

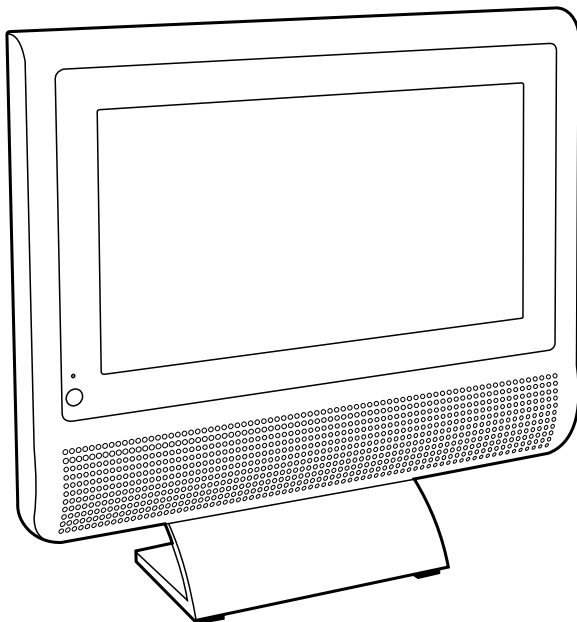

PLV16081

8" LCD Television



Instruction Manual

Need More Help?

DO NOT RETURN THIS PRODUCT TO THE STORE

Please visit online help at
<http://www.1800customersupport.com/audiovox>

SAFETY PRECAUTIONS



 The lightning flash with arrowhead symbol, within an equilateral triangle, is intended to alert the user to the presence of uninsulated "dangerous voltage" within the product's enclosure that may be of sufficient magnitude to constitute a risk of electric shock to persons.

 The exclamation point within an equilateral triangle is intended to alert the user to the presence of important operating and maintenance (servicing) instructions in the literature accompanying the appliance.

CAUTION

- DANGER OF EXPLOSION IF BATTERY IS INCORRECTLY REPLACED. REPLACE ONLY WITH THE SAME OR EQUIVALENT TYPE.
- TO PREVENT ELECTRIC SHOCK, MATCH WIDE BLADE OF PLUG TO WIDE SLOT OF WALL OUTLET, THEN FULLY INSERT.

WARNING :

- TO PREVENT FIRE OR SHOCK HAZARD, DO NOT EXPOSE THIS UNIT TO RAIN OR MOISTURE. DO NOT PLACE OBJECTS FILLED WITH LIQUIDS ON OR NEAR THIS UNIT.
- SHOULD ANY TROUBLE OCCUR, DISCONNECT THE AC POWER CORD AND REFER SERVICING TO A QUALIFIED TECHNICIAN.

 **WARNING:** Changes or modifications to this unit not expressly approved by party responsible for compliance could void the user authority to operate unit.

PLACEMENT INFORMATION

- Do not use this unit in places which are extremely hot, cold, dusty or humid.
- Do not restrict the air flow of this unit by placing it somewhere with poor air flow, by covering it with a cloth, by placing it on bedding or carpeting.

SAFETY INFORMATION

- When connecting or disconnecting the AC adapter, grip the plug and not the cord itself. Pulling the cord may damage it and create a hazard.
- When you are not going to use the unit for a long period of time, disconnect the AC adapter.

CONDENSATION INFORMATION

- When left in a heated room where it is warm and damp, water droplets or condensation may form inside the equipment. When there is condensation inside the unit, the unit may not function normally. Let the unit stand for 1-2 hours before turning the power on or gradually heat the room and let the unit dry before use.

RATING PLATE LOCATION

The rating plate is located on the rear of unit.

FCC STATEMENTS

NOTE: This unit has been tested and found to comply with the limits for a Class B digital device, pursuant to Part 15 of the FCC Rules. These limits are designed to provide reasonable protection against harmful interference in a residential installation. This unit generates, uses and can radiate radio frequency energy and, if not installed and used in accordance with the instructions, may cause harmful interference to radio communication. However, there is not guarantee that interference will not occur in a particular installation. If this unit does cause harmful interference to radio or television reception, which can be determined by turning the unit off and on, the user is encouraged to try to correct the interference by one or more of the following measures:

- Reorient or relocate the receiving antenna.
- Increase the separation between the unit and receiver.
- Connect the unit into an outlet on a circuit different from that to which the receiver is connected.
- Consult the dealer or an experienced radio/TV technician for help.

IMPORTANT SAFETY INSTRUCTIONS

- 1) Read these instructions.
- 2) Keep these instructions.
- 3) Heed all warnings.
- 4) Follow all instructions.
- 5) Do not use this apparatus near water.
- 6) Clean only with dry cloth.
- 7) Do not block any ventilation openings. Install in accordance with the manufacturer's instructions.
- 8) Do not install near any heat sources such as radiators, heat registers, stoves, or other apparatus (including amplifiers) that produce heat.
- 9) Do not defeat the safety purpose of the polarized or grounding-type plug. A polarized plug has two blades with one wider than the other. A grounding type plug has two blades and a third grounding prong. The wide blade or the third prong are provided for your safety. If the provided plug does not fit into your outlet, consult an electrician for replacement of the obsolete outlet.
- 10) Protect the power cord from being walked on or pinched particularly at plugs, convenience receptacles, and the point where they exit from the apparatus.
- 11) Only use detachments / accessories specified by the manufacturer.
- 12) Use only with the cart, stand, tripod, bracket, or table specified by the manufacturer, or sold with the apparatus. When a cart is used, use caution when moving the cart / apparatus combination to avoid injury from tip-over.
- 13) Unplug this apparatus during lightning storms or when unused for long periods of time.
- 14) Refer all servicing to qualified service personnel. Servicing is required when the apparatus has been damaged in any way, such as power-supply cord or plug is damaged, liquid has been spilled or objects have fallen into the apparatus, the apparatus has been exposed to rain or moisture, does not operate normally, or has been dropped.



CONTENTS

SAFETY PRECAUTIONS	1	SCREEN VIEWING ANGLE	
IMPORTANT SAFETY		ADJUSTMENT	9
INSTRUCTIONS	2	UNIT OPERATION	9
CONTENTS	3	USING THE TV	10
ACCESSORIES	4	Searching for TV Channels	
USING THE REMOTE CONTROL	4	Automatically	10
CONTROL REFERENCE GUIDE ..	5-6	Manual Searching for TV Channels	
CONNECTIONS	7-8	10
Connecting a TV Antenna	7	Watching Television	10
Connecting Equipment with Video		Resetting the TV Channels	10
Output (VCR, Camcorder, Video		TV SETUP	11-13
Game System, Cable, Satellite		Picture Setting	11
System, etc.)	7	Sound Setting	11
Connecting the AC adapter	8	Timer Setting	12
INSTALLATION	8-9	Misc Setting	12
Removing the Base Stand	8	TV Channel Setting	13
Mounting on the wall	8	TROUBLESHOOTING GUIDE	14
USING HEADPHONES	9		

ACCESSORIES

Please check and identify the supplied accessories.

- AC Adapter..... x 1
 Remote Control (with Battery)..... x 1

USING THE REMOTE CONTROL

USING THE REMOTE CONTROL

- This remote control is magnetic and can be attached to most refrigerators. Some refrigerator panels are not metallic. In this case, try attaching the magnetic remote control to the side of the refrigerator.
- Point the remote control at the remote sensor located on the unit.
- When there is a strong ambient light source, the performance of the infrared remote sensor may be degraded, causing unreliable operation.
- The recommended effective distance for remote operation is about 16 feet (5 meters).

TO INSTALL BATTERIES

1. Open the battery door.

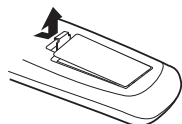

2. Insert 2 "AAA" batteries.

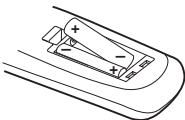

BATTERY REPLACEMENT

When the batteries become weak, the operating distance of the remote control is greatly reduced and you will need to replace the batteries.



CAUTION: Danger of explosion if battery is incorrectly replace. Replaced only with the same or equivalent type.

NOTES

- Do not place the remote control near magnetic devices.
- If the remote control is not going to be used for a long time, remove the batteries to avoid damage caused by battery leakage corrosion.
- Do not mix old and new batteries, Do not mix ALKALINE, standard (CARBON-ZINC) or rechargeable (NICKEL-CADMIUM) batteries.
- Always remove batteries as soon as they become weak.
- Weak batteries can leak and severely damage the remote control.
- **WARNING :** Do not dispose of batteries in a fire. Batteries may explode or leak.

CONTROL REFERENCE GUIDE

REMOTE CONTROL

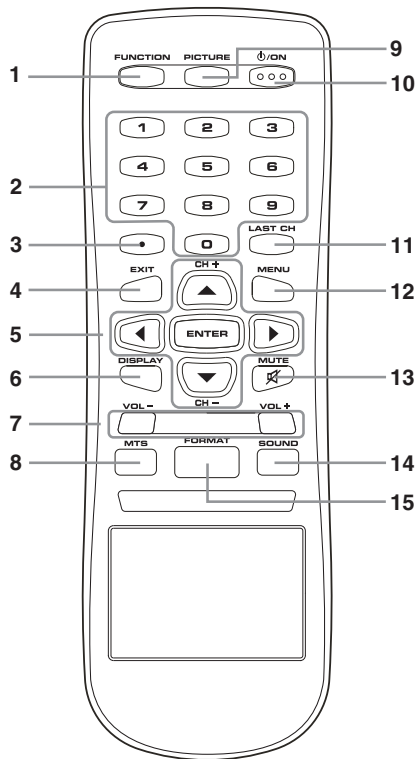

- FUNCTION Button**
Press to switch between TV / AV IN.
- Number (0 - 9) Buttons**
- [dot] Button**
Digital TV channels (i.e. 11.3 or 12.7)
- EXIT Button**
Press to exit the TV menu and return directly to normal viewing.
- CURSOR (▲, ▼, ◀, ▶) Buttons**
Use to highlight selections on a menu screen and adjust certain settings.
- ENTER Button**
Press to confirm selections on a menu screen.
- CH+ / CH- Buttons**
Press ▲ / ▼ to change the TV channels.
- DISPLAY Button**
Press to show which input you are watching.
- VOLUME (- / +) Buttons**
Press to adjust the volume level. Use to highlight selections on a menu screen and adjust certain settings.
- MTS Button**
Press to select MONO sound, STEREO sound and Secondary Audio Program (SAP).
- PICTURE Button**
Select from preset screen display settings to match the type of show you are watching.
- ON / OFF Button**
Press to turn ON the unit or put it in STANDBY (OFF) mode.
- LAST CH Button**
Press to switch repeatedly between the last two channels displayed.
- MENU Button**
Press to display the on-screen TV menu.
- MUTE  Button**
Press to turn off the sound.
- SOUND Button**
Press to select from preset sound settings to match the type of show you are watching.
- FORMAT Button**
Press to select the picture format.

CONTROL REFERENCE GUIDE

FRONT & BACK VIEWS

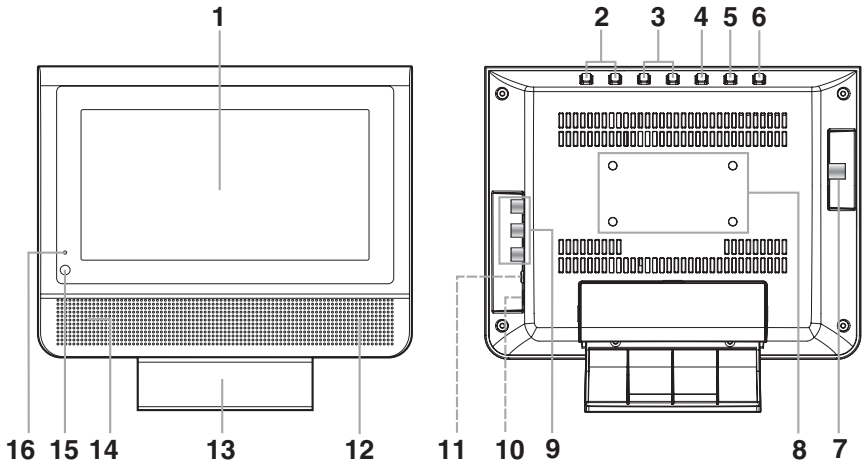

- 1. Color LCD Screen**
- 2. – VOL + Controls**
Adjusts the volume level and highlights selections (Left & Right) on the menu screen.
- 3. ▼ CHANNEL ▲ Buttons**
Press to confirm selections on the TV menu screen and ▲ / ▼ to move the TV channels.
- 4. FUNCTION Button**
Select TV / AV IN.
- 5. MENU Button**
Enters the on-screen TV menu.
- 6. ⏻ / ON Button**
Turns the unit on and off.
- 7. TV ANTENNA Terminal**
Connects a TV antenna or CATV cable
- 8. Wall Mounting Holes**
- 9. AUDIO IN (Left/Right)/ VIDEO IN Jacks**
- 10. DC IN 12V Jack**
- 11. Headphones Jack**
- 12. Right Speaker**
- 13. Removeable Stand**
- 14. Left Speaker**
- 15. Remote Sensor**
Point the remote control here.
- 16. STANDBY Indicator**
Indicates whether the unit is ON or in STANDBY (OFF) mode.
Light On: The unit is in STANDBY.
Light Off: The unit is turned ON.

CONNECTIONS

CONNECTING TV ANTENNA

To view television channels correctly, a signal must be received from one of the following sources:

- An indoor or outdoor aerial antenna
- A cable system
- A satellite system

To TV Antenna terminal

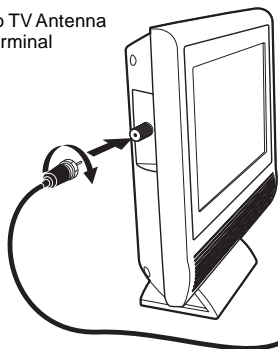

To Home Antenna terminal

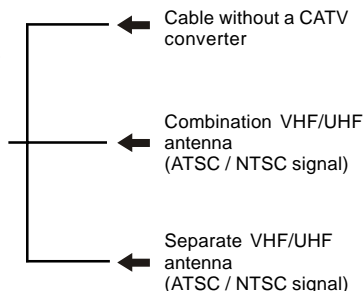

NOTE

For receiving over-the-air TV broadcasts, we recommend that you use an external fixed antenna. Should you require the use of a temporary antenna, please ensure that you purchase an antenna with sufficient ability to receive in weak signal areas. Only when you are in close proximity to a transmitter will a temporary antenna reproduce a signal as strongly as a fixed antenna.

CONNECTING EQUIPMENT WITH VIDEO OUTPUT

To connect to other equipment such as a VCR, camcorder, video game system, cable or satellite box.

Connecting to a VCR / Camcorder / Video Game System, Cable, Satellite System, etc)

Connect the AUDIO / VIDEO cable (not included) as shown:

Make sure you connect the cable from the other equipment (AUDIO/VIDEO OUT) to this unit (AUDIO/VIDEO IN).

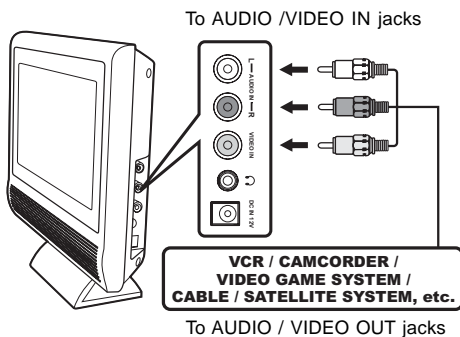

NOTE

Please refer to the user manual for the other equipment for more information.

CONNECTIONS

CONNECTING THE AC ADAPTER

This AC adapter operates on AC 100-240V.

1. Connect the AC adapter a wall outlet.
2. Press the **⏻/ON** button to turn on the unit.
3. Use the **◀** or **▶** button to select NO, then press **ENTER** button. (Only apply to the first time POWER ON.)
4. Press the **FUNCTION** button repeatedly to select TV / AV IN mode, then press **ENTER** button.

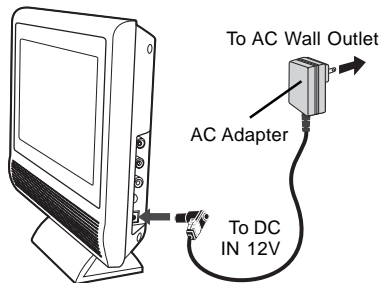

NOTES

- The included AC adapter is for use with this unit only. Do not use them with other equipment.
- When the AC adapter is plugged in, the unit is not completely disconnected from the main, even when the power is turned off.
- Be sure the AC adapter is disconnected and all functions are off before making connections.
- Make sure that all the components are connected correctly.
- When you are not going to use the unit for a long period of time, disconnect the AC adapter.

INSTALLATION

REMOVING THE BASE STAND

WARNING: The LCD display is very fragile, and must be protected at all times when removing the base stand. Be sure that no hard or sharp objects, or anything that could scratch or damage the LCD display, come in contact with it. Do NOT place pressure on the rear of the unit at anytime because the screen could crack.

1. Disconnect any cables or cords connected to the unit.
2. Remove the rear cover.
3. Lay the unit down on a flat surface, so the back side is facing up, making sure to place a soft cushioned material (such as a pillow or thick piece of foam) beneath the screen.
4. Remove the 4 screws and then remove the BASE STAND from the unit.

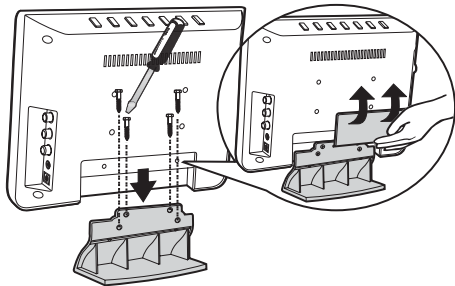

MOUNTING ON THE WALL

This unit is VESA-compliant, and is designed to be wall-mounted with a VESA-compliant 1.375" x 2.9375" (35mm x 75mm) mounting kit designed for flat-panel TVs (sold separately). Mount this unit according to the directions included with the mounting kit.

NOTE

Remove the base stand before mounting the unit on the wall.

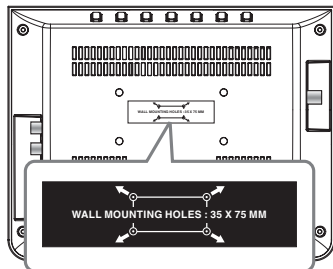

USING HEADPHONES (NOT INCLUDED)

- Turn down the volume before connecting headphones to the unit, then adjust the volume to your desired level.
- When headphones are connected, no sound will come from the front speakers.

Headphones
(1/8" [3.5mm]
diameter plug)

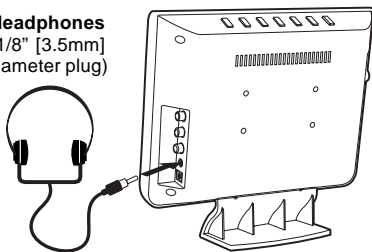

NOTE

Avoid listening to sound at high levels for prolonged periods of time. This may be harmful to you and may cause hearing loss.

SCREEN VIEWING ANGLE ADJUSTMENT

The unit is designed to allow users to have a comfortable viewing angle.

1. Hold the stand firmly.
2. Gently adjust the TV.

CAUTION

Do not force the LCD screen over the maximum viewing angle settings as stated above. Attempting this will result in damage to the unit.

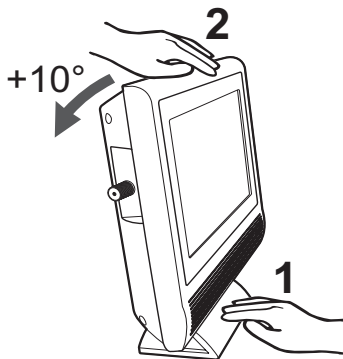

UNIT OPERATION

TURNING THE UNIT ON

When the AC adapter is connected, press the ϕ /ON button to turn it on. Press the **FUNCTION** button to select the desired mode (TV / AV IN).

NOTE

When the unit is not going to be used for a long time, disconnect the AC adapter cord from AC wall outlet.

USING THE TV

Connect an antenna or CATV cable or Satellite system to the TV antenna terminal before searching TV channels.

Searching for TV channels automatically

(Only appears to the first time Power ON)

When this unit is connected to an antenna, or a CATV cable or satellite system, it can automatically search for channels with adequate signal strength.

1. Connect the TV antenna.
2. Connect the AC adapter.
3. Press the **⏻ / ON** button to turn on the unit.
4. Press the **ENTER** button.
5. Press the **◀** or **▶** button to select "Air" or "CATV", then press the **ENTER** button to start auto scan.
6. The unit will immediately search all channels for those with adequate signal strength and store those channels with signals in memory. The unit will take a short minutes to finish auto scan and after this is completed, the unit will switch to the first channel found.

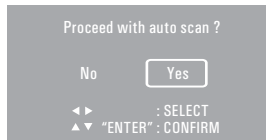

Manual searching for TV channels

1. Press the **MENU** button, then press the **◀** button to TV CHANNEL SETTING.
2. Press the **▼** button to select ANTENNA. Use the **◀** or **▶** button to select AIR or CATV.
3. Use the **▼** button to select Auto Scan.
4. Press the **ENTER** button to enter sub menu of Auto Scan.
5. Use the **▼** button to select "Start to Scan" in the sub menu.
6. Press the **ENTER** button to start the search for TV channels.
7. The screen will show the first received channel when auto search is completed.



Watching television

Viewing a television station after the auto/manual search for channels.

1. Press the **FUNCTION** button to TV mode.
2. Press the **▲ CH+** or **▼ CH-** button to select a channel, or press the number button on the remote to select the channel you want to watch.
 - For channels 1 to 9, enter one-digit channel number.
 - For channels 10 to 99, enter two-digit channel number.
 - For channels 100 or over, enter three-digit channel number.

NOTE

- When a channel is selected, the channel number is displayed on the top right corner of the screen. This number will disappear after a few seconds.

ATSC TV mode:

Press the **DISPLAY** button, the upper window will pop up, then press the **DISPLAY** button again, the lower window will pop up. Press the **DISPLAY** button once to exit.

NTSC TV mode:

Press the **DISPLAY** button, the upper window will pop up, then press the **DISPLAY** button once to exit.

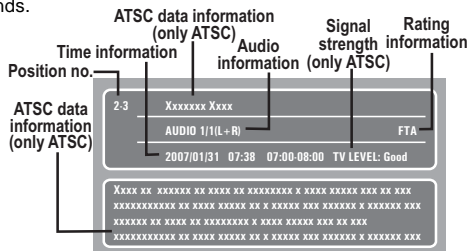

TV SETUP

PICTURE SETTING

1. Press the **MENU** button.
2. Use the **▲** or **▼** button to select the options (**Picture Mode / Contrast / Brightness / Sharpness / Tint / Color**).
3. Use **◀** or **▶** button to make adjustment. The screen will change to your selected mode immediately. Press the **MENU** button to return to the previous menu.
4. Repeat steps 2 and 3 to adjust other options.
5. To exit the TV SETUP MENU and return to the normal screen, press the **EXIT** button on the remote control.

NOTE

You can also access these setting by pressing the **PICTURE** button.

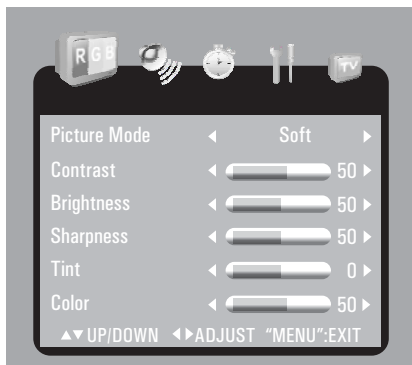

Picture Mode: Select from preset screen display settings to match the type of show you are watching (Standard, Dynamic, Soft & Personal).

Contrast: Adjust to sharpen the picture quality. The black portions of the picture become richer in darkness and the white become brighter.

Brightness: Adjust to brighten or darken the whole picture.

Sharpness: Adjust the sharpness level to improve detail in the picture.

Tint: Adjust natural skin tones in the picture quality.

Color: Adjust the color of the picture.

SOUND SETTING

1. Press the **MENU** button.
2. Use the **◀** or **▶** button to select **SOUND SETTING**.
3. Use the **▲** or **▼** button to select the options (**Sound Mode / Bass / Treble / Balance**).
4. Use the **◀** or **▶** button to make adjustment. Press the **MENU** button to return to the previous menu.
5. Repeat steps 2 to 4 to adjust other options.
6. To exit the TV SETUP MENU and return to the normal screen, press the **EXIT** button on the remote control.

NOTE

You can also access these setting by pressing the **SOUND** button.

Sound Mode: Select from preset sound settings (Standard, Music, Movie, Personal) to match the type of show you are watching.

Bass: Adjust the bass range.

Treble: Adjust the treble range.

Balance: Adjust the balance level toward the left or right speakers.

Audio Language: Use the **◀** or **▶** button to select English, French or Spanish (**Available for Digital TV system only**).

NOTE

Only for DTV/ATSC input source mode, thus it is not available in other input source mode.

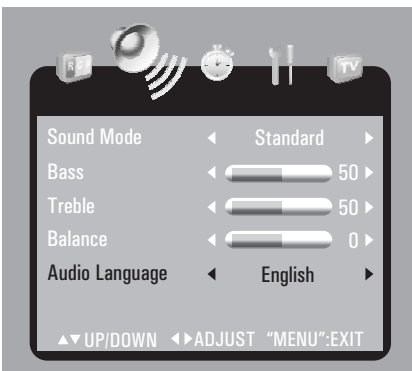

TV SETUP

TIMER SETTING

1. Press the **MENU** button.
2. Use the ◀ or ▶ button to select **TIMER SETTING**.
3. Use the ▲ or ▼ button to select the options (**OSD Duration / Sleep Timer / Time Zone / Day Saving Time**).
4. Use the ◀ or ▶ button to make adjustment. Press the **MENU** button to return to the previous menu.
5. Repeat steps 2 to 4 to adjust other options.
6. To exit the TV SETUP MENU and return to the normal screen, press the **EXIT** button on the remote control.

OSD Duration: Select amount the time of TV menu showing on screen.

Sleep Timer: Set the LCD TV to turn itself off within a certain time.

Time Zone / Day Saving Time / Clock

1. Set the local Time Zone, eg. Pacific.
2. After selecting the time zone, the Day Saving Time must be activated for those areas observing such change.
3. The clock will be recoded automatically (for ATSC only).

MISC SETTING

1. Press the **MENU** button.
2. Use the ◀ or ▶ button to select **MISC SETTING**.
3. Use the ▲ or ▼ button to select the options (**Language / Color Mode / Restore Setting**).
4. Use the ◀ or ▶ button to make adjustment. The screen will change to your selected mode immediately. Press the **MENU** button to return to the previous menu.
5. Repeat steps 2 to 4 to adjust other options.
6. To exit the TV SETUP MENU and return to the normal screen, press the **EXIT** button on the remote control.

Language : Select from English / Français / Español.

Color Mode : Adjust the three color temperature of the picture. Select Normal (balanced) / Warm (red white) / Cool (blue white) mode.

Restore Setting : If you reset the TV to the factory settings, all your present settings on picture & sound will be erased and replaced by the factory's default settings.

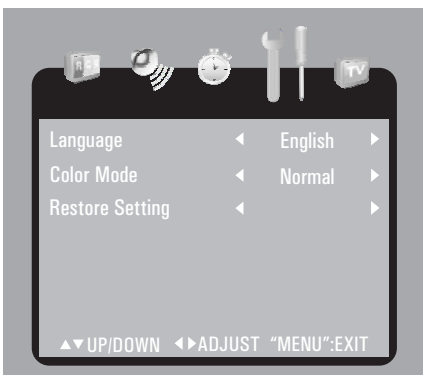
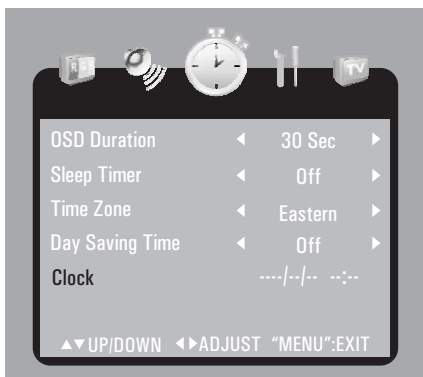

TV SETUP

TV CHANNEL SETTING

1. Press the **MENU** button.
2. Use the ◀ or ▶ button to select TV CHANNEL SETTING.
3. Use the ▲ or ▼ button to select the options (**Antenna / Auto Scan / Auto Scan Add CH / Channel Skip / Channel No. / Channel Label**).
4. Use the ◀ or ▶ button to make adjustment. The screen will change to your selected mode immediately. Press the **MENU** button to return to the previous menu.
5. Repeat steps 2 to 4 to adjust other options.
6. To exit the TV SETUP MENU and return to the normal screen, press the **EXIT** button on the remote control.

NOTE

Channel No. : 2-69 Channel for Air, 1-135 Channel for CATV.

Antenna : Select "CATV" to receive cable signal. Select "AIR" to receive air signal.

Auto Scan : Automatically search all channels for those with adequate signal strength.

Auto Scan Add CH : The stored channels can not be cleared and the Auto Scan Channels will be added.

If you have selected CATV in TV CHANNEL SETTING, then you can select Cable System (AUTO/STD/HRC/IRC) in the sub menu as the picture shown.

Channel Skip: You may switch ON/OFF the skip function of each stored channel by selecting the channel with ▲ / ▼ button (and using ◀ / ▶ button to select page if the amount of stored channels in more than 1 page), and followed with pressing the **ENTER** button.

Channel Label: You may edit one label for each channel.

1. Select the Channel Label item and press the ◀ or ▶ button to go into the channel label edit screen.
2. Use the ▲ or ▼ button to enter the number or letter.
3. Use the ◀ or ▶ button to move and edit for the next character.
4. After editing, press the **DISPLAY** button and the Channel & Channel Label will be shown on the screen.

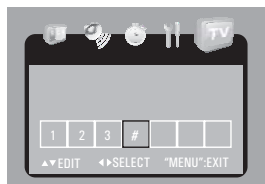
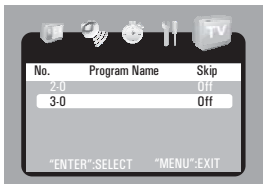
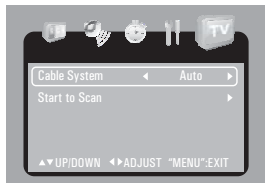
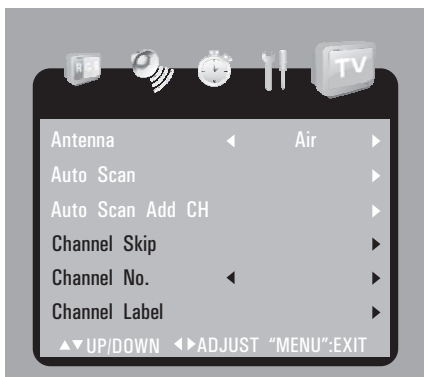

TROUBLESHOOTING GUIDE

SYMPTOM

CAUSE (AND REMEDY)

No power.

- Check that the AC power adapter is connected.
- The unit is not turned on.

The remote does not function.

- Remove any obstacles between the remote and the unit.
- Use the remote near the unit.
- Point the remote at the remote sensor on the unit.
- Replace the batteries in the remote with new ones.

Bad Picture (snow, multiple images, distortion, blurry)

- Check the location of the antenna and adjust it if necessary.
- Make sure the antenna cable is firmly connected.
- Make sure all input cables are firmly connected.

Black and white picture.

- Check the Picturing setting within the TV SETUP MENU.
- Check to make sure the program you are watching is broadcast in Color and not Black & White.

No picture or sound.

- Make sure the unit is plugged in and turned on.
- Make sure that TV mode is selected.
- Try a new channel to check for possible station trouble.
- Make sure the antenna is connected properly.
- Increase the volume.
- Make sure the antenna or audio video source device is working properly.
- Make sure all cables are firmly connected.
- Check for local interference.

Colored patches of picture.

- Make sure there are no unshielded electrical devices nearby that are causing interference.
- Turn the unit off for 30 minutes, then try it again.

Unit : INCH

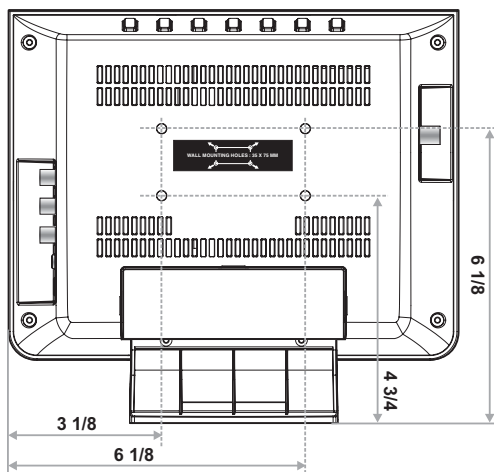
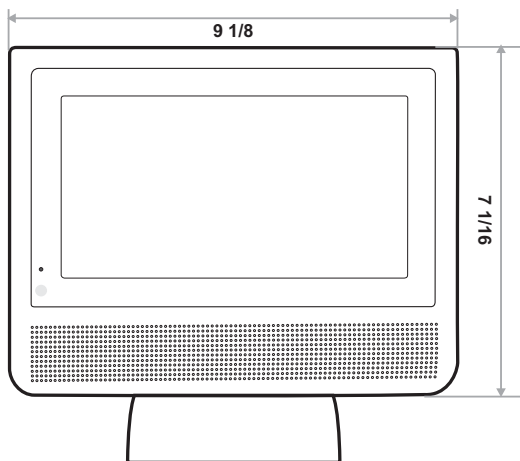
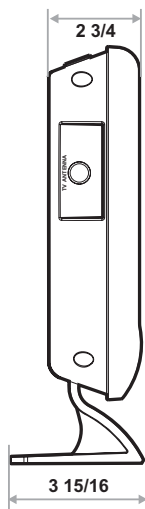

Free Manuals Download Website

<http://myh66.com>

<http://usermanuals.us>

<http://www.somanuals.com>

<http://www.4manuals.cc>

<http://www.manual-lib.com>

<http://www.404manual.com>

<http://www.luxmanual.com>

<http://aubethermostatmanual.com>

Golf course search by state

<http://golfingnear.com>

Email search by domain

<http://emailbydomain.com>

Auto manuals search

<http://auto.somanuals.com>

TV manuals search

<http://tv.somanuals.com>