

# VSI-PRO MAX



## POS / CASH REGISTER INTERFACE

Operation Manual

September 2008



# VSI-Pro Max



**CAUTION!**  
**RISK OF ELECTRICAL SHOCK!**  
**DO NOT OPEN!**



**TO PREVENT ELECTRIC SHOCK, DO NOT REMOVE THE COVER. DO NOT EXPOSE THE EQUIPMENT TO RAIN OR MOISTURE. NO USER SERVICEABLE PARTS ARE INSIDE. REFER SERVICING TO QUALIFIED PERSONNEL.**

## **WARNING!**

**THIS EQUIPMENT GENERATES, USES, AND CAN RADIATE RADIO FREQUENCY ENERGY AND IF NOT INSTALLED AND USED IN ACCORDANCE WITH THE INSTRUCTION MANUAL MAY CAUSE INTERFERENCE TO RADIO COMMUNICATIONS. IT HAS BEEN TESTED AND FOUND TO COMPLY WITH THE LIMITS FOR A CLASS A COMPUTING DEVICE PURSUANT TO SUBPART J OF PART 15 OF FCC RULES, WHICH ARE DESIGNED TO PROVIDE REASONABLE PROTECTION AGAINST SUCH INTERFERENCE WHEN OPERATED IN A COMMERCIAL ENVIRONMENT. OPERATION OF THIS EQUIPMENT IN A RESIDENTIAL AREA IS LIKELY TO CAUSE INTERFERENCE IN WHICH CASE THE USER AT HIS/HER OWN EXPENSE WILL BE REQUIRED TO TAKE WHATEVER MEASURES MAY BE REQUIRED TO CORRECT THE INTERFERENCE.**

### **AVE Multiview UK**

**Unit 1C, The Potteries,  
Woodgreen Road, Waltham  
Abbey Essex, EN9 3SA, UK  
Tel: 440-870-770-9323  
Fax: 440-870-770-9363  
Email: [ave-uk@multiview.net](mailto:ave-uk@multiview.net)  
[www.multiview.net](http://www.multiview.net)**

### **AVE Multiview USA**

**2000 West Governors Circle  
Suite E, Houston, Texas 77092  
Tel: 1-281-443-2300  
Fax: 1-281-443-8915  
Email: [sales@aveusa.com](mailto:sales@aveusa.com)  
<http://www.americanvideoequipment.com>**

### **AVE Thailand Co., Ltd.**

**147 Soi On-Nut 44  
Sukhumvit 77 Rd., Suan Luang  
Bangkok 10250, Thailand  
Tel: 662-331-9364, 331-9285  
Fax: 662-331-9365  
Email: [ave@avethailand.com](mailto:ave@avethailand.com)  
<http://www.ave.co.th> (Thai)  
<http://www.avethailand.com> (English)**

**Copyright © AVE Thailand Co., Ltd. 2000-2008**

1. Introduction.....	7
1.1 VSI / VSI+ / VSI-Pro / VSI-Pro Max Backward Compatibility .....	7
2. Features & Specifications.....	8
2.1 Features.....	8
2.2 Specifications.....	9
3. Connections.....	10
3.1 LED Indicators.....	10
3.2 RS-232 Serial Input.....	11
4. User Front Panel Controls.....	14
4.1 Front Panel Controls.....	14
5. Programming.....	16
5.1 Getting Started.....	16
5.2 Main- Menu Programming.....	16
5.3 Register Select.....	16
TCPIP.....	16
Generic .....	16
Addressable VSI (VSI-ADD) .....	16
ANSI Commands .....	16
Registers A - Z .....	16 - 24
5.4 Screen Setup.....	25
Text Grayscale.....	25
Background Gayscale.....	25
Character Positioning .....	25
Clock.....	25
On-Screen Titler.....	26
Language Settings .....	27
5.5 Text Display.....	28
Screen Blank.....	28
Display Lines.....	28
Characters per Line .....	28
Display Format.....	29
Space Compress .....	29
Left Justified.....	29
Scroll Delay.....	29
Display.....	29
5.6 Communication.....	30
Register Settings .....	30
Interface Type.....	30
RX Baudrate.....	30
TX Baudrate.....	31
TX Protocol.....	31
Parity.....	31
Data Bits.....	31
Hardware Handshaking.....	31
Software Handshaking .....	32
Auto Linefeed.....	32
Network Settings .....	32
Type.....	32
Address .....	32
Protocol .....	32
Baud Rate .....	32
5.7 Exception Report.....	33
Overview.....	33
Exception History.....	35
DVR Selection.....	36
Time Search.....	36
Output Exceptions .....	37
Set Exceptions.....	37
Exception String.....	36
Range.....	36
Operator.....	36
Time Stamping.....	42
Duplicate Line .....	42
Scroll Matching.....	42
5.8 Alarm Output.....	43
Alarm No.....	44
Alarm Trigger.....	44
Normal State.....	44

# CONTENTS

Alarm Duration.....	45
Flag Type.....	45
Flag Duration.....	45
Triggered Text.....	45
RTS Triggered Text Delay .....	45
Set Triggered Text.....	46
Video Loss .....	46
5.9 Test / Demo Mode.....	42
Port 1 Test.....	43
Data Capture.....	45
Register Demo.....	46
Version ID.....	46
5.10 Download/Upload Setup.....	46
Download/Upload Setup Using VSI-Pro Max to VSI-Pro Max.....	47
Download/Upload Setup Using a PC.....	49
PC Programming Software.....	53
Update Firmware.....	56
Firmware Update Utility .....	56
5.11 Help.....	59

## APPENDICES

Appendix A : Problem Solving Guide.....	59
Appendix B : Hard Alarm Output.....	62
Appendix C : DVR Text Input Connections.....	63
Appendix D : UTP Connections.....	64
Appendix E : P2RS Parallel to Serial Converter.....	65
Appendix F : USB to RS-232 Converter.....	66
Appendix G : VSIB Installation.....	67
Appendix H : ECR Interface Cards.....	68
Appendix I : ANSI Driver Commnads.....	68
Appendix J : RS-232 to RS-485 Converter.....	69
Appendix K : TCIP232 Adapter.....	70
Appendix L : VSI-Pro Max Networking .....	71
Appendix M : Network Communication and Configuration .....	72
Hydra / Regcom .....	74
Master Protocol (VSI-ADD) .....	75
Vnetworker Connections .....	76
Vnetworker PC Application .....	78
Appendix N : AL-16 Alarm Relay Expanison Device.....	80
Appendix O : POS / CCTV Applications.....	81
Appendix P : Warranty.....	82
Appendix Q : Master Reset to Factory Defaults.....	83

## TABLES

Table 1 : Pin-Out of the DB-9 Female Connector on the VSI-Pro MaxRS-232.....	11
Table 2 : RS-232 DB-9 Pin-Out vs VSI-Pro Max DB-9 Pin-Out.....	11
Table 3 : Pin-Out of the DB-9 Female Connector on the VSI-Pro Max RS-422 / RS-485.....	12
Table 4 : ANSI Driver Commands.....	68
Table 5 : VSI-Pro Max Master DB-9 Pin-Out.....	73
Table 6 : Hydra DB-9 Pin-Out.....	73
Table 7 : RJ-45 Pin-Out.....	73
Table 8 : RS-485 Network Data Cable Wiring.....	74
Table 9 : Hydra RS-232 Parameters .....	74
Table 10 : Network Parameters .....	74
Table 11: Hydra / Regcom Dipswitch Settings .....	74

## FIGURES

Figure 1 : Front of VSI-Pro Max .....	10
Figure 2 : VSI-Pro Max Network Connector .....	10
Figure 3 : VSI-Pro Max Rear Connections.....	10
Figure 4 : VSI-Pro Max Connections.....	12
Figure 5 : VSI-Pro Max Earth Grounding Connection.....	13
Figure 6 : Four Front Panel Push Button of VSI-Pro Max .....	14
Figure 7 : Four Front Panel Push Button of VSI-Pro Max (Down) .....	14
Figure 8 : Four Front Panel Push Button of VSI-Pro Max (Up) .....	15
Figure 9 : Four Front Panel Push Button of VSI-Pro Max (Set) .....	15
Figure 10 : VSI-Pro Max Main-Menu.....	16

Figure 11 : Register Select Sub-Menu.....	17
figure 12 : TCPIP Sub Menu.....	17
Figure 13 : Addressable VSI Sub-Menu (VSI-ADD) .....	18
Figure 14 : ADS Sub-Menu.....	18
Figure 15 : Beetle / 50 Printers Sub-Menu.....	18
Figure 16 : Casio TK-T 500 Sub-Menu.....	18
Figure 17 : Casio TE-2200 Sub-Menu.....	18
Figure 18 : Clarity Epos Sub-Menu.....	18
Figure 19 : Delta Sono 3.1 Sub-Menu.....	19
Figure 20 : Dresser Wayne Sub-Menu.....	19
Figure 21 : POS / CDU Sub-Menu.....	19
Figure 22 : Nucleus Sub-Menu.....	19
Figure 23 : Edacom Sub-Menu.....	19
Figure 24 : Model E90 Sub-Menu.....	19
Figure 25 : Epson Generic Sub-Menu.....	19
Figure 26 : Fujitsu 9920 Sub-Menu.....	19
Figure 27 : Gasboy Sub-Menu.....	20
Figure 28 : Gilbarco Sub-Menu.....	20
Figure 29 : IBM 3151 Terminal Sub-Menu.....	20
Figure 30 : IBM RDS Sub-Menu.....	20
Figure 31 : Mirelec Sub-Menu.....	20
Figure 32 : Mirelec MS Series Sub-Menu.....	20
Figure 33 : Mirelec 9500 Sub-Menu.....	20
Figure 34 : Micros Sub-Menu.....	21
Figure 35 : Micros IDN Networker.....	21
Figure 36 : Micros ISN Networker.....	21
Figure 37 : NCR Sub-Menu.....	21
Figure 38 : Nixdorf Beetle Sub-Menu.....	21
Figure 39 : Norand 1200 Sub-Menu.....	22
Figure 40 : Nucleus Printer Sub-Menu.....	22
Figure 41 : Omega 2000 Sub-Menu.....	22
Figure 42 : Panasonic Sub-Menu.....	22
Figure 43 : Schlumberger Sub-Menu.....	22
Figure 44 : Sharp Sub-Menu.....	23
Figure 45 : Sharp 750 ER-01PUSub-Menu.....	23
Figure 46 : Sharp ER-A410/420Sub-Menu.....	23
Figure 47 : Sharp UP600/700 Sub-Menu.....	23
Figure 48 : Sicom Sub-Menu.....	23
Figure 49 : Spedit CCTV Sub-Menu.....	23
Figure 50 : Suntronic Sub-Menu.....	23
Figure 51 : TCI Sub-Menu.....	23
Figure 52 : TEC Slip Printer Sub-Menu.....	23
Figure 53 : TKMAX Sub-Menu.....	24
Figure 54 : Uniwell UN 4025 Sub-Menu.....	24
Figure 55 : UP3000/3300 Sub-Menu.....	24
Figure 56 : Verifone Sub-Menu.....	24
Figure 56A : Weigh Scale Sub-Menu.....	24
Figure 57 : VSI-Pro Max On-Screen Setup Menu.....	25
Figure 58 : Clock Display Sub-Menu.....	26
Figure 59 : On-Screen Titler Sub-Menu.....	27
Figure 60 : Language Sub-Menu.....	27
Figure 61 : Text Display Sub-Menu.....	28
Figure 62 : Communication Sub-Menu.....	30
Figure 63 : Register Settings Sub-Menu.....	30
Figure 64 : Network Settings Sub-Menu.....	32
Figure 65 : Exception Report Sub-Menu.....	35
Figure 66 : Exception History Sub-Menu.....	35
Figure 67 : Display of View Exception.....	35
Figure 68 : DVR Selection Sub-Menu.....	36
Figure 69 : DVR-3011,3021,MVDR3000, MVDR5000 Sub-Menu.....	36
Figure 70 : Display of Time Search.....	36
Figure 71 : VSI-Pro Max with DVR Control Connections.....	37
Figure 72 : Set Exception Sub-Menu.....	38
Figure 72A : Scroll Matching Sub Menu.....	43
Figure 73 : Alarm Output Sub-Menu.....	43
Figure 74 : Triggered Text Sub-Menu.....	45
Figure 75 : Set Triggered Text Sub-Menu.....	46
Figure 76 : Test / Demo Mode Sub-Menu.....	47
Figure 77 : Port 1 Sub-Menu.....	47

# CONTENTS

Figure 78 : Recerve [ RX ] Test Sub-Menu.....	47
Figure 79 : Transmit [ RX ] Test Sub-Menu.....	48
Figure 80 : RX / TX Test Sub-Menu.....	48
Figure 81 : Baudrate Scan Sub-Menu.....	48
Figure 82 : Data Capture Sub-Menu.....	49
Figure 83 : Capture to Port 1 Sub-Menu.....	49
Figure 84 : Capture to Memory.....	49
Figure 85 : Register Demo Sub-Menu.....	50
Figure 86 : Download/Upload Data Cable.....	50
Figure 87 : Download/Upload Setup Using VSI-Pro Max to VSI-Pro Max.....	51
Figure 88 : Download/Upload Sub-Menu.....	52
Figure 89 : Download Setup Sub-Menu & Display.....	52
Figure 90 : Upload Setup Sub-Menu & Display.....	52
Figure 91 : Program Download Menu.....	53
Figure 92 : Remote Menu.....	54
Figure 93 : File Menu.....	55
Figure 94 : About Menu.....	55
Figure 95 : PC Programming Cable Pin Out.....	55
Figure 96 : Firmware Update Sub Menu.....	56
Figure 97 : Hyper Terminal Main Menu.....	56
Figure 98 : Connect To Menu.....	57
Figure 99 : Port Settings Menu.....	57
Figure 100 : In-System Programming Display.....	58
Figure 101 : Help Sub-Menu.....	59
Figure 102 : Hard Alarm Output.....	62
Figure 103 : VSI-Pro Max with DVR Text Input Connections .....	63
Figure 104 : VSI-Pro Max and DVR RS-485 Pin Outs.....	63
Figure 105 : VSI-Pro Max UTP Connections.....	64
Figure 106 : VSI-Pro Max RJ45 Pin Outs.....	64
Figure 107 : RJ45 Connector Configuration .....	64
Figure 108 : VSI-Pro Max and CAT5 Breakout .....	64
Figure 109 : P2RS Parallel to Serial Converter Front Panel.....	65
Figure 110 : P2RS Parallel to Serial Converter Rear Panel .....	65
Figure 111 : P2RS Parallel Connection Cables.....	65
Figure 112 : DB-25 Cable.....	65
Figure 113 : Centronics Cable.....	65
Figure 114 : Pin-Out for P2RS to VSI-Pro Max .....	65
Figure 115 : USB to RS-232 Converter PCB .....	66
Figure 116 : USB232 Adapter .....	66
Figure 117 : VSI-Pro Front Panel.....	67
Figure 118 : VSIB Front Panel.....	67
Figure 119 : VSIB Rear Panel.....	67
Figure 120 : VSIB Connection Cable.....	67
Figure 121 : Cable Connection to the VSIB.....	67
Figure 122 : Pin-Out for VSIB to VSI-Pro.....	67
Figure 123 : TK 6000/7000 PCB and Cable.....	68
Figure 124 : TK 2300 and Adapter.....	68
Figure 125 : TE-2200 Thermal Printer Adapter .....	68
Figure 126 : RS-232 to RS-485/422 Converter PCB .....	69
Figure 127 : RS-422/RS-485 Connections.....	69
Figure 128 : RS-232 Connections .....	69
Figure 129 : Front of TCPIP232 Adapter.....	70
Figure 130 : Rear of TCPIP 232 Adapter.....	70
Figure 131 : VSI-Pro Connections with TCPIP 232 Adapter.....	70
Figure 132 : Pin-Out for TCPIP 232 Adapter to VSI-Pro Max .....	70
Figure 133 : RJ45 Connector Configuration .....	72
Figure 134 : DS-20-OF VSI-Pro Max PCB Rack.....	72
Figure 135 : VSI-Pro Max Networking Connection Diagram.....	73
Figure 136 : VSI-Pro Max Front Panel.....	74
Figure 137 : Hydra / Regcom Front Panel.....	74
Figure 138 : Hydra /Regcom Rear Panel.....	74
Figure 139 : VSI-Pro Max Connection Diagram for RS-485 Network.....	76
Figure 140 : Hydra Connection Diagram for RS-485 Network.....	76
Figure 141 : Laptop Connection Diagram for RS-485 Network.....	77
Figure 142 : Vnetworker Software Main Menu.....	77
Figure 143 : Status Display .....	78
Figure 144 : Window Tile Options .....	78
Figure 145 : Remote Keyboard Window .....	79
Figure 146 : Time / Date Set Up Window .....	80

The VSI-Pro Max is the latest in the evolution of the popular VSI line of POS / Cash Register Interfaces from AVE. The VSI-Pro Max, now with larger memory space can hold ALL the AVE Interfaces in one unit with full remote PC or DVR programming for selection and setups and onsite firmware updating. New video processing circuitry allows use with new WDR cameras and low video of commonly used UTP adapters. Built in RS-232, RS-485, Passive and the new Opto-Isolated selection, gives complete isolation from the POS/Cash Register from the video system. Internal 40 Mhz operation allows for combining the Networking functions of the Hydra, Regcom, Networker or Vnetworker within one convenient unit with looping RJ45s for a seem-less solution for multiple till configurations.

The VSI-Pro Max allows characters to be inserted into any video source via an RS-232 / RS-422 / RS-485 link. This allows cash registers, computers, scales, pole displays, printers or any RS-232 / RS-485 / RS-422 communicating device to display alpha- numerics in the video picture of any CCTV system. Simple front panel push-buttons allow the user to simply program all functions and features of the VSI-Pro Max. This includes characters position, gray scale and a wide variety text processing function including exceptions and alarming features.

Whether used with a cash register providing real time data on an RS-232 port or tapping off a serial printer or pole display, the VSI-Pro Max is a valuable tool in loss prevention. When used in conjunction with AVE's extensive line of adapters this device can connect to any POS (Point of Sale) / ECR (Electronic Cash Register) or peripheral on the market today. Now available the TCP/IP232 Adapter for interfacing to Ethernet LAN networks to capture common printer data or monitor any single register transactions.

The VSI-Pro Max can be used to trigger switchers, time lapse VCRs, DVRs, remote transmission devices or other alarming devices via the 2 hardwired open collector alarm outputs.

The VSI-Pro Max also has an additional RS-232/RS-485 output that can send the formatted ASCII text to a DVR which can store the data as an electronic file in addition to inserted in the actual video image. This additional RS-485 port supports full networking of up to 16 VSI-Pro Max without any external devices.

The Exception Processor of the VSI-Pro Max provides the intelligence to bring questionable or exceptional transactions to view for the user. This allows the user to quickly and easily review employee transactions to identify fraud and theft transactions at the cash register. When used with a compatible DVR, the VSI-Pro Max can command or be commanded by the DVR to automatically search to the transaction in question for instant review of the recorded video.

With the new "Scroll Matching" feature, users can easily set and erase scrolling advertising messages from the customer display but always record the valid transactions.

The VSI-Pro Max is fully networkable with our "Networker", "Vnetworker", "Hydra" and "Regcom" line of products. These device connect to the VSI-Pro or ECR Interfaces or Adapters directly and communicate back via an RS-485 network to the central location. PC Windows-based software can also be used as the controller of this network and store transaction files for up to 16 cash registers for remote viewing or downloading to produce reports for management.

The VSI-Pro Max is fully remotely downloadable, uploadable or programmable by our PC VSI Programmable software. This utilizes a direct connection via RS-232 from a laptop to the VSI-Pro. Complete VSI-Pro Max settings can be saved on the laptop and uploaded to the VSI-Pro Max at will. This is mainly used for dealer maintenance or for single station user programming or when cameras or monitors are not easily available.

Firmware is also downloadable in the field with our Firmware Utility so new updates and features can be easily passed to customers without changing EPROMs or opening the unit.

## 1.1 VSI / VSI+ / VSI-Pro / VSI-Pro Max Backward Compatibility

Since 1990 various versions of the VSI have been on the market solving cash register retail problems. Several special version are available to interface to other RS-232 devices like scales, coin counters, PLCC, gambling machines and ATMs along with countless other generic RS-232 devices. The first VSI, Version 9 had no exception processing until the release of Version 10. However these versions had the ability to output the data so are compatible with the Regcom line of networking adapters. As features increased we moved to the VSI+ Version 11, which had the first powerful set of exception processing and printing functions. This version also had hardware handshaking capability which allows it to be fully operational with the Networker and Regcom line. The introduction of the VSI-Pro Version 12 added on-screen selection of various model registers for ease of installation and supported many characters sizes for multiple units to display data on one camera view. This version also supports the Networker and Regcom products. The VSI-Pro Version 13.XX has improved features and additional registers and the Version 13.00 supports North America cash registers and Version 13.24 supports UK and European models. All Version 13.XX VSI-Pro support the Networker and Regcom products. All Version 13.XX can be upgraded to the latest Ver. 13 release. This release adds PC Programming capability, Firmware update externally and Vnetworker support along with Networker and Regcom compatibility. The VSI-Pro Max is the latest in the development line and includes all register of Ver. 13.XX in one convenient unit along with built in Hydra, Regcom, Networker and Vnetworker hardware and software.

Contact the AVE factory for additional details on upgrading and networking with any DVR or learn about the advanced features when integrated with the AVE line of text insertion and search DVRs locally or remotely.



## 2. FEATURES & SPECIFICATIONS

---

### 2.1 FEATURES

- .....80 Register Selections Selectable via OSD
- .....User Selectable Full Duplex Bi-Directional POS / Cash Register Communications
  
- RS-232C
- RS-232C Optically Isolated
- RS-485 Full Duplex, RS-422 Half Duplex
- Passive Tap (Hi-Z)
  
- .....RS-232C or RS-485 Output of all data or exceptions to printers, computers, modems and DVRs
- .....Dual RJ45 Connectors for easy Networking with Standard CAT5 Cabling
- .....Built In Hydra, Regcom, Networker and Vnetworker Hardware and Protocol
- .....Diagnostic LEDs for Power, POS Communication & Network Communication
- .....Video Input AGC and Video Output can Drive two 75 ohm loads at 1VP-P
- .....Video and Power Input Surge and Lightning Suppression with External Grounding Lug
- .....Video Low and Lost LED indication and alarming function
- .....40 Mhz Processing with 128K Program and 128K SRAM Memory for High Performance Processing
- .....Programmable Time-Stamp and Trigger Text On-Screen and Exception Output
- .....Time/Date Searching with Compatible DVR
- .....Universal Time/Date Format , Automatic Daylight Savings Adjustment and Register T/D Locking
- .....800 Lines of Exception History Buffer
- .....16 Triggered Text associated with 16 virtual alarms
- .....2 Built-in Programmable Hard Alarm Outputs
- .....Alarm Input for drawer open, safe open, etc. with programmable time delay
- .....Large Data Buffers for input/output to accommodate newer and faster registers
- .....Powerful Data Filtering Algorithms like Truncating, Scroll Matching, Space Filtering, Duplicate Line Filtering
- .....Easy On-Screen Menu-Driven Setup and Programming
- .....Auto Baud Rate Detection
- .....24 Field Programmable Exceptions with Numeric Range
- .....On-screen Flagging of Exceptions with Asterisk or Reverse Text
- .....Programmable Delayed Screen Blanking
- .....Scroll Delay for non real time recording
- .....Choice of 1 to 11 lines Displayed On-Screen up to 40 Characters per Line
- .....On-screen Titler up to 40 characters
- .....Gray scale and Border Selection from Front Panel
- .....Built-in Test and Diagnostic Modes
- .....Built-in Cash Register Demo
- .....Upload/Download and Programming to a PC or another VSI-Pro Max
- .....Data Captured either to the Memory or to the Serial Port
- .....Local Firmware Downloadable
- .....Local / Remote Programming via PC Software or Compatible DVR
- .....Compatible with AVE AL-16 External Relay Interface adapter





**2.2 SPECIFICATIONS**

Video In (BNC)	.5VP-P to 2VP-P AGC Term. 75 ohms, 90V Gas Discharge Suppression
Video Out (BNC)	1V P-P Terminated or unterminated can drive two 75 ohm loads
Video S / N	better than 50dB
Video B / W	better than 7MHz
Power (DC Coax 2.1mmx5.5mm)	9-12VDC 170mA 18V MOV Surge Suppression
Battery Backup NiMH	1 year with 24 hour charge
Register Serial Port Bi-Directional (DB9 Female)	RS-232C      RS-232 Opto      RS-485 / RS-422      PassiveHi-Z
	RXD - Pin 2      RXD - Pin 2      A - Pin 4      RXD - Pin 2
	TXD - Pin 3      GND - Pin 5      B - Pin 6      TXD - Pin 3
	GND - Pin 5      Jumper s 14&18      GND - Pin 5      GND - Pin 5
Baud Rate	AUTO, 1200, 2400, 4800, 9600, 19.2K, 28.8K, 38.4K, 57.6K, 115.2K
Word Length	7 or 8
Parity	ODD, EVEN, NONE
Stop Bits	1
RTS / CTS Handshaking	ON or OFF (3.3K Pull Up Jumper Selectable)
DTR / DSR	3.3K Pull Up (3.3K Pull Up Jumper Selectable)
Data Buffer	128K bytes
Data/Network Port (RJ45 X2 in Parallel)	RS-232 or RS-485 TXD Only or RS-485 Bi-Directional (Jumper 4 & 11)
Baud Rate	1200-115.2K, 8 bits, No Parity, 1 stop Bit
Alarm Outputs Pin 1 & 9	Open Collector 12VDC @ 20mA (Jumpers 18 & 6)
Alarm Input Pin 7 (RTS)	Closure to Ground, 12 VDC Max
Real Time Clock	12 or 24 Hr with Auto Daylight Savings Time Programmable
Date Format	MM/DD/YY, DD/MM/YY, YY/MM/DD Julian Calendar
Display Characters	40
Number of Lines	1-11
Character and Border Gray Scale	8 levels of Gray
Screen Update Delay .5s	ON or OFF
Auto Scrolling from last line	
Line Processing	Compress, Truncate, Space Compress, Left Justify, Scroll Matching
DVR Support	MVDR2000, 3000, 4000, 5000, DMS-3001, DVR-3011, DVR-3021
Watchdog Timer Hardware and Software	Local / Remote Programming via PC Software
Local Firmware Downloading	History Buffer Downloadable / Searchable
40 Mhz Processor Operation	
Temperature Rating	0 - 50 degrees Celsius 32 - 122 degrees Fahrenheit
Humidity	Non-Condensing 85% RH
Weight	0.68 Kg or 1.5 lbs
Metal Enclosure Beige	130L x 127W x 38H (mm) 5.12L x 5W x 1.5H (in)
Maximum Size with Connectors	145L x 127W x 43H (mm) 5.7L x 5W x 1.7H (in)
Packed in White Box with Manual	1.02 Kg or 2.26 lbs 340L x 190W x 85H (mm) 13.4L x 86.2W x 3.35H (in)



### 3. CONNECTIONS

The VSI-Pro Max will overlay the characters on any input video source. The video input can be virtually any baseband or composite video source. The VSI-Pro will accept NTSC, RS-170, RS-330, CCIR, PAL or SECAM video formats. The Video input to the VSI-Pro Max is a standard BNC connector, terminated at 75 [ohms].

**NOTE**  *The input video level must be between 0.5V - 2.0V Peak to Peak. If the video is lower or not present the VL LED will illuminate signifying low or no video and the VSI-Pro Max will have a poor or no output video signal.*

After completing the interface installation as described in the separate Installation Guide for your specific cash register, computer, radar gun or other serial device, connect the video input source to the video input BNC on the rear of the VSI-Pro Max. The BNC video output goes out to the video system (VCR, DVR, quad, switcher, multiplexer, or monitor). This connection is shown in Figure 4. The video output from the VSI-Pro Max is 1[V] Peak to Peak into a 75 [ohm] load. Most monitors or televisions with direct video inputs are terminated with a 75 ohm load. If the monitor is not terminated, the VSI-Pro Max will still output 1[V] Peak to Peak. The VSI-Pro Max will be able to drive two terminated loads without loss of video level.

The VSI-Pro Max uses a 9-12VDC @300 [mA] UL/CSA power supply which must be plugged into the Power input on the VSI-Pro Max's Real Panel.

#### 3.1 LED Indicators

Power	Green	Signifies power is supplied to the unit
Register Data	Green	This LED flashes whenever data is received from the cash register
Network LED	Red	This LED flashes whenever data is sent or received on the Network Port
Video Error	Red	This LED illuminates with the video level is not present or too low



Figure 1: VSI-Pro Max Front Indicator LEDs and Programming Pushbuttons



Figure 2: VSI-Pro Max RJ45 Network Connections



Figure 3: VSI-Pro Max Rear Connections

Pin #	Label	Direction	Function
1	Alarm Out 1	From VSI-Pro Max	Open Collector Transistor
2	Receive Data	To VSI-Pro Max	Data from Cash Register
3	Transmit Data	From VSI-Pro Max	Data to Cash Register
4	DTR	From VSI-Pro Max	Remain High or RS-485 Input (+)(A)
5	Ground	-----	Signal / Power Gnd or Isolated RS-232 Input Gnd
6	DSR	From VSI-Pro Max	Remain High or RS-485 Input (-)(B)
7	RTS	To VSI-Pro Max	Alarm Input or Hardware Handshaking
8	CTS	From VSI-Pro Max	DVR RS-232 Output or Hardware Handshaking
9	Alarm Out 2	From VSI-Pro Max	Open Collector Transistor or Signal / Power Gnd

Table 1: Pin-Out of the DB-9 Female Connector on the VSI-Pro Max

### 3.2 RS-232 SERIAL INPUT

The VSI-Pro Max accepts serial data via the DB-9 Female connector located on the rear of VSI-Pro Max. This connector is similar to “AT” type computer RS232 serial ports and the pin out is identical. Table 1 shows the standard pin out for VSI-Pro Max RS-232 female connector. On the other hand Table 2 compares the VSI-Pro Max RS-232 with standard “AT” computer’s RS-232 connector.

PIN #	SIGNAL NAME ( RS232 )	VSI-Pro Max
1	CD (Carrier Detect )	Alarm Out 1
2	RXD ( Recieve Data )	RXD
3	TXD ( Transmit Data )	TXD
4	DTR ( Data Terminal Ready )	Always True
5	SG ( Signal Control )	GND
6	DSR ( Data Set Ready )	Always True
7	RTS ( Request to Send )	RTS ( Option)
8	CTS ( Clear to Send )	CTS ( Option)
9	RI ( Ring Indicator )	Alarm Out 2

Table 2: RS-232 DB-9 Pin-Out vs VSI-Pro Max DB-9 Pin-Out



# CONNECTIONS

PIN #	FUNCTION	DIRECTION
1	Alarm Out 1	Open Collector Transistor
2	No Function	No Function
3	TXD RS-232	From VSI-Pro Max (Option)
4	RS-485 (+) A Data	From or To VSI-Pro Max
5	Ground	
6	RS-485 (-) B Data	From or To VSI-Pro Max
7	RTS ( Alarm In )	To VSI-Pro Max
8	CTS	From VSI-Pro Max
9	Alarm Out 2	Open Collector Transistor

**Note:** When the RS-485 port is set for Bi-Directional RS-485 the TXD port has no function. When the RS-485 port is set for receive data only then the TXD port can be used for an RS-232 output.

Table 3 : Pin-Out of the DB-9 Female Connector on the VSI-Pro RS-422 / RS-485

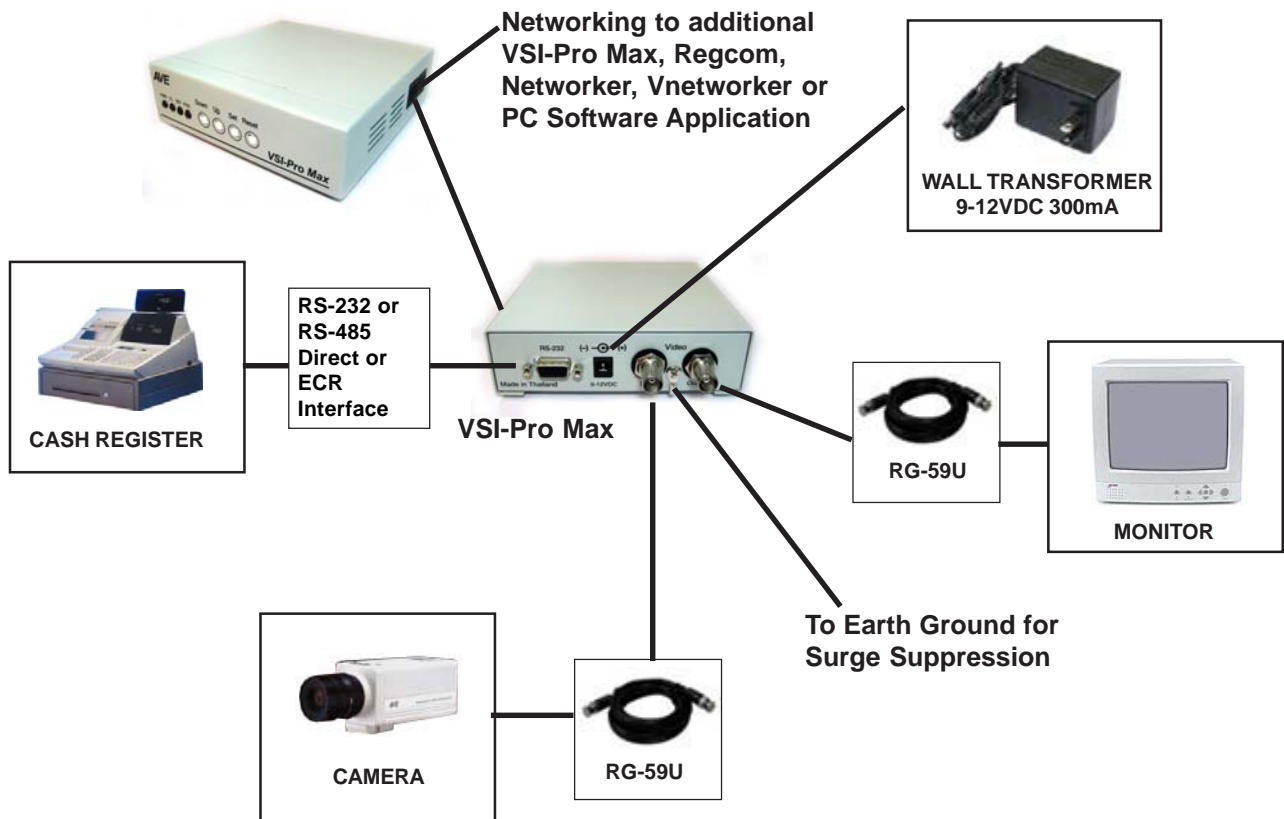

Figure 4: VSI-Pro Max Connections



**Grounding and Isolation**

The VSI-Pro Max has an isolated internal signal/power ground from the case or chassis ground. Therefore maintaining this isolation will insure proper surge and lightning suppression when the chassis grounded properly.

**Video Surge / Lightning Protection**

The VSI-Pro Max has an internal Gas Discharge Surge Suppressor on the video input. This enables high input surges to be suppressed so not to damage the internal circuitry of the VSI-Pro Max. Voltage spikes between video signal and video ground will be clamped and also between both of these signals and chassis ground. For this suppression to be fully effective the "Earth" grounding lug between the two BNC connectors must be connected to a solid and true earth ground. A good earth ground is a long metal rod into the ground 6' or connection to copper water pipes.

**NOTE:** If ground loops are in excess of 90 VAC to Earth or Signal ground the internal surge suppress make not be effective and cause undo noise in the video. If this is the case do not use the chassis grounding lug for undo voltage will be shorted through the suppression circuitry of the VSI-Pro Max.



**Figure 5 : VSI-Pro Max Earth Grounding Connection**

**Power Surge / Lightning Suppression**

The VSI-Pro Max has MOV (Metal Oxide Varistors) across the power input to signal ground and from both of these signal to chassis ground clamping at 18VDC. For this suppression to be fully effective the "Earth" grounding lug between the two BNC connectors must be connected to a solid and true earth ground. A good earth ground is a long metal rod into the ground 6' or connection to copper water pipes.

**RS-232 DB9F Shielding**

The shield of the DB9 RS-232 connector also connects to chassis ground. Therefore this shield should not be connected to any signal ground of any RS-232 signal or power signal. If for some reason the source or destination devices have internal connections from signal ground to the shield then the shield should not be connected on VSI-Pro Max end to maintain signal ground and earth ground isolation. Proper shielding of RS-232 signals will extend the length of wiring especially at high data rates and eliminate noise being coupled into the either a source or destination device by surrounding EMI or RFI generated by other equipment within the installation.

## 4. USER FRONT PANEL CONTROLS

---

The VSI-Pro Max is programmed by pressing and releasing specific combinations of the four front panel push-buttons. Via these four simple buttons, all of the powerful programming features of the Text Inserter are available. A video source and a monitor must be connected in order to see the programming menus.

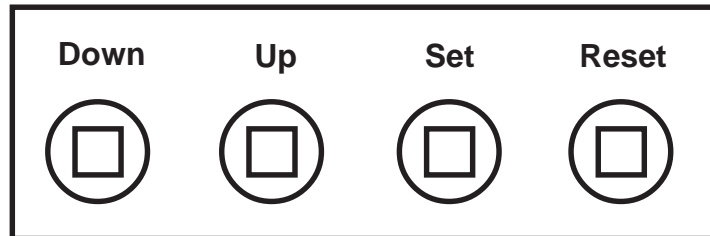

Figure 6 : Four Front Panel Push Buttons of VSI-Pro Max



### 4.1 FRONT PANEL CONTROLS

The front panel controls are provided to allow simple changing of the display's vertical and horizontal position and the gray scale or border. This eliminates the need of the user to enter the main menu and inadvertently change important programming setups.

#### *Changing the Gray Scale*

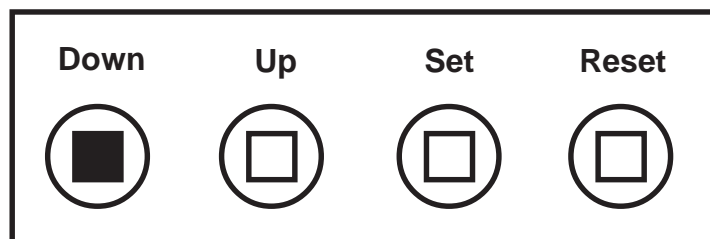
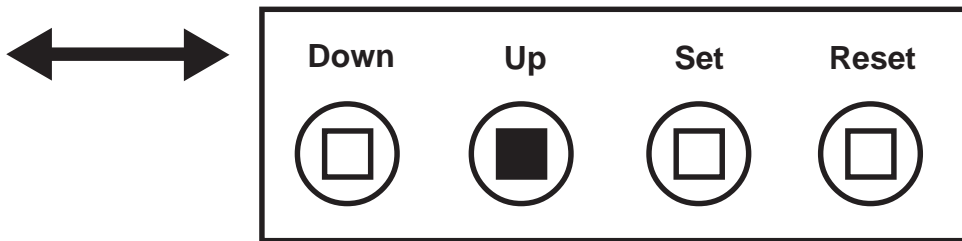

Figure 7: Four Front Panel Push Buttons of VSI-Pro Max (Down)

- 1) Press and hold the "Down" button.
- 2) Press and release the "Reset" button.
- 3) Release the "Down" button.
- 4) Press "Down" or "Up" to select the Gray Scale.
- 5) When choice is made, press and release the "Set" button.

**Changing the Horizontal Position**



**Figure 8: Four Front Panel Push Buttons of VSI-Pro Max (Up)**

1. Press and hold the “Up” button.
2. Press and release the “Reset” button.
3. Release the “Up” button.
4. Press “Down” or “Up” to move the text block.
5. When the choice is made, press and release the “Set” button.

**Changing the Vertical Position**

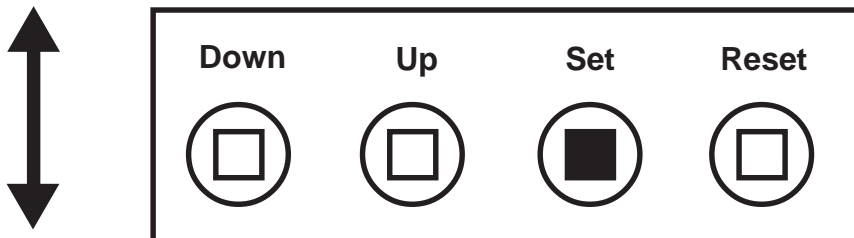

**Figure 9: Four Front Panel Push Buttons of VSI-Pro Max (Set)**

- 1) Press and hold the “Set” button.
- 2) Press and release the “Reset” button.
- 3) Release the “Set” button.
- 4) Press “Down” or “Up” to move the text block.
- 5) When the choice is made, press and release the “Set” button.

## 5. PROGRAMMING

---

### 5.1 GETTING STARTED

To access the main-menu of the VSI-Pro Max, simultaneously hold down the “Down” & “Up” buttons and press and release the “Reset” button and then release the “Down” & “Up” buttons. This will take you to the main programming menu. To navigate through this menu, simply use the “Down” and “Up” buttons to position the cursor in front of the desired function, then press “Set” to access that function.

If you have difficulty entering the main-menu, try the following procedure exactly. With your left thumb, lightly press and hold in the two buttons to the left (Up & Down). While holding down these buttons, press and release the “Reset” button with your right thumb. Then release the other buttons.

#### **NOTE**

*If a sub-menu has an “EXIT” selection, always go there and press “Set”. Pressing “Reset” at the main-menu exits you from the programming mode.*

### 5.2 MAIN PROGRAMMING MENU

Following is a detailed description of the menu selections and the programming capabilities of the VSI-Pro.

- REGISTER SELECT
- SCREEN SETUP
- TEXT DISPLAY
- COMMUNICATION
- EXCEPTION REPORT
- ALARM OUTPUTS
- TEST/DEMO MODE
- DOWNLOAD/UPLOAD SETUP
- HELP

Figure 10 : VSI-Pro Max Main-Menu

### 5.3 REGISTER SELECT

To select a specific register, press the “Up” or “Down” button to move the cursor to “REGISTER SELECT” and press “Set”. The REGISTER SELECT menu will bring up a sub-menu consisting of registers shown in Figure 10-A. You can go to the next or previous page by placing the cursor in front of “NEXT” or “PREVIOUS” and then pressing “Set”. To select the desired register, press the “Up” or “Down” button to move the cursor to that register and press “Set”. After selecting the register, exit out of the REGISTER SELECT menu by pressing the “Up” or “Down” button to move the cursor to “EXIT” and then pressing “Set”. In the main-menu, press “Reset” to activate the programming for that specific register. REGISTER SELECT automatically formats the VSI-Pro to match your register’s communication settings. However, if you need to change these settings, you can do so through the COMMUNICATION menu described later in this manual.

#### **NOTE**

*Whenever you select a register in this menu, certain programming features are reset to the default settings. Always set the register selection first, get the data on-screen, then proceed with additional programming.*



TCP/IP

Press the “Up” or “Down” button to move the cursor to “REGISTER SELECT” and press “Set”. The REGISTER SELECT menu will appear:

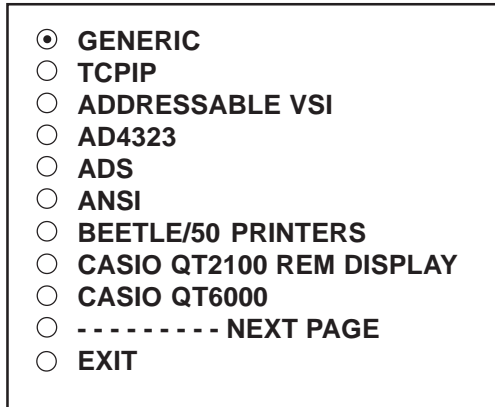

Figure 11: REGISTER SELECT Sub-Menu

Press the “Up” or “Down” button to move the cursor to “TCPIP” and press “Generic”. In this mode is simply no filtering of the input data and will display any printable character in the video. If you are not sure of what you are connecting to this is the first selection so you will see everything and then later choose the options you want to better filter the display to your liking.

1. Press the “Up” or “Down” button to move the cursor to “TCPIP” and press “Set” to enter and change the IP address to the same as the IP address you wish to monitor.

**EXAMPLE: If the IP address is 192.168.0.141, set the address on the TCPIP 232 Adapter using this menu.**

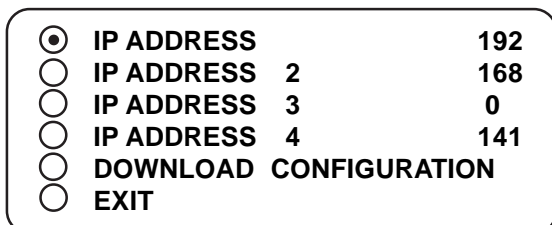

Figure 12: TCPIP Sub-Menu

2. Press the “Up” or “Down” button to move the cursor to “Download Configuration” and press “Set” to execute. Make sure a TCPIP232 Adapter is connected and the VSI-Pro will download the IP settings to this device.

3. Press the “Up” or “Down” button to move the cursor to “EXIT” and press “Set” to return to the previous menu.

Refer to Appendix I for additional information on the TCPIP232 Adapter or the manual included with the adapter.

**NOTE:** The TCPIP232 Adapter can be programmed by this method or by using a standard PC with a serial cable along with the AVE IP setting software. Refer to the TCPIP232 Adapter Manual for doing this.

Once you have set the IP address of the TCPIP232 Adapter you will be in the “Generic” display mode. You may select another register driver to format this display. When you do this the VSI-Pro loads the default register baudrate as if a direct connection to the register so make sure you set the proper baudrate as described below.

The TCPIP232 Adapter communicates with the VSI-Pro via RS-232 at a baudrate of 19.2K. Therefore when you select this menu option the baudrate of the VSI-Pro is changed to this rate so communication for downloading the configuration can occur. When using the TCPIP232 adapter with other register drivers or data dump mode make sure you change the RXD baudrate to 19.2K so the VSI-Pro Max will communicate.

**TCPIP Limitations**

The TCPIP232 Adapter can monitor any Ethernet LAN either 10MB/s or 100MB/s. However the actual long term throughput of the adapter is limited to 5MB/s. This is more than enough for network printers for cash receipts, bar code scanners or single cash registers that operate in a “Live Mode”. Live Mode means the register transmits the data on the network line by line or at the end of each transaction. Some cash registers have large local built in memories for thousands of items and then only batch multiple transactions on the network at any given time or controlled by the server. Cash Registers utilizing this kind of batch processing are not suitable for security monitoring. Other devices that output large amounts of data will overrun the buffers of either the TCPIP232 Adapter or VSI-Pro Max and data will be lost and would not be suitable for security monitoring anyway.

The VSI-Pro Max has a set of powerful data dump modes that compatible with the TCPIP232 Adapter. If large data packets need filtering or special formats are required contact the factory.



# PROGRAMMING

## GENERIC

Press the "Up" or "Down" button to move the cursor to "PC COM 1,2,3,4" and press "Set". No menu will appear and merely sets the VSI-Pro Max to "Generic" mode.

### ADDRESSABLE VSI (VSI-ADD)

Press the "Up" or "Down" button to move the cursor to "ADDRESSABLE VSI" and press "Set". The ADDRESSABLE VSI menu will appear:



Figure 13: ADDRESSABLE VSI Sub-Menu

SET ADDRESS

Choices: ANY, 1, 2, 3,..., 253, 254, 255

### AD4323

Press the "Up" or "Down" button to move the cursor to "AD4323" and press "Set". No menu will appear and merely sets the VSI-Pro Max to support the special protocol of this model.

### ADS

Press the "Up" or "Down" button to move the cursor to "ADS" and press "Set". The ADS menu will appear.

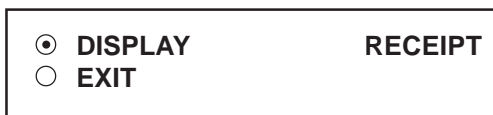

Figure 14: ADS Sub-Menu

DISPLAY

Choices: JOURNAL, RECEIPT

### ANSI

Press the "Up" or "Down" button to move the cursor to "ANSI" and press "Set".

This selects an ANSI driver for the VSI-Pro Max. In this mode standard ANSI terminal commands sent to the VSI-Pro Max will control the display of the data on the screen. See Appendix for a detailed command set supported.

## BEETLE/50 PRINTERS

Press the "Up" or "Down" button to move the cursor to "NIXDORF BEETLE" and press "Set". The NIXDORF BEETLE menu will appear:



Figure 15: NIXDORF BEETLE Sub-Menu

### CASIO TK-T500

Press the "Up" or "Down" button to move the cursor to "CASIO TK-T500" and press "Set". The CASIO TK-T500 menu will appear:

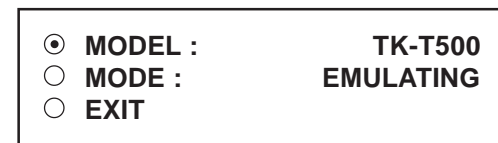

Figure 16: CASIO TK-T500 Sub-Menu

MODE

Choices: TAPPING, EMULATING

### CASIO TE-2200

Press the "Up" or "Down" button to move the cursor to "CASIO TE-2200" and press "Set". The CASIO TE-2200 menu will appear:

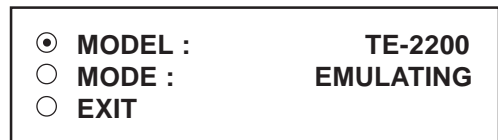

Figure 17: CASIO TE-2200 Sub-Menu

MODE

Choices: TAPPING, EMULATING

### CLARITY EPOS

Press the "Up" or "Down" button to move the cursor to "CLALITY EPOS" and press "Set". The CLALITY EPOS menu will appear:

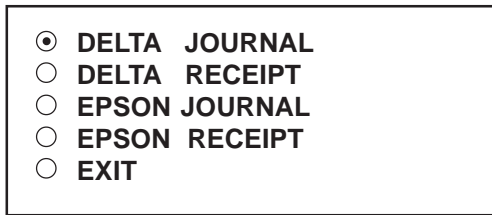

Figure 18: CLARITY EPOS Sub-Menu



**DELTA SONO 3.1**

Press the “Up” or “Down” button to move the cursor to “DELTA SONO 3.1” and press “Set”. The DELTA SONO 3.1 menu will appear:



**Figure 19: DELTA SONO 3.1 Sub-Menu**

**DRESSER WAYNE**

Press the “Up” or “Down” button to move the cursor to “DRESSER WAYNE” and press “Set”. The DRESSER WAYNE menu will appear:

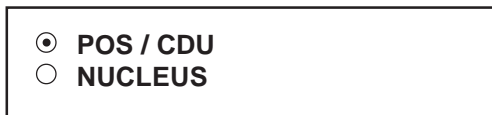

**Figure 20: DRESSER WAYNE Sub-Menu**

Press the “Up” or “Down” button to move the cursor to “POS / CDU” and press “Set”. The POS / CDU menu will appear:



**Figure 21: POS / CDU Sub-Menu**

Press the “Up” or “Down” button to move the cursor to “NUCLEUS” and press “Set”. The NUCLEUS menu will appear:

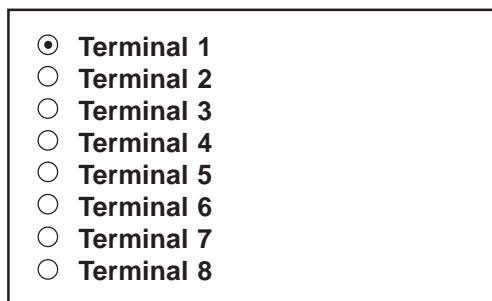

**Figure 22: NUCLEUS Sub-Menu**

**EDACOM**

Press the “Up” or “Down” button to move the cursor to “EDACOM” and press “Set”. The EDACOM menu will appear:

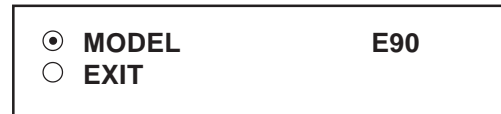

**Figure 23: EDACOM Sub-Menu**

Press the “Up” or “Down” button to move the cursor to “MODEL E90” and press “Set”. The MODEL E90 menu will appear:



**Figure 24: MODEL E90 Sub-Menu**

**MODEL**

*Choices: E90, E9010*

**EPSON GENERIC**

Press the “Up” or “Down” button to move the cursor to “EPSON GENERIC” and press “Set”. The EPSON GENERIC menu will appear:

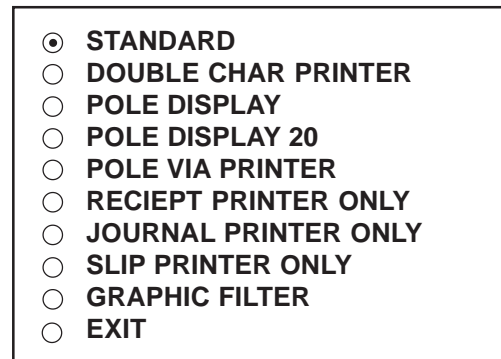

**Figure 25: EPSON GENERIC Sub-Menu**

**FUJITSU 9920**

Press the “Up” or “Down” button to move the cursor to “FUJISU 9920” and press “Set”. The FUJISU 9920 menu will appear:

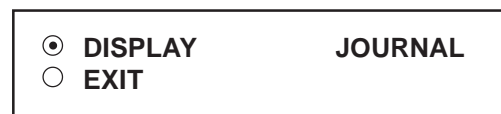

**Figure 26: FUJITZU 9920 Sub-Menu**

*Choices: Journal, Receipt*

## PROGRAMMING

### GASBOY

Press the "Up" or "Down" button to move the cursor to "GASBOY" and press "Set". The GASBOY20-A menu will appear:

<input checked="" type="radio"/> <b>DEVICE</b>	<b>CONSOLE</b>
<input type="radio"/> <b>DEVICE ADDRESS</b>	<b>01</b>
<input type="radio"/> <b>EXIT</b>	

Figure 27: GASBOY Sub-Menu

#### DEVICE

Choices: *PRINTER, CONSOLE, CSL OLD*

#### DEVICE ADDRESS

Choices: *ANY, 01, 02, 03, ..., 17*

### GILBARCO

Press the "Up" or "Down" button to move the cursor to "GILBARCO" and press "Set". The GILBARCO menu will appear:

<input checked="" type="radio"/> <b>PC G-SITE</b>
<input type="radio"/> <b>TCRG / 2</b>
<input type="radio"/> <b>TCR 15 G [ OLD FMT ]</b>
<input type="radio"/> <b>TCR 15 G [ NEW FMT ]</b>
<input type="radio"/> <b>PASSPORT</b>

Figure 28: GILBARCO Sub-Menu

### IBM 3151 TERMINAL

Press the "Up" or "Down" button to move the cursor to "IBM 3151 TERMINAL" and press "Set". The IBM 3151 TERMINAL menu will appear:

<input checked="" type="radio"/> <b>DISPLAY</b>	<b>MIXED</b>
<input type="radio"/> <b>EXIT</b>	

Figure 29: IBM 3151 TERMINAL Sub-Menu

#### DISPLAY

Choices: *JOURNAL, RECEIPT, MIXED*

### IBM RDS

Press the "Up" or "Down" button to move the cursor to "IBM RDS" and press "Set". The IBM RDS menu will appear:

<input checked="" type="radio"/> <b>DISPLAY</b>	<b>JOURNAL</b>
<input type="radio"/> <b>EXIT</b>	

Figure 30: IBM RDS Sub-Menu

#### DISPLAY

Choices: *JOURNAL, RECEIPT, MIXED*

### MICRELEC

Press the "Up" or "Down" button to move the cursor to "MICRELEC" and press "Set". The MICRELEC menu will appear:

<input checked="" type="radio"/> <b>MICRELEC</b>	<b>MS</b>	<b>SERIES</b>
<input type="radio"/> <b>MICRELEC</b>	<b>9500</b>	
<input type="radio"/> <b>EXIT</b>		

Figure 31: MICRELEC Sub-Menu

Press the "Up" or "Down" button to move the cursor to "MICRELEC MS SERIES" and press "Set". The MICRELEC MS SERIES menu will appear:

<input checked="" type="radio"/> <b>OPERATOR</b>
<input type="radio"/> <b>CUSTOMER</b>
<input type="radio"/> <b>COMBINED</b>
<input type="radio"/> <b>EXIT</b>

Figure 32: MICRELEC MS SERIES Sub-Menu

Press the "Up" or "Down" button to move the cursor to "MICRELEC 9500" and press "Set". The MICRELEC9500 menu will appear:

<input checked="" type="radio"/> <b>JOURNAL</b>
<input type="radio"/> <b>RECEIPT</b>
<input type="radio"/> <b>CHECK</b>
<input type="radio"/> <b>CREDIT</b>
<input type="radio"/> <b>EXIT</b>

Figure 33: MICRELEC 9500 Sub-Menu

**SOURCE TYPE**

Press the “Up” or “Down” button to move the cursor to “MICROS” and press “Set”. The MICROS menu will appear:

- LOCAL VSS
- MICROS IDN NETWORK
- MICROS ISN NETWORK
- EXIT

Figure 34: MICROS Sub-Menu

**MICROS IDN NETWORK**

Press the “Up” or “Down” button to move the cursor to “MICROS IDN NETWORK” and press “Set”. The MICROS IDN NETWORK menu will appear:

- DEVICE : PRINTER
- DEVICE ADDRESS: ANY
- MODE: TAP
- EXIT

Figure 35: MICROS IDN NETWORK Sub-Menu

DEVICE

Choices: PRINTER, VIDEO

DEVICE ADDRESS

Choices: ANY, 01, 02, 03,...,13, 14, 15

MODE

Choices: EMULATE, TAP

**MICROS ISN NETWORK**

Press the “Up” or “Down” button to move the cursor to “MICROS ISN NETWORK” and press “Set”. The MICROS ISN NETWORK menu will appear:

- SOURCE TYPE : ANY
- SRC ISN GNA : ANY
- SRC ISN LNA : ANY
- SRC IDN ID : ANY
- DESTIN TYPE : ANY
- DST ISN GNA : ANY
- DST ISN LNA : ANY
- DST IDN ID : ANY
- EXIT

Figure 36: MICROS IDN NETWORK Sub-Menu

**SOURCE TYPE**

Choices: ANY, 00, 01, 02 ,03,..., 09

**SRC ISN GNA**

Choices: ANY, 00, 01, 02, 03,..., 32

**SRC ISN LNA**

Choices: ANY, 00, 01, 02, 03,..., 32

**SRC IDN ID**

Choices: ANY, 00, 01, 02, 03,..., 15

**DESTIN TYPE**

Choices: ANY, 00, 01, 02, 03,..., 09

**DST ISN GNA**

Choices: ANY, 00, 01, 02, 03,..., 32

**DST ISN LNA**

Choices: ANY, 00, 01, 02, 03,..., 32

**DST IDN ID**

Choices: ANY, 00, 01, 02, 03,..., 15

**NCR**

Press the “Up” or “Down” button to move the cursor to “NCR” and press “Set”. The NCR menu will appear:

- NCR 2113,3110
- NCR 745X [ POLE ]
- NCR JRNL PRINTER
- NCR RCPT PRINTER
- NCR SLIP PRINTER

Figure 37: NCR Sub-Menu

**NIXDORF BEETLE**

Press the “Up” or “Down” button to move the cursor to “NIXDORF BEETLE” and press “Set”. The NIXDORF BEETLE menu will appear:

- JOURNAL PRINTER
- RECEIPT PRINTER

Figure 38: NIXDORF BEETLE Sub-Menu



## PROGRAMMING

### NORAND 1200

Press the “Up” or “Down” button to move the cursor to “NORAND 1200” and press “Set”. The NORAND 1200 menu will appear:

<input checked="" type="radio"/> TITLE DISPLAY :	ON
<input type="radio"/> CONSOLE ID :	ANY
<input type="radio"/> WORKING MODE :	
<input type="radio"/> EXIT	

Figure 39: NORAND 1200 Sub-Menu

#### TITLE DISPLAY

Choices: ON, OFF

#### CONSOLE ID :

Choices: ANY, 1, 2, 3, 4, 5, 6, 7, 8

#### WORKING MODE

Choices: ACK , TAP

### NUCLEUS PRINTER

Press the “Up” or “Down” button to move the cursor to “NUCLEUS PRINTER” and press “Set”. The NUCLEUS PRINTER” menu will appear:

<input checked="" type="radio"/> STANDARD [Both]
<input type="radio"/> PRINTER WITH POLE
<input type="radio"/> POLE VIA PRINTER

Figure 40 : NUCLEUS PRINTER Sub-Menu

### OMEGA 2000

Press the “Up” or “Down” button to move the cursor to “OMEGA 2000” and press “Set”. The OMEGA 2000 menu will appear:

<input checked="" type="radio"/> JOURNAL PRINTER
<input type="radio"/> RECEIPT PRINTER

Figure 41: OMEGA 2000 Sub-Menu

### PANASONIC

Press the “Up” or “Down” button to move the cursor to “PANASONIC” and press “Set”. The PANASONIC menu will appear:

<input checked="" type="radio"/> MODEL :	6000
<input type="radio"/> WORKING MODE :	TAP
<input type="radio"/> EXIT	

Figure 42: PANASONIC Sub-Menu

#### MODEL

Choices : 6000, 7000, 8000

#### WORKING MODE

Choices : ACK , TAP

### SCHLUMBERGER

Press the “Up” or “Down” button to move the cursor to “SCHLUMBERGER” and press “Set”. The SCHLUMBERGER menu will appear:

<input checked="" type="radio"/> DISPLAY	RECEIPT
<input type="radio"/> EXIT	

Figure 43: SCHLUMBERGER Sub-Menu

#### DISPLAY

Choices: RECEIPT, CDU[ 2L ], C.D.U.

### SHARP

Press the “Up” or “Down” button to move the cursor to “SHARP” and press “Set”. The SHARP menu will appear.

<input checked="" type="radio"/> 2590
<input type="radio"/> 3100,3110
<input type="radio"/> 3220,3221,3250
<input type="radio"/> 3310,3311,3550
<input type="radio"/> A-460,A-470
<input type="radio"/> A-550,A-570
<input type="radio"/> A-610,A650
<input type="radio"/> A-750
<input type="radio"/> A-770

Figure 44: SHARP Sub-Menu

**SHARP 750 ER-01PU**

Press the “Up” or “Down” button to move the cursor to “SHARP 750 ER-01PU” and press “Set”. The SHARP 750 ER-01PU menu will appear:

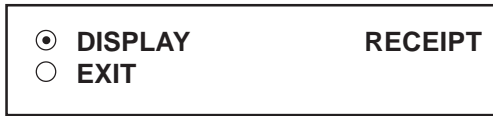

**Figure 45: SHARP 750 ER-01PU Sub-Menu**

DISPLAY

Choices: RECEIPT, JOURNAL

**SHARP ER-A410/420**

Press the “Up” or “Down” button to move the cursor to “SHARP ER-A410/420” and press “Set”. The SHARP ER-A410/420 menu will appear:



**Figure 46: SHARP ER-A410/420 Sub-Menu**

**SHARP UP600/700**

Press the “Up” or “Down” button to move the cursor to “SHARP UP600/700” and press “Set”. The SHARP UP600/700 menu will appear:



**Figure 47: SHARP UP600/700 Sub-Menu**

**SICOM**

Press the “Up” or “Down” button to move the cursor to “SICOM ” and press “Set”. The SICOM menu will appear:



**Figure 48: SICOM Sub-Menu**

SECRET ADDRESS

Choices: ANY, 1, 2, 3,..., 255

**SPEDI CCTV**

Press the “Up” or “Down” button to move the cursor to “SPEDI CCTV ” and press “Set”. The SPEDI CCTV menu will appear:



**Figure 49 : SPEDI CCTV Sub-Menu**

SET ADDRESS

Choices: ANY, 1, 2, 3,..., 255

**SUNTRONIC**

Press the “Up” or “Down” button to move the cursor to “SUNTRONIC” and press “Set”. The SUNTRONIC menu will appear.



**Figure 50: SUNTRONIC Sub-Menu**

TCI

Press the “Up” or “Down” button to move the cursor to “TCI” and press “Set”. The TCI menu will appear:



**Figure 51: TCI Sub-Menu**

DEVICE ADDRESS

Choices : 000, 001, 002,..., 999

**TEC SLIP PRINTER EMULATE**

Press the “Up” or “Down” button to move the cursor to “TEC SLIP PRINTER EMULATE” and press “Set”. The TEC SLIP PRINTER EMULATE” menu will appear:



**Figure 52: TEC SLIP PRINTER Sub-Menu**

## PROGRAMMING

### TKMAX

Press the "Up" or "Down" button to move the cursor to "TKMAXX" and press "Set". The TKMAXX menu will appear:

<input checked="" type="radio"/> JOURNAL PRINTER
<input type="radio"/> RECEIPT PRINTER

Figure 53: TKMAXXSub-Menu

### UNIWELL

Press the "Up" or "Down" button to move the cursor to "UNIWELL UN 4025" and press "Set". The UNIWELL UN 4025 menu will appear:

<input checked="" type="radio"/> DEVICE ADDRESS	000
<input type="radio"/> ANY ADDRESS	ON
<input type="radio"/> EXIT	

Figure 54: UNIWELL UN 4025 Sub-Menu

#### DEVICE ADDRESS

Choices: 000, 001, 002, ..., 999

#### ANY ADDRESS

Choices: ON, OFF

### UP3000/3300

Press the "Up" or "Down" button to move the cursor to "UP3000/3300" and press "Set". The UP3000/3300 menu will appear:

<input checked="" type="radio"/> TERMINAL	1
<input type="radio"/> EXIT	

Figure 55: UP3000/3300 Sub-Menu

#### TERMINAL

Choices: 1, 2, 3, ..., 16

### VERIFONE

Press the "Up" or "Down" button to move the cursor to "VERIFONE" and press "Set". The VERIFONE menu will appear:

<input checked="" type="radio"/> JOURNAL TAPPING
<input type="radio"/> RECEIPT TAPPING
<input type="radio"/> JOURNAL EMULATING
<input type="radio"/> RECEIPT EMULATING

Figure 56: VERIFONE Sub-Menu

### WEIGHSCALE

Press the "Up" or "Down" button to move the cursor to "WEIGH SCALE" and press "Set". The WEIGH SCALE menu will appear:

<input checked="" type="radio"/> AVERY
<input type="radio"/> MOLENS
<input type="radio"/> LEON LD5204

Figure 56A: WEIGH SCALE Sub-Menu

#### NOTE

*As we continually add new registers, these menus are subject to change.*



## 5.4 SCREEN SETUP

Press the “Up” or “Down” button to move the cursor to “SCREEN SETUP” and press “Set”. The following menu will appear:

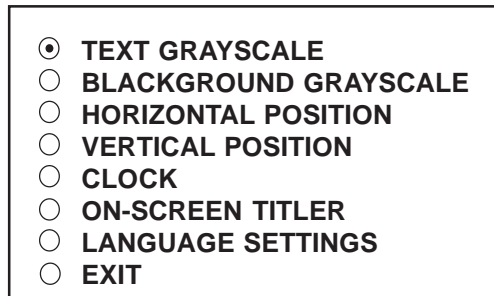

Figure 57: SCREEN SETUP Sub-Menu

### TEXT GRAYSCALE

To change the display border and/or the grayscale of the text on screen, press the “Up” or “Down” button to move the cursor to “TEXT GRAYSCALE” and press “Set”. Cycle through the selections by pressing the “Up” or “Down” buttons. There are 10 settings to choose from. Make your selection and press “Set” to return to the previous menu.

### BACKGROUND GRAYSCALE

To change the display border and/or the grayscale of the text on screen, press the “Up” or “Down” button to move the cursor to “BACKGROUND GRAY SCALE” and press “Set”. Cycle through the selections by pressing the “Up” or “Down” buttons. There are 10 settings to choose from. Make your selection and press “Set” to return to the previous menu.

### HORIZONTAL POSITION

To change the horizontal position of the inserted text on-screen, press the “Up” or “Down” button to move the cursor to “HORIZONTAL POSITON” and press “Set”. Press the “Up” or “Down” buttons to move the text to the desired horizontal position.

### VERTICAL POSITION

To change the vertical position of the inserted text on-screen, press the “Up” or “Down” button to move the cursor to “VERTICAL POSITION” and press “Set”. Press the “Up” or “Down” buttons to move the text to the desired vertical position.

#### **NOTE**

*Upon powering up for the first time or when the battery becomes depleted, the on-screen Time / Date display may be incorrect or have unreadable characters. If this is the case, enter the clock menu and “Reset Time / Date”. The Time / Date will then show readable characters and be unaffected by a Master Reset.*

### CLOCK

To program the clock's functions, press the “Up” or “Down” button to move the cursor to “CLOCK” and press “Set”. The following menu will appear:

## PROGRAMMING

---

<input checked="" type="radio"/> <b>T/D DISPLAY</b>	<b>ON</b>
<input type="radio"/> <b>TIME FORMAT</b>	<b>12 HOUR</b>
<input type="radio"/> <b>DATE FORMAT</b>	<b>MM/DD/YY</b>
<input type="radio"/> <b>DAYLIGHT SAVING</b>	<b>DISABLED</b>
<input type="radio"/> <b>SET TIME / DATE</b>	
<input type="radio"/> <b>RESET TIME / DATE</b>	
<input type="radio"/> <b>T/D LOCKING</b>	<b>ON</b>
<input type="radio"/> <b>EXIT</b>	

**Figure 58: CLOCK Sub-Menu**

**T/D DISPLAY** turns the time/date display on or off. Press the “Up” or “Down” button to move the cursor to “T/D DISPLAY” and press “Set”. The cursor will start flashing. Press the “Up” or “Down” button to toggle between “ON” or “OFF” and press “Set” when the desired value is displayed.

**TIME DISPLAY** selects either 12-hour AM/PM or 24-hour Military Time format with AM/PM. Press the “Up” or “Down” button to move the cursor to “TIME DISPLAY” and press “Set”. The cursor will start flashing. Press the “Up” or “Down” button to toggle between time formats and press “Set” when the desired format is displayed.

**DATE FORMAT** chooses one of the three available formats. Press the “Up” or “Down” button to move the cursor to “DATE FORMAT” and press “Set”. The cursor will start flashing. Press the “Up” or “Down” button to toggle between date formats and press “Set” when the desired format is displayed.

**DAYLIGHT SAVING** selects, for example, UK, USA, Canada, Australia and Tasmania or is disabled. Press the “Up” or “Down” button to move the cursor to “DAYLIGHT SAVING” and press “Set”. The cursor will start flashing. Press the “Up” or “Down” button to toggle between values and press “Set” when the desired value is displayed.

**SET TIME/DATE** sets the clock manually. Press the “Up” or “Down” button to move the cursor to “SET TIME/DATE” and press “Set”. The time/date will appear and the cursor will start flashing. Press the “Up” and “Down” button to change the value and press “Set” when the desired value is displayed. The value is selected and the cursor will advance to the next position. When the desired time/date is displayed, press the “Up” and “Down” buttons simultaneously to enter the time/date into memory and return to the previous menu.

**RESET TIME/DATE** resets the clock to the default value. Press the “Up” or “Down” button to move the cursor to “RESET TIME/DATE” and press “Set” to reset the time/date.

**T/D LOCKING** turns the time/date locking on or off. If the time/date locking is turned on, make sure that the time and date format selected is the same as the ATM time and date format. Press the “Up” or “Down” button to move the cursor to “T/D LOCKING” and press “Set”. The cursor will start flashing. Press the “Up” or “Down” button to toggle between “ON” or “OFF” and press “Set” when the desired value is displayed.

If the T/D LOCKING is turned on, make sure that the time format selected is the same as the register’s time/date format. If the T/D LOCKING is turned on, the VSI-Pro will monitor the incoming data string. If it finds a valid time and date in one or two consecutive lines, it will set the clock to whatever time/date it finds. A valid time has the following formats:

HH:MM, HH:MM:ss  
HH:MM AM, HH:mm:ss AM  
HH:MM PM, HH:MM:ss PM

where hh is a number between 0 and 12 ( 24 if either AM or PM not present )  
A valid date has the same format as for date display and has either “/” or “-” as a separator.

### ON-SCREEN TITLER

Press the “Up” or “Down” button to move the cursor to “ON-SCREEN TITLER” and press “Set”. The following menu will appear:



<input checked="" type="radio"/>	<b>TITLER</b>	<b>OFF</b>
<input type="radio"/>	<b>TITLE</b>	
<input type="radio"/>	<b>EXIT</b>	

Figure 59: ON-SCREEN TITLER Sub-Menu

**TITLER**

To change the status of the on-screen titler, press the “Up” or “Down” button to move the cursor to “TITLER” and press “Set”. The cursor will start flashing. Select either “ON” or “OFF” by pressing the “Up” or “Down” button. After making a selection, press “Set”. This will return the cursor to the non-flashing mode. Now select “EXIT” to return to the previous menu.

**TITLE**

The VSI-Pro gives you the option of a 40-character display for easy register identification in addition to the actual register transaction data.

To create a title, press the “Up” or “Down” button to move the cursor to “TITLE” and press “Set”. You will see a row of 40 boxes and the first box will be flashing.

To change the character in the first position, press the “Up” or “Down” buttons to cycle through the alpha-numeric selections from the following list of available characters.

**ABCDEFGHIJKLMNOPQRSTUVWXYZ**  
**abcdefghijklmnopqrstuvwxyz =.:+\*/9876543210**

The solid white box is used for a blank space. Make your selection and press “Set”. This will advance to the next block, repeat until you have entered the desired title. When finished, simultaneously press and release the “Down” & “Up” buttons to enter your title into memory. The white boxes will disappear and your title will be displayed as it will appear on-screen. Press the “Up” or “Down” button to move the cursor to “EXIT” and press “Set” to return to the previous menu.

**NOTE** 

*Remember, enabling the TITLE will limit text insertions to 10 lines maximum.*

**LANGUAGE SETTINGS**

Selecting Language Settings will give you the following menu;

<input checked="" type="radio"/>	<b>LANGUAGE</b>	<b>ENGLISH</b>
<input type="radio"/>	<b>EXIT</b>	

Figure 60: Language Selection

The language selection options are English, German or Spanish

**EXIT**

Press the “Up” or “Down” button to move the cursor to “EXIT” and press “Set” to return to the previous menu.

## PROGRAMMING

### 5.5 TEXT DISPLAY

This menu will give you more control over the actual text block formatting and its appearance on the screen. To access the menu, press the "Up" or "Down" button to move the cursor to "TEXT DISPLAY" and press "Set". The following sub-menu will appear:

<input checked="" type="radio"/> SCREEN BLANK	20
<input type="radio"/> DISPLAY LINES	10
<input type="radio"/> DISPLAY CHARACTER/LINE	40
<input type="radio"/> DISPLAY FORMAT	TOP
<input type="radio"/> LINE COMPRESS	OFF
<input type="radio"/> SPACE COMPRESS	OFF
<input type="radio"/> LEFT JUSTIFIED	OFF
<input type="radio"/> SCROLL DELAY	OFF
<input type="radio"/> DISPLAY	ON
<input type="radio"/> EXIT	

Figure 61: Text Display Sub-Menu

#### SCREEN BLANK

Choices: NONE, 6, 12, 20, 30, 60, 120, 180, 300

This is the amount of time that the VSI-Pro text display will remain on-screen after a transaction before blanking itself off (not the video picture, just the register transaction data) until the next transaction.

To change the SCREEN BLANK setting, press the "Up" or "Down" button to move the cursor to "SCREEN BLANK" and press "SET". The cursor will begin flashing. Press the "Up" or "Down" buttons to cycle through the selections.

Press "Set" when the desired time is displayed. The cursor will stop flashing and you may continue programming.

**NOTE**  *Choosing "NONE" means No Blanking. The VSI-Pro will display the last transaction until a new transaction is performed.*

#### DISPLAY LINES

You have the choice of how many lines of text to display on-screen for register transactions. The choices are up to 11 lines.

To change the DISPLAY LINES setting, press the "Up" or "Down" button to move the cursor to "DISPLAY LINES" and press "Set". The cursor will begin flashing. Press the "Up" or "Down" buttons to cycle through the selections. Press "Set" when the desired number is displayed. The cursor will stop flashing and you may continue programming.

**NOTE**  *All register transaction data will scroll up regardless of the number of lines you choose to display on-screen and the more lines you display on-screen, the greater the amount of time that the transaction data will be recorded. However, some applications may limit the number of lines and the size of the on-screen display. If you are using an on-screen title, it will occupy Line 1, leaving 10 lines for the text insertion. If you enable the on-screen Time/Date then this takes one additional line also.*

#### DISPLAY CHARACTER / LINE

This setting allows you to change the number of characters per line from 10 to 40.



## DISPLAY FORMAT

If "TOP" is selected which is the default, the data scrolls from the top most line down to the selected number of lines displayed. "T/D" and/or "TITLE" is displayed at the top of the screen. If "BOTTOM" is selected then the data scrolls up from the bottom most line to the top of the screen and "T/D" and/or "TITLE" is displayed at the bottom of the screen.

## LINE COMPRESS

**NOTE**  *Set your Exceptions first before enabling this feature.*

The VSI-Pro automatically compresses the spaces in a line first as it reaches 40 characters. With LINE COMPRESS "ON", the VSI-Pro will additionally remove multiple spaces and then vowels from the text to further compress the display as necessary.

To make this selection, position the arrow in front of "LINE COMPRESS" and press and release "Set". The arrow will start flashing. Cycle through "ON" or "OFF" by pressing either the "Up" or "Down" button, and press "Set" when your choice is displayed. The cursor will stop flashing and you can continue programming.

## SPACE COMPRESS

Space Compress allows you select the number of maximum spaces next to each other in a line. The selections are 1,2,3,4,5 and OFF. If you select "1" then if three spaces are shown on the receipt the VSI-Pro will delete 2 and only show 1 space between characters on the video and on the output data to the DVR.

## LEFT JUSTIFICATION

When LEFT JUSTIFIED is "ON", the VSI-Pro will start each line of text with no leading spaces from the left margin of the text display block.

## SCROLL DELAY

Scroll delay ensures that lines of text remain on-screen a minimum of 0.5 seconds. This is especially useful with registers that run at a high baud rate, time-lapse VCRs in extended record modes, switchers, or multiplexers. Sometimes, the register can produce characters so quickly that they can scroll up too fast on the screen to be recorded. When SCROLL DELAY is "ON", the VSI-Pro slows down this data feed just enough to insure that each line of text is recorded.

The choices for SCROLL DELAY are either "ON" or "OFF". To make this selection, position the arrow in front of "SCROLL DELAY" and press and release "Set". The arrow will start flashing. Cycle through "ON" or "OFF" by pressing either the "Up" or "Down" button, then press "Set" when your choice is displayed. The cursor will stop flashing and you can continue programming.

## DISPLAY

You have the choice to globally turn "ON" or "OFF" the complete VSI-Pro text insertion function. This means no data will be visible on the monitor if you select DISPLAY "OFF". However, if you select the DISPLAY "OFF", you can still command each exception independently to either display on-screen or not through its program setup menu under "EXCEPTION REPORTS". You may also choose to enable an alarm output to occur during an exception while not displaying the exception data through the program set-up in the ALARM OUTPUTS menu. With the display "OFF", the VSI-Pro will still perform all functions as programmed, for example, exception reporting will still function, but the information will not appear on-screen unless programmed to do so in the EXCEPTIONS REPORT menu. Also the data will not show in the history buffer if not displayed.

## EXIT

Press the "Up" or "Down" button to move the cursor to "EXIT" and press "Set" to return to the previous menu.



# PROGRAMMING

## 5.6 COMMUNICATION

This was discussed briefly in the section under “REGISTER SELECT” and will be fully explained here. When you choose your register type under the REGISTER SELECT menu, this automatically formats the VSI-Pro to the appropriate settings needed to communicate with your register. There may be times when you will need to amend these settings for a specific register.

To access the Communication menu, press the “Up” or “Down” button to move the cursor to “COMMUNICATION” and press “Set”. The following menu will appear:



Figure 62: COMMUNICATION Sub-Menu

The “Register Settings” selects and allows you to program the communication and protocol parameters used to communicate with the POS or Cash Register using the DB9 connector. The “Network Settings” selects and allows you to program the communication and protocol parameters used to network the VSI-Pro Max to other units using the RJ45 connector.

To access the Communication menu, press the “Up” or “Down” button to move the cursor to “COMMUNICATION” and press “Set”. The following menu will appear:

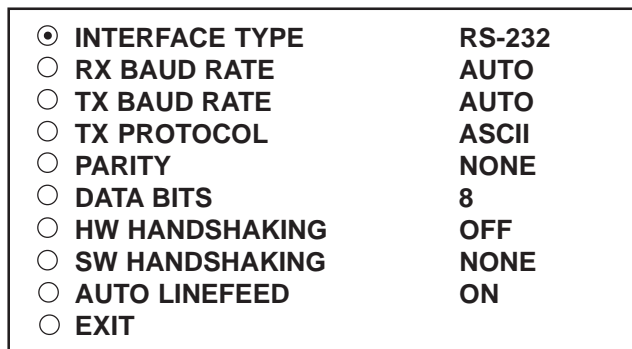

Figure 63: Register Settings Sub-Menu

### INTERFACE TYPE

Choices: RS-232, PASSIVE TAP, RS-485

To set the interface type for your particular device, press the “Up” or “Down” button to move the cursor to “INTERFACE TYPE” and press and release “Set”. The cursor will start flashing. You can now use the “Up” or “Down” button to make your selection. When your selection appears, press “Set” again. The cursor will stop flashing and you can proceed to the next menu item for programming. RS-232 and RS-485 are defined by IEEE standards, however, the Passive Tap is a high impedance (100K) input with full diode protection. Refer to Table 1 and 1A for respective pin-outs of RS-232 or RS-485.

### RX BAUD RATE

Choices: AUTO, 1200, 2400, 4800, 9600, 14.4K, 19.2K, 28.8K, 38.4K, 57.6K, 115.2K

To set the baud rate for your particular device, press the “Up” or “Down” button to move the cursor to “RX Baud Rate” and press “Set”. The cursor will start flashing. You can now use the “Up” or “Down” button to make your selection. When your selection appears, press “Set” again. The cursor will stop flashing and you can proceed to the next menu item for programming.



## TX BAUD RATE

*Choices: AUTO, 1200, 2400, 4800, 9600, 14.4K, 19.2K, 28.8K, 38.4K, 57.6K, 115.2K*

This feature allows you to set the transmit baud rate to a separate device if you are looping the data back out of the VSI-Pro.

To set the TX Baud Rate for your particular device, press the "Up" or "Down" button to move the cursor to "TX BAUD RATE" and press "Set". The cursor will start flashing. You can now use the "Up" or "Down" buttons to make your selection. When your selection appears, press "Set". The cursor will stop flashing and you can proceed to the next menu item for programming.

## TX PROTOCOL

This selection allows you program the protocol or format of the data that is transmitted out the TX port. This is only available for registers that do not use the TX line of the POS/Cash Register port for emulate modes. When using the register port for tapping then the data output in ASCII mode simulates the function of the VSI-Pro previous versions and utilizes the same pinout connection. When using the VSI-Pro Max in the Master mode this TX line is used to output the data in the VSI-ADD protocol to be compatible with the Hydra output to DVRs.

*Choices: ASCII, VSI-ADD, VNet, Dallmeier, MVDR*

**NOTE:** The choices in the above selection will change depending on the programming selections in the Network Settings submenu. In the "Master" mode the data can be sent out the VSI-ADD format which is the standard AVE protocol for register data which is supported by all AVE DVRs and many 3rd party DVR manufactures. The VNET format is only support by the AVE Vnetworker PC Software. The MVDR format is a subset of the VNET format that is supported by the AVE MVDR line of DVRs. The Dallmeier setting supports communication to the Dallmeier DVR in Commanding mode. ASCII is not supported in the Master mode selection.

## PARITY

*Choices: NONE, ODD, EVEN*

Press the "Up" or "Down" button to move the cursor to "PARITY" and press "Set". The cursor will start flashing. Press the "Up" or "Down" button to cycle through the values and press "Set" when the desired value is displayed.

## DATA BITS

*Choices: 7 or 8*

If you select 7 Data Bits, you must select "ODD" or "EVEN" Parity in the Parity menu. Press the "Up" or "Down" button to move the cursor to "DATA BITS" and press "Set". The cursor will start flashing. Press the "Up" or "Down" button to cycle through the values and press "Set" when the desired value is displayed.

## HW HANDSHAKING

*Choices: ON, OFF*

Hardware handshaking is an electrical signal that tells the cash register or computer that the VSI-Pro Max is ready to receive data. It may not be necessary and/or need not be connected to an outgoing signal from the cash register or computer since the VSI-Pro Max does not require handshaking. The VSI-Pro Max handshaking signal is always true signally the cash register or computer to send data.

Handshaking guarantees that the internal buffer is not over run or text is not lost. Most AVE interfaces do not support this function. Also since the VSI-Pro has a 128K buffer this feature is generally not required.



# PROGRAMMING

---

## SW HANDSHAKING

Choices: NONE, XON/XOFF, ACK/NAK

Software handshaking is a command that is embedded in the data stream that is read and/or sent by the VSI-Pro Max that controls the flow of data to or from an external device.

## AUTO LINEFEED

Choices: ON, OFF

Auto Linefeed makes the VSI-Pro append a CR/ LF after each displayed line. The default of this function is "ON", but if you would like to disable it then press the "Up" or "Down" button to move the cursor to "AUTO LINEFEED" and press "Set". The cursor will start flashing. Press the "Up" or "Down" button to cycle through the values and press "Set" when the desired value is displayed.

## NETWORK SETTINGS

Press the "Up" or "Down" button to move the cursor to "NETWORK SETTINGS" and press "Set". The cursor will start flashing. Press the "Up" or "Down" button to cycle through the values and press "Set" when the desired value is displayed.

<input checked="" type="radio"/> TYPE	OFF
<input type="radio"/> ADDRESS	OFF
<input type="radio"/> PROTOCOL	REGCOM 9.6K
<input type="radio"/> BAUD RATE	9600
<input type="radio"/> EXIT	

Figure 64: Network Settings Sub-Menu

Press the "Up" or "Down" button to move the cursor to "TYPE" and press "Set". The cursor will start flashing. Press the "Up" or "Down" button to cycle through the values and press "Set" when the desired value is displayed.

## TYPE

Choices: GENERIC, MASTER, SLAVE, OFF

### GENERIC

This is the default setting of the VSI-Pro Max. Also the default Jumper setting of the VSI-Pro Max connects the Network Serial RS-232 to the DB9 Pin 8 and outputs the Exception Data from this port which can be connected to a DVR or Serial Printer. Also the Network RJ45 port outputs the same data via RS-485.

For normal exception data output to be backward compatible with all VSIs set Protocol for ASCII.

### MASTER

This setting configures the Network RJ45 port to be a Master which is formerly called Hydra. The Master uses RS-485 bi-directional communication to slave devices using either the Regcom or Vnet protocol.

The "OUTPUT" RS-232 data with the selected format is sent out the DB9 TXD Pin 3 for RS-232. In the RS-232 mode you can still use the VSI-Pro Max to interface to a POS or Cash Register but only in the tap mode using the DB9 RXD Pin 2 only to receive the data. Emulation modes require the use of both the RXD and TXD so this mode is prohibited while using the VSI-Pro Max in the Master mode.

The "OUTPUT" serial data with the selected format is sent out the DB9 Pins 4 & 6 for RS-485 and the baud rate, etc, is set via the communications setting not in this menu. In this mode the VSI-Pro Max can not connect to any POS or Cash Register.





*Related Settings*

“PROTOCOL” which the choices are REGCOM or VNET

“TX PROTOCOL” which the choices will be MVDR, DALLMEIER, VSI-ADD, VNET

“BAUD RATE” 1200- 115.2K

**SLAVE**

This setting configures the Network RJ45 port to be a Slave which is formerly called Regcom or Vnetworker. The Slave uses RS-485 bi-directional communication to the Master unit.

*Related Settings*

“ADDRESS” choices are 1-16

“PROTOCOL” which the choices are REGCOM or VNET

“BAUD RATE” 1200 - 115.2K

OFF No data is sent out the Network Port either via RS-232 or RS-485.

**ADDRESS**

*Choices: OFF, 1-16*

This select the address or camera number when configured as a slave device. The selections are 1-16 so that the POS/Cash Register is assigned a unique number up to a maximum of 16 to send the data over the RS-485 network back to a Master unit or a Hydra device which then sends all the data to the DVR or PC for recording.

**PROTOCOL**

*Choices: REGCOM or VNET*

This setting selects the protocol of the RS-485 Network. There are two protocols to be compatible with two different devices and functions. The REGCOM can be selected for compatibility with the Regcom networking device. The Regcom device can be set for either 9600 or 57600 baud rate to match the installed device settings. However when not using the Regcom device and using only VSI-Pro Max then any baud rate can be set. The Regcom Protocol only has the ability to receive register data only.

The VNET can be configured for compatibility with the Vnetworker or Networker devices. A baud rate of 19200 can be only used for these external devices. However when used with a VSI-Pro Max device and no external Vnetworker or Networker devices are used then any baud rate can be used. The Vnetworker protocol has the ability to receive register data, Program remote VSI-Pro Max devices, receive remote alarming and Time/Date information.

**BAUD RATE**

*Choices: 1200 - 115200 baud rate*

This sets the communication speed for the Network port in all configurations. Care must be given to selecting the proper baud rate for the Type of operation you wish and configuration you set for the VSI-Pro Max.

**EXIT**

Press the “Up” or “Down” button to move the cursor to “EXIT” and press “Set” to return to the previous menu.

**5.7 EXCEPTION REPORTS****EXCEPTION REPORT OVERVIEW**

The Exception Report gives you the option to assign an on-screen flag, trigger an alarming device, or send data to another serial device on any questionable transaction that you have preprogrammed into the VSI-Pro Max.



## PROGRAMMING

---

The VSI-Pro Max will allow programming of up to 24 separate exceptions. These exceptions can be VOIDS, REFUNDS, COUPONS, PAID OUT, RETURNS, individual departments, specific items, or any transaction that you determine (by programming) to be "exceptional" or questionable. You may even set ranges for the exceptions. For example, all transactions over \$100, between \$8.00 and \$25.00, or lower than \$10 and greater than \$25.00, all transactions by a specific cashier, or whatever transactions you need to watch exceptionally close.

The following is a brief overview of how to set up Exception Reports.

1. On the main-menu, press the "Up" or "Down" button to move the cursor to "EXCEPTION REPORT" and press "Set".
2. On the sub-menu, press the "Up" or "Down" button to move the cursor to "EXCEPTION HISTORY" and press "Set".
3. On the sub-menu, press the "Up" or "Down" button to move the cursor to "DVR SELECTION" and press "Set". Then select the model of DVR you are using.
4. Exit and press the "Up" or "Down" button to move the cursor to "SET EXCEPTION" and press "Set".
5. To select the Exception No. that you wish to program, press the "Up" or "Down" button to move the cursor to the desired Exception No. then press "Set". Press the "Up" or "Down" button to toggle between the choices.
6. Make sure that DISPLAY is set to "ON" for any exception data to be saved in the Exception History.
7. Program the Exception String in the Exception Report to compare the data that shows on the screen for time search mode in the Exception History menu.
8. After you have set up the desired configurations, press the REC button on the DVR to record video into a hard drive or use alarm output for triggering the DVR at record input.
9. The monitor should display a flashing REC message and the REC button will light up indicating the DVR is in the recording mode.

### ON-SCREEN FLAGS

You have several options for programming your Exception Report. The first option typically has all programmed exceptions display a flashing asterisk in the upper right corner of the on-screen display, or reversing the entire text display. This on-screen flag is controlled through the ALARM OUTPUTS menu. You assign a corresponding alarm to an exception and set the parameters for the flag in this menu. You do this by choosing "DISPLAY" for the corresponding exception number and selecting "ON". With this option, all questionable transactions (exceptions) will be "flagged" with the flashing asterisk.

You can then review these exceptions by putting your DVR or VCR in play and pressing the FF button. This will give you a fast scan of the tape and you can go into normal play when you see the flashing asterisk and view that transaction in real time or slow play or frame by frame, depending on the type of playback options of your particular DVR or VCR.

### HARD ALARM OUTPUT

The VSI-Pro allows you to program exceptions to trigger external alarming devices such as DVRs, Time-lapse VCR's, quads, enunciators, LED's etc. Using the ALARM OUTPUT you can have your DVR record only exceptions, or have an alarming quad go to full screen on an exception, or even trigger a buzzer to alert you that an exception has occurred.

### PRINTER or DVR OUTPUT

There may be situations where you want to send all the data to store on a DVR or do not want cashiers or other employees to know what triggers an exception. In this case, the VSI-Pro Max provides a separate serial output that will send data to a remotely located DVR or serial printer. If you turn the on-screen display off and the output on and you have a remote serial printer hooked up to the VSI-Pro Max, then, whenever an exception is reported, it is sent out to the serial printer only. The printer will give you a hard copy printout of the questionable transaction with the time and date. With this hard copy printout of the exception report, you can then review the tape by going directly to that exception's time.

The serial output of the VSI-Pro Max can be programmed to send out the entire transaction. The output can be connected to the other equipment such as DVRs, computers, phone line transmissions or digital storage devices for later retrieval.



The VSI-Pro also has a “triggered text” feature. This feature allows programmed text or control characters to be sent out when an exception occurs to trigger devices like DVR’s to save the data file for future review. Other computer devices can wait for this specified text string and do other functions at this time via the serial communication process. From the main programming VSI-Pro Max menu, press the “Up” or “Down” button to move the cursor to “EXCEPTION REPORT” and press and release “Set”. The following menu will appear:

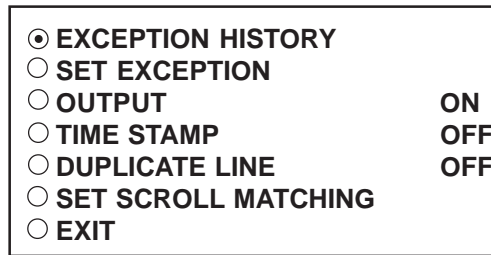

**Figure 65: EXCEPTION REPORT Sub-Menu**

**EXCEPTION HISTORY**

Press the “Up” or “Down” button to move the cursor to “ EXCEPTION HISTORY ” and press “Set”. The following menu will appear:

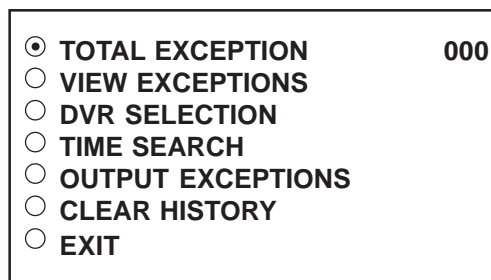

**Figure 66: EXEPTION HISTORY Sub-Menu**

**TOTAL EXCEPTIONS**

This is not a selection for just displays the total exception count kept in the Exception History Buffer maximum 800.

**VIEW EXCEPTIONS**

This displays the buffered exceptions on-screen, starting with the oldest exception in the buffer. Press the “Up” or “Down” button to move the cursor to “VIEW EXCEPTIONS” and press “Set”. Once in the exception displaying screen, press the “Up” or “Down” button to scroll to the next screen. Press “Set” to exit and return to the previous menu. Remember, you must turn the DISPLAY “ON” for exceptions to be saved in history.

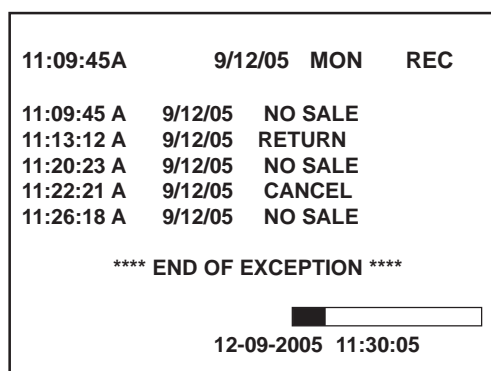

**Figure 67: Display of View Exceptions**

**NOTE** For any exception you must program Display “ON” for any exception data to be saved in the Exception History.



# PROGRAMMING

---

## DVR SELECTION

Press the “Up” or “Down” button to move the cursor to “DVR SELECTION” and press “Set”. The following menu will appear:

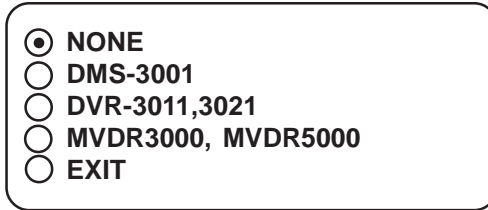

Figure 68: DVR Selection Sub-Menu

## DVR-3011 / DVR-3021 / MVDR3000 / MVDR5000

Press the “Up” or “Down” button to move the cursor to “DVR-3011,3021” and press “Set”. An asterisk appears to indicate your selection.



Figure 69: DVR-3011,3021,MVDR3000,MVDR5000 Sub-Menu

## DEST ID and SRC ID

Choices: 1 through 32 **Note:**The DEST ID and SRC ID can not be the same value or can not send any command.

## TIME SEARCH

Press the “Up” or “Down” button to move the cursor to “TIME SEARCH” and press “Set”. The following sub-menu will appear:

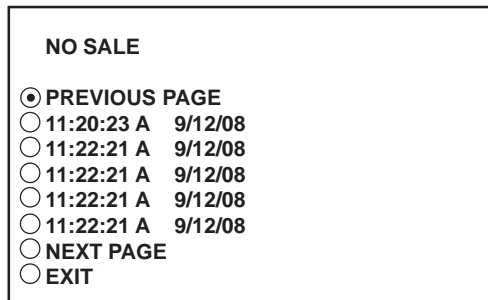

Figure 70: Display of TIME SEARCH

Use the “Up” or “Down” button to scroll to the desired exception in the transaction history. As you select the line the exception string will display at the top of the page.

Then press “Set” and the DVR will be commanded by the VSI-Pro Max to go to the selected transaction via its Time/Date Search function. Therefore you must make sure the T/D of the DVR is very close to the setting of the VSI-Pro Max or there will be an error in the actual search time. Verify the proper connection to the DVR from the diagram on the following page.

## EXAMPLE

Define “NO SALE” as an exception string In Exception No. 2 , DISPLAY to be “ON”, and define OPERATOR “IN”. If the screen is displayed “NOSELL”, the VSI-Pro will keep this displayed line on Exception History.



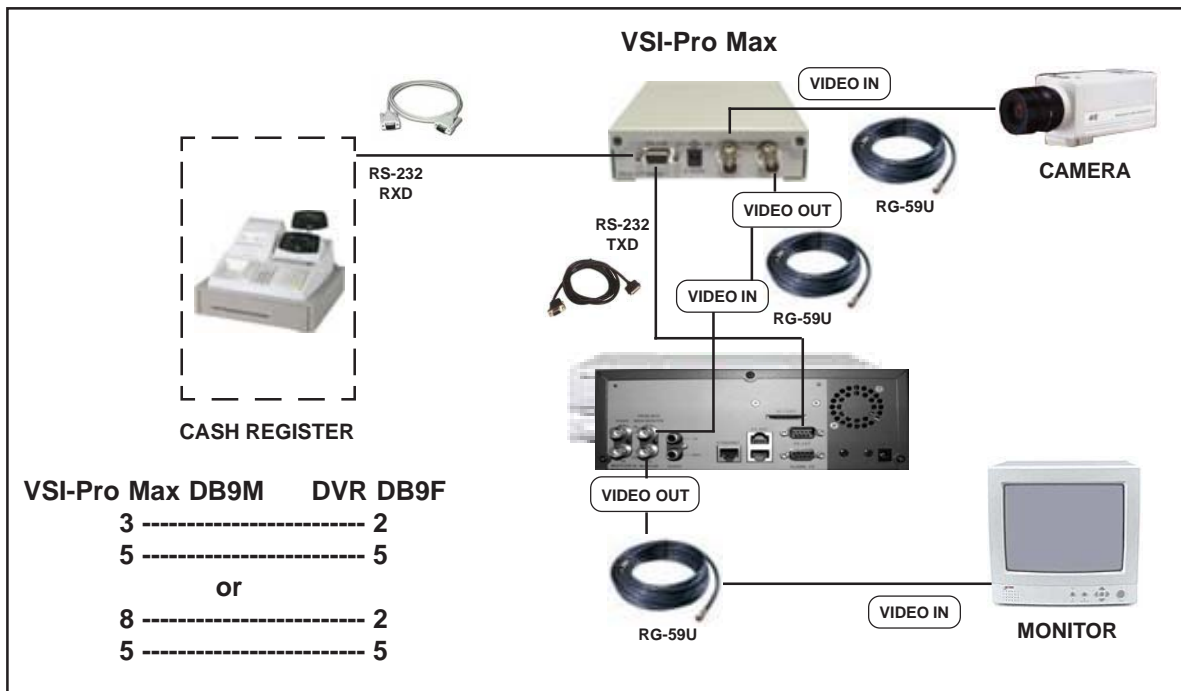

Figure 71: VSI-Pro Max with DVR Control Connections

**NOTE:**

The VSI-Pro Max can control the DVR RS-232 port from either Pin 3 or Pin 8 depending on the configuration. Default setting is both. In the Cash Register “Tapping Mode” the VSI-Pro Max uses Pin 3 to send out auxillary ASCII data and DVR control signals. Therefore in this mode you can operate the VSI-Pro Max in the “Slave Mode” and connect to control the DVR via Pin 3. You can not use the VSI-Pro Max in the “Master Mode”. If you select “Master Mode” this will have priority and when you select DVR Time/Data Search you will generate an error message.

In the Cash Register “Emulate Mode” the VSI-Pro Max uses Pin 3 to connect to the cash register supplying the proper emulate handshaking signals. Therefore Pin 8 must be connected to the DVR to command the Exception Search mode. Therefore you can not use the VSI-Pro Max in “Slave Mode” and utilize the DVR control feature while connecting in “Emulate Mode”. If you choose the “Slave Mode” this will have priority over the DVR control mode and will generate an Error Message when DVR Time/Date is selected. The same will be true if “Master Mode” is selected.

**OUTPUT EXCEPTIONS**

This selection allows you to have the buffered exceptions sent out for printing. This is a global setting for all exceptions, but you also need to turn on the output for each independent exception.

**CLEAR HISTORY**

This selection clears all the buffered exceptions and resets the TOTAL EXCEPTIONS counter.

**EXIT**

Press the “Up” or “Down” button to move the cursor to “EXIT” and press “Set” to return to the previous menu.

**SET EXCEPTION**

Press the “Up” or “Down” button to move the cursor to “SET EXCEPTION” and press “Set”. The following sub-menu will appear:

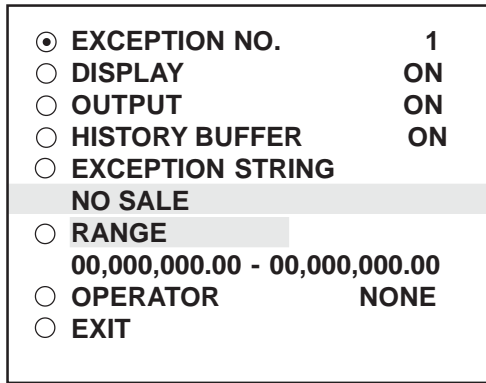

Figure 72: SET EXCEPTION Sub-Menu

**EXCEPTION NO.**

Choices: 1 through 24

To select the Exception No. that you wish to program, press the “Up” or “Down” button to move the cursor to “EXCEPTION NO.” and press “Set”. The cursor will start flashing. Use the “Up” & “Down” button to sequence through the choices. Make your selection and press “Set”. The cursor will stop flashing and you may continue to the next menu item.

**DISPLAY**

Choices: ON, OFF

The DISPLAY item lets you control whether or not this particular exception is displayed on the video monitor. Please understand that if you are not using a remote serial printer and if you do not turn on the Exceptions display here, you will not have the on-screen flag and consequently no record of the exception when it occurs.

To make your selection, press the “Up” or “Down” button to move the cursor to “DISPLAY” and press “Set”. The cursor will start flashing. Press the “Up” or “Down” button to toggle between “ON” or “OFF”. Make your selection and press “Set”. The cursor will stop flashing and you may continue to the next menu item.

 **APPLICATION NOTE**

*If the display of the Exception is turned off here, the exception data will actually be erased from the screen. This feature can be used to generate what we refer to as “Negative Exceptions”, allowing the removal of unwanted text from the screen. See “Negative Exceptions” that follows.*

**OUTPUT**

Choices: ON, OFF

The OUTPUT controls the RS-232 data from the VSI-Pro. Typically this is sent to a remote Serial Printer to provide a hard copy of Exceptions with time and date on it. This data can also be sent out to a computer with appropriate software and give you the ability to analyze data. You could also use an auto answer modem and have the data sent to a central office or even to your home. The serial devices must have the same Baud Rate, Parity, and Data Bits as the VSI-Pro for optimum performance of data transfer.

To make your selection, press the “Up” or “Down” button to move the cursor to “OUTPUT” and press “Set”. Press the “Up” or “Down” button to toggle between “ON” or “OFF”. Make your selection and press “Set”. The cursor will stop flashing and you may continue to the next menu item.

## HISTORY BUFFER ON/OFF

The history buffer stores all the exceptions that occur in the VSI-Pro. Sometimes this can be very large and consume a large portion of the memory of the VSI-Pro. This can be used to automatically search a compatible DVR, upload to a PC to save or print out and view on screen on the VSI-Pro. This setting allows the user to enable or disable this feature as to conserve memory allocation for other features.



### PROGRAMMING NOTE

*The following sections defines the Exceptions Strings, the Operator and the Range. The Exception String is programmed first, then Range is defined and finally the Operator is selected. The VSI-Pro looks at the Exceptions String first, and if there is data that matches, it then checks to see if a Range has been defined.*

## EXCEPTION STRING

The VSI-Pro compares the data that is printed to video to the data entered in the Exception String. The Exception String can also be used without a defined range. Example of this would be to assign a word "VOID" as an exception. VSI-Pro will look for that string so range definition is not necessary. However, exception string "VOID" could be further defined by assigning a Range, i.e. all "VOID" over \$20.

You can also define a global exception to flag all negative transactions. An example of this using the Samsung ER-4715 would be the following exception to flag any transaction that contains a "-", or negative sign. For example, in the Samaung ER-4715 register an assigned Exception string "..-" will flag all Void, Refund, Merchandise Return and Paid out to the monitor.

You can also use wild card symbol ".", a centered dot on any data location. An example of this would be instead of assigning eight different exception strings for dept 00 to dept 07, you can assign only one exception string e.g. "dept .". That wild card exception string will handle exceptions for all eight departments.

To program the exception string, press the "Up" or "Down" button to move the cursor to "EXCEPTION STRING" and press "Set". The first 40 character exception will become active after flashing. Program in your exception string.

### NOTE

*Remember to enter your Exception String based on the way that data prints to video, including spaces. Also remember pressing "Set" advances to the next position. Pressing "Down" and "Up" at the same time enters the string into memory and returns to the menu for further programming.*



### TIP

*If you make a mistake and need to erase a character, pressing "Up" and "Set" at the same time will change the character back to a blank space.*

## PROGRAMMING

---

### NEGATIVE EXCEPTION

You can remove unwanted text from the screen using the VSI-Pro. The VSI-Pro displays data in the text block 11 lines by 40 characters wide for total of 440 characters. To remove unwanted messages from the register data you first determine how the unwanted messages prints to the video. For example, a typical message which scrolls on the customer display or appears on the video monitor.

The removing of the above string is referred to as the Negative Exception. Follow the following steps to program the negative exception. Turn the display off for that exception. In the Exception String enter the words "WELCOME TO XYZ SUPER" exactly as they appear on the screen, including spaces.

#### **NOTE**

**Only 40 characters are allowed in each Exception String, including blank spaces.**

### RANGE

*Choices: 00,000,000.00-99,999,999.99*

The Range defines the limits of the Operator. These are numeric only. As you can see from the previous examples, the range has two separate fields that are separated by a double-sided arrow. This format must be followed.

To program the range, press the "Up" or "Down" button to move the cursor to "RANGE" and press "Set". The first "0" in the range starts to flash. This means it is active and ready for programming. Press the "Up" or "Down" button to cycle through the values and press "Set" when the desired value is displayed. This will advance the active block to the next character. While you are on an active block, pressing the "Up" and "Set" buttons simultaneously will return that block back to a blank, which is designated by a solid white box. You can follow this format to program your range. When you have finished and want to set this range into the VSI-Pro memory, simultaneously press and release the "Up" and "Down" buttons.

When you are ready to exit and continue on, simultaneously press and release the "Up" and "Down" buttons. This will set the range in the VSI-Pro memory and exit you back to the previous menu.

### OPERATOR

*Choices: NONE, IN, OUT*

The Operator determines the behavior of the Range. Think of the Operator in mathematical terms. Setting the correct range and specifying "IN" or "OUT" will make the Operator perform "greater than", "less than", "equal to", "in the range", or "out of the range" calculations.

With this version of the VSI-Pro, you can define ranges for your exceptions and have the VSI-Pro alarm when an exception falls within the range's parameters or outside the range of the two numbers. The choices are "IN", "OUT", and "NONE". To program the operator, press the "Up" or "Down" button to move the cursor to "OPERATOR" and press "Set". The cursor will start flashing. Press the "Up" or "Down" button to cycle through the values and press "Set" when the desired value is displayed.



**EXAMPLES FOR SETTING EXCEPTION****EQUAL**

Suppose Exception #2 would be flag all \$10 sales on Register Department 1. This would be the settings for this Exception: (For these examples, we are using the Samsung ER-4715 Electronic Cash Register)

Exception	No. 2
Display	ON
Output	ON,OFF (depending on presence of serial printer)
Exception String1 . . .	
Range	0010.00-0010.00
Operator	IN

**OUT RANGE**

Suppose Exception #3 would "FLAG" every transaction on Department 2 that is under 10 cents and over \$100 dollars. This would be the settings for this Exception:

Exception	No. 3
Display	ON
Output	ON, OFF (Depending on presence of serial printer).
Exception String2 . . .	
Range	0000.10 -0099.99
Operator	OUT

**IN RANGE**

Suppose Exception # 5 would flag all transactions between \$50.00 & \$100.00 on Department 3:

Exception No.	3
Display	ON
Output	ON or OFF (Depending on presence of serial printer).
Exception String3 ...	
Range	0049.99-0099.99
Operator	IN

*With this exception all sales between \$50 and \$100 dollars will be flagged.*

**IN RANGE**

Suppose Exception # 5 would flag all transactions between \$50.00 & \$100.00 on Department 3:

Exception No.	3
Display	ON
Output	ON or OFF (Depending on presence of serial printer).
Exception String	3 ...
Range	0049.99-0099.99
Operator	IN

*With this exception all sales between \$50 and \$100 dollars will be flagged.*

## PROGRAMMING

---

### GREATER THAN

This example will show you how to program an exception to flag all sales in department 5 greater than \$100 dollars

Exception	No. 2
Display	ON
Output	ON or OFF
Exception String	5...
Range	0000.01- 0099.99
Operator	OUT

*Now whenever anyone rings a sale of \$100 or more on Department 5, the transaction will be flagged.*

### LESS THAN

This example will show you how to program an exception to flag all sales in Department 6 of less than \$100. 00:

Exception	No. 4
Display	ON
Output	ON or OFF
Exception String	6
Range	0000.01-0099.00
Operator	IN

### OUTPUT

*Choices: ON, OFF*

This is global output to send data to the serial printer. When "ON" is selected all the data will be send to the serial printer regardless of what setting of out put has selected in the individual output in set exception menu. When "OFF" is selected only those exception will send to the serial printer whose out put is "ON" under set exceptions menu for individual exceptions. To turn output "ON" or "OFF", press the "Up" or "Down" button to move the cursor to "OUTPUT" and press "Set". Press the "Up" or "Down" button to cycle through the values and press "Set" when the desired value is displayed.

### TIME STAMP

*Choices: ON, OFF*

If TIME STAMP is selected "ON" then printer will print the exception with time stamp flag, otherwise just print the Exception. To turn TIME STAMP "ON" or "OFF", press the "Up" or "Down" button to move the cursor to "TIME STAMP" and press "Set". Press the "Up" or "Down" button to cycle through the values and press "Set" when the desired value is displayed.

### DUPLICATE LINE

*Choices: ON, OFF*

If this selection is turned on then any transaction line that is the exact duplicate of the previous one is not displayed or processed by the exception processor and is basically ignored. Be careful in selecting this function because many POS/ Cash Register have a "Repeat" key to ring up multiple items. In this case true transactions will be deleted and not shown. This function is useful when used with Customer Displays that continuously refresh the display with identical data and not related to new transactions and causes unnecessary data to be sent to the interface.

### SCROLL MATCHING

Scroll Matching is a feature to better remove those advertising scrolling messages on the customer display of cash registers so they do not clutter up the video recording.





Figure 72A: Scroll Matching Sub Menu

Exception Strings (with Scroll Matching OFF) are compared to any text in a line or any text after a CR LF up to 40 characters. If the line is longer than 40 characters we insert a virtual LF CR. Therefore an exception string can not be longer than 40 characters. If you use a wild card in front of or behind of a normal exception string then no matter what letter is recieved in that position of the wild card it will be accepted as part of exception string.

Typically to erase these scrolling messages we would use the Negative Exception feature and turn "Off" the display after we entered in the words with or without wildcards. However this left many unwanted bits and pieces of the scrolling message visible because the transactions interrupt the scrolling message and then when the transaction is completed the scrolling message goes back to the exact place in the message where it was interrupted. This is different than normal transactions for they always start with a the description, quantity and price usually in one line.

In scrolling messages we may not have LF and sometimes no CR. This has the first character of every line usually different in the scrolling message and even partial words starting at any place within any one of the words of the scrolling message. Therefore conventional Exceptions even with the wild card does not remove all.

Scroll Matching "On" changes the way the VSI-Pro Max processes exceptions. Scroll matching only works with advertising messages that are scrolling in the video by typically shifting accross a customer display. Messages that are displayed in full, then erased in full will have not be erased by scroll matching and conventional Negative Exception processing will have to be used for this message or messages. Therefore if the message is scrolling then the VSI-Pro Max will erase the entire message if the scrolling continues within the Time Out setting. The default Time Out is 1 second but is programmable if the display scrolls slower than normal. When the Time Out exceeds the programmed time the internal memory buffer of the scrolling message is erased and the process is repeated. This allows for new or different messages to be fully erased by the scroll matching feature.

**EXIT**

Press the "Up" or "Down" button to move the cursor to "Set" to return to the previous menu.

**5.8 ALARM OUTPUTS**

To access alarm output, press the "Up" or "Down" button to move the cursor to "ALARM OUTPUTS" and press "Set". The following sub-menu will appear:

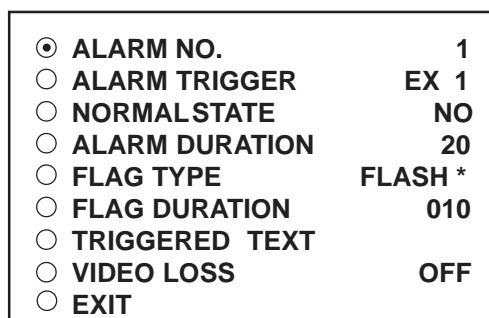

Figure 78: ALARM OUTPUTS Sub-Menu

**NOTE: The ALARM OUTPUTS menu controls not only the formatting of the external alarms but also the formatting of the on-screen flags assigned to individual exceptions.**

## PROGRAMMING

---

### ALARM NO.

Choices: 1, 2, 3, 4, 5, 6, 7, 8, 9, 10, 11, 12, 13, 14, 15, 16

The VSI-Pro Max allows you up to 16 alarms that may be used with any of the user programmed exceptions. However there are only 2 hardwired alarm outputs and these correspond to Alarm 1 & 2 only. The other 14 alarms can be used to send trigger text, serial data out or flash the screen. To select the Alarm Number that you want to program, press the "Up" or "Down" button to move the cursor to "ALARM NO." and press "Set". The cursor will start flashing. Press the "Up" or "Down" button to cycle through the values and press "Set" when the desired value is displayed.

### ALARM TRIGGER

Choices: 1, 2, 3, 4, 5, 6, 7, 8, 9, 10, 11, 12, 13, 14, 15, 16, 17, 18, 19, 20, 21, 22, 23,24 , 1-12, 13-24, 1-24, RTS

An Alarm Trigger is the source of activity programmed to activate a certain alarm. The alarm trigger tells the VSI-Pro Max what exception to use to trigger the alarming device or the on-screen flag.

Choices: Exceptions 1, 2, 3, 4, 5, 6, 7, 8, 9, 10, 11, 12, 13, 14, 15, 16, 17, 18, 19, 20, 21, 22, 23, and 24 (alarms when data is received that matches what you have set in these exception strings).

**Exceptions 1-12:** alarms when data is received that matches any data set in Exception 1-12.

**Exceptions 13-24:** alarms when data is received that matches any data set in Exception 13-24.

**Exceptions 1-24:** alarms when data is received that matches any data set in Exception.

### RTS

External alarm input. The VSI-Pro Max has 1 alarm input, if you are not using the handshaking function. A contact closure to ground on pin 7 will trigger this alarm. Coupled with the RTS Triggered text, you can now display a 40 character message from an external alarm input.

 **RTS APPLICATION NOTE**

**The RTS alarm input can be connected to the drawer of a cash register or safe to alarm and send the message "DRAWER OPEN" to the screen if the drawer is open too long.**

To select the alarm trigger that you want to program, press the "Up" or "Down" button to move the cursor to "ALARM TRIGGER" and press "Set". The cursor will start flashing. Press the "Up" or "Down" button to cycle through the values and press "Set" when the desired value is displayed.

### NORMAL STATE

Choices: NO (Normally open), NC (Normal closed)

There are two choices: NO (normally open) or NC (normal closed). These selections determine whether the alarm outputs will act as a normally open switch or a normally closed switch.

To select the Normal State that you want to program, press the "Up" or "Down" button to move the cursor to "NORMAL STATE" and press "Set". The cursor will start flashing . Press the "Up" or "Down" button to cycle through the values and press "Set" when the desired value is displayed.

**ALARM DURATION**

This is the amount of time in seconds that the alarm will remain activated once it is triggered. The selections for alarm duration are: PULSE, 6, 12, 20, 30, 60, 120, 180, and 300 seconds. (PULSE sends a 200mS alarm pulse to the alarm device.)

To select the amount of time in seconds that you want to program the alarm duration, press the “Up” or “Down” button to move the cursor to “ALARM DURATION” and press “Set”. The cursor will start flashing. Press the “Up” or “Down” button to cycle through the values and press “Set” when the desired value is displayed.

**FLAG TYPE**

This feature allows you to insert a visual alarm flag on each exception that you program to aid in the review of the video tape. This flag can appear as an asterisk “\*”, a flashing asterisk, reverse text, or flashing reverse text.

To make your selection, press the “Up” or “Down” button to move the cursor to “FLAG TYPE” and press “Set”. The cursor will start flashing. Press the “Up” or “Down” button to cycle through the values and press “Set” when the desired value is displayed.

**FLAG DURATION**

*Choices: 6, 12, 30, 60, 120, 180,..., 300*

This is the amount of time in seconds that the on-screen FLAG, either the Asterisk or the Reverse mode, will remain activated once it is triggered.

**NOTE** 

*Flag Duration is independent of the Alarm Duration. Flag Duration is the amount of time the on-screen flag will remain on after activation, while, Alarm Duration is the amount of time that the hard-wired Alarm Output remains activated after it is triggered.*

To select the amount of time in seconds that you want to program for the flag duration, press the “Up” or “Down” button to move the cursor to “FLAG DURATION” and press “Set”. The cursor will start flashing. Press the “Up” or “Down” button to cycle through the values and press “Set” when the desired value is displayed.

**TRIGGERED TEXT**

A Triggered Text is a data string that associates with one of the 16 alarms or with external RTS alarm. When the alarm is triggered by a source, the associated string is sent out and/or displayed, if enabled respectively. Each Triggered Text can contain up to 40 printable ASCII data. If non-printable data (control code) is included, each control code occupies 3 printable spaces. Therefore, only 13 control codes maximum can be programmed in one Triggered Text. To program the TRIGGERED TEXT, go to the ALARM OUTPUTS sub-menu. Select desired ALARM NO or RTS for external alarm. Then go to the TRIGGERED TEXT sub-menu.

<input checked="" type="radio"/> DISPLAY TEXT	OFF
<input type="radio"/> OUTPUT TEXT	OFF
<input type="radio"/> RTS TRIGGERED DELAY	30S
<input type="radio"/> SET TRIGGERED	TEXT
<input type="radio"/> EXIT	

**Figure 74: TRIGGERED TEXT Sub-Menu**

## PROGRAMMING

---

### DISPLAY TEXT

Choices: ON, OFF

Press the “Up” or “Down” button to move the cursor to “DISPLAY TEXT” and press “Set”. The cursor will start flashing. Press the “Up” or “Down” button to cycle through the values and press “Set” when the desired value is displayed. Selecting “OFF” will not display any exception text on the video output.

### OUTPUT TEXT

Choices: ON, OFF

Press the “Up” or “Down” button to move the cursor to “OUTPUT TEXT” and press “Set”. The cursor will start flashing. Press the “Up” or “Down” button to cycle through the values and press “Set” when the desired value is displayed. Selecting “OFF” will not send any exception text to the serial printer.

### RTS TRIGGERED DELAY

Choices: OFF, 1S, 5S, 10S, 20S, 30S, 1M, 5M, 10M

Press the “Up” or “Down” button to move the cursor to “RTS TRIGGERED DELAY” and press “Set”. The cursor will start flashing. Press the “Up” or “Down” button to cycle through the values and press “Set” when the desired value is displayed. Selecting “OFF” will give no delay and will trigger the alarm immediately upon RTS closure..

This function introduces a time delay for the RTS Trigger Input before initiating an alarm condition. The alarm must be continuous for the entire time of the delay setting or the time out will be reset. This is useful to connector to cash drawers or safe doors and wait a programmable amount of time before sounding the alarm. Leaving cash drawers or safe doors open are indicative of theft or simple forgetfulness and an alarm condition will deter this behavior.

### SET TRIGGERED TEXT

Press the “Up” or “Down” button to move the cursor to “SET TRIGGERED TEXT” and press “Set”. The following sub-menu will appear:



Figure 75: Set Triggered Text Main-Menu

You can enter 2 lines with 40 alpha numeric text on each line. You can also enter non-printable data (control code) instead of triggered text. Each control code occupies 3 characters, therefore you can enter 13 control codes in a line. To enter control code, first print up arrow ^ followed by 2 hex digit. For example, hex code 01 has to be entered like ^01. Press “Up” and “Down” simultaneously to exit.

### VIDEO LOSS

Choices: Manual, 1s, 2s, 3s, 4s, 5s, 10s, 20s, 30s, 1M

Video Loss allows the VSI-Pro Max to generate an alarm condition when low or lost video occurs. When set for manual the alarm follows the state of the video loss, when set for 1s-1M this means the video must be lost continuously for that period of time before an alarm is triggered. The alarm mode is a timed mode so once the video loss alarm is triggered the alarm time out must expire and get another video loss to retrigger the alarm.

### EXIT

Press the “Up” or “Down” button to move the cursor to “EXIT” and press “Set” to return to the previous menu.

---



## 5.9 TEST/DEMO MODE

The TEST/DEMO MODE provides you with several ways to test the VSI-Pro and demonstrate its capabilities as a cash register interface. Press the “Up” or “Down” button to move the cursor to “TEST/DEMO MODE” and press “Set”. The following sub-menu will appear:

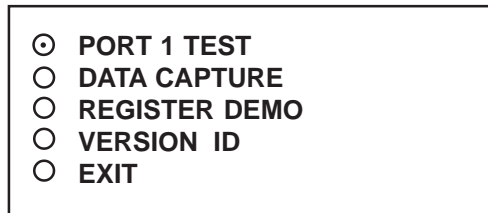

Figure 76: TEST/DEMO MODE Sub-Menu

### PORT 1 TEST

Sending and receiving data performance can be analyzed under the PORT 1 TEST sub-menu. Press the “Up” or “Down” button to move the cursor to “PORT 1 TEST” and press “Set”. The following sub-menu will appear:

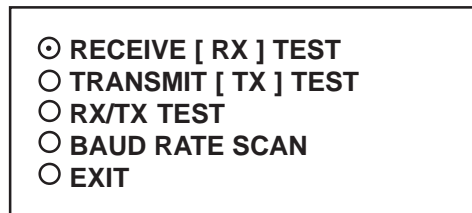

Figure 77: PORT 1 TEST Sub-Menu

### RECEIVE [ RX ] TEST

The purpose of this test is to determine that if VSI-Pro is receiving the data or not. Press the “Up” or “Down” button to move the cursor to “RECEIVE [ RX ] TEST”. The following display will appear (example only):

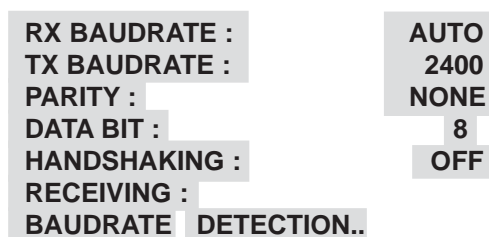

Figure 78: RECEIVE [ RX ] TEST Display

Receiving data will be appear in three sperate lines, scrolling from right to left. The first line is the actual ASCII data coming from the register while last two lines are HEX conversion of ASCII data. If you do not receive any data, check the connections between VSI-Pro and Register or any additional interfacing device.

Press “Set” to return to the previous menu.

#### **NOTE**

*In the above or below tests, you can stop the scrolling data by holding down either “Up” or “Down” button.*

## PROGRAMMING

---

### TRANSMIT [ TX ] TEST

The purpose of this test is to determine that if the VSI-Pro is able to transmit data or not. Press the “Up” or “Down” button to move the cursor to “TRANSMIT [ TX ] TEST” and press “Set”. The following display will appear (example only):

```
RX BAUDRATE :      AUTO
TX BAUDRATE :      2400
PARITY :           NONE
DATA BIT :         8
HANDSHAKING :     OFF
TRANSMITTING :
BAUDRATE  DETECTION..
```

Figure 79: TRANSMIT [ TX ] TEST Display

If VSI-Pro transmitting data you will see some predefined ASCII character on the screen. If you don't see any characters on the screen, check the connections and try again. Press “Set” to return to the previous menu.

### RX / TX TEST

In the RX/ TX test the VSI-Pro echos whatever it receives. Press the “Up” or “Down” button to move the cursor to “RX/ TX TEST” and press “Set”. The following display will appear (example only):

```
RX BAUDRATE :      AUTO
TX BAUDRATE :      2400
PARITY :           NONE
DATA BIT :         8
HANDSHAKING :     OFF
ECHOING :
BAUDRATE  DETECTION..
```

Figure 80: RX /TX TEST Display

Press “Set” to return to the previous menu.

### BAUD RATE SCAN

The Baud Rate Scan test can scan the baud rate of your register. Press the “Up” or “Down” button to move the cursor to “BAUD RATE SCAN” and press “Set”. The following display will appear (example only):

```
RX BAUDRATE :      AUTO
TX BAUDRATE :      2400
PARITY :           NONE
DATA BIT :         8
HANDSHAKING :     OFF
BAUDRATE SCAN :
BAUDRATE  DETECTION..
```

Figure 81: Baudrate Scan Display

Enter a transaction from the register. The VSI-Pro will detect the baud rate and display it in front of RX Baud rate. Press “Set” to return to the previous menu.

### EXIT

Press the “Up” or “Down” button to move the cursor to “EXIT” and press “Set” to return to the previous menu.





## DATA CAPTURE

This feature allow user to store the data either internal memory of VSI-Pro Max or some external data storing device. Press the “Up” or “Down” button to move the cursor to “DATA CAPTURE” and press “Set”. The following sub-menu will appear:



Figure 82: DATA CAPTURE Sub-Menu

Press “Set” to return to the previous menu.

## CAPTURE TO PORT 1

This feature redirect the incoming data to VSI-Pro Max to its output ( Pin 3 of AT type RS-232 female connector ) where that data can be stored to data storing devices (e.g. PC). This feature is useful to store non-RS 232 format data. Press the “Up” or “Down” button to move the cursor to “CAPTURE TO PORT 1 and press “Set”. The following display will appear (example only):

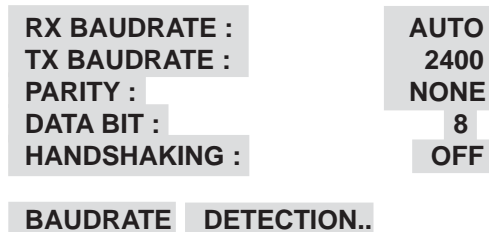

Figure 83: CAPTURE TO PORT 1 Display

Press “Set” to return to the previous menu.

## CAPTURE TO MEMORY

This feature allow you to store the data in the internal memory of VSI-Pro Max. You can store up to 20 kilobytes of data in the internal memory of VSI-Pro. Power up the VSI-Pro for 24 hours prior to download of data. This will provide VSI-Pro’s internal battery a full charge to hold data in its memory. Press the “Up” or “Down” button to move the cursor to “CAPTURE TO MEMORY” and press “Set”. The following display will appear (example only):

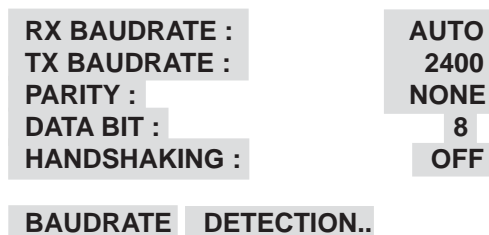

Figure 84: CAPTURE TO MEMORY Display

Press “Set” to return to the previous menu.

### NOTE

*VSI-Pro can hold up to 120 kilobytes of data to make sure that you only transfer the data which is in correct format.*

## PROGRAMMING

**NOTE**  Any Programming or data transfer of any kind can overwrite the saved data in memory.

### DUMP MEMORY

You can upload any saved information from the VSI-Pro memory to any PC or some specific communication devices using appropriate upload cable. To upload the information into a PC you must have any communication software which can transfer the binary data. Press the “Up” or “Down” button to move the cursor to “DUMP MEMORY” and press “Set”. The VSI-Pro will start uploading the data.

### REGISTER DEMO

This demonstration simulates transaction data from a register. This is used to demonstrate the VSI-Pro Max’s capabilities with just a monitor and camera without having a register hooked up. When the demo mode is active the VSI-Pro Max thinks the data is actually coming from a real register. You can use this demo data to configure exceptions and alarms to be fully functional for a complete customer demonstration.

Press the “Up” or “Down” button to move the cursor to “REGISTER DEMO” and press “Set”. You will see the following;

**Figure 85: Register Demo Sub-Menu**



Selecting “DEMO” will give you two options of 19 or 37 characters per line. After selection the demo will start after a few seconds. To exit this demo, press and release “Reset”. If data is sent to the VSI-Pro Max during this demo mode with “DEMO ON POWER UP” set to OFF then the demo mode will be disabled and you must go back into the programming mode and select again as described above.

If you select “DEMO ON POWER UP” as “ON” then pressing the “Reset” or powering up or down will have no effect on the demo mode and will continuously work until disabled by this menu selection. If you connect the VSI-Pro Max to a cash register and it sends data to the VSI-Pro during this demo mode then the demo mode will also be disabled until you press “Reset” or power down and up again.

### VERSION ID

When selected, this will display the version of software in use by the VSI-Pro Max shown detail (example below).

VSI-PRO Version 14.00 R1  
06/25/2008

### EXIT

Press the “Up” or “Down” button to move the cursor to “EXIT” and press “Set” to return to the previous menu.

## 5.10 DOWNLOAD/UPLOAD SETUP

This feature lets you upload or download data between two VSI-Pro Max’s or a VSI-Pro Max and a PC. This feature is especially helpful on multi-interface installations. You can program one VSI-Pro Max and download the data to another VSI-Pro Max with the download/upload feature and a data transfer cable. The cable is made up of two male DB-9 connectors and the pin-out is below. **NOTE:** This feature is only available to like versions and release. Therefore you can only program a VSI-Pro Max Ver. 14 R2 with a same exact VSI-Pro Max or erroneous data will occur.

**Figure 86: Download/Upload Data Cable**

<b>DOWNLOAD/UPLOAD DATA CABLE</b>	
<b>PIN 2</b>	----- <b>PIN 3</b>
<b>PIN 3</b>	----- <b>PIN 2</b>
<b>PIN 5</b>	----- <b>PIN 5</b>



## DOWNLOAD/UPLOAD SETUP USING VSI-Pro Max TO VSI-Pro Max

To insure that the DOWNLOAD/UPLOAD process is accomplished, you need to access the programming menu for both VSI-Pro Max, so each VSI-Pro Max needs a video input and a monitor. The optimum way to perform the DOWNLOAD/UPLOAD process would be to have a system set up with two separate cameras and monitors and the programmed VSI-Pro Max with the download data cable attached. The VSI-Pro Max programming data is stored internally in a battery backed 128K SRAM. This would allow you to program one VSI-Pro Max on-site and bring the programmed VSI-Pro Max back to the shop or office and program additional VSI-Pro Maxs quickly. We realize this may not always be possible to do and that there may be a need for field programming. The only difficulty with the field DOWNLOAD/UPLOAD process is accessing the programming menus of both VSI-Pro Max simultaneously.

The use of the diagram in Figure 87 will let you perform the DOWNLOAD/UPLOAD process in the field. For this, you will need a short BNC to BNC cable approximately a foot long, the data cable, and a monitor that can be used next to the VSI-Pros.

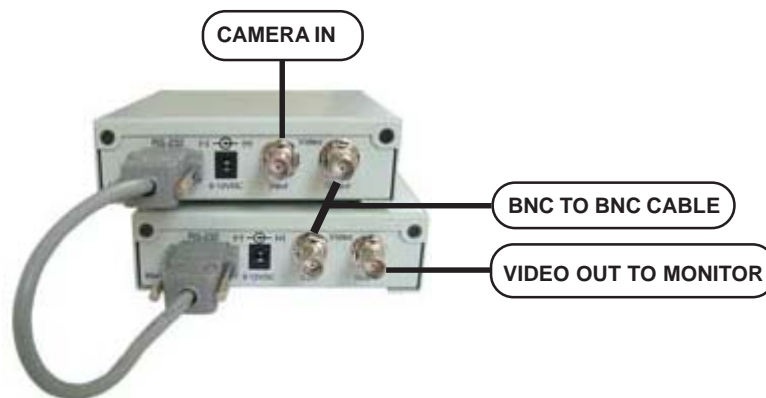

**Figure 87: DOWNLOAD/UPLOAD SETUP Using VSI-Pro Max to VSI-Pro Max**

The PROGRAMMED VSI-Pro Max will upload data to the UNPROGRAMMED VSI-Pro Max. In the configuration in the Figure 87, you can get the programming menus for both VSI-Pro Max on the screen at the same time. Use the front panel shortcut to position the text block from the PROGRAMMED VSI-Pro Max on the left side of the screen. To do this, press and hold down "Up", then press and release "Reset" and then release "Up". Now, by using the "Up" and "Down" buttons you can move the display side to side on the screen. Move the text block as far to the left as you can and press "Set" to exit. To move the display to the top of the screen, press and hold down "Set" and press and release "Reset", then release "Set". Now by using the "Up" and "Down" buttons you can move the display up and down on the screen. Move the display to the top of the screen. When you have it in the correct position, press "Set" to exit.

Go to the UNPROGRAMMED VSI-Pro and follow the same instructions to move the display to the right side of the screen. After you have both displays positioned properly, the next step is to bring up both programming menus.

Let's bring up the PROGRAMMED VSI-Pro Max first. To do this, simultaneously press and hold "Up" and "Down" and press and release "Reset", then release "Up" and "Down". This will bring up the main-menu and it should be on the top left of the screen. Now go to the UNPROGRAMMED VSI-Pro Max and do the same thing. You should now have both programming menus side by side.

### NOTE

*Depending on the size of the monitor you are using, these two menus may overlap, but should not be a problem.*

## PROGRAMMING

To proceed with the DOWNLOAD/UPLOAD SETUP, we will configure the UNPROGRAMMED VSI-Pro first. From the main-menu, press the “Up” or “Down” button to move the cursor to “DOWNLOAD/UPLOAD SETUP” and press “Set”. The following sub-menu will appear:



Figure 88: DOWNLOAD/UPLOAD SETUP Sub-Menu

Press the “Up” or “Down” button to move the cursor to “DOWNLOAD SETUP” and press “Set”. The following sub-menu will appear. Move to the cursor to “DOWNLOAD SETUP” and press “Set” and the display “DOWNLOAD SETUP...” will appear:

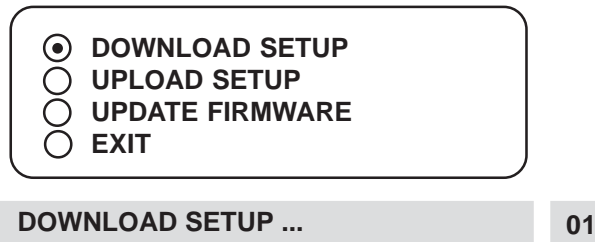

Figure 89: DOWNLOAD SETUP Sub-Menu & Display

The UNPROGRAMMED VSI-Pro Max is now waiting to receive data from the PROGRAMMED VSI-Pro Max.

Now go to the main-menu of the PROGRAMMED VSI-Pro Max and follow the previous instructions to get to “UP-LOAD SETUP” and press “Set”. The following sub-menu will appear. Move to the cursor to “UPLOAD SETUP” and press “Set” and the display “UPLOAD SETUP...” will appear:



Figure 90: UPLOAD SETUP Sub-Menu & Display

The data transfer will begin and you will have a screen count down of the status that reads:

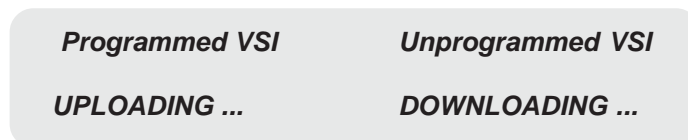

The count will end at 100. When this prompt clears the screen, the data transfer is complete. Press “Reset” to exit this menu on both VSI-Pro Max’s.

Now go to the main-menu of the previously UNPROGRAMMED VSI-Pro Max on the right side of the screen. Enter the EXCEPTIONS menu. You should see your exceptions and other programmed data just as they were on the original PROGRAMMED VSI-Pro Max.

**DOWNLOAD/UPLOAD SETUP USING A PC**

You can use a Laptop PC and AVE's IC, HyperTerminal or equivalent communications program to store data from a VSI-Pro Max to a file. This file can then be uploaded to other VSI-Pro Max units with the same software revision level. Use 38400,n,8,1 baud for the PC's baud rate.**NOTE:** This feature is only available to like versions and release. Therefore you can only program a Ver. 14.00 R5 with a same exact VSI-Pro Max or erroneous data will occur.

**NOTE** 

*For locations or companies with a large number of interfaces, we strongly advise that you keep one programmed VSI-Pro Max as a master and a backup to insure your system integrity. This will also aid in reprogramming any changes and protect against any catastrophic events.*

**VSI-Pro Max Remote Program Downloading Ver. 1.0**

The VSI-Pro Max has the ability to upload or download all the programming settings and history files via a PC Windows based application. Customer or specific registers configurations can now be saved in a laptop for ease of service and programming. You can set the VSI-Pro Max clock in sync with a laptop or manually enter. Simple keyboard strokes can enter titles, exceptions and trigger strings quickly and easily. This is accomplished by using a Com port of the laptop or a USB to RS-232 adapter. Auto connection time out and error recovery guarantees the VSI-Pro Max will function under any condition including cable breakage, power down of laptop or VSI-Pro Max and accidentally hitting reset on the VSI-Pro Max during connection.

**Software Installation**

Click Setup.exe for the VSI-Pro Max Program Download V1.0  
After installation is complete, run the program. The following window will be loaded.

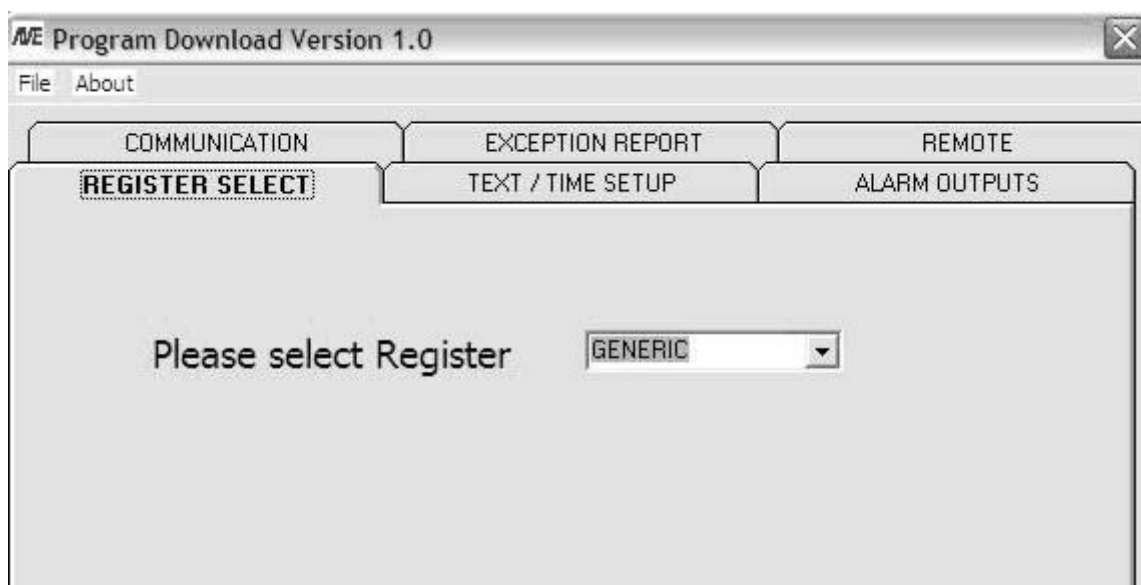

Figure 91 Program Download Main Menu

## PROGRAMMING

Click the Tab “Remote” and you will see the following Menu.

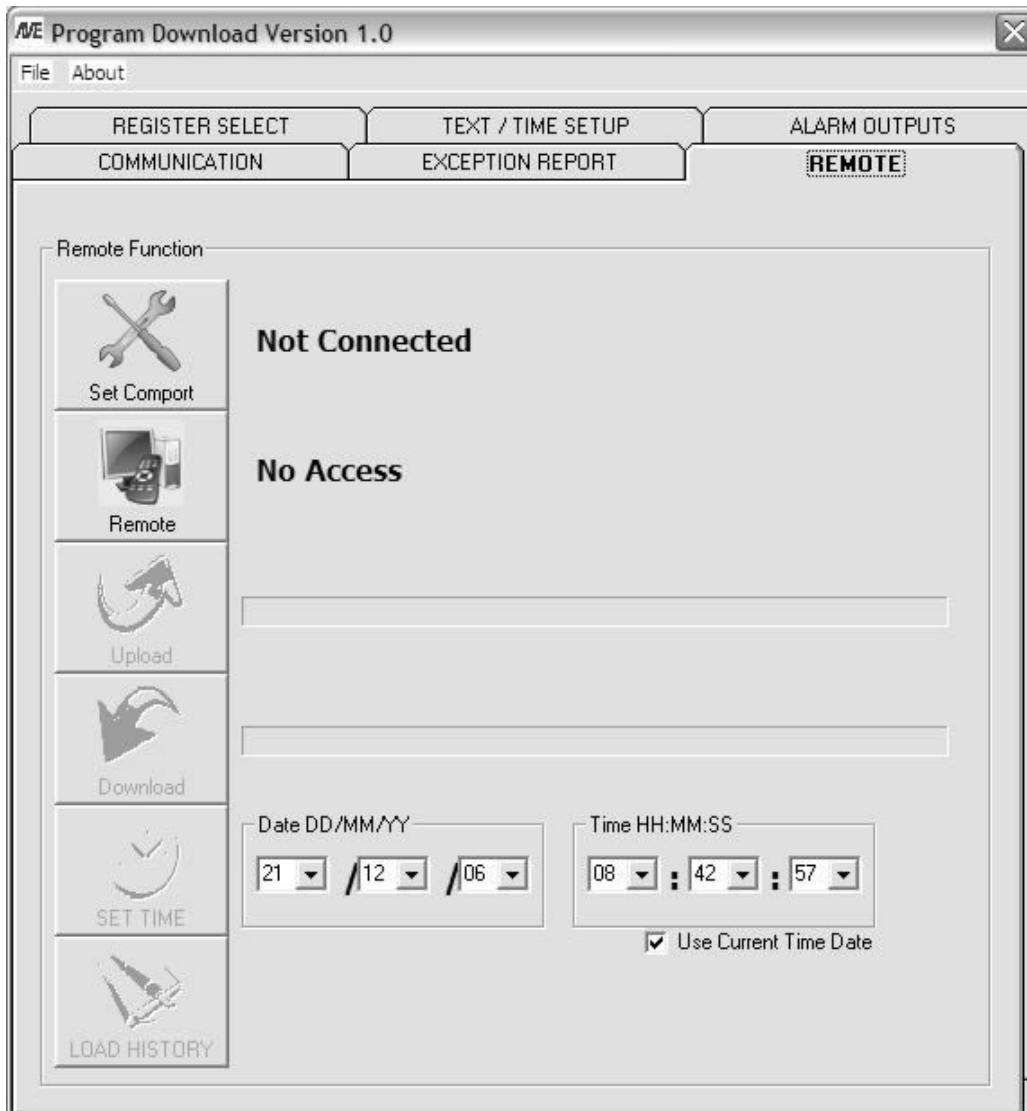

Figure 92 Remote Menu

Click on “Set Comport”. If the VSI-Pro Max is in the “Baudrate Detection” Mode then you can set any baud rate and the VSI-Pro Max will self configure. However if the VSI-Pro Max is already set to a baud rate you must select the exact baud rate and communication configuration in the VSI-Pro Max for connection to occur. If the unit does not display “Connected” then you have either entered the wrong baud rate or communication settings or a cable problem or the VSI-Pro Max not powered.

Once connected then click “Remote” and will display “Accessed” or will go back to “No Access” if the baud rate or cable connection is not proper and will also go back to “Not Connected” so you can reset the communication settings.

Once you have “Access” then you can do any function on this menu screen. “Upload” data which reads the current settings of the VSI-Pro into the PC. “Download” which sends the PC settings to the VSI-Pro. “Set Time” can set a new time or PC sync time to the VSI-Pro. “Load History” reads the History File of Exceptions from the VSI-Pro and saves as a text file on the PC.

Note: If the cable is disconnected, VSI-Pro reset or powered down, PC program closed, the PC and/or the VSI-Pro Max has a 30 second timeout and will reset itself for normal operation.

**File Menu**

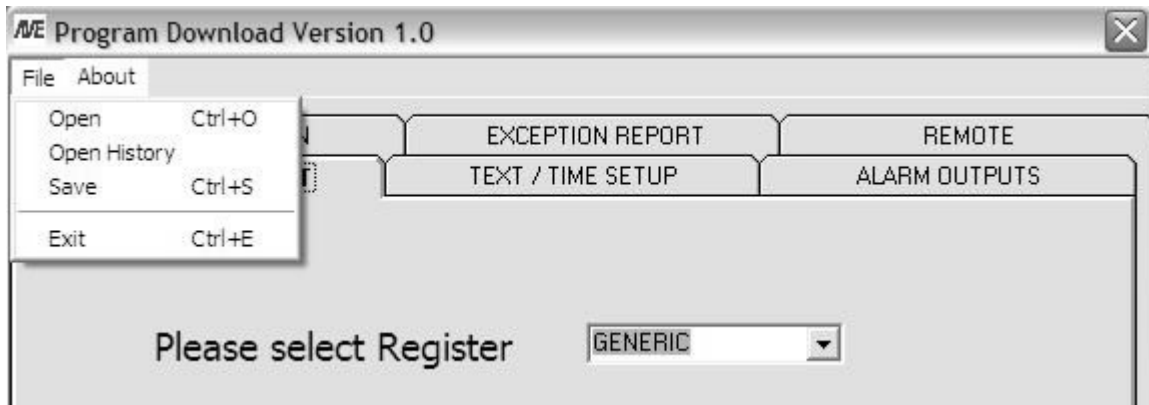

**Figure 93 File Menu**

“Open” allows you to select a file which contains a previously saved version of all the VSI-Pro Max setups.

“Open History” allows you to view a previously saved History File downloaded from the VSI-Pro Max.

“Save” allows you to save a current set of VSI-Pro Max settings that are configured in the program or previously uploaded from the VSI-Pro Max.

**About Menu**

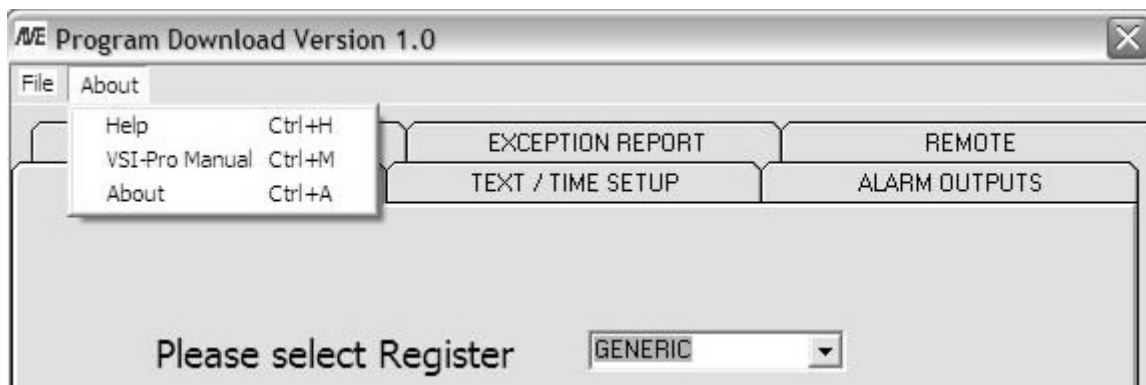

**Figure 94 About Main Menu**

“Help” gives you all the help topics of the VSI-Pro Max Program Download Ver. 1.0.

“VSI-Pro Max Manual” is an online .pdf of the current VSI-Pro Max manual for easy reference to all the setups and programming features and applications of the VSI-Pro Max.

“About” shows you the version and release of this software.

**Communication Cable Pin Out**

The Com cable is RS-232 from the PC or laptop to the VSI-Pro Max as follows. This cable can be no more than 100’ but if additional length is required you will need a set of the AVE RS-232 to RS-422 adapter which will extend the range to 3000’.

PC / Laptop DB9F	VSI-Pro DB9M
2 -----	3
3 -----	2
5 -----	5

**Figure 95: PC Programming Cable Pin Out**



# PROGRAMMING

## VSI-Pro Firmware Download Menu

To update the VSI-Pro Max, load the VSI-Pro Max Firmware Download Utility and follow the instructions below. Then select "UPDATE FIRMWARE" from the menu selection.



Figure 96: Update Firmware Sub-Menu

## VSI-Pro Max Firmware Download Utility

This document describes the VSI-Pro Max V14 Release 12. This feature allows a user to download firmware update via the RS-232 port. The LDROM 4K boot strap loader must be burner to the uP via a conventional programmer. Then the executable program is then loaded via any terminal program such as Hyper Terminal via a PC or compatible device. All firmware files are encoded to the AVE proprietary format and decoded by the bootstrap loader for standard program execution.

### Update Firmware of VSI-Pro Max

You have to connect the VSI-Pro Max with a Serial Program Terminal such as HyperTerminal, IC etc. But advise to use HyperTerminal. First, you have to set the baud rate HyperTerminal to 19200

See PC Windows below to verify proper HyperTerminal setup.

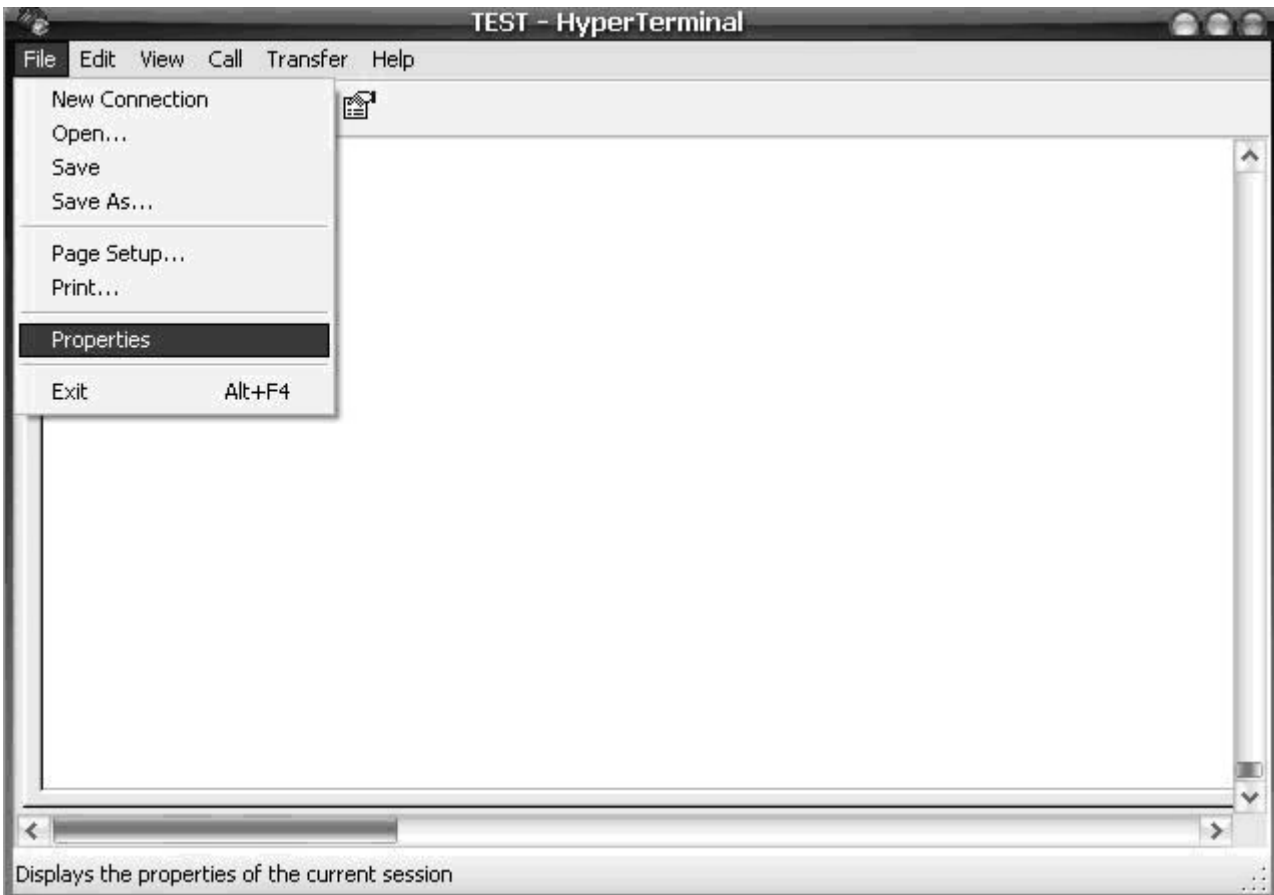
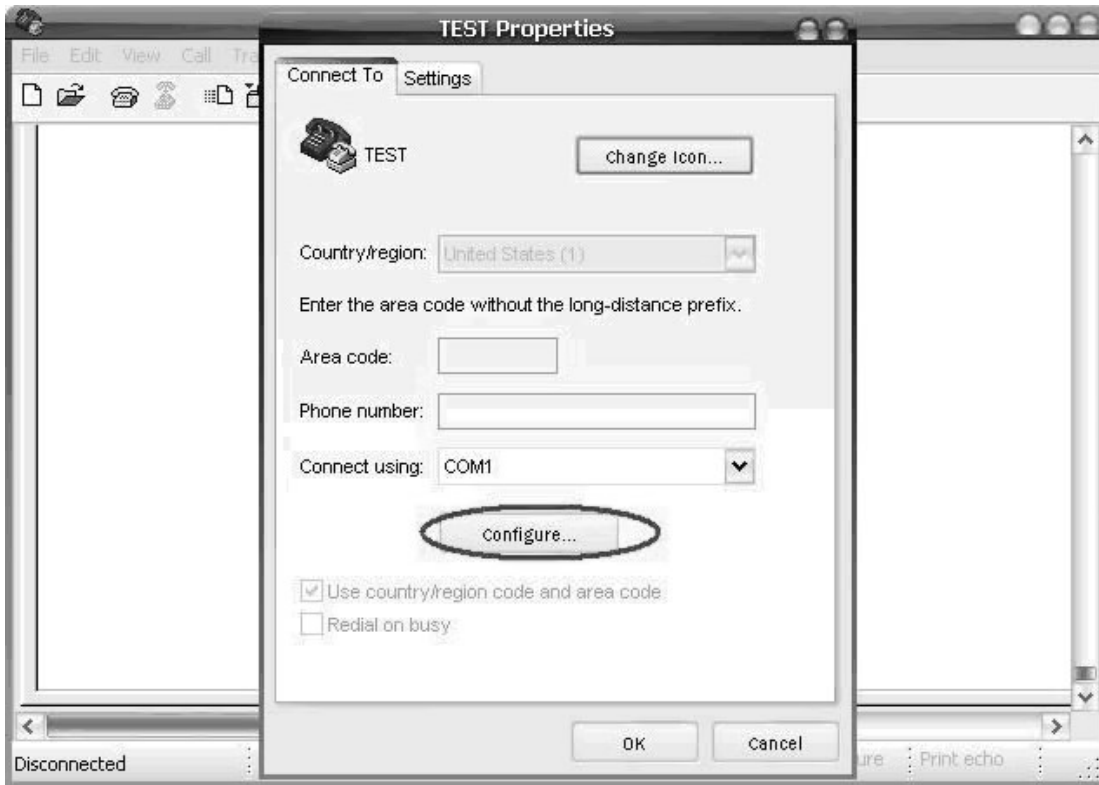

Figure 97: HyperTerminal Main Menu



Click File ==> Properties  
 You will see the configuration frame and then click.



Choose Bits per second to 19200 and press connect.

Figure 98: Connect To Menu

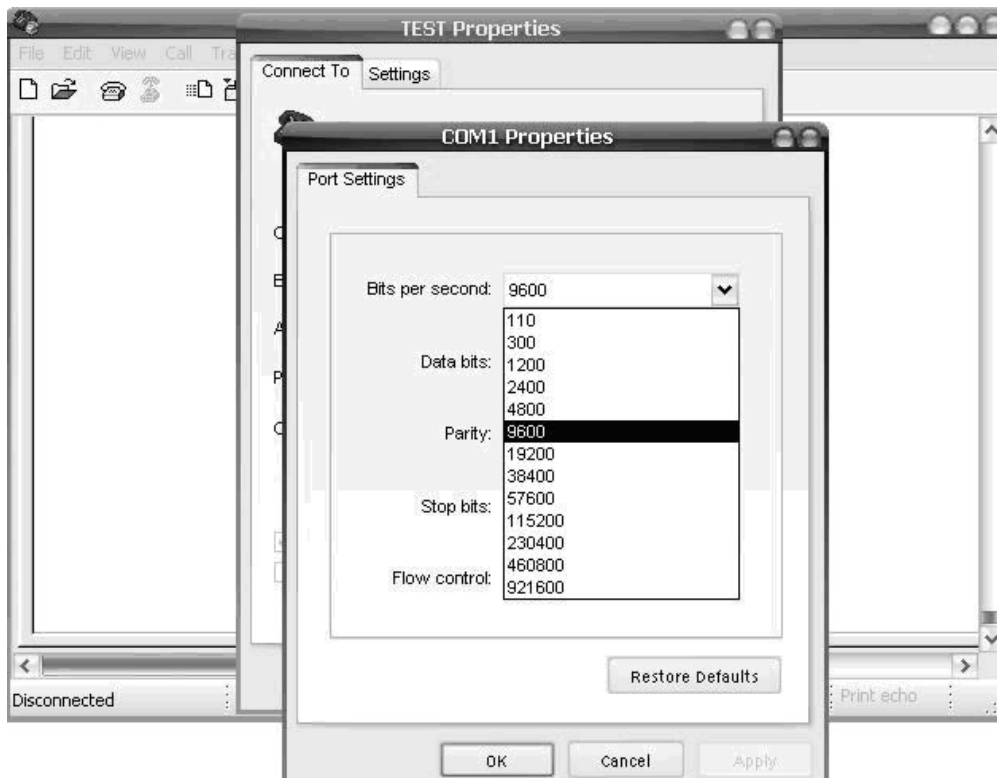
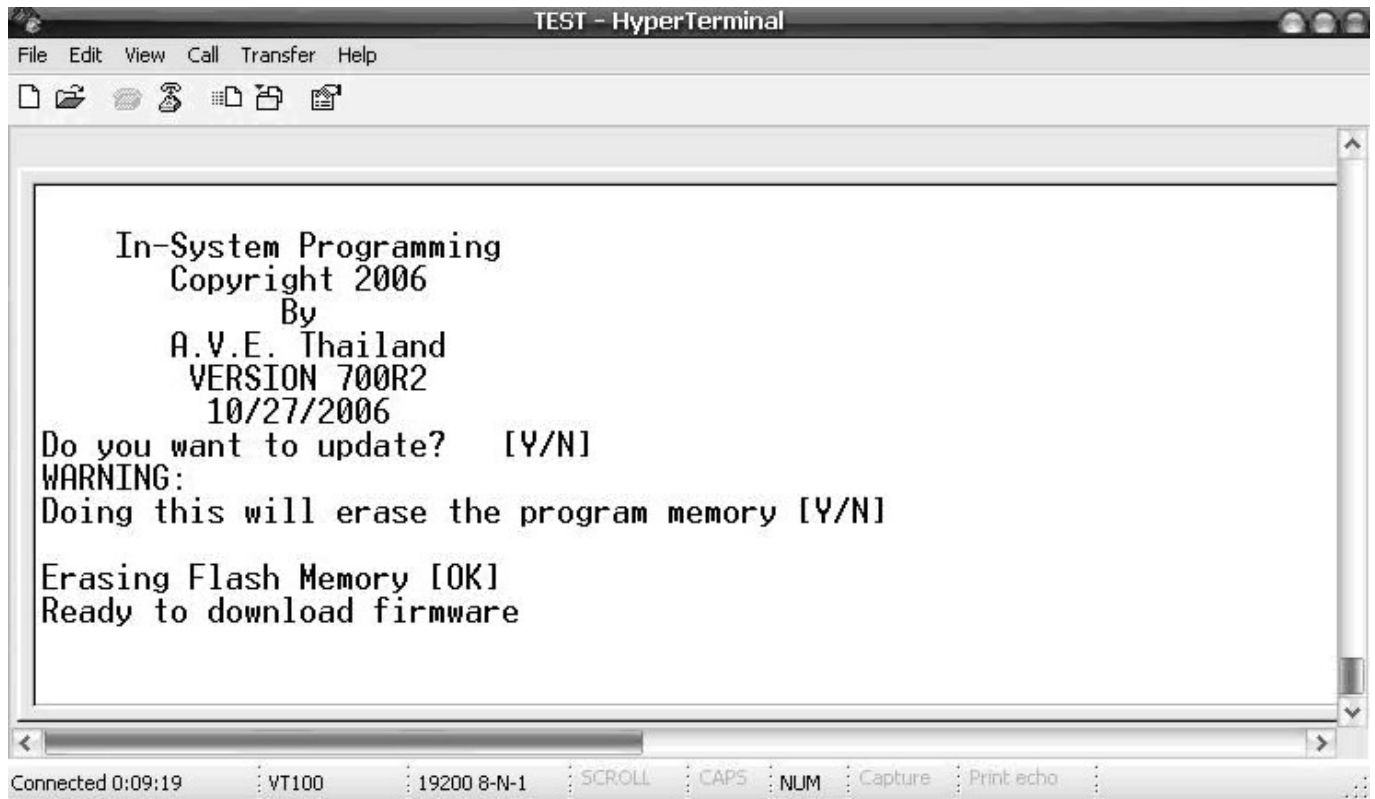

Figure 99: Port Settings Menu

## PROGRAMMING

Second, you go to the menu of the VSI-Pro Max "Download/Upload Setup" then select ==> "Update Firmware" and then press Set. Now you will see message in Hyper Terminal.



**Figure 100: In-System Programming Display**

"Do you want to update? [Y/N]"

Press "Y" to accept update.

You will see message warning again.

"Doing this will erase the program memory [Y/N]"

Press "Y" again to accept update.

NOTE: Pressing "Yes" again will permanently erase the entire program memory and the VSI-Pro will not function until firmware is loaded. Make sure you have the proper firmware file ready or the VSI-Pro will be rendered useless.

Finish erasing the program memory step.

Next, you have to send file to update firmware by click on "Transfer Menu" and select "Send Text File" and wait until finished programming. Progress dots will be displayed on the terminal program until finished and takes approximately 2.5 minutes.

NOTE: If for some reason you are disconnected from the VSI-Pro during downloading, power is lost to the VSI-Pro Max or PC or the firmware update does not finish for any reason you can repeat the procedure above again. The bootstrap loader never is erased and will always request for a valid firmware update until achieved.

To do this just power up the VSI-Pro Max or press reset while the terminal program is connected and you will see the prompt messages as above window.

## 5.11 HELP

“HELP” on the main-menu provides a quick reference guide of the functions of the “Up” and “Down” and “Set” buttons.

<b>Key Definitions :</b>	
<b>UP/DOWN</b>	-- Change value
<b>SET</b>	-- Enter change mode
	Save change
	Go to position
<b>UP AND DOWN</b>	-- Save string input
<b>UP AND SET</b>	-- Erase character

Figure 101: HELP Sub-Menu

## PROBLEM SOLVING GUIDE

## APPENDIX A

### NO DATA ON-SCREEN and/or REGISTER LED NOT FLASHING

1. Press the “Reset” button on the VSI-Pro Max front panel.
2. Incorrect register selected in the REGISTER SELECT menu.
3. Data cable is miswired.
4. Data cable is too long or did not use shielded cable.
5. May be connected to the wrong port.
6. Need RS-232 Optical Isolation so enable this feature in the VSI-Pro Max

### REGISTER LED FLASHING but NO or Wrong DATA ON-SCREEN

1. Incorrect register selected in the REGISTER SELECT menu.
2. Baud Rate wrong, change to Auto Baud rate and do transaction
3. Interface Type set wrong
3. Data cable is miswired.
4. Data cable is too long or did not use shielded cable.
5. May be connected to the wrong port.

### PROBLEMS WITH ECR / TPIF BOARDS

1. Upon register power up verify on-screen ECR power up test.
2. Check that the board is seated properly in the register.
3. Check jumper settings on the board if applicable.
4. For ECR boards make sure the 2 pin data cable is plugged in correctly.

### PROBLEMS WITH N2RS, NCR2RS, DTS2RS, B2RS ETC.

1. Check the cable to the register.
2. If VSI-Pro Max was working and stopped, power cycle the system. Turn off the register, unplug the power to the N2RS, and unplug the power to the VSI-Pro. Now power up the system, plug in the VSI-Pro and the N2RS. Turn on the register and do a transaction. The data should re-appear.
3. Check the cable between the VSI-Pro Max and the N2RS.

**NO NETWORK COMMUNICATION OR LED FLASHING**

1. Verify the RJ11, RJ12 or RJ45 is locked into the connector firmly and the locking tab no broken
2. Verify the RJ connector is crimped and wired properly, Pins 4 &5 the two in the very center.
3. Verify the unit is set to either the Master or Slave Mode
4. Verify all network modules are connected and the last in the loop terminated.

**NO DATA TO THE DVR FROM MASTER**

1. Verify the TX Protocol is set correctly and matches the DVR type and setting
2. Verify the DVR ComPort is enabled
3. Verify the cable from the VSI-Pro Max to the DVR is correct.

**NOTE** 

*The VSI-Pro Max requires 0.5VP-P to 2V P-P to properly overlay data on the video image*

**NO VIDEO ON MONITOR**

1. VSI-Pro Max transformer not plugged in, or is malfunctioning.
2. Video In/Out connectors reversed, or BNC connector is not correctly wired.
3. No video input signal.
4. Bad video cable or connector.
5. Camera Iris is closed.
6. Other video device in system is off or malfunctioning.

**CHARACTERS JITTER, JUMP, OR SKEW**

1. Darken the gray scale of the characters.
2. The VSI-Pro Max requires the input video signal to be 0.5VP-P to 2V P-P. If the voltage is too high or low, then the VSI has trouble syncing the text to the video. Use an amplifier such as AVE's VDA-401 or VECA to get the proper level.
3. Poor input sync signals - too many AC coupled amplifiers in the video input signal.
4. Noisy or poor quality video source. Replace with better source.
5. Check for double termination.
6. Video level too high; VSI-Pro Max will clip video.
7. The text block is too close to the edge of the screen. Try repositioning the text block. Also, changing the size may help.
8. Too much light in the video picture may cause character distortion. Reposition the camera or reduce the amount of light to which the camera view is exposed. If the camera you're using has an auto iris lens, try adjusting the iris to average and then reduce or increase the level.

**NO COLOR IN THE PICTURE**

1. Cable run too long and color signal too low, use AVE ARXD Active Receiver to recovery signal.
2. Cable run too long and color signal too low, use AVE VECA on the camera end to amplify the signal.

**HUM BARS or NOISE IN THE VIDEO**

1. Check video coax connectors for proper grounding
2. Check power ground for proper connection
3. Possible large ground loop fault and must use Video Isolation Transformer

**VL VIDEO ERROR LED NOT ON BUT VIDEO LOOKS BAD**

1. VL Video Error measures the level of the sync signal not the overall video peak to peak level. Therefore if sync signal is correct and the video level is noisy or low or high the display might be too light or too dark. In this case the addition of a video amplifier or adjustment of the camera settings might help.

**VL VIDEO ERROR LED ON BUT VIDEO LOOKS GOOD**

1. The VL Video Error measures the level of the sync signal not the overall video peak to peak level. Therefore it is detecting the sync signal is low and amplifying the video signal to its maximum of 2 times. In this case the sync is sufficient for the monitor or DVR to lock to and show a good image. If the inserted text from the VSI-Pro Max is stable then the VSI-Pro Max is able to lock to this low signal. If the text jitters or is skewed then a video amplifier must be placed in line with the VSI-Pro Max to bring the signal up to at least .5V P-P so the AGC circuitry can adjust to the proper output level.

**FUNNY CHARACTERS OR GARBAGE ON SCREEN**

1. Power disconnected for too long and memory is lost.
2. Lightning strike, power line noise or power surge.
3. ECR / TPIF boards make sure data cable is plugged in correctly.
4. Ground and Data wires are reversed. Verify correct DB-9 cable wiring.

**HOW TO DO A MASTER RESET ON VSI-Pro Max**

1. Press and hold in simultaneously the "Down", "Up" and "Set" buttons.
2. While holding those three buttons in, press and release the "Reset" button and then release the other three buttons.
3. This will display the copyright notice.
4. Restores the VSI-Pro Max to all the factory default settings and erases all user programming.

**MY CUSTOMER IS CHANGING REGISTERS. WILL THE VSI-Pro Max WORK WITH THE NEW REGISTER?**

This is a tricky one. The VSI-Pro Max interfaces to over 400 different registers. The probability the VSI-Pro Max will work with a new system is relatively high. The chances any additional boards or boxes will work is lower, unless your customer is staying with the same manufacturer and within the same register series.

***Contact AVE's Product Support Specialists for additional help with this issue.***

**IF I INSTALL YOUR INTERFACE BOARD INTO A NEW REGISTER, WILL IT VOID MY CUSTOMER'S WARRANTY?**

If you are connecting to an external RS-232 port of the register, generally it does not void the warranty. But if you want to add the interface board inside your new cash register, we will highly recommend you to contact the manufacturer of the cash register for sometimes opening the register does void the warranty.



The VSI-Pro provides two open collector transistor alarm outputs to trigger alarming devices. These are Alarm 1 & 2 in the Alarm menu. Upon an Exception, a VSI-Pro can be programmed to trigger a VCR to go to its fastest record time, have a Quad go full screen, home a switcher, trigger a preprogrammed PTZ, or provide visual or audible alarms. The VSI-Pro provides two alarm outputs that are rated at 12VDC @ 20mA maximum.

The following are some basic circuit designs to take advantage of the alarm output option of the VSI-Pro.

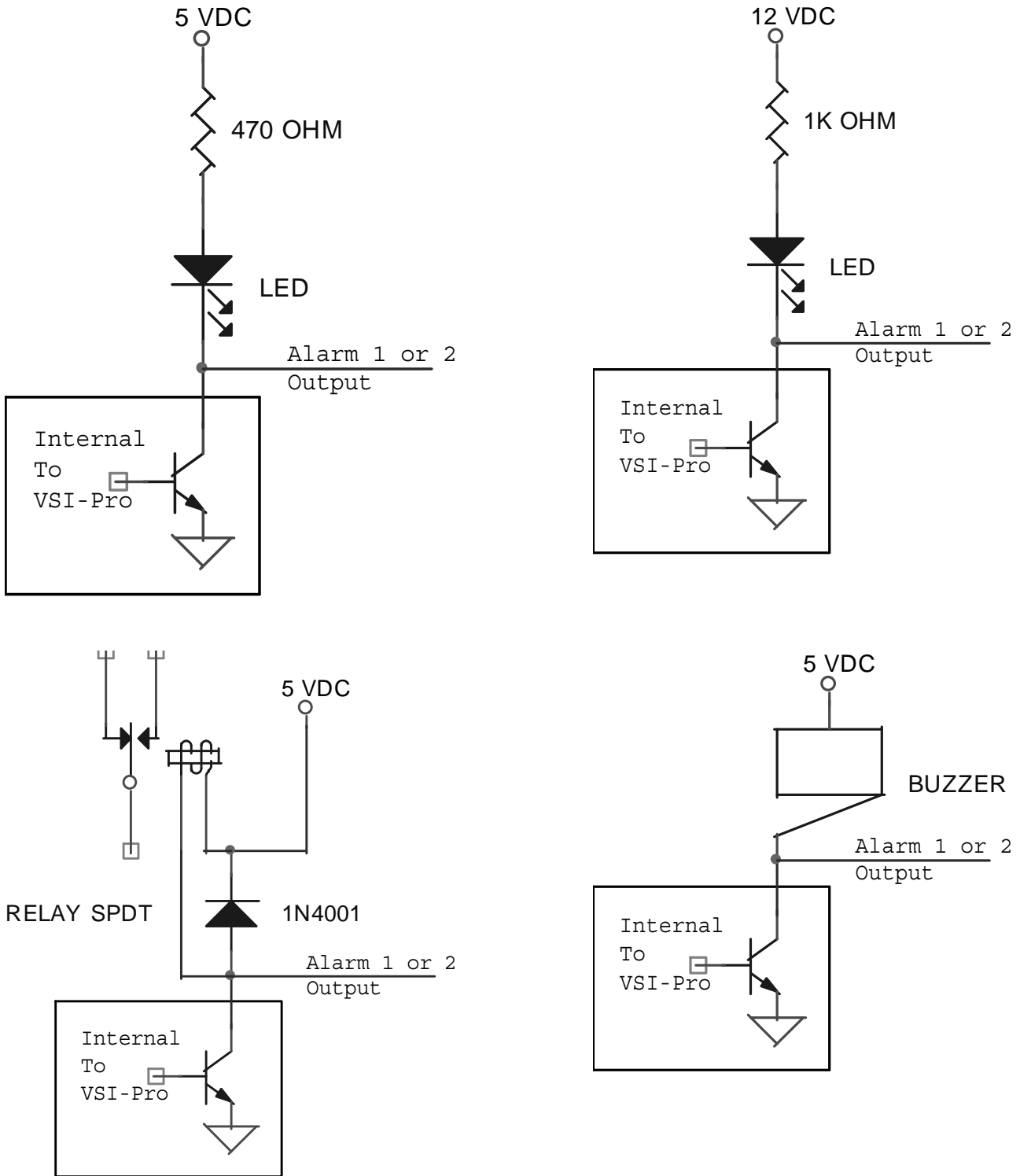

**Figure 102: Hard Alarm Output**

The AVE MVDR5000 DVR has the ability to input two VSI-Pro Max ASCII Text directly without any networking. The RS-232 DB9M connector on the rear of the DVR can accept the data from one VSI-Pro Max. The RS-485 RJ12 connector can also accept data from the VSI-Pro Max. The RS-232 port inserts the data on Camera 1 and the RS-485 port inserts on Camera 2.

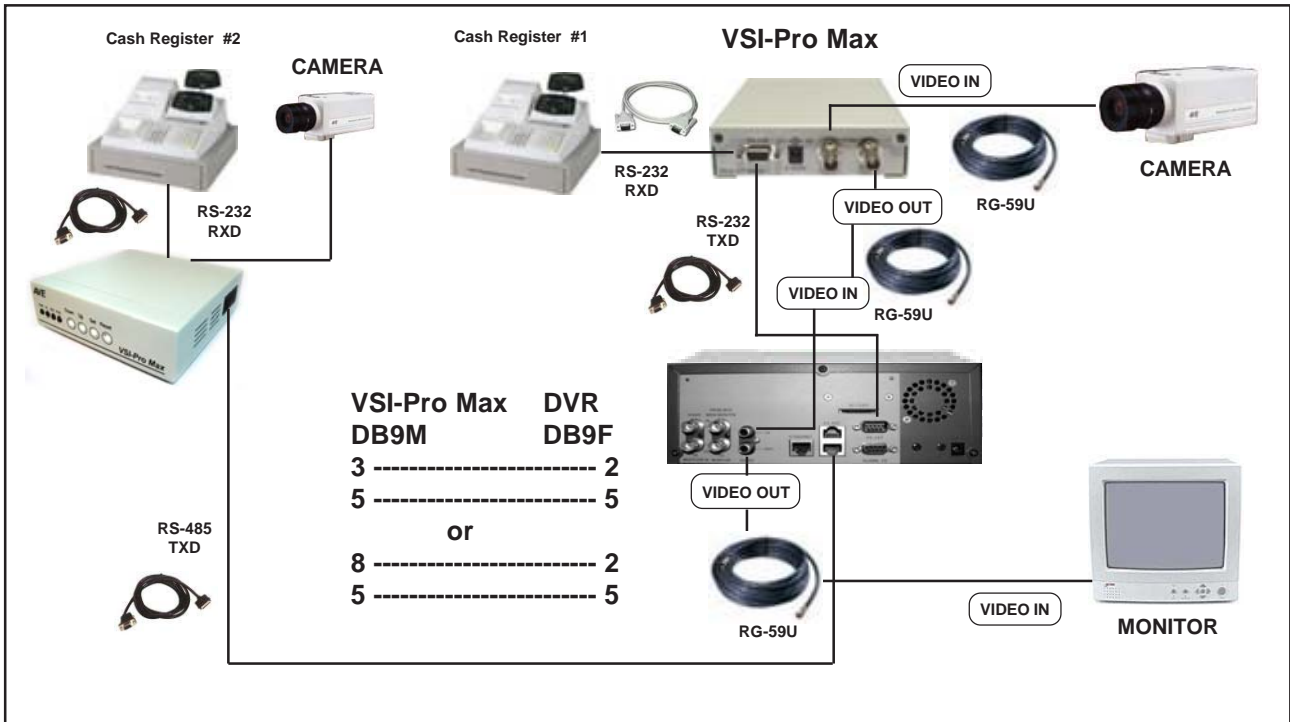

Figure 103 : VSI-Pro Max with DVR Text Input Connections

When using the VSI-Pro Max in the register “Tapping Mode” the RS-232 Pin 3 or Pin 8 can be used to output the text to the DVR. If you are using the VSI-Pro Max for “Slave Mode” networking then you can not use the RJ45 RS-485 or RS-232 Pin 8 as an output to the DVR and only RS-232 is available from Pin 3. If you are not using the VSI-Pro Max in the “Slave Mode” then you can use RS-232 Pin 8 or RJ45 RS-485 output to the DVR. If using the VSI-Pro Max in the “Master Mode” then only RS-232 Pin 3 can be used to connect to the DVR or use the AVE RS-232 to RS-485 converter to connect to the DVR RS-485 input.

When using the VSI-Pro Max in the register “Emulate Mode” only Pin 8 can be used for RS-232 output or the RJ45 Network connector can be used for RS-485 output to the DVR. The VSI-Pro Max can not be used in either the “Slave or Master Mode” while providing any ASCII text output to the DVR in either RS-232 or RS-485 format. Therefore the VSI-Pro Max when used in the “Emulate Mode” can only be used in conjunction with the “Slave Mode” OR Text output mode using RS-232 Pin 8 or RJ45 RS-485.

**MVDR3000 / 5000 RJ12 - 6 Pin Modular**      **VSI-Pro Max RJ45 - 8 Pin Modular**      **VSI-Pro Max DB9F**      **RS-232 to RS-422/485 Adapter Screw Terminals**

1 --- N/C				
2 --- GND	----- N/C	----- N/C	----- GND	----- Terminal 5
3 --- V+	----- 4	----- 4	----- A+	----- Terminal 1
4 --- V-	----- 5	----- 6	----- B-	----- Terminal 2
5 --- GND	---- N/C			
6 --- N/C				

Figure 104: VSI-Pro Max and DVR RS-485 Pin Outs

**AGC**

The VSI-Pro Max has an AGC (Automatic Gain Control) circuit on the video input. This means that even if the video signal is as low as 0.5 V P-P the VSI-Pro Max will automatically amplify to the proper level of 1 V P-P and insert the cash register data into the video flawlessly. Also if for some reason the video signal is as high as 2 V P-P the VSI-Pro Max will reduce the video signal to 1 V P-P.

With the increasing cost of RG-59U coaxial cable many installers are using the lower cost UTP (Unshielded Twisted Pair) cable and video adapters similar to the AVE TwistPlex line of passive and active adapters. When passive transmitters like the AVE UTP-1500 are used at the camera end and long runs of UTP or CAT5 wire is used, the video signal is reduced significantly by the time it reaches the VSI-Pro Max. Therefore the built in AGC circuitry of the VSI-Pro Max allows the use of low cost passive receivers like the AVE UTP-1500 and recovers the video signal.

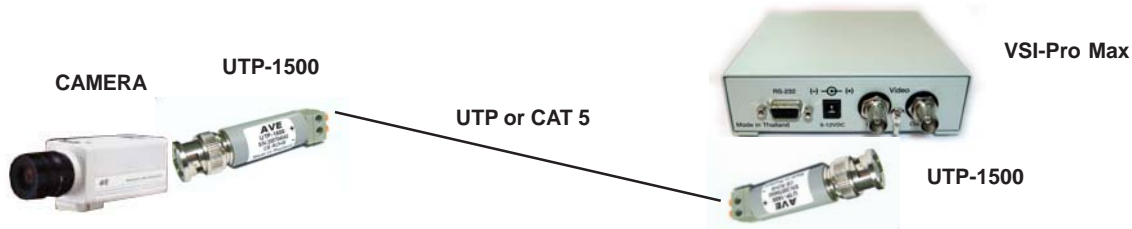

**Figure 105: VSI-Pro Max UTP Connections**

**Network RJ45 Connector**

The VSI-Pro Max has two RJ45 connectors on the side of the unit mainly for Network communications. However only two pins of this connector is used for the networking RS-485 signals Pins 4&5. All other pins are wired in parallel so can pass other LAN signals utilizing the same cable. When using CAT5 or CAT6 cable for 10Mbps or 100Mbps only Pins 1&2 and 3&6 are used for the Ethernet LAN connections so the VSI-Pro Max networking signals can use Pins 4&5 without any conflict with the LAN connections. Therefore IP cameras or Internet can ride on the same cable. Furthermore Pins 7&8 can be used to for power or the video signal utilizing the UTP-1500.

**VSI-Pro Max RJ45 Pin Outs**

RJ45 In	RJ45 Out	VSI-Pro Max
1 -----	1 -----	N/C
2 -----	2 -----	N/C
3 -----	3 -----	N/C
4 -----	4 -----	A+ VSI-Pro Max Network
5 -----	5 -----	B- VSI-Pro Max Network
6 -----	6 -----	N/C
7 -----	7 -----	N/C
8 -----	8 -----	N/C

**Figure 106: VSI-Pro Max RJ45 Pin Outs**

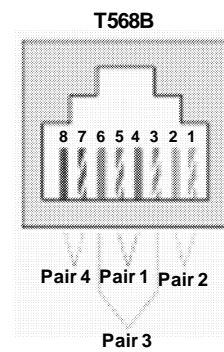

**Figure 107: RJ45 Connector**

**CAT 5 Breakout**

The AVE CAT5 Breakout makes all these connections simply plug and play. This device has an RJ45 connector for the CAT5/6 wire connection of all 4 pairs. It also has an additional RJ45 for the addition of Ethernet LAN, another RJ45 for the VSI-Pro Max Networking or Telco signals and a built in UTP-1500 for passive video transmission on the same cable.

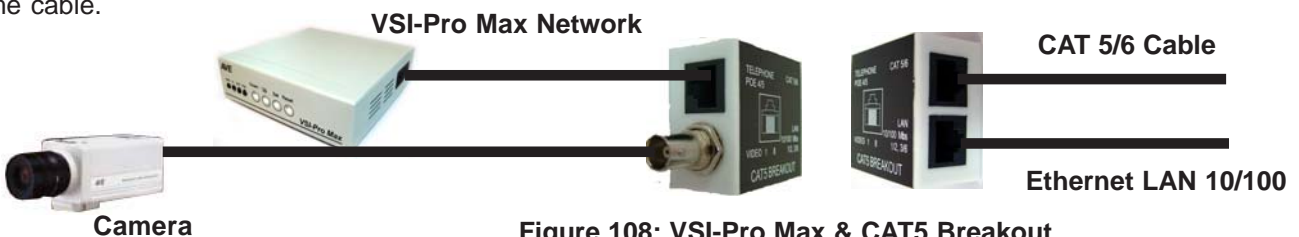

**Figure 108: VSI-Pro Max & CAT5 Breakout**





There are a myriad of PC-based systems out there which do not appear on the AVE Cash Register Compatibility List. Most of the PC-based cash registers that are not included in the AVE Cash Register Compatibility List are able to interface to the VSI-Pro Max. To find the compatibility of a cash register we need to determine following:

Does the cash register use a stand-alone receipt printer? If it does it can either be a serial or parallel printer. Serial printers use DB9 , DB25 or RJ45 type connectors. However parallel printers generally use Centronics type connectors, but on the cash register side use DB25. If it is a serial printer then you can use an AVE Triport DB9 or Triport DB25.

USB ports are also commonly connected to printers. The AVE USB232 adapter will emulate a printer and output RS-232 data to the VSI-Pro Max. A software driver is supplied with the unit which needs to be installed on the PC prior to running the POS software.

The VSI-Pro Max can also interface with a parallel printer, if a high speed parallel-to-serial converter is connected with either the cash register or with the printer. You can also use AVE's high speed serial-to-parallel converter "P2RS" for interfacing the VSI-Pro to the parallel port. AVE's high speed P2RS converter is shown below.

Pole or Customer Displays are similar to printers and are either serial, parallel or USB and all the above also apply.



Figure 109: P2RS Parallel-to-Serial Converter Front Panel



Figure 110: P2RS Parallel-to-Serial Converter Front Panel

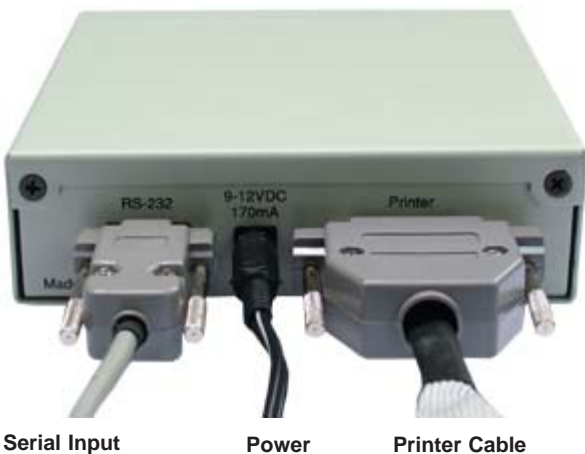

Figure 111: P2RS Parallel-to-Serial Converter Connection Cables



Figure 112: DB-25 Cable



Figure 113: Centronics Cable

The Pin-Out for the cable between the P2RS and the VSI-Pro is as follows.

P-2-RS ( DB-9F )	VSI-Pro ( DB-9M )
TXD 3	2 RXD
GND 1	5 GND

Figure 114: Pin-Out for P2RS to VSI-Pro Max

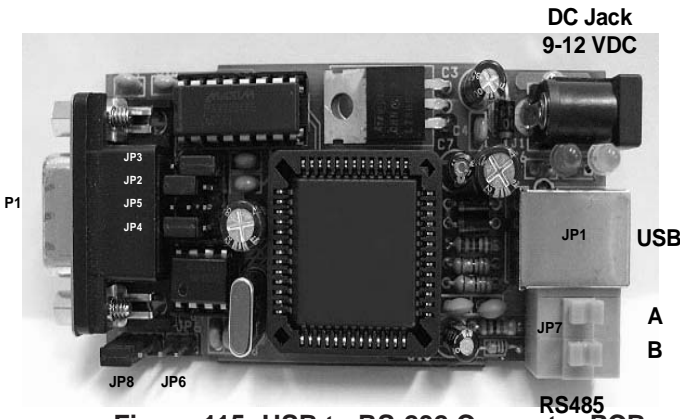

Figure 115: USB to RS-232 Converter PCB



Figure 116: USB232

- JP1** - USB type B Connector.
- JP7** - RS485 Connector.
- P1** - RS232 Connector (DB9 Male).
- JP6** - RS485 load resistor jumper (120 Ohm).

**Configuration Settings**

RXD	RS232	RS485 A(+)	B(-)
JP8	2-3	1-2	

**RS232 Configuration**

Jumper Setting	(2-3)	(1-2)
RXD (JP3)	PIN 2	PIN 3
TXD (JP2)	PIN 2	PIN 3
CTS (JP5)	PIN 7	PIN 8
RTS (JP4)	PIN 7	PIN 8

**Jumper Default Setting**

JP8	1-2	Select RS485
RXD (JP3)	2-3	Connect to DB9 PIN 2
TXD (JP2)	1-2	Connect to DB9 PIN 3
CTS (JP5)	None	Not connected
RTS (JP4)	1-2	Connect to DB9 PIN 7

**Baud Rate**

This device can scan terminal baudrate and set device Baud rate as same as terminal.

**Compatible Baud rate (Bit per second)**

300, 1200, 2400, 4800, 9600, 19200, 38400, 57600, 115200

**Power**

This device can **use power from USB bus** or power from DC adaptor 9-12 VDC

See users guide for Software Installation and compatibility

**VSIB for Thai, Korean or Chinese Languages**

The VSIB is a bit-mapped display device that can display Thai, Korean, or Chinese characters. This device works in conjunction with the VSI-Pro. A special cable is connected between the VSI-Pro and the VSIB so all on-screen programming is done via the VSIB but the controls and menus are the same as the VSI-Pro. Therefore after connection, the programming will be identical to this manual. The VSIB must be ordered independently for any of the above supported languages and the language must be specified.



Figure 117: VSI-Pro Front Panel



Figure 118: VSIB Front Panel



Figure 119: VSIB Rear Panel



Serial Input    Power    Video Input    Video Output

Figure 120: VSIB Connection Cables

Disconnect the standard VSI-Pro and plug its cable into the female connector of the Triport.



Use the BNC connectors of the VSIB for your Video Input & Output

Figure 121: Cable Connection to VSIB

The pin-out for the VSIB between the VSI-Pro and the VSIB is as follows:

VSIB ( DB-9M )	VSIB ( DB-9M )	VSIB ( DB-9M )	VSIB ( DB-9M )
TXD 3	—————	2	RXD
RTS 7	—————	8	CTS
GND 5	—————	5	GND

Figure 122: Pin-Out for VSIB to VSI-Pro

The ECR Interfaces are small PCBs that mount internally to the cash registers. These PCBs convert internal data from matrix and drum printers or thermal printers to RS-232 data. This RS-232 data is then connected directly to the VSI-Pro for display. It also can be connected directly to the Regcom to send up to 16 cash register's data on a central collection PC or DVR.

The ECR Interfaces have many different connection types depending on the make and model of cash register. Typically the RS-232 cable comes from the rear of the register to further connect to the VSI-Pro or DVR. The manufacturer and model number of the cash register must be supplied when ordering this ECR Interface.

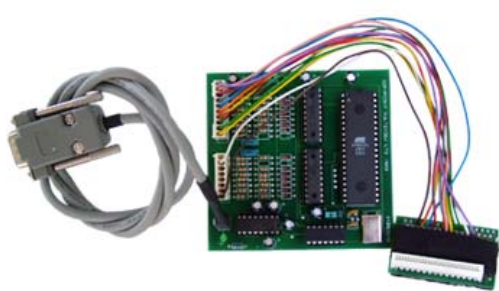

Figure 123: TK6000/7000 PCB and Cable

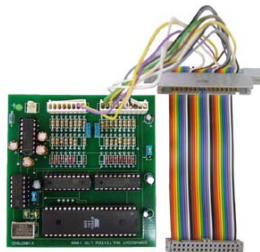

Figure 124: TK2300 and Adapter



Figure 125: TE2200 Thermal Printer

When using the AVE IF ECR Interface PCBs that are generally installed inside the cash register and an RS-232 connector mounted on the register or the RS-232 cable fitted through the rear of the till. These interfaces output direct converted and formatted RS-232 of the printer. This data can be connected directly to the AVE line of DVRs without additional conversion up to 100'. If additional lengths are needed then the AVE RS-232 to RS-422/485 converter can be used to extend this range to 3000'.

The Regcom interface can directly connect to these devices and report up to 16 tills on the Regcom network back to the PC Program or to the AVE line of DVRs converted using the Hydra.

ANSI DRIVER COMMANDS

APPENDIX I

**SET CURSOR**

<ESC>[Y;XH -> Y is vertical, X is horizontal , X and Y set by numeric character (0-9)  
 Ex. Vertical line = 5 , Parameter Y will be set to "35H"  
 Horizontal line = 19 , Parameter X will be set to "31H39H"  
 Result Hex format = 1BH 5BH 35H 3BH 31H 39H 48H

**CLEAR DISPLAY**

<ESC>[2J

**CLEAR CURRENT CURSOR TO END OF LINE**

<ESC>[K

**REVERSE TEXT**

<ESC>[7M

**CURSOR DOWN**

<ESC>[PnB

**FLASH TEXT**

<ESC>[5M

**CURSOR UP**

<ESC>[PnA

**NORMAL TEXT**

<ESC>[0M

**CURSOR LEFT**

<ESC>[PnC

**CURSOR RIGHT**

<ESC>[PnD

\*\* <ESC> = 1BH

\*\* Pn = The distance moved is determined by this parameter. If the parameter value is not set then default value will be 1

Table:4 ANSI Driver Commands



For some installations exceptional long runs are required, then RS-232 can not support for is normally limited to about 100 ft. In this case one would convert the RS-232 to RS-485 which can be extended up to about 3000 ft. Then on the other end another converter would convert back to RS-232. When using the VSI-Pro Max this additional converter is not required for already has built in RS-485 compatibility. However termination for the POS / Cash Register port is via JP2 internally to the VSI-Pro Max is required.

**Jumper Setting**

JP1	OPEN/CLOSE	RS485 / RS-422 Transmit Termination On/Off 120 Ohm
JP2	OPEN/CLOSE	RS-422 Receive Termination On/Off 120 Ohm
JP4	CLOSE 1-2	RS-232 TXD to DB9M Pin 3
JP4	CLOSE 2-3	RS-232 TXD to DB9M Pin 2
JP5	CLOSE 1-2	RS-232 RXD to DB9M Pin 2
JP5	CLOSE 2-3	RS-232 RXD to DB9M Pin 3
JP6	CLOSE 1-2	Enable RS-485
JP6	CLOSE 2-3	Enable RS-422
JP7	CLOSE 1-2	Enable RS-485
JP7	CLOSE 2-3	Enable RS-422

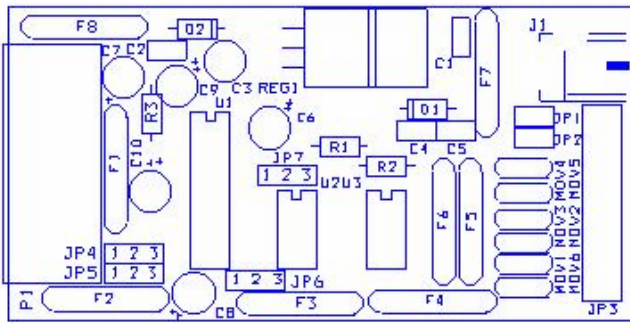

- 5 GND
- 4 RS422 Rx + A
- 3 RS422 Rx - B
- 2 RS422 Tx + A / RS485 + A
- 1 RS422 Tx - B / RS485 - B

Figure 126: RS-232 to RS-485/422 Converter PCB

**Jumper Setting for RS422**

JP1	CLOSE	RS-422 Transmit Termination On 120 Ohm
JP2	CLOSE	RS-422 Receive Termination On 120 Ohm
JP4	CLOSE 1-2	RS-232 TXD to DB9M Pin 3
JP5	CLOSE 1-2	RS-232 RXD to DB9M Pin 2
JP6	CLOSE 2-3	Enable RS485
JP7	CLOSE 2-3	Enable RS485

**Jumper Setting for RS485 (Default )**

JP1	CLOSE	RS-485 Termination On 120 Ohm
JP2	OPEN	RS-422 Receive Termination Off 120 Ohm
JP4	CLOSE 1-2	RS-232 TXD to DB9M Pin 3
JP5	CLOSE 1-2	RS-232 RXD to DB9M Pin 2
JP6	CLOSE 1-2	Enable RS-485
JP7	CLOSE 1-2	Enable RS-485

**DB9M Pin Out**

- 1 \_\_\_\_\_ N/C
- 2 \_\_\_\_\_ RXD/TXD
- 3 \_\_\_\_\_ RXD/TXD
- 4 \_\_\_\_\_ DTR True
- 5 \_\_\_\_\_ GND
- 6 \_\_\_\_\_ N/C
- 7 \_\_\_\_\_ RTS
- 8 \_\_\_\_\_ N/C
- 9 \_\_\_\_\_ 12VDC Input



Figure 127: RS-422/485 Connector of the RS-232 to RS-422/485 Converter.



Figure 128: RS-232 Connector of the RS-232 to RS-422/485 Converter.

TCPIP 232 ADAPTER

Interfacing the VSI-Pro Max to the cash register TCP/IP network requires the TCPIP 232 Adapter along with the VSI-Pro Max. The IP address of the cash register is programmed into the TCPIP 232 Adapter via on-screen programming. The cash register LAN cable is plugged into the adapter and the supplied additional LAN cable is then plugged into the cash register. Therefore this DOES NOT require an additional network port for the cash register interface or any host programming of the router or switch. The TCPIP232 Adapter is not AutoSense so make sure the router is set for MDI so normal straight thru cables are used.



Figure 129: Front of TCPIP 232 Adapter



Figure 130: Rear of TCPIP 232 Adapter

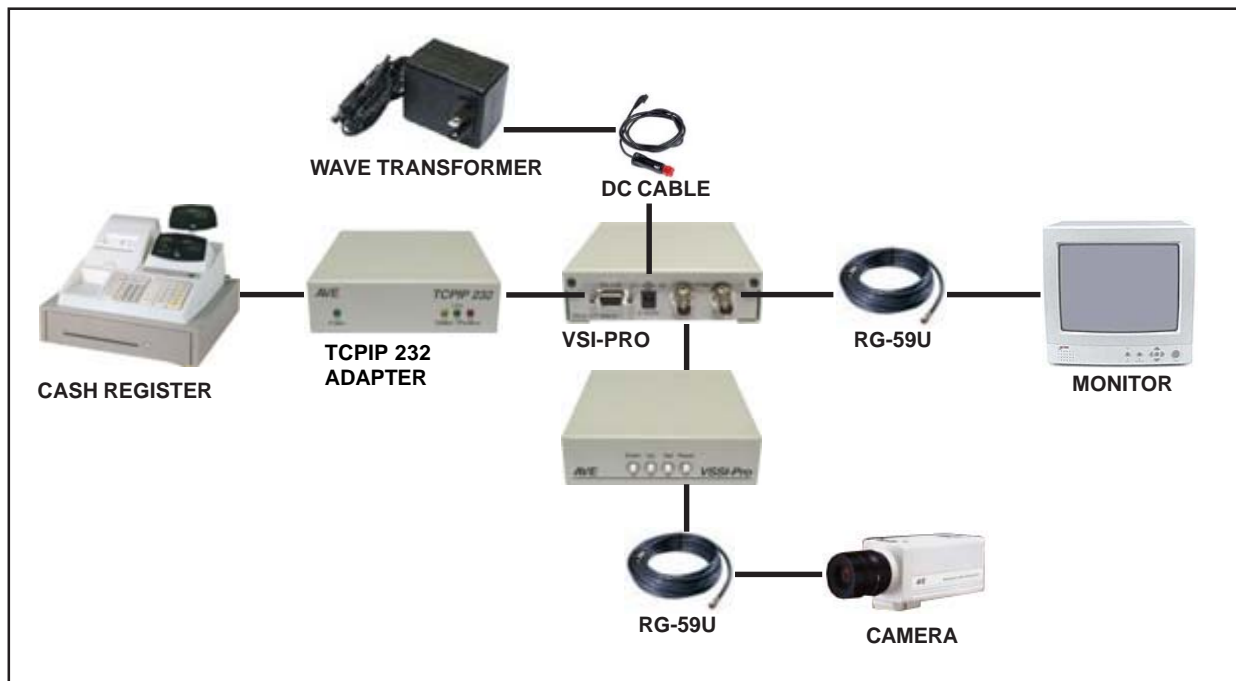

Figure 131: VSI-Pro Connections with TCPIP 232 Adapter

The pin-out between the TCPIP 232 Adapter and the VSI-Pro is as follows:

TCPIP (DB-9M)	VSI-Pro (DB-9M)
RXD 2	3 TXD
TXD 3	2 RXD
GND 5	5 GND

Figure 132: Pin-Out for TCPIP 232 Adapter to VSI-Pro Max



The VSI-Pro Max is an evolution in the philosophy of AVE to be fully backward compatible with older products along with advancing the features and performance of our new products. Not only can the VSI-Pro Max be fully compatible with all AVE Networking devices like the original Hydra / Regcom, the lower cost Networker and Vnetworker but it can translate between these protocols to integrate older installations and configurations seamlessly with the latest products. Both communication ports of the VSI-Pro Max are either RS-232 or RS-485 so the need of external converters is now eliminated.

### Network Types

Traditionally the Hydra / Regcom system connected to VSIs, ECR Cards or adapter directly with a buffered product and allows the register data to be collected on one RS-485 network and delivered to a DVR or PC offering a moderately priced solution

The Hydra / Networker system connected only to VSIs using the VSI internal buffer and allows the register data to be collected on one RS-485 network and delivered to a DVR or PC offering a low cost solution.

The Hydra / Vnetworker system connected only to VSI-Pro using the VSI-Pro internal buffer and remote programming ability to program and control the VSI-Pro remotely by the DVR or PC along with register data collection and delivery via the RS-485 network.

### VSI-Pro Max Network Capability

The VSI-Pro Max can interface to all of the above network types and then output this network data in the Master or Hydra mode in any format selectable by the user. Therefore existing systems can simply add a VSI-Pro Max to them and configure for whatever they choose. The following is some examples;

- 1) Systems using VSIs with Regcoms and a Hydra Master can simply add the VSI-Pro Max as a slave register interface expanding the existing system.
- 2) Systems using the VSIs with Regcoms can replace the Hydra Master with a VSI-Pro Max which will do the Hydra function and add another register to the system. Then with the VSI-Pro Max as the Master the protocol can be translated from Regcom to Vnet allowing connection to the AVE MVDR5000 and have remote programming capability from the DVR front panel for the VSI-Pro Max. The older VSIs and Regcoms on the network will remain to collect data but will not be able to be remotely programmed by the DVR.
- 3) If a user is using an older version of PC software for data collection for Regcoms or Vnetworkers, the same software can be used to collect data from another network type by the translation capability of the VSI-Pro Max. However the latest release of PC Programming software for the VSI-Pro Max includes all versions in one and supersedes all previous multiple versions.
- 4) Systems using Networkers can add Vnetworkers seamlessly to these networks or VSI-Pro Max. The programming capability of Vnetworkers and VSI-Pro Max are macro sets of the Networker so would seamlessly together. However you could use a VSI-Pro Max as the Hydra Master and translate the Vnetworker protocol to the Regcom protocol and deliver the data to a DVR that only supports the VSI-ADD protocol. Then if the DVR software is updated to support the Vnetworker protocol, simply select the output protocol of the VSI-Pro Max accordingly and take advantage of remote programming capability of the DVR.

### Summary

The VSI-Pro Max is now the solution to almost every new application or configuration of any AVE POS/Cash Register Interface solution. Compatibility with existing cables for both the register and the network make the VSI-Pro Max Plug and Play as a standalone or an addition to any existing AVE interface installation.

### MASTER COMMUNICATION PROTOCOL

#### OPERATION

The VSI-Pro Max or Hydra/Regcom/Vnetworker/Networker use a bi-directional, 2-wire RS-485 databus to communicate. A VSI-Pro Max can be a Slave or a Master. A Regcom, Vnetworker or Networker are used to convert the VSI-Pro, ECR Cards or Adapters to be slaves. The Hydra is a "Master" device and only one unit required for up to 16 Slaves. Only one master device can exist on a single network. When the VSI-Pro Max is used to connect to a register that uses the emulate mode then it can not be a Master. However the VSI-Pro Max can connect to a normal register in tap mode and still be configurable as a master or slave.

The master device controls the flow of data by polling each of the slaves in turn. When polled, a slave device will either respond with a "No Data" code to say it has no data to send, or it will begin sending data from its buffer.

The Hydra or VSI-Pro Max can support many manufactures of DVR for direct storage of the transaction data on the DVR as a file rather than just inserting in the video image for recording. It also supports the VSI-ADD (VSI Addressable) format which allows multiple VSI-Pros or VSI-Pro Max to be mounted in a convenient rack and connected to a Master for display of cash register data remotely. See Figure below.

#### HYDRA COMPATABILITY LIST

##### DVR

- Norbain Columbus
- GE StoreSafe
- Kalatel StoreSafe
- NOVAR VP
- Dallmeier
- Appro
- Pinetron

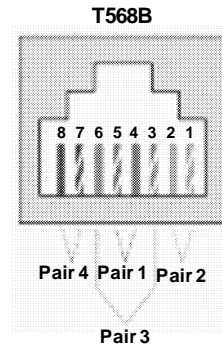

Figure 133 : RJ45 Network Connector Pin Out

The Network Port of a VSI-Pro Max, Regcom or Hydra use an RJ45 connector. Each unit has two RJ45s and the Networking signals Pins 4&5 are in parallel. However in the VSI-Pro Max all pins are wired in parallel but the Regcom or Hydra are not. The useage of an RJ45 connector allows the installer to use either RJ11, RJ12 or RJ45 connectors since all support the center two pins of the connector which are the only pins used.



Figure 134: DS-20-OF VSI-Pro Max PCB Rack using VSI-ADD protocol



**VSI-Pro Max Networking**

The VSI-Pro Max as a slave allows the connection of multiple cash register terminals to a master unit for the purpose of transaction logging.

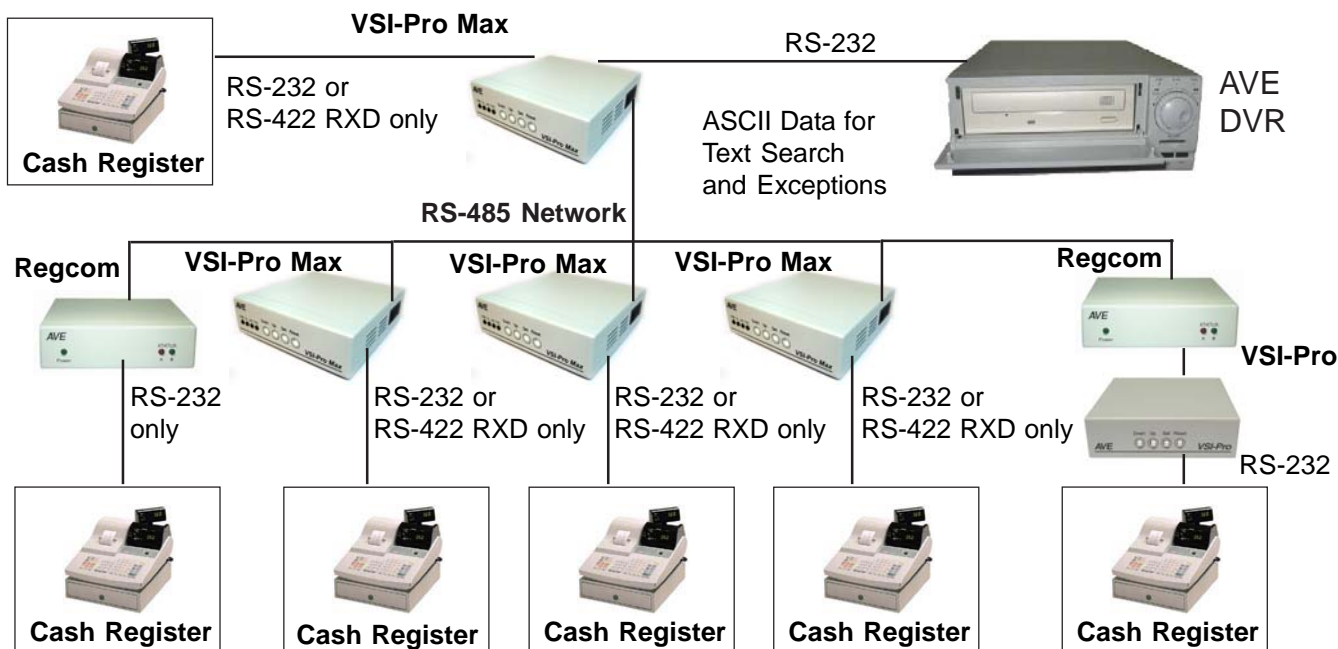

Figure 135: VSI-Pro Max Networking Connection Diagram

**NETWORK TERMINATION**

The device at end of the network must be "TERMINATED". For the Hydra an 8 DIP Switch on the rear of the unit is used to set the termination. When the switch is set to "ON", the device is terminated. When the switch is set to "OFF", it will be un-terminated. For the VSI-Pro Max an internal jumper JP15 must be set to terminate.

**DB-9 Pin-Out**

Pin 1	Alarm 1
Pin 2	To Register
Pin 3	TXD (Master)
Pin 4	DTR
Pin 5	Ground
Pin 6	DSR
Pin 7	RTS
Pin 8	CTS
Pin 9	Alarm 2

**DB-9 Pin-Out**

Pin 1	
Pin 2	RX ( RS-232 )
Pin 3	TX ( RS-232 )
Pin 4	
Pin 5	Ground
Pin 6	
Pin 7	
Pin 8	
Pin 9	

**RJ-45 Pin-Out**

Pin 1	
Pin 2	
Pin 3	
Pin 4	RS-485 ( + )
Pin 5	RS-485 ( - )
Pin 6	
Pin 7	
Pin 8	

Table 7: RJ-45 Pin-Out

Table 5 : VSI-Pro Max Master Output Table 6: Hydra DB-9 Pin-Out



RS-485 NETWORK DATA CABLE WIRING

(120 Ohm impedance, twisted pair)

RJ-45	RJ-45
Pin 4	Pin 4
Pin 5	Pin 5

Table 8: RS-485 Network Data Cable Wiring

RS-232 Parameters

Baud rate	9600 or 57.6K
Data bits	8
Parity	None
Stop bits	1

Table 9: Hydra RS-232 Parameters

LED STATUS INDICATION

Status light A illuminates whenever data is sent from the Regcom to the master unit. This is the same as Network LED on the VSI-Pro Max.

Status light B illuminates to indicate the Regcom is correctly connectly connected via the RS-485 network to the master unit. This is the same as the Register LED on the VSI-Pro Max

Network Parameters

Standard	RS-485
Max line length	4000 ft
Cable type	120 Ohm twised pair

Table 10: Network Parameters



Figure 136: VSI-Pro Max Front Panel

Figure 137: Hydra / Regcom Front Panel

Figure 138: Hydra / Regcom Rear Panel

Dipswitch Settings

The following are the rear dipswitch settings for both the Regcom and Hydra. SW1-5 select the address for the Regcom and the communication parameters for the Hydra. SW6 has no function. SW7 has no function for the Hydra but selects Baud rate for the Regcom On- 57.6K, Off 9600 baud. SW8 terminates either device with 120 ohms and should be on for the Hydra and on for the last Regcom in the network.

Regcom Address	SW1	SW2	SW3	SW4	SW5	SW6	SW7	SW8	(Note) Term On/Off Input	Hydra Functions
---	Off	Off	Off	Off	Off	Off	----	----	Regcom	VSI-ADD 9600 baud
1	On	Off	Off	Off	Off	Off	----	----	Vnetworker	Vnetworker
2	Off	On	Off	Off	Off	Off	----	----	Vnetworker	MVDR3000/5000
3	On	On	Off	Off	Off	Off	----	----	Regcom	Dallmeier Addr 1-8
4	Off	Off	On	Off	Off	Off	----	----	Vnetworker	Dallmeier Addr 1-8
5	On	Off	On	Off	Off	Off	----	----	Regcom	VSI-ADD 57.6K baud
6	Off	On	On	Off	Off	Off	----	----	TBD	
7	On	On	On	Off	Off	Off	----	----	TBD	
8	Off	Off	Off	On	Off	Off	----	----	TBD	
9	On	Off	Off	On	Off	Off	----	----	TBD	
10	Off	On	Off	On	Off	Off	----	----	TBD	
11	On	On	Off	On	Off	Off	----	----	TBD	
12	Off	Off	On	On	Off	Off	----	----	TBD	
13	On	Off	On	On	Off	Off	----	----	TBD	
14	Off	On	On	On	Off	Off	----	----	TBD	
15	On	On	On	On	Off	Off	----	----	TBD	
16	Off	Off	Off	Off	On	Off	----	----	TBD	

Table 11: Hydra / Regcom Dipswitch Settings



### AVE POS Networking Protocol (VSI-ADD Protocol)

The AVE VSI-Pro Max, IF ECR Interface Cards and other POS Adapters export the POS data in formatted ASCII text via RS-232 directly. This data can be read by any DVR Com Port for recording as a separate data file appended to the Audio/Video file.

For multiple POS on one DVR you could use multiple RS-232 ports but this is cumbersome and the length of runs is limited.

The VSI-Pro Max in the Slave mode or the "Regcom" device connects directly to any of the AVE POS interfaces listed above or any RS-232 source. This buffered device takes the POS data and converts it to an RS-485 network.

The "Networker" connects only to the older VSI-Pro and supports the same RS-485 network. This network is terminated by a "Hydra" or a VSI-Pro Max in the Master mode which decodes the RS-485 network and sends all the data to one RS-232 Com Port on the DVR.

The data from the Master device to the DVR Com Port has the following data format:

**<ESC> ADDR {TEXT TO BE DISPLAYED}**

Where ESC is 1BH; ADDR is one byte binary code. The valid address is 1 through 16.

The DVR will then read this protocol and decode the proper POS interface data to be associated with the respective camera.

#### Network Protocol

For advanced interfacing a DVR may directly control the RS-485 Regcom Network by implementing the full poll/select protocol. For more information on this contact the AVE factory.

The latest in the development of RS-485 networking is called the Vnetworker Protocol. This is an enhanced poll/select protocol that allows the remote master to program and control the remote VSI-Pro Max or VSI-Pro with Vnetworker device. Not only will this allow transaction logging but allow reading Alarm inputs, setting/reading/locking to T/D and full programming and register configuration remotely. Implementation of this protocol brings seamless POS /Cash Register / ATM interfacing to the AVE or 3rd party DVR suppliers. For more information on this contact the AVE factory.

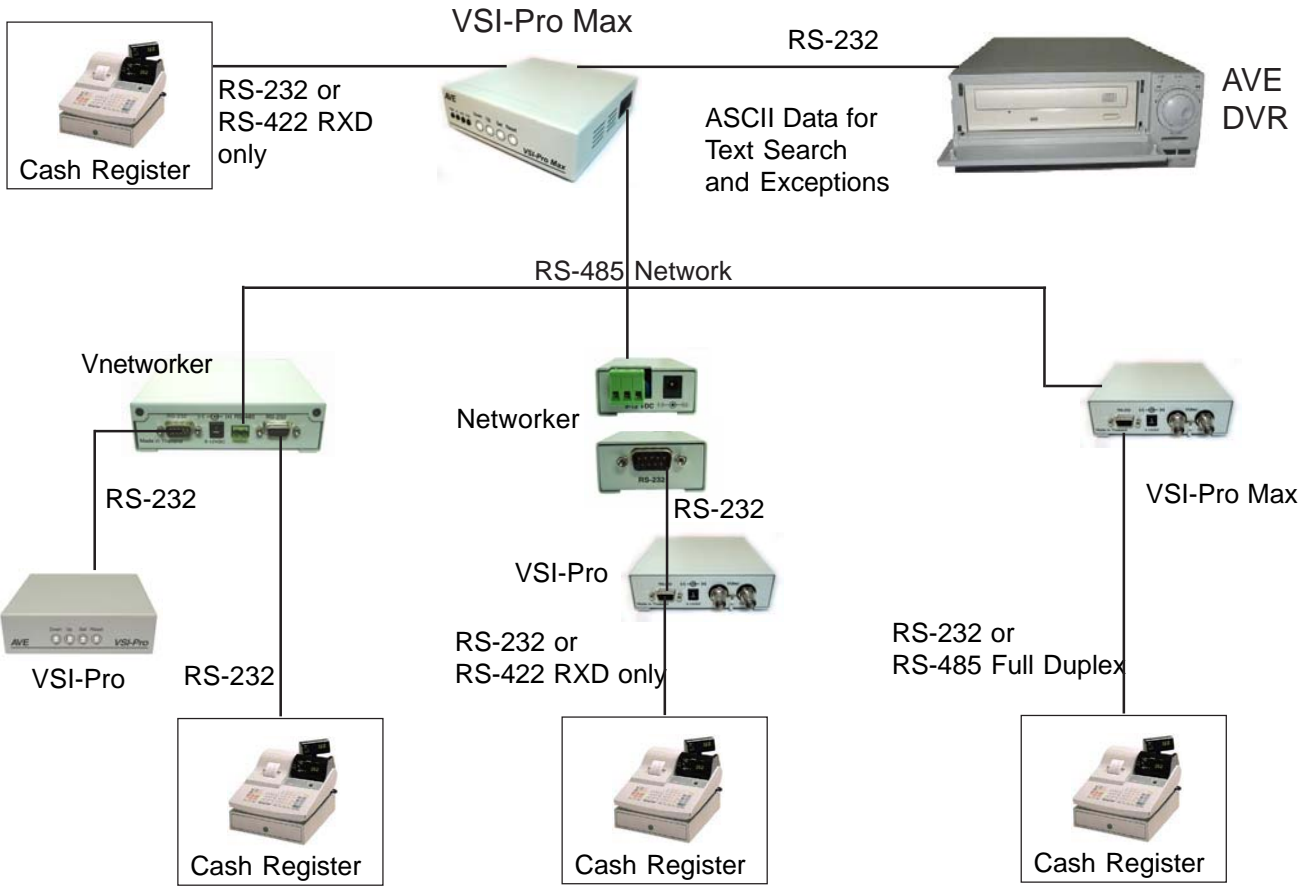

Figure 139: VSI-Pro Max Vnetworker Connection

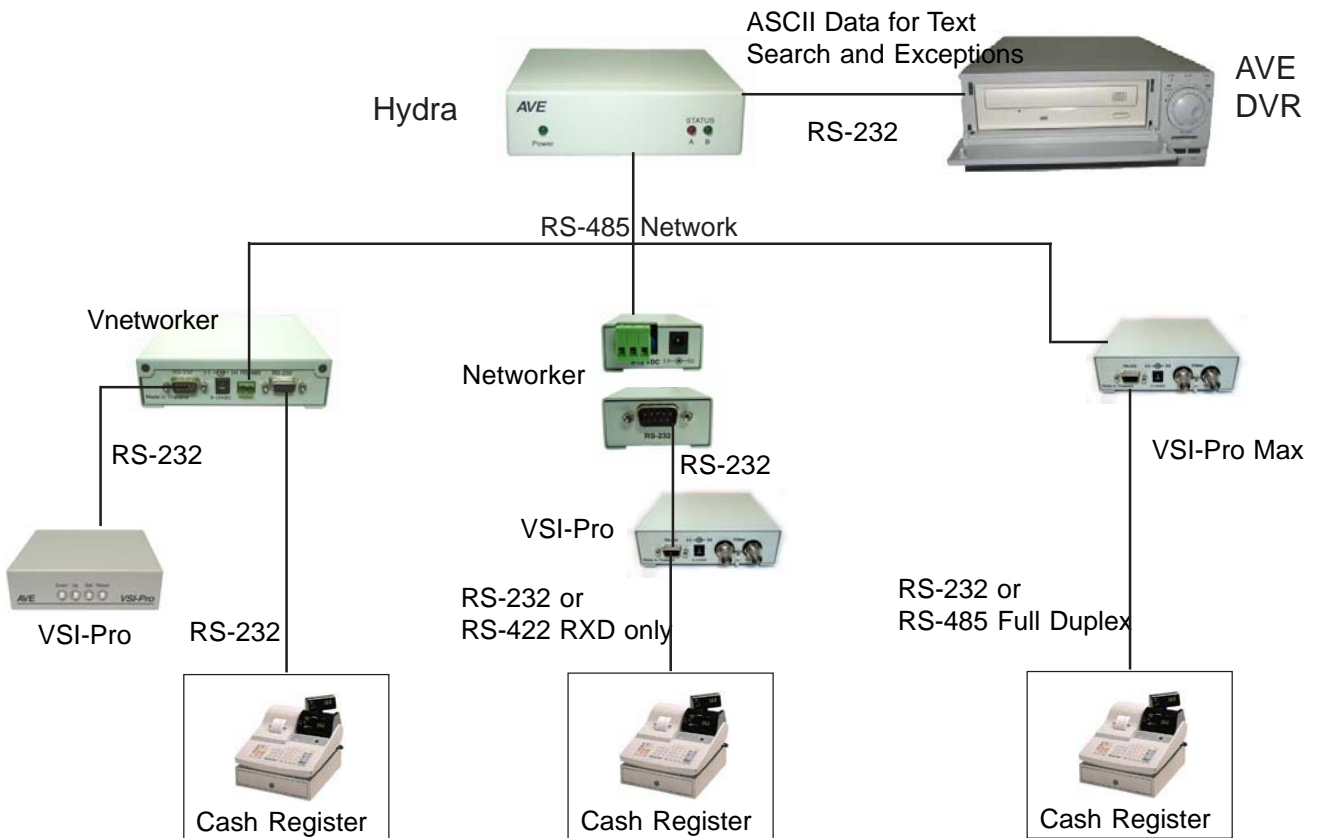

Figure 140 : Hydra Vnetworker Connection



Introduction

The Vnetworker Software can communicate directly with a VSI-Pro Max or a VSI-Pro with Vnetworker or a VSI-Pro with Networker and connects to the Cash Register. The VSI-Pro Max or Vnetworker or Networker take the RS-232 or RS-485 data from a cash register and puts it on a common RS-485 network and sends it back to a PC. This network supports up to 64 cash registers. The Vnetworker software is able to program the VSI-Pro Max or VSI-Pro with Vnetworker remotely along with gathering the transaction or exception data. The VSI-Pro with Networker can only send back the transaction data. The VSI-Pro must be Ver. 13.00 or 13.24 and Release 12 or higher. Any VSI-Pro Ver. 13.00 or 13.24 can be upgraded with a uP software change for the hardware of the VSI-Pro remains the same.

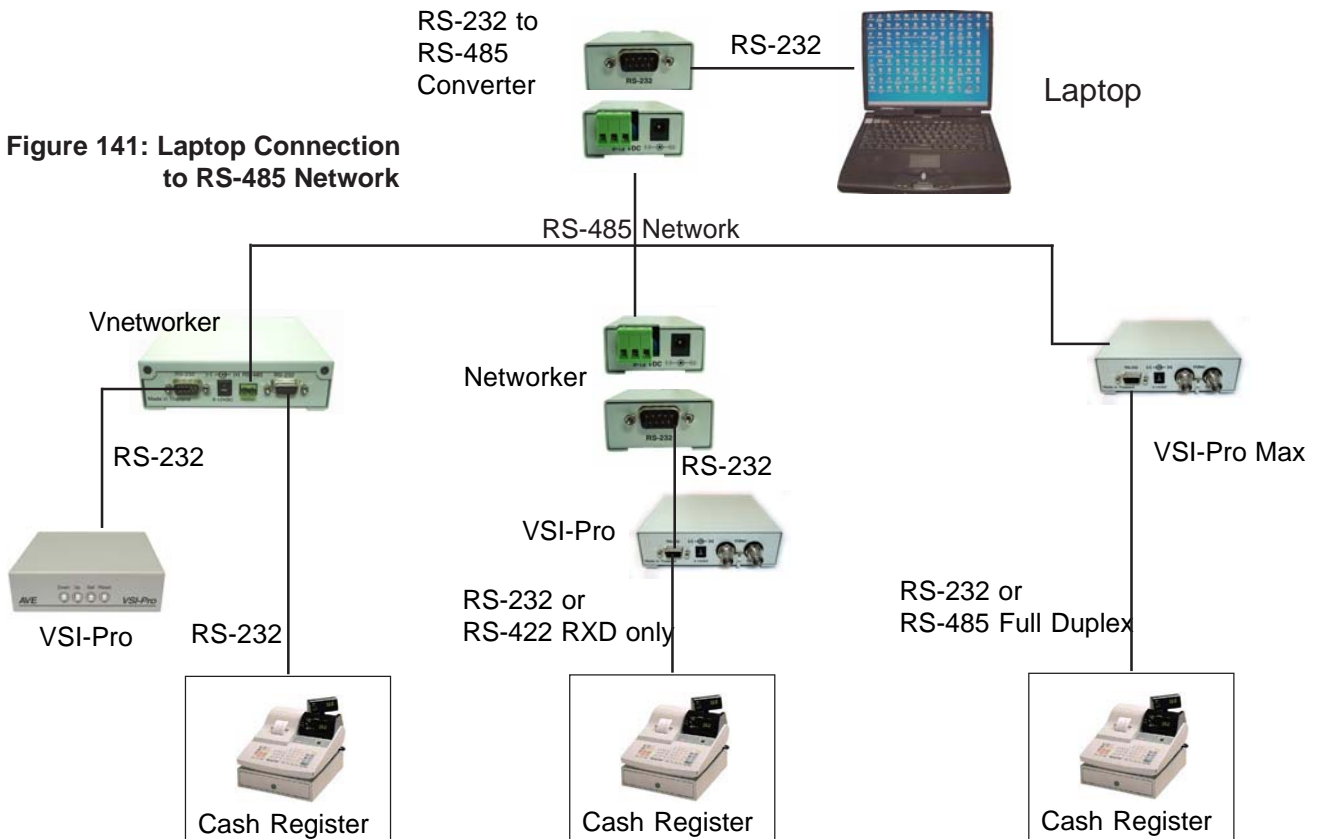

Figure 141: Laptop Connection to RS-485 Network

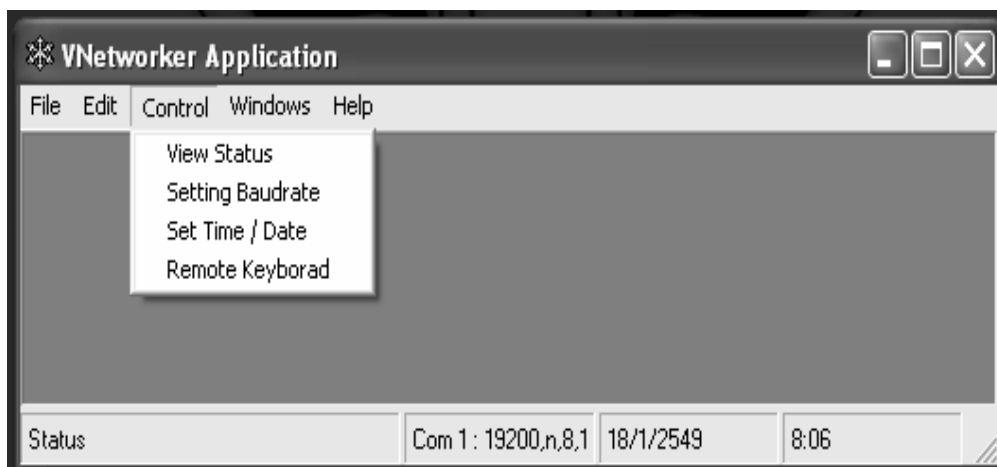
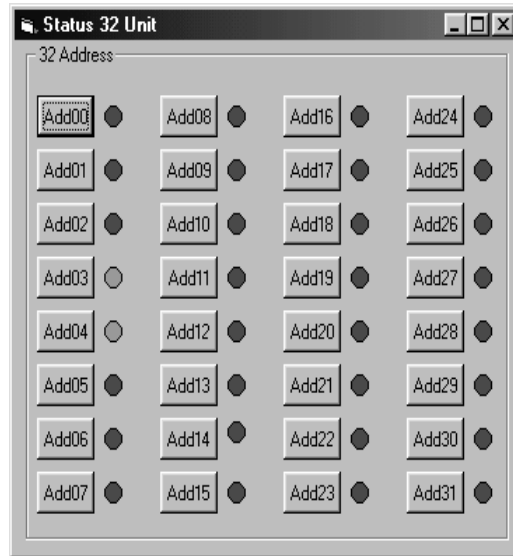

Figure 142 : Vnetworker Main Menu

### View Status

Pull Down the Window to select ComPort and select 32 Address when using less than 32 registers and select 64 if using more than 32 registers.



The **Green** Led is indicated when a Networker is Detected.  
The **Red** Led is indicated no Networker at that Address.

Figure 143: Status Display

### Windows

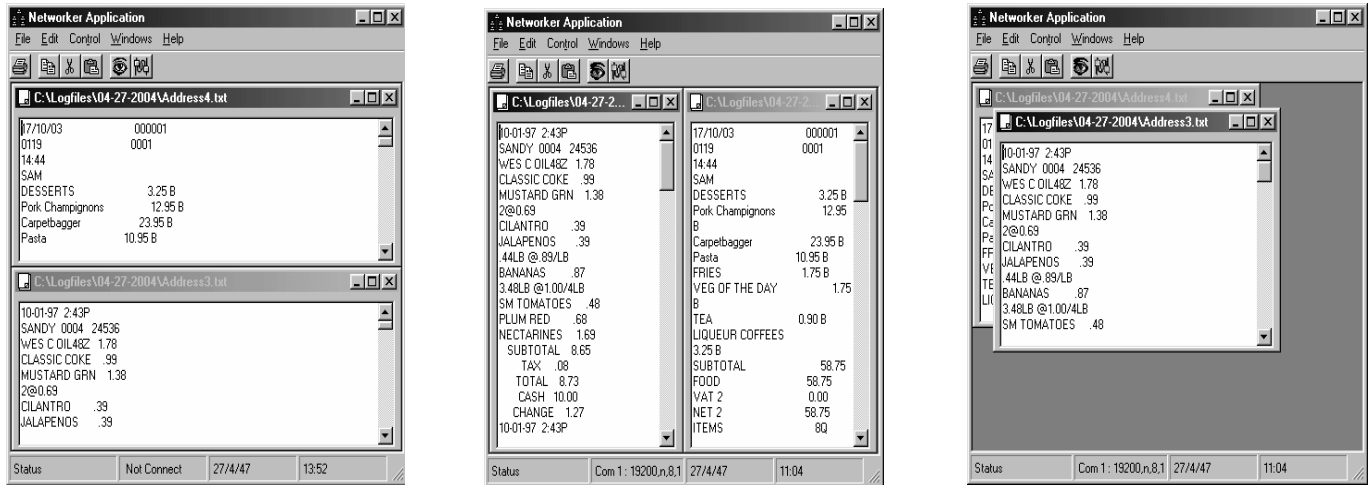

Windows Tile Horizontally

Windows Tile Vertically

Windows Cascade

Figure 144: Window Tile Options

### Files:

C:\Logfiles directory contains all the files with the name extension Address1.txt, Address2.txt, etc corresponding to the address of the Networker. These files are updated continuously. If you copy and then delete the file, a new log file will be created with the same number as new data is recieved. Viewing the files is updated every 2 seconds.



## Remote Keyboard

This function allows the user to select the appropriate VSI-Pro Max on the network with the Select Address setting. Once this is done you then click "Programming". The Vnetworker will then signal the VSI-Pro to exit the register interface mode and go to the programming mode. **Note:** While in this mode all data from the cash register will not be stored or displayed in the VSI-Pro and will be lost.

After a brief pause, communication is established with the VSI-Pro and the following menu will be displayed. This is the same as the on-screen menu and using the "Up", "Down", "Enter" buttons you can navigate the VSI-Pro menu just like at the local pushbuttons.



Figure 145 : Remote Keyboard

### Control Button

- Programming
- Up
- Down
- Enter
- Erase Character
- Save String Input
- Reset

### Address Select :

You should select the address for Programming, then press the Programming Button

The new menu items are “Set Time / Date” and “Remote Keyboard”.

The “Set Time / Date” functions allows you to set this value from the PC Time/Date or manually enter yourself. Select ID sets the address value of the appropriate VSI-Pro on the network you wish to up date.

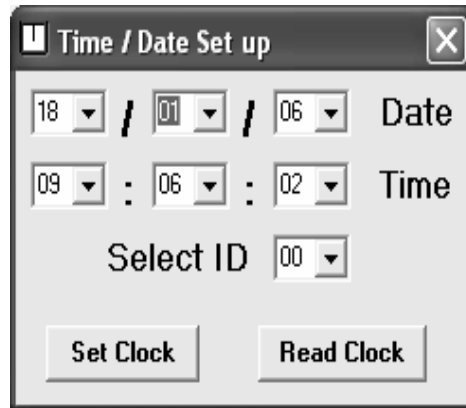

Figure 146 : Time / Date Set up Menu

APPENDIX N

AL-16 Alarm Output Adapter

Trigger Text not only sends out printable data for the user to be notified visually or markers for the DVR Text Search function but also can send out special Control Characters or Escape Sequences. The AVE AL-16 accepts commands to trigger independent Form C Relay contacts via RS-232 communication. Therefore the proper command sequences can be programmed into the Trigger Text and sent to this device upon alarm or exception. This will expand the number of hard alarm outputs of the VSI-Pro or VSI-Pro Max to the maximum of 16. This allows simple wire connection to presets of PTZ, gate openers, lights, IR illuminators and any other external device that needs to be controlled by the powerful exception and alarm processor of the VSI-Pro Max.



Figure : AL-16 RS-232 & Power Connector



Figure : AL-16 Relay Output Connectors

NOTES



### PTZ Control

Trigger Text not only sends out printable data for the user to be notified visually or markers for the DVR Text Search function but also can send out special Control Characters or Escape Sequences. PTZ commands for homing to preset positions are very common. When using a PTZ dome to monitor more than one POS / Cash Register the VSI-Pro Max can be programmed to send out a homing preset string via RS-485 to the PTZ controller upon an exception. Therefore the dome will then home to that particular register and view the exception in progress. Multiple VSI-Pro Max can be paralleled on the RS-485 since in the receive mode until the exception occurs.

In gasoline or petrol stations the same function is very useful. One PTZ can cover several pumps. When a customer slides his credit card or activates the pump the VSI-Pro Max can send out the homing preset string for the PTZ and capture images of the user and vehicle for every transaction. This will allow close up images of each transaction from one camera rather than many fixed cameras.

### Cash Drawers, Safes and Security Doors

The RTS Alarm Input can be programmed to be a generic Hard Alarm input. This can be connected to a Cash Drawer and alarmed when the drawer is open. With the RTS Alarm Delay feature a time can be programmed to wait for this alarm to be true longer than that time and then trigger the alarm. This is very powerful to detect when cash drawers or safes are open for an excessive amount of time which is indicative of theft practices.

The RTS Alarm input can also be connected to entry and exit doors and generate alarm conditions when the door open too long. This in conjunction with the Trigger Text can send specific text data to the DVR upon this condition so later the DVR database can be searched for such events. Therefore hard alarms in conjunction with user programmed data strings provide powerful search criteria for exceptional events.

### Access Control Panels

The VSI-Pro Max can be connected to read the data coming directly from an access control panel or to the server. The VSI-Pro Max has RS-485 or RS-422 compatibility along with RS-232 in passive mode which can be connected in parallel with most access panels with no effect on transmission to the server. The VSI-Pro Max can then be programmed for a specific user ID and generate alarm or exception conditions and alerts when they enter. It also can deliver an e-journal of all entries directly to the database of the AVE DVRs and then later search directly to a user name or specific Time & Date.

### VMD and Cash Registers

In a normal check out lane if motion is detected in the customer area but no motion in the clerk area this is a potential problem. If this exists and the cash drawer is opened or a transaction is detected by the VSI-Pro Max then this is indicative of a theft. Many VMDs like the DigiSpec DS1-PL has logic on the alarm input to the VMD so it can be connected in series with the VSI-Pro Max alarm output functions detecting cash drawer open or transactions being entered. Therefore a single camera with this type of VMD can detect motion in several areas independently with one camera view and combined with the VSI-Pro Max to detect these types of situations.

### NOTES

---

**LIMITED WARRANTY*****(Terms and Conditions)***

For **2 Years** from the date of shipment, Seller warrants to Buyer that the Product is free from defects in material or workmanship **under normal use and service**. Equipment manufactured by other than Seller but furnished by Seller carries the same warranty to Buyer as Seller receives from the other manufacturer, notwithstanding any provision to the contrary. If Buyer has specified a particular manufacturer's product which is not the brand standardly supplied by Seller, Buyer shall look only to the other manufacturer's warranty and Seller shall not warrant such item.

***EXCLUSIONS. Seller's warranty does not cover the following :***

1. In-transit damage claims, improper handling by carrier or post office.

***(Only the consignee of the shipment can file a claim with the common carrier.)***

2. Damages caused by incorrect use, modification, carelessness, improper storage, hostile operating conditions, or unauthorized service, installation or repairs without proper training from the Seller.
3. Damages caused by fire, flood, lightning, collision, acts of God or other events beyond the control of Seller.
4. Products or parts thereof that have had serial numbers removed, altered or defaced.
5. Products returned without an RMA number and sales or delivery receipt showing the date of original purchase.
6. Use of components that do not meet Seller's specifications.
7. External parts such as cabinets or keypads.
8. Periodic maintenance and adjustments resulting from normal use.

***WARRANTIES EXCLUDED, SELLER EXPRESSLY DISCLAIMS AND EXCLUDES ANY EXPRESS OR IMPLIED WARRANTY OR MERCHANTABILITY OR FITNESS FOR A PARTICULAR PURPOSE WHICH EXCEEDS OR IS INCONSISTENT WITH THE WARRANTY HEREIN EXPRESSLY SET FORTH.***

***NON-WARRANTY CLAIMS***

In the event Buyer makes a warranty claim and Seller's warranty does not apply, Buyer shall reimburse Seller for all reasonable expenses incurred by Seller in diagnosing the installation/repair problem.

***BUYER'S EXCLUSIVE REMEDIES***

If the Product supplied shall fail to conform to the contract or any applicable warranty, Buyer shall immediately notify Seller of such condition and afford Seller a reasonable opportunity to inspect said Product. Seller shall, at its option, either repair or replace such nonconforming Product. Seller shall not be responsible for labor charges for removal or installation of such equipment or material or charges for transportation, handling and shipping except as provided in Seller's written service policy. No Product shall be returned without Seller's prior written consent.



**SELLER SHALL NOT BE LIABLE FOR ANY SPECIAL, DIRECT INCIDENTAL OR CONSEQUENTIAL DAMAGES OF A COMMERCIAL NATURE ARISING OUT THE USE OF OR INABILITY TO USE SELLER'S PRODUCT BY REASON OF THE FACT THAT SUCH PRODUCT DOES NOT CONFORM TO THE CONTRACT OR TO ANY EXPRESS OR IMPLIED WARRANTY. SELLER'S MAXIMUM LIABILITY SHALL BE LIMITED TO THE COST OF REPAIR AND/OR REPLACEMENT OF THE PRODUCT CLAIMED TO BE DEFECTIVE OR NONCONFORMING, SUBJECT TO SELLER'S RIGHT OF REMOVAL AND RETURN OF PRODUCT.**

All of the foregoing constitute Buyer's sole and exclusive remedy and Seller's sole and exclusive liability for supplying nonconforming or defective Product.

### **RETURNS**

AVE products are fully inspected and carefully packed to ensure you are delivered a quality product in good condition. If you are not fully satisfied with our product, returns of standard stocking items with no restocking fee can be made within thirty (30) days of invoice to Buyer. All such returns must have prior consent of Seller by obtaining an RMA number and must include the sales or delivery receipt showing the date of original purchase and be in an unused condition contained in its original packaging. Any other returns must have prior written consent of Seller and are subject to a restocking fee of fifteen percent (15%) and freight charges.

### **RMA NUMBER**

The RMA (Return Material Authorization) number must be obtained by contacting Seller prior to the shipment of the product for return. The RMA number is valid only for 15 days from the date of issue. The RMA number must be clearly displayed on all shipping labels.

### **MASTER RESET**

### **APPENDIX Q**

## **WARNING!**

**DOING A MASTER RESET CLEARS ALL PROGRAMMING AND THE VSI-Pro Max DEFAULTS TO THE FACTORY SETTINGS.**

If you have difficulty entering the main-menu or you changed uP or updated the Firmware in your VSI-Pro Max, do the following procedure exactly: Lightly press and hold in the 3 buttons to the left ("Up", "Down" & "Set"). While holding down these buttons, press and release the "Reset" button. Then release the other buttons. Wait a few seconds and the copyright notice will appear on-screen along with the version of software installed in your VSI-Pro Max.

Upon powering up the VSI-Pro Max for the first time, if the battery is depleted the master reset should be done. However in some cases the Time/Date display may not have the correct or legible characters. If this occurs, go to the Clock programming section of the menu and reset the clock and program the correct time. The Time/Date display will then function properly and any subsequent master resets will not affect the time.

The internal rechargeable NiMH battery needs a full 24 Hr charge if fully discharged to be fully charged.





#### **ASIA**

##### **AVE Thailand Co., Ltd.**

147 Soi On-Nut 44  
Sukhumvit 77 Rd., Suan Luang  
Bangkok, 10250 Thailand  
Tel: 662-331-9364, 331-9285  
Fax: 662-331-9365  
Email: [ave@avethailand.com](mailto:ave@avethailand.com)  
[www.avethailand.com](http://www.avethailand.com) (English)  
[www.ave.co.th](http://www.ave.co.th) (Thai)

#### **NORTH AMERICA**

##### **American Video Equipment (AVE)**

2000 West Governors Circle, Suite E  
Houston, Texas 77092  
Tel: 281-443-2300  
Fax: 281- 443-8915  
Email: [aveus@ave-us.com](mailto:aveus@ave-us.com)  
[www.americanvideoequipment.com](http://www.americanvideoequipment.com)

#### **WESTERN EUROPE**

##### **AVE Multiview**

Unit 1C, The Potteries,  
Woodgreen Road, Waltham Abbey  
Essex, EN9 3SA, UK  
Tel: 440-870-770-9323  
Fax: 440-870-770-9363  
Email: [ave-uk@multiview.net](mailto:ave-uk@multiview.net)  
[www.multiview.net](http://www.multiview.net)

## Free Manuals Download Website

<http://myh66.com>

<http://usermanuals.us>

<http://www.somanuals.com>

<http://www.4manuals.cc>

<http://www.manual-lib.com>

<http://www.404manual.com>

<http://www.luxmanual.com>

<http://aubethermostatmanual.com>

Golf course search by state

<http://golfingnear.com>

Email search by domain

<http://emailbydomain.com>

Auto manuals search

<http://auto.somanuals.com>

TV manuals search

<http://tv.somanuals.com>