



INSTALLATION & OPERATING MANUAL

Digital Video Recorder MV-DR4000



AVE









MULTI*view*

Before trying to connect or operate this product, please read this manual completely

SAFETY PRECAUTIONS



All the following safety and operated instructions which will prevent harm or damage to the operator and other persons should be read before the unit is operated.

WARNING

-  To reduce the risk of fire or electric shock, do not expose this appliance to rain or moisture.
-  Do not block ventilation openings.
-  Do not place anything on top of the unit that might spill or fall into it.
-  Do not attempt to service this unit yourself as opening or removing covers may expose you to dangerous voltage or other hazards. Please refer all servicing to qualified service personnel.
-  Do not use liquid cleaners or aerosols for cleaning.
-  This installation should be by a qualified service person and should conform to all local codes.
-  To prevent fire or electric shock, do not overload wall outlets or extension cord.
-  This unit must be grounded to reduce the risk of electric shock hazard.

CAUTION

Danger of explosion if the Lithium battery (RTC Battery) is incorrectly replaced.

-  Danger of explosion if battery is incorrectly replaced. Replace only with the same or equivalent type recommended by the manufacturer. Dispose of used batteries according to the manufacturer's instructions.
-  Risk of explosion if replaced by an incorrect type. Dispose of used batteries according to the instructions.

INFORMATION

This equipment has been tested and found to comply with the limits for a Class A digital device, pursuant to Part 15 of the FCC Rules. These limits are designed to provide reasonable protection against harmful interference when the equipment is operated in a commercial environment. This equipment generates, uses, and can radiate radio frequency energy and, if not installed and used in accordance with the instruction manual, may cause harmful interference to radio communications. Operation of this equipment in a residential area is likely to cause harmful interference in which case the user will be required to correct the interference at his/her own expense.

Table Of Contents

1. PRODUCT FEATURES	4
1.1 Product Introduction	4
1.2 Product Features	4
2. DESCRIPTION OF THE FRONT/REAR VIEW.....	5
2.1 Front View	5
2.2 Rear View	8
2.3 ALARM In/Out	9
3. INSTALLATION	10
3.1 Basic Connection	10
3.2 Hard-Disk Drive Installation	11
3.3 System Information and channel selection.....	12
3.4 Updating System Software	14
4. BASIC OPERATIONS	15
4.1 Configuring Recording Settings.....	15
4.2 Recording Operations	17
4.3 Playback Operations.....	22
4.4 Search Operations.....	24
4.5 Backup Operations.....	27
4.6 Key Lock Operation	31
5. MENU SETUP	32
5.1 REC SETTING	33
5.2 ALARM / MOTION SETTING.....	34
5.3 TIMER/ SEQ/ TITLE	37
5.4 COMMUNICATION	39
5.5 DISK SETTING.....	42
5.6 SYSTEM	42

6. RS-232 & RS-485 PROTOCOL.....	46
6.1 Setup.....	46
6.2 Communication Protocol.....	46
7. IDE HARD DISK INSTALLATION	49
7.1 Built-in hard disk.....	49
7.2 Mobile Rack HDD Installation	50
8. SYSTEM DEFAULT	53
9. O.S.D. MESSAGE	55
10. NETWORK VIEWER AND IMAGE VIEWER.....	56
10.1 The Network Viewer.....	56
10.2 The Image Viewer.....	64
11. INDEX TABLE	65
12. NETWORK CONFIGURATION	66
12.1 Cable Connections.....	66
12.2 Configure Your DVR Network Settings	67
12.3 TCP/IP Communication Software.....	70
12.4 TCP/IP installation	71
12.5 TCP/IP Configuration setting.....	72
12.6 Connection Testing.....	73
13. MICROSOFT INTERNET EXPLORER.....	75
13.1 Connecting the 4CH DVR.....	75
13.2 Change Record / Alarm Setting.....	78
13.3 Change Timer Record Setting	79
13.4 Change Pan/Tilt/Zoom Setting.....	80
14. SPECIFICATIONS	82
APPENDIX 1. –SCANIP	83

1. PRODUCT FEATURES

1.1 Product Introduction

The **MV-DR4000** four channel Digital Video Recorder (DVR) provides high quality storage of up to four video sources. Equipped with a range of comprehensive features, such as video motion detection, pre-alarm recording, thumbnail search, jog/shuttle function, hard drive expansion, and TCP/IP connectivity, this DVR will make your applications far more flexible and effective than ever before.

1.2 Product Features

- * Dual Hard Drive Support. (One Internal, One Hot-Swappable)
- * Pre-alarm image recording.
- * Time-lapse and real-time recording.
- * Refresh rate up to 60 IPS.
- * Image quality selectable at 4 different levels for recording.
- * Event/Timer/Alarm recording mode.
- * Quick search by time, alarm, event, and recording list.
- * Fast and slow playback of recorded video at various speeds.
- * Single-picture playback.
- * On-screen setup menu, title and system timer.
- * Password protection.
- * Disk-full warning and operation status LEDs.
- * RS-232, RS-485 communication port.
- * Remote control via RS-232, RS-485 and Ethernet ports
- * Power interruption recovery.
- * Operation-status record log.
- * Distributing live and recorded images through TCP/IP network environment.
- * Audio recording capability
- * Built-in SD (Secure Digital) memory card slot for image retrieval.
- * Support DHCP protocol.

2. DESCRIPTION OF THE FRONT/REAR VIEW

2.1 Front View

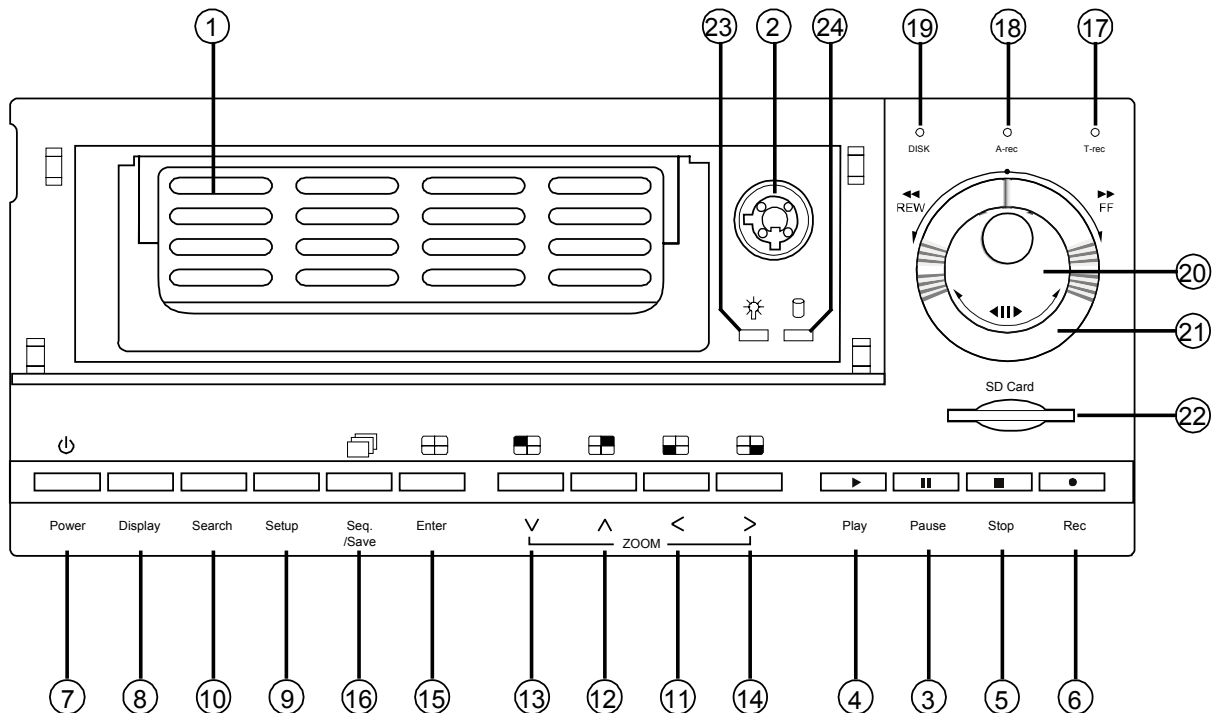

① **Hard-disk drive compartment.**

This compartment houses the removable (hot-swappable) hard disk drive.

NOTE: The compartment must be locked before the hard drive can be used.

② **Hard disk compartment lock:**

The key lock secures a hard disk in place. Unlock the compartment before you remove the hard disk cartridge from the unit.

③ **PAUSE** button:

Press the **PAUSE** button to pause the video during playback. Pressing the **PAUSE** button while in the PAUSE MODE will advance the video by one frame.

The green "PAUSE" LED will be illuminated.

④ **PLAY** button:

Press the **PLAY** button to play recorded video from the hard disk.

The green LED under the "PLAY" button will be illuminated.

⑤ **STOP** button:



Press the **STOP** button to stop the playing of video during playback, or stop recording during a manual record.

The green LED under the "STOP" button will be illuminated.

⑥ **REC** button:

Press the **REC** button to start manually recording video onto the hard disk while viewing live video display mode.

The red LED under the REC button will be illuminated.

- ⑦ **POWER** button:
Press and hold **POWER** button for 3 seconds to turn on the unit, press (and hold again) to turn the unit off.
- ⑧ **DISPLAY** button:
Press to show the system operation status on the screen. (See Section 3.3 for Display indications)
- ⑨ **Setup** button:
Press this to enter the setup menu. Press again to exit the setup mode.
- ⑩ **Search** button:
Press the **SEARCH** to enter the search mode to access recorded video.
- ⑪⑭ **Left / Right (CH3 / CH4)** buttons:
In setup menu/ search mode, use these buttons scroll Left/Right to select desired items in the menu setup mode.
In live mode, use these buttons to select channel 3 or 4 for display.
In play mode, use these buttons to select a channel 3 or 4 as well as zoom in on the desired channel.
- ⑫⑬ **Up / Down (CH2 / CH1)** buttons:
In setup menu/ search mode, use these buttons to scroll Up/Down to select the desired items options for programming.
In live mode, use these buttons to select channel 2 or 1 for display.
In play mode, use these buttons to select a channel 2 or 1 as well as zoom in on the desired channel.
- ⑮ **Enter /  (Quad)** Button:
Press the **ENTER** button to select or enter an item while in the setup menu.
When changing a value within the setup menu, press the ENTER to save the change.
This button also switches to the 4 camera view during live or playback viewing.
- ⑯ **Seq./Save ** button:
In live mode, press to begin sequential switching of the live cameras. The view will rotate through all cameras following the programmed dwell time.
In SD card backup mode, press to save the desired still image to SD card.
- ⑰ **T-rec Indicator:**
This indicator LED will turn ON to signal that the schedule/timer record setting is enabled.
- ⑱ **A-rec Indicator:**
This indicator LED will turn ON to signal that the alarm record setting is enabled.
- ⑲ **DISK Indicator:**
The indicator shows the operation status of the unit's hard-disk drives. The green light indicates the hard-disk drive is storing or retrieving data. The red light signals the hard-disk drive is filling up. The orange light indicates the hard disk is retrieving at disk-full status.
- ⑳ **Shuttle Ring:**
The shuttle ring is used to playback video at different speeds in forward or reverse. Turning the shuttle ring to the left will play recorded video in reverse, turning the shuttle ring to the right will play the video at different speeds in the forward direction.

⑳ **Jog Dial:**

The Jog Dial can be used to step frame by frame in the forward or reverse direction.

㉑ **SD CARD Slot:**

This is used for system software updating and archiving/accessing critical images.

㉒ **Mobile Rack Power LED:**

Indicates the power status of the Mobile Rack. The green light indicates the Mobile Rack is activate.

㉓ **Mobile Rack HDD LED:**

Indicates the HDD status of the Mobile Rack. The orange light indicates the HDD is storing or retrieving data.

2.2 Rear View

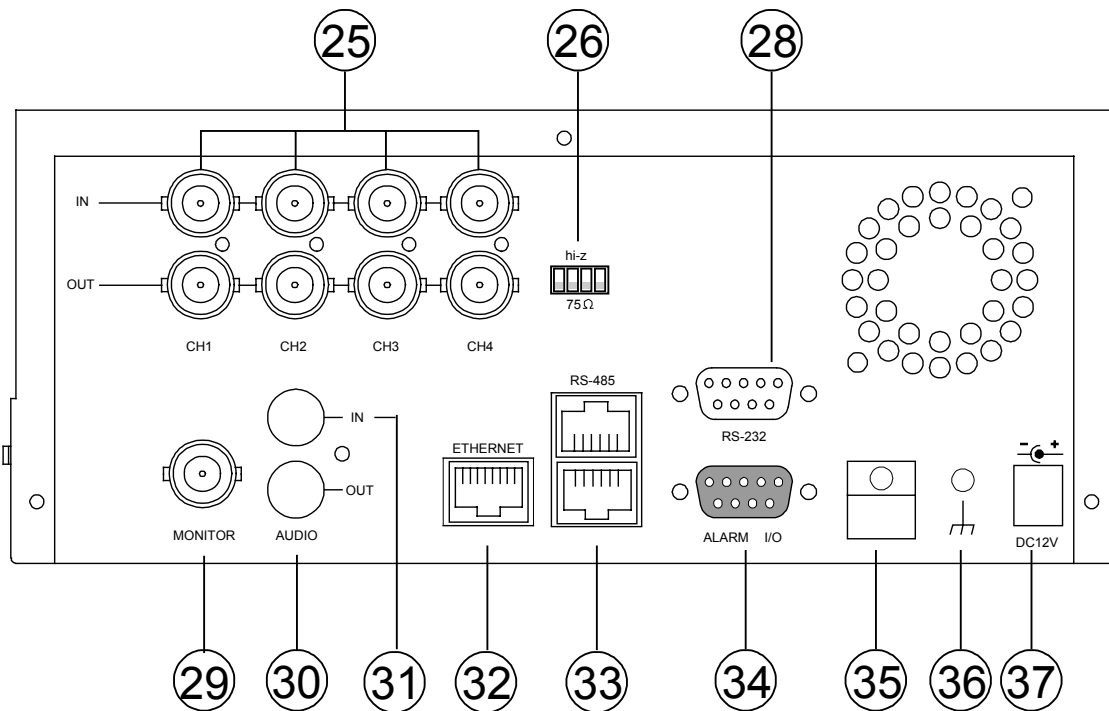

- ②5 **VIDEO IN Connector:** These 4 BNC connectors are used to connect the video output from a camera
- ②6 **Hi-Z/75 Ω Individual termination:** These 4 switches are used to set the impedance of each loop between **75Ω** and **Hi-Z**.
- ②8 **RS-232 Port:** The RS-232 communication port functions as a connector to an external control device. Please refer to **RS-232 & RS-485 Protocol** for more details.
- ②9 **MONITOR Connector:** The connector provides the unit's composite video to a display device.
- ③0 **AUDIO OUT:** This connector is used to connect the device's audio input.
- ③1 **AUDIO IN Connector:** This connector is used to connect the audio output from a camera or other devices to the DVR.
- ③2 **ETHERNET 10/100 Connector:** This is one standard RJ-45 connector for 10/100 Mbps Ethernet networks.
- ③3 **RS-485 Port:** The RS-485 communication ports function as connectors when two or more units are serially connected to an external control device.
- ③4 **ALARM I/O:** This is a 9-PIN D-SUB connector including **SWITCH OUT, GROUND, ALARM OUT, DISK FULL, RECORD IN, ALARM RESET,** and **ALARM IN** for connecting with external devices. Please refer to the next section for details.
- ③5 **Wire Catch:** The wire catch secures the power cord and keeps it in place (so that it does not droop or hang loosely).
- ③6 **Ground Screw's:** The ground screw is for chassis terminal.
- ③7 **DC Power Jack:** The inlet connects to the external power supply. 12 VDC, 5A UL Listed Class 2 Power Supply.

2.3 ALARM In/Out

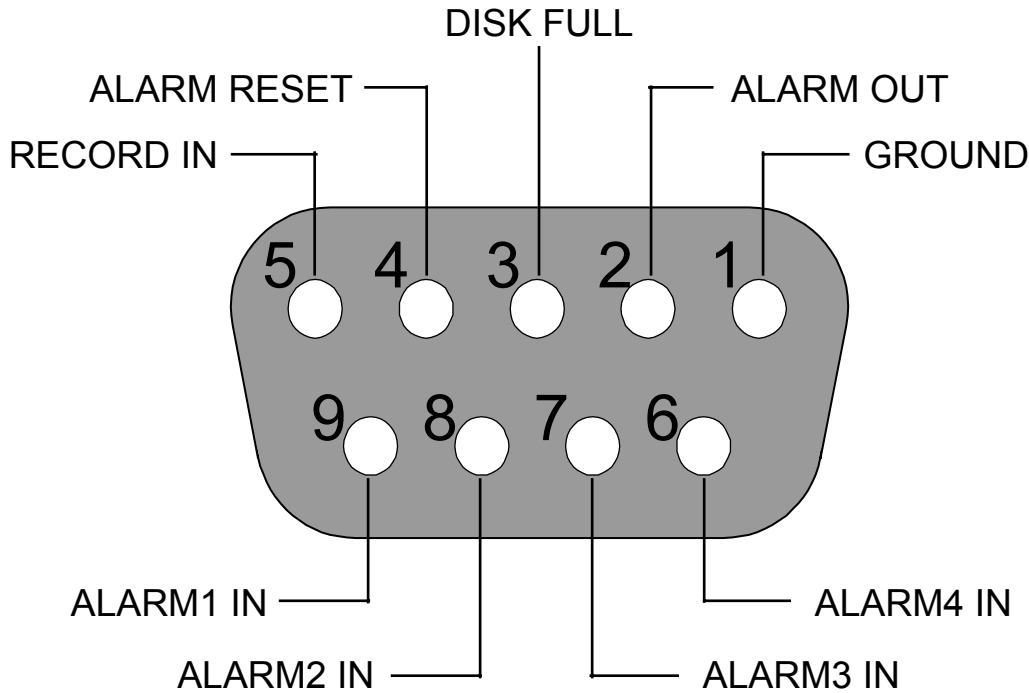

THIS FIGURE IS LOOKED FROM THE REAR VIEW

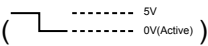
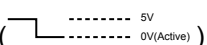
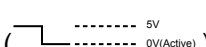
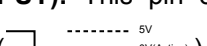
- 1. GND:** Ground Contact.
- 2. ALARM OUT (OUTPUT):** This is a common alarm output trigger. Connect this to external devices such as buzzers or lights. Switches Low (GND) ()
- 3. DISK FULL (OUTPUT):** This is a disk full output trigger. Connect this to external devices such as buzzers or lights. Switches Low (GND) ()
- 4. ALARM RESET (INPUT):** This pin connects to an alarm-clear device for clearing an alarm. Use a Normally Open switch to GND. ()
- 5. RECORD IN (INPUT):** This pin connects to a record trigger device for starting a record. Negative Trigger. ()
- 6. ALARM4 IN (INPUT):** This is an alarm input (for CH 4), which can be programmed in the menu system to Normally Open or Normally Closed operation.
- 7. ALARM3 IN (INPUT):** same as the above, for CH 3
- 8. ALARM2 IN (INPUT):** same as the above, for CH 2
- 9. ALARM1 IN (INPUT):** same as the above, for CH 1

3. INSTALLATION

Please follow the instructions and the diagram below to set up the system.

3.1 Basic Connection

CONNECTING WITH 1 to 4 CAMERAS

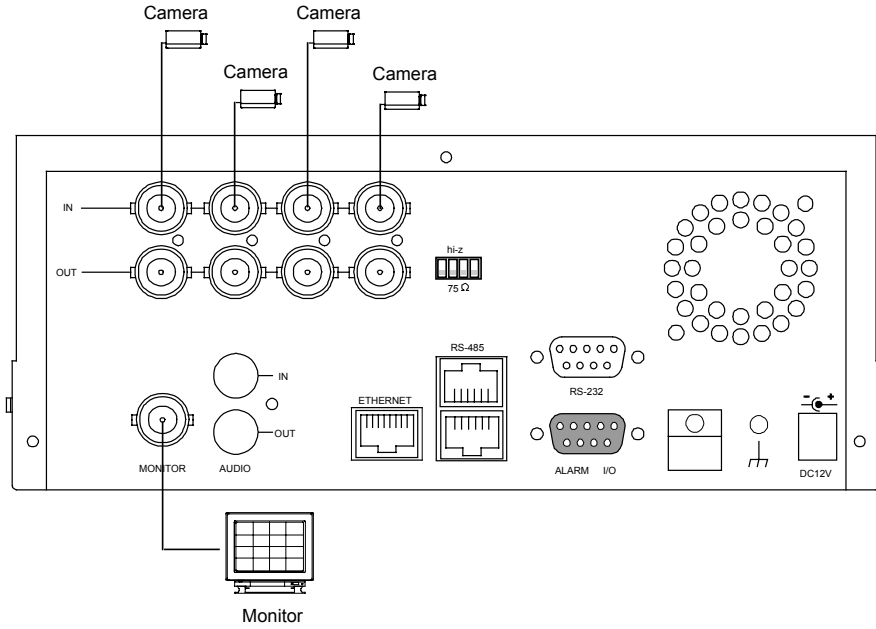

ATTACHING AN EXTERNAL DEVICE TO DVR

Connect an alarm out, alarm input, and a peripheral device as shown in the diagram below.

Alarm In -> Alarm1 In, Alarm2 In, Alarm3 In, Alarm4 In

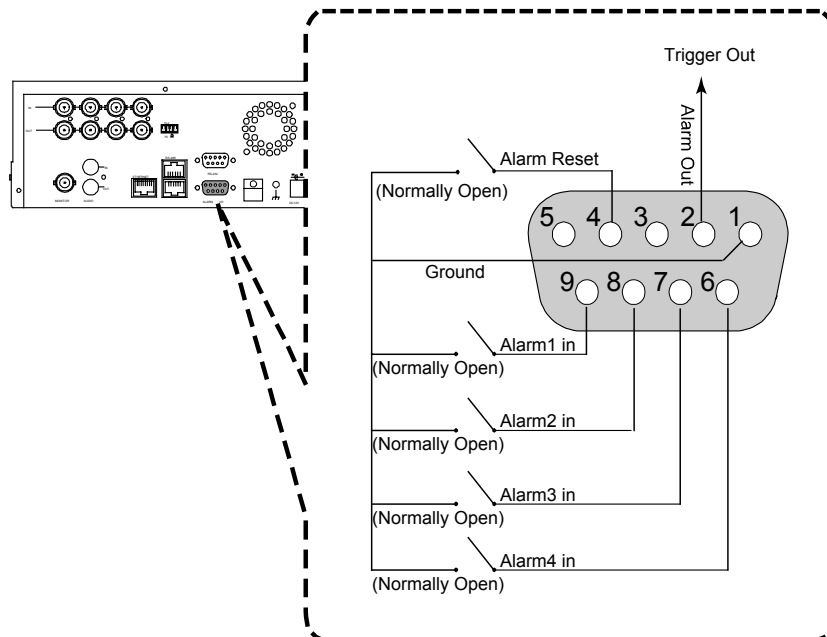

3.2 Hard-Disk Drive Installation

The **MV-DR4000** is capable of supporting two hard drives - One internal drive (from factory) and one hot swappable mobile drive (factory option). The internal HDD (compartment HD1), is default-configured as a master. If adding an additional HDD to the Mobile Rack (compartment HD2), please set to Master and follow the install instructions in section. Arrangement of installed hard-disk drives for the system (Table 3.2 A.) is shown in the tables below.

Table 3.2 A. The jumper settings of hard disk drives in the system

	Location	Jumper
IDE 1	Compartment HD 1	Master (Default)
IDE 2	Compartment HD 2	Master



Table 3.2 B. Compatible hard-disk drives

Manufacturer	Model	Capacity	Rotation
Western Digital	WD800AB	80GB	5400 RPM
	WD1200AB	120GB	5400 RPM
	WD800BB	80GB	7200 RPM
	WD1200BB	120GB	7200 RPM
	WD1800BB	180GB	7200 RPM
	WD2000BB	200GB	7200 RPM
	WD2500JB	250GB	7200 RPM
Seagate	ST380020A/P	80GB	5400 RPM
	ST340810A/P	40GB	5400 RPM
	ST320014A	20GB	5400 RPM
	ST340015A	40GB	5400 RPM
	ST380012ACE	80GB	5400 RPM
	ST3120025ACE	120GB	5400 RPM
Maxtor	4A160J0-1A	160GB	5400 RPM
	4R080L0-1	80GB	5400 RPM
	6Y120L0-1	120GB	7200 RPM
	6Y200P0-1A	200GB	7200 RPM
	6Y250P0-1A	250GB	7200 RPM
SAMSUNG	SV0802N	80GB	5400 RPM
	SV1203N	120GB	5400 RPM

NOTE: Hard-disk drives not shown on this list have not been tested by the engineering team and are not recommended for use with this product. For the latest updated list on the recommended hard disk drives, please contact your dealers or distributors.

3.3 System Information and channel selection

3.3.1 SYSTEM INFORMATION

You can display system settings information as shown on **Figure 3.3 A** below at any time by pressing the **Display** button . In the playback mode, the recorded video information is displayed. In the live or recording mode, the Manual Recording information is displayed. Each sequential press of the **Display** button  displays a different message detailed in the following example. By default, the unit displays titles, time, and date on a monitor as shown next.

Default display

CH 1	CH 2
CH 3	CH 4
09- 05-2003 16:13:02	

CH1 , CH2, CH3, CH4 are titles for each channel, changeable in Setup menu

Capacity Status :

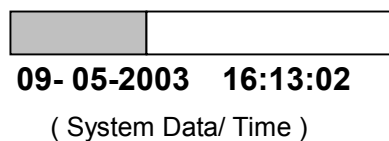



Press the **Display** button  once; the DVR will display the following sample message plus the default display. Press the **Display** button  again; the unit will not display any OSD message. Press the button one more time to back to the default display.

Figure 3.3 A.



Description of Figure 3.3 A

(1+2: 59G): Total capacity of installed hard disks, 59 GB (in this example)

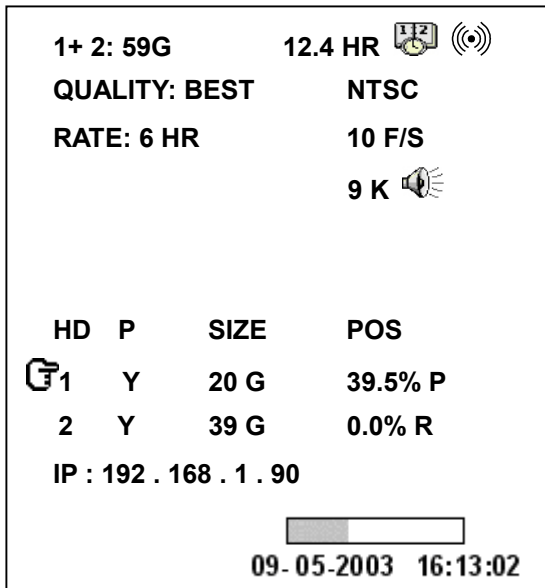
(12.4 HR): Total 12.4 hour recording time available

: Timer record activated

: Alarm record activated

(QUALITY: BEST): Record quality setting, BEST

(NTSC): NTSC system

(RATE: 6 HR): Setting of Record time mode, 6 hours

(10 F/S): Record speed setting, 10 frames/sec

: Audio function activated

: Indicate which HDD is activated

(9K): The image file size

(HD): Hard disk Compartment

(P): **Y** Hard disk installed; **.** No hard disk installed

(SIZE 20G): The capacity of the installed hard disk

(POS): Percentage of system; **R**: Recording; **P**: Playback

(IP : 192 . 168 . 1 . 90): Setting of the Ethernet communication, 192.168.1.90

: External signal

: Disk unavailable

3.3.2 Channel Selection

The CH1, CH2, CH3, CH4, Quad (), and Seq./Save button are used to select the displayed video channels and zoom in factor. The following table shows the functions under different mode.

Mode	Key	Result Display
Live / Record	Quad ()	
	CH1/ CH2/ CH3/ CH4	<input type="checkbox"/> (Single channel)
	Seq./Save	<input type="checkbox"/> → <input type="checkbox"/> → <input type="checkbox"/> → <input type="checkbox"/> → then loop back
Playback	Quad ()	
	CH1/ CH2/ CH3/ CH4	<input type="checkbox"/> (Single channel)
	The same channel pressed the 2 nd time	<input type="checkbox"/> single channel with 2x2 zoom in

3.4 Updating System Software

If the system software of the **MV-DR4000** needs to be upgraded, please take the following steps to safely update it.

Important: Before carrying out the following procedures, please ensure the SD card is working and the file of system software is intact

1. Turn off the 4CH DVR.
2. Insert the SD card into the built-in SD slot of the unit.
3. Hold down the **12 Up** and **13 Down** buttons simultaneously, and then turn on the unit.
4. Keep holding down the buttons until the 4CH DVR sounds a tone and display the message “**XXXXXX BYTES READ**” Now the 4CH DVR is updating the system software, which will take approximately 90 seconds to process.
5. Restart the unit turn off the **7 POWER** button when the device sounds a tone twice and displays the message “**PLEASE RESTART**”. Then turn on the **7 POWER** button. The process is complete.
(If you have already followed the procedure 1~5. the unit, however, not being able to power on. Please first check if the SD card you are using is functioning and the file is intact. And then repeat procedures 1 ~ 5 again.)
6. Verify the version of the system software. (Please refer to section 5.6 VERSION option)

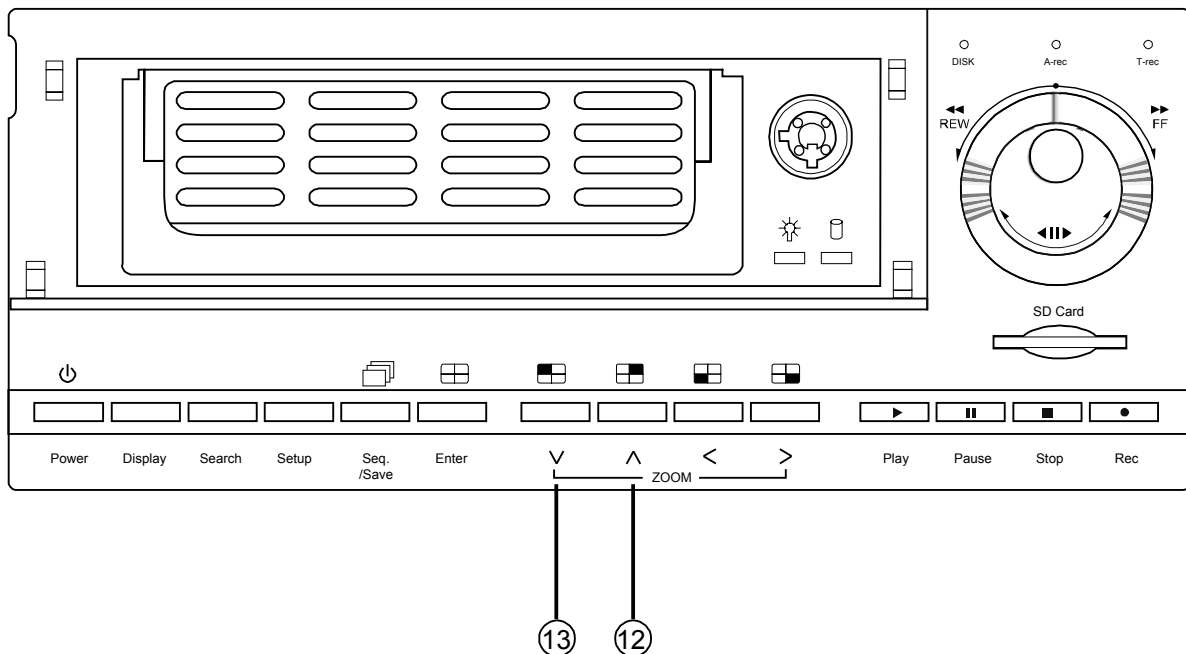

Warning: Don't Interrupt the process while the unit is updating itself. Doing so could cause the unit hang/lock-up.

4. BASIC OPERATIONS

This section outlines the basic operating instructions for the 4CH DVR.

4.1 Configuring Recording Settings

Recording Time settings (Recording Rate and Picture Quality Setting)

Recording time will vary depending on the image size, recording rate, and the capacity of the hard-disk drives. Generally, the DVR comes with a built-in hard-disk drive for continuous recording from one to four weeks under most recording conditions. The table below shows the possible recording times based on a 80GB hard-disk drive at certain refresh rates and the corresponding image quality.

With one or more hard-disk drive(s) in operation, please calculate the recording time using the table below in accordance with your requirement. For a NTSC unit, for example, if the unit is set to record images with **BEST** quality at a **30 Frame/Sec** record rate, normally a 80GB hard-disk drive will be filled in 15 hours (See the gray area in the table). If a 160GB hard-disk drive is used with the same refresh rate and picture quality, it will be filled in 30 hours (2 times the rate of a 80GB hard-disk drive).

NTSC (Audio OFF)		Possible Recording Time HDD=80GB (hour)										
Image Quality	BEST	15	24	36	60	132	301	590	1024	2905	4352	5799
	HIGH	18	29	43	72	152	362	709	1230	3486	5222	6959
	STANDARD	22	36	54	90	198	452	886	1537	4358	6528	8698
	BASIC	30	45	68	113	248	565	1108	1921	5448	8160	10873
Refresh Rate (Frame/Sec)		30	15	10	6	2.7	1.2	0.61	0.35	1/8	1/12	1/16
REC Time Mode		2 hr	4 hr	6 hr	12 hr	24 hr	48 hr	96 hr	168 hr	480 hr	720 hr	960 hr

NTSC (Audio ON)		Possible Recording Time HDD=80GB (hour)										
Image Quality	BEST	-	-	36	59	126	271	485	744	-	-	-
	HIGH	-	-	42	70	150	319	562	846	-	-	-
	STANDARD	-	-	53	87	185	387	668	981	-	-	-
	BASIC	-	-	66	108	228	468	786	1124	-	-	-
Refresh Rate (Frame/Sec)		30	15	10	6	2.7	1.2	0.61	0.35	1/8	1/12	1/16
REC Time Mode		2 hr	4 hr	6 hr	12 hr	24 hr	48 hr	96 hr	168 hr	480 hr	720 hr	960 hr

PAL (Audio OFF)		Possible Recording Time HDD=80GB (hour)										
Image Quality	BEST	3.8	6	9	15	27.1	51.2	99.4	171.8	605.8	907.2	1208.6
	HIGH	4.5	7.2	10.8	18	32.5	61.4	119.3	206.1	726.9	1088.6	1450.3
	STANDARD	5.7	9	13.5	22.6	40.6	76.8	149.1	257.7	908.7	1360.8	1812.9
	BASIC	7.7	11.4	17.1	28.5	51.3	97	188.4	325.5	1147.8	1718.9	2290.0
Refresh Rate (Frame/Sec)		25	12.5	8.3	5	2.7	1.4	0.76	0.44	1/8	1/12	1/16
REC Time Mode		3 hr	6 hr	9 hr	12 hr	24 hr	48 hr	96 hr	168 hr	480 hr	720 hr	960 hr

PAL (Audio ON)		Possible Recording Time HDD=80GB (hour)										
Image Quality	BEST	-	-	8.9	14.7	26.0	47.6	86.7	137.0	-	-	-
	HIGH	-	-	10.6	17.6	31.0	56.3	101.4	158.0	-	-	-
	STANDARD	-	-	13.2	21.8	38.3	69.0	122.2	186.7	-	-	-
	BASIC	-	-	16.7	27.4	47.7	84.9	147.4	219.9	-	-	-
Refresh Rate (Frame/Sec)		25	12.5	8.3	5	2.7	1.4	0.76	0.44	1/8	1/12	1/16
REC Time Mode		3 hr	6 hr	9 hr	12 hr	24 hr	48 hr	96 hr	168 hr	480 hr	720 hr	960 hr

NOTE 1: Recording times on the tables above are estimated. For actual available recording time of a recording configuration, please refer to the system information of the DVR. (Please refer to section 3.3 system information for more details.)

2: No audio function at the refresh rate in NTSC: 30 frame/sec ~ 15 frame/sec, 1/8 frame/sec ~ 1/16 frame/sec.

No audio function at the refresh rate in PAL: 25 frame/sec ~ 12.5 frame/sec, 1/8 frame/sec ~ 1/16 frame/sec.

4.2 Recording Operations

This section details the various recording methods available – Manual, Timer, Alarm, and External. Before commencing with the recording function, please configure the recording settings properly according to your needs.

4.2.1 Manual Recording

When the DVR is in live display mode, take the following steps to start recording:

- (1) In live display, press the **REC** button (6) to record video into a hard disk drive with the corresponding programmed recording settings. The monitor should display a flashing **REC** message and the **REC** button (6) will light up indicating the DVR is in the recording status.
- (2) Press the **STOP** button (5) to stop recording any time.
- (3) To access just recorded video, please refer to section 4.4 for more details.

4.2.2 Timer Recording

Timer recording provides two periods of time each day in a weekly table which programs the DVR Start and Stop recording at specified times. Please take the following steps to program the scheduled recording.

- (1) Press the **Setup** button (9) to enter the **MAIN MENU**.
- (2) Select the **TIMER/ SEQ/ TITLE** and press the **Enter** button (15) to enter the **TIMER/ SEQ/ TITLE** page.
- (3) Select the **TIMER – SET**.
- (4) Press the **Enter** button (15) to enter the **REC SCHEDULE** table.
- (5) ● You can set up by using the “<” button (11) and the “>” button (14) to locate the specific day/hour/minute and use the “^” button (12) and the “v” button (13) to set the day/hour/minute you wish.
 - You can also set up by using the **Shuttle Ring** and the **Jog Dial**. “⊖” is the equal of the “<” button (11), “⊕” is the equal of the “>” button (14), “⬆” is the equal of the “^” button (12) and “⬇” is the equal of the “v” button (13).
 - The time is displayed in a 24-hour clock format.
- (6) After scheduling is completed, press the **Enter** button (15) and set **OK** to save the setting or select **CANCEL** to leave the page without saving the settings.
- (7) To activate the programmed recording schedule, set the **REC ENABLE** to **ON**. As the scheduled recording is on, the red indicator of the Timer Record (17) will be on as well. To deactivate it, set to **OFF**.
- (8) Press the **STOP** button (5) during the scheduled recording to stop it at any time. If you wish to continue the scheduled recording, press the **REC** button (6) to proceed.

NOTE: If a programmed schedule falls within the current set time of the DVR, recording will begin upon exiting programming.

NOTE: If you activate the recording function before the scheduled recording, the unit will operate recording as shown in the diagram below and keep those Images in different files.

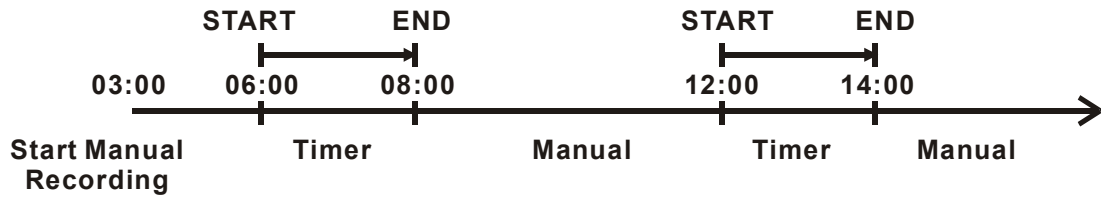

MAIN MENU

RECORD
 ALARM/ MOTION
TIMER/ SEQ/ TITLE
 COMMUNICATION
 DISK
 SYSTEM

GOTO TIMER/SEQ/TITLE PAGE



TIMER/ SEQ/ TITLE

CLOCK : SET
 REC ENABLE : OFF
TIMER : SET
 SEQUENCER : SET
 TITLE : SET

MAIN PAGE

SET REC SCHEDULE



REC SCHEDULE

START	END	START	END
S :	00 :00-00:00	00:00-	00:00
M :	00:00-00:00	00:00-	00:00
T :	00:00-00:00	00:00-	00:00
W :	00:00-00:00	00:00-	00:00
T :	00:00-00:00	00:00-	00:00
F :	00:00-00:00	00:00-	00:00
S :	00:00-00:00	00:00-	00:00

OK CANCEL

← → TO MOVE ↓ ↑ TO CHANGE

MAIN MENU

RECORD
 ALARM/ MOTION
TIMER/ SEQ/ TITLE
 COMMUNICATION
 DISK
 SYSTEM

GOTO TIMER/SEQ/TITLE PAGE



TIMER/ SEQ/ TITLE

CLOCK : SET
REC ENABLE : ON
 TIMER : SET
 SEQUENCER : SET
 TITLE : SET

MAIN PAGE

TIMER REC ENABLE

4.2.3 Alarm / Motion Recording

Take the following steps to activate the programmed alarm recording. For **ALM OPERATION**, **REC RATE**, **REC QUALITY**, **AUDIO**, **ALM TYPE**, **ALM DURATION**, and **PRE-ALARM** settings, please refer to section 5.2 for more details.

- (1) Press the **Setup** button **9** to enter the **MAIN MENU**.
- (2) Select **ALARM/ MOTION** and press the **Enter** button **15** to enter the **ALARM/ MOTION SETTING**.
- (3) Set the desired **REC RATE**, **REC QUALITY**, **ALM TYPE**, and **ALM DURATION** for use. If audio is required, set **AUDIO** to **ON**. If pre-alarm recording is required, set **PRE-ALARM** to **ON**.
- (4) To activate the alarm recording, set **ALM OPERATION** to **ON**. To deactivate it, set **ALM OPERATION** to **OFF**.

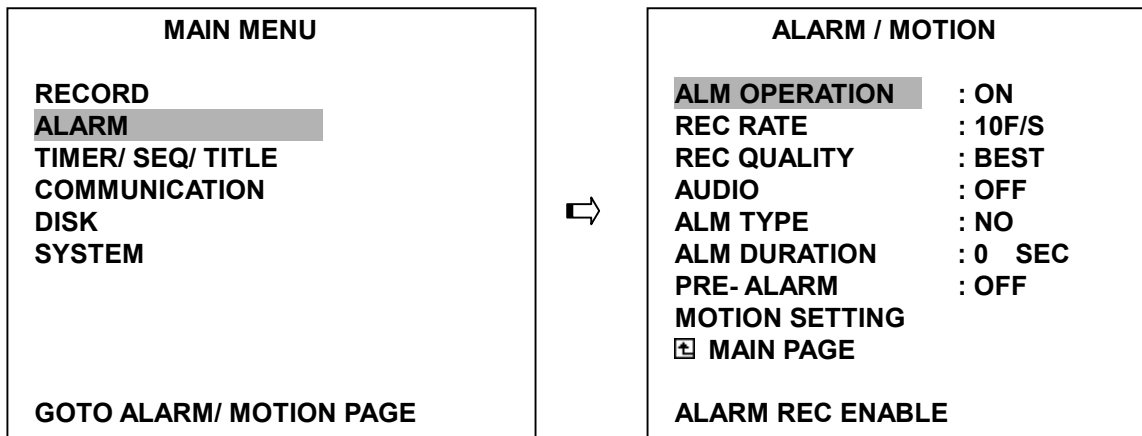

- (5) To active the motion alarm recording, Select **MOTION SETTING** and press the **Enter** button **15** to enter the **MOTION SETTING PAGE**, set **CH1/ CH2/ CH3/ CH4** TO **ON**, and set a suitable sensitivity according to the video sources. 1 is the Highest sensitivity, 5 is the lowest.

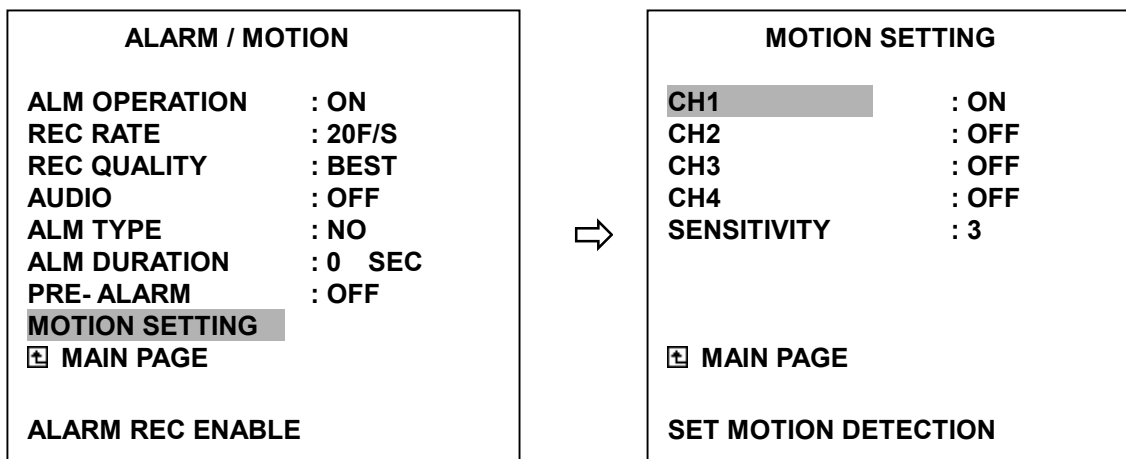

4.2.4 Externally triggered Recording

By connecting the **RECORD IN** of ALARM I/O on the rear panel of the DVR, you can activate/deactivate the recording function of a DVR. The file will be kept with a prefixed "R".

Please refer to section 2.3 for more details.

NOTE: The status of recording operations when an alarm occurs are shown in the diagrams below.

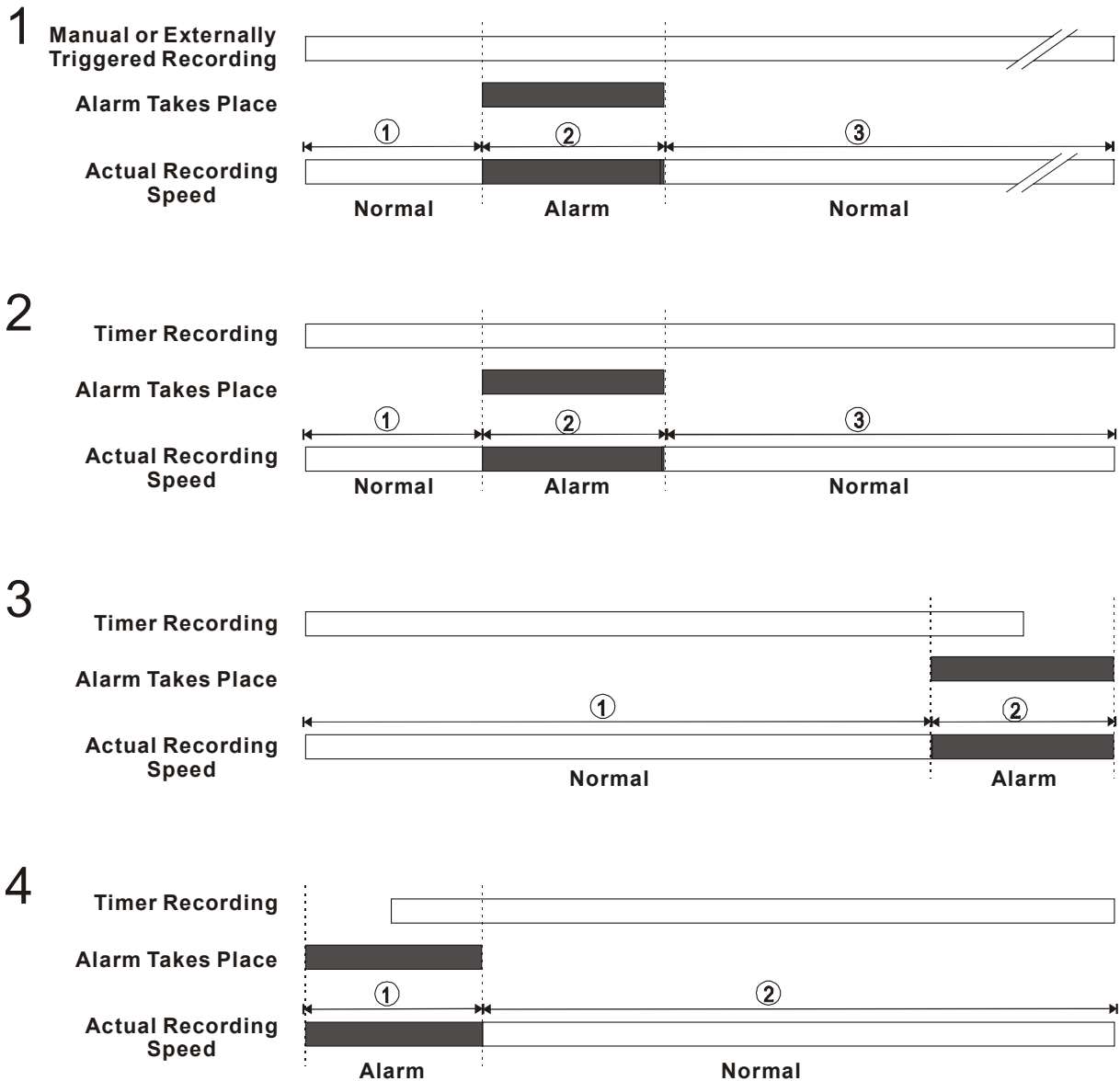

4.3 Playback Operations

This section outlines the controls and options available during playback of recorded video. When playing a file, the monitor should display a flashing **PLAY** message and the **PLAY** button ④ will light up indicating that the DVR is in the playback status.

To switch between channel 1..4 and quad view in the playback mode, please press ⑪ **CH1** ⑭ **CH 2** ⑬ **CH 3** ⑫ **CH4** and ⑮  buttons. Besides switching between channels, ⑪ **CH1** ⑭ **CH 2** ⑬ **CH 3** ⑫ **CH4** can also be used to zoom the picture as 2X2 full screen view.

Operation Status

A. From REC mode to Playback mode

(In live mode, directly press the **PLAY** button ④ to play a latest recorded video)

REC → [**STOP**] → [**PLAY**] Play the latest recorded file

- ▶ [Play to the end of the file] Show the ending message (use search functions or rewind to replay the file if required)
- ▶ [**STOP**] → [**PLAY**] Play the file from the stop position

B. Search to play back a particular recorded video

Search → [**PLAY**] Play a selected file

- ▶ [Play to the end of the file] Show the ending message (Search again or rewind to replay the file if required)
- ▶ [**STOP**] → [**PLAY**] Play the file from the stop position

C. Play Back From The Oldest Data

[Stop: Press the “**STOP**” button for three seconds] → [**PLAY**] ..play back from the beginning of the HDD recorded data

4.3.1 Fast Forward/Reverse

There are 7 speeds available for playback: 1x, 2x, 4x, 8x, 16x, 30x and 100x

While playing back recorded video at recorded speed:

Forward: Turn the **Shuttle** dial ⑳ to the right to view the recorded video in the forward direction at a speed faster than the recorded speed. Each subsequent turn of the shuttle to the right increases the forward rate, as 2x, 4x, 8x, 16x, 30x and 100x.

Reverse: Turn the **Shuttle** dial ⑳ to the left to view the recorded video in the reverse direction at a speed faster than the recorded speed. Each subsequent turn of the shuttle to the left increases the reverse rate, as -1x, -2x, -4x, -8x, -16x, -30x and -100x.

Normal: Release the **Shuttle** dial ⑳ to return to the normal speed of playback.

4.3.2 Slow Forward/ Reverse

There are 4 speeds available for a slow playback: 1/2, 1/4, 1/8, 1/16.

While playing back recorded video at the recorded speed:

- (1) Press the **PAUSE** button **③** for the slow playback mode.
- (2) **Forward:** Turn the **Shuttle** dial **⑳** to the right to view the recorded video in the forward direction at a speed slower than the recorded speed. Each subsequent turn of the shuttle to the right increases the forward rate, as 1/2, 1/4, 1/8, and 1/16.
- (3) **Reverse:** Turn the **Shuttle** dial **⑳** to the left to view the recorded video in the reverse direction at a speed slower than the recorded speed. Each subsequent turn of the shuttle to the left increases the reverse rate, as -1/2, -1/4, -1/8, and -1/16.
- (4) **Normal:** Release the **Shuttle** dial **⑳** and then press the **PLAY** button **④** to return to the normal speed of playback.

4.3.3 Playback Picture-by-picture

While playing back recorded video at the recorded speed:

- (1) Press the **PAUSE** button **③** for the picture-by-picture mode.
- (2) There are two ways, by PAUSE button or by JOG, available to play in the picture-by-picture mode, but the **PAUSE** button **③** can only function in a forward direction; the other, **JOG** dial **㉑**, can act in both a forward and a backward direction, as well as picture-by-picture.

By **PAUSE** button **③** :

Press the **PAUSE** button **③** to display one frame of a picture at a time in the forward direction.

By **JOG** dial **㉑** :

Turn the **JOG** dial **㉑** clockwise to display one frame of a picture at a time in the forward direction. Turn the **JOG** dial **㉑** counterclockwise to display one frame of a picture at a time in the backward direction.

- (3) Press the **PLAY** button **④** to return to the normal speed of playback.

4.3.4 Play Back Recorded Video from a HDD of the mobile rack

To play back a recorded video from a HD2, take the following steps::

- (1) Press the **Search** button **⑩** to enter the search mode.
- (2) Press the **⑫** “**▲**” and **⑬** “**▼**” buttons, to select a video; press the **⑪** “**<**” and **⑭** “**>**” buttons, to flip over a page.
- (3) Use the search function to access desired recorded video. For specific operation details please refer to the next section 4.4 (Search Operations).

4.4 Search Operations

This section shows you how to access recorded video.

4.4.1 Full List Search

Take the following steps to proceed with the full-list search function.

- (1) Press the **Search** button **(10)** to enter the search mode.
- (2) Select the **FULL LIST** and press the **Enter** button **(15)** to access the complete list of recorded video.
- (3) Highlight the specific recorded video of your requirement and press the **Enter** button **(15)** to display the selected video.

(Key Operation: Press the **(12) “^” and **(13)** “v” buttons, to select a video; press the **(11)** “<” and **(14)** “>” buttons, to flip over a page.)**

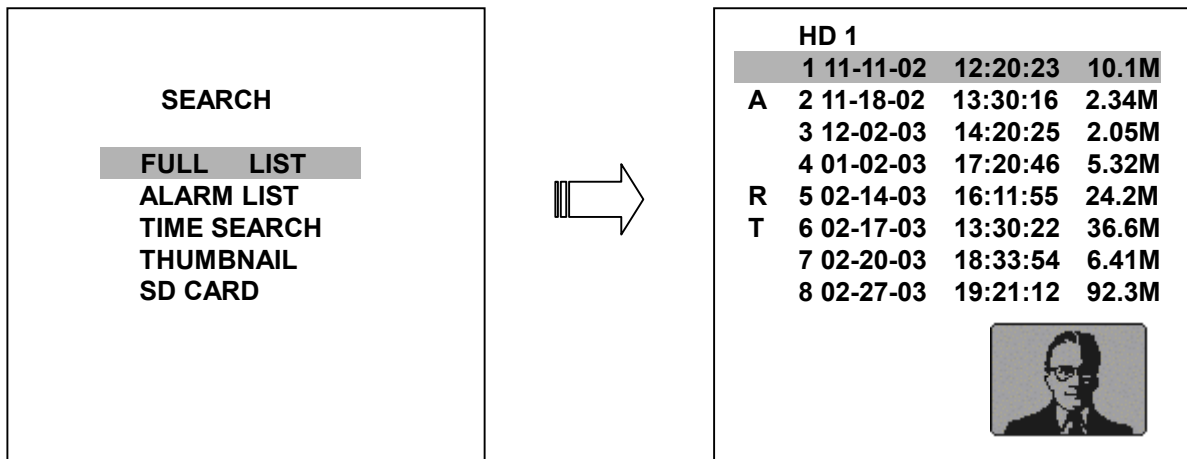

NOTE 1 : T: Timer recording; R: External trigger recording; A: Alarm recording.

2 : The maximum number of lists, for a respective HDD, is 3000.

4.4.2 Alarm list Search

Take the following steps to proceed with the alarm-list search function.

- (1) Press the **Search** button ⑩ to enter the search mode.
- (2) Select the **ALARM LIST** and press the **Enter** button ⑮ to access the complete list of alarm-event recorded video.
- (3) Highlight the specific recorded video of your requirement and press the **Enter** button ⑮ to display the selected video.

(Key Operation: Press the ⑫ “^” and ⑬ “v” buttons, to select a video; press the ⑪ “<” and ⑭ “>” buttons, to flip over a page.)

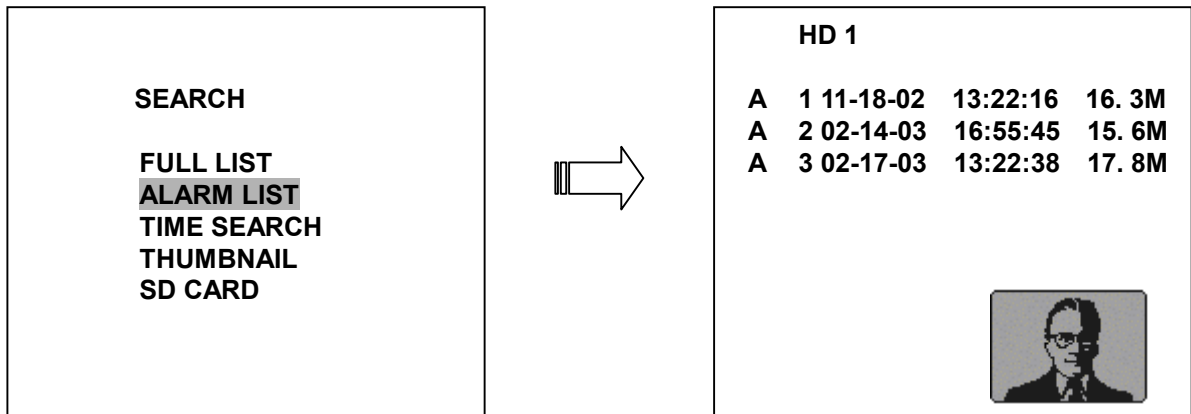

4.4.3 TIME Search

Take the following steps to proceed with the time-list search function.

- (1) Press the **Search** button ⑩ to enter the search mode.
- (2) Select the **TIME SEARCH** and press the **Enter** button ⑮ to access the time-setting page.
- (3) Set the time period you wish to search for the recorded video.
- (4) Press the **Enter** button ⑮ to start searching and displaying the concerned image.
- (5) If no video is found, please return to the time-setting page and repeat steps (3) and (4) again for another search.

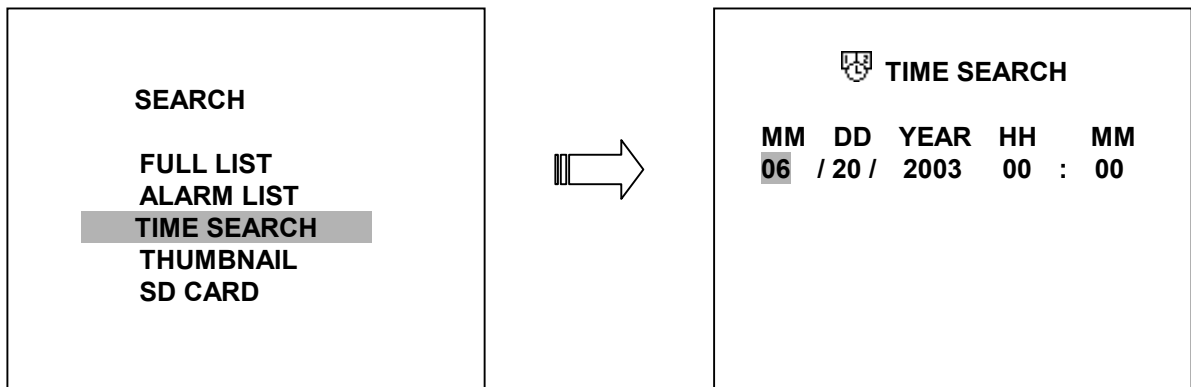

4.4.4 THUMBNAIL Search

Take the following steps to proceed with the thumbnail search function.

- (1) Press the **Search** button ⑩ to enter the search mode.
- (2) Select the **THUMBNAIL** and press the **Enter** button ⑮ to access the thumbnail page.
- (3) Set the date you wish to search for the recorded video.
- (4) Press the **Enter** button ⑮ to start searching and displaying the concerned image.
 - You can set up by using the “<” button ⑪, the “>” button ⑭, the “^” button ⑫ and the “v” button ⑬ to move eye focus.
 - You can also set up by using the **Shuttle Ring** and the **Jog Dial** to move eye focus. ⌚ is the equal of the “<” button ⑪, ⌚ is the equal of the “>” button ⑭, ⌚ is the equal of the “^” button ⑫ and ⌚ is the equal of the “v” button ⑬.
- (5) There are 5 levels of recording range modes to choose from: **1 Hour, 10 Minutes, 1 Minute, 10 Seconds** and **1 Second**. Select the specific frame of your requirement and press the **Enter** button ⑮ to enter the next level. If you want to return the previous level, please press the **Setup** button ⑨
- (6) Once reaching the critical point at any level, the user can start playback by just clicking the **PLAY** button ④.

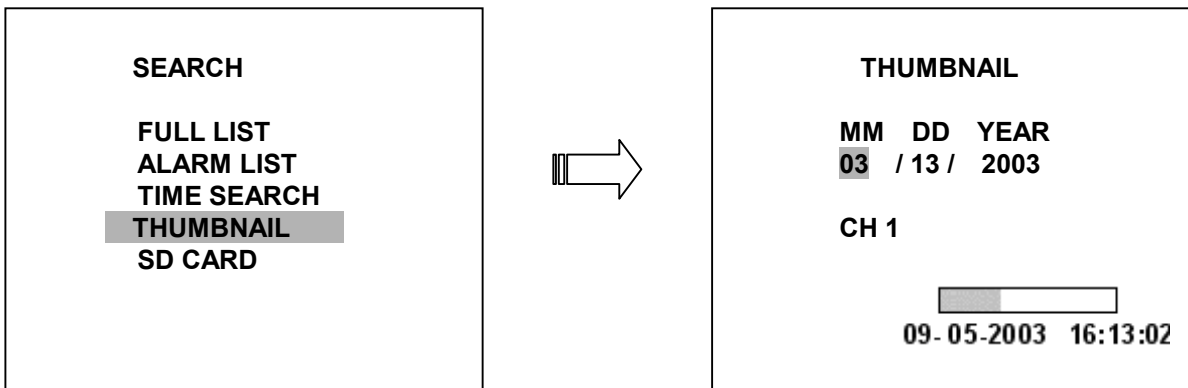

4.4.5 SD CARD Search

Take the following steps to proceed with the SD card search function.

- (1) Insert a SD Card into the SD card slot of the rear unit.
- (2) Press the **Search** button ⑩ to enter the search mode.
- (3) Select the **SD CARD** and press the **Enter** button ⑮ to access the complete list of JPG files.
- (4) Highlight the specific JPG file of your requirement and press the **Enter** button ⑮ to display the image.
- (5) If you need another, please return to the SD card JPG file list page and repeat steps (3) and (4) again for another search.

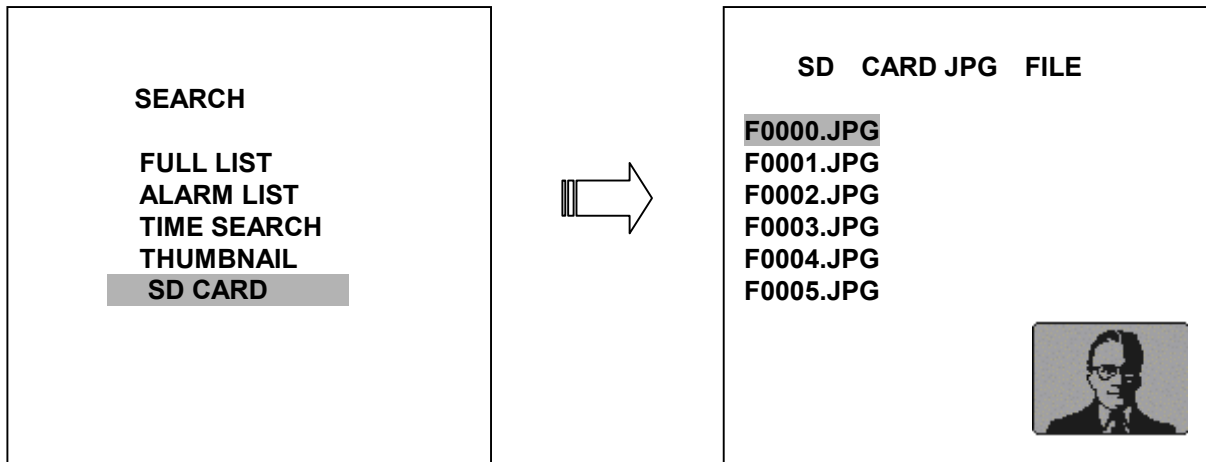

NOTE: If you would like to delete JPG file in the SD card, please return to **SD CARD JPG FILE** list page and highlight the specific JPG file of your requirement and press the **Setup** button **9** and then select the **“Yes”** to delete the image.

4.5 Backup Operations

4.5.1 Mobile Rack HD Backup Operations

There are three ways available to duplicate the recorded video from HD 1 (Fixed HD) to HD 2 (Mobile Rack HD). Please take the following steps to proceed.

(1) Set HD 2 to BACKUP first. Take the following steps.

- Press the **Setup** button **9** to enter the setup mode and select the **DISK**.
- Highlight **DISK** and press the **Enter** button **15** to enter the **DISK SETTING** page.
- Then set **HD 2 USAGE** to **BACKUP**.

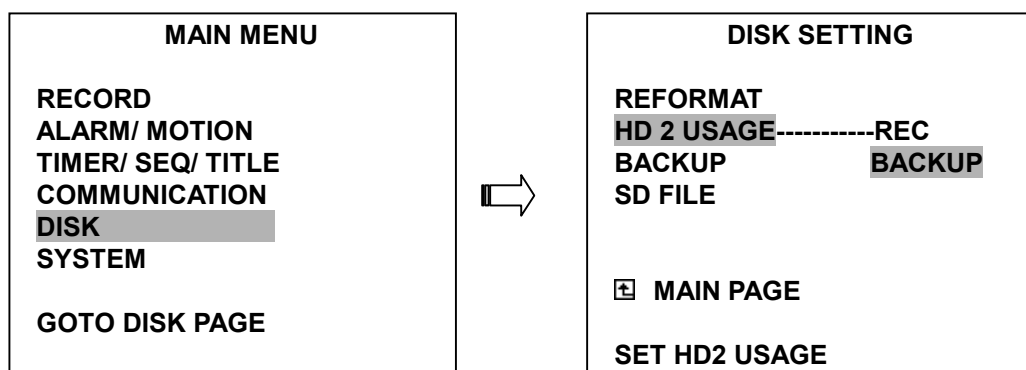

(2) FULL: Duplicate all the recorded video from HD1 to HD2.

- Stay on the **DISK SETTING** page.
- Use the **“^”** and **“v”** buttons, **12** and **13**, to highlight **BACKUP**, select **FULL**, then press the **Enter** button **15** to proceed.

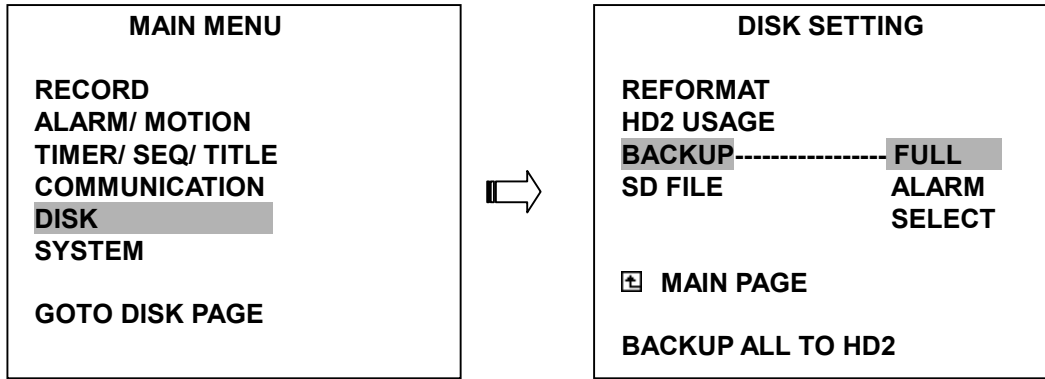

ALARM: Duplicate all the alarm-event recorded video from HD 1 to HD2.

- Stay on the **DISK SETTING** page.
- Use the “^” and “v” buttons, ⑫ and ⑬, to highlight **BACKUP**; select **ALARM**, then press the **Enter** button ⑮ to proceed.

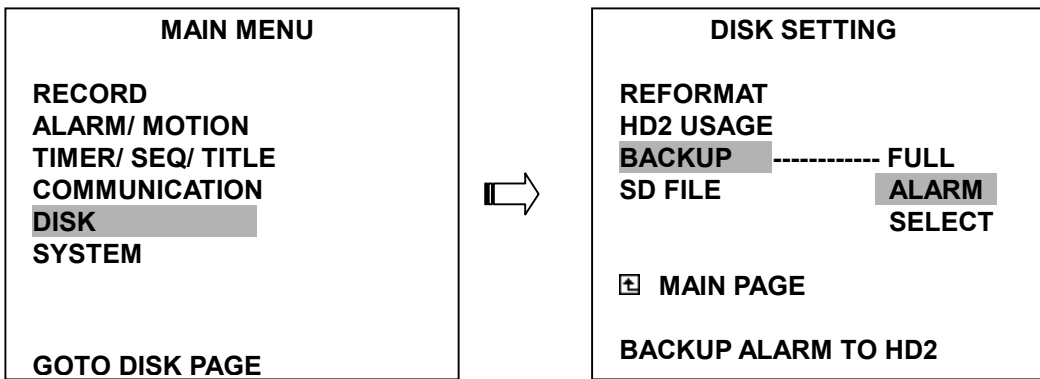

SELECT: Duplicate a particular recorded video from HD1 to HD2.

- Stay on the **DISK SETTING** page.
- Use the “^” ⑫ and “v” ⑬ buttons, to highlight **BACKUP**, select **SELECT** and then press the **Enter** ⑮ button to list all the recorded video.
- Press the “^” ⑫ and “v” ⑬ buttons, and, to select the desired clip and press the **Search** button ⑨ to mark it.
- After completing the selection, press the **Enter** ⑮ button to proceed.

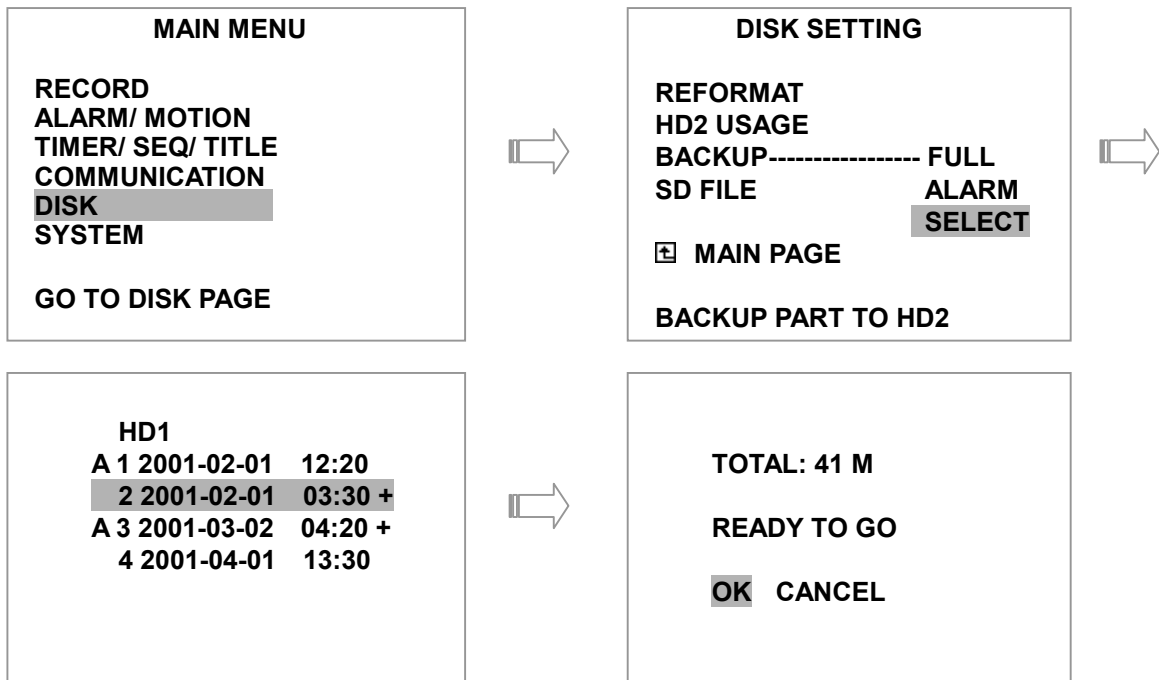

NOTE: If the capacity of HD 2 is not sufficient to store all selected video, a warning message “HD2 SPACE NOT ENOUGH” will be displayed on the screen. Please, insert a larger capacity of hard-disk drive and start the process all over again.

4.5.2 Security Digital Card (SD Card) Backup Operations

The SD card slot of the rear unit has three functions as shown below:

1. Archive Single image Clips into SD Card

Please take the following steps to archive a critical image in a SD card.

- (1) Insert a SD Card into the SD card slot of the rear unit.
- (2) Start playing back the recorded video.
- (3) Press the **PAUSE** button **3** to freeze the desired pictures.
- (4) Press the **Seq./Save** button **16** to save the image in the SD Card.

The quantity of pictures that can be stored depends on the SD card capacity. You can have the saved images printed out in any computer. The image is stored in the JPEG compressed format. If more than one clip is stored in a SD card, file names will be assigned in sequence as shown below.

SAVE TO F000.JPG
SAVE TO F001.JPG
 ...
SAVE TO F00N.JPG

- (5) The saved picture is the same as the present picture on the screen, please use CH1**11**, CH2**14**, CH3**12**, CH4**13**, and **Enter/ Quad** button **15** to switch to channel(s) desired, and then press **Seq./Save** **16** button to save.

2. Archive video of AVI Clips into SD Card

Please take the following steps to archive a critical video in a SD card.

- (1) Insert a SD Card into the SD card slot of the rear unit.
- (2) Start playing back the recorded video.
- (3) Press the **PAUSE** button **3** to freeze the desired pictures.
- (4) Press the **Enter** button **15** to save the video in the SD Card.

The quantity of video that can be stored depends on the SD card capacity. The image is stored in the AVI compressed format. If more than one clip is stored in a SD card, file names will be assigned in sequence as shown below.

SAVE TO M0000.AVI

SAVE TO M0001.AVI

...

SAVE TO M000N.AVI

- NOTE:**
- The JPEG file format can be played and deleted in the DVR. Please refer to section 4.4.5.
 - The AVI file format can not. It can only be played in a card reader connected to a computer.
 - The file format can be selected from “SD FILE” item on Setup Menu. Please refer to section 5.5 for more detail.

3. Backup the System setting info into SD Card.

The **MV-DR4000** offers a quick setup method by using a SD card. If a user wants to set many 4CH DVR devices with the same settings, the 4CH DVR could save the whole setting in the SD card, then transfer it to another DVR. (Approx. 800KB space required on the card)

Save the whole setting into the SD card:

- Insert a SD card into the SD card slot.
- Press the **Setup** button **9** to enter the setup mode and select the **SYSTEM**.
- Highlight **SYSTEM** and press the **Enter** button **15** to enter the **SYSTEM SETTING** page.
- Set **SD SETUP** to **SAVE**. Then the system setting info will auto save into SD card.

Transfer the system setting info of DVR to another:

- Insert the SD card containing the stored system setting info into the DVR.
- Press the **Setup** button **9** to enter the setup mode and select the **SYSTEM**.
- Highlight **SYSTEM** and press the **Enter** button **15** to enter the **SYSTEM SETTING** page.
- Then set **SD SETUP** to **LOAD**.

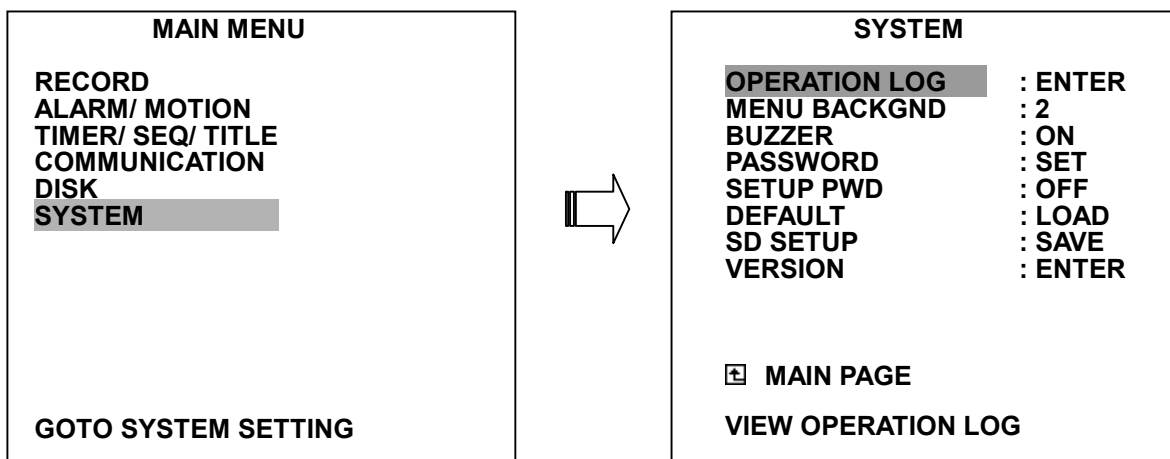

4. Updating System Software (Please refer to section 3.4 for more details.)

4.6 Key Lock Operation

The Key lock operation protects the unit against unauthorized use by disabling the entire front panel controls. Press the **Enter** button ⑮ (as shown below) for at least 3 seconds to lock the unit; to release the **Key Lock**, press the button again.

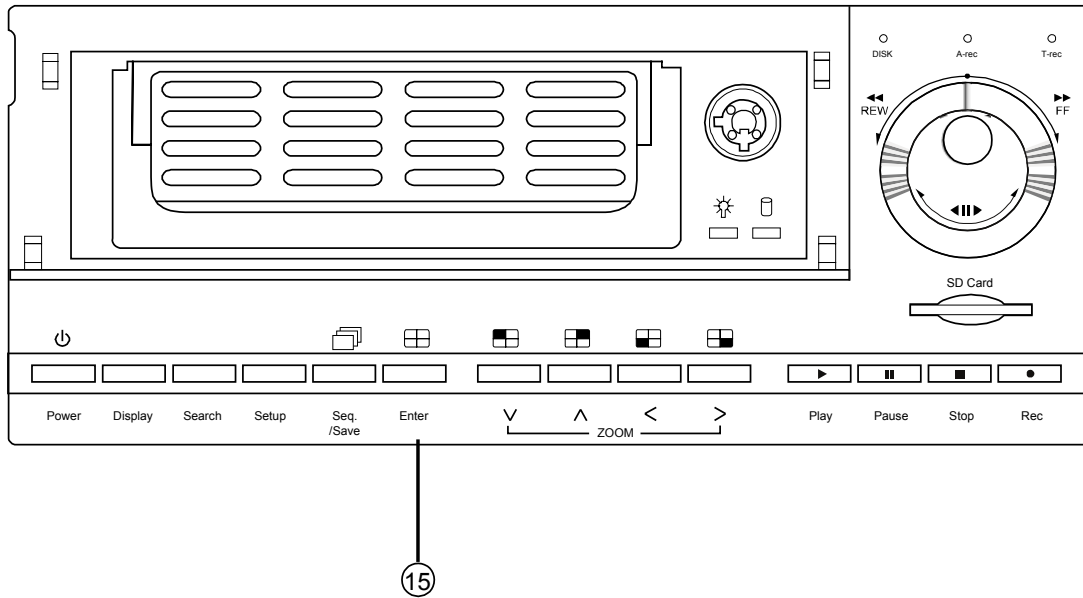

5. MENU SETUP

There are 6 categories of operation settings able to be configured from the setup menu. The following sections will provide step-by-step instructions for configuring/changing the setup options. Press the **Setup** button ⑨ to access the setup menu. Once inside the menu system, the on-screen menu allows you to set up the key features of the unit. The functions of various buttons within the menu-setup mode are described in the paragraphs below.

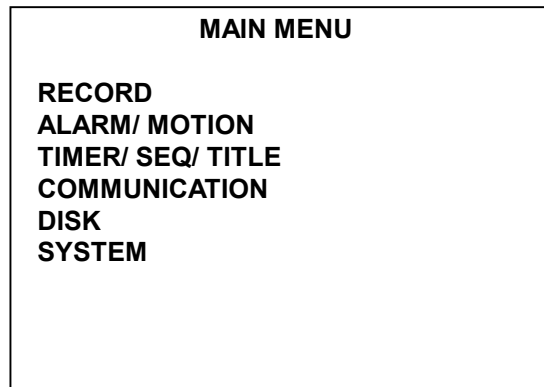

Set Up Menu Navigation Buttons:

Setup button ⑨ :

Press to enter the setup menu. Press again to exit the setup mode.

“▲” ⑫ and “▼” ⑬ buttons :

Press to select the desired item or entry for setting.

“<” ⑪ and “>” ⑭ buttons :

Press to highlight the desired option or to select the context for setting.

Enter button ⑮ :

Press to enter the selected item and to save the setting.

Shuttle Ring ⑳ :

Turn to highlight the desired option or to select the context for setting.

Jog Dial ㉑ :

Turn to select the desired item or entry for setting.

5.1 REC SETTING

This page allows you to set the recording rate and recording quality, and enables you to continue recording when the disk is full.

NOTE: Please see chart in section 4.1 to help determine the appropriate settings for REC RATE and REC QUALITY according to your desired record time.

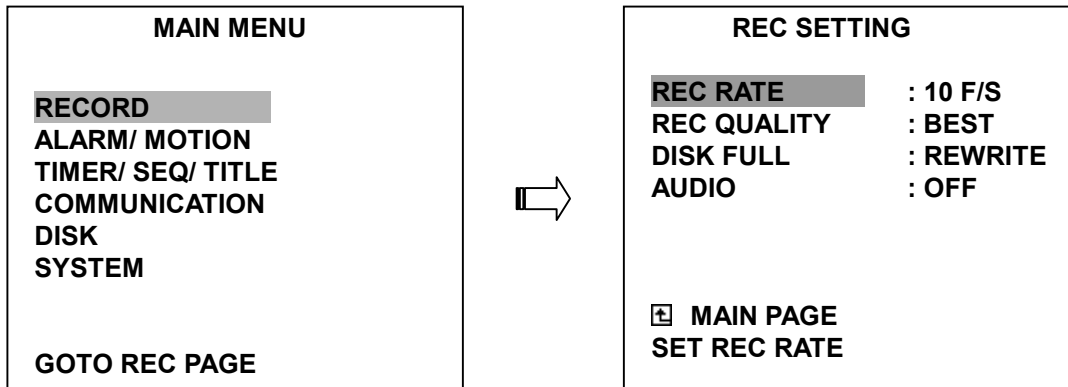

REC RATE:

This option is for adjusting the number of pictures recorded every second into a storage disk. The recording rate controls the frequency at which the number of video pictures can be recorded.

- For a NTSC unit, there are 11 different recording rates you can select from: **30F/S (30 frames per second)**, **15F/S**, **10F/S**, **6F/S**, **2.7F/S**, **1.2F/S**, **0.61F/S**, **0.35F/S**, **1F/8S**, **1F/12S**, and **1F/16S**.
- For a PAL unit, there are 11 different recording rates you can select from: **25F/S (25 frames per second)**, **12.5F/S**, **8.3F/S**, **5F/S**, **2.7F/S**, **1.4F/S**, **0.76F/S**, **0.44F/S**, **1F/8S**, **1F/12S**, and **1F/16S**. Please refer to the table in section 4.1 for details.

NOTE: The 30 F/S (25 F/S for a PAL unit) recording rate can only function in a 352x240 (352x288 for a PAL unit) resolution

REC QUALITY:

This option determines the image quality to be recorded. The DVR stores images in the compressed format and allows the image quality to be altered by the image size. There are 4 levels of image quality you can select from: **BEST**, **HIGH**, **STANDARD**, and **BASIC**. Selecting the BEST image for use provides higher-resolution recorded images, and normally takes up more storage space than a HIGH, STANDARD or BASIC image does.

DISK FULL: This option determines the way to utilize storage media in case of a full disk

- **REWRITE:** When the hard disk is full, the device continues recording by displacing the old data.
- **STOP:** When the hard disk is full, the device will stop recording.

AUDIO: This option determines the way to record sound if necessary.

- **ON:** Enables AUDIO recording.
- **OFF:** Disables AUDIO recording.

NOTE: Audio function can only be activated in the following refresh rate in NTSC(PAL): 10(8.3), 6(5), 2.7(2.7), 1.2(1.4), 0.61(0.76), 0.35(0.44) frames/sec

5.2 ALARM / MOTION SETTING

This menu allows users to program the configuration of alarm recording only when an alarm input is activated. The device will record as long as the alarm input is activated.

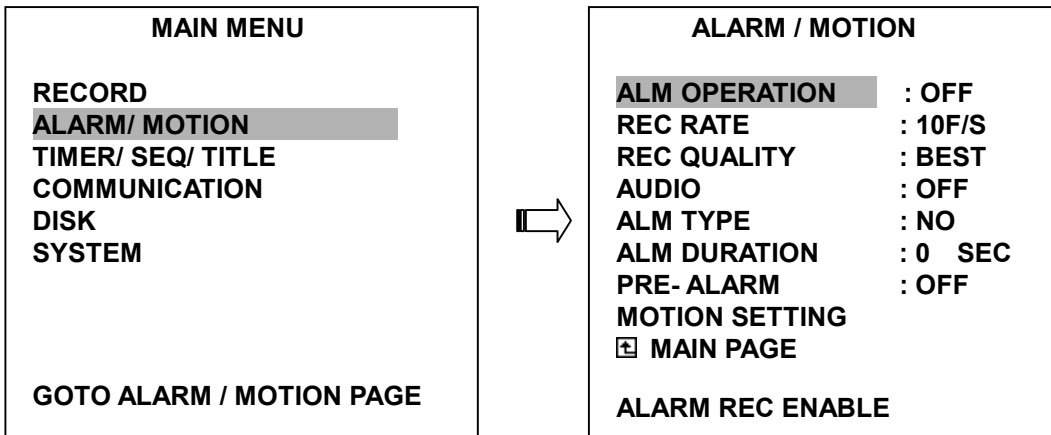

ALM OPERATION:

This option determines whether to activate/deactivate the alarm recording when it detects an alarm input.

ON: The device activates the alarm recording when it detects an alarm input.

OFF: The device ignores the alarm signal when it detects an alarm input.

REC RATE:

This option is for the purpose of adjusting the number of pictures recorded every second into a storage disk when an alarm input is activated. For a NTSC unit, there are 5 different record speeds you can select from: **30F/S (30 frames per second)**, **15F/S**, **10F/S**, **6F/S**, and **REMAIN**. For a PAL unit, there are 5 different record speeds you can select from: **25F/S (25 frames per second)**, **12.5F/S**, **8.3F/S**, **5F/S**, and **REMAIN**. If you select **REMAIN** for use, the device will record images at the same speed as set on the **REC** page.

REC QUALITY:

This option determines the image quality to be recorded when an alarm input occurs. There are 4 levels of image quality to choose from: **BEST**, **HIGH**, **STANDARD**, and **BASIC**. The table below shows the level of image quality with the corresponding compression ratio and image size for every 4 pictures(CH1 ~ CH4)

Image Quality	Compression Ratio			
	Best	High	Standard	Basic
Image Size	60KB	50KB	40KB	32KB

AUDIO:

This option determines the way to record sound if necessary.

ON: Enables AUDIO recording.

OFF: Disables AUDIO recording.

NOTE: Audio function can only be activated in the following refresh rate in NTSC(PAL): **10(8.3)**, **6(5)**, **2.7(2.7)**, **1.2(1.4)**, **0.61(0.76)**, **0.35(0.44) frames/sec**

ALM TYPE:

This option allows users to set a type of alarm input corresponding to the sensor signal in use.

NO: Normally Open. This is to be used with the type of alarm sensor whose contact remains open in normal conditions and closes in case of activation.

NC: Normally Closed. This is to be used with the type of alarm sensor whose contact remains closed in normal conditions and opens in case of activation.

ALM DURATION:

This option allows users to set alarms for a certain duration. You can select one of the six following options: **0 SEC, 30SEC, 1 MIN, 5 MIN, 10 MIN, and NON-STOP.**

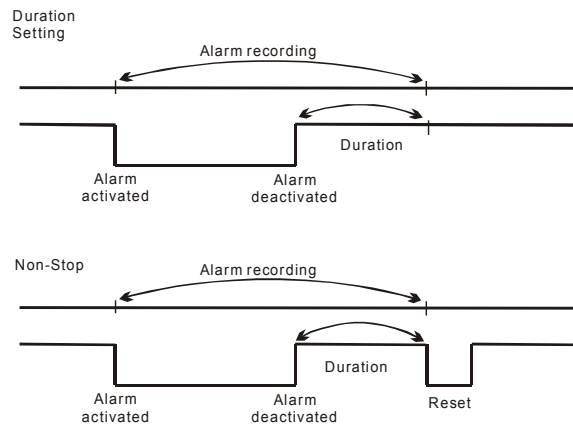

NOTE: Recording may be interrupted at the time of Alarm-in or Alarm-out.

LIVE images may be interrupted at the time of Alarm-out.

PRE- ALARM:

This option determines whether images that occurred prior to an alarm prior to an alarm activation will be recorded. When an alarm is triggered the device will record the image prior to the alarm for 5 seconds. (10 frames/sec)

ON: Enables this function.

OFF: Disables this function.

NOTE: If the device is already in the recording mode before an alarm occurs, the pre-alarm recording would not take effect.

MOTION SETTING:

The video motion detection function is convenient for the people without alarm trigger input, but also can used with alarm trigger input at the same time. If this function is enabled, any object movement would trigger the alarm recording. Before using the motion detection function, please turn the **CH1/ CH2/ CH3/ CH4** options as **ON**, and set the **SENTIVITY** (1 ~ 5) to a suitable value.

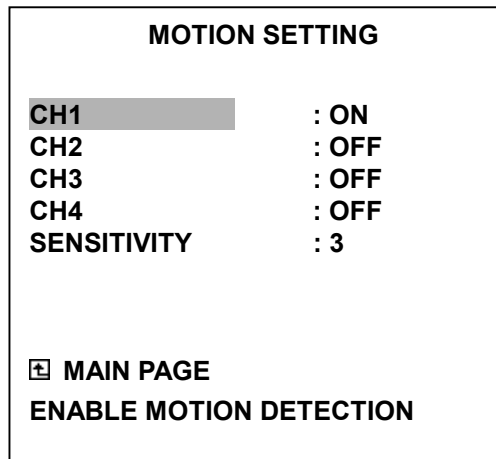

CH1/ CH2/ CH3/ CH4 :

These options enables/disables the motion detection.

ON : Enables the motion detection.

OFF: Disables the motion detection.

SENSITIVITY:

This option allows users to set the motion sensitivity.

1 is the most sensitive setting. **5** is the least sensitive setting

5.3 TIMER/ SEQ/ TITLE

The DVR provides a weekly table, consisting of two periods of time each day for scheduled recording. This option allows you to set the time each day that the DVR will start and stop recording. The SEQUENCER setting allow user to set the sequence dwell time (time interval) for each channel, and TITLE setting allow user to set TITLE for each channel.

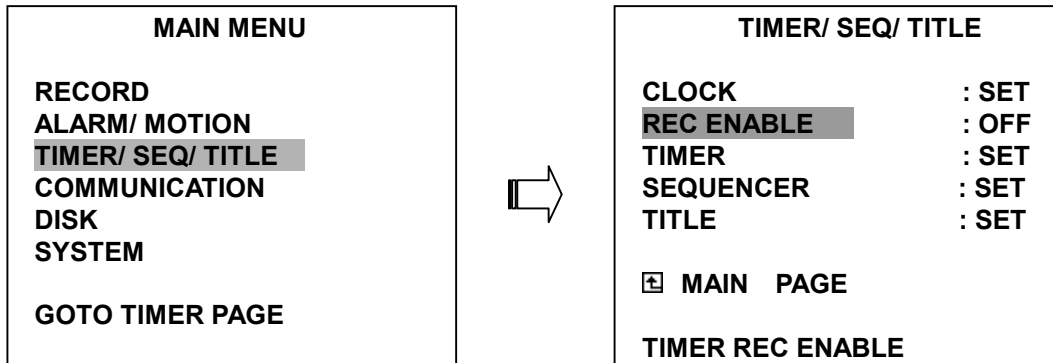

CLOCK:

This entry allows users to set the current system time and date.

REC ENABLE:

This option enables/disables the programmed scheduled recording.

ON: Enables the scheduled recording.

OFF: Disables the scheduled recording.

TIMER:

This entry allows users to program the time each day that the DVR will start and stop recording. There are two time periods each day available for scheduling. The time is displayed in a 24-hour clock format. If there is a time overlapping showing between two continual time period settings, the device will automatically combine the two time-period settings into one combined time-period setting.

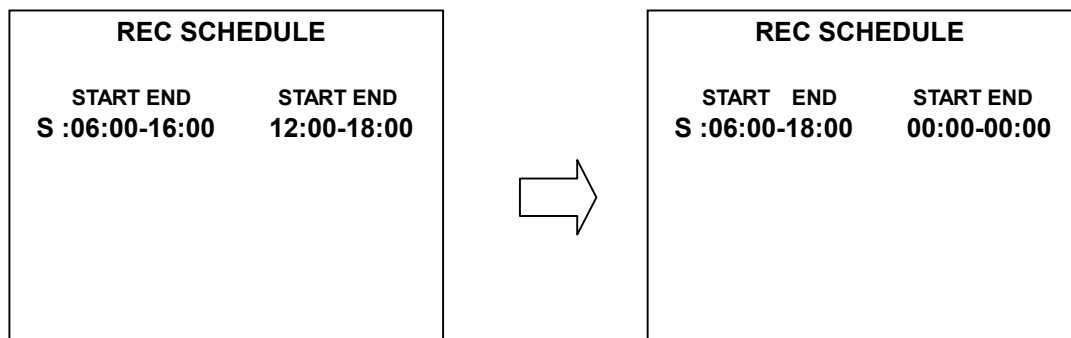

SEQUENCER:

This entry allows users to set the DWELL time(time interval) for CH1, CH2, CH3, CH4, and quad view(田), the valid values are 01 ~ 99 seconds, set to 00 would disable the corresponding channels during the sequential jumping is proceed. In live mode, press the Seq./Save button to switch the screen to the sequential jumping mode.

SEQUENCER					
CHANNEL	1	2	3	4	田
DWELL	03	03	03	03	03

TITLE:

This entry allows users to set the titles for each video source or camera, in live or recording mode, press the DISPLAY button can switch the display status to show the titles. The maximum length for each title is 12 characters.

TITLE		
CH1	[FRONT DOOR]
CH2	[KITCHEN]
CH3	[BACKYARD]
CH4	[ROOM]

<> TO MOVE ^ V TO CHANGE

5.4 COMMUNICATION

This option allows you to configure the Ethernet settings when connected to a LAN/WAN as well as RS-232/485 protocols if connected to an external control device.

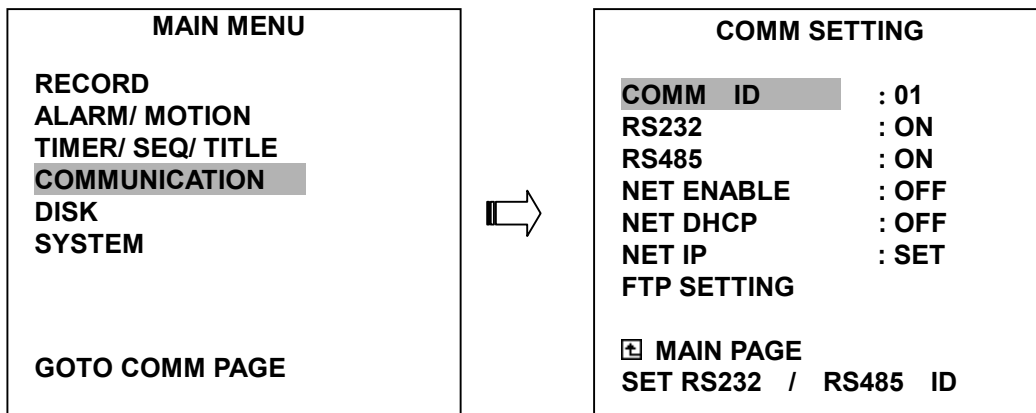

COMM ID:

Communication ID for RS232 and RS485 communication. After the 4CH DVR receives a RS232 or RS485 command, it checks if the <Dest ID> within the code is the same as the COMM ID, in which case the particular command can be accept.

RS-232:

The RS-232 communication port can be either in an importing or exporting mode according to your applications.

ON: Enables the RS-232 communication port. When you wish the unit to be controlled by an external device, please select this entry for use.

OFF: Disables the RS-232 communication port.

RS-485:

The RS-485 communication port can be either in an importing or exporting mode according to your applications.

ON: Enables the RS-485 communication port. When you wish the unit to be controlled by an external device, please select this entry for use.

OFF: Disables the RS-485 communication port.

NET ENABLE:

This option selects either enable or disable for the Ethernet communication port.

OFF: Disables it.

ON: Enables it.

NET DHCP:

This option selects enable or disable for the DHCP communication function.

OFF: Disables it.

ON: Enables it.

NOTE: If provided with a DHCP server, the 4CH DVR can get an IP automatically by setting this option to ON.

NET IP:

This option is used to configure the Ethernet communication settings. This is required for the purpose of making a network connection. Please consult with a qualified MIS professional to configure it.

IP: XXX.XXX.XXX.XXX

MASK: XXX.XXX.XXX.XXX

GATEWAY: XXX.XXX.XXX.XXX

HTTP PORT: XXXX

NOTE: The HTTP PORT allows users to set the HTTP port number of 80, 1080, and 2080.

FTP SETTING:

This entry allows users to set the FTP File Transfer Protocol.

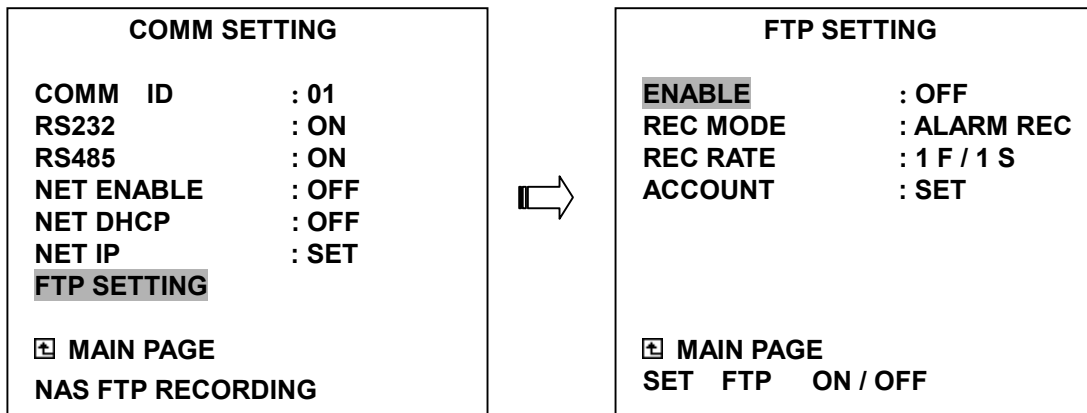

ENABLE:

This option is to select enable or disable for the FTP function.

ON: Enables it.

OFF: Disables it.

REC MODE:

This option determines the recording mode to be recorded when the FTP function occurs. There are 2 levels of recording mode to choose: **ALARM REC** and **ALL REC**.

ALARM REC: Only to record the alarm-event recorded video.

ALL REC: To record all the recorded video.

REC RATE:

This option determines the recording rate to be recorded at when the FTP function occurs. There are 4 levels of recording rates to choose from: **1 F / 1 S**, **1 F / 10 S**, **1 F / 30 S** and **1 F / 60 S**.

ACCOUNT:

This option is used to configure the FTP account settings. This is required for the purpose of making a FTP connection. Please consult with a qualified MIS professional to configure it.

FTP ACCOUNT	
FTP IP	: 192.168.001.128
USER	: [dvr]
PASSWORD	: [00000000]
PATH	: [/dvrvideo]

FTP IP : Every FTP server has to own an IP address to be identified on the network. Input the IP address of the FTP server.

USER : Input the FTP user name (Login Name).

PASSWORD : Input the FTP password (Password).

PATH : Input the upload path while doing the FTP.

5.5 DISK SETTING

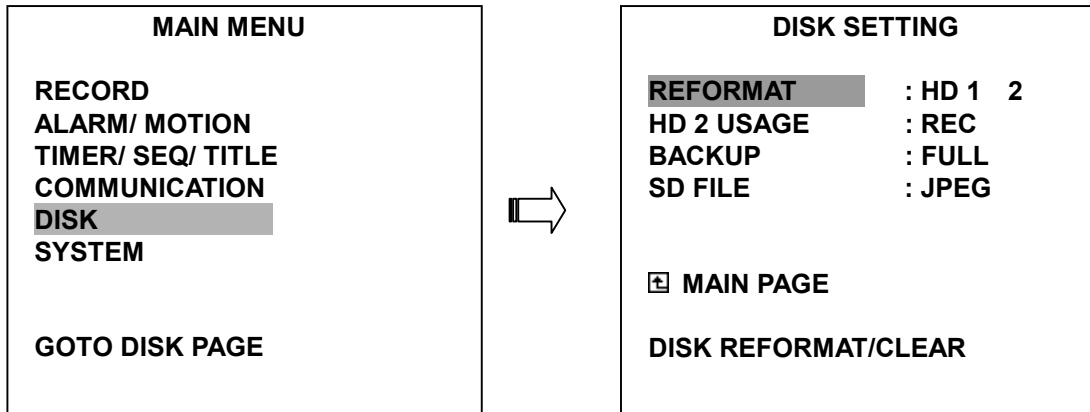

REFORMAT:

This option allows you to clear out all the data in the hard-disk drive. You will be required to enter the pre-set password before proceeding with clearing out the data. Enter the standard password "9999" if you don't set your individual password. To set your individual password, please refer to section 5.6

PASSWORD option.

HD 1 2: Clears out all the data stored in HD 1 and HD 2.

BACKUP HD: Clears out all the data stored in HD 2, which is set to backup purpose only. (This function has to be proceeded with when the **HD 2 USAGE** option is set to **BACKUP**.)

HD2 USAGE:

This option determines the way to utilize the hard-disk drive in the mobile compartment.

BACKUP: Used for data backup only, which will not be part of regular recording hard-disk drive.

REC: Used for the regular recording hard-disk drive.

NOTE: When you wish to play back a recorded video from a HD2, this option must be set to REC.

For more details, please refer to section 4.3.4.

BACKUP:

This function allows you to duplicate data from HD 1 to HD 2. Please set HD 2 as **BACKUP** first. (For operation details, please refer to section 4.5.1)

FULL: Duplicates all the recorded video from HD1 to HD2.

ALARM: Duplicates all the alarm-event recorded video from HD 1 to HD2

SELECT: Duplicates a particular recorded video from HD1 to HD2.

SD FILE:

This option determines the format to save the important image files in the SD card.

JPEG: Archives images in the JPEG format, to save a single picture in every file.

AVI: Archives images in the AVI format, to save a sequence of images in a file, the maximum limit being 300 images for every file. You can stop recording whenever you want, and if you don't, recording will automatically stop at the optimum of 300 images.

NOTE: To save the image, please refer to section 4.5.2 for more details.

5.6 SYSTEM

This section is used for accessing the history of the operation status, setting the password, resuming factory default, and determining the menu display background.

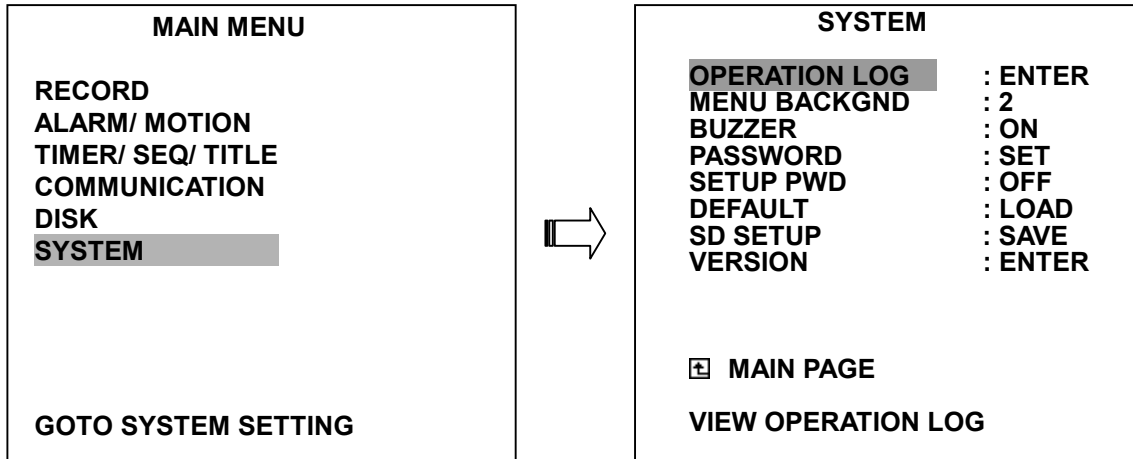

OPERATION LOG:

This log shows the history of the operation status in chronological order. What the following entries represent is detailed below.

- ON:** Powers up the device.
- OFF:** Powers off the device.
- REC:** Starts recording.
- STOP:** Ceases recording.
- PLAY:** Shows recorded video.
- V-IN:** Video input is connected.
- V-LOSS:** Video loss occurs.
- P-LOSS:** Power interruption occurs.
- A-IN:** Detects an alarm input.
- LOCK:** Disables the entire front panel controls.
- UNLOCK:** Releases the key lock.
- UPDATE:** Updates system software.

05/15/03	18:19:32	ON
05/15/03	18:19:32	OFF
05/15/03	18:19:32	REC
05/15/03	18:19:32	STOP
05/15/03	18:19:32	PLAY
05/15/03	18:19:32	V-IN
05/15/03	18:19:32	V-LOSS
05/15/03	18:19:32	P-LOSS

Note: The event log is able to store up to 2000 events. When the log is full, the newly registered record of an operation will replace the existing records from the oldest one.

MENU BACKGND:

There are 3 levels of background color transparency, you can choose from : level 1 is totally transparent, level 3 is opaque, and level 2 is between level 1 and 3. The background color is used in setup menu and search function.

BUZZER:

This option determines the embedded buzzer sounding a tone to signal the following situations. A tone lasts about two seconds long.

ON: Enables buzzer.

OFF: Disables buzzer.

Situation
Alarm occurs
Video loss occurs
Disk is full
Load factory default
Buzzer set to ON
Enable/disable key lock function
Power on /off mobile rack HDD
Backup operation complete
Timer activate/deactivate
Recording switching between HDD

PASSWORD:

This option allows you to set a password to prevent any unauthorized re-formatting of the hard disk drives or use by a network viewer. The standard password is "9999".

OLD PASSWORD: Enter the pre-set password (or the standard password if this is the initial setting) to access the password setting system.

NEW PASSWORD: Enter a 4-digit-number password of your choosing which will replace the pre-set password (or the standard password "9999").

SETUP PWD:

When this option is on, user must pass the password check before entering the setup menu.

ON: Enables it.

OFF: Disables it.

DEFAULT:

This option allows you to reload the factory default setting. Please do note that the password cannot be changed in the factory default setting.

SD SETUP:

The 4CH DVR offers a quick setup method by using a SD card. If the user wants to set up many a number of the same devices with the same settings, he can save the whole settings to a SD card, then transfer to another DVR.

SAVE: Saves the whole setting to the SD card.

LOAD: Loads the whole setting to the SD card.

VERSION:

This item is in the setup menu reveal network MAC, BIOS version, and software version, and last updated date.

```
MAC   : 00 : 0c : 0c : 00 : 00 : 07
BIOS  : 1.03
SW    : 1.00
DATE  : Mar 10 2003
```

6. RS-232 & RS-485 Protocol

6.1 Setup

6.1.1 Use a Null Modem cable (the standard RS-232 9 Pin Cable with Pin 2 and Pin 3 exchanged, see pin configuration chart below for details) to connect the COM 1 on the rear panel of the DVR to a PC.

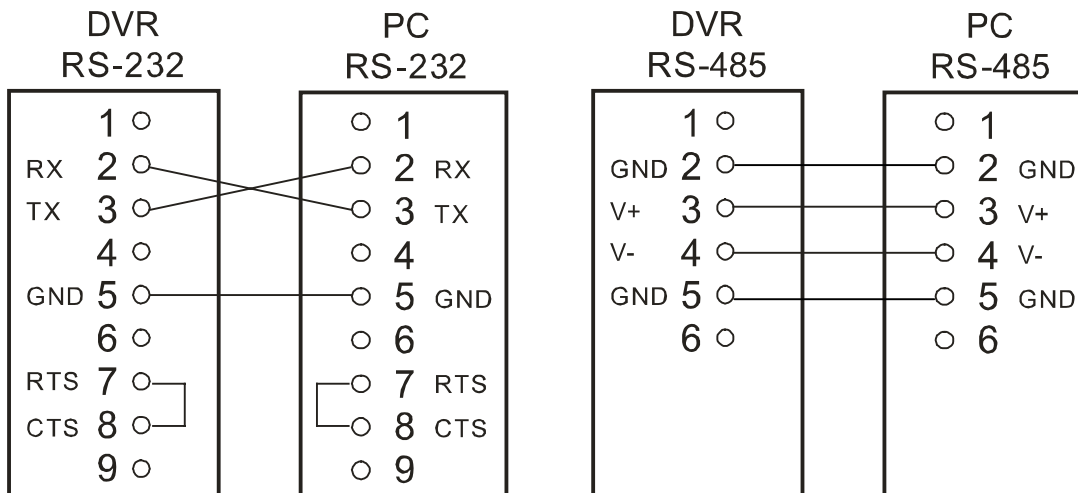

6.1.2 Set the **RS-232** option to **ON** in the **COMMUNICATION** page of the setup menu.

6.1.3 Set the PC communication parameters: 9600 bps, No Parity, 8 Data Bits, 1 Stop Bit.

6.2 Communication Protocol

6.2.0 General Command Format

<Lead Code = 0x41>, <Dest ID >, <Src ID >, <Main category >, <Second category >, {<Number of parameters>, <Parameter 1>, <Parameter 2> ...} <End Code= 0x4f>

Lead Code = 0x41
 Dest ID = 0x01
 Src ID = 0x20
 Main Category = 0x01 Keys and Signals
 = 0x02 Command
 Second Category = 0x01 Handshake
 = 0x02 Request Time/Set Time
 = 0x06 Request System State
 = 0x0b Time Search
 = 0x10 Request HDD Info
 = 0x11 Request REC Position
 = 0x12 Playback Immediately
 End Code= 0x4f

The different command types and their corresponding parameters are as follows:

6.2.1 Keys and signals

PC Send: <0x41>, <0x01>, <0x20>, <0x01>, <Key Value>, <0x4f>

< The value of a specific front panel key >

	DEC	HEX	
KEY_PLAY	1	01	
KEY_STOP	3	03	
KEY_PAUSE	4	04	
KEY_REC	6	06	
KEY_SETUP	7	07	
KEY_ENTER	8	08	
KEY_SEARCH	10	0A	
KEY_DISPLAY	11	0B	
KEY_UP	13	0D	
KEY_DOWN	14	0E	
KEY_LEFT	15	0F	
KEY_RIGHT	16	10	
KEY_MONITOR	36	24	
JOG_L	128	80	
JOG_R	129	81	
KEY_SHUTTLE_L8	130	82	(-100x, -1/16x)
KEY_SHUTTLE_L7	131	83	(-100x, -1/16x)
KEY_SHUTTLE_L6	132	84	(-30x, -1/8x)
KEY_SHUTTLE_L5	133	85	(-16x, -1/8x)
KEY_SHUTTLE_L4	134	86	(-8x, -1/4x)
KEY_SHUTTLE_L3	135	87	(-4x, -1/4x)
KEY_SHUTTLE_L2	136	88	(-2x, -1/2x)
KEY_SHUTTLE_L1	137	89	(-1x, -1/2x)
KEY_SHUTTLE_CT	138	8A	
KEY_SHUTTLE_R1	139	8B	(2x, 1/2x)
KEY_SHUTTLE_R2	140	8C	(4x, 1/2x)
KEY_SHUTTLE_R3	141	8D	(8x, 1/4x)
KEY_SHUTTLE_R4	142	8E	(16x, 1/4x)
KEY_SHUTTLE_R5	143	8F	(30x, 1/8x)
KEY_SHUTTLE_R6	144	90	(100x, 1/8x)
KEY_SHUTTLE_R7	145	91	(100x, 1/16x)
SIGNAL_REC_IN	163	A3	
SIGNAL_ALARM_RESET	165	A5	
SIGNAL_REC_OUT	169	A9	
SIGNAL_ALARM_IN	189	BD	
SIGNAL_ALARM_OUT	209	D1	

6.2.2 COMMAND Types

6.2.2.0 Command (Main Category=0x02)

6.2.2.1 Handshake (Second Category=0x01)

PC Request: <0x41>, <0x01>, <0x20>, <0x02>, <0x01>, <0x00>, <0x4f>

DVR Response: <0x41>, <0x20>, <0x01>, <0x02>, <0x08>, <0x00>, <0x4f>

6.2.2.2 Request Time (Second Category=0x02)

PC Request: <0x41>, <0x01>, <0x20>, <0x02>, <0x02>, <0x00>, <0x4f>

DVR Response: <0x41>, <0x20>, <0x01>, <0x02>, <0x02>, <0x07>, <7 Time Value >, <0x4f>

The following case is an illustration of < 7 Time Value >

2003/06/20 17:05:00 = <0xD3>, <0x07>, <0x06>, <0x14>, <0x11>, <0x05>, <0x00>

6.2.2.3 Set Time (Second Category=0x02)

PC Request: <0x41>, <0x01>, <0x20>, <0x02>, <0x02>, <0x07>, < 7 Time Value >, <0x4f>

The following case is an illustration of < 7 Time Value >

2003/06/20 17:05:00 = <0xD3>, <0x07>, <0x06>, <0x14>, <0x11>, <0x05>, <0x00>

DVR Act: Changing the time and date.

6.2.2.4 Request State (Second Category=0x06)

PC Request: <0x41>, <0x01>, <0x20>, <0x02>, <0x06>, <0x00>, <0x4f>

DVR Response: <0x41>, <0x20>, <0x01>, <0x02>, <0x06>, <0x01>,
<System State = 0..>, <0x4f>

Description of <System State>:

STATE_STOP	0
STATE_REC	1
STATE_PLAY	3
STATE_SETUP	6
STATE_SEARCH	7
STATE_BACKUP	15
STATE_NET_PLAY	23

6.2.2.5 Time Search (Second Category=0x0b)

PC send: <0x41>, <0x01>, <0x20>, <0x02>, <0x0b>, <0x06>, <6 Bytes Date/Time>, <0x4f>
where < 6 bytes Date/Time >, = year (2 bytes, =LowByte + HighByte*256), month (1 byte),
day (1 byte), hour (1 byte), min (1 byte)

Example: to search 06/12/2003 17:00 the Date/Time =

<0xd3>, <0x07>, <0x06>, <0x0c>, <0x11>, <0x00> where 2003= 210(=0xd3) + 7(=0x07) *256

6.2.2.6 Request HDD Info (Second Category=0x10)

PC send: <0x41>, <0x01>, <0x20>, <0x02>, <0x10>, <0x00>, <0x4f>

DVR Response: <0x41>, <0x20>, <0x01>, <0x02>, <0x10>, <0x32>, <0x00>, <0x00>,
<48 Bytes Data> <0x4f>

<48 Bytes Data>=4 HDD Status(Primary Master/Slave, Secondary Master/Slave)

Every HDD use 12 Bytes=

#0 :HDD Exist (if = 1)

#1 :Active HDD (if = 1)

#2 :Current HDD for REC (if = 1)

#3 :Current HDD for PLAY (if = 1)

#4...#7 :Capacity

#8..#11 :REC/PLAY Position

6.2.2.7 Request REC Position (Second Category=0x11)

PC send: <0x41>, <0x01>, <0x20>, <0x02>, <0x11>, <0x00>, <0x4f>

REC Mode

DVR Response: <0x41>, <0x20>, <0x01>, <0x02>, <0x11>, <0x08>, <HDD#>, <0x0>,
<4 Bytes REC Position>, <2 Bytes Image NO.>, <0x4f>

Get HDD#, REC Position and Image NO. used in Playback Immediately command (6.2.2.8)

Non REC Mode

DVR Response ERROR: <0x41>, <0x20>, <0x01>, <0x02>, <0x11>, <0x01>, <0x45>, <0x4f>

6.2.2.8 Playback Immediately (Second Category=0x12)

PC send: <0x41>, <0x01>, <0x20>, <0x02>, <0x12>, <0x0a>, <HDD#>, <0x0>, <0x0>, <0x0>,
<4 Bytes REC Position>, <2 Bytes Image NO.>, <0x4f>

DVR Playback Immediately

DVR Response: <0x41>, <0x20>, <0x01>, <0x02>, <0x12>, <0x00>, <0x4f>

DVR Playback ERROR

DVR Response ERROR: <0x41>, <0x20>, <0x01>, <0x02>, <0x12>, <0x01>, <0x45>, <0x4f>

NOTE: The DVR accepts RS-232 time search commands only under the live or playback Mode.

7. IDE Hard Disk Installation

Usually, the unit comes with one hard-disk drive installed in compartment HD 1, which is default-configured as a master. The jumper settings configuration of the installed hard-disk drives for the unit and compatible drives which can be used with this unit are listed in the table below. To install two hard disk drives in compartment HD 1 and HD 2, please take the following steps.

The jumper settings of hard-disk drives for the system

	Location	Jumper
IDE 1	Compartment HD 1	Master
IDE 2	Compartment HD 2	Master

7.1 Built-in hard disk

1.

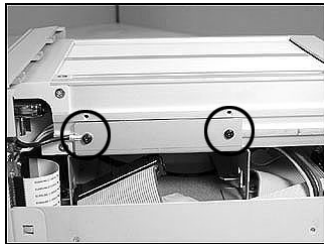

1. Unscrew all the mounting screws on the mobile rack of the unit and detach it.

2.



3.

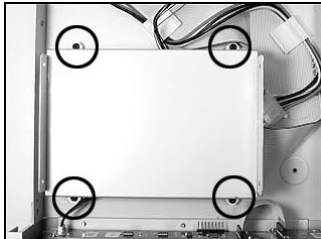

2. Carefully lift the mobile rack to a vertical position.

3. Unscrew the secured screws to detach the hard disk rack.

4.



5.



4. Setting the jumper of your hard disk driver. The way to set the jumper of the drive varies between manufacturers; please refer to the instructions on the driver to set the jumpers in the master position.

5. Place the hard disk in the rack.

6.

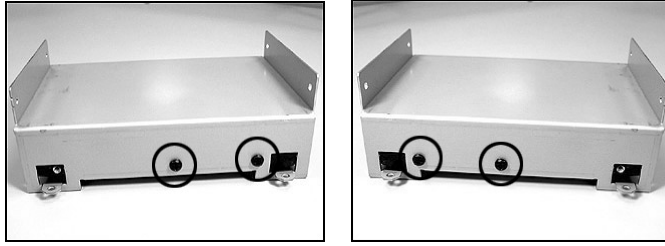

6. Secure the driver in the rack using two mounting screws in both the side-mounting holes. Please don't tighten the screws too much, otherwise that may damage the driver.

7.

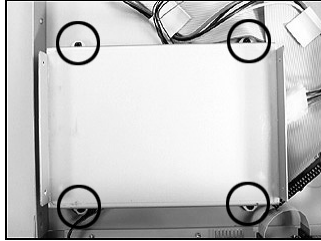

8.

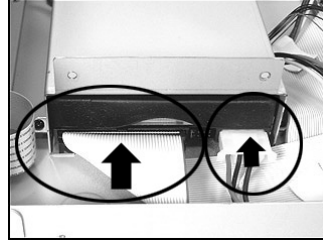

7. Screw the rack into the device, screwing in all the four screws.

8. Attach the interface connector and the power connector to the drive. Please note the red lining of the IDE cable and the red wire of power cable must line up side by side.

10.

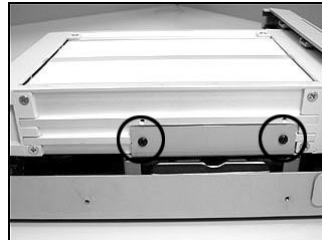
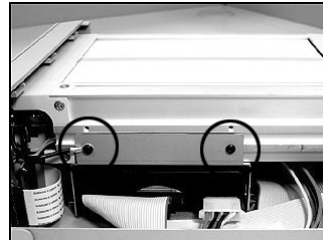
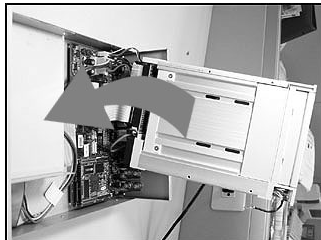

Place the mobile rack back onto the device and screw it in.

7.2 Mobile Rack HDD Installation



1. Make sure that the key is unlocked.



2. Pull the active-handle outward to remove the carrier body away from the mobile rack

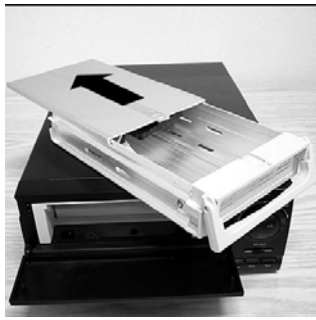

3. Slide the top cover backward and remove.



4. Setting the jumper of your hard disk driver. The way to set the jumper of the drive varies between manufacturers; please refer to the instructions on the driver to set the jumpers in the master position.

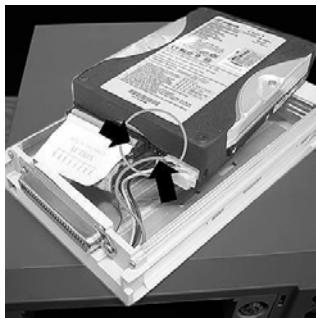

5. Attach the interface connector and the power connector to the drive. Please note the red lining of the IDE cable and the red wire of power cable must line up side by side.

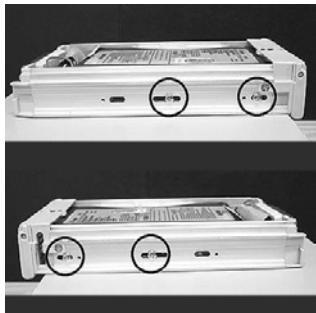

6. Place the HDD inside mobile rack, Use four of the provided screws.

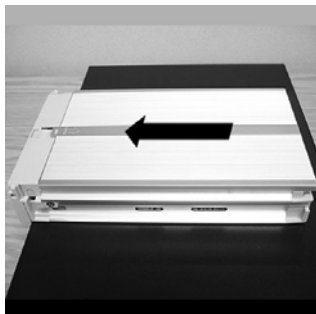

7. Place the top cover back to the carrier body by sliding forward to secure.



8. Slide the carrier body back in the mobile rack.



9. Push the carrier body further into the mobile rack until fully inserted.



10. Push the active-handle inward.



11. Lock the Key.

8. System Default

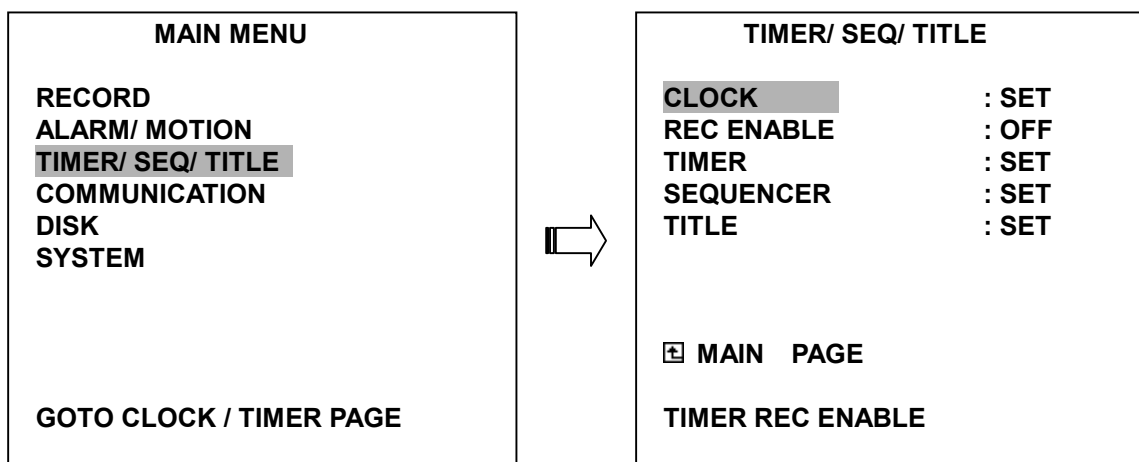
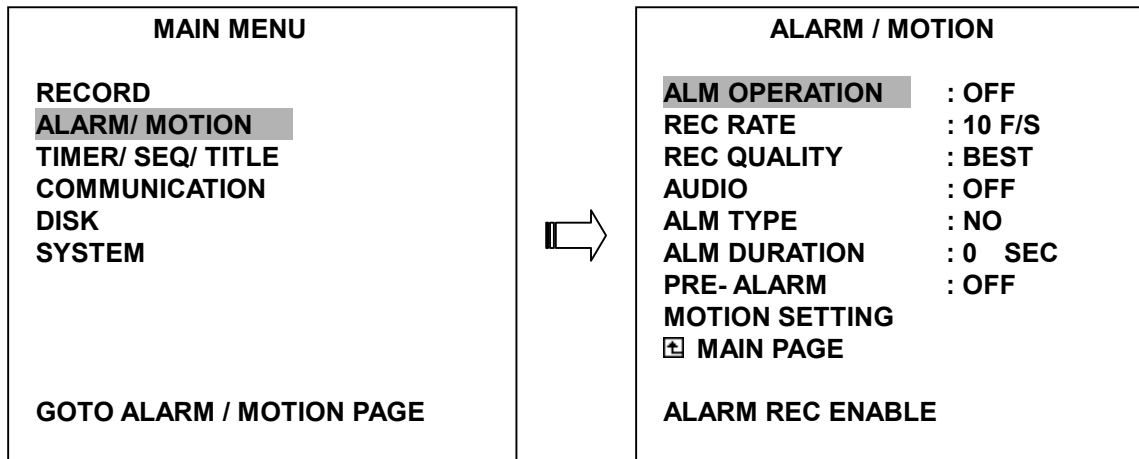
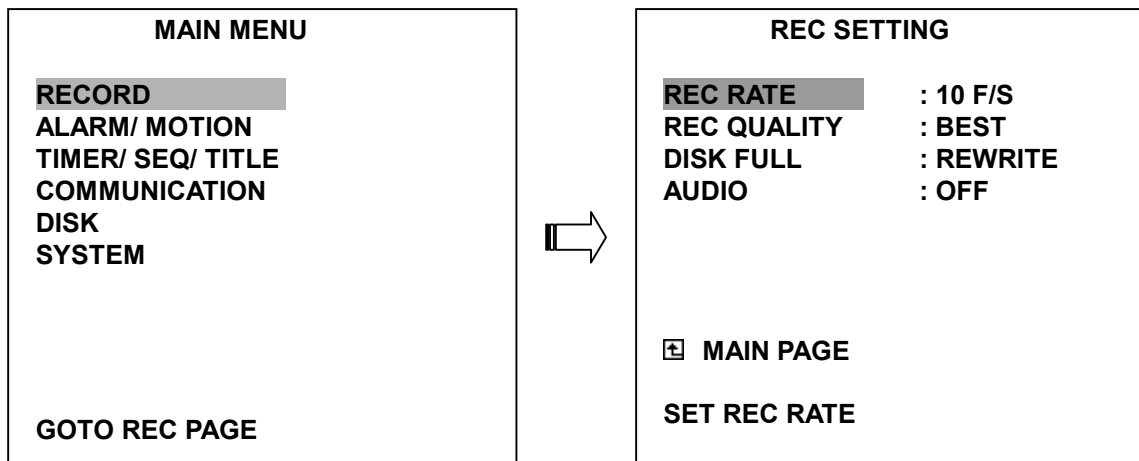

MAIN MENU

RECORD
 ALARM/ MOTION
 TIMER/ SEQ/ TITLE
COMMUNICATION
 DISK
 SYSTEM

GOTO COMM PAGE



COMM SETTING

COMM ID : 01
 RS232 : ON
 RS485 : ON
 NET ENABLE : OFF
 NET DHCP : OFF
 NET IP : SET
 FTP SETTING

☒ MAIN PAGE

SET RS232 / RS485 ID

MAIN MENU

RECORD
 ALARM/ MOTION
 TIMER/ SEQ/ TITLE
 COMMUNICATION
DISK
 SYSTEM

GOTO DISK PAGE



DISK SETTING

REFORMAT : HD 1 2
 HD 2 USAGE : REC
 BACKUP : FULL
 SD FILE : JPEG

☒ MAIN PAGE

DISK REFORMAT/CLEAR

MAIN MENU

RECORD
 ALARM/ MOTION
 TIMER/ SEQ/ TITLE
 COMMUNICATION
 DISK
SYSTEM

GOTO SYSTEM SETTING



SYSTEM

OPERATION LOG : ENTER
 MENU BACKGND : 2
 BUZZER : ON
 PASSWORD : SET
 SETUP PWD : OFF
 DEFAULT : LOAD
 SD SETUP : SAVE
 VERSION : ENTER

☒ MAIN PAGE

VIEW OPERATION LOG

9. O.S.D. Message

No.	O.S.D. Message	Meanings
1	NO DISK	No hard-disk detected after power up
2	BATTERY LOW	Suggest change the battery and reset the system time
3	LOADING	System Boot up
4	VIDEO LOSS	Video loss
5	VIDEO IN	Video input source
6	KEY LOCKED	Key lock function is on
7	KEY UNLOCKED	Key lock function is off
8	n1 OF n2 ITEMS PROGRESS n3 %	BACKUP n1/n2 NOW
9	BACKUP COMPLETE	Backup complete
10	HD2 SPACE NOT ENOUGH	HD2 has not enough space for backup
11	NO ENTRY FOR BACKUP	No backup is possible.
12	BACKUP INCOMPLETE	Backup incomplete, since the user has pressed the STOP button to stop it
13	NOT FOUND	The system cannot find a video in the Search function.
14	END	Playback of recorded video has reached the end point
15	DISK FULL	Hard disks are full; this happens only when the DISK FULL item in the setup menu is set to STOP.
16	EMPTY	The user presses the PLAY button or uses the SEARCH function, but no video can be played.
17	SET TO NTSC, PLS RESTART	System has to be set to NTSC, please reboot (PAL is similar)
18	SOFTWARE UPDATE	Software update
19	PLEASE RESTART	The system should be rebooted after the software has been updated
20	NO DISK	The user has pressed the Save key without putting in a SD card, or there is a disk error.
21	DATA NOT CONTINUOUS	The system found data in an installed HDD that cannot be used contiguously. Suggest you remove HD2 from the system.
22	DISK ATTACHED	HD2 has been attached.
23	DISK REMOVED	HD2 has been removed.
24	FAN STOPPED	The chassis fan has stopped for over 30 seconds.
25	HDn ERROR AT xxxxx	There is a hard-disk error during recording, where n is the hard-disk number and xxxxx is the hexadecimal location.
26	NOT PRESENT	When the user tries to clear a disk that was not attached in the setup menu.
27	SAVE TO DISK	Start saving to the JPEG file.
28	SAVE TO Fnnn. JPG	Save to Fnnn. JPG (where nnn= 0..999)
29	SAVE OK	Save to the JPEG is ok.
30	SD CARD WRITE PROTECT	A SD card is write-protected; or there is an error
31	WAIT . . .	The composition of the hard disk is changing now. Or, it is saving the image into the SD card. Please wait for a while.

10. Network Viewer and Image Viewer

This section provides instructions for installing and using the Network Viewer, and Image Viewer, which are included with the 4CH DVR. The programs can be operated by a selected PC equipped with the following requirements.

1. Intel Pentium 233MHz at least.
2. 32 MB RAM
3. Window 95, 98, NT, and ME.
4. 4 MB Video card capable of 24-bit true color display.
5. 5 MB free hard-disk space for software installation.
6. 10-base T network for LAN operation.

10.1 The Network Viewer

10.1.1 Introduction to Network Viewer

The Network Viewer allows you to potentially access unit of the 4CH DVR from a remote desktop or a laptop in a TCP/IP networking environment. It can perform the following functions.

- View live images from the 4CH DVR
- Store, search, and review recorded video from the 4CH DVR HDD.
- Change the regular record, event record, and timer properties.

Before you are ready to view images from a desktop, you need to have your 4CH DVR networked by obtaining a 10 base Ethernet data cable (Standard RJ-45) to connect the 4CH DVR to your LAN/WAN. Now enter the main menu to set the IP address.

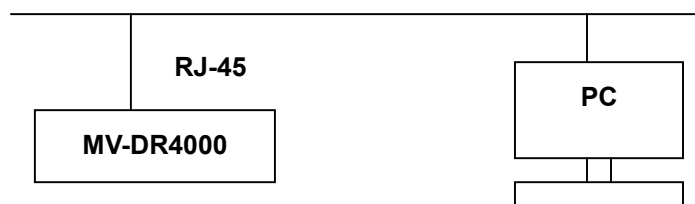

RJ-45 PIN configuration for Ethernet

PIN NO.	PIN Assignment
1.	TX +
2.	TX -
3.	RX +
4.	Not Connected
5.	Not Connected
6.	RX -
7.	Not Connected
8.	Not Connected

RJ-45 socket

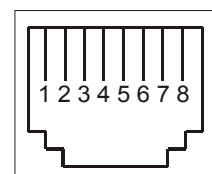

Physical specification for Ethernet

Wire Type	Cat. 5
Connector Type	RJ-45
Max. Cable Length	30 m
Hub Wiring Configuration	Straight Through
PC Wiring Configuration	Cross Over

NOTE: For more details on network connections, please refer to the following document.

10.1.2 Install the Network Viewer in your PC

Install the Network Viewer from the supported CD-R.

1. Exit all applications currently running in the selected PC.
2. Insert the supported CD in the CD-ROM drive. The program will execute the installation automatically. Follow the on-screen instructions to proceed with the rest of the installation procedure as they appear.
3. After the installation is complete, pop up the **START** menu from your computer, and point to **Programs / 4CH DVR Network Viewer** to open up the program selection page as shown below. Click the **4CH DVR Network Viewer** tag to start the **4CH DVR Network Viewer** program.

Install the Network Viewer for the ZIP file.

1. Save the ZIP file to your PC and extract the file to a designated directory.
2. Open the extracted folder.



3. Click on the  icon to execute the installation and then follow the on-screen instructions to proceed with the rest of the installation procedure as they appear.
4. After the installation is complete, pop up the **START** menu from your computer, and point to **Programs / 4CH DVR Network Viewer** to start the **4CH DVR Network Viewer** program.

NOTE: Please make sure the TCP/IP communication software has been properly set and configured in your computer. To check your TCP/IP settings, refer to the following document.

10.1.3 View the 4CH DVR video from a remote PC

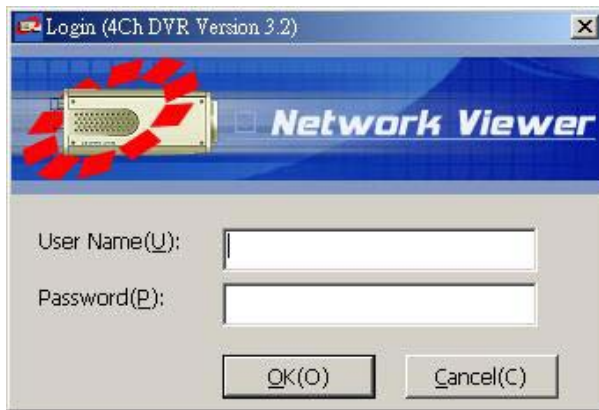

Once Network View is executed a Login prompt will appear, you must enter the default User Name: **admin**, password: **9999** into the respective field and click on OK to log into the application.

Follow the instructions below to use the Network Viewer to browse a 4CH DVR video from a remote location. Upon entering the Network Viewer, the connection box will appear as follows.

1. Click the **Find** tag to connection of the all DVR device in the LAN.
2. Choose a channel number from the Channel drop-down list.
3. Type in the user name for the chosen 4CH DVR.
4. Type in the password of the device and click the **Modify** tag to add the device to the Device List.
5. Please repeat steps 2 to 4 again for another desire.
6. Select the 4CH DVR to enter this device.
7. Click the **Login** tag to begin viewing images.



NOTE: Upon connection, the connection status box indicates the name and IP address of the selected device. If there's a failure to connect, a "Fail" message appears on the screen right after the device IP address; otherwise an "OK" appears. To add more connections or units to the 4CH DVR, please repeat the above instructions.









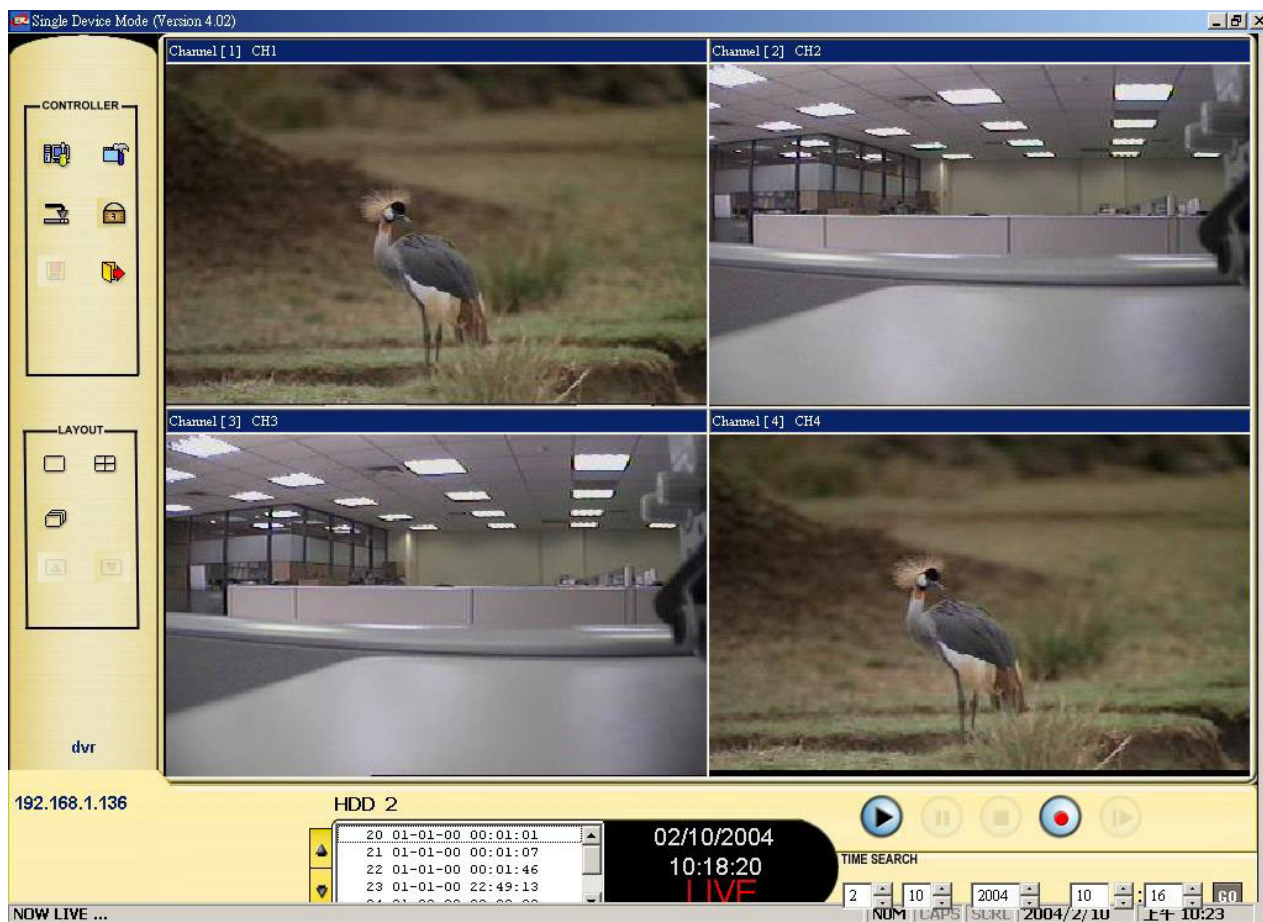

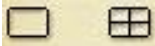

Functions	Description
● Device List	Displays the entire list of connected devices if and as necessary. This list includes a lot of information about all the connected devices.
● DVR Number	Assigns a display location when you have multiple devices connected.
● Device Type	Displays the device type.
● Device Title	This blank allows you to assign a label to the chosen device.
● IP Address	Type in the IP address which you preset for the device
● User Name	This space allows you to assign a name to the chosen device.
● Password	Type in the preset password for making a connection.
● Add	Click to add the settings of a chosen device.
● Modify	Click to change the settings of a chosen device.
● Delete	Click to remove the connection of a chosen device.
● Find	Click to find the connection of the all 4CH DVR device in the LAN.
● Login	Click to access the display page of the Network Viewer.

Viewing images

View the connected device

Once the connection has been established, click the **Login** tag to enter the single-device mode window. (See the sample screen below) This window displays the connected device in the sequence which has been arranged when you established the connection.



Function Buttons	Description
	<p>Playback function bar.</p> <ul style="list-style-type: none"> ● Play- Click to a recorded video from the PLAY LIST. ● Pause- Click to freeze the image. ● Stop- Click to stop playing back the recorded video or cease recording. ● REC- Click to activate the recording function of the device. ● Step- Click to view images picture-by-picture.
	<p>The Split-Screen display function bar. This allows you to display the connected device in the multi-format screens of 1, and 2x2.</p>
	<p>Press to enter the PC SYSTEM SETUP window, which allows you to program the System Setup, Record Setup, and Alarm Setup.</p>
	<p>Press to enter the DEVICE SETUP window, to open the device setting page to add more devices for viewing, Which allows you to program the Record Setting and Record Schedule.</p>
	<p>Click to minimize the Network Viewer into a PC system tray.</p>
	<p>Click to lock the system.</p>
	<p>Click to save a viewing image in the local computer.</p>
	<p>Press to leave the Network Viewer program.</p>
	<p>The single sequence.</p>
	<p>Click to page up.</p>
	<p>Click to page down.</p>
	<p>Recorded video list box. This box allows you to access all recorded video, which are stored in the HDD of the connected devices. To review a recorded video, just click an entry from the list and click the  button. PgUp/PgDn: To scroll up and down the list.</p>
	<p>4CH DVR Status Box. This box indicates the selected device status. PLAY: The device is in the playback mode. LIVE: The device is in the live display mode. WAIT: The device is processing the command. PAUSE: Pauses the image.</p>

TIME SEARCH

6	30	2003	19	33	GO
---	----	------	----	----	----

This allows you to search a recorded video kept in the HDD of the device. Enter the MONTH/DAY/YEAR HOUR: MINUTE you wish to search and click GO to proceed.

dvr
192.168.1.103

Every 4CH DVR has to own an IP address and a title to be identified on the network. This area displays the title and the IP address of the 4CH DVR.



Image display area. Displays the images of each camera and the title and time/date information on the top blue bar. Double click the image to view a full screen of the camera.

10.1.4 Change the Record & Timer Properties Via the Network

Follow the instructions below to reconfigure the record and schedule recording settings via the network.

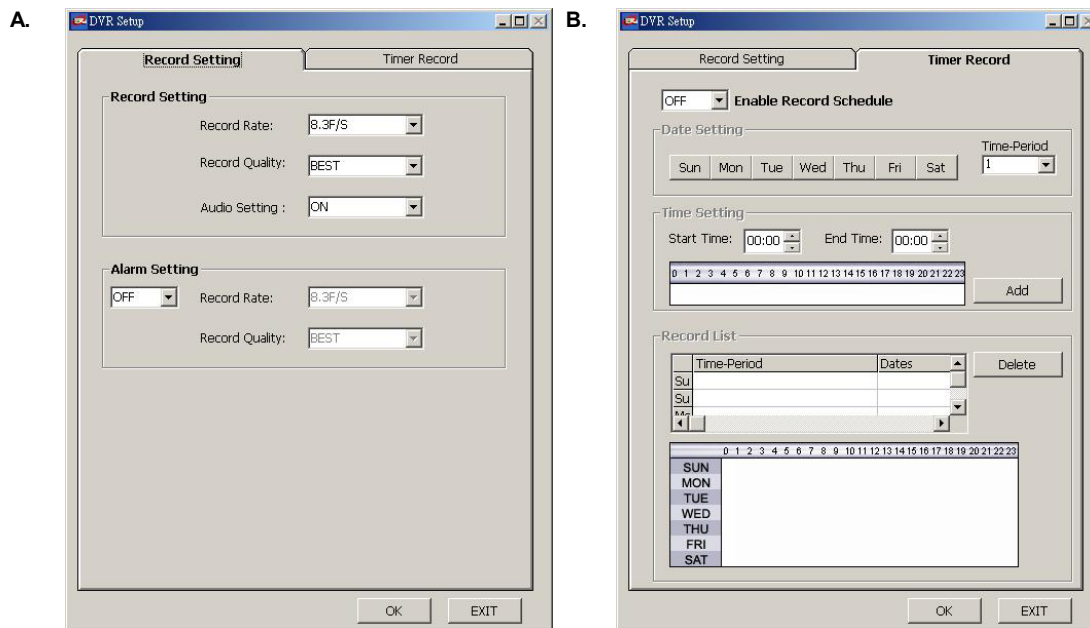

Set the regular record settings

1. When in the single –device mode, click  to enter the SETUP page. (See the sample screen as in A above)
2. Select a desired recording rate and Quality from the corresponding drop-down list
3. Click the **OK** tag to proceed.

Set the Alarm record settings

1. When in the single –device mode, click  to enter the SETUP page. (See the sample screen as in A above)
2. Set the ALRM SETTING to ON to enable the drop-down list in the ALARM SETTING area.
3. Select a desired recording rate and Quality from the corresponding drop-down list.
4. Click the **OK** tag to proceed.

Set the Record Schedule

1. When in the single –device mode, click  to enter the SETUP page. (See the sample screen as in B above)
2. Set the **Record Schedule** to **ON** to enable the **Record Schedule** setting area.
3. Click the **Time-Period** button to set the schedule for recording for each day. Go to both the **START TIME & END TIME** boxes, enter a specific **Hour: Minute** and click **Add** button to add to the **Record List**.
4. When all required settings are completed, click **OK** to proceed.

10.1.5 Archive Images to the Computer

Playback images can be stored in a local PC in the JPEG format. Follow the instructions below to save the viewed images or videos to your PC.

1. Press  to enter the following sample screen whenever in the playback mode.
2. Select a folder in the computer for copying images in.
3. Enter the number of images into the **NUMBER OF SAVING** box you wish to save in.
4. Click the **SAVE** tag; the program will automatically copy the displayed images into the designated folder. The images are saved under the DVRxxx.jpg file names, which are displayed in the box on the right-hand side. To view a saved image, please follow the instructions in the next section.
5. Saving videos: click the **AVI** tag to save images in a single file; the program will open a window which enables you to select the path of saving video recordings of any number of images (up to a maximum of 256) you wish to save (see step 3 above).

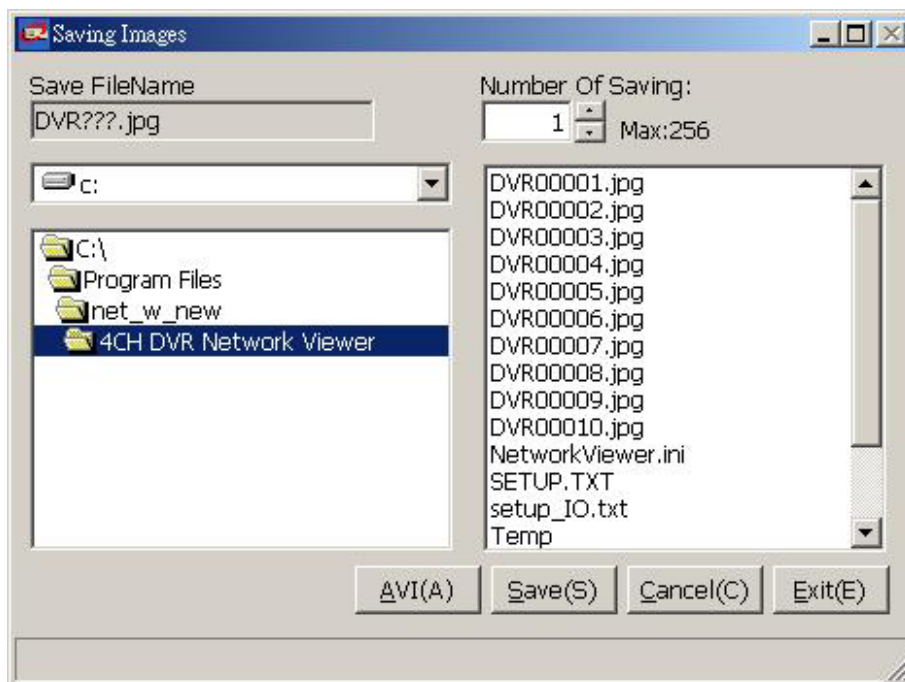

10.2 The Image Viewer

This is image integrity-protect software. It not only allows you to view an archived image from the SD card or HDD of a computer, but also protects an archived image from reproduction or interpolation. If an image isn't in the original format made by a 4CH DVR, the Image Viewer won't display the image and instead will send a warning message "Wrong File, Can't Open". Follow the instructions below to open an archived image from a SD card or a HDD.

1. Pop up the **START** menu from your computer, and point to **Programs / 4CH DVR Network Viewer** to open up the program selection page. Click the **Image Viewer** tag to start the **Image Viewer** program. (See a sample screen below.)
2. Click the **PRINT** tag to get a displayed image printed out from a printer.

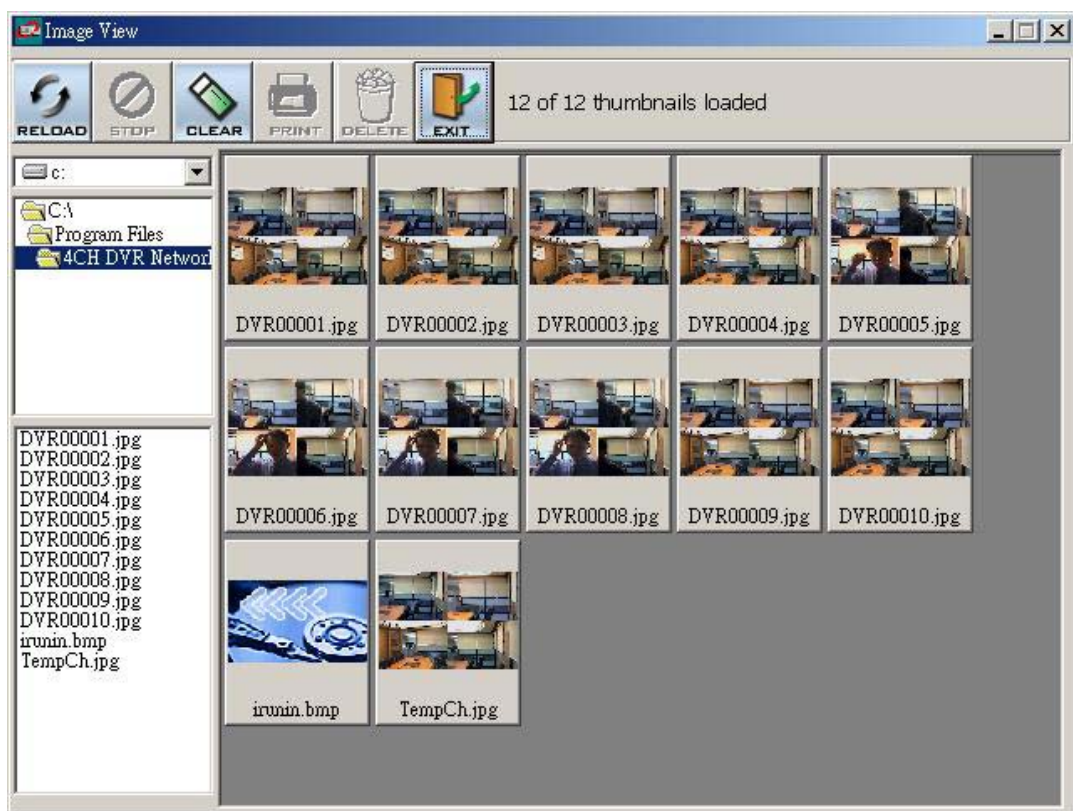

11. Index Table

The following description details how the DVR manages an index table issue.

The DVR will generate a time index table indicating recorded data is kept in a particular HDD. This allows to individually selecting recorded data to be displayed via the alarm list search and full list search. The maximum number of lists, for a given HDD, is 3000. When the list of any given HDD is used up-and the disk is not full, The unit will still use the rest of the space for recording. In such a case, an index for the recent recorded data will be generated and the index of the next oldest data will be erased so that the list does remain 3000 in total. And the next oldest data will be kept in the index of the corresponding oldest data. For any newly recorded data, this approach will be applied until the disk becomes full.

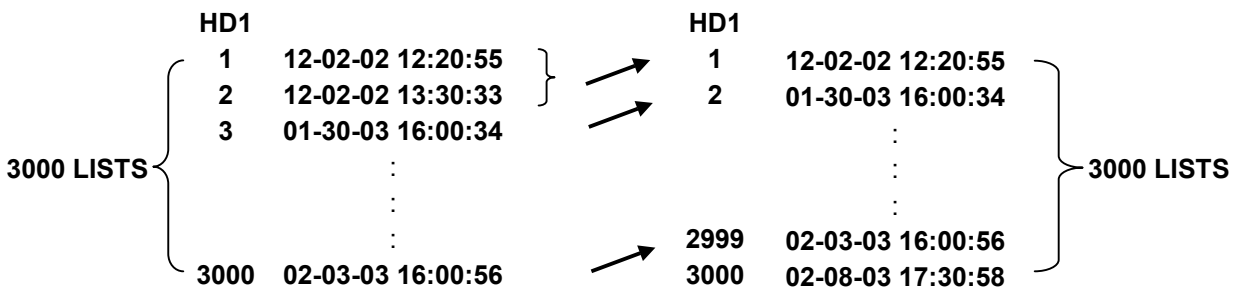

In the rewrite recording mode, when the archived hard disk drive is full, the DVR will start overwriting the oldest data recorded. As the previous recorded data was partially overwritten by the recent recording, the indicating time index of that data will be changed corresponding to the starting time of the remaining session. The index of the session will be deleted from the table when it is fully overwritten.

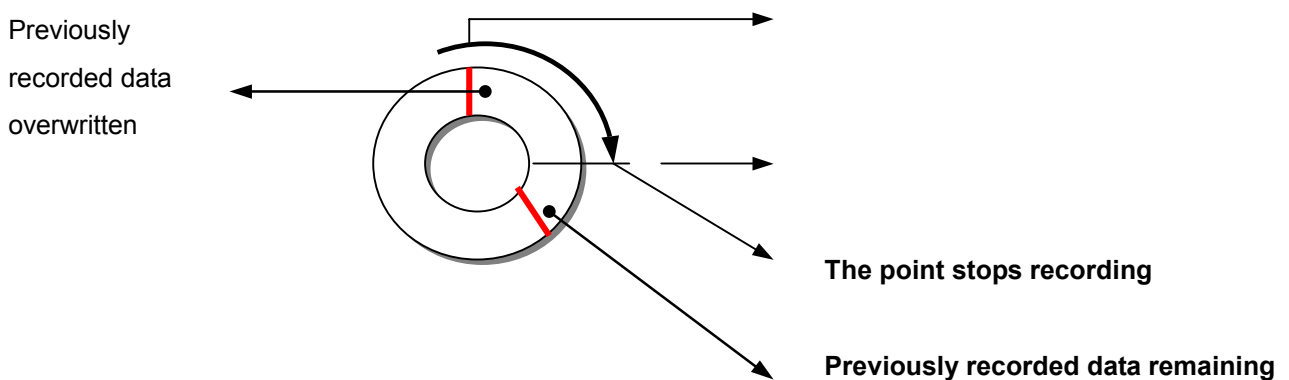

12. Network Configuration

12.1 Cable Connections

Please follow the instructions below to connect your **MV-DR4000** to a computer or a network and to choose a proper RJ-45 cable configuration for connections.

Physical specification of RJ-45 cable for Ethernet

Wire Type	Cat. 5
Connector Type	RJ-45
Max. Cable Length	30 m
Hub Wiring Configuration	Straight Through
PC Wiring Configuration	Cross Over

12.1.1 Connect to a computer

Use a crossover LAN cable to connect directly to a computer.

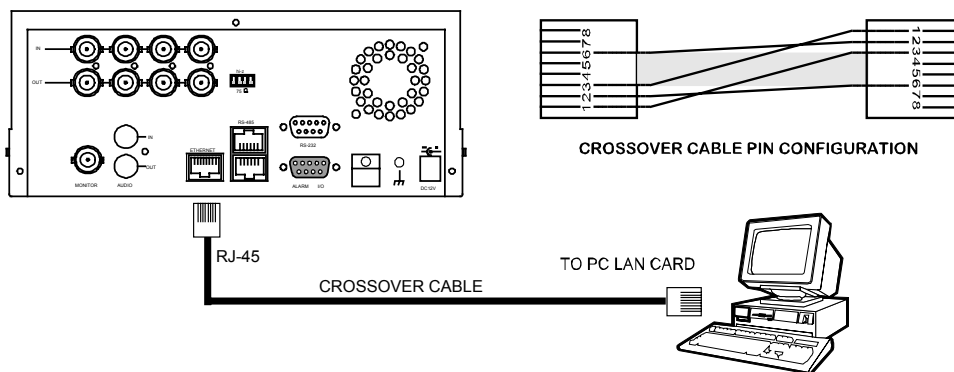

12.1.2 Connect to a LAN Hub (INTRANET)

The RJ-45 PIN configuration for connecting with a LAN Hub is shown below.

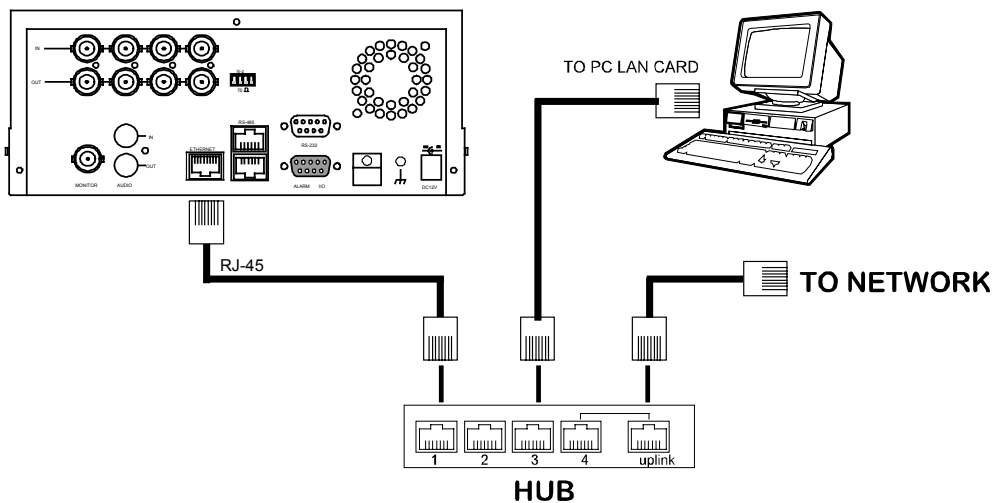

RJ-45 PIN configuration for LAN Hub

PIN NO.	PIN Assignment
1.	TX +
2.	TX -
3.	RX +
4.	Not Connected
5.	Not Connected
6.	RX -
7.	Not Connected
8.	Not Connected

RJ-45 socket

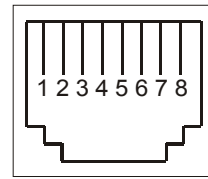

12.1.3 Connect to WAN (INTERNET)

The RJ-45 PIN configuration for connecting to a WAN is the same as connecting to a LAN.

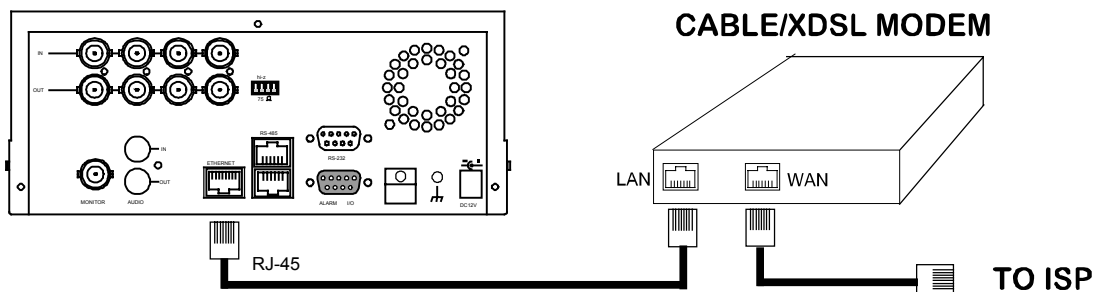

12.2 Configure Your DVR Network Settings

Upon network hardware connection, you need to activate the network function and configure the proper network settings of the DVR.

12.2.1 Enable DVR Network Function

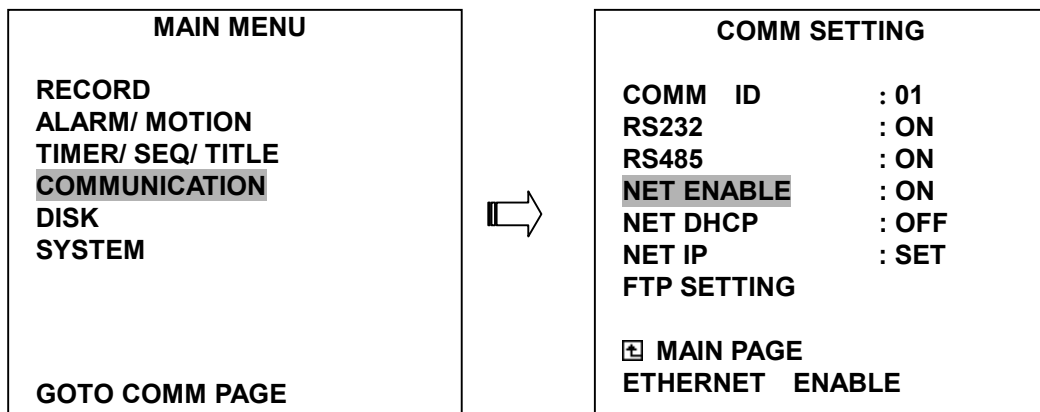

- Press the **Setup** button to enter the OSD MAIN MENU. Please use the “<” “>” buttons ⑪ and ⑭ to highlight COMMUNICATION; then press the **Enter** button to enter the COMM SETTING page.
- Use the “^” “v” buttons ⑫ and ⑬ to highlight NET ENABLE; select ON. Then press the **Enter** button to proceed.

12.2.2 Enable DHCP Function

- Use the “**▲**” and “**▼**” buttons **12**, and **13**, to highlight NET DHCP; select ON. Then press the **Enter** button to proceed.

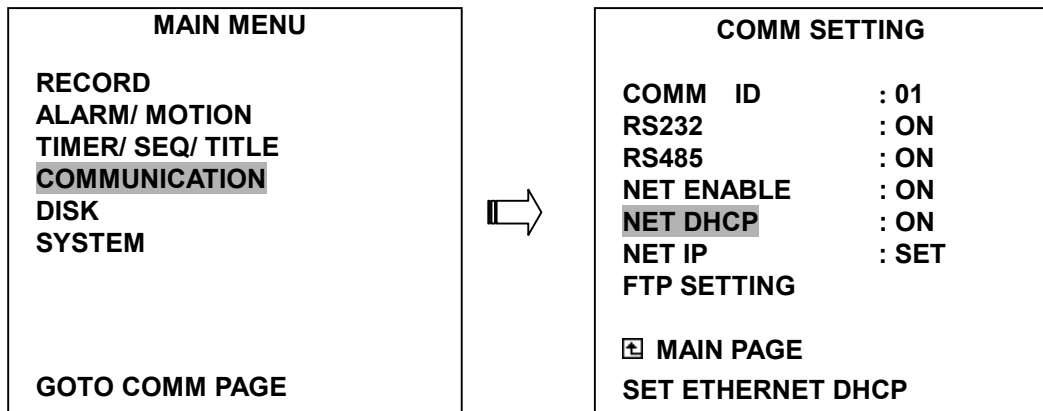

NOTE: This function can only work if the LAN which the unit is connected to has a DHCP server. If the DHCP server is working, the DVR will obtain an IP address automatically from the DHCP server. In that case please skip the section 2.3 (Set IP address) and follow section 3. (TCP/IP Communication Software).

12.2.3 Set IP Address

You don't need to set a NET IP for the unit if the LAN which the unit is connected to has a DHCP server. Otherwise, please follow the instructions given below:

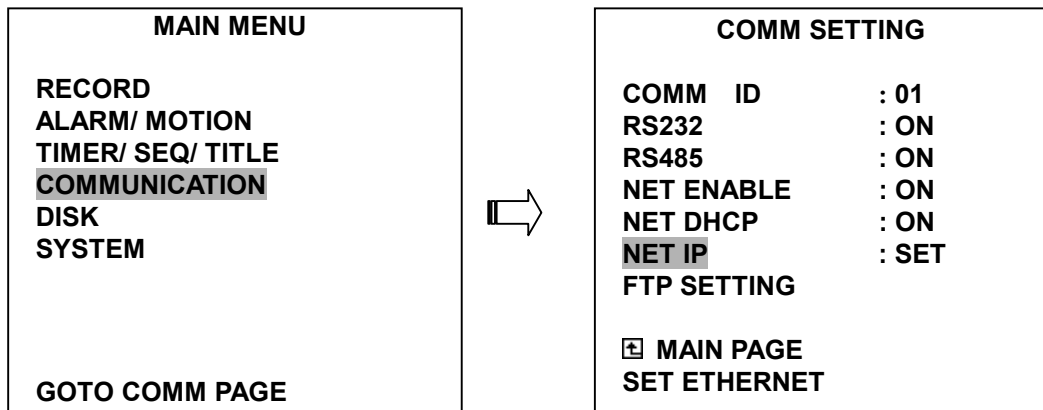

Use the “**▲**” and “**▼**” buttons **12**, and **13**, to highlight the NET IP. Press the **Enter** button to enter the NET IP page

- Set the IP, MASK and GATEWAY. Then press the **Enter** button to proceed. The following is a sample setting.
IP: 192.168.0.1
MASK: 255.255.255.0
GATEWAY: 0.0.0.0
HTTP PORT: 80

NOTE: When only one unit of the DVR is connected to a computer or LAN, you can freely assign an IP address for the DVR. For example, there are a range of DVR IP addresses from 192.168.0.1 to 192.168.0.255. You can pick one for use from the range of the IP. It's not necessary to set MASK and GATEWAY; leave the settings as default.

When a DVR is connected to a WAN, you must acquire a unique, permanent IP address and correctly configure the MASK and GATEWAY settings according to your network architecture. If you have any questions regarding those settings, please contact a qualified MIS professional or your ISP.

NOTE: When connecting to a network, each connected DVR must be assigned a unique IP, which must be in the same class type as your network address. IP addresses are written as four sets of numbers separated by periods; for example, 192.168.0.1. Therefore, if the connected network is identified as Class C, for example, the first three sets of numbers of the DVR IP address must be the same as the network address. If the connected network is identified as Class B, the first two sets of numbers of the DVR IP address must be the same as the network address. If you have any questions regarding these settings, please contact a qualified MIS professional or your ISP.

12.3 TCP/IP Communication Software

Follow the instructions below to install the TCP/IP communication program into your computer.

- Click the **Start** Menu from your computer, and point to the **Settings/Control panel**.

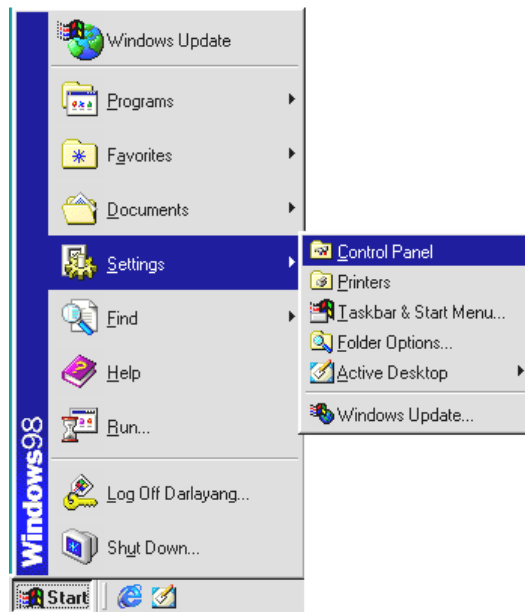

- Click the **NETWORK** icon twice to enter the **NETWORK** setting windows.

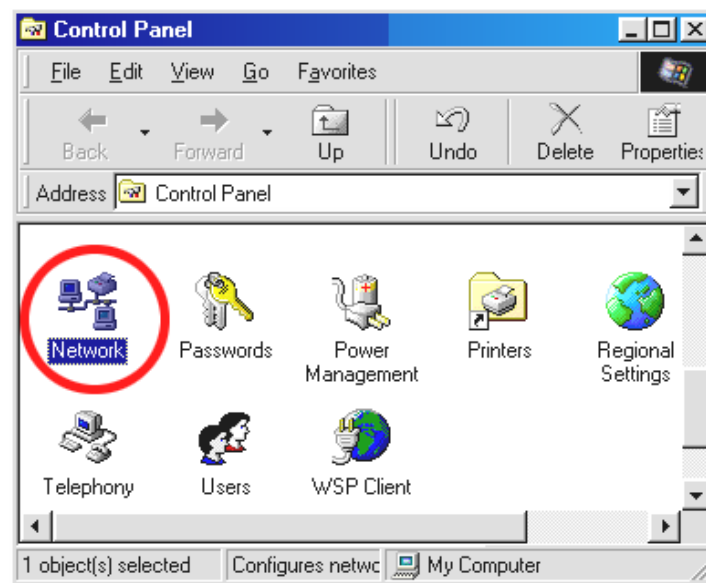

- Click on the **Configuration** tag; check if the TCP/IP is included among the network components list. If the TCP/IP is included, please process step 5. If it is not included, please follow step 4 to install the TCP/IP.

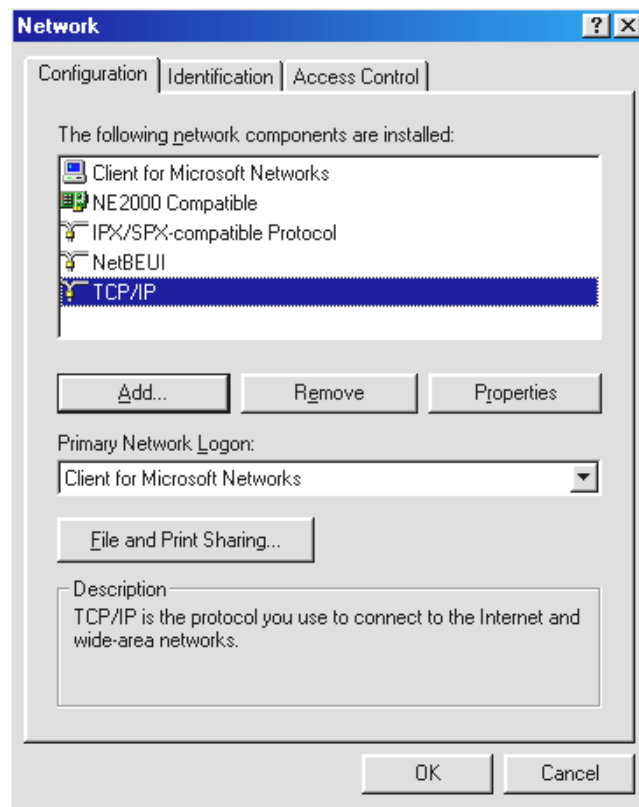

12.4 TCP/IP installation

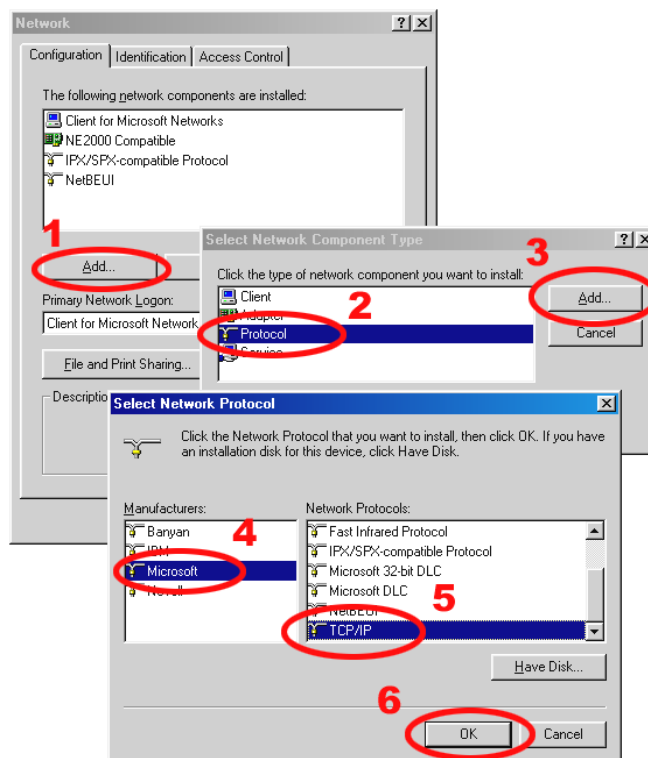

During the installation, you will be requested to insert the windows 98 CD ROM. After installation, the PC will be restarted.

12.5 TCP/IP Configuration setting

- Click **Start → Settings → Control Panel → Network**.
- Select **TCP/IP**, and then click **Properties**.
- Before processing the DVR installation in a WAN, please make sure the Internet connection works properly. If not, please contact your ISP provider.

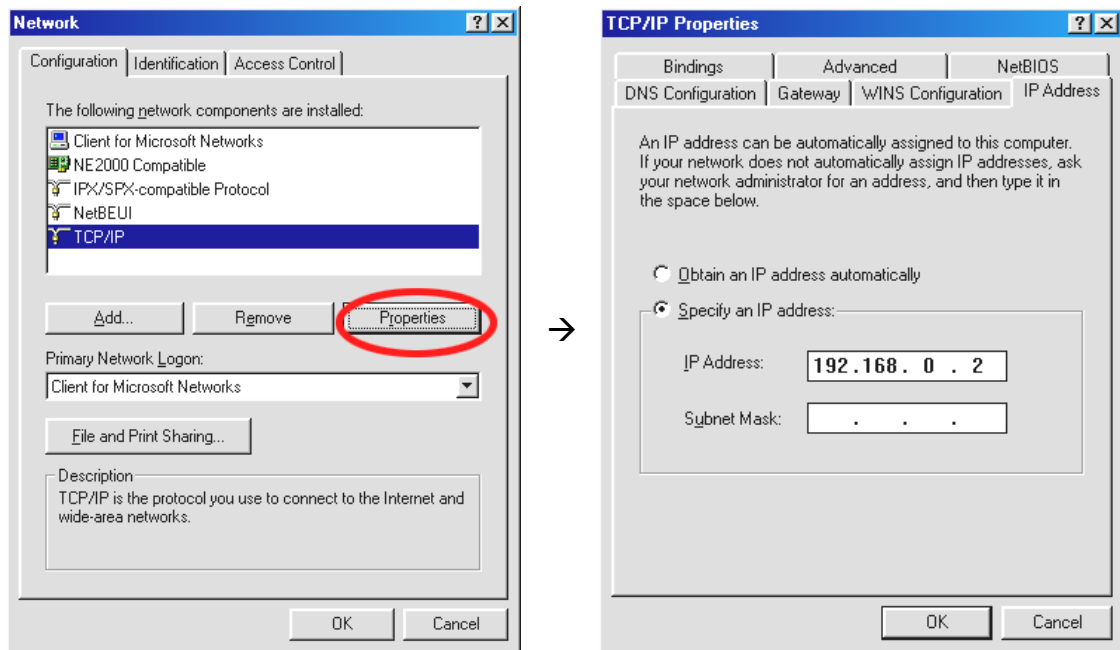

If you are using a DHCP server, please select **Obtain an IP address automatically**. Any assigned IP address for the connected DVRs must be in the same class type as the server. If there is no DHCP server, please select **specify an IP address** and type in the IP address of your PC. This IP address must be different from the DVR IP but in the same class type.

NOTE: The IP address of a DVR in a network must be unique to itself as opposed to those of the other chosen PCs, but in the same class type

12.6 Connection Testing

With the previous settings, follow the instructions below to ensure whether you have established the connection successfully.

- Click **Start → Programs → MS-DOS Prompt**

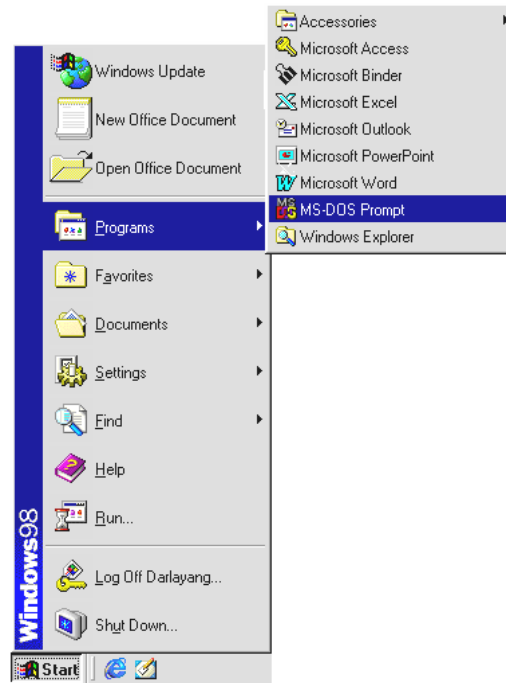

- Type in **ping 192.168.0.1** then Enter. (See the sample screen below)
*** This IP is the DVR IP address that is assigned for the connected DVR in step 2.*

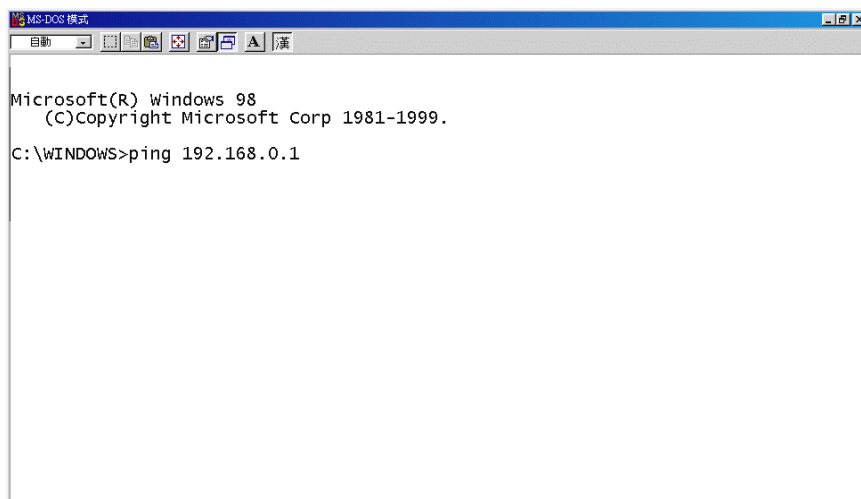

- If you receive a response as in the sample screen below, the connection hasn't been successfully established. Please re-check all the hardware and software installation by repeating steps 1 to 5. If you still can't establish the connection after rechecking, please contact your dealer.

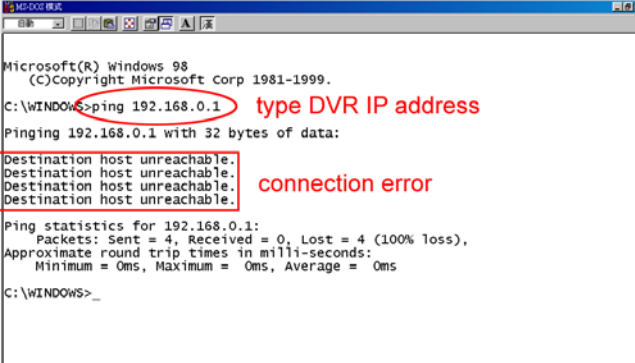

```
Microsoft(R) Windows 98
(C)Copyright Microsoft Corp 1981-1999.
C:\WINDOWS>ping 192.168.0.1
Pinging 192.168.0.1 with 32 bytes of data:
Destination host unreachable.
Destination host unreachable.
Destination host unreachable.
Destination host unreachable.
Ping statistics for 192.168.0.1:
    Packets: Sent = 4, Received = 0, Lost = 4 (100% loss),
    Approximate round trip times in milli-seconds:
        Minimum = 0ms, Maximum = 0ms, Average = 0ms
C:\WINDOWS>
```

- If you receive a response as in the sample screen below, you have successfully made the connection.

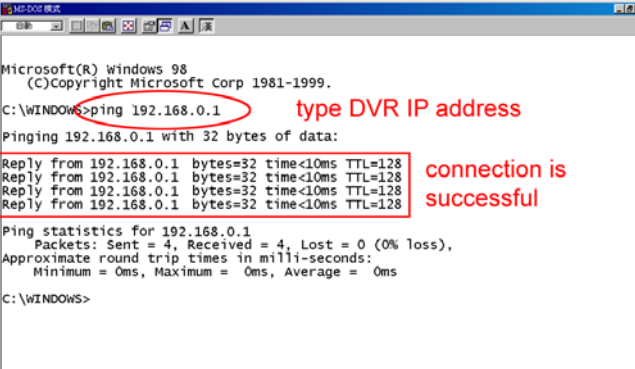

```
Microsoft(R) Windows 98
(C)Copyright Microsoft Corp 1981-1999.
C:\WINDOWS>ping 192.168.0.1
Pinging 192.168.0.1 with 32 bytes of data:
Reply from 192.168.0.1 bytes=32 time<10ms TTL=128
Reply from 192.168.0.1 bytes=32 time<10ms TTL=128
Reply from 192.168.0.1 bytes=32 time<10ms TTL=128
Reply from 192.168.0.1 bytes=32 time<10ms TTL=128
Ping statistics for 192.168.0.1:
    Packets: Sent = 4, Received = 4, Lost = 0 (0% loss),
    Approximate round trip times in milli-seconds:
        Minimum = 0ms, Maximum = 0ms, Average = 0ms
C:\WINDOWS>
```

13. Microsoft Internet Explorer

This section provides instructions for using the Microsoft Internet Explorer, which are included with the 4CH DVR.

13.1 Connecting the 4CH DVR

Start up the Microsoft Internet Explorer, and then follow the steps given below to connect the 4CH DVR:

1. Click the URL block at the top of the screen.
2. Type in the URL address of the 4CH DVR into the URL block and press the “**Enter**” button to enter the login page. The default User Name and password is **admin** and **9999** respectively.
3. Enter the user name (Login Name).
4. Fill in the password (Password).
5. Click the “**Login**” button and enter the home page of the 4CH DVR: both the user name and password must be provided correctly.



The screenshot shows a web browser window displaying the login page for a 4CH DVR. The page has a light blue header with the text "DVR". Below the header, there are two input fields: "User name:" followed by a text box, and "Password:" followed by a text box. Below the password field is a button labeled "Login".

Description of functional keys:

Login Name: Enter the user name in the blank space.

Password: Fill in the password in the blank space.

Login: Click to enter the home page of the 4CH DVR.

Browsing images from the 4CH DVR:

The images from the 4CH DVR will be displayed on the home page while going online with the 4CH DVR. There are some buttons provided on the bottom of the home page for further setting:

The screenshot shows the DVR web interface. On the left, there are four camera feeds showing an office interior. On the right, there is a 'DVR' control panel with tabs for 'Viewer', 'Setup', and 'PTZ'. Below the tabs is a 'PLAY LIST' with four entries:

Item	Date/Time	Action
1	10-02-03 14:08:34	▶
2	10-02-03 14:42:07	▶
3	10-02-03 15:36:58	▶
4	10-03-03 08:21:04	▶

Below the play list are 'HD2', 'PgUp ▲', and 'PgDn ▼' buttons. At the bottom, there is a status bar showing '[LIVE] 10-08-2003 11:22:02' and a row of control buttons: 'STOP', 'PLAY', 'PAUSE', 'REC', and 'LOG OUT'. Below the buttons is a 'TIME SEARCH' section with date and time input fields and a 'GO' button.

Function Buttons	Description
	Click to stop playing back the recorded video or to cease recording.
	Click to a recorded video from the PLAY LIST.
	Click to freeze the image.
	Click to activate the recording function of the device.
	Click to leave the home page of the 4CH DVR.
	Press to enter the SETUP window, and open the device setting page in order to add more devices for viewing. This allows you to program the Record Setting and Record Schedule.
	Press to enter the IMAGE window and open the device home page for viewing.
	Click to open the control panel and remote control the pan/tilt/zoom function camera live over a local area network or the Internet



Recorded video list box. This box allows you to access all recorded video, which are stored in the HDD of the connected devices. To review a recorded video, simply select an entry from the list and click the ▶ button.

PgUp/PgDn: Enables you to scroll up and down the list.

[LIVE] 10-08-2003 11:22:02

4CH DVR Time & Status Box. This box indicates the selected device status.

PLAY: The device is in the playback mode.

LIVE: The device enters the live display mode.

TIME SEARCH: Date 2003 / 10 / 02 Time 14 : 08 GO

This allows you to search a recorded video stored in the HDD of the device. Enter the YEAR/MONTH/DAY HOUR: MINUTE you wish to search and click the GO button to proceed.



Image display area. Displays images from the 4ch cameras.

13.2 Change Record / Alarm Setting

Please follow the steps given below to change the Record / Alarm setting through the network as and when necessary.

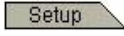
1. Click the  button on the home page to enter the Record / Alarm setting page.



DVR

Viewer Setup PTZ +

•RECORD/ ALARM
•TIMER RECORD

REC SETTING

RATE QUALITY
15 F/S BEST

ALARM REC SETTING

ENABLE RATE QUALITY
OFF 10 F/S BEST

Send Clear

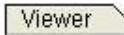
2. Adjust the Record / Alarm setting, including the “REC rate”, “REC quality”, “ALARM REC enable”, “ALARM REC rate”, and “ALARM REC quality” as and when necessary.
3. Click the  button to submit the new Record / Alarm setting.
4. Click the  button to return to the home page while the new image setting acts on the images to effect the desired changes instantly. (If the setting has not been changed by the above steps, any (re)entry onto the home page will find images in their earlier or original setting.)

13.3 Change Timer Record Setting

Please follow the steps below to change the Timer Record setting through the network as and when necessary.

1. Click the **Setup** button on the home page to enter the Record / Alarm setting page.
2. Click the [TIMER RECORD](#) connection on the Record / Alarm setting page to enter the Timer Record setting page.

	Start	End	Start	End
Sunday	0:00	0:00	0:00	0:00
Monday	0:00	0:00	0:00	0:00
Tuesday	0:00	0:00	0:00	0:00
Wednesday	0:00	0:00	0:00	0:00
Thursday	0:00	0:00	0:00	0:00
Friday	0:00	0:00	0:00	0:00
Saturday	0:00	0:00	0:00	0:00

3. Set the **TIMER RECORD** to **ON** to enable the **TIMER RECORD** function.
4. There are two time-periods available for scheduling each day. The Timer Record setting page allows users to program the time each day that the 4CH DVR will start and stop recording. The time is displayed in a 24-hour clock format. If there is a time overlap showing between two continual time-period settings, the device will automatically combine the two time-period settings into one combined time-period setting.
5. Click the **Send** button to submit the new Timer Record setting.
6. Click the **Viewer** button to return to the home page while the new image setting acts on the images to effect the desired changes instantly. (If the setting has not been changed by the above steps, any (re)entry onto the home page will find images in their earlier or original setting.)

13.4 Change Pan/Tilt/Zoom Setting

Please follow the steps provided below to control the Pan/Tilt/Zoom setting through the network as and when necessary.

1. Click the **PTZ** button on the home page to open the Speed Dome Controller.

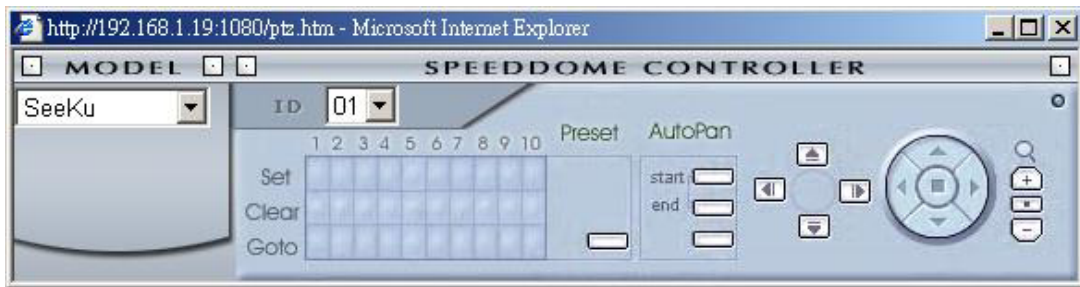



2. Click the  button to control the Zoom setting on the Speed Dome Controller.



3. The right-hand set, , has four buttons, each of which, upon being clicked, will turn the camera all the way, without stopping, in one of the four designated directions. The fifth button, in the center, will stop the camera at any point you prefer.



4. The left-hand set of buttons, , has four buttons, each of which, upon being clicked, will move one short step only in any of the four designated directions.

5. Select a Speed Dome device Model  from the drop-down list on the SpeedDome Controller. The Controller will be able to display the Model by turn.

6. Select a Speed Dome device ID  from the drop-down list on the Speed Dome Controller. The Controller will be able to display the ID by turn.

- 7.



Each of the ten buttons under 'Set' is connected with a specific position and angle of either panning or tilting of the camera. Click each button to activate its particular position and angle.

Press the button under 'Preset' to turn the camera angle by angle in the set positions.

Each of the ten buttons under 'Clear' can be clicked to delete the corresponding 'Set' button above it. For example, if you wish to de-activate 'Set' button #4, please click 'Clear' button #4 to delete its corresponding 'Set' counterpart.

Each of the ten buttons designated 'Go to' can be clicked to view the particular corresponding angle of the position in which it is set.

8.



The 'AutoPan' section has three buttons. The 'Start' and 'End' buttons fix the two points of any panning movement you select. The third or bottom button sets the chosen movement in the play mode.

14. SPECIFICATIONS

Model Number	MV-DR4000	
Image System	NTSC	PAL
Resolution	720 x 480 pixels / 352 x 240 pixels	720 x 576 pixels / 352 x 288 pixels
Video In	Composite Video In (BNC) x 4	
Video Out	Composite Video Out (BNC) x 4, Monitor Out (BNC) x 1	
Audio In/Out	Line In / Out (RCAx2), 16 bits, 8 kHz	
Storage Media	> 320 GB / 1 Fixed HDD, 1 Removable HDD	
Compression	MJPEG	
Memory Card	SD Card	
Archive	Hot Swappable Removable HD	
Watermark	Digital Signature	
Recording mode	Frame record	
Recording Rate	15 fps (720x480) 30 fps (352x240)	12 fps (720x576) 25 fps (352x288)
Image Size	Best(60KB) / High(50KB) / Standard(40KB) / Basic(32KB)	
Recording Mode	Schedule / Manual / Alarm / Circular	
Alarm Recording	Event / Pre-Alarm / Post Alarm	
Pre-Alarm Recording	50 pictures	
Playback Speeds	Frame Stepping, 1/16x, 1/8x, 1/4x, 1/2x, 1x, 2x, 4x, 8x, 16x, 30x, 100x	
Record Search	Alarm / Time / Event list / Filter(thumbnail) / SD card	
Motion Detection	Yes	
Set-up Menu	Multi-layer / Network setting	
Log list	2000 records	
Alarm In/Out	4 Alarm Input / 1 Alarm Output	
Built-in Buzzer	Yes	
Communication Port	RS-232, RS-485, and Ethernet Port	
Network Interface	Ethernet (RJ-45 10/100 base-Tx) x 1	
Network Protocol	TCP/IP, DHCP, HTTP, UDP, FTP	
Software Upgrade	Upgrade via Memory Card(SD Card)	
Password Protection	Operation / Menu Setup / Remote Access	
Network Capabilities	Archive image as JPEG formats, Remote live or recorded images	
Power Supply (AC adapter)	Input: 100V-240V, 50 Hz/60 Hz; Output: DC12V max 5A	
Dimensions	220 mm x 94 mm x 340 mm EIA 19" 2U Half Size Mountable	
Weight	About 3.9 kg	
Operation Temperature	5° C ~ 40° C (41° F ~ 104° F)	
Regulation	FCC, CE	
Provided Accessories	AC Adapter x 1	
	Instruction manual x 1	
	Power cord x 1	
	Software CD-ROM x 1	
	Screw (#6-32UNC) x 4, Screw (M3) x 8(not in use)	
	Key x 2	

***Design and specifications subject to change without notice.**

APPENDIX 1. –SCANIP

Follow the instructions below to use the SCANIP software to search the DVR devices from a local location.

1. Click the  button to discover the connection of the all-type device in the LAN. The **Device List** will display the connection of the all-type device.
2. Select the desired device from the **Device List**.
3. Click the desired device to show the window while the DVR information acts to display the desired changes instantly.

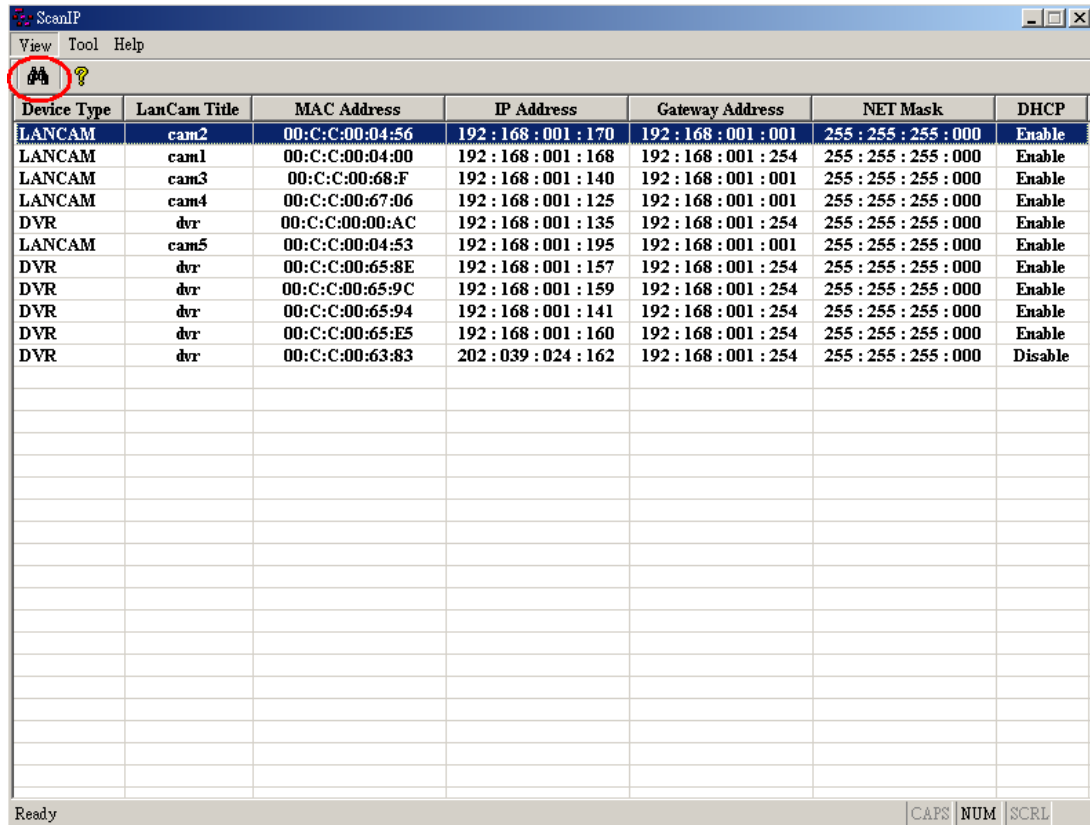

Device Type	LanCam Title	MAC Address	IP Address	Gateway Address	NET Mask	DHCP
LANCAM	cam2	00:C:C:00:04:56	192:168:001:170	192:168:001:001	255:255:255:000	Enable
LANCAM	cam1	00:C:C:00:04:00	192:168:001:168	192:168:001:254	255:255:255:000	Enable
LANCAM	cam3	00:C:C:00:68:F	192:168:001:140	192:168:001:001	255:255:255:000	Enable
LANCAM	cam4	00:C:C:00:67:06	192:168:001:125	192:168:001:001	255:255:255:000	Enable
DVR	dvr	00:C:C:00:00:AC	192:168:001:135	192:168:001:254	255:255:255:000	Enable
LANCAM	cam5	00:C:C:00:04:53	192:168:001:195	192:168:001:001	255:255:255:000	Enable
DVR	dvr	00:C:C:00:65:8E	192:168:001:157	192:168:001:254	255:255:255:000	Enable
DVR	dvr	00:C:C:00:65:9C	192:168:001:159	192:168:001:254	255:255:255:000	Enable
DVR	dvr	00:C:C:00:65:94	192:168:001:141	192:168:001:254	255:255:255:000	Enable
DVR	dvr	00:C:C:00:65:E5	192:168:001:160	192:168:001:254	255:255:255:000	Enable
DVR	dvr	00:C:C:00:63:83	202:039:024:162	192:168:001:254	255:255:255:000	Disable

4. Do you want to auto search free IP?

If and when you want to auto search the free IP, select “Yes” or “No”. If clicked “Yes” the software will provide the “Free IP Address” boxes on the right side of the window. If you click “No”, these address boxes will not show.

5. Manual insertion of "Free IP Address".

If you have clicked "No", please manually type in insertions as required in the "Free IP Address", "Gateway Address", and "NET Mask". Follow each insertion you make by typing in the "Login Name" and "Password", and click "UPDATE" to send your alterations to the DVR.

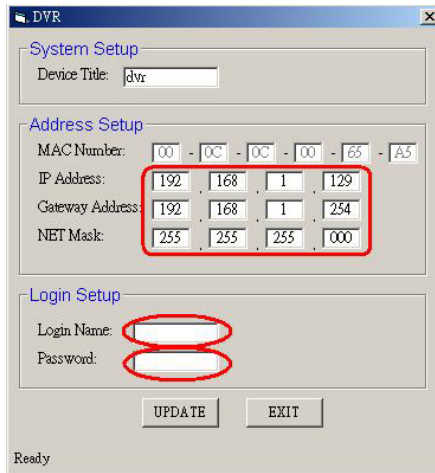

6. Auto search "Free IP Address".

If you clicked "Yes" the "Free IP Address" box will appear on the right.

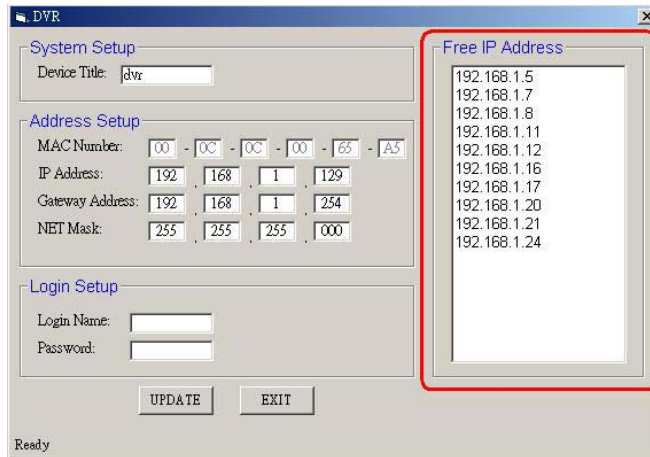

7. Select and double click any of the addresses in the "Free IP Address" box on the right to enter it into an IP Address on the left.

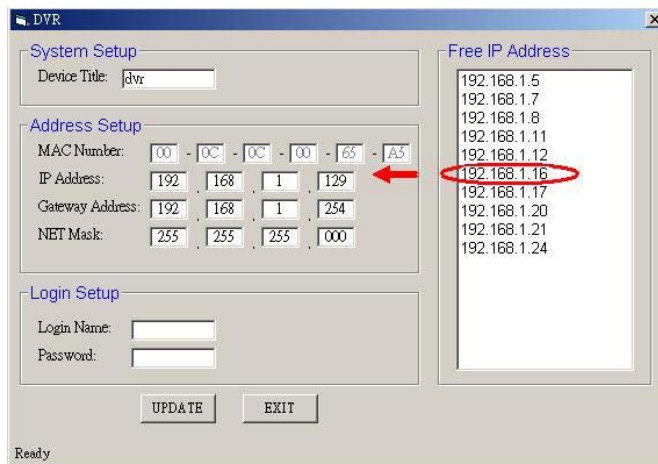

- To change any IP address, type in the new address in the “Free IP Address” box on the right as well as the device “Login Name” and “Password” in their respective blanks at bottom left, then click “UPDATE”, and the new address will automatically be sent to the device.

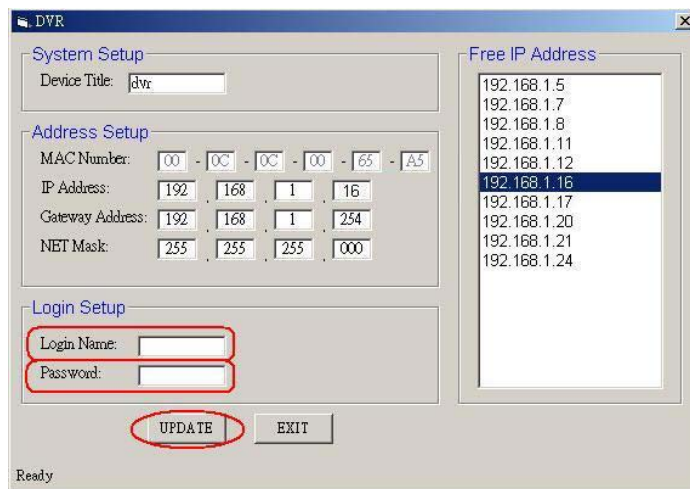

- Click “Exit” at bottom right to shut the device.

Free Manuals Download Website

<http://myh66.com>

<http://usermanuals.us>

<http://www.somanuals.com>

<http://www.4manuals.cc>

<http://www.manual-lib.com>

<http://www.404manual.com>

<http://www.luxmanual.com>

<http://aubethermostatmanual.com>

Golf course search by state

<http://golfingnear.com>

Email search by domain

<http://emailbydomain.com>

Auto manuals search

<http://auto.somanuals.com>

TV manuals search

<http://tv.somanuals.com>