

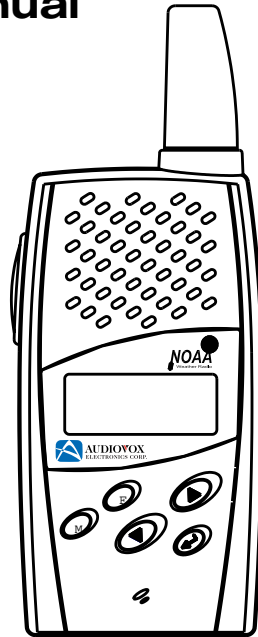

Model FR-1538

Owner's Manual



Customer Service
1-800-290-6650

**CONGRATULATIONS ON YOUR SELECTION
OF THE FR-1538 (FAMILY RADIO)**

It is one of the most sophisticated and reliable two way
family radios available.

**BEFORE OPERATING YOUR FR-1538 (FAMILY RADIO)
READ THIS MANUAL CAREFULLY**



For Customer Service
Visit Our Website At
www.audiovox.com
Product Information, Photos,
FAQ's, Owner's Manuals

■ FEATURES

Your FR-1538 Family Radio is a portable, easy to use, two-way radio that you can carry almost anywhere. It is skillfully constructed to give you reliable communications for many different applications. The FR-1538 is ideal for use around the house, in your boat, on hunting and camping trips, on the ski slopes or at the mall. Some of the FR-1538 features are:

No Air Time Fees and No License Required

Up to 2 Mile Range

Auto Battery Saver and Auto Squelch

National Oceanic and Atmospheric Administration (NOAA) Channel Function

14 Family Radio Service Channels

38 Continuous Tone Coded Squelch System (CTCSS)

Multifunction LCD Display

Talk Confirmation Tone and Call / Ring Button

Stopwatch Function

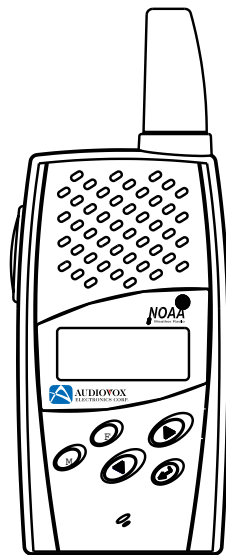

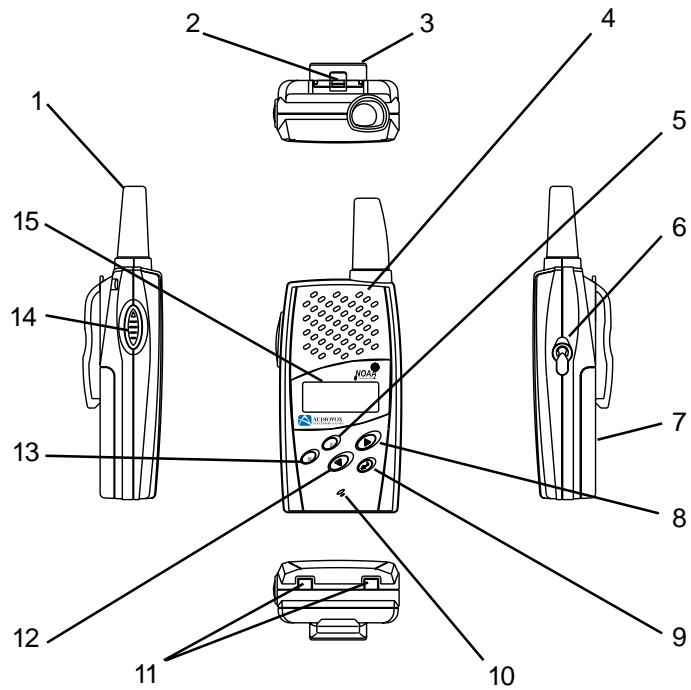

- | | |
|---------------------------------|--|
| 1. Antenna | 9. Power On/Off and Shift/Enter Button |
| 2. Belt Clip Release Tab | 10. Built-in Microphone |
| 3. Detachable Belt Clip | 11. Battery Charging Contacts |
| 4. Built-in Speaker | 12. Down Button and Volume Control |
| 5. Function Button | 13. Monitor Button |
| 6. External Earphone Jack | 14. Push-To-Talk (PTT) Button |
| 7. Battery Door | 15. Liquid Crystal Display (LCD) |
| 8. Up Button and Volume Control | |

MODEL FR-1538 DISPLAY

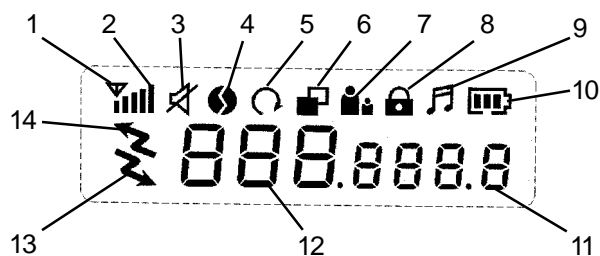

1. Transmit (TX): Antenna/bar Icon appears during transmission each time PTT button is pressed.
2. RSSI Indicator: Number of illuminated bars indicates receive signal strength.
3. Monitor Indicator: Icon appears when the monitor button is pressed.
4. Continuous Tone Coded Squelch System (CTCSS) Indicator: Icon appears when receiving a transmission with correct CTCSS tone.
5. Auto Scan Indicator: Icon appears when the auto scan channel mode is activated.
6. Priority Channel Scan Indicator: Icon appears when the priority channel scan mode is activated.
7. Voice Activated Transmission (VOX) Indicator: Blinks in the VOX selection mode or appears when VOX is activated.
8. Key Lock Indicator: Appears when the key lock is activated.
9. Weather Alert Melody Indicator: This icon appears when the National Oceanic and Atmospheric Administration (NOAA) alert mode is activated.
10. Battery Level Indicator: Icon indicates the battery charge strength.
11. Small Segment Display: Displays the CTCSS tone option in the normal mode. The CTCSS option is shown in Hz.
12. Large Segment Display: Indicates the channel number in use in normal mode. When the Function Button is pressed, the FR-1538 menu is displayed in this position in the following sequence:
 - (Ch)** Channel Select Mode (1-14)
 - (NOA)** Weather Channel Mode (0-9)
 - (Sc)** Automatic Channel Scan Mode

(Uo) Voice Activated Function (**OFF, Hi, Lo** or **nr**)

(H00) Stop Watch Mode depicting Hours/Minutes/Seconds/Tenths of Seconds/Hundreds of Seconds

(Sub) Sub-function menu on (**yes**) or off (**no**)

13. TX Indicator: Icon appears when a signal is being transmitted.

14. RX Indicator: Icon appears when a signal is being received.

Each time the Function (F) Button is pressed, the FR-1538 scrolls through selection of each main menu as noted above. Pressing and holding the Function button for 2 seconds or longer activates the keylock () feature, whereby all buttons except the Monitor (M) and Press-to-Talk (PTT) are inoperable. When the Sub-Function menu is selected (**sub yes**), additional menu options are available in the following order:

(CAL) Call Ringer Melody Selection (1 through 7)

(bep) Key (button) Beep **on/off**

(ro9) Roger Beep **on/off**

[**1,2,3**] Preset Channel Numbers. Select each channel using up/down buttons

In addition, when the Channel Select mode is chosen (**Ch** flashing), the Continuous Tone Coded Squelch System (CTCSS) can be accessed as follows:

1. Press the Power/Enter () Button (9); the CTCSS code digits flash.
2. Press the Up or Down button to select the desired CTCSS code.
3. Press the PTT button to confirm selection.

Powering the transceiver:

Your FR-1538 radio transceiver operates on four AAA batteries. You may operate your FR-1538 using the rechargeable batteries included or you may use alkaline batteries. Alkaline batteries will provide slightly better performance than the rechargeable batteries.

Installing the batteries:

To install batteries into the radio, it is necessary to remove the belt clip. To do this you will need to release the spring clip securing the belt clip to the radio and lift the belt clip away from the radio body. Next, remove the battery compartment cover by sliding it downward towards the bottom of the transceiver. Observe the polarity symbols on the top of the tray when inserting the batteries. Replace the cover.

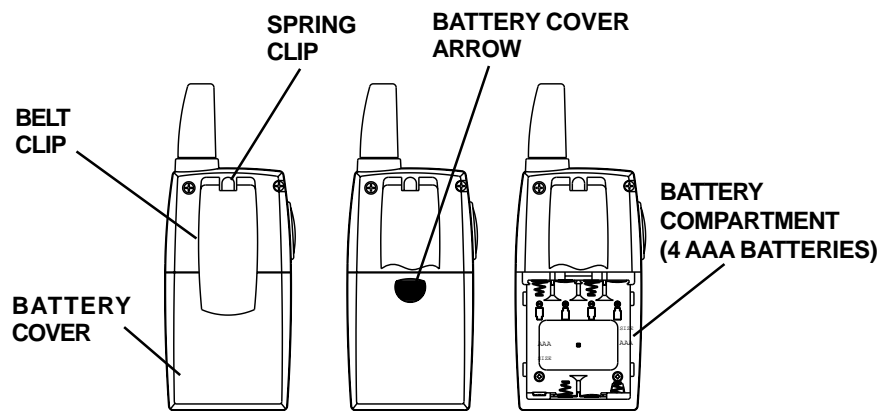

1. Press the spring clip and slide the belt clip upwards.
2. Slide the battery cover downward.
3. Insert batteries observing the polarity symbols on the top of the tray.

The following guidelines will improve performance and provide longer operating times for the FR-1538:

1. Do not mix old and new batteries.
2. The use of alkaline-type batteries is recommended to provide the longest operating time.
3. Do not mix alkaline, standard (carbon-zinc) or rechargeable (Ni-MH) batteries.
4. If the unit is not to be used for an extended period of time, remove the batteries. Old or leaking batteries can cause damage to the unit and will void the warranty.

Wrist Strap and Detachable Belt Clip Installation

The wrist strap and detachable belt clip are provided to enable you to carry the FR-1538 easily and safely. The wrist strap can be attached to the hole located on the top of the belt clip. Feed the small loop on the end of the strap through the hole and then pass the strap through the loop and pull tight.

The detachable belt clip fits into the slot located on the rear of the unit. To remove the belt clip, press the locking clip at the top of the belt clip away from the unit and slide the belt clip upwards. To install the belt clip, slide it down into the slot until it snaps in to place.

Charging the FR-1538:

Insert the charging transformer into a household electrical outlet and connect its power jack to the socket on the rear of the charging stand. Simply placing the unit into the charging stand will begin the charging process. The red LED on the front of the charging transformer serves as a charge indicator. The charging stand will charge two units simultaneously. Approximately 12 – 16 hours are required to fully charge the batteries. Remember to turn your FR-1538 **OFF** before placing it into the charging stand.

CAUTION: The charging stand in your kit is intended for use with the rechargeable NiMH batteries supplied with the unit. Do not attempt to recharge any other type batteries (Alkaline) with the charging stand.

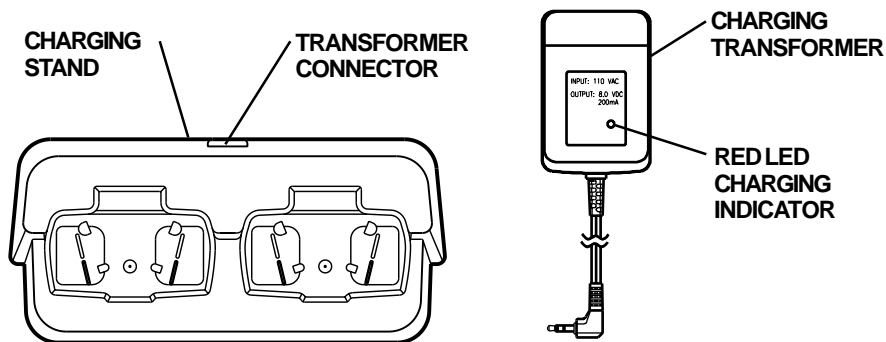

Controls:

Power On/Off and Enter () Button (9):

Press and hold this button () momentarily to turn the unit on. A short confirming melody will sound and the unit will perform a brief self-test. To turn the unit off, press and hold the button for a 2 second period. A short tone will sound before the unit shuts off. The word **bye bye** in large and small script will appear momentarily and then disappear.

Enter Button (9):

This button () is also used to confirm options for operating modes during the function edit mode. During main channel selection, a momentary press of this button will access the CTCSS subcode for selection using the Up and Down buttons.

Push To Talk (PTT) Button (14):

Pressing and holding this button will allow you to speak to any transceiver that is set to the same channel and privacy code setting as yours. Hold the transceiver approximately 1 to 2 inches from your face as you speak into the built-in microphone (10). After you have finished speaking, release the PTT button to allow for reception of incoming signals. It is not possible to transmit and receive at the same time. The red transmit LED indicator located on the right side of the LCD Panel (15) will light while the PTT button is pressed.

Releasing the button allows the unit to revert to standby mode. When receiving an incoming signal, the green receive LED indicator on the left side of the LCD Panel (15) will light.

The PTT button can also be used as a two-way call ringer. Pressing the button twice quickly will call another party on the same channel. The word **CALL** and the transmit icon will appear in the display. The user selected call will sound.

Volume Control (8 and 12):

In the standby mode, adjust the volume to a comfortable level between **01** and **15** by pressing the Up (8) button to increase the volume level and the Down (12) button to decrease the volume level.

Up Button (8):

In the standby mode, pressing this briefly will increase the volume. In the function edit mode, pressing the button briefly will shift from the current option in each sub-menu to next option in the same sub-menu.

Pressing the button for more than 1.5 seconds allows navigation at a more rapid rate. In the standby mode the volume will increase rapidly. In the function mode, different menus can be rapidly accessed.

Down Button (12):

In the standby mode, pressing this briefly will decrease the volume. In the function edit mode, pressing the button briefly will shift from the current option in each sub-menu to next previous option in the same sub-menu.

Pressing the button for more than 1.5 seconds allows navigation at a more rapid rate. In the standby mode the volume will decrease rapidly. In the function mode, different menus can be rapidly accessed.

Function Button (5):

In the standby mode, pressing this button briefly will enter the function edit mode. Pressing the button for more than 1.5 seconds will activate or deactivate the KEY LOCK when the unit is in the standby mode. Refer to KEY LOCK function description to activate and deactivate the KEY LOCK.

NOTE: All buttons will be disabled except for the Up (▲) Button (8) or the Down (▼) Button (12) Monitor (M) Button (13) and the PTT Button (14).

Monitor (M) Button (13):

The Monitor Button is used to check the activity on a channel before transmitting. When the Monitor Button is pressed, the LCD panel (15) will be lit with an amber backlight, and both the transmit (red) and the receive (green) LEDs will light. Pressing the Monitor Button during the edit function mode will confirm and entry and return the unit to standby. Pressing the Monitor Button during a VOX transmission (voice activated transmission) will discontinue the transmission and disable the VOX function for 10 seconds.

External Microphone/Speaker (6):

This jack accepts an Audiovox FRS-BHST headset/microphone for total hands- free operation.

NOTES FOR GOOD COMMUNICATION

1. The FR-1538 14 channels are shared on a 'take turns' basis. This means other groups may be talking on any of the channels. A common code of ethics/courtesy is to switch to another vacant channel and not to attempt to talk over someone who is already using the channel you first selected.
2. The FR-1538 has been designed to maximize performance and improve transmission range in the field. To avoid interference, it is recommended that you do not use the units closer than 5 feet apart.
3. For best transmission results, always keep your mouth about 2-3 inches from the microphone (10) and speak slowly in a normal voice.

FRS-1538 OPERATIONAL MODES

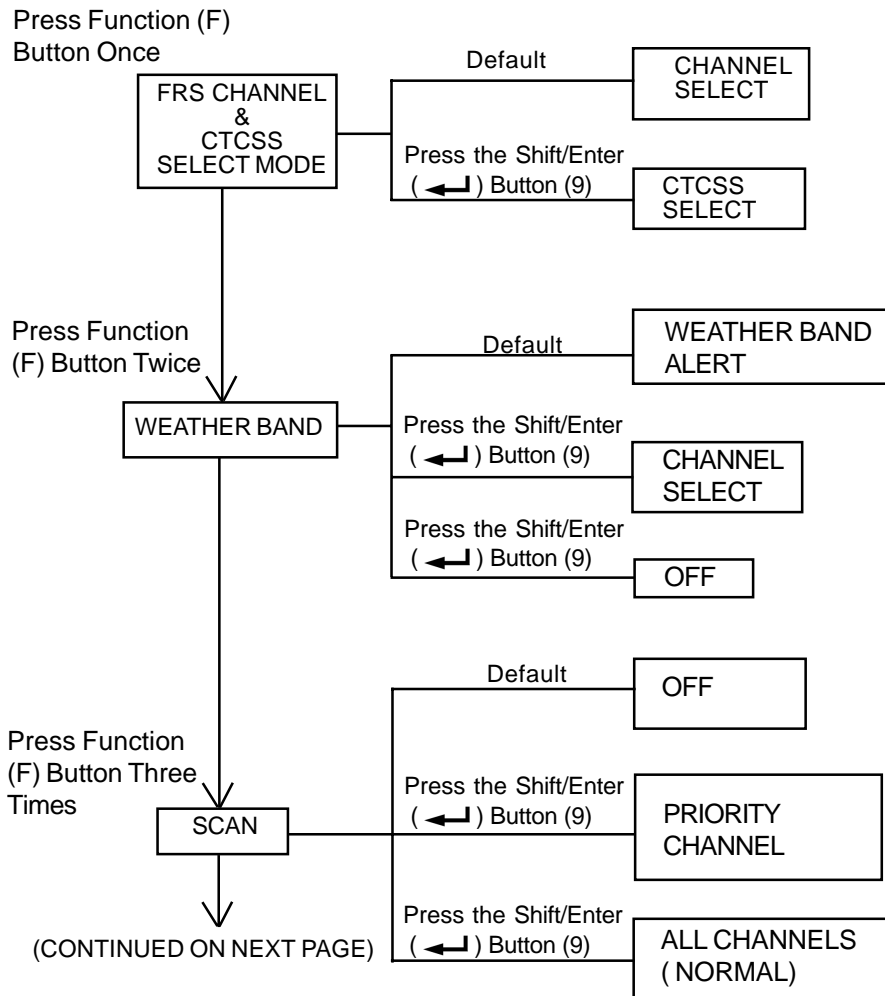

FRS-1538 OPERATIONAL MODES (CONTINUED)

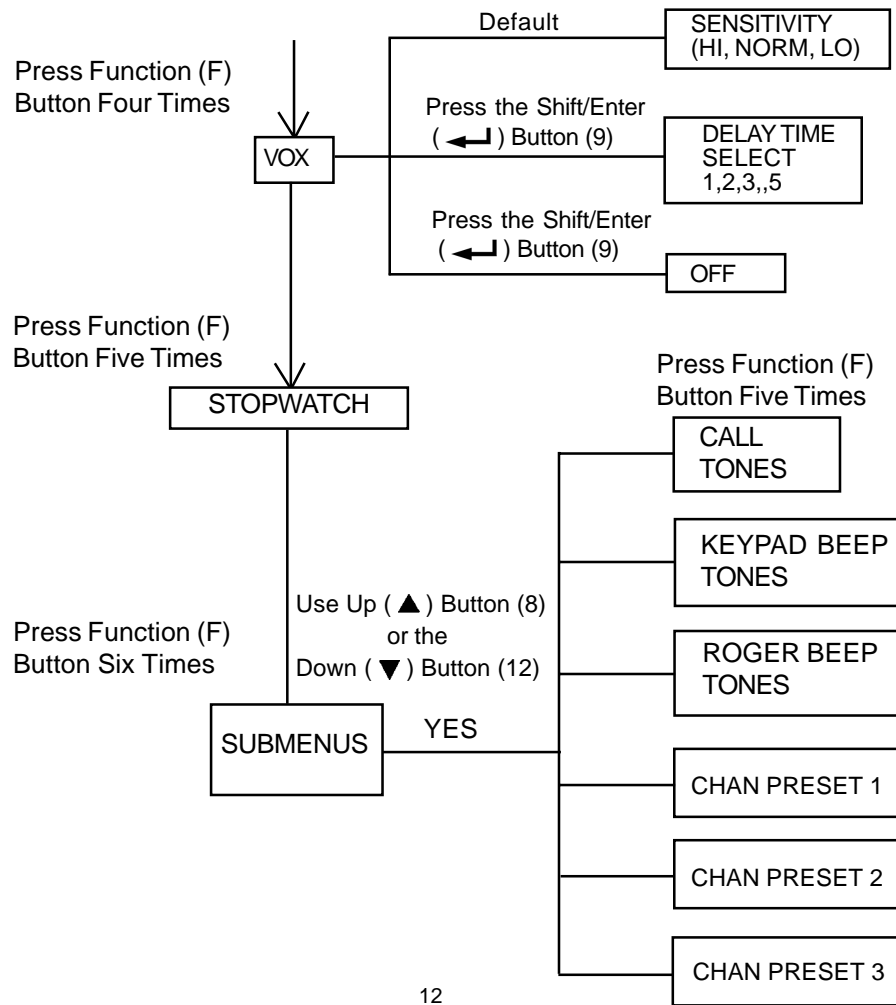

OPERATING MODES AND FEATURES

FRS CHANNEL MODE

CHANNEL NUMBER SELECTION:

This feature allows the selection of main channels for communication as follows:

1. Press the Function (F) Button (5) once: (**Ch** and the flashing channel number appears on the display¹⁵).
2. Press the Up (▲) Button (8) or the Down (▼) Button (12) to choose the channel.
3. Press the Monitor (M) button (13) to confirm your selection.

CODED TONE CONTROL SQUELCH SYSTEM (CTCSS) CODE SELECTION

When the **CTCSS** feature is enabled, the transceiver will only receive signals from other transceivers set to the same channel and privacy code. When the CTCSS mode is off, the transceiver will receive signals from all transceivers set to the same channel. Remember that the CTCSS feature does not prevent others from listening to your transmissions. It only allows your FR-1538 to ignore signals from transceivers not set to the same privacy code.

1. Press the Function Button (5) once to access the main channel number as before.
2. Press the Shift/Enter (←) Button (9) to select the CTCSS 2-digit code position which flashes.
3. Press the Up Button (8) or the Down Button (12) to select the desired sub-code between 01 and 38.
4. Press the Monitor (M) button (13) to confirm your selection.

NOTE: To communicate with other units, they must be switched to the same channel and CTCSS sub-code. To communicate with other units that do not have subcodes, switch your unit to the same channel with the sub-code set to Off.

ALL FRS CHANNEL SCAN SELECTOR:

This feature allows scanning for an active channel on all 14 FRS channels. The power saver mode is disabled in this mode. To activate this feature:

1. Press the Function Button (5) until **SC** appears in the LCD Panel (15).
2. Press the Up Button (8) or the Down Button (12) to choose scanning up or down from the current channel number.
3. Press the Monitor (M) button (13) to confirm your selection.

The unit will begin scanning for an active main channel. If a transmission is detected, the Receive and RSSI icons will appear on the display. To turn off the auto channel scan feature, return to the Scan mode by pressing the Function button and choose **OFF**. You can pause on any channel while in the Auto Channel Scan Mode by pressing the PTT Button (14) during the reception of a signal for 5 seconds afterward. Pressing the Monitor Button (13) will resume scanning.

PRIORITY CHANNEL SCAN MODE:

This feature allows you to monitor two different channels at the same time. If you reset any priority channel other than the current channel in use, the preset channel will be scanned every 0.5 second, and signals you when a call is received. While in the Priority Channel Scan mode you may hear transmission from either a primary or secondary channel when transmitting. The unit will always transmit on the primary channel unless the PTT button (14) is pressed during or immediately following the reception of secondary channel transmission. To access the Priority Channel Scan mode, proceed as follows:

1. Press the Function button twice; **SC** will appear flashing on the display.
2. Press the Up Button (8) or the Down Button (12) to choose **Pr**, and then press Shift/Enter () Button (9) .
3. Select the priority channel you wish to monitor by pressing the Up or Down button.
4. Press the Monitor button (13) to confirm your selection.
NOTE: The unit will scan between the normal channel and the priority channel just selected.
5. To turn off the Priority channel scan feature, press the Function button (F) until **SC** appears flashing on the display; then choose the **OFF option**.

VOX MODE:

The Voice Activated Transmission (VOX) function allows your voice to activate signal transmission automatically when the FR-1538 is used with an optional hands-free microphone/headset (FRS-BHST). It also allows hand-free use when a microphone/headset is not being used without having to use the PTT button (14). When in the VOX mode, a short beep will sound after the termination of any VOX generated transmission.

VOX SENSITIVITY SELECTION:

This feature allows the user to select the voice/signal level at which the unit will transmit. The high sensitivity setting (**HI**) should be used in high background noise environments or when whispering. The low sensitivity setting (**LO**) should be used in low background noise environments. The normal (**NR**) setting can be used in most all typical applications.

To access the VOX Selection menu:

1. Press the Function Button (5) until the **VOX** icon blinks and **Uo** appears on the display (15).
2. Press the Up Button (8) or the Down Button (12) to select from the **HI**, **nr**, **Lo**, or **OFF**. The high, normal or low setting determines VOX response sensitivity.
3. Press the Monitor button (13) to confirm your selection.

VOX RECOVERY TIME SELECTION MODE

This feature allows the response time characteristics of the VOX function to be precisely adjusted to suit individual needs.

To access the VOX Recovery Time Selection menu:

1. Press the Function Button (5) until the **VOX** icon blinks and **Uo** appears on the display (15).
2. Press the Enter (**↵**) Button (9) button to confirm VOX sensitivity selection, and note that the recovery time digit to the right flashes.
3. Press the Up Button (8) or the Down Button (12) to select from the **5**, **3**, **2** or **1** second setting. This setting determines the delay time between transmitting and receiving.
4. Press the Monitor button (13) to confirm your selection.

NOTE: You may need to try different VOX time settings to determine the best value to suit your speaking habits.

5. To turn off the VOX feature, enter the VOX selection mode and then select **OFF**.

STOPWATCH MODE

The stopwatch mode provides you with the capability of timing certain external functions without the need for a separate stopwatch time piece. To use the stopwatch feature, proceed as follows:

1. Press the Function (F) button five times; **H00** appears on the display, with the minutes and seconds digits (**0000**) flashing.
2. Press the Enter (**↵**) Button (9) button to stabilize the entire display.
3. Press the Up button to start and stop the timing counter while the timing is in progress. Press the Down Button (12) to obtain the lap time.
4. Press the Enter (**↵**) Button (9) button to reset the stopwatch time to zero.
5. Press the Function (F) button to exit the stopwatch function.

KEY LOCK SELECTION MODE

This feature prevents accidental channel change to the user preferred settings of the FR-1538. The Key Lock feature temporarily disables the Function (F) and Enter () Buttons. To access the Key Lock Selection menu:

1. Press and hold the Function Button (5) for at least 1.5 seconds; the lock icon appears on the display and the Function and Enter buttons are disabled.
2. To exit from the key lock mode, press and hold the Function button until the key lock icon disappears from the display.

SUB-MODE SELECTION

Sub-mode selection enables you to access sub-menus available for other functions such as Call Ringer selection, Key Tone Beep on/off, Roger Beep Tone on/off, and selection of three channel presets. To enter the sub-mode, proceed as follows:

1. Press the Function (F) button six times, until **Sub** appears on the display together with the flashing **no** indication.
2. Press the Up Button (8) or the Down Button (12) to access the flashing **yes** indication.
3. While **yes** is flashing, press the Function button to access the following sub-menus:
 - a. Call ringer melody selection.
 - b. Key Tone Beep on/off.
 - c. Roger Beep Tone selection on/off.
 - d. Channel preset selection 1-3.

CALL MELODY SELECTION MENU

This feature provides seven user selectable call ringer melodies that alert the user that a calling party wishes to communicate with them. Once the melody is chosen, pressing the PTT Button (14) twice within one second will transmit the call tone selected. To select your favorite Call Ringer melody:

1. Perform the sub-mode selection procedure as previously outlined.
2. With **yes** flashing, press the Function button once; CALL will appear on the display together with a flashing number between 1 and 7, or an OFF indication.
2. Press the Up Button (8) or Down Button (12) to preview the seven available melodies, stopping at the one preferred.
3. Press the Monitor (13) button to confirm your selection and return to the standby menu.

KEY BEEP TONE SELECTION

The unit will emit a confirmation beep tone after a button has been pushed. To enable/disable the key beep tones, proceed as follows:

1. Perform the sub-mode selection procedure as previously outlined.
2. With **yes** flashing, press the Function button twice; **bep** will appear with a flashing **on** or **OFF** indication.
3. Press the Up Button (8) or Down Button (12) to select the beep mode **on** or **OFF** as desired.
4. Press the Monitor (13) button to confirm your selection and return to the standby menu.

ROGER BEEP TONE SELECTION

The unit will transmit a beep tone sequence after each transmission to signal the receiving party that transmission has ended. This tone is called a "Roger Beep". To enable/disable the Roger Beep tone, proceed as follows:

1. Perform the sub-mode selection procedure as previously outlined.
2. With **yes** flashing, press the Function (F) button three times; **rbp** will appear with a flashing **on** or **OFF** indication.
3. Press the Up Button (8) or Down Button (12) to set the Roger Beep mode **on** or **OFF** as desired.
4. Press the Monitor (13) button to confirm your selection and return to the standby menu.

CHANNEL PRESET SELECTION

This feature allows you to preset up to three frequently used channel numbers, with their CTCSS channel designations, so that they can be quickly accessed without the need for selecting them individually through the normal channel/CTCSS selection process. To preset these channels, proceed as follows:

1. Perform the sub-mode selection procedure as previously outlined.
2. With **yes** flashing, press the Function (F) button four times; a preset channel number in parenthesis (**1**, **2** or **3**) will appear with a flashing channel number to the right. Press the Function button until (**1**) appears.
3. Press the Up Button (8) or Down Button (12) Up or Down button to select the desired channel number in the blinking display position.
4. Press the Enter () Button (9); the CTCSS position to the right flashes.
5. Press the Up Button (8) or Down Button (12) to select the desired channel for the tone code.

To set preset channels 2 and 3, repeat steps 1 through 5.

NATIONAL OCEANIC AND ATMOSPHERIC ADMINISTRATION (NOAA) RECEIVER MODE

NOAA provides transmitters which are located throughout the United States; these transmitters broadcast National Weather Service warnings, watches forecasts and hazard information 24 hours a day.

The NOAA receiver on the FR-1538 provides you with weather information for all types of hazards. This function allows you to listen to one of 10 weather channels, and to configure your radio in the NOAA alert mode to inform you of emergency weather broadcasts in your listening area. To access the NOAA functions, proceed as follows:

NOAA CHANNEL MENU

To access the NOAA channel menu:

1. Press the Function (F) button until the **NOA** indication appears on the display with a flashing **OFF** indication.
2. Press the Up or Down button to select either **On** or **ALt** to enable the weather alert.
3. Press the Enter () Button (9) button to listen to broadcast weather channels; the current channel number will appear flashing.
4. Press the Up Button (8) or the Down Button (12) to select the strongest of the 10 channels.
5. To exit the NOAA function, press the Function button and select the **OFF** mode.

NOAA ALERT MODE

Whenever you are listening to the weather channel broadcast, the 2-way radio function of the FR-1538 is disabled; however, when the NOAA alert function is active, the FR-1538 operates in the normal radio modes. After setting the NOAA alert option in the NOAA mode, when the radio receives the NOAA alert signal, it switches to the selected weather channel and normal radio operation is inhibited. Set the NOAA alert mode as follows:

1. Press the Function (F) button until **NOA** appears on the display.
 2. Press the Up Button (8) or the Down Button (12) until **Alt** appears flashing on the display; then press the Enter () Button (9).
 3. Press the Function button to return to normal radio operation.
- The radio is now in the NOAA alert mode, awaiting for a weather alert on one of the NOAA weather channels you have selected.

Warning

- Remove the batteries from the transceiver if it is not expected to be used for long periods. This will eliminate the possibility of chemicals leaking from the batteries and corroding the transceiver.
- Avoid exposing the transceiver to water or extremes of temperature.
- Do not use this device in or near a mining facility, which uses remotely triggered explosives or in areas labeled "Blasting Area". Premature or accidental detonation may result.
- Do not attempt to modify or in any way increase the output of this transceiver. Its output is designed to meet the legal limits set by the F.C.C.
- Do not use this device or change its batteries in potentially explosive atmospheres as sparks in such areas could result in an explosion.
- Turn your transceiver off wherever posted notices restrict the use of radios or cellular telephones. Facilities such as hospitals may use equipment that is sensitive to RF energy.
- Turn your transceiver off on board aircraft when requested to do so.
- Do not place your radio in front of a vehicle's air-bag. If the air-bag deploys, it could propel the transceiver like a projectile causing bodily injury.

This transceiver complies with F.C.C. regulations for use in the United States of America. Use in other countries may be prohibited or restricted by local regulation. Please check with the local regulating agency before using this device outside the United States of America.

Technical Specifications:**General**

Frequency Range:	Refer to frequency charts
FRS Channels	14
Privacy Codes	38 for each main channel
Weather Channels	10
Dimensions (W x H x D) (Without Antenna)	2.08 in x 6.889 in x 1.10 in 53 mm x 175 mm x 28 mm

Power Supply

Power Source	AC/DC Adapter Input: 120 Vac Output 8 Vdc, 0.12 Amp
Battery Backup	Alkaline, AAA (4), 6.0 VDC, 1000 mAh
Operating Time	30 hours (Transmit: Receive: Standby) (5: 5: 90 ratio)

Receiver

Useable Sensitivity	<0.28 uV
Maximum Audio Output Power	200 mW (8 Ohm)
Modulation Distortion	< 5% (1 kHz 60%)

Transmitter

Maximum RF Output Power	500 Mw ERP
Range	Up to 2 miles
Maximum Deviation	<+/- 2.5 kHz
Modulation Distortion	< 5% (1 kHz 60%)

FRS Channel Frequencies:

Channel	Freq. MHz	Channel	Freq. MHz
1	462.5625	8	467.5625
2	462.5875	9	467.5875
3	462.6125	10	467.6125
4	462.6375	11	467.6375
5	462.6625	12	467.6625
6	462.6875	13	467.6875
7	462.7125	14	467.7125

Weather Channel Frequencies:

Channel	Freq. MHz	Channel	Freq. MHz
1	162.550	6	162.500
2	162.400	7	162.525
3	162.475	8*	161.650
4	162.425	9*	161.775
5	162.450	0*	163.275

*Canadian Marine

Continuous Tone Coded Squelch System Tone Frequencies (in Hz)

CTCSS	Freq. Hz	CTCSS	Freq. Hz
1	67.0	20	131.8
2	71.9	21	136.5
3	74.4	22	141.3
4	77.0	23	146.2
5	79.7	24	151.4
6	82.5	25	156.7
7	85.4	26	162.2
8	88.5	27	167.9
9	91.5	28	173.8
10	94.8	29	179.9
11	97.4	30	186.2
12	100.0	31	192.8
13	103.5	32	203.5
14	107.2	33	210.7
15	110.9	34	218.1
16	114.8	35	225.7
17	118.8	36	233.6
18	123.0	37	241.8
19	127.3	38	250.3

Troubleshooting

Problem	Possible cause	Corrective Action
No transmission while pressing the PTT button	Weak batteries	Charge or replace batteries
	Incorrect battery polarity	Install the batteries in the directions indicated by the battery tray.
Weak or no signal received	Weak batteries	Charge or replace batteries
	Channel and privacy code not set the same as target transceiver	Adjust the transceiver's settings to match those settings of the target transceiver
	Volume level too low	Increase volume level
	PTT button inadvertently depressed	Release PTT button
	Excessive radio interference on a particular channel	Change to a different channel
	Obstruction of radio signal	Avoid operating in or near large buildings or vehicles
Transceiver beeps, but will not turn on when Power button is pressed	Batteries extremely discharged	Charge or replace batteries
Reception of unwanted signals	CTCSS privacy mode not on	Turn on the CTCSS privacy mode and set code number to match the setting of the target transceiver.
	Interference from electronic devices such as computers or TVs	Turn the devices off or move farther away from them.

90 DAY LIMITED WARRANTY

Applies to Audiovox Family Radio Service Products.

AUDIOVOX CORPORATION (the Company) warrants to the original retail purchaser of this product that should this product or any part thereof, under normal use and conditions, be proven defective in material or workmanship within 90 days from the date of original purchase, such defect(s) will be repaired or replaced with new or reconditioned product (at the Company's option) without charge for parts and repair labor.

To obtain repair or replacement within the terms of this Warranty, the product is to be delivered with proof of warranty coverage (e.g. dated bill of sale), specification of defect(s), transportation prepaid, to the warranty center at the address shown below.

The Company disclaims liability for communications range of this product.

This Warranty does not apply to any product or part thereof which, in the opinion of the Company, has suffered or been damaged through alteration, improper installation, mishandling, misuse, neglect, accident, or by removal or defacement of the factory serial number/bar code label(s). THE EXTENT OF THE COMPANY'S LIABILITY UNDER THIS WARRANTY IS LIMITED TO THE REPAIR OR REPLACEMENT PROVIDED ABOVE AND, IN NO EVENT, SHALL THE COMPANY'S LIABILITY EXCEED THE PURCHASE PRICE PAID BY PURCHASER FOR THE PRODUCT.

This Warranty is in lieu of all other express warranties or liabilities. ANY IMPLIED WARRANTIES, INCLUDING ANY IMPLIED WARRANTY OF MERCHANTABILITY, SHALL BE LIMITED TO THE DURATION OF THIS WRITTEN WARRANTY. ANY ACTION FOR BREACH OF ANY WARRANTY HEREUNDER INCLUDING ANY IMPLIED WARRANTY OF MERCHANTABILITY MUST BE BROUGHT WITHIN A PERIOD OF 30 MONTHS FROM DATE OF ORIGINAL PURCHASE. IN NO CASE SHALL THE COMPANY BE LIABLE FOR ANY CONSEQUENTIAL OR INCIDENTAL DAMAGES FOR BREACH OF THIS OR ANY OTHER WARRANTY, EXPRESS OR IMPLIED, WHATSOEVER. No person or representative is authorized to assume for the Company any liability other than expressed herein in connection with the sale of this product.

Some states do not allow limitations on how long an implied warranty lasts or the exclusion or limitation of incidental or consequential damage so the above limitations or exclusions may not apply to you. This Warranty gives you specific legal rights and you may also have other rights which vary from state to state.

AUDIOVOX CORPORATION, 150 MARCUS BLVD., HAUPPAUGE, NEW YORK 11788

1-800-290-6650

128-5385A

Free Manuals Download Website

<http://myh66.com>

<http://usermanuals.us>

<http://www.somanuals.com>

<http://www.4manuals.cc>

<http://www.manual-lib.com>

<http://www.404manual.com>

<http://www.luxmanual.com>

<http://aubethermostatmanual.com>

Golf course search by state

<http://golfingnear.com>

Email search by domain

<http://emailbydomain.com>

Auto manuals search

<http://auto.somanuals.com>

TV manuals search

<http://tv.somanuals.com>