

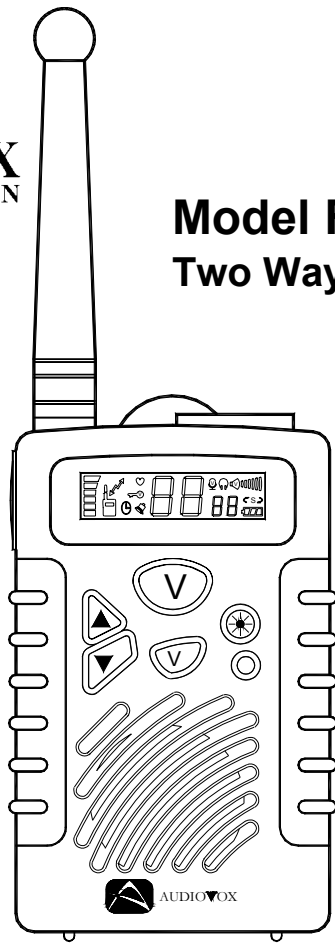

Model FR-314 Two Way Family Radio



Owner's Manual

Customer Service
1-800-645-4994

CONGRATULATIONS ON YOUR SELECTION
OF THE FR-314 (FAMILY RADIO)

It is one of the most sophisticated and reliable two way
radios available.

BEFORE OPERATING YOUR FR-314 (FAMILY RADIO)
READ THIS MANUAL CAREFULLY

FCC WARNING

Replacement or substitution of transistors, diodes or other parts of a unique nature, with parts other than those recommended by the manufacturer, may cause a violation of the technical regulations of Part 15 of FCC Rules.

■ FEATURES

Selectable Transmission Power Output Level
Electroluminescent Illuminated Display
Received Signal Strength Indicator
38 Privacy Codes
14 Channels
Remote Monitor Mode
Internal Voice Activation Circuitry
7 Call Tones
Adjustable Squelch

■ PERFORMANCE

Your transceiver will achieve its maximum operating range when communicating with other transceiver(s) in a flat open area with no trees or buildings obstructing its signal. Range may be up to two miles under such conditions. Obstacles such as buildings, trees or mountains will tend to reduce the transceiver's effective range.

■ BATTERY INSTALLATION

Your FR-314 may be powered by the BAT-314 rechargeable battery pack or three alkaline “AA” cells. Alkaline batteries will provide the best performance from your transceiver. Remove the battery cover by rotating and removing the belt clip. Unsnap the battery compartment clasp, and lift the battery cover from the transceiver. Be careful not to lose the belt clip retainer. Observe the polarity symbols inside the battery tray when installing the battery pack or alkaline batteries. Remember to lock the battery compartment clasp in place when finished.

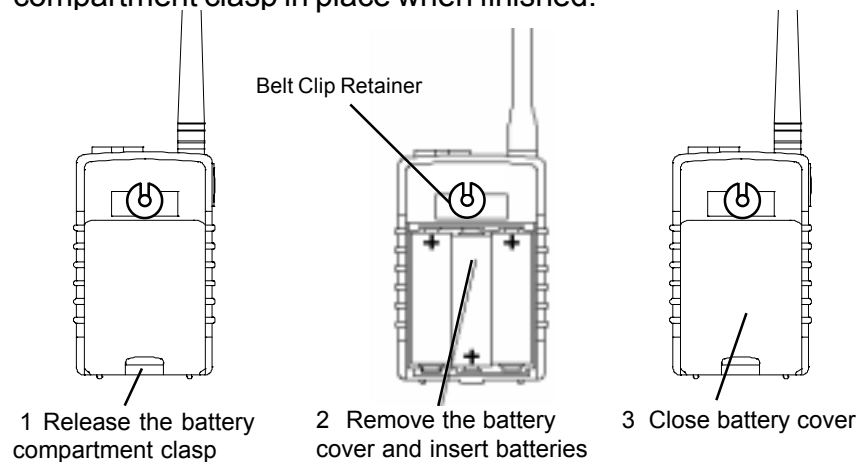

■ THE FR-314's CHARGING STAND

The FR-314 transceiver kit includes a high capacity nickel metal hydride battery pack and charging stand. The charging stand is designed for use only with the Audiovox BAT-314 battery pack. Never attempt to charge other batteries with the charging stand.

The FR-314's four step battery strength indicator will display the current state of charge of the batteries or battery pack in the unit. 3 solid bars indicates a full charge, one or no bars indicates a low charge.



To charge your BAT-314 battery pack, plug the AC adapter into a household electrical outlet, and insert the DC output connector into the receptacle at the base of the charging stand. Before placing the transceiver into the charging stand, be sure it has been turned off. Once the FR-314 is placed in the charging stand, the charge rate indicator on the charging stand will begin to flash, confirming the charging process. The charge rate indicator will flash rapidly, when the battery charge is low. As the BAT-314 battery pack charges, the indicator will flash at a slower rate. A fully charged battery pack is indicated by a flash rate of once every 15 seconds. When charging a deeply discharged battery pack, several beep tones may be heard during the first moments of charging.

Nickel metal hydride batteries do not have a "memory" so the BAT-314 battery pack can be charged at any time, regardless of its current state of charge

■ THE BELT CLIP

The FR-314 Family Radio Kit includes a quick release belt clip. This can be used to secure the radio to a belt or pocket. The clip allows quick access to the transceiver at all times. To use the belt clip, attach it to a belt or shirt pocket, then slide the round hinge retainer into the slot on the belt clip. A click sound will be

heard when the transceiver is locked in place. The belt clip will hold the transceiver securely, while allowing it to rotate from side to side.

To release the transceiver, rotate it 180 degrees and lift it straight upwards.

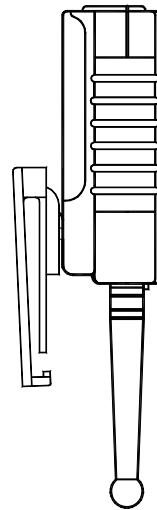
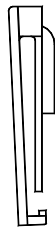

FUNCTION AND LOCATION OF THE CONTROLS

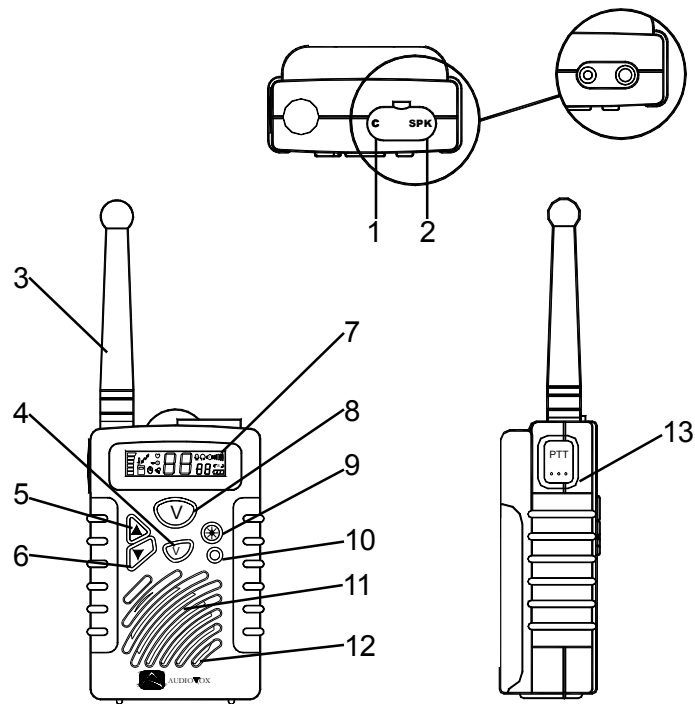

- 1 Microphone jack
- 2 Speaker jack
- 3 Antenna
- 4 Call button
- 5 Up button
- 6 Down button
- 7 LCD display
- 8 Function button
- 9 Monitor / Illumination button
- 10 Power button
- 11 Speaker
- 12 Microphone
- 13 Push to Talk button

■ LCD DISPLAY

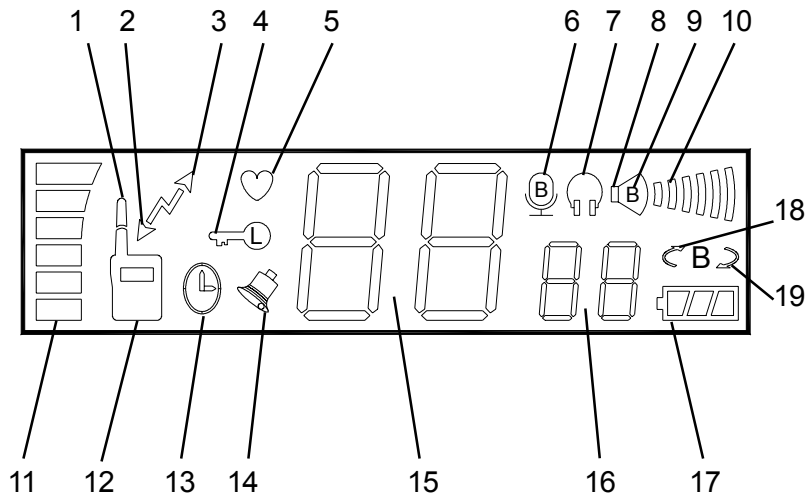

- 1 High power transmission icon
- 2 Receive icon
- 3 Transmit icon
- 4 Keypad lock icon
- 5 Battery save icon
- 6 Voice activation icon
- 7 Monitor icon
- 8 Speaker icon
- 9 Beep tone indicator
- 10 Volume level graph
- 11 Signal Strength Indicator
- 12 Low Power Transmission Mode Indicator
- 13 Auto shut down timer icon
- 14 Call tone icon
- 15 Channel display
- 16 CTCSS privacy code display
- 17 Battery strength indicator
- 18 Scan up indicator
- 19 Scan down indicator

■ USING YOUR FR-314

Turning the Transceiver On or Off

Pressing the red power button for 2 seconds will turn the FR-314 on or off. If the button conformation tones are active, the transceiver will play conformation tones when turned on or off.

Auto-shutdown Timer,

The FR-314 has an internal timer which can automatically shut the transceiver off after 30 minutes of inactivity. To activate the auto-shutdown timer, press the power button twice within 1 second, while the transceiver is on. The clock icon will appear on the display, whenever the auto-shutdown timer is active. If no buttons are pressed and no signals are received for 30 minutes, the clock icon will flash on the display, as indication that the auto-shutdown timer is about to turn the transceiver off. The FR-314 will also sound warning tones to alert its user that it is about to turn off. The auto shutdown warning indicators will continue for 30 seconds. During this time, pressing any of the buttons will reset the 30 minute timer. To disable, the auto-shutdown timer, press the power button twice within 1 second, while the transceiver is on.

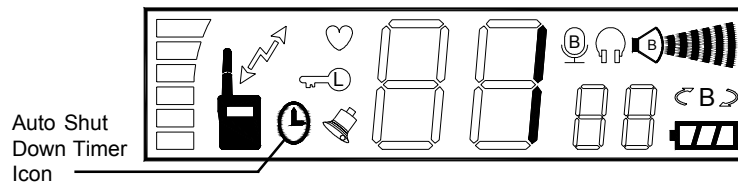

LCD Illumination

The FR-314 incorporates an electro-luminescent display. A momentary press of the monitor button will illuminate the LCD. The backlighting will remain lit for five seconds. If the up, down, call or function buttons are pressed during this period, the LCD will remain illuminated for another five seconds. This allows the backlighting to remain lit while the operator makes adjustments to the FR-314.

Volume Adjustment

The volume of the internal speaker or headphones can be adjusted with the up or down buttons. The current setting will be displayed by the 6 bar indicator on LCD. If the button conformation tones have been activated, the transceiver will beep each time a button is pressed. A double beep tone indicates that the minimum or maximum levels have been reached. When adjusting the volume level, it is helpful to depress the monitor button, in this manner the sound level can easily be adjusted to a comfortable level. It is important to set the volume to a low level before attempting to use a headset or external speaker because extremely loud sounds may damage your ear.

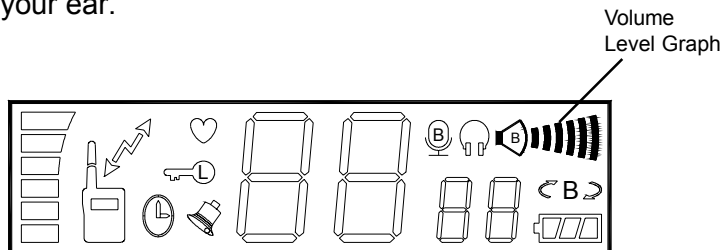

Selecting the Channel

To adjust the channel, press the function button once or until the channel number flashes on the display. Pressing the up or down buttons momentarily, within five seconds, will change the current channel number. The LCD will indicate the current setting and, if the beep conformation tones are activated, the transceiver will sound a conformation tone. When the highest or lowest channel is reached, a double tone will be played as the channel setting wraps to the opposite limit of adjustment. The channel number will stop flashing and the FR-314 will return to standby if no buttons are pressed for 5 seconds, or if the call or PTT buttons are pressed.

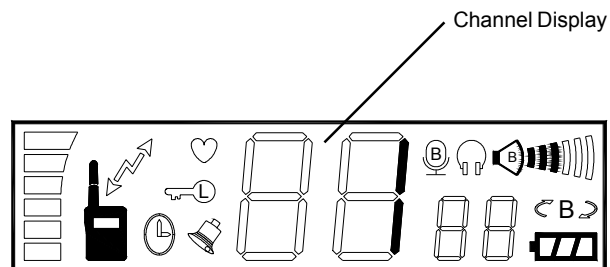

Scanning Channels

The FR-314 can scan all 14 FRS channels to search for active transmissions. To begin scanning, press the function button once or until the channel number flashes on the display, then hold the up or down button for 2 seconds while the channel number is flashing. When the scan mode is activated, the scan icon will be displayed on the LCD. A beep tone will also confirm activation of the scan mode if the beep conformation tones are active. While in scan mode, the transceiver will continuously check all channels for activity. If a signal is received, the transceiver will play the entire signal and continue to monitor its channel for one second. If no other signals are received, the FR-314 will resume scanning. Pressing the function select or PTT buttons will exit the scan mode.

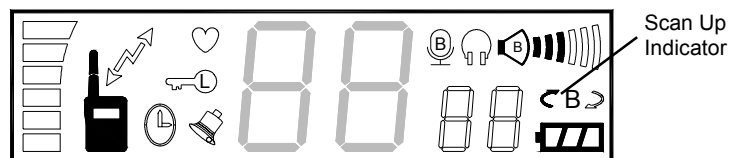

Transmitting a signal

To Transmit manually

1. Set the desired channel number.
2. Press and hold the PTT (Push-to-Talk) button while speaking slowly and clearly in a normal voice, approximately 2 to 3 inches from the microphone.
3. The transmission icon will be displayed while transmitting and the signal's strength will be displayed the indicator on the left.
4. Release the PTT button when you finish speaking to receive incoming signals.

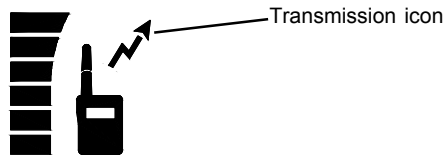

The Transmission icon will be displayed whenever the unit is transmitting a signal, including the automatic transmissions of the vox and monitor modes.

Continuous Transmission

When desired, the FR-314 can be locked into the transmit mode. This is useful for continuously monitoring all sounds in an area, however battery life is dramatically reduced in this mode. To initiate a continuous transmission, momentarily press the power button while holding the PTT button together. The transmission indicator will flash to whenever the FR-314 is in continuous transmit mode. Momentarily pressing the PTT button will terminate the transmission. Remember, no signals can be received while transmitting.

Transmission Power level

The FR-314 transceiver has two available transmit power levels. The high power transmits signals at the regulated limit of 500 milliwatts. The low power level transmits at 200 milliwatts. When using the FR-314 to communicate with other transceivers at close range, it is possible to increase its battery life, by setting its transmission power level to the low setting. Maximum range communication will require the higher setting. To adjust the setting, simply press the up or down button momentarily while transmitting. The FRS Radio icon on the display will show a short antenna in low power mode and a long antenna in high power mode.

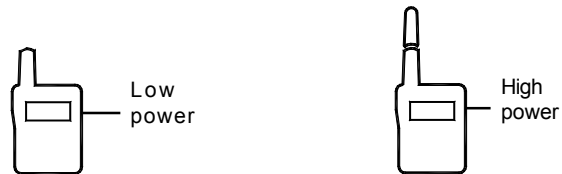

Battery Save Mode

The FR-314 will automatically switch to battery save mode if no buttons are pressed and no signals are received for 6 seconds. While the battery save mode is active, the transceiver will remain ready to transmit or receive signals and the heart icon will flash on the display. This mode dramatically increases the life of the FR-314's batteries. The battery save mode will not function when the squelch is bypassed or adjusted to the zero setting.



Receiving Signals

To Receive

1. Turn the transceiver on.
2. Check the battery condition on the display. If the battery icon is displayed, charge or replace the batteries.
3. Set the desired channel number.
4. Adjust the volume control to the desired listening volume by pressing and holding the monitor button while using the up and down buttons to adjust the sound level.
5. The receive icon will be displayed when the transceiver detects an incoming transmission and its signal strength will be displayed by the indicator on the left.

When communicating with other transceivers at extreme range or when it is desirable to receive weak signals, the monitor button may be used to bypass the squelch and listen to all activity on a channel. Press and hold the monitor button whenever this is desired.



Continuous Monitor Mode

The monitor feature may be locked on by pressing and holding the monitor button, then pressing and holding the PTT button. Releasing the monitor button, then PTT button will initiate the continuous monitor mode. When in continuous monitor mode the receive icon will be displayed and the signal strength indicator will display the strength of any signals received. Pressing the monitor button momentarily will return to the standard reception mode.

Adjusting the Squelch

The FR-314 has 5 different squelch settings. These settings determine the strength that an incoming signal must have in order to be played by the FR-314's internal speaker or through a headset. The higher the setting, the stronger the signal must be in order for the FR-314 to play it. If you desire to communicate with other transceivers in close proximity, the squelch should be set high to eliminate unwanted weak signals. If the transceiver is being used at extreme range, the squelch should be set low to allow reception of weak signals. Level 0 will bypass the squelch entirely. For standard use, level 2 is recommended.

The procedure for adjusting the squelch begins with the FR-314 turned off. While pressing and holding the function button and the up or down button, turn the unit on. The display will show "59L" and the current squelch level will flash on the LCD. Use the up or down buttons to adjust the level. The FR-314 will return to the standby state if no buttons are pressed for 10 seconds, or if the call or PTT buttons are pressed.

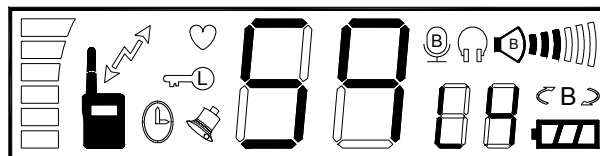

Using the Continuous Tone Coded Squelch System (CTCSS) Privacy Codes

This feature allows you to ignore transmissions from other transceivers that are using the same channel. One of 38 privacy codes may be selected. The same code must also be selected on those transceivers which you desire to communicate with. When in use, the transceiver will play only strong signals from other FRS units set to the same code number. Keep in mind, however, that this feature does not prevent others from listening to your transmissions. To activate or deactivate the CTCSS mode, press and hold the call button for 2 seconds, this will toggle the mode on or off. Upon activation the current privacy code number will be displayed to the right of the current channel number on the LCD and will flash for 5 seconds to allow its adjustment. If no CTCSS number is displayed this indicates that the system is off.

To select a CTCSS code number, activate the system as described above and use the up or down keys to adjust the code number. If the CTCSS mode was already active, a momentary press of the call button will cause the current CTCSS number to flash on the LCD, allowing its adjustment. The FR-314 will return to its standby state if no buttons are pressed for 5 seconds, or if the call or PTT buttons are pressed. See the table at the end of this manual for the CTCSS frequency assignments

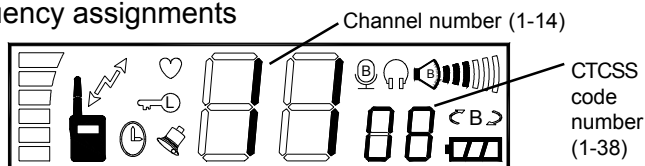

Selecting a Call Tone

The FR-314 has seven built - in call tones. To select a call tone, press the function button twice or until the LCD displays “bP_{EX}” the current call tone number will flash on the right of the display. Pressing the up or down buttons will select between the seven available signals. Each signal will be played by the speaker or headset as it is selected. Once a signal is chosen, the FR-314 will return to standby state if no buttons are pressed for 5 seconds, or if the call or PTT buttons are pressed.

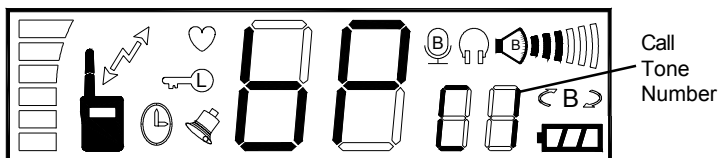

Sending a Call Tone

To Transmit the chosen signal, simply press the call button while holding the PTT button. The chosen call signal will be played by the speaker or headset and transmitted on the current channel, the call icon will display on the LCD whenever a call signal is sent.

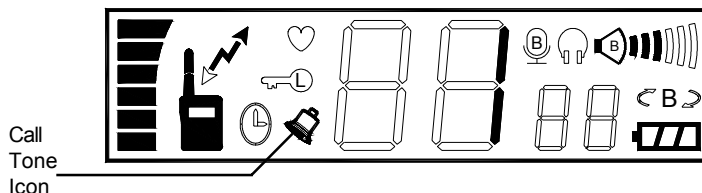

Voice Activation (VOX)

The FR-314 has internal circuitry which will allow it to operate hands free. The voice activation circuitry will activate the transmitter as if the PTT button were pressed whenever its microphone detects the users voice. This feature is particularly useful when using an external microphone. To activate the Vox mode, press the function button three times or until the vox icon flashes on the LCD. The transceiver will show the current status with the words "on or off". Use the up or down buttons to select the vox mode on or off. After adjustment, the FR-314 will return to the standby state if no buttons are pressed for 5 seconds, or if the call or PTT buttons are pressed. If vox operation has been selected the vox icon will display on the LCD.

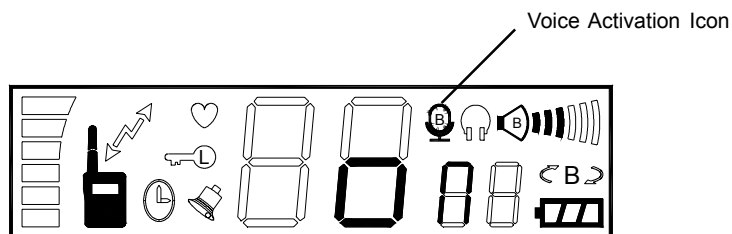

Adjusting the Vox Trigger Level

Whenever the Vox mode is selected, it is necessary to adjust its sensitivity setting. There are four available adjustment levels. When using the vox feature in areas where there is a lot of background noise, choose setting number 1. To avoid inadvertent transmissions in quiet areas, choose setting number 4. To adjust the vox sensitivity level, press the function button four times or until "SE LX" displays on the LCD. The vox mode must be already activated, or the transceiver will not display the adjustment screen. The level may be adjusted by using the up or down buttons. The FR-314 will return to the standby state if no buttons are pressed for 5 seconds, or if the call or PTT buttons are pressed.

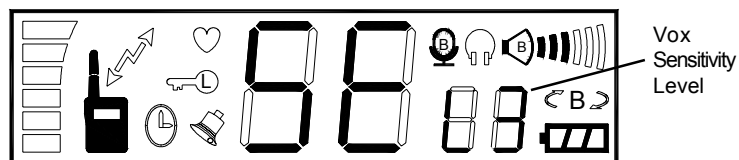

Using the Monitor feature

The FR-314 has a unique feature which allows a pair of units to operate as a remote monitoring system. A single unit to be placed in an area and transmit sounds from that area to a second FR-314 transceiver. The monitor feature allows the user of the second transceiver to check the status of the radio link between the two transceivers and periodically “listen in” on the remote transceiver. This is particularly useful as a baby monitor.

To use a pair of FR-314 transceivers in the monitor mode, they must both have the CTCSS mode activated and be set to the same Channel and CTCSS code. For the remote transceiver, activate and adjust the vox mode as described earlier. Then press the function button 5 times or until the monitor icon flashes on the LCD. The transceiver will show the current status with the words “on or off”. Use the up or down buttons to change the setting. After adjustment, the FR-314 will return to the standby state if no buttons are pressed for 5 seconds, or if the call or PTT buttons are pressed. If vox operation has been selected the vox icon will display on the LCD. Remember to reduce the volume setting of the remote transceiver, if it is to be used as a baby monitor. If the transceiver will be used to monitor an area for longer than 30 minutes, make sure that the shut-off timer is not active. Place the remote transceiver on its base with the front, facing the area to be monitored.

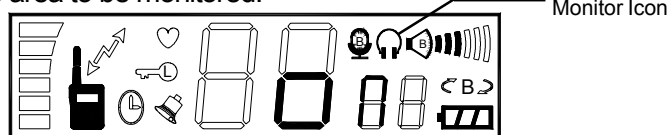

Using the Monitor feature Continued

It is now possible for an FR-314 to receive sounds transmitted by the remote FR-314 in monitor mode at any time. Pressing and holding the PTT button, then momentarily pressing and releasing the monitor button on the second FR-314 will initiate an 8 second transmission from the remote transceiver. The monitor icon will flash to confirm that a "listen in" request was sent to the remote receiver. The following 8 second transmission can be used to check the radio link between the two transceivers by observing the received signal strength indicator on the left of the display. This allows a user to move from location to location and have confidence that he or she is within range of the remote transmitter.

To "listen in" Press and hold the PTT button,....

Momentarily, press and release the Monitor button.

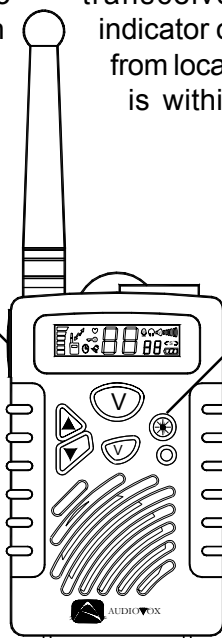

Keypad Lock

To prevent the transceiver's settings from being inadvertently changed, the keypad can be locked. When the keypad is locked, only the volume is adjustable, the other functions can be viewed, but not changed. This is useful when the FR-314 is being used by small children, or when the unit is kept in a pocket. A key icon will be shown on the display whenever the keypad is locked. To lock or unlock the keypad, press and hold the function button for 2 seconds.

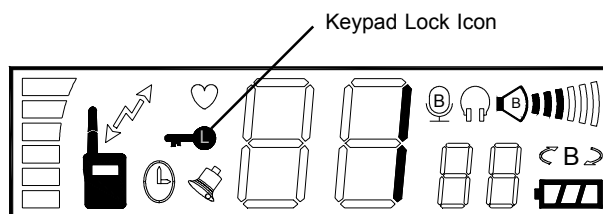

■ WARNING

Remove the batteries from the transceiver if it is not expected to be used for long periods of time. This will eliminate the possibility of battery acid leaking from the batteries and corroding the transceiver.

Avoid exposing the unit to water or extremes of temperature.

Do not use this device in or near a mining facility, which uses remotely triggered explosives or in areas labeled "Blasting Area". Premature or accidental detonation may result.

Do not attempt to modify or in any way increase the output of this transceiver. Its output is designed to meet the legal limits set by the FCC.

Do not use this device or change its batteries in potentially explosive atmospheres as sparks in such areas could result in an explosion.

Turn your transceiver off wherever posted notices restrict the use of radios or cellular telephones. Facilities such as hospitals may use equipment that is sensitive to RF energy.

Turn your transceiver off on board aircraft when requested to do so.

Do not place your transceiver in front of a vehicle's air-bag. If the air-bag deploys, it could propel the transceiver like a projectile.

This transceiver complies with F.C.C. Regulations for use in the United States. Use in other countries may be prohibited or restricted by local regulation. Please check with the local regulating agency before using this device outside of the United States.

■ SPECIFICATIONS*

General

Channels:	14
Frequency range:	See Chart on p. 30
CTCSS codes:	38
Modulation Type	FM 2.5 kHz
Operating Temperature Range:	14° - 140° F
Standby time (Alkaline):	>60 Hours
Power Supply:	3 - 4.5 V DC

Receiver

Sensitivity at 12 dB Sinad:	.25 Microvolts
Selectivity:	45 dB

Transmitter

High Power RF Output:	500 milliwatts
Low Power RF Output:	200 milliwatts
Maximum Deviation:	2.5 kHz

* These specifications are subject to change without notice.
They represent typical values, individual units may vary.

**Continuous Tone Coded Squelch System
Tone Frequencies**

CTCSS	Freq. Hz	CTCSS	Freq. Hz
1	67.0	20	131.8
2	71.9	21	136.5
3	74.4	22	141.3
4	77.0	23	146.2
5	79.7	24	151.4
6	82.5	25	156.7
7	85.4	26	162.2
8	88.5	27	167.9
9	91.5	28	173.8
10	94.8	29	179.9
11	97.4	30	186.2
12	100.0	31	192.8
13	103.5	32	203.5
14	107.2	33	210.7
15	110.9	34	218.1
16	114.8	35	225.7
17	118.8	36	233.6
18	123.0	37	241.8
19	127.3	38	250.3

Channel Frequencies

Channel	MHz	Channel	MHz
1	462.5625	8	467.5625
2	462.5875	9	467.5875
3	462.6125	10	467.6125
4	462.6375	11	467.6375
5	462.6625	12	467.6625
6	462.6875	13	467.6875
7	462.7125	14	467.7125

90 DAY LIMITED WARRANTY

Applies to Audiovox Family Radio Service Products.

AUDIOVOX CORPORATION (the Company) warrants to the original retail purchaser of this product that should this product or any part thereof, under normal use and conditions, be proven defective in material or workmanship within 90 days from the date of original purchase, such defect(s) will be repaired or replaced with new or reconditioned product (at the Company's option) without charge for parts and repair labor.

To obtain repair or replacement within the terms of this Warranty, the product is to be delivered with proof of warranty coverage (e.g. dated bill of sale), specification of defect(s), transportation prepaid, to the warranty center at the address shown below.

The Company disclaims liability for communications range of this product.

This Warranty does not apply to any product or part thereof which, in the opinion of the Company, has suffered or been damaged through alteration, improper installation, mishandling, misuse, neglect, accident, or by removal or defacement of the factory serial number/bar code label(s). THE EXTENT OF THE COMPANY'S LIABILITY UNDER THIS WARRANTY IS LIMITED TO THE REPAIR OR REPLACEMENT PROVIDED ABOVE AND, IN NO EVENT, SHALL THE COMPANY'S LIABILITY EXCEED THE PURCHASE PRICE PAID BY PURCHASER FOR THE PRODUCT.

This Warranty is in lieu of all other express warranties or liabilities. ANY IMPLIED WARRANTIES, INCLUDING ANY IMPLIED WARRANTY OF MERCHANTABILITY, SHALL BE LIMITED TO THE DURATION OF THIS WRITTEN WARRANTY. ANY ACTION FOR BREACH OF ANY WARRANTY HEREUNDER INCLUDING ANY IMPLIED WARRANTY OF MERCHANTABILITY MUST BE BROUGHT WITHIN A PERIOD OF 30 MONTHS FROM DATE OF ORIGINAL PURCHASE. IN NO CASE SHALL THE COMPANY BE LIABLE FOR ANY CONSEQUENTIAL OR INCIDENTAL DAMAGES FOR BREACH OF THIS OR ANY OTHER WARRANTY, EXPRESS OR IMPLIED, WHATSOEVER. No person or representative is authorized to assume for the Company any liability other than expressed herein in connection with the sale of this product.

AUDIOVOX CORPORATION, 150 MARCUS BLVD., HAUPPAUGE, NEW YORK 11788

1-800-645-4994

128-5385

Free Manuals Download Website

<http://myh66.com>

<http://usermanuals.us>

<http://www.somanuals.com>

<http://www.4manuals.cc>

<http://www.manual-lib.com>

<http://www.404manual.com>

<http://www.luxmanual.com>

<http://aubethermostatmanual.com>

Golf course search by state

<http://golfingnear.com>

Email search by domain

<http://emailbydomain.com>

Auto manuals search

<http://auto.somanuals.com>

TV manuals search

<http://tv.somanuals.com>