

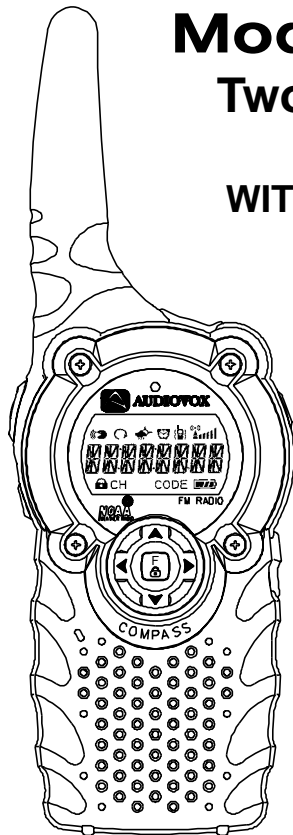

# **Model FR-1500XTM**

## **Two-Way Family Radio**

**WITH NOAA AND FM RADIO**



**Owner's Manual**

Customer Service  
1-800-290-6650

**CONGRATULATIONS ON YOUR SELECTION  
OF THE FR-1500XTM (FAMILY RADIO)**

It is one of the most sophisticated and reliable two way  
family radios available.

BEFORE OPERATING YOUR FR-1500XTM (FAMILY RADIO)  
**READ THIS MANUAL CAREFULLY**

---

## FEATURES

---

Your FR-1500XTM Family Radio is a portable, easy to use, two-way radio that you can carry almost anywhere. It is skillfully constructed to give you reliable communications for many different applications. The FR-1500XTM is ideal for use around the house, in your boat, on hunting and camping trips, on the ski slopes or at the mall. Some of the FR-1500XTM features are:

- No Air Time Fees and No License Required
- Up to 2 Mile Range
- Battery Saver and Auto Squelch
- National Oceanic and Atmospheric Administration (NOAA)
- 14 Family Radio Service Channels
- 38 Continuous Tone Coded Squelch System (CTCSS)
- Multifunction LCD Display
- Roger Beep and Call / Ring Button
- FM Radio with Tune/Seek and Preset Functions
- Built-In Compass
- Time-of-Day Readout
- Temperature Readout in Degrees Fahrenheit and Centigrade
- Stopwatch Function
- Setup Menu for Personalizing Unit Functions
- Vibrating Call Function

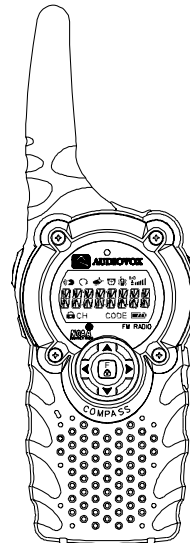

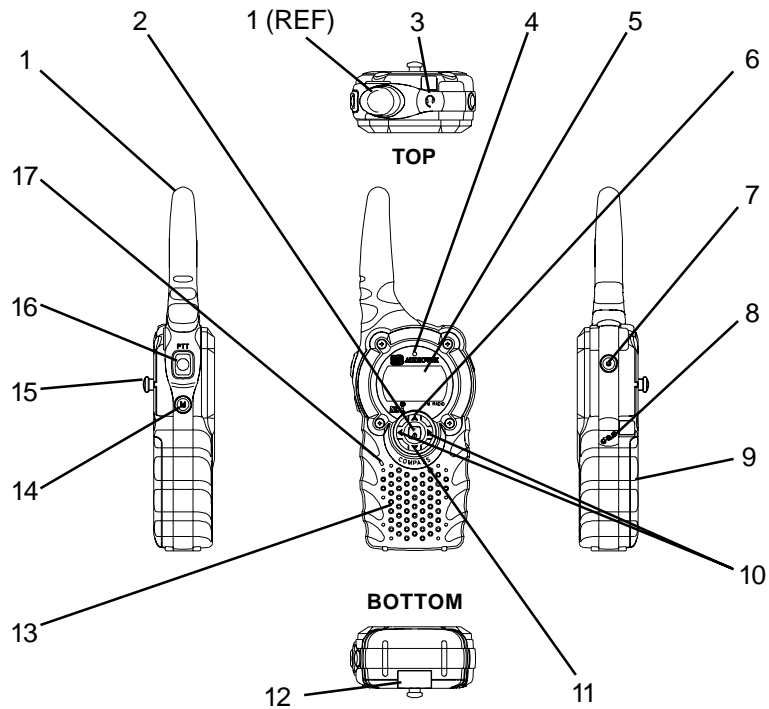

- |  |   |
|--|---|
| 1. Antenna                             | 9. Battery Compartment Door             |
| 2. Function (F) Select/Key Lock Button | 10. Menu Scroll Buttons (Forward/Back)  |
| 3. External Microphone/Speaker Jack    | 11. Down Control/Volume Decrease Button |
| 4. Transmit (Red) LED                  | 12. Battery Compartment Cover Latch     |
| 5. Liquid Crystal Display (LCD)        | 13. Built-in Speaker                    |
| 6. Up Control /Volume Increase Button  | 14. Monitor (M) Button                  |
| 7. Power On/Off Button                 | 15. Belt Clip Stud                      |
| 8. Battery Charging Connector          | 16. Push-To-Talk (PTT) Button           |
|  | 17. Built-In Microphone                 |

## MODEL FR-1500XTM DISPLAY

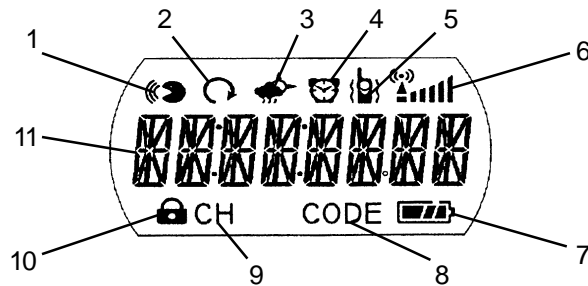

1. Voice Activated Transmission (VOX) Indicator: Blinks in the VOX selection mode or appears when VOX is activated.
2. Auto Scan Indicator: Icon appears when the auto scan channel mode is activated.
3. Weather Alert Indicator: This icon appears when the National Oceanic and Atmospheric Administration (NOAA) alert mode is activated.
4. Alarm Indicator: Appears when the Clock Alarm mode is activated.
5. Call Ringer and Vibration Indicator: Appears when vibration call mode is activated.
6. RSSI Indicator; indicates receive signal strength.
7. Battery Level Indicator: Icon indicates the battery charge strength.
8. CODE: Continuous Tone Coded Squelch System (CTCSS) Indicator: CTCSS tone code is displayed in two characters directly above.
9. CH: Indicates the channel number in use in FRS mode; channel number is displayed in two characters directly above.
10. Key Lock Indicator: Appears when the key lock is activated.
11. Eight-character display; used in various modes to indicate user identification (ID), operating parameters such as FR channel and CTCSS code, stopwatch operation, FM radio frequency, time-of-day, temperature, compass heading, receive signal level indicator, etc.

Each time the Function (F) Button is pressed, the FR-1500XTM scrolls through the main menu; pressing and holding the Function button for 2 seconds or longer activates the keylock (  ) feature, whereby all buttons except volume adjustment, Function (F), Monitor (M) and Press-to-Talk (PTT) are inoperable.

### **Accessories**

**SUPPLIED:** (1) Belt Clip

**OPTIONAL:** (1) Headset P/N FRS-BHST

#### **NOTE:**

To order optional accessories for the FR-1500XTM, please contact Customer Service at 1-800-290-6650 or visit the Audiovox web site at [www.audiovox.com](http://www.audiovox.com).

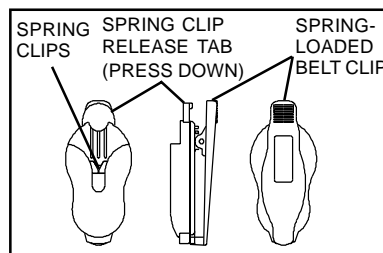

Belt Clip Accessory

### **Powering the FR-1500XTM Unit:**

The FR-1500XTM unit operates on four AAA batteries installed in the battery compartment. You may operate the unit using type NiMH rechargeable batteries, or you may use Alkaline batteries. Alkaline batteries will provide slightly better performance than the rechargeable batteries. The rechargeable batteries can not be recharged while in the unit.

### **Installing the Batteries:**

Installing batteries in the FR-1500XTM unit is straightforward as shown in the following illustration.

1. Remove unit from belt clip, and simply unlatch the cover clip at the bottom rear of the unit; lift off the battery compartment cover.
2. Remove the weak batteries, if present.
3. Install four AAA batteries and carefully note battery polarity as marked within the battery compartment.

**NOTE:** When the last battery is installed in place, the unit will vibrate for approximately 2 seconds, indicating battery installation is correct, and the self-test display will appear momentarily, then fade out.

4. Slide up the battery compartment cover in place; swing up the cover retaining clip and snap it into position.

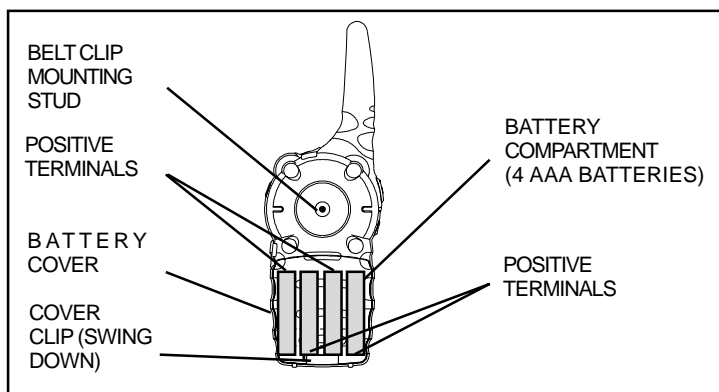

The following guidelines will improve performance and provide longer operating times for the FR-1500XTM:

1. Do not mix old and new batteries.
2. The use of alkaline-type batteries is recommended to provide the longest operating time.
3. Do not mix alkaline, standard (carbon-zinc) or rechargeable batteries.
4. If the unit is not to be used for an extended period of time, remove the batteries. Old or leaking batteries can cause damage to the unit and will void the warranty.

### Controls:

#### Power On/Off (⏻) Button (6):

Press and hold this button (⏻) momentarily to turn the unit on. The unit will perform a brief self-test and then vibrate for a short time; the user identification code will display from left-to-right, sequencing through all 8 display characters, followed by display of **TWO WAY** (accompanied by a short melody). The unit will then beep and the FRS standby display appears showing **CH, CODE** and the battery charge icon.

To turn the unit off, press and hold the button for a 2 second period. A short melody will sound as the unit shuts off.

#### Function (F) Button (2):

In the standby mode, pressing this button will scroll through the various modes as shown in the Operational Modes diagram.

Pressing the button for more than 1.5 seconds will activate or deactivate the KEY LOCK feature in any mode. Refer to KEY LOCK function description to activate and deactivate

## FRS-1500XTM OPERATIONAL MODES

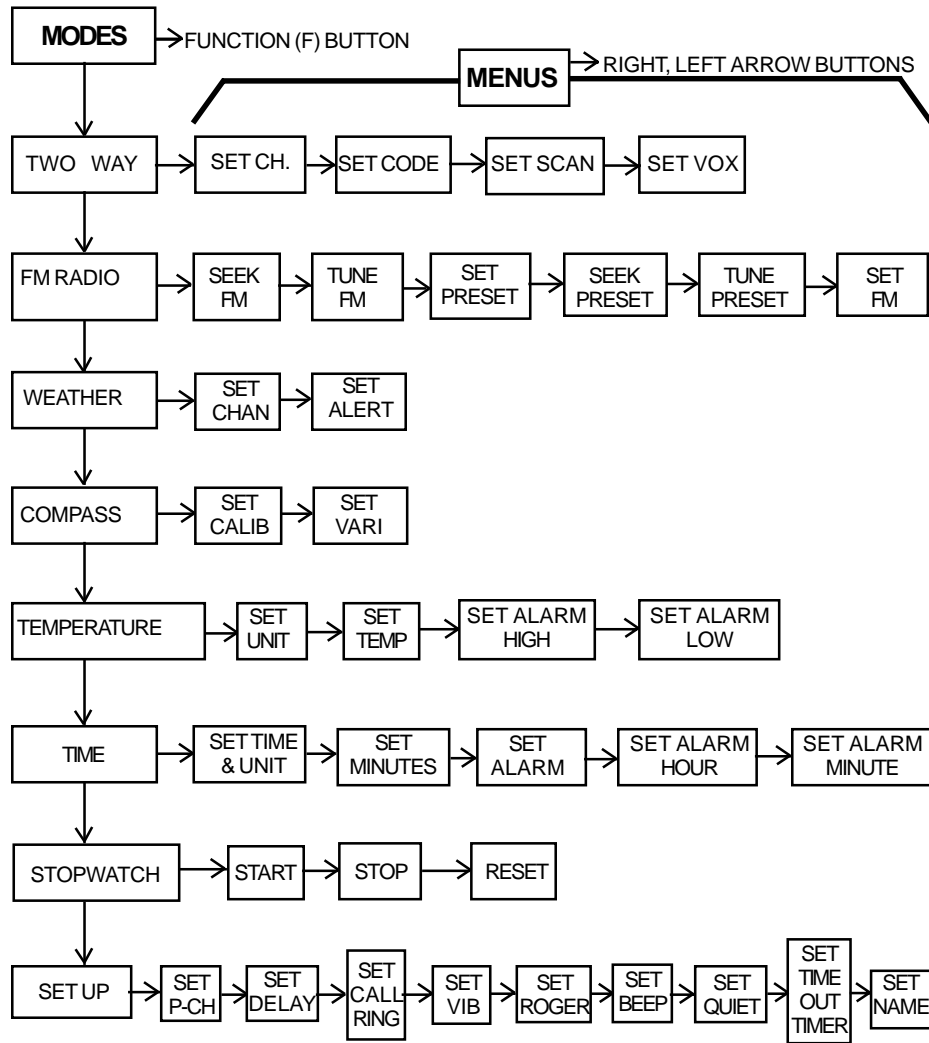



**NOTE:** In KEY LOCK, all buttons will be disabled except for the Up ( ▲ ) Control/Volume Button (6), the Down ( ▼ ) Control/Volume Button (11), the Monitor (M) Button (14) and the PTT Button (16).

**Push-To-Talk (PTT) Button (16):**

Pressing and holding this button will allow you to speak to any transceiver that is set to the same channel and privacy code setting as yours. Hold the transceiver approximately 1 to 2 inches from your face as you speak into the built-in microphone (17). After you have finished speaking, release the PTT button to allow for reception of incoming signals. It is not possible to transmit and receive at the same time.

The transmit LED indicator (4) located above the LCD Panel (5) will light red while the PTT button is pressed. Releasing the button allows the unit to revert to standby mode.

The PTT button can also be used as a two-way call ringer. Pressing the button twice quickly will call another party on the same channel. The letter **T** (transmit) will appear in the display and the user-selected call melody will sound.

**Volume Control (6 and 11):**

In the standby mode, adjust the volume to a comfortable level between **01** and **16** by pressing the Up (6) button to increase the volume level and the Down (11) button to decrease the volume level. Pressing the Monitor (M) button momentarily will check the volume setting level.

**Up Button (6):**

In the standby mode, pressing this briefly will increase the volume. In the function edit mode, pressing the button briefly will shift from the current option in each sub-menu to next option in the same sub-menu.

Pressing the button for more than 1.5 seconds allows navigation at a more rapid rate. In the standby mode the volume will increase rapidly. In the function mode, different options can be rapidly changed.

**Down Button (11):**

In the standby mode, pressing this briefly will decrease the volume. In the function edit mode, pressing the button briefly will shift from the current option in each sub-menu to next previous option in the same sub-menu.

Pressing the button for more than 1.5 seconds allows navigation at a more rapid rate. In the standby mode the volume will decrease rapidly. In the function mode, different options can be rapidly changed.

### **Menu Scroll Forward and Back Buttons (10)**

These buttons are used to scroll through the options in a selected menu; the menu is determined by mode selection using the Function (F) button. Refer to the Operational Modes flow diagram.

### **Monitor (M) Button (14):**

The Monitor Button is used to check the activity on a channel before transmitting. When the Monitor Button is pressed, the green LCD panel (5) backlight will come on. Pressing the Monitor Button during the edit function mode will confirm an entry and return the unit to standby. Pressing the Monitor Button during a VOX transmission (voice activated transmission) will discontinue the transmission and disable the VOX function for 2 seconds.

### **External Microphone/Speaker (3):**

This jack accepts an Audiovox FRS-BHST headset/microphone for total hands-free operation.

### **External Battery Charging Connector (8):**

This jack is part of a future upgrade for an Audiovox approved battery recharger. Do not use this jack with any other charging devices. Please visit the Audiovox web site for updates at [www.audiovox.com](http://www.audiovox.com). or contact Customer Service at 1-800-290-6650 for additional optional accessories for the FR-1500XTM.

### **NOTES FOR GOOD COMMUNICATION**

1. The FR-1500XTM 14 channels are shared on a 'take turns' basis. This means other groups may be talking on any of the channels. A common code of ethics/courtesy is to switch to another vacant channel and not to attempt to talk over someone who is already using the channel you first selected.
2. The FR-1500XTM has been designed to maximize performance and improve transmission range in the field. To avoid interference, it is recommended that you do not use the units closer than 5 feet apart.
3. For best transmission results, always keep your mouth about 2-3 inches from the microphone (17) and speak slowly in a normal voice.

## OPERATING MODES AND FEATURES

### ***FRS TWO WAY MODE***

#### **CHANNEL NUMBER SELECTION**

This feature allows the selection of main channels for communication as follows:

1. From the FRS TWO WAY mode (**CH** and **CODE** displayed), press the right (forward) menu scroll button (10) once; the channel (**CH**) number flashes on the display (5).
2. Press the Up (▲) Button (6) or the Down (▼) Button (11) to choose the desired channel.
3. Press the Monitor (M) button (14) to confirm your selection.

#### **CODED TONE CONTROL SQUELCH SYSTEM (CTCSS) CODE SELECTION**

When the **CTCSS** feature is enabled, the transceiver will only receive signals from other transceivers set to the same channel and privacy code. When the CTCSS mode is off, the transceiver will receive signals from all transceivers set to the same channel. Remember that the CTCSS feature does not prevent others from listening to your transmissions. It only allows your FR-1500XTM to ignore signals from transceivers not set to the same privacy code. Access the CTCSS code selection feature as follows:

1. From the FRS TWO WAY mode (CH and CODE displayed), press the right (forward) menu scroll button (10) twice; the CODE number flashes on the display(5).
2. Press the Up Button (6) or the Down Button (11) to select the desired sub-code between **01** and **38**.
3. Press the Monitor (M) button (14) to confirm your selection.

**NOTE:** To communicate with other units, they must be switched to the same channel and CTCSS sub-code. To communicate with other units that do not have subcodes, switch your unit to the same channel with the sub-code set to **00**.

#### **CHANNEL SCAN OPERATION**

##### ***ALL CHANNEL SCAN***

This feature allows scanning for an active channel on all 14 FRS channels. The power saver is disabled in this mode. To activate this feature:

1. From the FRS TWO WAY mode (CH and CODE displayed), press the right (forward) menu scroll button (10) three times; SCAN will appear on the LCD display (5) with OFF flashing (if scan was not active before)

2. Press the Up Button (6) or the Down Button (11) to choose normal (flashing NR) scanning. The scan icon (  ) also appears flashing.
3. When NR is flashing, press the Monitor (M) button (14) to confirm your selection.
4. To turn off the auto channel scan feature, return to the Scan mode by pressing the forward menu scroll button to access the **SCAN** function and choose **OFF**.

The unit will begin scanning in the upward direction (starting from the current channel), looking for an active main channel. If a transmission is detected, the RSSI icon (  ) will appear on the display, and the signal strength (0-9) will display below the icon. During scan, when a signal is received, scan will pause for 5 seconds and then resume.

You can transmit on the primary channel for 15 seconds, while in the Auto Channel Scan Mode, by pressing the PTT Button (14). Channel scan will then resume. Pressing the Monitor Button (14) will cause scanning to resume during a received signal.

#### ***PRIORITY CHANNEL SCAN MODE***

This feature allows you to monitor two different channels at the same time. If you preset any priority channel other than the current channel in use, the preset channel will be scanned every 0.5 second and signals you when a call is received. The priority channel will be the one selected during the SET UP mode, and the other channel will be the one selected from the TWO WAY menu. While in the Priority Channel Scan mode, you may hear transmissions from either a primary or secondary channel when transmitting. The unit will always transmit on the primary channel unless the PTT button (14) is pressed during or immediately following the reception of secondary channel transmission. To access the Priority Channel Scan mode proceed as follows:

1. From the FRS TWO WAY mode (CH and CODE displayed), press the right (forward) menu scroll button (10) three times; **SCAN** will appear on the LCD display (5) with **OFF** flashing (if scan was not active before).
2. Press the Up Button (6) or the Down Button (11) to choose priority (flashing **PRI**) scanning. The scan icon (  ) also appears flashing.
3. Press the Monitor button (14) to confirm your selection.  
**NOTE:** The unit will scan between the normal channel selected from the TWO WAY menu and the priority channel chosen during the SET UP mode.
4. To turn off the Priority channel scan feature, return to the Scan mode by pressing the forward menu scroll button to access the **SCAN** function and choose **OFF**.

## **VOX FUNCTION**

This feature enables you to have hands-free conversation. When using the internal microphone/speaker or an external microphone/headset (purchased separately), your voice or the signal is detected and the radio transmits and receives automatically. When in the VOX mode, a short beep will sound after the termination of any VOX generated transmission.

### **VOX SENSITIVITY SELECTION**

This feature allows the user to select the voice/signal level at which the unit will transmit. The high sensitivity setting ( **HI** ) should be used in low background noise environments or when whispering. The low sensitivity setting ( **LO** ) should be used in high background noise environments. The normal ( **MID** ) setting can be used in most all typical applications. To access the VOX Selection menu:

1. From the FRS TWO WAY mode (CH and CODE displayed), press the right menu button four times; VOX will appear on the LCD display together with the flashing VOX icon (  ) and a flashing **OFF, LO, MID** or **HI** indication.
2. Press the Up Button (6) or the Down Button (11) to choose the VOX sensitivity setting desired (LO, MID or HI).
3. Press the Monitor (M) button (14) to confirm your selection.

### **VOX DELAY TIME SELECTION**

This feature allows the response time characteristics of the VOX function to be precisely adjusted to suit individual needs. The VOX Recovery Time Selection menu is accessible from the SET UP menu and provides choices of OFF, 1, 2, 3, 4 or 5 seconds. (Refer to the SET UP mode for VOX Recovery Time Selection.)

## **FM RADIO MODE**

The FM Radio Mode provides the user with FM radio capability, thereby allowing FM radio enjoyment even though other modes of the FRS-1500XTM are being used.

The various FM radio features are listed on the Operational Modes flow diagram, and include most FM receiver characteristics. To enter the FM RADIO mode, proceed as follows:

1. From the FRS TWO WAY mode (CH and CODE displayed), press the Function (F) button once; **FM RADIO** appears on the display accompanied by a short melody.
2. Approximately 2 seconds later, the FM standby display appears showing **FM** and the current station frequency (in MHz).

### FM SEEK

The FM seek function allows scanning of the FM band for an active broadcast. To enter this function, proceed as follows:

1. From the FM standby mode, press the right menu button (10); the frequency display will flash; an **S** (scan) appears to the right of the frequency display.
2. Press the Up (6) or Down (11) buttons to activate the seek function. The radio will scan in the up or down direction looking for an active (strong) FM station.
3. When a station is found, the scan will stop at that frequency and re-enter the standby listening mode.
4. Press the Monitor (M) button to confirm.

Adjust the volume to a comfortable level using the Up (6) and Down (11) buttons for volume control.

### FM TUNE

The FM tune function allows for station tuning in 100kHz steps. This function is accessed as follows:

1. From the FM standby mode, press the right menu button (10); the frequency display will flash.
2. Press the right menu button again; a **T** (tune) will appear to the right of the frequency display.
3. Use the Up (6) or Down (11) buttons to increase or decrease FM frequency in 100kHz steps.
4. When the desired station is displayed, press the Monitor (M) button to confirm selection.

Adjust the volume to a comfortable level using the Up (6) and Down (11) buttons for volume control.

### FM MEMORY PRESET

The FM memory preset function allows you to preset up to 9 station frequencies into memory, thereby making them readily accessible without having to scan or tune through the FM frequency band for a favorite station. To access the memory preset function, proceed as follows:

1. Access the FM tune function as outlined in steps 1 and 2 above.
2. Press the right menu button again; **MEM** appears on the display with **OFF** flashing.
3. Press the Up (6) or Down (11) button to set memory **ON**; then press the right menu button to access the first memory preset. **M** appears with **1** flashing to the right and the current FM frequency.
4. With **1** flashing, press the right menu button until **T** (tune) appears to the right of the frequency; then press the Up (6) or Down (11) button to select the desired station for preset number 1 in 100kHz steps.

**NOTE:** You can use the scan tune (**S**) function to more quickly establish the preset station frequencies.

5. Press the left menu button until **1** begins to flash again; then press the Up (6) button to increment the preset to number **2** which also flashes.
6. Repeat steps 4 and 5 to establish the second preset station frequency.
7. Repeat step 6 to increment the preset number to **3** and repeat steps 4 and 5.
8. Continue with presets **4** through **9** as indicated.
9. Press the right menu button, scrolling through **S**, **T** and **MEM**; then press again to access **OFF** or **WAY**.
10. If **OFF** appears flashing, and you wish to turn off FM radio reception whenever other modes are being used, press the Monitor (M) button to confirm. If **WAY** is flashing, and you wish to continue FM radio reception while other modes are being used, press the Monitor (M) button to confirm.

**NOTE:** When **WAY** is selected, FM broadcast can be heard in all modes except for Weather band. During FRS transmission and reception, the FM program is interrupted and will resume when transmission or reception ends.

## **WEATHER MODE**

### **NATIONAL OCEANIC AND ATMOSPHERIC ADMINISTRATION (NOAA) RECEIVER MODE**

NOAA provides transmitters which are located throughout the United States; these transmitters broadcast National Weather Service warnings, watches forecasts and hazard information 24 hours a day.

The NOAA receiver on the FR-1500XTM provides you with weather information for all types of hazards. This function allows you to listen to one of 10 weather channels, and to configure your radio in the NOAA alert mode to inform you of emergency weather broadcasts in your listening area. To access the NOAA functions, proceed as follows:

#### **NOAA WEATHER MENU**

To access the NOAA channel menu:

1. From the FRS TWO WAY mode (CH and CODE displayed), press the Function (F) button twice; **WEATHER** is momentarily displayed, followed by the **WEA** and channel indication (**01-10**).
2. Press the right menu button; the channel number flashes.
3. Press the Up button (6) or the Down button (11) to select the strongest of the 10 channels.
4. Press the Monitor (M) button to confirm channel selection.

### **NOAA ALERT MODE**

Whenever you are listening to the weather channel broadcast, the 2-way radio function of the FR-1500XTM is disabled; however, when the NOAA alert function is active, the FR-1500XTM operates in the normal radio modes. After setting the NOAA alert option in the NOAA mode, when the radio receives the NOAA alert signal, it switches to the selected weather channel and normal radio operation is inhibited. Set the NOAA alert mode as follows:

1. From the FRS TWO WAY mode (**CH** and **CODE** displayed), press the Function (F) button twice; **WEATHER** is momentarily displayed, followed by the **WEA** and selected channel indication (**01-10**).
2. Press the right menu button; the channel number flashes; press the right menu button again. The Alert (**ALT**) indication appears with a flashing **OFF** indication if the feature is not activated.
3. Press the Up (6) button; **ON** appears flashing together with a flashing NOAA alert icon (  ).
4. Press the Monitor (M) button to confirm the alert selection; the alert icon remains steady on the display, which now returns to the weather channel menu display.

The radio is now in the NOAA alert mode, awaiting a weather alert on one of the NOAA weather channels you have selected.

### **COMPASS MODE**

#### **HEADING INDICATION**

The compass mode displays the direction in which the FRS antenna is pointed with respect to the magnetic North Pole; the display indicates antenna heading in degrees (0 - 360) in one of 8 directions (N, NE, E, SE, S, SW, W, NW, ), any of which can be calibrated for the deviation, or variation, with respect to True North (geographical North Pole).

To access the Compass mode:

1. From the FRS TWO WAY mode (**CH** and **CODE** displayed), press the Function (F) button 3 times; **COMPASS** is momentarily displayed, followed by the heading indication.
2. If the compass has already been calibrated for your current position, then the FRS antenna need only be pointed in any direction to establish the desired bearing to a desired destination.

**NOTE:** Hold the unit in a flat and level manner while taking bearings.



## COMPASS CALIBRATION

Since the apparent position of magnetic North will vary according to your location in the world (especially Latitude), you will need to know the difference between these two positions (Magnetic and True North) to take an accurate bearing. To calibrate the compass for the effects of magnetic variation, proceed as follows:

**NOTE:** When calibrating the compass, make sure the unit is at least 2 yards away from any source of magnetic interference.

1. From the FRS TWO WAY mode (**CH** and **CODE** displayed), press the Function(F) button 3 times; **COMPASS** is momentarily displayed, followed by the heading indication.
2. Press the right menu button; **CALIB** appears with **OFF** flashing.
3. Press the Up button (6); flashing **TUN** appears.
4. Place the unit on a flat non-metallic surface and rotate the unit twice, very slowly at a constant rate, through 360 degrees, taking about 10 seconds to complete the successive circles.
5. Press the Up or Down button; **CALIB** appears with **OFF** flashing.
6. Press the Monitor (M) button to confirm compass calibration and initiate the compass function.

To insert compensation for the effects of magnetic variation, perform the following steps:

7. Repeat steps 1 and 2, and press the right menu button twice; **VARI** appears with a flashing **0** (if no magnetic variation has been inserted).
8. Press and hold the Up button (6); variation increases quickly between **0** and **+90**. If the Up button continues to be held, variation will begin to decrease from -90 to 0 after +90 is reached. The Down button will also perform the same function in the reverse manner.

The following table presents a list of declination angles for a number of major world cities; insert the proper value to compensate for the effects of magnetic variation when you are in the specified location.

Anchorage +22	Denver -4	New York -14	Seattle +19
Atlanta -4	Jerusalem +3	Orlando -5	Seoul, Korea -7
Bombay -1	London -4	Oslo -2	Shanghai -5
Boston -16	Little Rock +3	Paris -2	Toronto -11
Calgary -18	Livingston +14	Rio De Janeiro -21	Vancouver -20
Chicago -3	Munich +1	San Francisco +15	Washington DC -10
			Waterbury, CT -14

## **TEMPERATURE MODE**

The Temperature mode allows you to know the ambient temperature on both the Centigrade and Fahrenheit scales. In addition, you can set high and low temperature limits on either scale; when a limit is reached or exceeded, the unit will sound a warning melody, repeating it every 5 seconds. As an additional feature, the temperature alarm limits can be automatically transmitted on the current channel, together with your user ID; this will occur every 5 minutes when the preset alarm temperature is reached or exceeded, provided the temperature plus transmit mode is enabled (+TX). To access the temperature mode, proceed as follows:

1. From the FRS TWO WAY mode (**CH** and **CODE** displayed), press the Function (F) button 4 times; **TEMPERATURE** is momentarily displayed, followed by the temperature indication (**TEMP**) in **Centigrade** or **Fahrenheit**.

**NOTE:** When moving from a moderate temperature environment to either a cooler or hotter environment, allow about 20 minutes for the unit temperature sensing element to stabilize.

2. To change the temperature scale, press the right menu button once; **C** or **F** will flash.
3. Press the Up button (6); the temperature scale will change from **C** to **F** or vice-versa.

To set the high and low temperature alarm limits:

4. Access the temperature mode as outlined in step 1. Press the right menu button again; **ON** or **OFF** will appear flashing. Press the Up or Down button (11) to set temperature **ON**; then press the Monitor (M) button to confirm.
5. With **TEMP** in **C** or **F** displayed, press the right menu button three times; **AL H**: appears with the temperature indication flashing, provided temperature is **ON**. The indication will be in **F** or **C**, depending on the temperature scale previously selected.
6. Press the Up or Down button to set the high temperature alarm limit; if the low temperature alarm is desired, proceed to step 7. If not, press the Monitor (M) button to confirm the high temperature setting.
7. Press the right menu button; **AL L**: appears with the **C** or **F** indication flashing provided temperature is **ON**.
8. Press the Up or Down button to set the low temperature alarm limit; then press the Monitor (M) button to confirm the low temperature setting.

The temperature alarm transmit mode will automatically transmit a call tone with the radio's identification (ID) code (if entered) and temperature to other FR-1500 XTM units on the same channel. This mode is accessed in the following manner:

9. Repeat steps 4 through 8 to set the high and/or low temperature alarm limits; then press the right menu button until **ON** is flashing.

10. Press the Up or Down button until **+TX** appears flashing; then press the Monitor (M) button to confirm the alarm transmit setting.

**NOTE:** This mode will only operate if the radio ID is enabled on and the unit's temperature triggers a temperature alarm.

### **TIME MODE**

The Time mode provides you with a reliable clock which not only indicates the time-of-day on a 12 or 24 hour basis, but also permits an alarm set capability provided the beep tone feature is enabled. To access the time mode, proceed as follows:

1. From the FRS TWO WAY mode (**CH** and **CODE** displayed), press the Function (F) button 5 times; **TIME** is momentarily displayed, followed by the indication in **AM** or **PM**.
2. To set the clock to a 12 hour display, press the right menu button once; the hours digits will flash. (To access the 24 hour display, press the Up or Down buttons until the AM/PM indication disappears from the display; then proceed with the hour/minute setting.)
3. Press the Up button or Down button; the hour indication will change between 1 and 12 accordingly. As the hour indication passes through 12 noon, the **AM** indication changes to **PM**.
4. When the hour is set, press the right menu button again; the minutes indication will flash.
5. Press the Up or Down button; the minutes indication will change between **00** and **59** accordingly.
6. Press the right menu button again; **ALARM** will appear with **ON** or **OFF** flashing, together with the alarm icon (🔔).
7. Press the Up or Down button to set the alarm ON or OFF as desired.
8. If ON is selected, use the right/ left and Up/Down buttons to select the desired time of alarm in the same manner as time-set in steps 2 through 5 above.
9. After all time functions have been selected and entered, press the Monitor (M) button to confirm.

When the alarm time is reached, the unit will repeat four short beeps at 5-second intervals; pressing any button during the alarm will snooze the alarm for 5 minutes. To disable the alarm, repeat the above procedure and select OFF at step 7.

## **STOPWATCH MODE**

The stopwatch mode provides you with the capability of timing certain external functions without the need for a separate time piece. To use the stopwatch feature, proceed as follows:

1. Press the Function (F) button 6 times; **STOPWATCH** appears on the display momentarily, followed by eight zeros; each pair of zeros is separated by a colon (:), signifying tenths-of-seconds, seconds, minutes and hours, right-to-left.
2. Press the right menu button to initiate the clock; the timing counter will begin counting up. While timing is in progress, press the right menu button again to stop the clock.
3. Press the right menu button to reset the stopwatch time to zero.
4. Press the left menu button to start and stop the timing counter, while the timing is in progress, without resetting the timer function.
5. Press the Function (F) button to exit the stopwatch mode.

## **SETUP MODE**

The SETUP mode is accessed by pressing the Function (F) button 7 times; this mode contains a number of sub-modes designed to personalize the functions of your FRS-1500XTM. These sub-modes consist of the following:

- \* Setting the Priority radio channel
- \* Setting the VOX delay time
- \* Choosing the Call melody
- \* Setting the ring vibrator on or off (or choosing both on)
- \* Setting Roger Beep on or off
- \* Setting the beep tone (key or button beep) on or off
- \* Setting the Quiet mode on or off
- \* Selecting a Time Out Timer setting (or none)
- \* Entering an identification name (ID) tag for your unit

### **PRIORITY CHANNEL SELECT**

The priority channel is the radio channel that you and others in your group will be monitoring for activity. To select the priority channel, proceed as follows:

1. With **SETUP** displayed, press the right menu button once; **P. CH** appears with the channel number flashing on the right.
2. Press the Up and Down buttons to select the priority channel you wish to use.

3. Press the Monitor (M) button to confirm your selection; the display returns to **SETUP**.

When you initiate a priority scan, as explained earlier, the unit will scan between this priority channel and the channel selected in the **TWO WAY** menu.

### SET VOX DELAY

When the VOX function is activated in the TWO WAY mode, the VOX delay is incorporated as selected from this menu. This delay represents the time delay after the unit stops detecting a VOX signal and before it stops transmitting. If you have long pauses in your speech patterns, a longer delay setting will transmit your speech in a more articulate manner. To set the delay time, proceed as follows:

1. From the **SETUP** mode, press the right menu button twice; **DLAY** appears with **OFF** (or number **1-5S**) flashing.
2. Press the Up and Down buttons to select the desired delay time between **1** and **5 Seconds**, or select **OFF** if no delay is needed.
3. Press the Monitor (M) button to confirm your selection; the display returns to **SETUP**.

### CALL MELODY SELECTION

This feature provides seven selectable call ringer melodies that alert the user that a calling party wishes to communicate with them. Once the melody is chosen, pressing the PTT Button (14) twice within one second will transmit the call tone selected. To select your favorite Call Ringer melody:

1. From the **SETUP** mode, press the right menu button three times; **CALL** will appear, with **OFF** or number **1-7** flashing, and the call melody for that number will sound.
2. Press the Up or Down Buttons to preview the seven available melodies, stopping at the one preferred.
3. Press the Monitor (M) button to confirm your selection; the display returns to **SETUP**.

### RINGER VIBRATION SELECTION

The unit can be made to vibrate whenever a call is being received; this selection gives the user the option of ringer only, vibration only, or employing both at the same time. To select this option, proceed as follows:

1. With **SETUP** displayed, press the right menu button four times; **RING** appears with **R**, **V** or **R+V** flashing on the right, together with the vibrator icon (  ).
2. Press the Up and Down buttons to select the desired option.

**NOTE:** The ringer vibration will only work between two FR-1500XTM's.

3. Press the Monitor (M) button to confirm your choice; the display returns to **SETUP**.

With the ring set for RING only, the unit will play a receive and play a call melody from a transmitting FRS unit. If the unit is set for Vibrator only, no melody will play, but the unit will vibrate whenever a call is being received. This feature is useful when a call ring can be disruptive in an otherwise quiet environment. If the unit is set for both ring and vibrator options, both call features will be active.

### **ROGER BEEP TONE SELECTION**

The unit will transmit a beep tone sequence after each transmission to signal the receiving party that transmission has ended. This tone is called a "Roger Beep".

To enable/disable the Roger Beep tone, proceed as follows:

1. With **SETUP** displayed, press the right menu button five times; **ROGER** appears with a flashing **ON** or **OFF** indication.
2. Press the Up or Down button to set the Roger Beep mode **ON** or **OFF** as desired.
3. Press the Monitor (M) button to confirm your selection; the display returns to **SETUP**.

**NOTE:** This function must be enabled for the clock alarm function to operate.

### **KEY BEEP TONE SELECTION**

The unit will emit a confirmation beep tone after a button has been pushed. To enable/disable the key beep tones, proceed as follows:

1. With **SETUP** displayed, press the right menu button six times; **BEEP** appears with a flashing **ON** or **OFF** indication.
2. Press the Up or Down button to select the beep mode **ON** or **OFF** as desired.
3. Press the Monitor (M) button to confirm your selection; the display returns to **SETUP**.

### **QUIET OPERATION**

Whenever you transmit, the receiving party (on the same channel) will hear the short buzz, referred to as the "Squelch Tail", when you finish the transmission. The unit can be set to suppress (quiet) this noise by using the QUIET option. To enable/disable the quiet option, proceed as follows:

1. With **SETUP** displayed, press the right menu button seven times; **QUIET** appears with a flashing **ON** or **OFF** indication.
2. Press the Up or Down button to select quiet mode **ON** or **OFF** as desired.
3. Press the Monitor (M) button to confirm your selection; the display returns to **SETUP**.

### **TIME OUT TIMER (TOT)**

This feature allows the user to limit continuous transmission times (pressing and holding the PTT button). This feature provides four selectable time out options (OFF, 30/60/180 seconds) the user can select:

1. From the **SETUP** mode, press the right menu button eight times; **TOT** will appear, with OFF, 30, 60 or 180 flashing.
2. Press the Up or Down Buttons to select the selected time out option, stopping at the one preferred.
3. Press the Monitor (M) button to confirm your selection; the display returns to **SETUP**.

### **NAME SELECTION OPTION**

The name selection option provides the user with the capability of entering an identification (ID) name into unit memory consisting of eight characters. This name, or ID (it could also be a number or an alphanumeric combination), once entered, will appear on the display when the unit is turned on. If no ID is entered, the AUDIOVOX icon will be spelled out across the eight character positions on the display. To enter an ID into unit memory, proceed as follows:

1. From the **SETUP** mode, press the right menu button nine times; **NAME** will appear, with **OFF** or **ON** flashing.
2. Press the Up or Down button to select the name **ON** or **OFF** as desired.
3. If **ON** is selected, press the right menu button; the current name will appear with the first character position flashing.
4. While the character position is flashing, press the Up and Down buttons to scroll through the alphanumeric choices you wish to incorporate into the ID option.

**NOTE:** In addition to alphanumeric characters, other icons are also available for use, such as brackets, a + sign, etc.

5. After choosing the first character, press the right menu button to access the second position; then use the Up and Down buttons, as before, to choose the desired character.
6. Repeat steps 4 and 5 to incorporate the other seven characters as needed. One of the available symbols can be used to occupy the unused character positions.

**NOTE:** This feature will retain the user settings when the batteries are removed and/or replaced.

### **KEY LOCK SELECTION MODE**

This feature prevents accidental channel change to the user preferred settings of the FR-1500XTM. The Key Lock feature temporarily disables all buttons except volume Up/Down, Function (F), Monitor (M) and PTT. To access the Key Lock feature:

1. Press and hold the Function (F) button for at least 1.5 seconds; the lock icon appears on the display and the menu (right/left) and Up/Down buttons are disabled.
2. To exit from the key lock mode, press and hold the Function (F) button until the key lock icon disappears from the display.

### **BASIC RADIO OPERATION**

#### **TO TRANSMIT:**

1. Set the desired priority channel.
2. Press and hold the **PTT** (Push-to-Talk) button while speaking slowly and clearly in a normal voice, approximately 2 to 3 inches from the microphone.
3. The transmit indicator (**T**) will be displayed while transmitting.
4. Release the **PTT** (Push-to-Talk) button when you finish speaking to receive incoming signals.

#### **TO RECEIVE:**

1. Set the desired channel and CTCSS code.
2. Adjust the volume control to the desired listening volume by using the up and down buttons.
3. The transceiver will play strong received signals through its internal speaker or through a headset, if so equipped, and the Receive Signal Strength Indicator (RSSI) (  ), together with the appropriate level indicator (0-9) below, will display the relative strength of the signal.

### **MONITOR FUNCTION**

The Monitor (M) button can be used to play all signals present on a channel. This is useful when communicating with other parties at extreme range.

The monitor function can also be locked on by pressing the Monitor (M) button for 3 seconds; a two-tone melody will sound. When the monitor lock has been activated, the radio will issue background noise until a voice transmission is received. Momentarily pressing the monitor button again will unlock the monitor function.



## Warning

- Remove the batteries from the transceiver if it is not expected to be used for long periods. This will eliminate the possibility of chemicals leaking from the batteries and corroding the transceiver.
- Avoid exposing the transceiver to water or extremes of temperature.
- Do not use this device in or near a mining facility, which uses remotely triggered explosives or in areas labeled "Blasting Area". Premature or accidental detonation may result.
- Do not attempt to modify or in any way increase the output of this transceiver. Its output is designed to meet the legal limits set by the FCC.
- Do not use this device or change its batteries in potentially explosive atmospheres as sparks in such areas could result in an explosion.
- Turn your transceiver off wherever posted notices restrict the use of radios or cellular telephones. Facilities such as hospitals may use equipment that is sensitive to RF energy.
- Turn your transceiver off on board aircraft when requested to do so.
- Do not place your radio in front of a vehicle's air-bag. If the air-bag deploys, it could propel the transceiver like a projectile causing bodily injury.

This transceiver complies with FCC regulations for use in the United States of America. Use in other countries may be prohibited or restricted by local regulation. Please check with the local regulating agency before using this device outside the United States of America.

## Technical Specifications:

### **General**

Frequency Range:	Refer to frequency chart
FRS Channels	14
Privacy Codes	38 for each main channel
Weather Channels	Refer to frequency chart
FM Frequency Range	87.5 to 108.0 MHz
Dimensions (W x H x D) (Without Antenna)	2.5 in x 4.5 in x 1.325 in 63.5 mm x 114.3 mm x 34.9 mm
Temperature Accuracy	2.5°C variation (0° - 50°C), 3.5°C variation(-20° - 0°, 50° - 80°C) 4.5°F variation (32°-122°F) 6°F variation (-4°-32°, 122°-176°F)

### **Power Supply**

Battery	Alkaline, AAA (4), 6.0 VDC, 1000 mAh
Operating Time	30 hours (Transmit: Receive: Standby) (5: 5: 90 ratio)

### **Receiver**

Useable Sensitivity	<0.28 uV
Maximum Audio Output Power	200 mW (8 Ohm )
Modulation Distortion	3% maximum (1 kHz 60%)

### **Transmitter**

Maximum RF Output Power	500 mW ERP
Range	Up to 2 miles
Maximum Deviation	2.2 +/- 0.1kHz
Modulation Distortion	2% maximum (1 kHz 60%)

### FRS Channel Frequencies:

Channel	Freq. MHz	Channel	Freq. MHz
1	462.5625	8	467.5625
2	462.5875	9	467.5875
3	462.6125	10	467.6125
4	462.6375	11	467.6375
5	462.6625	12	467.6625
6	462.6875	13	467.6875
7	462.7125	14	467.7125

### Weather Channel Frequencies:

Channel	Freq. MHz	Channel	Freq. MHz
1	162.550	6	162.500
2	162.400	7	162.525
3	162.475	8*	161.650
4	162.425	9*	161.775
5	162.450	10*	163.275

\*Canadian Marine

## Continuous Tone Coded Squelch System Tone Frequencies (in Hz)

CTCSS	Freq. Hz	CTCSS	Freq. Hz
1	67.0	20	131.8
2	71.9	21	136.5
3	74.4	22	141.3
4	77.0	23	146.2
5	79.7	24	151.4
6	82.5	25	156.7
7	85.4	26	162.2
8	88.5	27	167.9
9	91.5	28	173.8
10	94.8	29	179.9
11	97.4	30	186.2
12	100.0	31	192.8
13	103.5	32	203.5
14	107.2	33	210.7
15	110.9	34	218.1
16	114.8	35	225.7
17	118.8	36	233.6
18	123.0	37	241.8
19	127.3	38	250.3

\* 00 = NO CODE

## Troubleshooting

Problem	Possible cause	Corrective Action
No transmission while pressing the PTT button	Weak batteries	Charge or replace batteries
	Incorrect battery polarity	Install the batteries in the directions indicated by the battery tray.
Weak or no signal received	Weak batteries	Charge or replace batteries
	Channel and privacy code not set the same as target transceiver	Adjust the transceiver's settings to match those settings of the target transceiver
	Volume level too low	Increase volume level
	PTT button inadvertently depressed	Release PTT button
	Excessive radio interference on a particular channel	Change to a different channel
	Obstruction of radio signal	Avoid operating in or near large buildings or vehicles
Transceiver beeps, but will not turn on when Power button is pressed	Batteries extremely discharged	Charge or replace batteries
Reception of unwanted signals	CTCSS privacy mode not on	Turn on the CTCSS privacy mode and set code number to match the setting of the target transceiver.
	Interference from electronic devices such as computers or TVs	Turn the devices off or move farther away from them.

## 90 DAY LIMITED WARRANTY

Applies to Audiovox Family Radio Service Products.

AUDIOVOX CORPORATION (the Company) warrants to the original retail purchaser of this product that should this product or any part thereof, under normal use and conditions, be proven defective in material or workmanship within 90 days from the date of original purchase, such defect(s) will be repaired or replaced with new or reconditioned product (at the Company's option) without charge for parts and repair labor.

To obtain repair or replacement within the terms of this Warranty, the product is to be delivered with proof of warranty coverage (e.g. dated bill of sale), specification of defect(s), transportation prepaid, to the warranty center at the address shown below.

The Company disclaims liability for communications range of this product.

This Warranty does not apply to any product or part thereof which, in the opinion of the Company, has suffered or been damaged through alteration, improper installation, mishandling, misuse, neglect, accident, or by removal or defacement of the factory serial number/bar code label(s). THE EXTENT OF THE COMPANY'S LIABILITY UNDER THIS WARRANTY IS LIMITED TO THE REPAIR OR REPLACEMENT PROVIDED ABOVE AND, IN NO EVENT, SHALL THE COMPANY'S LIABILITY EXCEED THE PURCHASE PRICE PAID BY PURCHASER FOR THE PRODUCT.

This Warranty is in lieu of all other express warranties or liabilities. ANY IMPLIED WARRANTIES, INCLUDING ANY IMPLIED WARRANTY OF MERCHANTABILITY, SHALL BE LIMITED TO THE DURATION OF THIS WRITTEN WARRANTY. ANY ACTION FOR BREACH OF ANY WARRANTY HEREUNDER INCLUDING ANY IMPLIED WARRANTY OF MERCHANTABILITY MUST BE BROUGHT WITHIN A PERIOD OF 30 MONTHS FROM DATE OF ORIGINAL PURCHASE. IN NO CASE SHALL THE COMPANY BE LIABLE FOR ANY CONSEQUENTIAL OR INCIDENTAL DAMAGES FOR BREACH OF THIS OR ANY OTHER WARRANTY, EXPRESS OR IMPLIED, WHATSOEVER. No person or representative is authorized to assume for the Company any liability other than expressed herein in connection with the sale of this product.

Some states do not allow limitations on how long an implied warranty lasts or the exclusion or limitation of incidental or consequential damage so the above limitations or exclusions may not apply to you. This Warranty gives you specific legal rights and you may also have other rights which vary from state to state.

AUDIOVOX CORPORATION, 150 MARCUS BLVD., HAUPPAUGE, NEW YORK 11788  
1-800-290-6650 128-5385A



For Customer Service  
Visit Our Website At  
**[www.audiovox.com](http://www.audiovox.com)**  
Product Information, Photos,  
FAQ's, Owner's Manuals

© 2001 Audiovox Electronics Corp., Hauppauge, NY 11788

Printed in Korea

128-6113

## Free Manuals Download Website

<http://myh66.com>

<http://usermanuals.us>

<http://www.somanuals.com>

<http://www.4manuals.cc>

<http://www.manual-lib.com>

<http://www.404manual.com>

<http://www.luxmanual.com>

<http://aubethermostatmanual.com>

Golf course search by state

<http://golfingnear.com>

Email search by domain

<http://emailbydomain.com>

Auto manuals search

<http://auto.somanuals.com>

TV manuals search

<http://tv.somanuals.com>