

General Mobile

Radio Service (GMRS)

**Model
GMRS200W**



Owner's Manual

1-800-290-6650

Released: 4-25-03

128-6781
1 of 16

CAUTIONS

WHEN RECHARGING LITHIUM ION (Li-ion) BATTERY WITH THE AUDIOVOX CHARGER, USE ONLY THE AUDIOVOX SUPPLIED RECHARGEABLE BATTERY. USE OF THE AUDIOVOX CHARGER WITH OTHER BRANDS OF BATTERIES IS NOT RECOMMENDED, AS BATTERY CHARGING TIMES WILL VARY WITH DIFFERENT BRANDS. REFER TO THE MANUFACTURER'S INSTRUCTIONS FOR CHARGING OTHER BRANDS OF BATTERIES. AVOID PLACING THE GMRS200W RADIO TRANSCEIVER FOR PROLONGED PERIODS OF TIME IN DIRECT SUNLIGHT OR TEMPERATURES BELOW -4° F (-20° C) OR ABOVE 140° F (60° C).

KEEP THE ANTENNA AT 1 INCH (2.5 cm) AWAY FROM YOUR HEAD AND BODY. DO NOT USE YOUR GMRS200W RADIO TRANSCEIVER WITH A DAMAGED ANTENNA.

GMRS LICENSE:

USE OF THIS RADIO WITHIN THE UNITED STATES REQUIRES AN FCC GMRS LICENSE. AN INDIVIDUAL 18 YEARS OF AGE OR OLDER, WHO IS NOT A REPRESENTATIVE OF A FOREIGN GOVERNMENT, IS ELIGIBLE TO APPLY FOR A GMRS SYSTEM LICENSE. YOU WILL NEED TWO FORMS FROM THE FCC; FCC FORM 159 AND FCC FORM 605 MAIN FORM AND SCHEDULE F. YOU CAN FIND THE FORMS ONLINE AT: [HTTP://WWW.FCC.GOV/FORMPAGE.HTML](http://www.fcc.gov/formpage.html), OR CALL 1-800-418-3676.

Model GMRS200W (FCC License Required)

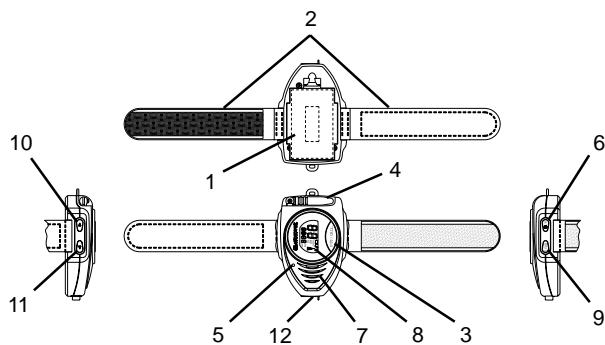

- | | |
|-------------------------------------------------------------|-----------------------------------------------------|
| 1. Battery Cover | 7. Built-In Speaker |
| 2. Wrist Band Set | 8. Liquid Crystal Display (LCD) |
| 3. Push-to-Talk (PTT)/CALL and Function Confirmation Button | 9. SCAN (and VOX) Button |
| 4. Antenna | 10. Up Channel/Volume Button |
| 5. Built-In Microphone | 11. Down Channel/Volume Button |
| 6. Power (PWR) On/Off and Function (F) Button | 12. External Speaker (SP)/Microphone (MIC)/CHG Jack |

3

128-6781
3 of 16

Model GMRS200W Display

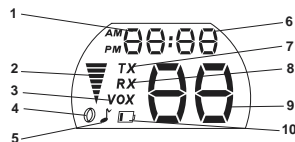

- 1. Clock Indicator (Hour):** These two segments indicate the hour.
- 2. Volume Indicator:** Indicates the volume level.
- 3. Voice Activated Transmission (VOX) Indicator:** This function allows hands free conversation. The icon appears when the VOX mode is activated.
- 4. Scan Indicator:** This function allows the user to scan a channel every 0.5 second to search for a valid signal.
- 5. Roger Beep Tone On/Off Indicator:** This icon appears when Roger Beep tone is on, and disappears when tone is not in use.
- 6. Clock indicator (minute):** These two segments indicate the minutes.
- 7. Transmit Indicator:** The icon indicates when radio is in transmit mode.
- 8. Receiving Indicator:** The icon indicates when radio is in receiving mode.
- 9. Large Segment Display:** Indicates the channel number in use.
- 10. Battery Level Indicator:** Icon indicates when the battery level is low.

Equipment and Accessories Supplied

1. Radio (1) GMRS200W
2. Owner's Manual (1) 128-6781
3. Lithium-ion Battery GMRS2WBAT
4. Wrist Strap Set GMRS2WWS
5. Wall Charging Adapter GMRS2WCH

4

128-6781
4 of 16

Powering the Transceiver

Your GMRS200W radio transceiver operates on a Lithium ion (Li-ion) battery.

Installing the Batteries:

To install the battery, proceed as follows:

1. Press the release clip lever toward the cover and lift the battery cover up and off at the same time.
2. Insert the Li-ion battery with the contacts facing down and touching the unit contacts.
3. Insert the end tab of the battery cover in the bottom slot and press the top of the cover into position until it clicks into place.

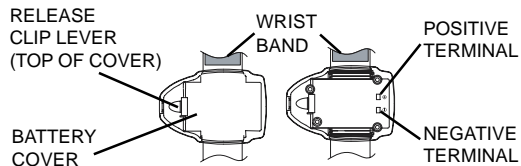

Charging the Transceiver Battery

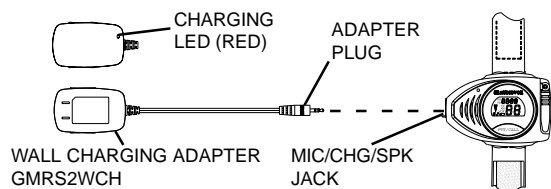

NOTE: The battery will fully charge in approximately 10-12 hours.

Installing and Removing Wrist/Arm Straps

Removing Wrist/Arm Straps

Remove the wrist/arm straps as follows:

1. Remove the battery as outlined on the preceding page.
2. Noting the arrow direction, push each strap from outside to inside, disengaging the strap pin from the side slot.
3. Continue to pull the strap through the slot and remove it from the radio. Save the strap pins for replacement use.

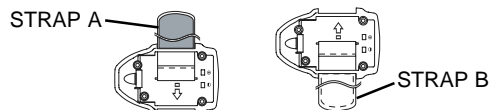

Installing Wrist/Arm Straps

Install the wrist/arm straps as follows:

1. With the battery removed, orient strap A with the velcro side facing up away from the battery compartment, orient strap B with the velcro side facing down from the compartment.
2. Noting the arrow direction, insert the end of the strap through the square slot, and pull until the strap pin engages the stop below the strap slot.

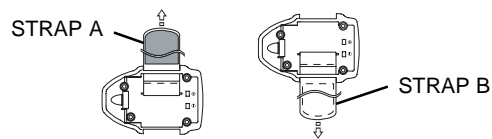

GMRS200W Operational Modes

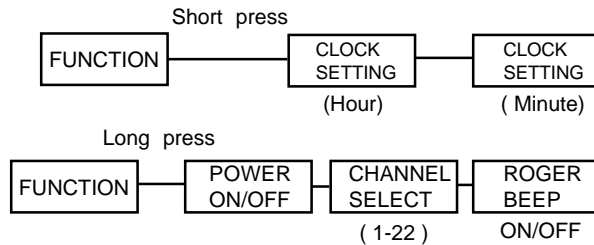

NOTE: Refer to the appropriate section of this manual for detailed operating instructions for each mode.

Controls

Power On/Off (6) Button

Press and hold the Power on/off button (⏻) for at least 2 seconds. You will hear a confirming melody to indicate the unit is on. To turn the unit off, press and hold the button for at least 2 seconds.

Adjusting the Volume

With the unit powered on, press the Up Channel/Volume button (▶) to increase volume and the Down Channel/Volume button (◀) to decrease volume. The display will indicate the current volume level by the volume (🔊) icon (6 steps).

Push-To-Talk (PTT) Button (3)

Pressing and holding this button will allow you to speak to any transceiver that is set to the same channel as yours. Hold the transceiver approximately 1 to 2 inches from your face as you speak into the built-in microphone (5). After you have finished speaking, release the PTT Button to allow reception of incoming signals. It is not possible to transmit and receive at the same time. Whenever the PTT Button is pressed the **TX** icon is displayed on the LCD. Releasing the button allows the unit to revert to standby mode. When receiving an incoming signal, the **RX** icon will appear on the display. The PTT Button can also be used as a two-way call ringer. Pressing the button twice quickly will call another party on the same channel. The Transmit icon (**TX**) will appear on the display for 3 seconds and then disappear.

Up Channel/Volume Button (10)

In the standby mode, pressing this button increments the listening volume. When in function edit mode, this button is used to adjust the unit's settings.

Down Channel/Volume Button (11)

In the standby mode, pressing this button decrements the listening volume. When in function edit mode, this button is used to adjust the unit's settings.

Power/Function (⏻ /F) Button (6)

This button is used to turn on the transceiver; it also provides access to various feature settings in the GMRS and FRS modes.

Scan Button (9)

Press this Button momentarily to enable or disable the scan mode.

8

128-6781
8 of 16

Operating Modes and Features

GRMS/FRS Operation

- From GMRS/FRS standby mode, press and hold the power button for 2 seconds to turn on power.
- Press the Function (F) button so the Channel number flashes.
- Select the desired channel with the Up (10) and Down (11) Buttons. When receiving a call, the RX icon on the LCD appears to indicate incoming received signal.
- Press and hold the PTT button (3) to transmit, then speak into the microphone clearly and slowly.
- Communication can only be accomplished when the channel frequency of at least two parties are the same.
- Release PTT Button (3) to receive.

Channel Selection

In order to communicate with other GMRS/FRS units, both transmitting and receiving party must be on the same frequency. The GMRS200W has 22 channels (frequencies) (1-22) indicated by the large digits on the LCD display panel. Channels 1 through 7 are the shared GMRS/FRS channels. Channels 8-14 are FRS only channels, while channels 15-22 are GMRS only channels. Communication with Audiovox GMRS/FRS and compatible units is possible on these 22 channels.

To change the channel:

- From GMRS/FRS standby mode, press the Function (F) button (6) until the channel number flashes.
- Press the Up Button (10) briefly to move to the next higher main channel number.
- Press the Down Button (11) briefly to move to the next lower main channel number.

VOX Selection Mode

This option enables you to have hands-free conversation. Your voice or nearby sound is detected and the radio transmits without the need to press the PTT button.

To set radio for VOX operation:

- From GMRS/FRS standby mode, press and hold the SCAN button until the **VOX** icon appears on the display.
- The VOX mode can be turned off by pressing the SCAN button for 3 seconds; the **VOX** icon disappears.

Channel Scan Operation

This feature allows you to monitor all channels automatically for valid signals. While scanning, you can transmit and receive. When a signal is received, the scan is interrupted and will return to scan mode 5 seconds after reception is terminated.

NOTE: While the scan function is active, the MODE button will be inoperative. In addition, the scan mode will shorten overall battery life because the battery save function is overridden.

To enable the channel scan mode:

- From GMRS/FRS standby mode, momentarily press the SCAN Button; (Ⓞ) will appear on the LCD display.
- The radio will display each channel (1-22) in order as the scan mode operates to find an active main channel.
- When unit doesn't find any signals and you want to transmit, press the PTT button to return to home channel operation. The transceiver will automatically resume scanning approximately 10 seconds after the communication is completed.
- If there is no activity and you want to leave the scan mode, press the power button momentarily and the unit will return to normal operation; (Ⓞ) icon will disappear from the LCD display.

10

128-6781
10 of 16



Key Tone

This feature allows the transceiver to sound a confirmation tone whenever the following keys are pressed: Up/Down buttons, Power/Function button, SCAN button. The key tone is always on.

Roger Beep Tone

The Roger Beep is a tone which is automatically transmitted whenever the PTT button is released. This tone alerts the receiving party that the transmission has been terminated intentionally.

To enable and disable the Roger Beep tone:

- From GMRS/FRS standby mode, press the Function Button until the Roger Beep icon () appears flashing on the display.
- Press the Up or Down Button to select the tone **on** or **of** as desired.
- When enabled, the tone icon () appears steady on the display.
- Press the PTT or Power On/Off button to confirm selection.

Battery Alert

When the battery icon () blinks steadily on the LCD panel, recharge the unit. The unit will revert to the clock mode automatically.

NOTES FOR GOOD COMMUNICATION

1. The GMRS200W 22 channels are shared on a 'take turns' basis. This means other groups may be talking on any of the channels. A common code of ethics/courtesy is to switch to another vacant channel and not to attempt to talk over someone who is already using the channel you first selected.

2. The GMRS200W has been designed to maximize performance and improve transmission range in the field. To avoid interference, it is recommended that you do not use the units closer than 5 feet apart.
3. For best transmission results, always keep your mouth about 2-3 inches from the microphone (5) and speak slowly in a normal voice.
4. To increase battery life, avoid the Scan feature. SCAN mode will reduce operating time considerably.

Warning

- Do not operate the transceiver unless you are licensed to do so.
- Remove the batteries from the transceiver if it is not expected to be used for long periods. This will eliminate the possibility of chemicals leaking from the batteries and corroding the transceiver.
- Avoid exposing the transceiver to water or extremes of temperature.
- Do not use this device in or near a mining facility, which uses remotely triggered explosives or in areas labeled "Blasting Area". Accidental detonation may result.
- Do not attempt to modify or in any way increase the output of this transceiver. Its output is designed to meet the legal limits set by the FCC.
- Do not use this device or change its batteries in potentially explosive atmospheres as sparks in such areas could result in an explosion.
- Turn your transceiver off wherever posted notices restrict the use of radios or cellular telephones. Facilities such as hospitals may use equipment that is sensitive to RF energy.

Turn your transceiver off on board aircraft when requested to do so. Do not place your radio in front of a vehicle's air-bag. If the air-bag deploys, it could propel the transceiver like a projectile causing bodily injury.

Troubleshooting

Problem	Probable Cause	Remedy
No transmission while pressing the PTT button	Weak battery	Charge or replace battery
	Incorrect battery polarity	Correctly install battery as outlined in battery replacement procedure
Weak, intermittent or no received signal	Weak battery	Charge or replace battery
	Channel not set to the same as target transceiver	Adjust transceiver's settings to match those of the target transceiver
	Volume level too low PTT button inadvertently pressed	Increase volume level Release PTT button
Unit beeps, but will not function when turned on	Battery extremely discharged	Charge or replace battery
	Excessive radio interference on a particular channel Obstruction of radio signal	Change to a different channel Avoid operating in or near large buildings or vehicles
Reception of unwanted signals	Interference from electronic devices such as computers or TVs	Turn the devices off or move further away from them

Technical Specifications

General

Frequency Range:	
Channels 1 through 7 are shared with FRS radios.	Refer to frequency chart on next page.
Channels 8 through 14 are FRS only.	Refer to frequency chart on next page.
Channels 15 through 22 are GMRS only.	Refer to frequency chart on next page.
Channel Spacing	12.5kHz
Dimensions (W x H x D) (Without Antenna)	2.83 W x 2.00 H x 0.83 D (72.0 mm x 50.5 mm x 21.0 mm)

Power Supply

Power Source	Lithium-ion (Li-ion) Battery (1), 3.7 VDC
Operating Time	20 hours (Transmit: Receive: Standby = 5: 5: 90 ratio)

Receiver

Usable Sensitivity	>-119 dBm
Maximum Audio Output Power	> 0.1 Watt maximum (16 Ohm)
Modulation Distortion	< 5% (1 kHz 70%)

Transmitter

RF Output Power	0.3 Watts maximum
Maximum Deviation	+/- 2.5 kHz
Modulation Distortion	< 5% (1 kHz 70%)

This transceiver complies with FCC regulations for use in the United States of America. Use in other countries may be prohibited or restricted by local regulation. Please check with the local regulating agency before using this device outside the United States of America.

Main Channel Frequencies

No.	CHANNEL/ TYPE	FREQ (MHz)	No.	CHANNEL/ TYPE	FREQ (MHz)
1	GMRS/FRS	462.5625	12	FRS	467.6625
2	GMRS/FRS	462.5875	13	FRS	467.6875
3	GMRS/FRS	462.6125	14	FRS	467.7125
4	GMRS/FRS	462.6375	15	GMRS	462.5500
5	GMRS/FRS	462.6625	16	GMRS	462.5750
6	GMRS/FRS	462.6875	17	GMRS	462.6000
7	GMRS/FRS	462.7125	18	GMRS	462.6250
8	FRS	467.5625	19	GMRS	462.6500
9	FRS	467.5875	20	GMRS	462.6750
10	FRS	467.6125	21	GMRS	462.7000
11	FRS	467.6375	22	GMRS	462.7250

NOTE: Channels 1 through 7 are shared with FRS radios.
Channels 8 through 14 are FRS only.
Channels 15 through 22 are GMRS only.

90 DAY LIMITED WARRANTY

Applies to Audiovox Family Radio and General Mobile Service Products. AUDIOVOX CORPORATION (the Company) warrants to the original retail purchaser of this product that should this product or any part thereof, under normal use and conditions, be proven defective in material or workmanship within 90 days from the date of original purchase, such defect(s) will be repaired or replaced with new or reconditioned product (at the Company's option) without charge for parts and repair labor.

To obtain repair or replacement within the terms of this Warranty, the product is to be delivered with proof of warranty coverage (e.g. dated bill of sale), specification of defect(s), transportation prepaid, to the warranty center at the address shown below. The Company disclaims liability for communications range of this product.

This Warranty does not apply to any product or part thereof which, in the opinion of the Company, has suffered or been damaged through alteration, improper installation, mishandling, misuse, neglect, accident, or by removal or defacement of the factory serial number/bar code label(s). THE EXTENT OF THE COMPANY'S LIABILITY UNDER THIS WARRANTY IS LIMITED TO THE REPAIR OR REPLACEMENT PROVIDED ABOVE AND, IN NO EVENT, SHALL THE COMPANY'S LIABILITY EXCEED THE PURCHASE PRICE PAID BY PURCHASER FOR THE PRODUCT.

This Warranty is in lieu of all other express warranties or liabilities. ANY IMPLIED WARRANTIES, INCLUDING ANY IMPLIED WARRANTY OF MERCHANTABILITY, SHALL BE LIMITED TO THE DURATION OF THIS WRITTEN WARRANTY. ANY ACTION FOR BREACH OF ANY WARRANTY HEREUNDER INCLUDING ANY IMPLIED WARRANTY OF MERCHANTABILITY MUST BE BROUGHT WITHIN A PERIOD OF 30 MONTHS FROM DATE OF ORIGINAL PURCHASE. IN NO CASE SHALL THE COMPANY BE LIABLE FOR ANY CONSEQUENTIAL OR INCIDENTAL DAMAGES FOR BREACH OF THIS OR ANY OTHER WARRANTY, EXPRESS OR IMPLIED, WHATSOEVER. No person or representative is authorized to assume for the Company any liability other than expressed herein in connection with the sale of this product.

Some states do not allow limitations on how long an implied warranty lasts or the exclusion or limitation of incidental or consequential damage so the above limitations or exclusions may not apply to you. This Warranty gives you specific legal rights and you may also have other rights which vary from state to state.

©AUDIOVOX ELECTRONICS CORPORATION, 150 MARCUS BLVD., HAUPPAUGE,
NEW YORK 11788 1-800-290-6650

128-5385A

Free Manuals Download Website

<http://myh66.com>

<http://usermanuals.us>

<http://www.somanuals.com>

<http://www.4manuals.cc>

<http://www.manual-lib.com>

<http://www.404manual.com>

<http://www.luxmanual.com>

<http://aubethermostatmanual.com>

Golf course search by state

<http://golfingnear.com>

Email search by domain

<http://emailbydomain.com>

Auto manuals search

<http://auto.somanuals.com>

TV manuals search

<http://tv.somanuals.com>