

AUDIOVOX®

MODEL AVP-7380

**Video Cassette Player
and
Built-in TV Tuner
with Voice Status Annunciator**

Owner's Instruction Manual

**128-6163
1 of 24**

THIS PAGE INTENTIONALLY LEFT BLANK

Contents

Thank You	3
Safety Precautions	3
Cautions and Warnings	5
Important Safeguards	6
Service	7
Features	9
Front Panel Operation	10
Rear Panel Connections	11
Remote Control Operation	13
Getting Started	15
VCP to Vehicle Connection	15
12 Volt Power Notes	15
Making VCP Connections	16
Basic Operation	17
Specifications	21
Feature List	22
Bill of Material	22

A. Thank You

Thank you for choosing the AVP-7380 Video Cassette Player with built-in TV Tuner and Voice Status Annunciator. This unit is the result of advanced technology in audio and video electronics. Please read this manual completely before operation and retain it for future reference.

B. Safety Instructions

1. Read Instructions -All the safety and operating instructions should be read before the Video Cassette Player is operated.
2. Retain Instructions - The safety and operating instructions should be retained for future reference.
3. Heed Cautions and Warnings -All cautions and warnings regarding the Video Cassette Player should be adhered to.
4. Follow Instructions -All operating instructions should be followed.

5. **Cleaning** - Unplug or turn off vehicle power to the Video Cassette Player before cleaning. Do not use liquid cleaners or aerosol cleaners. Use only a damp cloth for cleaning.
6. **Attachments** - Do not use attachments not recommended by the Video Cassette Player manufacturer as they may cause hazards.
7. **Water and Moisture** - Do not use this video product near water; for example, near a bath tub, kitchen sink, near a swimming pool or other wet locations.
8. **Accessories** - Do not place the Video Cassette Player on an unstable cart, stand, tripod, bracket, or table. The Video Cassette Player may fall, causing serious injury to a child or adult, and serious damage to the Video Cassette Player. Use only with a cart, stand, tripod, bracket, or table recommended by the manufacturer or sold with the Video Cassette Player. When used in vehicles, the Video Cassette Player must be securely fastened.
9. **Ventilation** - Slots and openings in the cabinet are provided for ventilation to insure reliable operation of the Video Cassette Player and to protect it from overheating. These openings must not be blocked or covered. The openings should never be blocked by placing the Video Cassette Player on a bed, sofa, rug or other similar surface. The Video Cassette Player should never be placed near or over a radiator or heat register. This video product should not be placed in a built-in installation such as a book case or rack unless proper ventilation is provided.
10. **Power Sources** - The Video Cassette Player should be operated only from the type of power source indicated on the marking label. If you are not sure of the type of power supplied to your home, consult your appliance dealer or local power company. For video products intended to operate from battery power of other sources, refer to the operating instructions.

C. Cautions and Warnings

1. *Cleaning Video Head*

Use only good quality VHS tapes and discard worn out tapes to prevent video head clogging. If the heads get dirty over a period of time during normal operation of the VCP, the picture will be snowy and the auto-tracking will not adjust the snow out of the picture. We recommend using cleaning cartridges sparingly to restore normal picture.

2. *Placement*

To prevent fire or electric shock, do not expose this appliance to rain, moisture, or direct sunlight, keep the unit away from radiators or other sources of heat. Do not operate or store the unit close to strong magnetic fields. Do not place the set on an unstable cart, stand, tripod, bracket or table to prevent it from falling.

3. *Ventilation*

Never cover or block the slots and openings in the cabinet with a cloth or other material to ensure proper ventilation.

4. *Object and Liquid Entry*

Do not push objects of any kind into the set through openings; do not spill liquid of any kind on or in the set. It may result in a fire or electric shock. Do not place anything heavy on the unit.

5. *Disassemble*

To reduce the risk of electric shock, do not remove the cover (or back). No user-serviceable parts inside. Refer servicing to qualified service personnel.

6. **Cleaning Unit**

Made sure unit is unplugged from power source. Do not use liquid cleaners or aerosol cleaners. Use a cloth lightly dampened with water for cleaning the exterior of the set.

7. **Power**

This unit should be operated only from the type of power source indicated on the marking label. Use only the supplied power cable matching this set to avoid electric hazards. When the unit is left unattended and unused for long periods of time, unplug it from the power source. Always disconnect the power source first and then the jack from the unit.

8. **Cassette**

Do not force a cassette into the compartment when the power cord is Unplugged. An inverted cassette cannot be inserted. After playing a video cassette, remove it from the player. Do not move the player with a cassette in the compartment. Store videocassettes in the sleeves or cases and position them vertically.

D. Important Safeguards

At room temperature, if you pour a cold liquid into a glass, water vapor in the air will condense on the surface of the glass, This is moisture condensation. The moisture condensation may occur inside of VCPs; if used in this condition, it will cause damage to the head and the tape.



When does the moisture condensation occur inside of the VCP?

When moving the VCP from a cold place to heated place.

Or the temperature of surroundings goes up due to vehicle heating switched on.

Or moving the VCP suddenly from air conditioned room to a place of high temperature or humidity in summer may cause the dew indicator to appear on video monitor display.

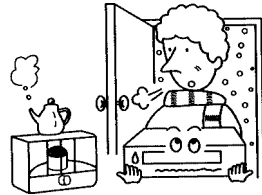

When the moisture condensation occurs inside of the VCP, NEVER insert the cassette into the cassette compartment.

Remove the cassette, if loaded, by pressing the STOP/EJECT key. Only operate the VCP after the moisture condensation has completely dried out. Normally, it takes about 2 hours.

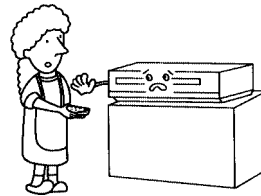

SERVICE--- :

-if the set has been subjected to excessive shock by being dropped, or the cabinet has been damaged.



-if the set does not operate normally when following the operating instructions, adjust only those controls that are specified in the operating instructions. Improper adjustment of other controls may result in damage and will often require extensive work by a qualified technician to restore the set to normal operation.



-when the set exhibits a distinct change in performance, this indicates a need for service.

Servicing- Do not attempt to service the set yourself as opening or removing covers may expose you to dangerous voltage or other hazards. Refer all servicing to qualified service personnel.

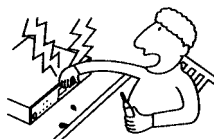

Replacement of Parts - When replacement of parts is required, be sure the service technician has used replacement parts specified by the manufacturer that have the same characteristics as the original parts. Unauthorized substitutions may result in fire, electric shock, or other hazards.

Safety Check - Upon completion of any service or repairs to the set, ask the service technician to perform routine safety checks (as specified by the manufacturer) to determine that the set is in safe operating condition.



E. Features

CONGRATULATIONS on your purchase of the Audiovox Model AVP-7380 Video Cassette Player. This unit is designed to satisfy all your VHS tape playback needs and with proper use and care, will offer many years of viewing enjoyment. The features of the Model AVP-7380 Video Cassette Player include:

- **DIGITAL AUTO TRACKING**
This VCP plays clear pictures without special operations. In the Auto Tracking Mode.
- **SELF PICTURE ADJUSTMENT**
Since HEAD DRUM rotation continuously compensates for voltage change or tape condition, the picture is always stable.
- **AUTO START FUNCTION**
This VCP will automatically power on and go into PLAY mode when a cassette is inserted.
- **2-HEAD PLAYBACK**
- **AUTO REPEAT PLAYBACK**
In the AUTO REPEAT mode, the VCP will , at the end of the tape, rewind and enter the playback mode.
- **INFRARED (IR) INPUT FOR REMOTE CONTROL**
- **DC OPERATION WITH SPECIALIZED TAPE MECHANISM**
- **DIAMOND-LIKE COATED (DLC) VIDEO HEAD**
A special coating on the tape drum which prevents oxide and moisture build-up.
- **ILLUMINATED FUNCTION BUTTONS**
- **DEW SENSOR**
Prevents a tape from being played when moisture is detected in the unit.

Features (Continued)

- **3 MONITOR OUTPUT PORTS**
- **FRONT AND REAR A/V INPUTS**
- **BUILT-IN 69 CHANNEL TV TUNER**
- **BUILT-IN VCP STATUS ANNUNCIATOR**
- **FULL FUNCTION REMOTE**

F. Front Panel Operation

POWER Button (1)

When pressed this button alternately turns the VCP on and off. When power is turned on, the annunciator says "Power On"; the power indicator lights red and the other function buttons light green. When power is turned off, the annunciator says "Power Off".

Remote Control Sensor (2)

Infrared sensor responds to remote control inputs for VCP operation.

AUTO REPEAT Button (3)

When this button is pressed the VCP is in the Auto Repeat Playback mode, and the button indicator lights red. At the end of the tape, the rewind function takes over; the tape will automatically rewind to the beginning and playback will commence again.

1. Power On/Off Button
2. Remote Control Sensor
3. Auto Repeat Button
4. Stop/Eject Button
5. Fast Rewind Button
6. Play Button
7. Fast Forward Button
8. Video Input Jack
9. Audio Left Input Jack
10. Audio Right Input Jack

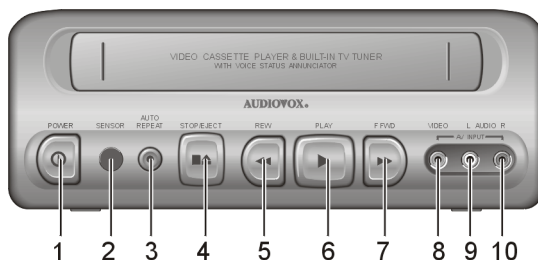

STOP/EJECT Button (4)

When pressed once, the annunciator says "Stop" and the tape is stopped. When pressed again the tape is ejected.

REW/Review Button (5)

If this button is pressed in the PLAYBACK mode, the VCP enters the reverse picture search mode. If pressed in STOP mode, the annunciator says "Rewind" and the tape will rewind at high speed.

PLAY Button (6)

Press this key to play back a recorded tape. In the playback mode, the annunciator says "Play" and the playback indicator lights.

F FWD/Cue Button (7)

When this button is pressed during playback, the VCP enters the forward picture search mode. When pressed during stop, the annunciator says "Fast Forward" and the tape will fast forward at high speed.

VIDEO IN Jack (8)

Connect this jack to the video out jack/terminal of your Game machine, Camcorder, or Portable DVD Player.

AUDIO IN L Jack (9)

Connect this jack to the left audio out jack/terminal of your Game machine, Camcorder, or Portable DVD Player.

AUDIO IN R Jack (10)

Connect this jack to the right audio out jack/terminal of your Game machine, Camcorder, or Portable DVD Player.

G. Rear Panel Connections

DC 12V INPUT Jack (1)

When using a DC power source, connect this jack to 12 Vdc TV

ANT. Connector (2)

Connect the TV antenna to this connector.

MONITOR PORT 1 Connector (3)

Connects to external Monitor for remote viewing purposes.

MONITOR PORT 2 Connector (4)

Connects to external monitor for remote viewing purposes.

MONITOR PORT 3 Connector (5)

Connects to external monitor for remote viewing purposes.

VIDEO INPUT Jack (6)

Connect this jack to the video out jack/terminal of your Game machine, Camcorder, or Portable DVD Player.

AUDIO INPUT L Jack (7)

Connect this jack to the left audio out jack/terminal of your Game machine, Camcorder, or Portable DVD Player.

AUDIO INPUT R Jack (8)

Connect this jack to the right audio out jack/terminal of your Game machine, Camcorder, or Portable DVD Player.

SPEAKER OUTPUT Jack (9)

Connect the external speaker to this jack for voice annunciator.

REMIR Jack (10)

This connector provides the interface with the IR input of the Remote Control.

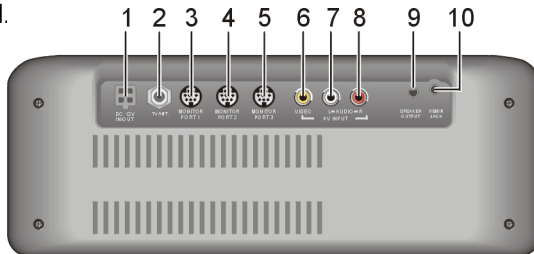

EXTERNAL SPEAKER

1. Voice High/Low/Off Switch
2. Plug of Speaker

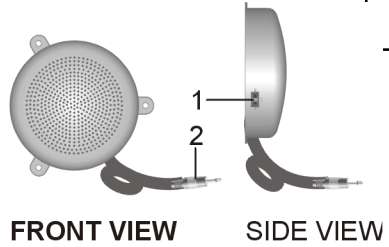

H. Remote Control Operation

TV/VIDEO Button (1)

Pressing this button selects from TV (external antenna connected to the Antenna jack), VIDEO 1 (internal VCP) or VIDEO 2 (front or rear A/V inputs).

NOTE: Plugging into the front panel A/V inputs overrides all other inputs.

Keypad Buttons (2)

These buttons provide direct access to TV channel: 1 number chosen will be displayed on the screen for

1. TV/VIDEO Key
2. Number Keys
3. Skip Search Key
4. Erase Write Key
5. Channel Up Key
6. Channel Down Key
7. Auto Memory Key
8. Main Power Key
9. Rewind Key
10. FastForward Key
11. Play Key
12. Stop Key

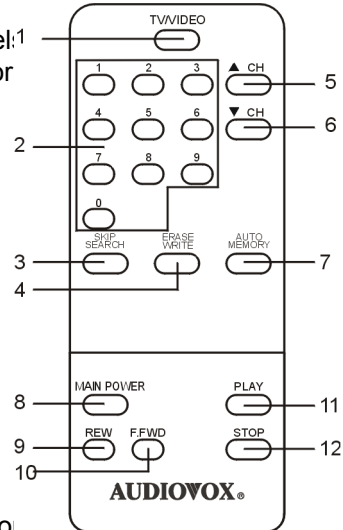

SKIP/SEARCH Button (3)

Pressing this button toggles between skip mode on and skip mode off. With skip mode on, only the channels programmed in memory are accessed with the channel up/down buttons; with skip mode off, all channels can be accessed with the channel up/down buttons.

ERASE/WRITE Button (4)

This button is used to add or erase channels from memory. To erase a channel, use the keypad buttons to select the desired channel and press the ERASE/WRITE button; ERASED will appear on the screen. To add a channel to memory, use the keypad buttons to select the desired channel and press the ERASE/WRITE button; ADD will appear on the screen.

Channel Up (Δ CH) Button (5)

Pressing this button with skip mode off will access all channels in the up direction; with skip mode on, only those channels stored in memory can be accessed.

Channel Down (∇ CH) Button (6)

Pressing this button with skip mode off will access all channels in the down direction; with skip mode on, only those channels stored in memory can be accessed.

AUTO MEMORY Button (7)

When this button is pressed, the tuner will scan all strong broadcast signals and store them in memory.

MAIN POWER Button (8)

When pressed, this button alternately turns the AVP-7380 on and off; the annunciator says "Power On" or "Power Off".

REW Button (9)

If this button is pressed in the PLAYBACK mode, the VCP enters the reverse picture search mode. If pressed in STOP mode, the annunciator says "Rewind" and the tape will rewind at high speed.

F FWD Button (10)

When this button is pressed during playback, the VCP enters the forward picture search mode. When pressed in stop mode, the annunciator says "Fast Forward" and the tape will fast forward at high speed.

PLAY Button (11)

Press this key to play back a recorded tape. In the playback mode, the annunciator says "Play" and the playback indicator lights.

STOP Button (12)

When pressed once, the annunciator says "Stop" and the tape is stopped. When pressed again the tape is ejected.

I. Getting Started

VCP TO VEHICLE CONNECTION

- Connect the unit to a 12 Vdc source only.
- The unit should be connected to the vehicle only after verifying the polarity of the Power Source (12 Vdc with negative ground).

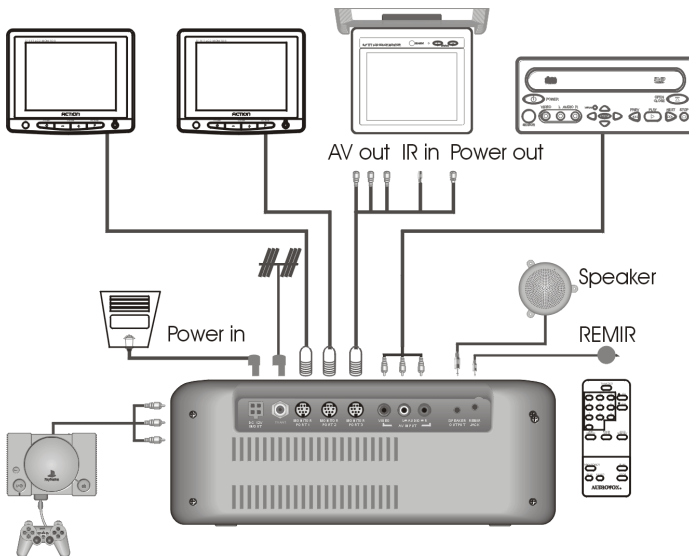

12 VOLT POWER NOTES

- This VCP operates on 12 Vdc only. If you apply more than 18 Vdc, the VCP will automatically turnoff.

- If the polarity is reversed, the unit will not operate.
- Use of this VCP is not recommended in excessive heat. If the inside temperature of the vehicle is over 100 F, do not use the VCP. Allow the VCP to cool before use.

MAKING VCP CONNECTIONS

1. Powering the Unit:
Insert one end of the power connector into the 4 PIN DC 12V jack on the back of the unit; connect the other end to an ACC (switched) power source of the vehicle.
2. Connecting the Antenna:
Connect the coaxial cable of the external antenna to the TV ANT jack on the back of the unit.
3. Driving the External Monitors:
Connect any of the 3 MONITOR PORTS in the rear of the unit to the external monitor to output DC 12V power, audio, video and IR input signals all in one DIN jack to the external monitor. Depending on the connector type of the monitor, you can use the supplied DIN convertor cable, or the DIN cable that we may supply as the optional accessory.
4. A/V Inputs:
 - a. Plug the video output from an auxiliary source such as Game and Camcorder into the yellow video jack, and the audio L and audio R into the appropriate jacks in the front of the unit.
NOTE: Plugging into the front panel A/V inputs overrides all other inputs. (TV, VCP, Rear Aux input)
 - b. Plug the video output from an auxiliary source such as DVD Player, VCP, VCR and so on into yellow video jack, and the audio L and audio R into the appropriate jacks in the rear of the unit.
5. External Speaker:
Input the plug of the separate Speaker into the SPEAKEROUTPUT JACK for transmitting the sound from

- the built-in voice annunciator to the Speaker. Use the LOW/MED/HI switch to adjust the volume.
6. Control the Unit Remotely:
Plug REMIR into this jack and extend the sensor of the REMIR to where the driver can control the unit conveniently with the Remote Control pointing to the sensor.
 7. Secure the VCP to the vehicle using the supplied mounting brackets to ensure safe operation.

J. Basic Operation

1. POWER
Plug in the unit, and the power lamp will turn on. Press the POWER key to switch on or off the power. The lamp will be brighter when the unit is on.
2. TV/VIDEO
Press the TV/VIDEO key on the remote control to select the tuner (TV) mode, the VCP mode (VIDEO 1) and the rear AV INPUT mode (VIDEO 2) in turn. When the power turns on, the unit goes to the mode with last memory.

NOTE: Plugging the front-mounted AV inputs overrides all other inputs.

3. CASSETTE LOADING/UNLOADING
 - a. Loading the Cassette:
 - 1) Gently push the cassette into the cassette compartment, making sure the cassette arrow is on top.

NOTE: The cassette cannot be inserted upside down.
 - 2) If VCP power is off when the cassette is inserted, power will turn on as long as the VCP is connected to the power source, and the cassette will begin to play.

b. Unloading the Cassette:

If the VCP is in the playback mode, press the STOP/EJECT button twice; the first press will stop tape play, and the second press will eject the tape.

NOTE: The cassette will be ejected even if VCP power is off, as long as the unit is connected to the power source.

4. AUTO MEMORY

Press the AUTO MEMORY key for searching and storing automatically the TV channels with on-screen display, the unit will start to play the first channel automatically.

5. SKIP SEARCH

- a. Press the SKIP SEARCH key until SKIP MODE ON is displayed on the screen. Then if using the channel up and down keys, the TV will stop only on the active TV channels.
- b. Press the SKIP SEARCH key until SKIP MODE OFF is displayed on the screen. Then all the TV channels will be shown using the channel up and down keys.

6. CHANNEL UP/DOWN

Press the CHANNEL UP and DOWN keys to get your desired TV channel.

7. DIRECT ACCESS

Press the number keys to make a direct TV channel selection. The channel number chosen will be displayed on the screen for about 4 seconds.

8. ERASE/WRITE

To erase a TV channel, press the ERASE/WRITE key until MANUAL MEMORY has “erase” displayed on the screen. To store a TV channel, press this key until MANUAL MEMORY has “add” displayed on the screen.

9. VCP AUTO START

After plugging the DC power cord, push the cassette into the cassette compartment gently, the VCP automatically powers on if it was off, and goes into the play mode. Select VIDEO 1.

10. STOP/EJECT

Press the STOP/EJECT key to stop tape; the voice annunciator will say “STOP”. Press this key once more to eject tape.

11. HIGH/LOW/OFF

Push the HI/LO/OFF switch to select high volume, low volume, or volume off for the Voice Status Annunciator Speaker. (Located on external speaker).

12. REWIND/SCAN

- a. Press the REWIND key once in the playback mode, and the VCP enters the reverse picture search mode and the tape will rewind rapidly with picture. The rewind indicator lamp will blink. Press this key once more, the tape will rewind/scan at a high speed with the lamp blinking more quickly.

- b. Press the REWIND key in the stop mode, the voice annunciator will say "REWIND", and the tape will rewind at a very high speed without any picture or sound. The rewind indicator lamp will blink very quickly.

13. PLAYBACK

Press the PLAYBACK key in the stop mode to playback a tape, and the voice annunciator will say "PLAY". You can also press this key to release special operations such as the search mode.

14. FAST FORWARD/SCAN

- a. Press the FAST FORWARD key once in the playback mode; the VCP enters the forward picture search mode and the tape advances rapidly with picture. The fast forward indicator lamp will blink. Press this key once more; the tape will forward/scan at a high speed with the lamp blinking more quickly.
- b. Press the FAST FORWARD key in the stop mode, the voice annunciator will say "FAST FORWARD", and the tape will advances at a very high speed without any picture or sound. The fast forward indicator lamp will blink very quickly.

15. AUTO REPEAT

When this button is pressed the VCP is in the Auto Repeat Playback mode, and the button indicator lights red. At the end of the tape, the rewind function takes over; the tape will automatically rewind to the beginning and playback will commence again.

K. Specifications

System	NTSC
Remote Control	Infrared
Antenna	External Antenna Jack
Channels	2-6 (VHF low), 7-13 (VHF high), 14-69 (UHF)
Audio track	1 track
Tape width	12.7mm
Tape speed SP	33.35mm/s
Playback time	180 minutes with T-180 set to
SP mode	
FF/REW time	Less than 7 minutes with T-120
Heads	2 helical scanning system
Video Output	1.0 Vp/p, 75ohm, unbalanced
Video signal-to noise ratio	Better than 40 dB
Audio output	1W
Audio signal-to-noise ratio SP	Better than 40 dB
Frequency response SP	100 Hz-7kHz
Power Supply	DC 12V
Power Consumption	30W
Operating Humidity	10~75%
Operating Temperature	41~104 degrees Fahrenheit (5~40) centigrade
Storage Temperature	4~140 degrees Fahrenheit (-20~60) centigrade
Dimensions (W x H x D)	10.9" x 3.8" x 9.8"
Weight	7 pounds 6 ounces

L. Bill of Material

- * 1 x VCP with built-in TV Tuner & Voice Status Annunciator
- * 1 x Speaker
- * 1 x Remote Control
- * 1 x REMIR
- * 1 x DIN Convertor Cable
- * 1 x DC Power Connector
- * 2 x Brackets with 4 x Screws
- * 1 x Owner's Manual



36 MONTH LIMITED WARRANTY

Applies to Audiovox Mobile Video Products

AUDIOVOX ELECTRONICS CORP. (the Company) warrants to the original retail purchaser of this product that should this product or any part thereof, under normal use and conditions, be proven defective in material or workmanship within 36 months from the date of original purchase, such defect(s) will be repaired or replaced with reconditioned product (at the Company's option) without charge for parts and repair labor.

To obtain repair or replacement within the terms of this Warranty, the product is to be delivered with proof of warranty coverage (e.g. dated bill of sale), specification of defect(s), transportation prepaid, to the Company at the address shown below.

This Warranty does not extend to the elimination of externally generated static or noise, to correction of antenna problems, to costs incurred for installation, removal or reinstallation of the product, or to damage to tapes, discs, speakers, accessories, or vehicle electrical systems.

This Warranty does not apply to any product or part thereof which, in the opinion of the Company, has suffered or been damaged through alteration, improper installation, mishandling, misuse, neglect, accident, or by removal or defacement of the factory serial number/bar code label(s). THE EXTENT OF THE COMPANY'S LIABILITY UNDER THIS WARRANTY IS LIMITED TO THE REPAIR OR REPLACEMENT PROVIDED ABOVE AND, IN NO EVENT, SHALL THE COMPANY'S LIABILITY EXCEED THE PURCHASE PRICE PAID BY PURCHASER FOR THE PRODUCT.

This Warranty is in lieu of all other express warranties or liabilities. ANY IMPLIED WARRANTIES, INCLUDING ANY IMPLIED WARRANTY OF MERCHANTABILITY, SHALL BE LIMITED TO THE DURATION OF THIS WRITTEN WARRANTY. ANY ACTION FOR BREACH OF ANY WARRANTY HEREUNDER INCLUDING ANY IMPLIED WARRANTY OF MERCHANTABILITY MUST BE BROUGHT WITHIN A PERIOD OF 48 MONTHS FROM DATE OF ORIGINAL PURCHASE. IN NO CASE SHALL THE COMPANY BE LIABLE FOR ANY CONSEQUENTIAL OR INCIDENTAL DAMAGES FOR BREACH OF THIS OR ANY OTHER WARRANTY, EXPRESS OR IMPLIED, WHATSOEVER. No person or representative is authorized to assume for the Company any liability other than expressed herein in connection with the sale of this product.

Some states do not allow limitations on how long an implied warranty lasts or the exclusion or limitation of incidental or consequential damage so the above limitations or exclusions may not apply to you. This Warranty gives you specific legal rights and you may also have other rights which vary from state to state.

U.S.A. : AUDIOVOX ELECTRONICS CORPORATION, 150 MARCUS BLVD.,
HAUPPAUGE, NEW YORK 11788 1-800-645-4994

CANADA : CALL 1-800-645-4994 FOR LOCATION OF WARRANTY STATION
SERVING YOUR AREA

128-5148C



For Customer Service
Visit Our Website At
www.audiovox.com
Product Information, Photos,
FAQ's, Owner's Manuals

© 2001 Audiovox Electronics Corp., Hauppauge, NY 11788 Printed in Korea
128-6163

Free Manuals Download Website

<http://myh66.com>

<http://usermanuals.us>

<http://www.somanuals.com>

<http://www.4manuals.cc>

<http://www.manual-lib.com>

<http://www.404manual.com>

<http://www.luxmanual.com>

<http://aubethermostatmanual.com>

Golf course search by state

<http://golfingnear.com>

Email search by domain

<http://emailbydomain.com>

Auto manuals search

<http://auto.somanuals.com>

TV manuals search

<http://tv.somanuals.com>