

GPS-DG9208G3 | Vehicle Specific Mounting Bracket for Most Portable GPS



Package Contents:

- (1) DG-92-08-G3 - Pro.Fit™ Vehicle Specific Mounting Bracket*
- (1) SP-SBH-Kit - Dual-T Head with Swivel Ball Socket & Locking Ring
- (1) APTTO - Adapter plate for TomTom ONE pattern
- (1) APTTGOXL - Adapter plate for TomTom ONE XL pattern
- (1) APTTGO520 - Adapter plate for TomTom GO pattern
- (1) APTTTEP - Adapter plate for TomTom EasyPort™ pattern
- (1) APTTSE - Adapter plate for TomTom Start™ and Ease™ pattern
- (1) APMM200 - Adapter plate for Mio Moov 200 Series pattern
- (1) APMM300 - Adapter plate for Mio Moov 300 Series and newer Magellan GPS patterns

TomTom Device Compatibility:

TomTom ONE 125 (TomTom EasyPort Mount)
 TomTom ONE 130, ONE 130-S (TomTom EasyPort Mount)
 TomTom ONE 140, ONE 140-S (TomTom EasyPort Mount)
 TomTom XL 325, XL 325-S (TomTom EasyPort Mount)
 TomTom XL 330, XL 330-S (TomTom EasyPort Mount)
 TomTom XL 340, XL 340-S (TomTom EasyPort Mount)
 TomTom XXL 530-S, XXL 540-S (TomTom EasyPort Mount)
 TomTom ONE (US Edition, US 3rd Edition)
 TomTom ONE XL (1st Edition) - TomTom ONE XL-S (1st Edition)
 TomTom ONE 22, ONE 22 Regional, ONE 22 Regional Traffic
 TomTom XL 22, XL 22 Regional (TomTom EasyPort Mount)
 TomTom ONE UK / EUROPE (NEW Edition aka 2nd Edition, 3rd Edition)
 TomTom GO 520 / 530 / 630 / 720 / 730 / 920 / 920T / 930
 TomTom Start and Ease

Garmin Nuvi Device Compatibility - 17mm Ball Pattern: 200, 200w, 205, 205w, 250, 250w, 255, 255w, 260, 260w, 265T, 265WT, 270, 275T, 285WT, 300, 300T, 310, 310T, 350, 360, 360T, 370, 370T, 500, 550, 600, 610, 650, 660, 670, 680, 710, 750, 755T, 760, 760T, 765T, 770, 775T, 780, 785T, 850, 855, 860, 880, 885T, 1200, 1250, 1260T, 1300, 1350, 1340T, 1350T, 1370T, 1390T, 1450, 1490T, 1690, 5000

Garmin StreetPilot Device Compatibility: c310, c340, c510, c530, c550, c580

Magellan GPS Device Compatibility:

Magellan Maestro 3100, 3140, 3200, 3210, 3220, 3225, 3250, 4000, 4010, 4040, 4050, 4210, 4215, 4200, 4220, 4245, 4250, 4350, 4370, 5310, 5340
 Magellan RoadMate 300, 360, 500, 500 Plus, 700, 760, 800, 860T 1200, 1210, 1212, 1215, 1220, 1230, 1340, 1400, 1412, 1430, 1440, 1445T, 1470, 1475T, 2000, 2200T, 2250T, 3000T, 3050T, 6000T
 Magellan Triton 1500, 200, 2000, 300, 400, 500

Mio Moov Device Compatibility: Mio Moov 200 Series and Mio Moov 300, 301, 310, 330, 330 Europe, 360, 370 Europe, 380, Mio Knight Rider Edition, Moov 500, 5401, 5501, M300, M400

NAVMAN Device Compatibility: S30, S30 3D, S50, S50 3D, S70, S90i

*See included Pro.Fit manual for Vehicle Specific Mounting Bracket instructions. For question regarding installation, contact Pro.Fit at 800.388.0073.

Installing the Vehicle Specific Mounting Bracket

- Step 1. See the included ProFit VSM Bracket manual for instructions on installing the VSM Bracket. Arkon recommends that you have the VSM bracket professionally installed. Arkon is not responsible for any unintended damaged caused by installation of the VSM Bracket.

*See included Pro.Fit manual for Vehicle Specific Mounting Bracket instructions. For question regarding installation, contact Pro.Fit at 800.388.0073.

Connect Dual-T Head to VSM Mounting Pedestal

- Step 1. Slip the tightening ring (A) over the VSM bracket ball. Snap the dual-T head adapter plate (B) on to the bracket ball (C). Screw the tightening ring over the adapter plate until securely holding the plate. Adjust the angle as needed.

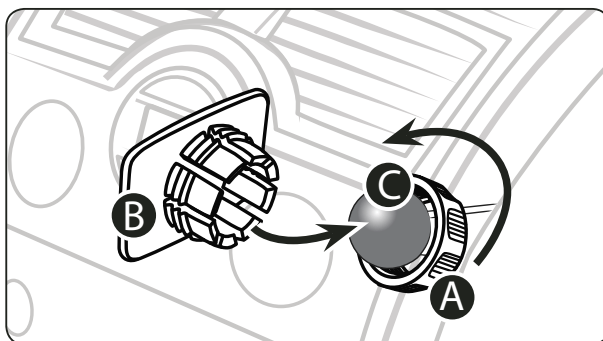

Do not place mount in or near an air bag deployment zone.

Safety Precautions

Do not install Arkon products over an air bag cover or within the air bag deployment zone. Arkon Resources, Inc. assumes no responsibility of liability for injury or death as a result of car crashes and/or air bag deployment.

Arkon is not responsible for any damages caused to your car, your device, or yourself due to the installation or use of this pedestal mount.

Connect Adapter Plate for TomTom ONE or ONE XL to Device

- Step 1. Slide the adapter plate up into the grooves on the back of the TomTom ONE, XL, or XL-S device (not included, sold separately).

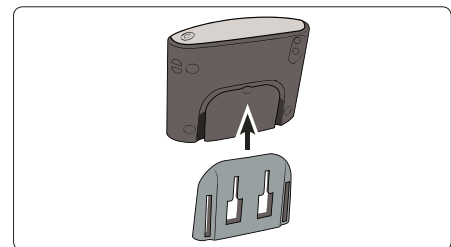

Connect TomTom ONE, XL, or XL-S Device to Pedestal

- Step 1. Connect the dual T-tabs (A) on the dual-T pedestal to the dual T-tab slots (B) on the adapter plate.

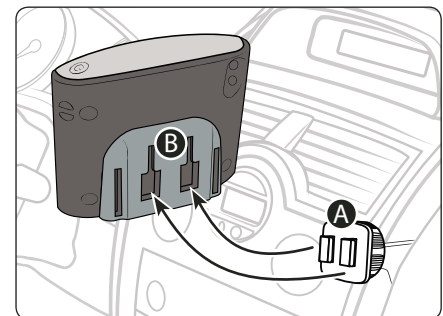

Continued on other side...

All brand names and product names are trademarks or registered trademarks of their respective owners.

ARKON
RESOURCES INC.

The Mobile Mounting Specialists™

Consumer Hotline:

USA (800) 841-0884

INT'L (626) 254-9005

Monday - Friday 9am - 5pm, PST

www.arkon.com

Arcadia, CA 91006 USA

Designed in USA | Made in the USA & China

© Copyright 2010 Arkon Resources, Inc.

GPS-DG9208G3 | Vehicle Specific Mounting Bracket for Most Portable GPS

Connect Adapter Plate for TomTom EasyPort™ to Pedestal

Step 1. Connect the dual T-tabs (A) on the dual-T pedestal to the dual T-tab slots (B) on the adapter plate.

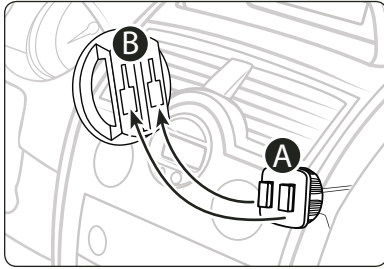

Connect TomTom Device to Pedestal with EasyPort™ pattern

Step 1. While holding the mounted TomTom adapter plate, gently insert the TomTom device (not included, sold separately) into the adapter plate until an audible click is heard. The device can then be rotated into the desired viewing angle.

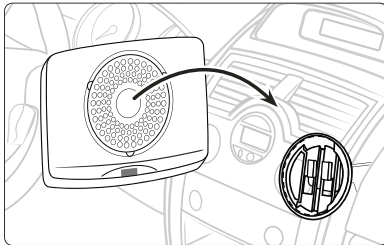

Connect Adapter Plate for TomTom GO GPS

Step 1. Slide the adapter plate up into the grooves on the back of the TomTom GO series device (not included, sold separately).

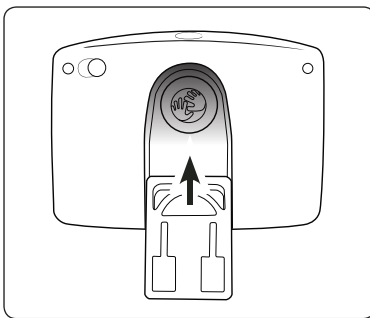

Connect TomTom GO GPS to Pedestal

Step 1. Connect the dual T-tabs (A) on the dual-T pedestal to the dual T-tab slots (B) on the adapter plate.

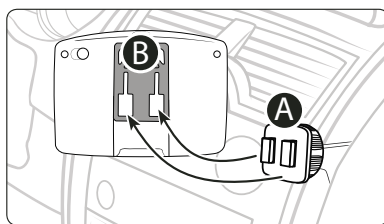

Connect TomTom Start™ & Ease™ Device to Pedestal

Step 1. Attach the dual-T adapter plate for TomTom to the pedestal by inserting the dual-T tabs of the pedestal (A) into the dual T-slots on the adapter plate (B).

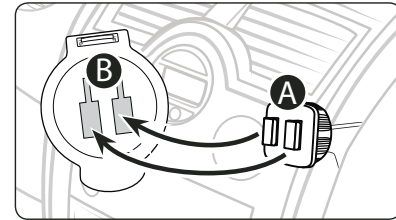

Step 2. While holding the mounted TomTom adapter plate, gently insert the TomTom device (not included, sold separately) into the adapter plate until an audible click is heard.

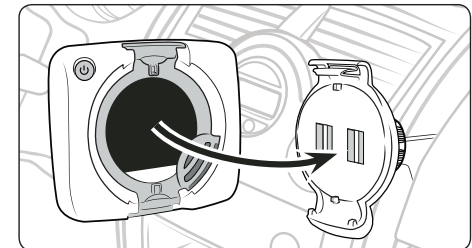

Connect Garmin Device to 17mm ball head

Step 1. Attach Garmin GPS to 17mm ball head by firmly pushing the ball head (A) into the 17mm ball head socket on the back of the device (B) as pictured below.

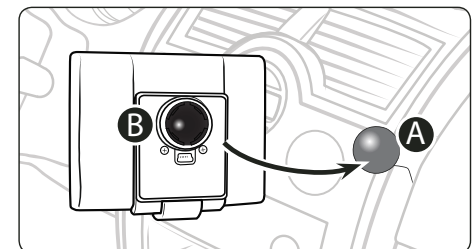

Connect Mio Moov 200 Series or NAVMAN 530 3D GPS Device to Pedestal

Step 1. Connect the adapter plate for Mio Moov to Mio device (not included, sold separately) by placing the feet (A) of the adapter into the corresponding notches (B) on the bottom of the device. Holding the thumb tab down (C), insert the upper tooth (D) into the recessed slot on the back of the device.

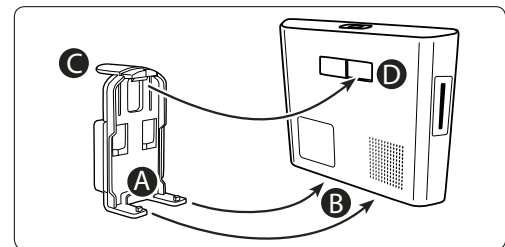

Safety Precautions

Do not install Arkon products over an air bag cover or within the air bag deployment zone. Arkon Resources, Inc. assumes no responsibility of liability for injury or death as a result of car crashes and/or air bag deployment.

Arkon is not responsible for any damages caused to your car, your device, or yourself due to the installation or use of this pedestal mount.

ARKON
RESOURCES INC.

The Mobile Mounting Specialists™

Consumer Hotline:
USA (800) 841-0884
INT'L (626) 254-9005
Monday - Friday 9am - 5pm, PST

www.arkon.com
Arcadia, CA 91006 USA
Designed in USA | Made in the USA & China
© Copyright 2010 Arkon Resources, Inc.

GPS-DG9208G3 | Vehicle Specific Mounting Bracket for Most Portable GPS

Step 2. Connect the dual T-tabs (E) on the dual-T pedestal to the dual T-tab slots (F) on the adapter plate.

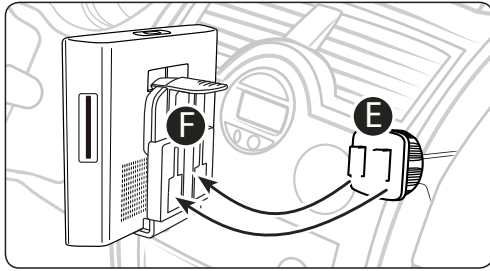

Connect Mio Moov 300 Series, NAVMAN S50, S50 3D, 570, S90i or newer Magellan Devices to Pedestal

Step 1. Insert the power cord (not included, sold separately) into the grooved slot in the bottom of the adapter plate.

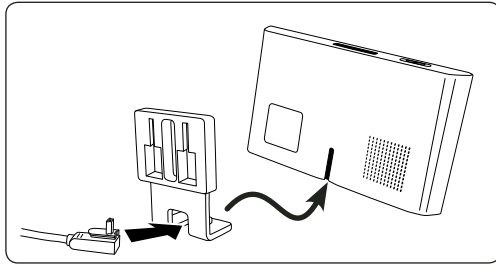

Step 2. Connect the dual T-tabs (A) on the dual-T pedestal to the dual T-tab slots (B) on the adapter plate.

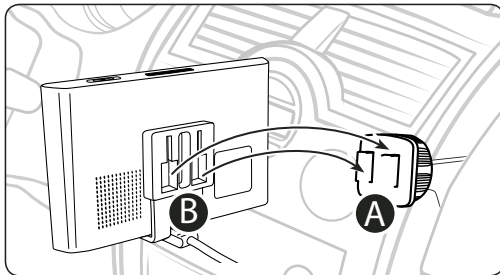

Safety Precautions

Do not install Arkon products over an air bag cover or within the air bag deployment zone. Arkon Resources, Inc. assumes no responsibility of liability for injury or death as a result of car crashes and/or air bag deployment.

Arkon is not responsible for any damages caused to your car, your device, or yourself due to the installation or use of this pedestal mount.

ARKON
RESOURCES INC. The Mobile Mounting Specialists™

Consumer Hotline:

USA (800) 841-0884

INT'L (626) 254-9005

Monday - Friday 9am - 5pm, PST

www.arkon.com

Arcadia, CA 91006 USA

Designed in USA | Made in the USA & China

© Copyright 2010 Arkon Resources, Inc.



Dodge Challenger 2009-2010

DG-92-08-G3



PLEASE READ COMPLETE INSTRUCTIONS BEFORE INSTALLING THIS VSM G3

All instructions assume a drivers seat vantage point. Caution is advised when removing and reassembling wood or plastic parts of a dash. Applying unnecessary force or pressure may cause a piece to crack or break.

When properly installed, the metal between the ball and 2 small holes is all that is exposed.
(Some exceptions apply).

TOOLS REQUIRED: Dash Trim Removal Tool (DTRT), Phillips screwdriver

PARTS INCLUDED: VSM G3, A Plate, J Stem

LOCATION: Right of Radio

Step 1: Place the DTRT in between the radio bezel and the dash molding **Photo #1**. Gently use the DTRT in a twisting motion around the radio bezel releasing a series of eight (8) retainer clips. Do not disconnect any wiring to the bezel and simply set the radio bezel off to the side.



Step 2: Remove the two Phillips screws securing the right side of the radio to the dash molding and carefully set them off to the side. Place the VSM G3 flush to dash molding over the screw holes and evenly tighten the VSM G3 to the right side of the radio molding as pictured in **Photo #2**.



Step 3: Once the VSM G3 is flush and secured to the right side of the radio, replace the radio bezel back into its secured original position. You have successfully installed your VSM G3!



Note: Note: See the Assembly Instructions for G3 Components for additional information.

Pro.Fit International, Inc.® may not be held liable for any damage to a vehicle before, during or after the installation or removal of this VSM G3™. Pro.Fit International may not be held liable for any personal injury resulting from accident or improper installation. Pro.Fit International, Inc.® 1335 Eagandale Court, Eagan, MN 55121, Ph: 651.688.3588 or 800.388.0073 Fx: 651.688.9876

Installation Difficulty
 ● ○ ○ ○ ○
 Simple Advanced

© Pro.Fit International, Eagan, MN 2009

View Instruction & Updates
 Online at
www.pro-fit-intl.com

Free Manuals Download Website

<http://myh66.com>

<http://usermanuals.us>

<http://www.somanuals.com>

<http://www.4manuals.cc>

<http://www.manual-lib.com>

<http://www.404manual.com>

<http://www.luxmanual.com>

<http://aubethermostatmanual.com>

Golf course search by state

<http://golfingnear.com>

Email search by domain

<http://emailbydomain.com>

Auto manuals search

<http://auto.somanuals.com>

TV manuals search

<http://tv.somanuals.com>