



Analog Door Phone Model LUADS

Installation and Use Manual

- Telephone line powered
- Two-way, hands-free communication
- Vandal-resistant brushed stainless steel faceplate with mounting gasket and heavy-duty call button
- Adjustable microphone and speaker volume
- Adjustable call timer duration
- Defeatable call timer
- Responds to forward disconnect
- Selectable Auto Answer feature allows remote monitoring

Issue 1, December 2003

© 2003 Bogen Communications, Inc.
All rights reserved. 54-2106-01A 0312
Printed in Taiwan.

Specifications subject to change without notice.

Notice

Every effort was made to ensure that the information in this manual was complete and accurate at the time of printing. However, information is subject to change.

Important Safety Information

Always follow these basic safety precautions when installing and using the system:

1. Read and understand all instructions.
2. Follow all warnings and instructions marked on the product.
3. DO NOT block or cover the ventilation slots and openings.
4. Never spill liquid on the product or drop objects into the ventilation slots and openings. Doing so may result in serious damage to the components.
5. Repair or service must be performed by a factory authorized repair facility.
6. DO NOT install telephone wiring during a lightning storm.
7. DO NOT install telephone jacks in a wet location unless the jack is specifically designed for wet locations.
8. Never touch uninsulated wires or terminals, unless the line has been disconnected at the paging or controller interface.
9. Use caution when installing or modifying paging or control lines.

Service Requirements

In the event of equipment malfunction, all repairs should be performed by Bogen or an authorized agent. It is the responsibility of users requiring service to report the need for service to Bogen or to one of our authorized agents. Service can be facilitated through our office at:

Bogen Communications, Inc.

50 Spring Street, Ramsey, NJ 07446, USA

Tel. 1-800-999-2809

Bogen's Applications Department may be reached at: 1-800-999-2809.

Package Contents

- (1) LUADS
- (1) Dual gang electrical box
- (4) Panel screws
- (1) Hex wrench

Features

Auto Answer

The LUADS can be programmed to automatically answer an incoming call. This feature can be enabled or disabled using a jumper.

Timer Duration

The LUADS can be programmed to automatically disconnect a call after a preset amount of time has elapsed. The timer can be set between 15 seconds and 2 minutes.

When the call is initiated by the unit, then the timer starts as soon as the button is pushed. When the call is initiated by another phone (Auto Answer), then the timer starts once the unit answers the call.

With the timer disabled, the call time will be unlimited and the LUADS will not disconnect the call until a 300 ms or longer loss of loop current is detected. If your telephone line/phone system extension does not supply a loop current break when the calling party hangs up, then the call timer feature must be used (enabled).

Speaker Volume

Adjusts the speaker volume of the unit.

Microphone Level

Adjusts the microphone return talk level of the unit. In certain noisy locations (e.g., background traffic, machinery, or wind) the microphone threshold level may need to be decreased, otherwise the unit might pickup the background noise thereby causing the unit to remain in the talk mode.

Active LED

When lit, the LED indicates that the unit is active (off-hook). Active LED is intended for diagnostic use only.

Programming

TEL Line Connector - Analog station line connection (Tip and Ring) is made via an RJ11 connector that is pre-wired to a 2-position pluggable terminal block. Not polarity sensitive.

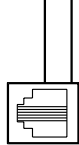

Auto Answer Feature - The Auto Answer feature can be enabled or disabled depending on where the jumper is set.

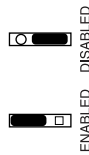

Timer - The Timer feature is jumper selectable and can be enabled or disabled.



Speaker Volume - The Speaker Volume POT can be adjusted to increase or decrease the speaker volume to the desired level.

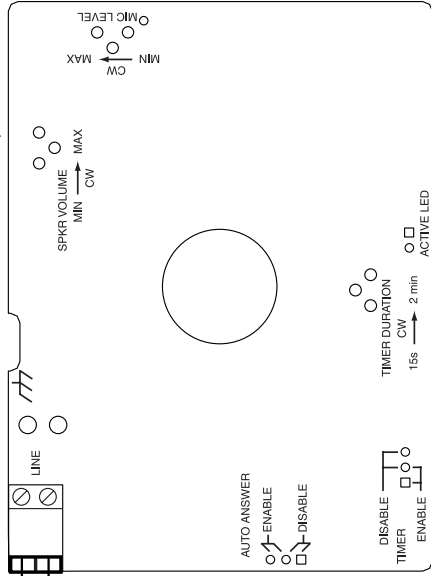
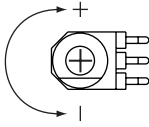

Mic Level - A Mic Level POT is provided on the LUADS for increasing or decreasing the microphone return talk level.

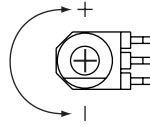

Timer Duration - The LUADS is equipped with an adjustable call timer duration feature that automatically hangs up the unit after the preset time has elapsed.

Wiring

Phone Connection

To connect the LUADS to a phone system, simply connect the analog station line to the RJ11, which is already wired to a pluggable terminal block that is preassembled to the circuit board. The connections to the terminal block are not polarity sensitive.

Surge Protection

To increase surge protection, connect a protective Earth Ground to the spare lug provided. The location of the spare lug is shown below.

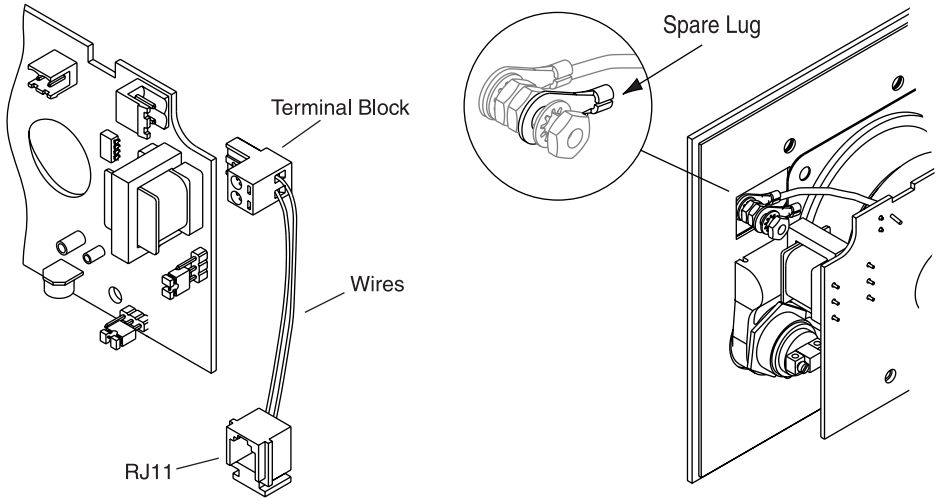

Installation

The LUADS comes with a standard dual gang electrical box.

Make all electrical connections prior to installing the LUADS into the electrical box.

Surface Mounting the LUADS (Indoor/Outdoor)

1. Mount electrical box.
2. Make electrical connections (see *Wiring*) and attach the faceplate to the electrical box using the four hex drive screws (tool provided).

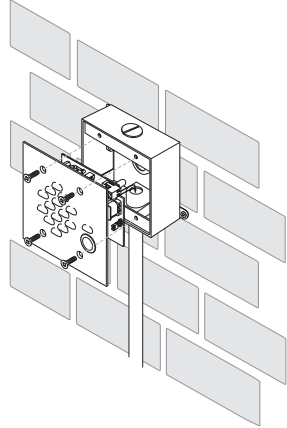

Specifications

Power:	Telephone line powered (18V DC / 20 mA minimum)
Timer Duration:	15 seconds to 2 minutes
Loop Current Loss Disconnect:	300 ms minimum
Ring Voltage:	40V AC RMS minimum
REN:	0.7A
Connections:	RJ11 pre-wired to a 2-position pluggable terminal block Earth Ground lug
Dimensions:	5" W x 5" H x 2 ¹ / ₄ " D (fully assembled) 4 ⁵ / ₈ " W x 4 ⁵ / ₈ " H x 2" D (aluminum box)
Product Weight:	4 lb.

Free Manuals Download Website

<http://myh66.com>

<http://usermanuals.us>

<http://www.somanuals.com>

<http://www.4manuals.cc>

<http://www.manual-lib.com>

<http://www.404manual.com>

<http://www.luxmanual.com>

<http://aubethermostatmanual.com>

Golf course search by state

<http://golfingnear.com>

Email search by domain

<http://emailbydomain.com>

Auto manuals search

<http://auto.somanuals.com>

TV manuals search

<http://tv.somanuals.com>