

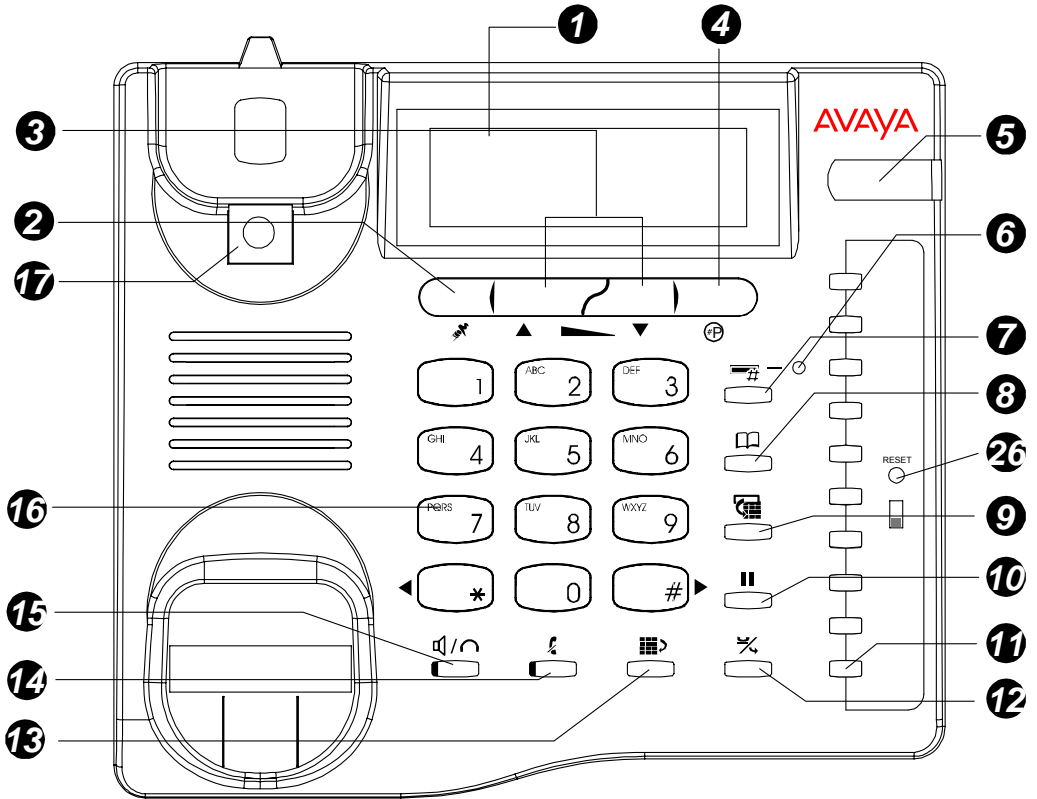

Avaya Gemini CLI Analog Telephone 9335-AV

General Note: When power is switched on or batteries are inserted the display will be blank until the Handset is lifted or the Handsfree button is pressed.

Figure One



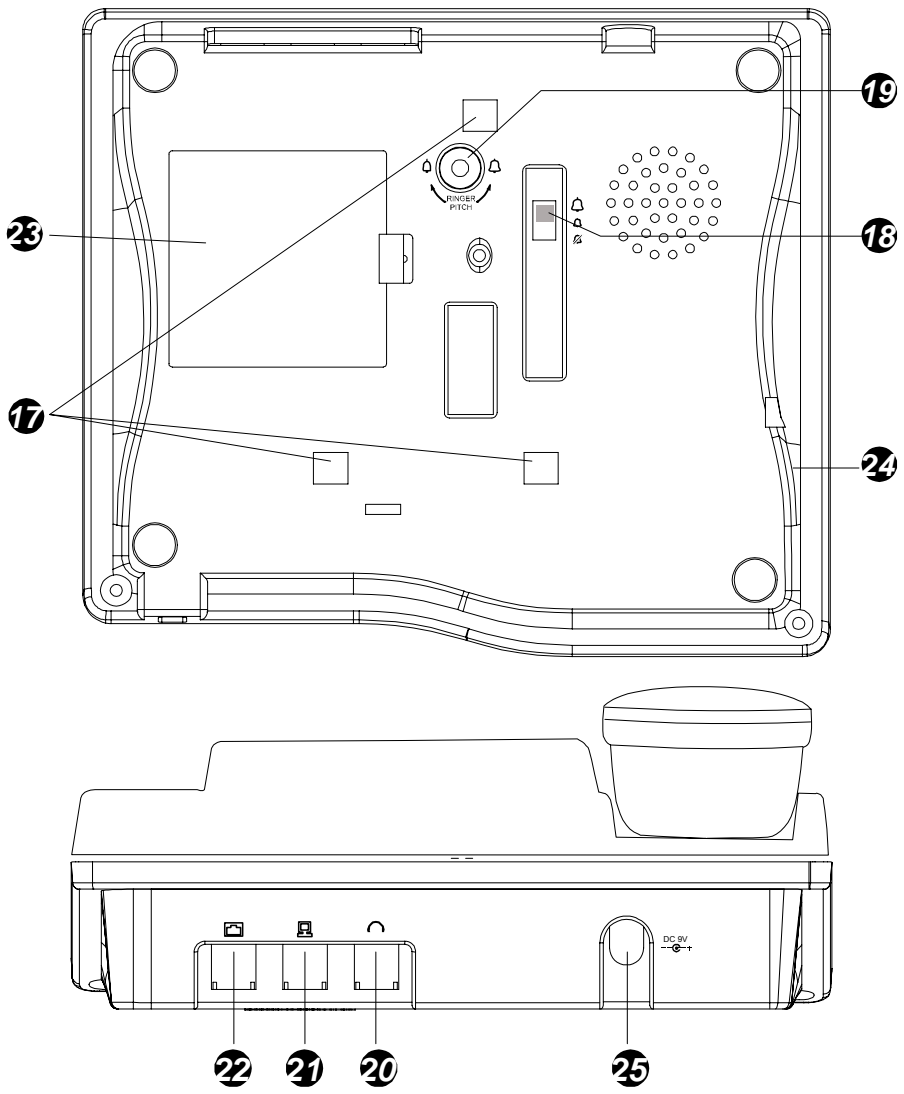

Contents

INTRODUCTION	7
INTENDED USE	8
SAFETY	9
TELEPHONE FEATURES	11
DISPLAY.....	14
SETTING THE CLOCK.....	15
MEMORY FUNCTION	16
DIRECTORY.....	16
<i>Programming Directory memory.....</i>	<i>16</i>
<i>Dialling a Directory memory.....</i>	<i>17</i>
<i>To delete a Directory memory.....</i>	<i>17</i>
DIRECT ACCESS MEMORY	17
<i>Programming Direct Access memory buttons</i>	<i>18</i>
<i>Dialling Direct Access memory buttons</i>	<i>19</i>
CALLS MEMORY	19
DISPLAYING CALLS RECEIVED.....	19
<i>To store a Call memory to Directory Memory.....</i>	<i>20</i>
<i>To store a Call Memory to Direct Access memory</i>	<i>20</i>
<i>Deleting the Calls memory.....</i>	<i>21</i>
REDIAL MEMORY	21
<i>Viewing the Redial memories</i>	<i>22</i>

SERVICE	23
HEARING AID COMPATIBLE	23
WARRANTY	23

Introduction

This AVAYA 9335-AV caller display telephone is specially designed to work behind the AVAYA IP OFFICE system.

The telephone is able to show caller display information provided that this option has been switched on by your installer.

When a call is received at the telephone, it will display the number of the person calling you (there are some exceptions to this like withheld numbers). This information is stored together with information about the time/date of the call and whether you answered the call or not. Information on the last 80 calls is retained in the telephone memory and it is possible to scan through these calls and dial someone back by simply pressing one button.

There is an independent directory for you to store the telephone numbers and names of 100 entries. If one of your directory “Names” calls you, then the display will show not only the number calling you but the name, as stored in your directory or the IP OFFICE system memory.

As well as a directory of numbers it is possible to store up to 20 names and numbers in ten one- and two-touch buttons.

It is also possible to use this telephone in combination with a headset. There is a universal interface in the telephone which will allow connection of most headsets, providing that they have an RJ11 plug for connection to the headset socket situated at the back of the telephone.

Safety

When using your telephone equipment, the following safety precautions should always be followed to reduce the risk of fire, electric shock and injury to persons. Read and understand all instructions. Follow all warnings and instructions marked on the telephone. This telephone can be hazardous if immersed in water.









If you suspect a natural gas leak, report it immediately, but use a telephone away from the area in question.

Never push objects of any kind into the equipment through housing slots. To reduce the risk of electric shock, do not disassemble this telephone. There are no user serviceable parts.

Avoid using the telephone during thunderstorms in your immediate area.





Installation





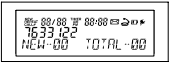



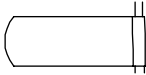

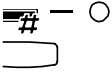

Please refer to **Figure One** at the front of this user guide



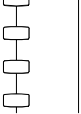

25		<p>This telephone requires a power supply in order to operate correctly. A suitable power supply is included with the telephone and it should be connected to the socket at the rear of the telephone.</p>
23		<p>Alternatively, the telephone will operate utilizing 3 AA batteries (not provided). To insert the batteries, first ensure that the telephone is disconnected from the telephone line.</p>
22		<p>This jack is used to connect a line cord to your telephone.</p>
24		<p>The handset cord plugs in here.</p>
20		<p>A headset plugs in here.</p>
21		<p>The jack labelled is used to connect a device such as a modem to your Telephone.</p>
18		<p>A 3-position switch is used to control the volume of the ring tone. Select from loud ring, quiet ring or ringer off.</p>
19		<p>Turn the pitch control to adjust the pitch of the ringer.</p>
17		<p>Wall mounting - An additional wall bracket is required - Using the template supplied with the bracket, position where you want to fix your telephone. Drill two holes and fix roundhead screws. Attach the telephone to the bracket. Slide the bracket into place on the screws. Remove the handset retainer by pushing up out of the slot. Turn the retainer through 180° and place back in its slot.</p> <p>Wall brackets can be obtained from your distributor or contact Avaya Analog support on +44 870 220 0402 www.analogphonesavaya.com</p>

Telephone Features

Please refer to **Figure One** at the front of this user guide

1		<p>The telephone is supplied with a protective cover over the display. Carefully peel this off before using the telephone.</p> <p>The large LCD panel normally shows the time of day and the number of new calls that you have not yet viewed. With incoming calls or when viewing the directory or viewing the calls list it will show the date, the number and the name of the caller (if programmed into the directory or the IP OFFICE). There are several prompts that also tell you what state the telephone is in at a particular moment in time (see detailed instructions on page 14).</p>
2		<p>Use this button to delete a Directory memory.</p> <p>Access the Directory memory to be deleted and press this button TWICE in quick succession.</p> <p>“ERASE” will appear on the display and the memory will be deleted.</p>
3		<p>To adjust the volume of the Handset, Headset and Handsfree, Press the ▲ and ▼ volume buttons.</p> <p>Note: The ▲ and ▼ can also be used as Scroll Up or Down buttons to review the Redial, Directory and the Caller memory list. The Scroll buttons also serve as Edit buttons during memory storage.</p>
4		<p>Use this button to program the 100 telephone numbers and names in your Directory and the 10 Direct Access memory buttons 11.</p>
5		<p>The red message waiting light flashes when you have a message. It also flashes when your telephone rings.</p>



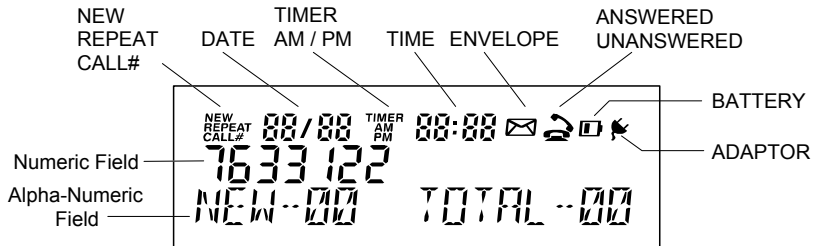

6		This light is to let you know that new calls have been received which have not been reviewed.
7		Pressing this button will bring the calls information on the display and, at the same time, cause the LED to stop flashing and reset the NEW CALLS counter to 0.
8		<p>You can store up to 100 telephone numbers and names in your personal directory.</p> <p>Use this button to access a memory; a call can be made by pressing the  button.</p> <p>If an incoming call is received from someone whose name is stored in the Directory, then that name will appear on your display together with the incoming callers telephone number.</p>
9		Use this button to dial a number on the display. This can be a call from your Directory  or an incoming call stored in the Call memory  or one of the calls in the Last Number Redial memory.
10		Press this button to insert a pause.
11		These 10 Direct Access memory buttons are able to save 20 memories, each with a maximum of 32 digits and 16 alpha characters. The memories are accessed by either one touch or two touches of the memory button.
12		Press this button during a call to return dial tone. This will enable you to transfer the call to another party or instigate a feature such as conference.
13		Press this button to redial the last number you dialed from the keypad. Using the ▲ and ▼ buttons, you can scroll through the last five numbers you dialed. To call any of the numbers press the  button when the correct number is displayed on the screen.

14		<p>This button mutes the microphone so the other person on the call cannot hear you. A red lamp indicates the mute is on. Pressing it a second time releases the mute and returns you to normal conversation. It works in Handset, Handsfree and Headset mode.</p>
15		<p>This button will activate the two-way Handsfree speech circuit. Lifting the Handset will revert to Handset working. Pressing the button when in Handset mode will switch to Handsfree, allowing you to replace the Handset in the cradle without disconnecting the call in progress. When a Headset is plugged in to the Headset socket 20 the Handsfree function is disabled to allow the button to operate the Headset.</p>
16		<p>A standard telephone keypad with the number “5” having a raised dot for visually impaired users.</p>
26	<p>RESET</p> 	<p>If the telephone appears not to function correctly pressing this button will reset the telephone.</p>

Display



Please refer to the drawing above

<p>NEW REPEAT CALL#</p>	<p>This is the received calls indicator. NEW denotes calls not previously reviewed. REPEAT - indicates multiple calls from the same caller; only the Date and Time from the most recent attempt will be displayed. CALL # - indicates received Caller List entry number.</p>
<p>02/25</p>	<p>This is the Date field showing date in MONTH/DAY format; it shows the current date or date of received call.</p>
<p>TIMER AM PM</p>	<p>This field indicates Time mode status. TIMER - indicates Call Timer or Stop Watch mode is active. AM/PM - for clock display (only displays in 12 hour mode).</p>
<p>20:40</p>	<p>Displays the current time or the time of the received call in HOUR : MINUTE format. It also displays the call timer and stop watch in MINUTE : SECOND format.</p>
	<p>These symbols are used in conjunction with Caller list.</p> <p> indicates the call was answered;  indicates call was not answered.</p>
	<p>If this symbol is displayed, you are recommended to change the batteries.</p>

	This symbol will be displayed when the unit is functioning with batteries.
7633	16 digit field for displaying the telephone number.
NEW-00 TOTAL-00	16 character alpha numeric display to show caller name or number of new calls and total calls received.

Setting the clock

Lift Handset, insert the 9V DC Adaptor (supplied) to the power socket or insert 3 AA Alkaline batteries.

1. Key in the year, # month and day

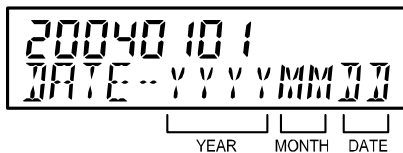

2. Press "1" for 12HR or Press "2" for 24HR

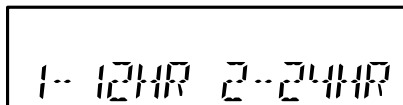

3. If 12HR selected, Press "1" for AM or Press "2" for PM

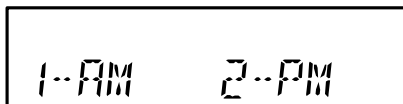

4. Enter time hour & minute



5. The display will show "CLOCK STORED"

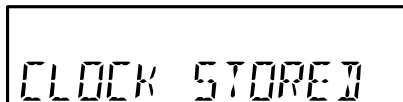

NOTE: You do not need to perform this operation if you wait for your first call to be received, clock will be set automatically to the correct time by the caller display signal. If you want to reset date / clock, press STORE and **#**.

Memory function

There are four different memory stores on this telephone. All of the memory locations will accept 32 digits and 16 alpha characters.

Directory

You can store up to 100 telephone numbers and names in your personal directory. By accessing a memory, a call can be made by pressing the  button. If an incoming call is received from someone whose name is stored in the directory or in the IP OFFICE directory, then that name will appear on your display together with the incoming callers telephone number.





Programming Directory memory

To store a Directory memory; Press  then press  follow the screen prompts

- at “ENTER NUMBER” prompt key in the number to be stored.

Press 

- at “ENTER NAME” prompt key in the name to be stored using the numeric keypad press the appropriate button a number of times to display the letter you require.

Press the  to move the cursor to the next space, use the  buttons to edit the name or  buttons to edit the number. The names will be stored in alphabetical order.

Press 

Dialling a Directory memory

To dial a Directory memory; Press 

You can then scroll through the complete directory by using the ▲ and ▼ buttons. Each memory will appear in alphabetical order.

Alternatively, you can search for a particular letter by pressing , followed by the alpha key for which you want to search - press 6 once for “M” or twice for “N” for example. All entries that begin with that letter will then be scanned using the ▲ and ▼ buttons.

When you find the memory you require press the  button to dial.

To delete a Directory memory

Access the Directory memory to be deleted, as described above. Press the  button TWICE in quick succession. “ERASE” will appear on the display and the memory will be deleted.

Direct Access memory

There are 10 buttons providing 20 Direct Access memory locations, each with a maximum of 32 digits and 16 alpha characters. The memories are accessed by one touch or two touches of the Direct Access memory button **11**.

Programming Direct Access memory buttons





To store a Direct Access memory; Press the  button. "STORE" will appear on the display.

Press one of the Direct Access memory buttons **11**, where you wish the memory to be stored.

NOTE: if the button is pressed once the memory will be stored under the button as a one-touch button. If the memory button is pressed twice in quick succession, the memory will be stored under the button as a two-touch button.

At the prompt dial the number to be stored. It is possible to store the Handsfree function  as the first character. In this case when a memory button is pressed, the telephone will automatically seize the line and make the call, in Handsfree mode.

Press the  button



- at "ENTER NAME" prompt key in the name to be stored using the numeric keypad press the appropriate button a number of times to display the letter you require. Press the  to move the cursor to the next space use the   buttons to edit the name or   buttons to edit the number.

Press the  button

"STORE COMPLETED" will appear on the display.

If you make a mistake in entering the data, simply overwrite the memory data by doing the entry again.





Dialling Direct Access memory buttons

Pressing any of the Direct Access buttons  once or twice will automatically display the number stored. If the Handsfree  has been programmed into the memory then pressing the memory button will automatically dial the number. If the number is displayed because the Handsfree function has not been stored, pressing the  button will dial the number.

Calls memory

Each call received, up to a maximum of 80 calls, can be stored in this memory. The information stored includes telephone number and name (if this information is stored in your personal or IP OFFICE directory) date and time of call, whether the call was answered or not.



Displaying calls received

If the  is flashing then there are new calls in the Directory that you have not viewed before. Press  button to display the last call to be received on the screen. Using the  and  button you can move up and down through the memories to see who has called. If you wish to make a call to a particular caller, make sure that the entry is on the screen and then press the  button. The telephone will automatically call the number in Handsfree mode.

To store a Call memory to Directory Memory

Press the # button

Press the ▲ and ▼ button to select desired number from the Caller list.

Press  and then press .

Follow the screen prompts

- at “ENTER NUMBER” prompt key in the number to be stored.

Press 

- at “ENTER NAME” prompt key in the name to be stored

Press 

To store a Call Memory to Direct Access memory

Press the # button

Press the ▲ and ▼ button to select desired number from the Caller list

Press  and then press a memory button (one- or two-touch memory button)

11

Follow the screen prompts

- at “ENTER NUMBER” prompt key in the number to be stored.

Press 

- at "ENTER NAME" prompt key in the name to be stored

Press 

Deleting the Calls memory

Press the  button

Press the ▲ and ▼ button to select desired number from the Caller list that is to be erased.

Press  button twice; the call is erased.

There may be situations where you wish to delete the entire Calls memory.

Press the  button



Press  button twice in quick succession holding it down after the second press until the screen has displayed "HOLD TO CLR CALL".

The screen displays "CALL MEM CLEAR" after all call memories have been erased.

Redial memory

The redial buffer stores the phone number of the last five numbers that were called from the telephone, either from the keypad or from a Direct Access memory

Viewing the Redial memories

Press the  button. The last number called on the telephone will be displayed with the telephone number and the message REDIAL 1. Using the ▲ and ▼ buttons you can review the last five numbers called. To call any of the numbers, make sure that the entry required is on the screen and press the  button. The telephone will automatically call the number in Handsfree mode.

Service

Before cleaning, unplug the telephone from the modular wall jack. Do not use liquid cleaners or aerosol cleaners. Use a damp cloth for cleaning.

Hearing Aid Compatible

This telephone is Hearing Aid Compatible (HAC).

Warranty

This product is guaranteed for 18 months from the date of manufacture. To get warranty service on your telephone call the authorised service agent on +44 870 220 0402. Alternatively you may call the distributor from whom the product was purchased.

If you are directed to ship your telephone to the authorised service location, you must do this at your cost. We suggest that you retain the original packing material in the event you need to ship the unit. When sending your telephone include your name, address, and phone number, and description of the fault. After repairing or replacing your telephone, it will be shipped back at our expense. Further information can be obtained from www.analogphonesavaya.com

3C9335001-AV

Free Manuals Download Website

<http://myh66.com>

<http://usermanuals.us>

<http://www.somanuals.com>

<http://www.4manuals.cc>

<http://www.manual-lib.com>

<http://www.404manual.com>

<http://www.luxmanual.com>

<http://aubethermostatmanual.com>

Golf course search by state

<http://golfingnear.com>

Email search by domain

<http://emailbydomain.com>

Auto manuals search

<http://auto.somanuals.com>

TV manuals search

<http://tv.somanuals.com>