

ENGLISH

AVAYON

PORTABLE DivX MPEG-4 DVD PLAYER

Model DXP-7P

OWNER`S MANUAL

Please read this manual before operating.

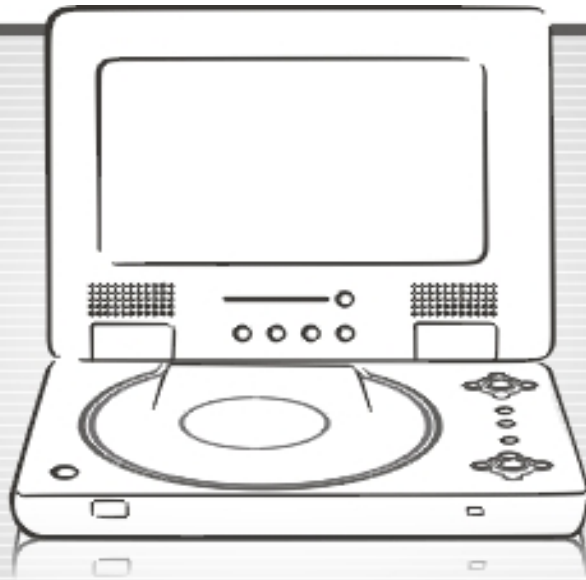

Table of Contents

Table of Contents.....	2
Safety Information.....	3
DivX Certification.....	4
Remote Control	5
Description.....	6
Using the Remote Control.....	7
Connecting Earphones to the DVD Player.....	8
Connecting to an External Component	9
Connecting to a TV.....	10
Connecting to a Stereo Component.....	11
Using the AC Adaptor.....	12
Using the Battery Pack.....	13
Cautions in Using Battery Pack.....	14
Installing Carrying Bag/Car Harness Kit (Optional Accessory).....	15
Playing a Disc.....	16-21
Playing an Mp3 or Regular Audio CD.....	22
Playing Picture CD.....	23
Setting Screen and Audio.....	24
Setting Parental Control, Password, Camera Angle.....	25
Setting System for TV system, Screen saver, TV type(4:3/16:9), Password, Rating, Default , DivX(R) VOD).....	26-27
Setting Language for OSD, Voice, Subtitle, Menu.....	28
Setting Audio Output.....	29
Setting Video for Brightness, Contrast, Hue, Saturation.....	30
Adjusting the LCD Screen.....	31
Troubleshooting.....	32-33
Specifications.....	34

Safety Information

Please read all of the safety and operating instructions before operating this Player, follow all warnings placed on the Player and in the user's manual. These safety and operating instructions should be retained for future reference.

Safety Information

- Do not expose the system to excessive moisture, rain, sand, or heat sources.
- Place the DVD Player on a firm, flat surface.
- Keep the DVD Player away from domestic heating equipment and direct sunlight.
- When placing the DVD Player in a cabinet, allow about one inch of space all around the DVD Player for ventilation.

SAFETY WARNING

CLASS 1 LASER PRODUCT / KLASSE 1 LASER PRODUKT / LUOKAN 1 LASER LAITE / KLASS 1 LASER APPARAT / PRODUCTO LASER CLASE.

INVISIBLE LASER RADIATION WHEN OPEN AND INTERLOCKS DEFEATED. AVOID EXPOSURE TO BEAM.

WARNING

- To prevent fire or electrical shock, do not expose this Player to rain or moisture.
- To avoid electrical shock, do not open the cabinet. No user-serviceable parts inside. Refer servicing to qualified personnel only.
- Certain countries may regulate the disposal of the battery used to power this product. Please consult with your local authority.
- Listening with earphones for many hours at maximum volume may damage your hearing.
- The Player should be connected to a power supply only of the type described in the operating instructions or as marked on the Player.

REFER ALL SERVICING TO A QUALIFIED SERVICE TECHNICIAN ONLY!

DivX Certification

By displaying the DivX® logo, we are demonstrating that AVAYON products have been tested and certified by DivXNetworks, the creators of DivX® video technology, and are capable of playing all versions of DivX® video content. DivX Certified ensures that the DivX® content you attain and create can be played on your AVAYON DivX® Certified product.



Supports DivX V3.11, V4.x, V5.x and later files (without QPEL and GMC).

Remote Control

Remote Control

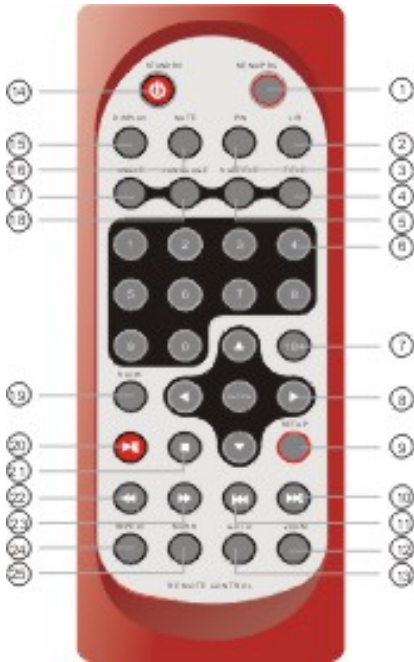

1. MENU/PBC Button
 - Brings up the disc menu.
2. L/R Button
 - Selects left, right and stereo sound tracks.
3. P/N Button
 - Selects PAL/NTSC/AUTO TV systems.
4. TITLE Button
5. SUBTITLE Button
 - Selects the subtitle's language.
6. Number Buttons (0,1,...,9)
7. 10+ Button
 - Uses to input 10 to 999 (combining this button and other digit number buttons).
8. ENTER/DIRECTION Buttons
9. SETUP Button
 - Brings up the setup MENU to set up the system's language, audio, display, password etc.
10. SKIP FORWARD (▶▶) Button
 - Use to skip to next title, chapter or track.
11. SKIP BACKWARD (◀◀) Button
 - Use to skip to previous title, chapter or track.
12. ZOOM Button
13. GOTO Button
 - Use to enter the specific chapter, track or time to playback.
14. STANDBY Button
 - Toggles between putting the Player on standby and power on.
15. DISPLAY Button
 - Displays the current disc playback information.
16. MUTE Button
17. ANGLE Button
 - Use to access various camera angles on a DVD.
18. LANGUAGE Button
 - Selects the voice language in a DVD.
19. SLOW Button
20. PLAY/PAUSE (▶||) Button
 - Press once to start play, press again to pause.
21. STOP Button
 - Stops disc play.
22. FAST REVERSE (◀◀) Button
23. FAST FORWARD (▶▶) Button
24. REPEAT Button
 - Allows you to repeat play a title, chapter, track, or disc.
25. MARK Button
 - Use to mark a point where the playback starts each time when the MARK button is pressed later on.

Description

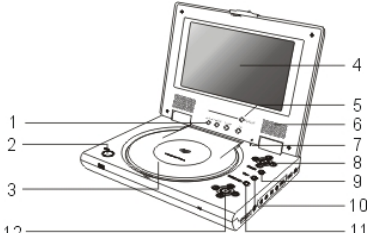
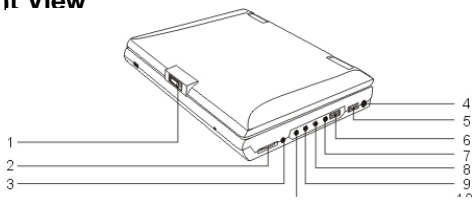
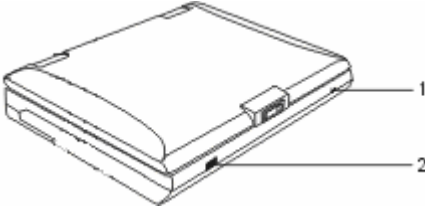
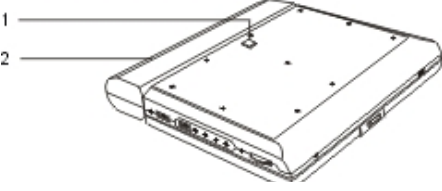
<p>Front View</p> 	<p>Right View</p> 
<p>1. (16:9/4:3)/MODE/DOWN/UP 2. OPEN 3. DISC COVER 4. LCD 5. REVERSE DISPLAY 6. SPEAKER ► 7. LCD on/off switch</p> <p>8. CURSOR(UP/DOWN/LEFT/ RIGHT), (◀▶) 9. MENU/PBC 10. STOP ■ 11. PAUSE/STEP ▶ 12. PLAYBACK BUTTONS PLAY FAST REVERSE FAST FORWARD SKIP-FORWARD SKIP-PREVIOUS</p>	<p>1. OPEN 2. EARPHONE/SPEAKER VOLUME 3. EARPHONE JACK 4. DC IN 12V 5. POWER ON/OFF</p> <p>6. INPUT / OUTPUT 7. VIDEO 8. AUDIO OUT 9. AUDIO IN 10. SPDIF: Digital audio signal output jack</p>
<p>Left View</p>  <p>1. LED LIGHT 2. REMOTE CONTROL SENSOR</p>	<p>Bottom View</p>  <p>1. RELEASE LATCH (Battery pack separation switch) 2. BATTERY PACK</p>

Using the Remote Control

Installing the battery

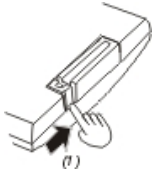

1. Press the locking tab in the arrow direction.

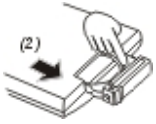

2. Pull out the battery tray.

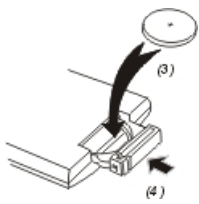

3. Insert a 3V lithium battery into the tray with the polarity (+) facing up as marked.

(4)

4. Replace the battery tray by pushing it until it clicks into place.

Using the remote control

Point the remote control directly at the remote sensor on the front of the DVD Player.



Connecting Earphones to the DVD Player

You can attach an earphone with a stereo mini-jack plug to the phone jack () for private listening. Its volume is adjustable using the VOLUME control dial. You can also connect a second earphone to the AUDIO OUT jack, but its volume cannot be adjusted.

Note: When the earphone is connected to the Phone Jack (), the speaker will be disconnected.



Notes on DSP

- The DSP decodes the digital audio signal into stereo dts or Dolby digital audio signal for speaker and earphone playback after converting the signal to analog and amplifying it.
- The 5.1 digital signal passes through without decoding and can be accessed by the SPDIF jack on the Player.

Connecting to an External Component

You can enjoy video from VCR or camcorder on your DVD player.

1. Turn off DVD player, VCR and other components.
2. Connect the audio and video cables as illustrated below.
3. Slide INPUT/OUTPUT to INPUT.
4. Turn on power.

VCR or other component equipped with external output connectors

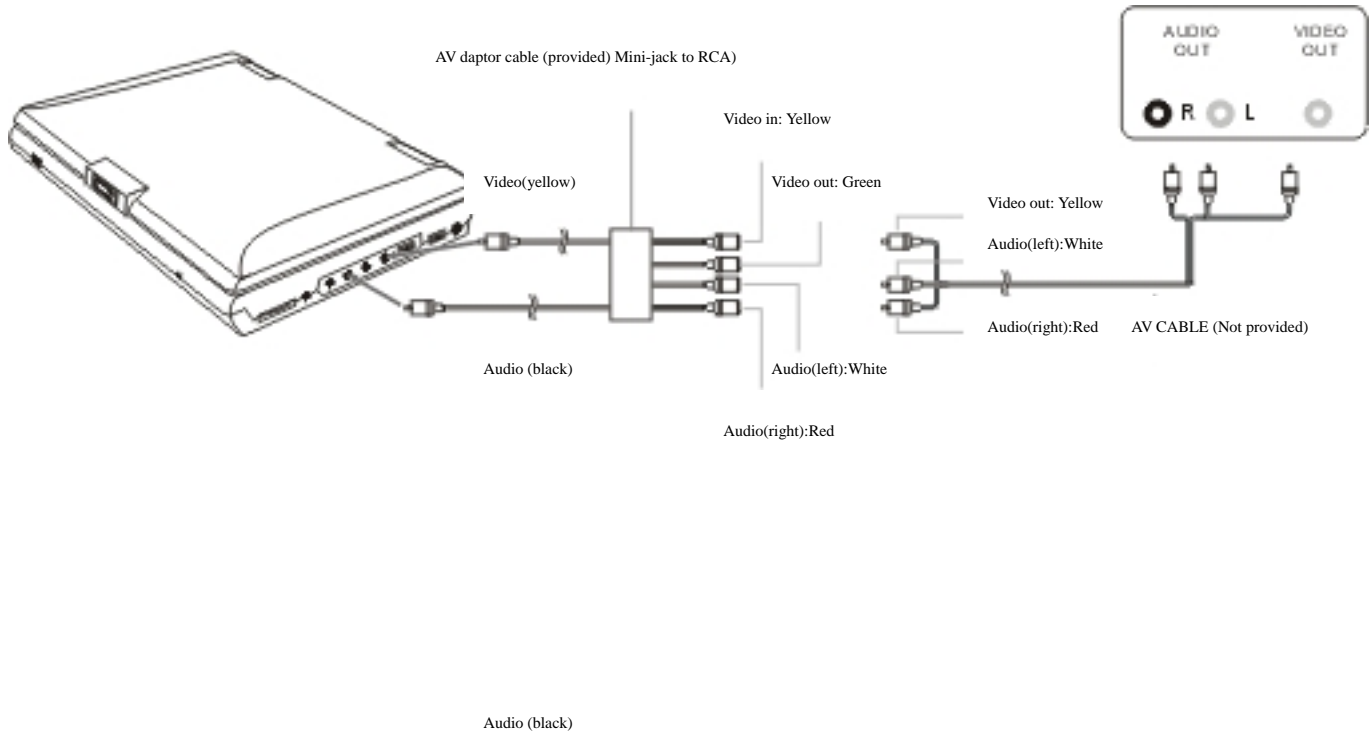

Connecting to a TV

You can enjoy DVD quality video on a TV screen.

1. Turn off DVD player and TV.
2. Connect the audio and video cables as illustrated.
3. Slide INPUT/OUTPUT to OUTPUT.
4. Turn on DVD player and TV.
5. Select corresponding Video input which is connected to DVD player.
6. Press PLAY on DVD player.

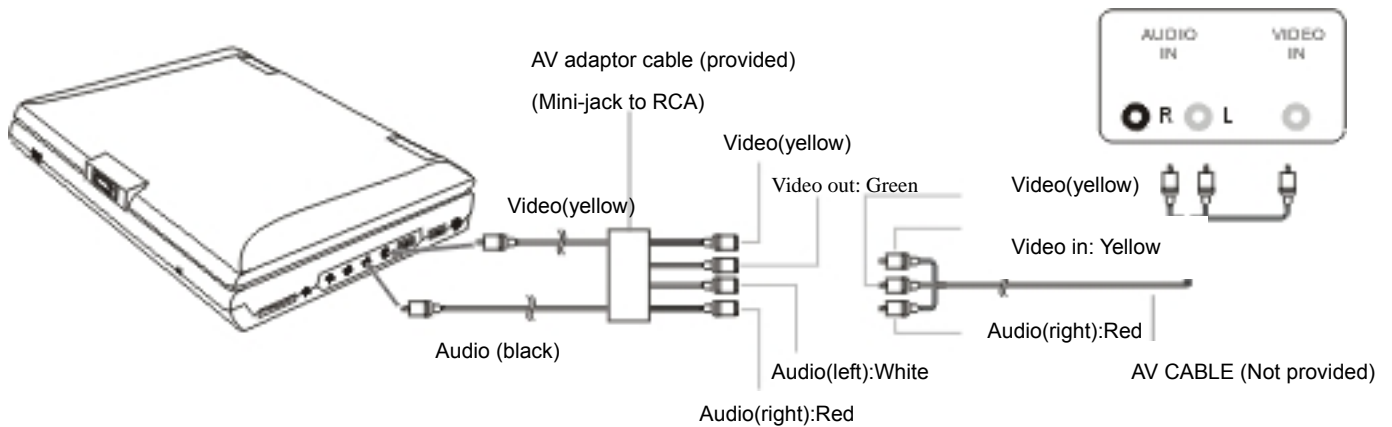

TIPS

- If you wish to view video on your TV only, close the display panel of your Player.
- With the display panel shut, use the remote to control the Player.

Connecting to a Stereo Component

By connecting the digital output (SPDIF) on the DVD player through a coaxial cable (optional accessory) to a Dolby Digital/DTS amplifier or processor, you can enjoy full 5.1 channel surround sound. Follow these steps for making the connection.

1. Turn off both DVD player and your stereo system.
2. Connect the SPDIF to your stereo system as illustrated below.
3. Slide **INPUT/OUTPUT** to **OUTPUT**.
4. Turn on power of DVD player.

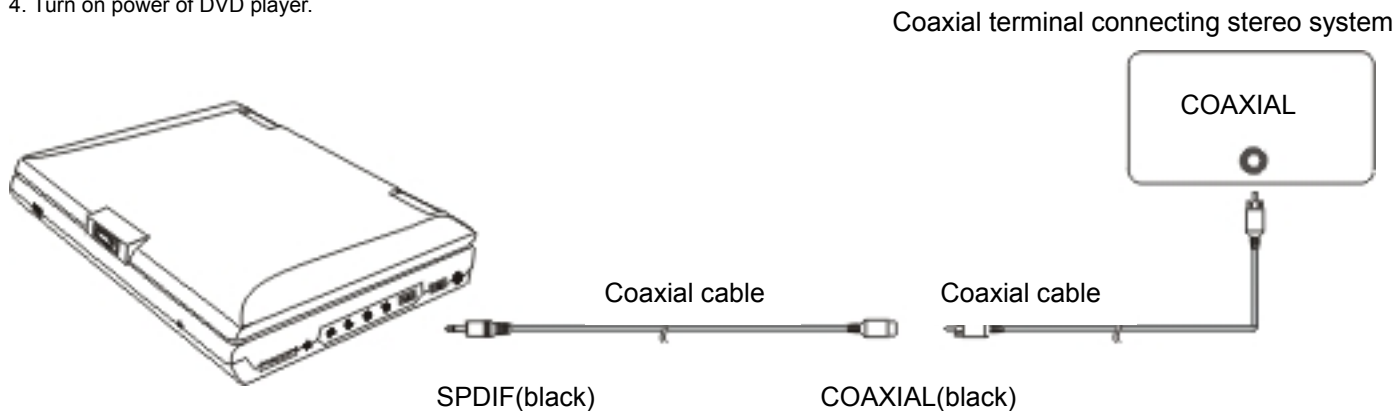

Depending on your amplifier system, you need to make the following selection from MENU:

1. Refer to Changing Audio Output on page 26.
2. Select SPDIF/RAW if your amplifier has 5.1-channel decoder.
3. Select SPDIF/PCM if your amplifier has 2 channels.
4. Select OFF, if there is no digital signal output from the DVD player.

Using the AC Adaptor

This portable DVD player can be powered by AC through the supplied switching power AC adaptor. It can also use the supplied battery pack to power.

When the AC adaptor is connected to the unit and powered, the unit will be automatically powered by the AC power.

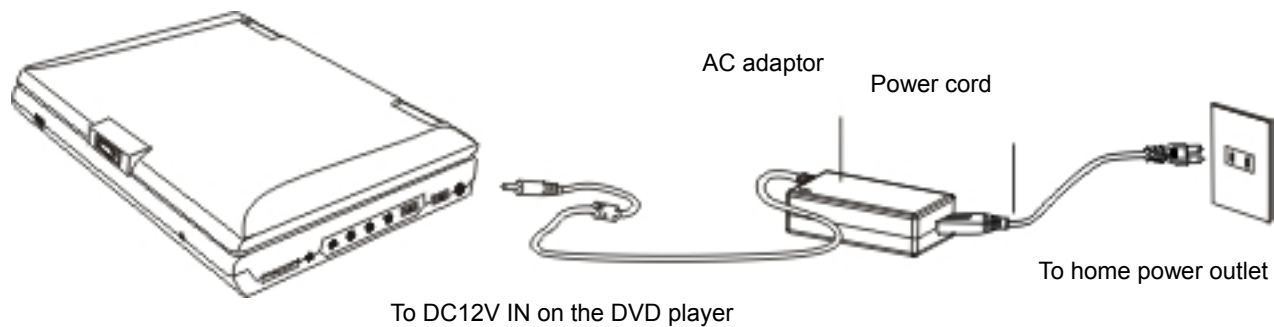

Important !

- Always turn off the DVD Player before connecting or disconnecting the AC cord.
- Only use the AC adaptor supplied with this Player. Using a different type of adaptor may cause malfunction or damage to the product.
- When the AC adaptor is used for prolonged period of time, the adaptor may heat up. This is normal and is not a cause for concern.
- When not using the adaptor, unplug it from the outlet.

Using the Battery Pack

Installing the battery pack

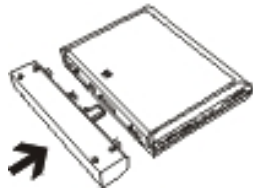

1. Align and insert the battery pack into the corresponding slots on the back of the unit.



2. Slide the battery pack to the left until it clicks into place.



1. Slide down the latch.



2. Slide the battery pack to the right, and remove.

Charging the battery pack

1. Attach the battery pack to the Player.
2. Use the AC adaptor to charge the battery pack. Make the connection as illustrated below.
3. Slide **POWER** to **ON**. (The Player must be turned on to charge the battery).

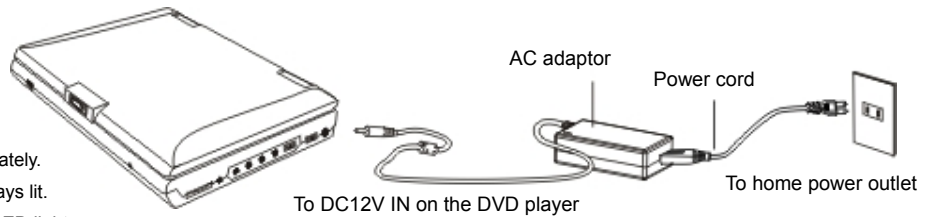

LED Indicator

- During charging, the red and green LEDs blink alternately.
- When the battery is fully charged, the orange LED stays lit.
- When the Player uses battery for power, steady red LED lights.
- If the battery power is low, the red LED blinks.

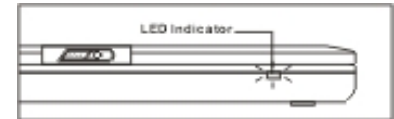

Cautions in Using Battery Pack

Danger!

Strictly follow these safety information when using the battery pack, Otherwise, a short circuit, overheating, smoke, fire, or damage to the product may result.

- Never disassemble or modify the battery pack in any way. Do not touch the terminal of the battery pack with a metal object.
- Do not place the battery pack in direct sunlight, dashboard of a vehicle, or high temperature place. It can cause explosion or fire.
- Do not expose the battery pack to water, fire, or heat.
- Always use the included AC adaptor when charging the battery pack.
- This battery pack is designed exclusively for your portable DVD player. Do not use it with other devices.

Warning!

- Do not drop or subject to strong vibration.
- Keep out of reach of children.
- The battery pack may leak fluid that is harmful to your eyes.

If this fluid gets in your eyes, wash eyes immediately with large amounts of running water and get medical attention immediately.

If the fluid gets on your skin or clothing, wash immediately with water.

Caution!

- When not using the battery pack, remove it and store in a cool place.
- Do not use the AC adaptor or battery pack for a prolonged period of time during recharging.
- Keep the battery pack free from smoke, steam, moisture, and dust.
- Using the battery pack under 0°C (32°F) or over 40°C(104°F) can cause reduced battery life.



Installing Carrying Bag/Car Harness Kit (Optional Accessory)

You can install the Carry case/Car Harness kit to a car seat to enjoy the movie in the car. Following these steps.

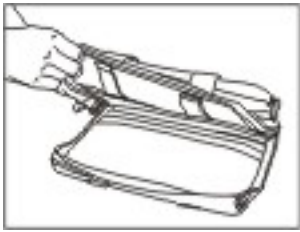

1. Unzip and open the bag.



2. Fold the top and bottom covers backwards.



3. Zip the bag closed; you have to reverse the flap to do this.



4. Case A: Without battery
Open the Player and slide it under the elastic strap and place the Player inside the bag.



5. Case A: Without battery
(1) Fold the LCD panel to upright position and pull the elastic bag over the back of the Player. (2) Place the elastic strap over the player.



6. Case B: With battery
Fold down the LCD panel and position the battery end into the net bag.



7. Case B: With battery
Open the Player and place the elastic strap over the player.

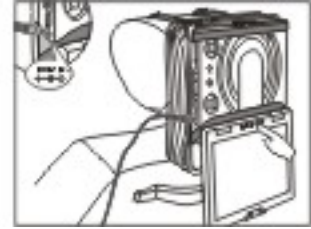

8. Attach the bag to the car seat by the two straps. Adjust the screen angle for comfortable viewing. Press the **REVERSE** button to flip the video 180 degrees. If no battery is installed, connect the DV car adapter to the Player through the side opening.

Playing a Disc

Turning the player ON /OFF

To Turn On The Player

1. Slide POWER on the Player to ON, this will put the Player on standby mode.
2. Press  on the Player to turn on the power.
3. You can also press STANDBY on the remote control to turn on the power.

To put the Player on standby mode

Press STANDBY on the remote control.

To Turn Off The Power

Slide POWER on the Player to OFF.

Preparation for Playback

1. Make sure the unit has the power either from the battery pack or the AC adaptor.
2. Loading a disc, following these steps:
 - Open the top cover by pushing the latch to the right and lift the top cover.
 - Press the OPEN button to open the disc compartment cover.
 - Place a disc into the tray with the label side facing up.
 - Close the disc cover.
3. Slide INPUT/OUTPUT to OUTPUT (located on the side of the player).
4. Turn on the Power
 - Slide POWER to ON.
 - Press STANDBY on the remote control to turn on the Player. You can also press PLAY () on the Player to turn on.

PLAY/PAUSE

Press  on the Player or PLAY/ PAUSE () on the remote control to start play.

STOP

Press  once to stop playback.

Playing a Disc (cont'd)

Slow Motion

You can only perform slow motion play in the forward direction.

1. During playback, repeatedly press SLOW to play at slower speeds.
2. To resume normal playback, press ► .

Forward / reverse speed: 1/2, 1/3, 1/4, 1/5, 1/7.

Frame-by-Frame Playback

You can only perform step play in the forward direction.

1. During playback, press || ► on the Player to pause.
2. Repeatedly press || ► to play one frame at a time.
3. To resume normal playback, press ► on the Player or ► || on the remote control.

Repeat Playback

You can play a chapter, a track, a title, a file or the entire disc repeatedly.

1. During playback, repeatedly press REPEAT to choose a Repeat option. Depending on the type of disc, the Repeat options may be different.
2. To cancel repeat playback, repeatedly press REPEAT until " REP:[OFF] " .

Mark (Bookmark)

The Mark function lets you select parts of a DVD so that you can quickly find the section at a later time.

Follow these steps to set up marker playback:

1. During playback, press MARK on the remote control.
2. Use ◀▶ to select the desired underscore.
3. When you reach the scene you want to mark, press ENTER to confirm; and the underscore changes to a number (1, 2, 3, 4 or 5).
4. Repeat the above procedure for a new scene. You can have up to 5 bookmarks.

You can perform marker playback at any time by pressing MARK, and using ◀▶ to select one of the marks, then pressing ▶ on the Player to start playing the bookmarked scene. The playback continues until the end of the disc. Repeat the above to play the other marked scenes.

Playing a Disc (cont'd)

GOTO

You can go directly to a desired chapter and play, or play at a desired point of time. Follow these steps:

To play a specific chapter:

1. Press GOTO, use ◀▶ to select title (TT) and chapter (CH) and enter the desired number.
2. Press ENTER to confirm and start play.

To play from a specific point of time:

1. Press GOTO, repeatedly press ▶ to move to the time display and it changes 00:00:00.
2. Fill in the time (hour: minute: second).
3. Press ENTER to confirm and start play.

ZOOM

1. Press ZOOM repeatedly during playback or pause to enlarge (2X, 3x, 4x,) or reduce (1/2, 1/3, 1/4) the image.
2. Use direction keys (▲▼ and ◀▶) to move around (pan and scan) the enlarged image.

Playing a Disc (cont'd)

MUTE

Repeatedly press MUTE until "MUTE" appears on the display to silence the audio. Press MUTE again to turn on audio.

MENU/PBC

Press MENU/PBC to return to the disc's Start Menu if it has the Start menu, if not, "INVALID KEY" appears. Use "TITLE" to return to the beginning of the disc if there is no Start Menu.

LANGUAGE

To switch voice language, press LANGUAGE, the currently selected language is displayed on the screen. Repeatedly press LANGUAGE to select other language if the disc has multiple languages.

You can also switch the voice language in disc menu screen by pressing MENU.

SUBTITLE

Repeatedly press SUBTITLE during playback to change the subtitle's language if the disc has multiple language subtitles. You can turn off subtitle when " OFF " is selected.

ANGLE

With DVDs featuring recordings of pictures shot from different angles, you can choose any desired viewing angle during playback.

To switch to different view angle, press ANGLE, the currently selected angle is displayed on the screen, repeatedly press ANGLE to select your desired angle

Playing a Disc (cont'd)

TITLE

Press TITLE, it takes you to the very beginning of the title and play, or to the MENU if it has title menu.

DISPLAY

Repeatedly press DISPLAY during playback to display various playback information such as current title, chapter, track elapsed time, languages etc.

L/R

This function is mostly used for karaoke (sing along) discs, by repeatedly pressing L/R, you can select STEREO, MONO (Left), MONO (Right).

P/N

This is used when you connect the Player to a TV and watch video on the TV. Repeatedly press P/N to select NTSC, PAL and AUTO to match that of your TV.

The LCD screen does not have NTSC or PAL, so if you watch video on the Player's screen, it is recommended to set to NTSC which will give a better video quality. The player will play both PAL or NTSC DVD's titles even when the Player is set to NTSC.

Playing an MP3 or Regular Audio CD

Valid MP3 CD and CD-R/RW

The MP3 files should be ISO9660 or Joliet format.
Use "mp3" as the file extension.

Play

In most cases, when a MP3 or CD is placed into the player, the first song file of the first folder plays.

In other cases, the file manger appears. Use direction keys (▲▼ and ◀▶) to select the song file and press Play ▶ on the Player or ▶|| on the remote control to play.

Playing a Picture CD

Valid Picture

The player can play both Kodak Picture CD that you order from photo processing store, and home-made CD by burning JPEG files onto a CD-R or CD-RW disc.

Play

In most cases, after the disc is placed into the player, the first file will be shown.

In other cases, the file manger appears. Use direction keys (▲▼ and ◀▶) to select the picture and press ENTER to view one picture or press PLAY on the Player or ▶|| on the remote control to start the slide show (plays photos automatically).

Press ZOOM to enlarge the photo and use ▲▼ and ◀▶ to move around the enlarged photo. The slide show function stops when you press ZOOM.

Pause

1. During playback, press ▶|| (on the remote) or ||▶ (on the player) to pause.
2. Press ▶|| (on the remote) or ▶ (on the player) to resume playback.

Next/Previous

You can manually skip to the next picture by pressing ▶▶||, and to skip to the previous picture by pressing ||◀◀.

Rotate

The picture can be rotated and flipped.

1. During playback, use direction keys (▲▼ and ◀▶) to rotate right 90 degrees, left 90 degrees, flip vertically and horizontally respectively.



Original



Rotate right 90 degrees



Flip vertically



Flip horizontally

Setting Screen and Audio

1. Press SETUP on the remote control.
2. Use the direction keys (▲▼◀▶) to select Screen Setup and its sub-menu.
3. Press ENTER or SETUP to confirm and exit.

Adjusting the Aspect Ratio

4:3 LB (Letter Box)

Displays the content of the DVD title in 16:9 aspect ratio.

The black bars will appear at the top and bottom of the screen.

4:3 PS (Pan Scan)

The left and right of the screen are cut off and displays the central portion of the 16:9 screen.



Turning on/off screen saver



Press order:
(▼, ▶)

Adjusting screen brightness



Press order:
(▼, ▶)

Adjusting screen contrast



Press order:
(▼, ▶)

Adjusting Audio



Press order:
(SETUP, ▼, ▶, ▶)

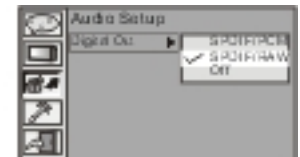
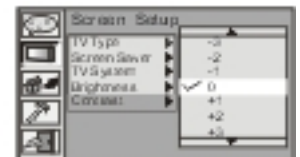
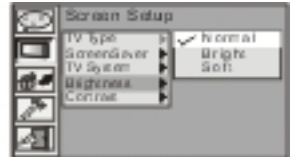
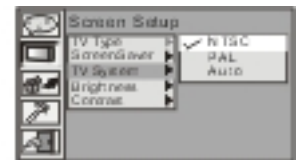

Setting Parental Control, Password, Camera Angle

1. Press SETUP on the remote control.
2. Use the direction keys (▲▼◀▶) to select Custom Setup and its sub-menu.
3. Press ENTER or SETUP to confirm and exit.

Setting parental control



Changing password

1. Use direction keys (▲▼◀▶) to select Password and press ENTER to confirm.
2. Key in your old password (8888 if this is the first use), press ENTER to confirm.
3. Key in new password and again to verify.



Turning on/off camera angle



When ON is selected, the player will display multi-angle mark on the screen if the disc has multi-angle shot.

Returning to default setting



All settings will revert to the original factory settings when Read is selected.

Setting System for TV System, Screen Saver, TV type (4:3/16:9), Password, Rating, Default, DivX(R) VOD

1. Press SETUP on the remote control.
2. Use the direction keys (▲▼◀▶) to select SYSTEM SETUP and its sub-menu.
3. Press ENTER to confirm your selection.
4. Press SETUP to exit, or select EXIT SETUP to exit.

Selecting TV system



Turning on/off screen saver



TV type 4:3 or 16:9

4:3 LB (Letter Box)

Displays the content of the DVD title in 16:9 aspect ratio.

The black bars will appear at the top and bottom of the screen.

4:3 PS(Pan Scan)

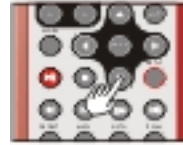

Changing password

1. Use direction keys (▲▼◀▶) to select Password and press ENTER to confirm.
2. Key in your old password (888888 if this is the first use). Press ENTER to confirm.
3. Key in new password and press ENTER to confirm.



Setting System for TV System, Screen Saver, TV Type (4:3/16:9), Password, Rating, Default, DivX(R) VOD (cont'd)

1. Press SETUP on the remote control.
2. Use the direction keys(▲▼◀▶) to select SYSTEM SETUP and its sub-menu.
3. Press ENTER to confirm your selection.
4. Press SETUP to exit, or select EXIT SETUP to exit.

Adjusting rating

1. Go to PASSWORD and enter the password to open the lock for Rating, the " " shows
2. Go to RATING and select the rating.
3. Go back to PASSWORD and enter the password again to lock the Rating, the " " shows.

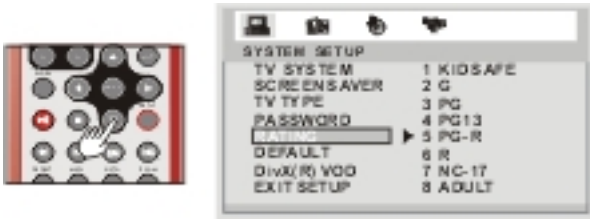

Returning to default setting



All settings will revert to the original factory settings when RESTORE is selected.

Displaying DivX registration number

1. Go to DivX(R) VOD.



2. Press ENTER to show the registration number.

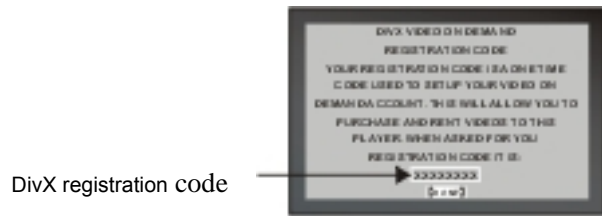

3. Move down to [DONE] and press ENTER to return

FEATURE

1. Official DivX Certified product?
2. Plays DivX@5, DivX@4, DivX@3, and DivX@VOD video content.

Setting Language for OSD, Voice, Subtitle, Menu

Although this Player supports a list of different languages for OSD, subtitle and voice, the disc must have the specific language(s) built-in in order to effect the multi-language function of this Player.

1. Press SETUP on the remote control.
2. Use the direction keys (▲▼◀▶) to select LANGUAGE SETUP and its sub-menu.
3. Press ENTER to confirm your selection.
4. Press SETUP to exit, or select EXIT SETUP to exit.

Changing OSD language



Changing subtitle language



Changing voice language



Changing menu language



Setting Audio Output

1. Press SETUP on the remote control.
2. Use the direction keys (▲▼◀▶) to select Audio Setup and its sub-menu.
3. Press ENTER or SETUP to confirm and exit.

Changing AUDIO output



Note:

SPDIF/OFF: select this when you do not want to have digital audio signal output.

SPDIF/RAW: select this when the digital audio output is connected to an external amplifier with Dolby Digital or DTS decoder which gives 5.1 channel sound.

SPDIF/PCM: select this when the external amplifier has no decoder.

Setting Video for Brightness, Contrast, Hue, Saturation

1. Press SETUP on the remote control.
2. Use the direction keys (▲▼◀▶) to select Video Setup and its sub-menu.
3. Press ENTER or SETUP to confirm and exit.

Adjusting brightness



Adjusting hue



Adjusting contrast



Adjusting saturation



Adjusting LCD Screen

Following these steps to adjust the LCD quality during playback or while paused,

1. Repeatedly press MODE on the screen panel to select the parameters listed in the menu.
You can change BRIGHTNESS, CONTRAST, SHARPNESS, COLOR and TINT.
2. Repeatedly press (or hold down) UP and DOWN to change the setting of the parameter selected.
3. To reset the setting to its defaulted value, select RESET by repeatedly pressing MODE then press UP or DOWN to confirm.

Note: If no key is pressed in 9 seconds, the Menu disappears.

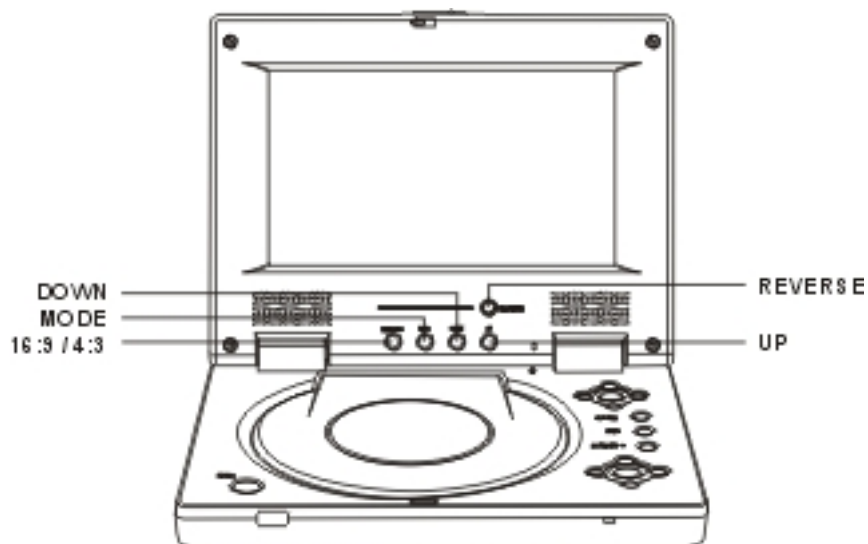

Troubleshooting

If your DVD player does not seem to be functioning properly, check the items below before you contact a service center.

Symptom	Check
Power does not turn on or suddenly turns off	Make sure the AC Power cord is securely plugged into an AC outlet. Turn the power off and then back on.
Battery pack is in place but the power does not turn on or suddenly turns off	Check that the battery pack is charged. If not, recharge it.
Remote control does not work	Check that the battery is inserted in the "+" and "-" directions properly. The batteries may be dead. Replace them with new batteries. Check that the signal transmission is directed at the remote control sensor on the DVD player.
Disc does not play	Check that the disc is a DVD, DVD-RW, VIDEO CD, or AUDIO CD. Do not use a disc that has scratches or dirt. Check that the label-side of the disc is facing up. The pick-up lens of the DVD player may be dirty. Contact the service center for lens cleaning.
No picture	Check if the LCD on/off switch is stuck, and cannot move freely when the top cover is open.
No picture and sound	Check INPUT/OUTPUT is switched to OUTPUT not INPUT. With power turned on, slide INPUT/OUTPUT once.
No sound	Check the volume setting. If set to zero, turn up volume level. Check that the headphones are plugged into the PHONES and Audio jack. Speakers cannot be used with the headphones.

Troubleshooting

Symptom	Check
While in the input mode, no picture is output from the external component to the DVD player	Check that the video or audio cable is securely connected. Check that the DVD player is in the INPUT mode and in the DVD mode.
Battery pack won't charge	Check that the DVD player is turned on. You cannot charge the battery pack with the player turned off. A hot battery pack may take longer to charge. Wait until the battery pack is sufficiently cooled down.
Charging LED indicator does not light	Check with another fully charged pack if the LED lights. Check that the AC adaptor is securely plugged in. If DVD or battery pack is overheated, you will not be able to charge the battery pack.
On charging the depleted battery, the red and green LED charging indicators quickly light, indicating battery is fully charged, but in fact it is not	Disconnect the AC adaptor and reconnect to make sure the connection is OK. Use another battery pack, if the same symptom occurs, the AC adaptor may be defective. If the second battery pack charges without any problem, your first battery pack may be defective.

Specifications

General	Power Requirements	Input AC 100V~240V, 50/60 Hz, Output DC 12V
	Power Consumption	≤15 W
	Weight	931.5g (without battery pack) 2.05 lbs (without battery pack)
	Dimensions	206mm (W) x 158.5mm (D) x 39.7mm (H) 8.1" (W) x 6.2" (D) x 1.5" (H)
	Operating Temperature Range	+10°C ~ +40°C +50°F ~ +105°F
Readable Disc	DVD, DVD-R, DVD+R, DVD-RW, DVD+RW, VCD, SVCD, DVCD, MP3, PICTURE CD, CD, CD-G, HDCD, CD-R, CD-RW, MPEG4, DivX Video, MPEG4, DivX Video	
Video Output	Composite Video	1 channel :1.0 Vp-p (75 Ω load)
Audio Output	2 Channel	L(1/L), R(2/R)
	Frequency Response	20Hz - 20kHz ±2.5dB
	S/N Ratio	≥85 dB
	Dynamic Range	≥85 dB

Battery Specifications

ITEM	SPECIFICATION
Nominal Voltage	7.2V
Capacity	Minimum 4200 mAh
Charge Voltage	8.400 ±0.05V
Max Charge Current	4A
Use Time	2.5HR
Charge time in Full	4.5HR

Operating environment

Charge	0°C ~ +45°C	+32°F ~ +113°F
Discharge	-20°C ~ +60°C	-4°F ~ +140°F
Store less than 1 month	-20°C ~ +60°C	-4°F ~ +140°F
Store less than 3 months	-20°C ~ +45°C	-4°F ~ +113°F
Store less than 1 year	-20°C ~ +25°C	-4°F ~ +77°F

- The specifications are subject to change without notice.
- Weight and dimensions are approximate.

Customer Support and Warranty

Customer Support

For installation, usage and repair assistance for both the Warranty and post-Warranty periods, go to <http://www.avayon.com/support> to access customer support.

Warranty

AVAYON Technologies, Inc.

DVD/DivX Player One-Year Limited Warranty

NOTE: BEFORE YOU CONTACT AVAYON FOR WARRANTY SUPPORT PLEASE READ YOUR USER MANUAL.

Players purchased from AVAYON in the United States are warranted to be free from defects in materials or workmanship for a period of one (1) year ("Warranty Period") from the date of their original retail purchase ("Effective Date"). If the player fails to conform to this warranty, AVAYON will repair the Player using new or refurbished parts or replace the entire Player with a new or refurbished Player.

TO ENSURE WARRANTY SERVICE, KEEP THE DATED SALES RECEIPT AS EVIDENCE OF THE PURCHASE DATE. Also, be sure to register for warranty either through returning the completed mail-in card found in the shipment box or on line at www.avayon.com/support.

To obtain warranty service in the U. S., you must also go to www.avayon.com/support and access customer support. You will be required to provide the model, serial number, and date of purchase.

AVAYON retains the right to assess all warranty claims and to determine if damages are covered by this warranty. In case of a claim that is not covered by the warranty, you will be contacted to determine if AVAYON should repair the damage for a fee or if the player should be returned to you as received by the service center.

Customer Support and Warranty (cont'd)

During a period of ninety (90) days from the Effective Date, AVAYON will provide service labor to repair a manufacturing defect at its designated service center at no charge to you. If a defective part is replaced after ninety (90) days from the Effective Date, you pay labor charges for the repair.

For one (1) year from the Effective Date, AVAYON will use new or refurbished parts for repairs. Such replacement parts are warranted for the remaining portion of the original Warranty Period.

During the Warranty Period, AVAYON will, at its option and sole discretion, repair or replace defective parts, including replacement of the entire Player. You will be required to ship the player to the service center indicated at the time you contact AVAYON customer service for warranty support. You are responsible for all transportation charges to and from the service center and for all loss or damage during transport. AVAYON is not responsible for the de-installation or re-installation of the player.

WHAT IS NOT COVERED BY THIS ONE-YEAR LIMITED WARRANTY

This warranty does not cover defects, malfunctions or failures resulting from shipping or transit accidents, abuse, misuse, operation contrary to furnished instructions, operation on incorrect power supplies, operation with faulty associated equipment, modification, alteration, improper servicing from anyone other than an AVAYON authorized service center, tampering, normal wear and tear, if the serial number has been removed/defaced or deterioration of the external cabinet.

ANY IMPLIED WARRANTIES, INCLUDING ANY IMPLIED WARRANTY OF MERCHANTABILITY AND FITNESS FOR A PARTICULAR PURPOSE SHALL BE LIMITED IN DURATION TO THE PERIOD OF TIME SET FORTH ABOVE. AVAYON'S LIABILITY FOR ANY AND ALL LOSSES AND DAMAGES RESULTING FROM ANY CAUSE WHATSOEVER, INCLUDING OUR NEGLIGENCE, ALLEGED DAMAGE OR DEFECTIVE GOODS, WHETHER SUCH DEFECTS ARE DISCOVERABLE OR LATENT, SHALL IN NO EVENT EXCEED THE PURCHASE PRICE OF THE PLAYER. WE SHALL NOT BE RESPONSIBLE FOR LOSS OF USE, COMMERCIAL LOSS OR OTHER INCIDENTAL OR CONSEQUENTIAL DAMAGES.

Free Manuals Download Website

<http://myh66.com>

<http://usermanuals.us>

<http://www.somanuals.com>

<http://www.4manuals.cc>

<http://www.manual-lib.com>

<http://www.404manual.com>

<http://www.luxmanual.com>

<http://aubethermostatmanual.com>

Golf course search by state

<http://golfingnear.com>

Email search by domain

<http://emailbydomain.com>

Auto manuals search

<http://auto.somanuals.com>

TV manuals search

<http://tv.somanuals.com>