

# B & K

WE SIMPLY SOUND BETTER.

**B&K Components, Ltd.**

**AVR202 Plus**

**A/V Receiver**

**Owner's Manual**

# USER INFORMATION

Model # \_\_\_\_\_  
Serial # \_\_\_\_\_  
Date purchased \_\_\_\_\_  
Purchased from: \_\_\_\_\_  
City \_\_\_\_\_  
State \_\_\_\_\_  
Phone \_\_\_\_\_  
Contact \_\_\_\_\_

**SETUP SPEAKER SIZE**

1 Front \_\_\_\_\_  
2 Center \_\_\_\_\_  
3 Surround \_\_\_\_\_  
4 Surround Back \_\_\_\_\_  
5 Subwoofer \_\_\_\_\_

↑ ↓ next item      adjust ← →  
MENU setup speakers

**SPEAKER LOCATION**      feet

1 Left Front \_\_\_\_\_  
2 Center \_\_\_\_\_  
3 Right Front \_\_\_\_\_  
4 Right Surround \_\_\_\_\_  
5 Right Surr Back \_\_\_\_\_  
6 Left Surr Back \_\_\_\_\_  
7 Left Surround \_\_\_\_\_  
8 Subwoofer \_\_\_\_\_

↑ ↓ next item      adjust ← →  
MENU setup speakers

**SETUP SPEAKER LEVELS**

1 Left Front \_\_\_\_\_ dB  
2 Center \_\_\_\_\_ dB  
3 Right Front \_\_\_\_\_ dB  
4 Right Surround \_\_\_\_\_ dB  
5 Right Surr Back \_\_\_\_\_ dB  
6 Left Surr Back \_\_\_\_\_ dB  
7 Left Surround \_\_\_\_\_ dB  
8 Subwoofer \_\_\_\_\_ dB

↑ ↓ next item      adjust ← →  
MENU setup speakers

**SETUP CROSSOVERS + LFE**

1 Crossover \_\_\_\_\_ Hz  
2 High Pass \_\_\_\_\_ dB  
3 Low Pass \_\_\_\_\_ dB  
4 Peak Limiter \_\_\_\_\_ dB  
5 LFE Level \_\_\_\_\_ dB  
6 DTS LFE Mode \_\_\_\_\_  
7 Subwoofer Phase \_\_\_\_\_

↑ ↓ next item      adjust ← →  
MENU setup speakers

**SETUP ROOM EQUALIZATION**

Test Tone    20 Hz      Off  
Notch      \_\_\_\_\_ Hz    \_\_\_\_ dB  
Notch Width \_\_\_\_\_ Hz  
Bass      \_\_\_\_\_ Hz    \_\_\_\_ dB  
Treble      \_\_\_\_\_ Hz    \_\_\_\_ dB

↑ ↓ next item      adjust ← →  
MENU setup speakers

# TABLE OF CONTENTS

User Information .....	ii
Table of Contents .....	iii
Acknowledgments .....	2
Safety Precautions .....	3
Features .....	4
The Basics .....	5
Front panel .....	9
Rear Panel .....	11
<b>Making the connection.....</b>	<b>13</b>
Audio / Video connections .....	14
Digital Connections .....	16
Surround Outputs .....	17
Speaker Outputs .....	18
Antenna Connections .....	19
Control Outputs / IR Inputs .....	19
Frequently Asked Questions .....	20
<b>Setup.....</b>	<b>22</b>
The Menu System .....	22
System Setup .....	23
Speakers .....	23
Speaker Size .....	23
Speaker Location .....	27
Speaker Levels .....	28
Crossovers + LFE .....	29
Room Equalization .....	33
Display .....	36
Inputs .....	39
Presets .....	43
Memory Backup .....	45
<b>Operation.....</b>	<b>46</b>
Power On/Off .....	46
Sleep .....	46
Choosing a source .....	47
AM/FM Tuner .....	47
Adjusting the Volume .....	48
Temporary Level Adjustments .....	48
Audio Modes .....	49
MONO .....	50
STEREO .....	50
SURROUND .....	50
DVD Audio .....	50
Special Considerations .....	50
Equalization 'EQ' .....	52
Zone 'Z' .....	54
Presets .....	55
Zone 1 (A) .....	56
Zone 2 (B) .....	57
Zone 1 Favorite Presets .....	58
Zone 2 Favorite Presets .....	59
Getting Receiver Status .....	60
<b>Advanced Features.....</b>	<b>61</b>
Advanced .....	61
Zone 1 Setup (A) .....	61
Zone 2 Setup (B) .....	64
Power On Titles .....	68
Control Outputs .....	68
Setup Control Out 1 .....	69
Setup Control Out 2 .....	69

<i>Setup Control Out 3</i> .....	70
<i>Setup Control Out 4</i> .....	70
<i>Security Options</i> .....	71
<i>DSP Usage</i> .....	73
<i>RS-232 Control Port</i> .....	73
Factory Reset .....	75
<b>Troubleshooting</b> .....	<b>76</b>
<b>Receiver Specifications</b> .....	<b>77</b>
<b>Returning Equipment</b> .....	<b>78</b>
<b>Rear Panel Enlarged View</b> .....	<b>79</b>
<b>The Menu System</b> .....	<b>80</b>

# ACKNOWLEDGMENTS

Motorola® ,  , “ \* DigitalDNA™, “Powered by Motorola”™, Motorola name and logo are registered trademarks of Motorola, Inc.

Manufactured under license from Dolby Laboratories. “Dolby”, “Pro Logic”, “AC-3”, and the double-D symbol are trademarks of Dolby Laboratories. Confidential Unpublished Works. © 1992-1997 Dolby Laboratories, Inc. All rights reserved.

Surround EX is a trademark of Dolby Laboratories. Used under authorization.

DTS® is a registered trademark of Digital Theater Systems, LLC. Additionally licensed under the following US Patent 5,451,942 & National Patent applications derived from PCT/US95/00959. Additional U.S. and Foreign Patents pending. “DTS”, “digital sound”, and “coherent acoustics” logos are trademarks of DTS Technology LLC. All rights reserved.

Manufactured under license from Lucasfilm Ltd. U.S. patent numbers 5,043,970; 5,189,703; and/or 5,222,059. European patent number 0 323 830. Other U.S. and foreign patents pending. Lucasfilm and THX are registered trademarks of Lucasfilm Ltd. Surround EX is a trademark of Dolby Laboratories. Used under authorization.

THX, Home THX Cinema, Lucasfilm THX, Re-Equalization, Timbre Matching, Adaptive Decorrelation and THX Ultra are registered trademarks of Lucasfilm Ltd.

**The AVR202 Plus** A/V Receiver with five 105 watts into 8 ohms channels of power amplification. Additionally, the AVR202 Plus incorporates further processing to allow for the precise decoding of Dolby Digital Surround EX and DTS-ES soundtracks via matrix decoding.

**Accessories included:** Owners manual, Remote control Manual, Power cord, Remote control, 4-AAA batteries

# SAFETY PRECAUTIONS



**CAUTION**  
RISK OF ELECTRIC SHOCK  
DO NOT OPEN



## PLEASE READ BEFORE INSTALLING

**WARNING:** to prevent fire or shock hazard, do not expose this unit to rain or moisture. Care should be taken to prevent objects or liquid from entering the enclosure. Never handle the power cord with wet hands.

The lightning flash with arrowhead, within an equilateral triangle, is intended to alert the user of the presence of uninsulated "dangerous voltage" within the product's enclosure that may constitute a risk of electric shock to you.

The exclamation point within an equilateral triangle is intended to alert the user of the presence of important operating and maintenance (servicing) instructions in the literature accompanying the unit.

**Caution:** To prevent the risk of electric shock, do not remove cover. No user-serviceable *parts inside*. Refer servicing to *qualified service personnel*.

If an outdoor antenna is connected to the antenna input, be sure it is grounded to provide some protection against voltage surges and built up static charges. Keep the outdoor antenna away from power lines.

Unplug the receiver from the AC outlet when plugging in or unplugging cables, when left unused for an extended period of time, moving the receiver, or when you suspect lightning in your area.

Prevent damage to the power cord. Do not bend, pull, place objects on, alter, etc. Replace the power cord if it becomes damaged. Always grasp the plug on the power cord when plugging in or unplugging the receiver from the AC outlet.

Your system may produce sound levels capable of causing permanent hearing loss. Do not operate for extended periods of time at high volume levels.

Make sure the receiver is placed on a level surface.

Protect the receiver from impact. (Do not drop it!!!)

Do not climb on top of the receiver or place heavy objects on its top cover.

The receiver is equipped with raised feet to provide ventilation, reduce acoustic feedback, and provide protection against scratching the surface the unit is resting on. We advise against removing or altering feet.

Do not stack anything on top of the receiver (processor, source, etc.) Leave a minimum of 3" clearance from the top of the receiver to the next shelf (or component).

The receiver should be located away from heat sources such as heaters or amplifiers.

Do not perform any internal modifications to the receiver.

Always connect the receiver's power cord to an unswitched AC outlet for normal operation.

If young children are present, adult supervision should be provided until the children are capable of following all rules for safe operation.

Do not plug the receiver's power cord into an outlet with an unreasonable number of other devices. Be careful if using extension cords and ensure the total power used by all devices does not exceed the power rating (watts/amperes) of the extension cord. Excessive loads may cause the insulation on the cord to heat and possibly melt.

Mistaking **CONTROL OUTPUT** or **IR INPUT** connectors for audio/video inputs or outputs may damage your receiver or other components.

Damage can occur to your speakers if the power rating of each individual driver is exceeded by the receiver. Ensure that all the drivers in your system are capable of handling not only the average power being delivered by the amplifiers, but also the peak power that is likely to be generated during strong passages. If you are unsure of your speaker's power rating, contact the speaker manufacturer or the dealer where you purchased them.

The receiver should be serviced by qualified personnel when:

- A. The receiver is not functioning properly.
- B. Objects have entered the chassis.
- C. The receiver was exposed to rain or other type of moisture.
- D. The receiver was dropped, or the chassis is damaged.

# FEATURES

Your new receiver is a versatile audio/video control center. The receiver is designed to sound sensational and be an attractive, easy-to-use addition to your audio/video system. Although you already have a good idea of your receiver's features, we would like to take a moment to point out certain highlights.

**Matrix Decoding** - incorporates further processing to allow for the precise decoding of Dolby Digital Surround EX and DTS-ES soundtracks via matrix decoding.

**Two-zone operation** - complete digital/analog preamp/processor for Zone 1 (A) plus an additional independent analog A/V preamp internally for use with a second listening/viewing area - Zone 2 (B).

**Internal Digitally Synthesized AM/FM Stereo tuner** - store up to 40 AM or FM stations in A/V presets.

**Analog inputs/outputs** - seven A/V inputs and five A/V outputs **all** with stereo audio, composite video and S-video plus one set of 7.1 surround outputs.

**Digital inputs/outputs** - six coaxial inputs and one coaxial output plus five optical inputs and one optical output.

**Control Outputs** - four 12 VDC @ 50 mA outputs for turning on amplifiers and controlling external systems such as a projection screen or B & K amplifier.

**IR inputs/outputs** - two IR inputs and up to four IR outputs let you integrate the receiver with an infrared repeater control system.

**Gold Plated Connectors** - better sound with minimum signal loss and degradation.

**Plug and Play operation** - automatically selects the optimum input, surround sound format, and performs a wide range of automated functions to provide invisible and easy operation.

**A/V presets** - 40 favorite preset memories allow instant configuration and recall of user settings.

**Customized input and A/V preset names** - assign names to presets, inputs, or the turn on message.

**Remote Control** - designed to interface with standard or learning B&K multi-source universal remote controls, allows total control of B&K and/or other brand user equipment.

**RS-232 Control** - easy control and interface of your B&K product with other system controllers.

## **State-of-the-art power amplifier section -**

- Toroidal transformer and computer-grade electrolytic capacitors combine to provide for improved dynamics and extended low frequency control.
- Discrete Circuitry for more accurate, 3-dimensional reproduction.
- Class A Predriver improves low level detail for smoother, more musical sound.
- AB MOSFET Output Stage for efficient and linear power delivery.

**96/24 bit A/D and D/A Conversion** - Ultra High Resolution reproduction of musical details.

**96/24 bit processing** - 96/24 bit digital data and analog source material use 96 kHz, 24 bit DSP processing during all stereo listening modes.

**Selectable Bass Management Crossover Frequency and Slope** - allows system versatility for bass adjustments and management to assure optimum performance from your speaker system.

**Room Equalization** - a sweepable notch filter and variable equalization is available in the digital domain for use in achieving the best possible room response.

**Upgradable** - modular design allows for future A/D, D/A, DSP and Digital Receiver. State of the art today, state of the art tomorrow.

# THE BASICS

The following is intended to familiarize users with common terms and applications of Home Theater equipment.

**Sources** - your receiver can directly provide audio from its built-in AM/FM tuner. It can also provide limited video from its on-screen menu system. Typically you will want to connect a number of additional sources (VCR, DVD player, etc.) to your receiver. Your receiver is designed to accommodate a wide range of audio and video signals.

The following table lists the most popular home theater media and how the audio information is stored.

Source Media	Analog	PCM	Dolby Digital	DTS
Audio Cassette	X			
Video Cassette	X			
Laser disc (LD)	X	X	X	X
Compact Disc (CD)		X	X	X
Digital Versatile Disc (DVD)		X	X	X
Satellite Broadcast		X	X	
Digital Audio Tape (DAT)	X	X	X	X
Digital Compact Cassette (DCC)		X (compressed)		
Mini disc (MD)		X (compressed)		

**Analog vs. Digital Audio** - This refers to the method used to place audio information on the source material and how they are delivered to your receiver from the source. Analog signals exactly represent the sound you will hear through a continuously varying voltage. Audio and video cassettes are analog recordings and are normally delivered to your receiver over a pair of coaxial audio cables.

Digital signals closely approximate the original audio signals with a set of numbers referred to as a bitstream. CDs and DVDs are sources of digital audio and are normally connected to your receiver through a coaxial or optical digital cable. There are several different bitstream formats available. The simplest format is called Pulse Code Modulation (PCM). In PCM, the bitstream directly represents the original 2-channel audio. In Dolby Digital and DTS (see "Surround Formats" below) bitstreams are modified using a process called compression to squeeze more information into limited space. DTS squeezes 5.1 channels into the space normally required for two uncompressed channels, while Dolby Digital squeezes 5.1 channels into about 1/4 the space required for two channels. Your receiver automatically detects the bitstream currently being provided from the source and performs the required decompression and surround processing. If no digital signal is present your receiver will automatically switch to analog processing.

All sounds that you hear from your speakers are analog. Digital signals are automatically converted to analog by your receiver before being output to your the speakers.

*If analog signals exactly represent the audio, while digital signals only approximate it, why would I want to use digital?*

All analog sources add some amount of noise and distortion to the audio signal. Additional noise can be picked up through the cables from the source to your receiver. It is impossible for the receiver to tell the difference between the desired signal and the added noise and distortion, so it reproduces both of them. The result is increased background noise and decreased dynamic range and fidelity. Digital signals are virtually immune to noise and distortion. The receiver can, therefore, reproduce the signal with the greatest possible fidelity. We recommend you use digital signals wherever possible. Also Dolby Digital and DTS (see "Surround Formats" below) work only with digital signals.

**Audio and Surround Formats** - Your source material will be in one of seven possible formats described below.

**Monaural (Mono)** - This is the oldest format available. It contains a single, full range audio channel. Modern recordings are seldom made in this format, but most older movies and music are available only in this format. You may get mono from any source - digital or analog. Sound will normally come from the seven speaker channels, but your receiver can produce mono in one to seven channels (see "Audio Modes under Operation"). Since all modern sources are stereo, the mono information is usually replicated from both the left and right channels.



**Stereo** - Stereo contains two discrete, front left and right full range audio channels. This is the most common format for music and is also used on many movies. You may get stereo from any source - digital or analog. Sound will normally come from the seven speaker channels, but your receiver can produce stereo in one (mono) to seven channels (see "Audio Modes under Operation").

**Dolby Pro Logic** - Dolby Pro Logic is a refinement of Dolby Surround which was the earliest form of true surround processing. Like Stereo, Dolby Surround contains two discrete, full range audio channels. In addition, a monaural, limited range surround channel is encoded on the two stereo channels in a process called matrixing. The surround channel information is encoded in positive polarity on the left channel and in negative polarity on the right channel. The Dolby Processor can detect this encoding (left minus right) and send that information to the surround channels. Dolby Pro Logic adds additional processing to produce a full range center channel by extracting the mono information from the left and right channel. This is the most common format for all but the most recent movies. Music sources are occasionally encoded in Dolby Surround. However, many people prefer to use Pro Logic processing on all of their stereo sources. The center channel extraction process often yields improved stereo imaging, especially when you are sitting away from the "sweet spot" at center of the listening area. The surround channel processing often lends a pleasing ambiance even to material that is not encoded in Dolby Surround. Dolby Pro Logic is fully compatible with stereo and you may get it from any source - digital or analog. Sound will normally come from all seven speakers in your system, but your receiver can produce sound in one (mono) to seven channels (see "Audio Modes under Operation").

**Dolby Digital** - Dolby Digital contains up to five discrete, full range audio channels plus an additional Low Frequency Effects (LFE) channel. The LFE channel contains only low frequency information for enhanced sound effects in movies. This combination of five discrete channels plus a LFE channel is often referred to as 5.1 channels. Dolby Digital is a digital format only. It must be delivered to your receiver over a coaxial or optical digital cable. As of the writing of this manual, Dolby Digital is commercially available on DVD and Satellite (Also see *Dolby Digital RF* below). It is also possible to create your own Dolby Digital CDs and DATs if you have the recording equipment. You can't directly record Dolby Digital onto mini disc or digital compact cassette since these devices add their own compression which is incompatible with the Dolby Digital compression. Not all Dolby Digital recordings will include all five channels, and, in fact, it is common on DVDs to have two channel Dolby Digital with or without Pro Logic processing. Sound will normally come from all seven speakers in your system, but your receiver can produce sound in one (mono) to seven channels (see "Audio Modes under Operation").

**Dolby Digital RF** - Dolby Digital RF is identical to normal Dolby Digital except that it uses a special RF encoding scheme to put the bitstream on Laser discs without replacing the normal stereo (or Dolby Surround) PCM bitstream that is normally available from laser disc. In order to use Dolby Digital RF laser discs you must have a B&K DT-1 RF demodulator or similar product from another manufacturer. For best results with your receivers Plug and Play capability we recommend the B&K DT-1.

**Dolby Digital Surround EX** - Dolby Digital Surround EX is a new movie sound track that greatly enhances the sense of spatial and positioning of the surround channel sound. This system was developed jointly by Lucasfilm THX and Dolby Laboratories, using Lucas film's idea of improving spatial expression and achieving a 360 degree sound positioning with Dolby Laboratories' matrix encoding technology. The surround back channel is matrix-encoded and inserted into both Dolby Digital SL (surround left) and Dolby Digital SR (surround right) channels. Upon playback, the signals may be decoded by a high precision digital matrix decoder within the Dolby Digital decoder into SL, SR and SB channels.

**DTS (Digital Theater Systems)** - DTS is similar to Dolby Digital in that it provides 5.1 discrete audio channels. However, it uses more digital data to encode the information and may provide greater fidelity than Dolby Digital. DTS is a digital format only. It must be delivered to your receiver over a coaxial or optical digital cable. No RF demodulator is required for DTS laser discs since the DTS bitstream replaces the normal PCM bitstream. Like Dolby Digital, you can create your own DTS DATs or CDs but not mini disc or digital compact cassette. As with Dolby Digital, sound will normally come from all seven speakers in your system, but your receiver can produce sound in one (mono) to seven channels (see "Audio Modes under Operation").

**DVD Audio (also referred to as MLP)** - Meridian Lossless Packing (MLP) is a lossless coding system for high-quality linear PCM audio. For DVD-Audio MLP performs lossless compression of up to 6 channels of up to 24-bit material sampled at rates between 44.1kHz and 192kHz. Lossless coding does not alter the final signal, it 'packs' the audio data into a smaller rate and space. Currently, DVD Audio can only be delivered to your processor via the 6 coaxial digital inputs. The coax digital inputs may be configured internally for use as an analog 5.1 input. Sound will normally come from all seven speakers in your system, but your processor can produce sound in one (mono) to seven channels (see "Audio Modes under Operation").

**Home THX Cinema Processing** - THX is an exclusive set of standards and technologies established by the world-renowned film production company, Lucasfilm Ltd. THX grew from George Lucas' personal desire to make your experience of the film soundtrack, in both movie and in your home theater, as faithful as possible to whatever the director intended. **Currently, the AVR202 Plus does not support Home THX Cinema Processing.**

**Bass Management** - Dolby Digital and DTS formats contain up to 5 full range channels plus LFE. Only a system with five full-range (large) speakers plus a subwoofer can directly reproduce these formats. However, almost all commercially available center channel speakers are small and incapable of reproducing the lowest bass frequencies without distortion or even damage to the speaker. Many people also use small speakers in the rear of their system, while others use small speakers all around. Use of a subwoofer is almost mandatory when using five small speakers, but people with at least two large speakers may or may not choose to use a subwoofer. Some people may not use a center channel or surround speakers at all. In order to handle any possible combination of large, small, or missing speakers, a home theater system must contain good bass management, a concept often missing from two-piece systems where the Dolby Digital or DTS decoder is separate from the preamp. Your receiver contains a complete bass management system. You can use as few as two large front left and right speakers or two small left and right speakers plus a subwoofer or as many as seven full range speakers plus a subwoofer or any combination in between without missing any information. Wherever small speakers are used the bass management system prevents low bass information from going to that speaker ("high pass"). This bass information is rerouted to a speaker that can handle it, usually a subwoofer, but it can also send center, surround, or LFE bass to large front speakers if no subwoofer is available. When center or surround speakers are not used at all, the missing channel is sent ("down mixed") to the front speakers.

**Preamp** - A preamp typically includes the capability to select from a number of sources, adjust volume levels and route the data to an amplifier. Your receiver includes a high quality preamp.

**Processor** - A processor typically includes the capability to decode one or more surround formats, and convert between digital and analog as required. Your A/V system controller includes a high quality processor capable of decoding the surround formats described above.

**Zone** - A zone is usually a room that has speakers installed in it. Your receiver includes a full preamp/processor for Zone 1 (A) plus an additional analog stereo preamp for Zone 2 (B). This allows, for example, watching a Dolby Digital movie in zone one while simultaneously using the built-in AM/FM tuner in another room.

**Amplifier** - An amplifier takes the output of a preamp/processor and increases its level to that necessary to drive a speaker.

**Speakers** - A surround sound system use to typically use 5 speakers located left front, center front, right front, right surround, and left surround plus a subwoofer located anywhere in the room. With the new developments in surround technology from companies such as Dolby Laboratories, DTS, and Lucasfilm, it is now possible to improve spatial expressions with an additional channel of information for use with a 6th and/or 7th surround back speaker. Although best results are achieved using seven large speakers plus a subwoofer, this is not always practical. Excellent results can be achieved using small and/or fewer speakers, as long as you go through the set up procedures described later in the manual. Your receiver includes the capability of reproducing up to 6.1 channels of surround information.

**Component video vs. S-video vs. Composite video** - Composite video is the oldest standard for color video. It combines the luminance (brightness or black-and-white) and chrominance (color) information onto a single conductor. These signals must be separated again for display resulting in some degradation of the video quality. S-video is a newer standard that uses separate conductors for the luminance (Y) and chrominance (C) information resulting in better video quality. Component video is the newest form of video introduced with DVD. This video format uses separate conductors for luminance (Y), red - luminance (R - Y), and blue - luminance (B - Y). Using these signals a component video capable monitor allows for even better and higher resolution video quality. Your processor is capable of switching composite and S-video with no support of component video signals. Also, you unit cannot convert between video types.

# FRONT PANEL

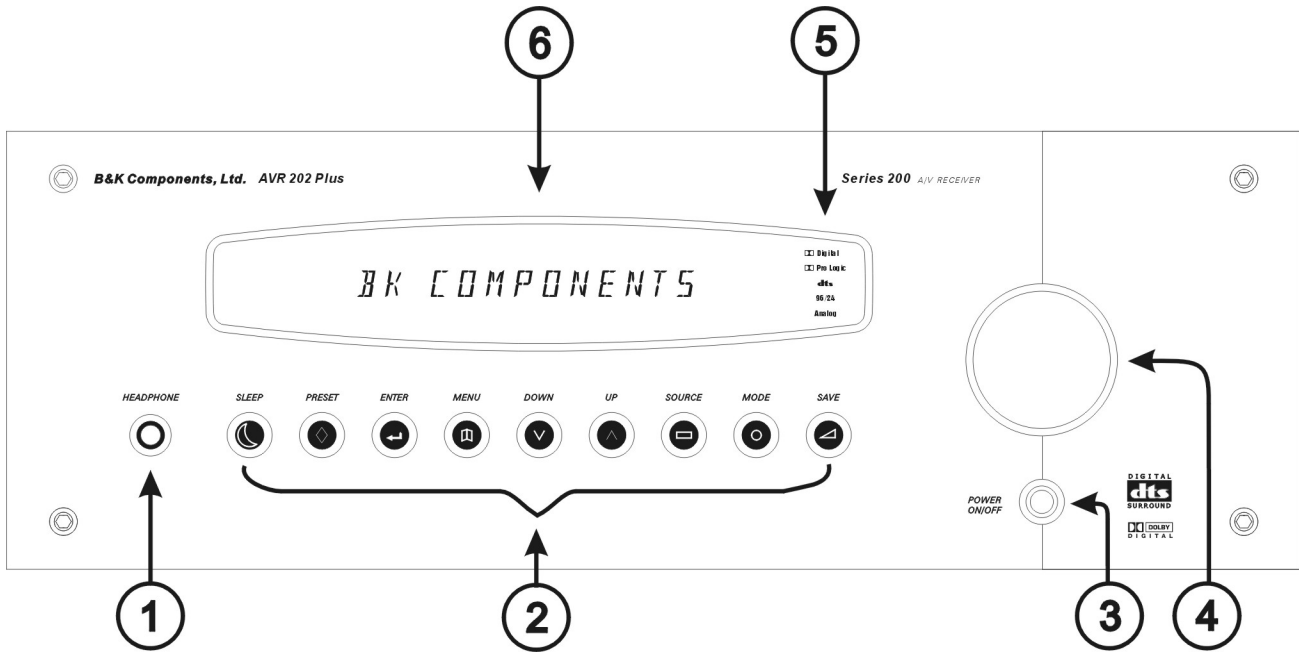

**1. Headphone Jack** - Stereo headphones having a standard ¼ inch binaural plug can be connected to the headphone output. The receiver must be on and in HEADPHONE Mode for proper headphone operation.

## 2. Front panel buttons

SLEEP	Puts the receiver in standby (low power) mode.
PRESET	Steps through audio / video presets for instant recall of setups. Pressing ENTER recalls the preset.
ENTER	Confirm selection or display current status of the receiver.
MENU	Enter / exit menu system.
DOWN  UP	Step through menus, sources, or audio modes.
SOURCE	Steps through the audio / video sources.
MODE	Steps through the audio modes.
SAVE	Pressing SAVE followed by ENTER saves a favorite preset.

**3. Main power switch** - Removes all power to the receiver. Normal operation of the receiver requires the power switch to remain on. Use the Sleep button for daily on and off of the receiver. It places the unit in standby mode that allows turning back on with the remote control. Turn the receiver off with the main power switch when not using the receiver for an extended period of time.

**4. Volume control** - For controlling system volume. Turning the jog-shuttle type volume control clockwise increases the volume level, counterclockwise decreases the volume level. The volume knob is also used to change other processor settings. See THE MENU SYSTEM and OPERATION

**5. Status indicators** - Displays current status of the receivers audio processor. Indicators have been supplied to show when the DSP is decoding Dolby Digital '**DD Digital**', Dolby Pro Logic '**DD Pro Logic**', or DTS audio. There is an indicator to show the input to the S/PDIF digital receiver is 96kHz 24 bit data '**96/24**' or an analog input that is being sampled using 96kHz/24bits. Finally, there is an indicator to show processed audio is sourced from the selected analog input '**Analog**'. See MODE OPERATION

**6. Display** - The receiver display is a 16 character alphanumeric fluorescent display. Displays current status of receiver and any changes being performed.

# REAR PANEL

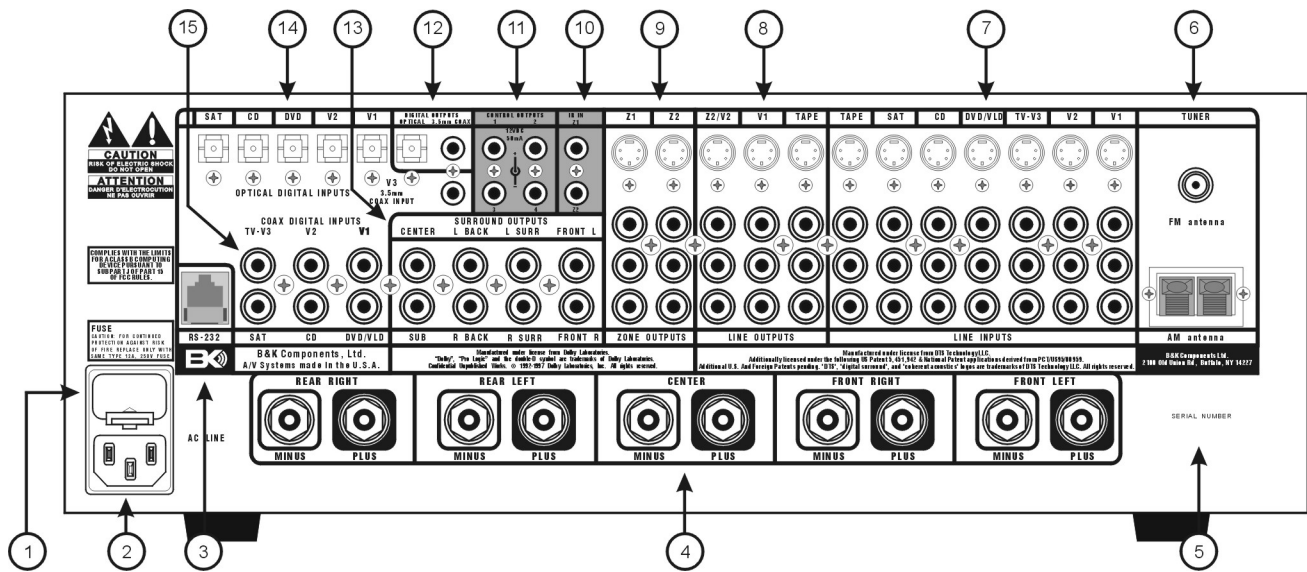

The receiver's back panel is organized into groups of inputs and outputs for audio and video as shown below. See back of this manual for an enlarged view.

1. **AC fuse holder** - Holds the AC Line fuse. Replace only with same type and value.
2. **AC input receptacle** - For attaching the supplied AC power cord to the receiver.
3. **RS-232 input** - Computer interface applications.
4. **Speaker outputs** - Connections for your speakers.  
**Red binding posts** - speakers (+)  
**Black binding posts** - speakers (-)
5. **Serial number** - The serial number of your unit is located on back of the unit.
6. **Antenna inputs** - Connections for the AM and FM antennas.
7. **Line inputs** - Connections from your audio/video sources.  
**Red RCA jacks** - right analog audio  
**White RCA jacks** - left analog audio  
**Yellow RCA jacks** - composite video  
**4 pin din jacks** - S-video
8. **Line level A/V outputs** – Switched fixed level A/V outputs to an audio or video recorder.
9. **Zone 1 (A) and Zone 2 (B) video outputs** - Outputs to your video monitors.
10. **IR in** - Accepts input from external IR receptors. Connect an IR repeater (“home run”) to IR IN for controlling the receiver. This method of control is useful when the front IR receptor is blocked (for example, by a cabinet door) or to control the receiver from another room. This input is typically used in place of an emitter attached to the front panel.

- 11. Control outs** - Outputs that allow you to remotely control external devices. (See “Making The Connection”).
- 12. Optical and Coax Digital output** - Zone 1 (A) optical and 1/8” mini-plug coax output to carry digital information from the selected digital input of the receiver out to digital recorders, personal computers, etc.
- 13. Surround outputs** - Variable level outputs for driving external power amplifiers or powered speakers.
- 14. Optical Digital inputs** - Optical digital inputs are used to connect digital audio signals from your source to the receiver. The incoming signal may be PCM, Dolby Digital or DTS.
- 15. Coax Digital inputs** - Coax digital inputs are used to connect digital audio signals from your source to the receiver. The incoming signal may be PCM, Dolby Digital (AC-3) or DTS.

**(Optional)**

**DVD Audio inputs** – Optional connections for a DVD audio or other 5.1 source device.

<b>Center</b>	<b>(TV-V3)</b>	<b>RCA jacks</b>	- center front surround audio inputs
<b>Sub</b>	<b>(SAT)</b>	<b>RCA jacks</b>	- sub audio inputs
<b>Ls</b>	<b>( V2)</b>	<b>RCA jacks</b>	- left rear surround audio inputs
<b>Rs</b>	<b>(CD)</b>	<b>RCA jacks</b>	- right rear surround audio inputs
<b>Lf</b>	<b>( V1)</b>	<b>RCA jacks</b>	- left front surround audio inputs
<b>Rf</b>	<b>( DVD/VLD)</b>	<b>RCA jacks</b>	- right front surround audio inputs

# MAKING THE CONNECTION

It's tempting to just plug in your new A/V receiver and have great sound pour out. Before you do that, take a few minutes to plan out how you want the receiver to fit into your audio/video system. Ask yourself the following questions:

- What source components do I want to connect to my receiver? (CD, VCR, etc.)
- What equipment will be receiving the audio and video? (TV monitor, Speakers, etc.)

The answers to your questions determine how many cables you need to connect to the back of the receiver. Good preplanning equals great sound. Keep these recommendations in mind:

- List all components in your system and indicate which jacks of the receiver each component will be connected to. Your receiver has seven sets of inputs. It is convenient to connect a DVD player to the input labeled DVD or a VCR to the input labeled V1 or TAPE, etc. However, your equipment may differ from the labeling on the back of your receiver. In most cases you can connect any type of source to any input (see FREQUENTLY ASKED QUESTIONS). For example, if you don't have a satellite receiver you can connect a DAT player or a second cassette deck to SAT. You can also reprogram the source name that will appear on your receiver's front panel and on-screen display (see SYSTEM SETUP - INPUTS)
- Also note the length of the cable for each component's connection and describe how it should be routed or draw your routing scheme below your list. You may want to label each cable with a name or number at both ends. Use high quality connections to maintain high quality audio and video.
- Think about the type and length of cable you need and obstacles in the cable's path (doorways, furniture, walkways, etc.). To decide which ones are right for you talk to your dealer about the various cable products that are available.
- For safety, keep all cables out of high traffic areas (hallways or doorways) and away from equipment that radiates power, including amplifiers, power cords, heaters, etc.
- If you might expand your audio/video system later, keep these ideas in mind as you plan current cable runs.
- To provide the best tuner reception, make sure the antenna is at least several feet away from the receiver and any other equipment that may produce high frequency interference such as Personal computers, CD players, halogen lamps, etc.

Take a look at the back panel of the receiver. You will notice that the RCA-type audio input and output connectors are identified by colors, red for right channel and white for the left channel audio. Composite video input and output connectors are identified by yellow. Coaxial digital inputs are identified by orange. The surround outputs are the Black connectors.



# AUDIO / VIDEO CONNECTIONS

## Connecting your analog sources to your processor

**Audio / Video source** - connecting a DVD/VLD player to the receiver's analog inputs. Use the same instructions for connecting to other audio / video sources such as a television, satellite receiver, cable box, etc. See Connecting Video for use with other than composite and S-video (Omit the video connections for an audio-only component such as a CD player)

Attach one end of the audio interconnect cable to the left audio output on the DVD/VLD player, then attach the other end to the left (white) DVD/VLD audio input on the receiver. Repeat for the right (red) audio connection. Attach one end of the composite video interconnect cable to the video out on the DVD/VLD player, then attach the other end to the yellow video input on the receiver labeled DVD/VLD. Repeat for the S-video connections if you are using S-video.

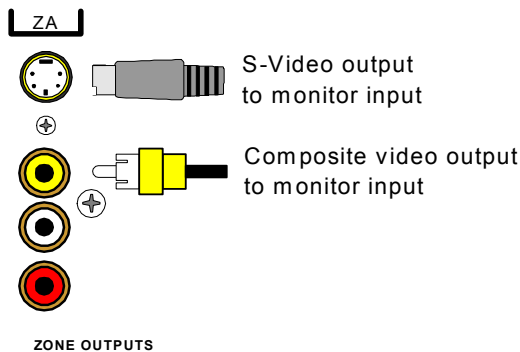
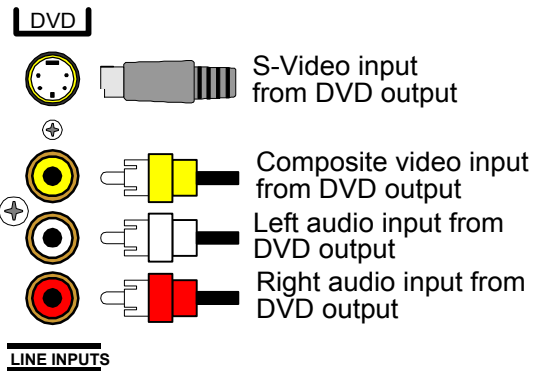

**Video Monitor** - Attach one end of the composite video interconnect cable to the video input on the monitor, then attach the other end to the yellow video output on the receiver's ZONE OUTPUTS. Repeat for the S-video connections if you are using S-video. Dual zone operation requires connections be made to (ZA) for Zone 1, and (ZB) for Zone 2.

**VCR or audio recorder** - connect a VCR to V1 . Use the same instructions for connecting to the V2 and TAPE analog inputs. If connecting a cassette deck or other audio-only recorder then omit the video connections.

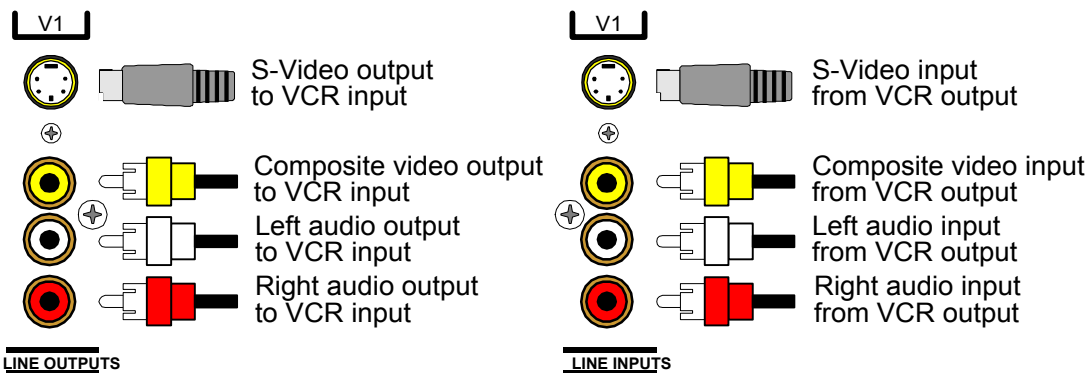

Attach one end of the audio interconnect cable to the left audio output on the VCR, then attach the other end to the left (white) V1 audio input on the receiver. Repeat for the right (red) audio connection. Attach one end of the composite video interconnect cable to the composite video output on the VCR, then attach the other end to the yellow video input on the receiver labeled V1. Repeat for the S-video connections if you are using S-video.

Attach one end of the audio interconnect cable to the left audio input on the VCR, then attach the other end to the left (white) V1 audio output on the receiver. Repeat for the right (red) audio connection. Attach one end of the composite video interconnect cable to the composite video input on the VCR, then attach the other end to the yellow video output on the receiver labeled V1. Repeat for the S-video connections if you are using S-video.

**DVD Audio using the Coax digital inputs (optional)** – your receiver allows for an option to connect a 5.1 DVD Audio or other 5.1 surround format device, to the receiver’s DVD Audio input when NO coax digital inputs are to be used. **This option calls for the setting of a push button switch internal to the unit. Please contact B&K customer service for further details if this option is desired.**

Attach one end of an audio interconnect cable to the center output on the DVD Audio source device, then attach the other end to the Center (TV-V3) DVD Audio input on the receiver. Repeat for the Left surround (V2) and Left front (V1) audio connection. Attach one end of an audio interconnect cable to the sub output on the DVD Audio source device, then attach the other end to the SUB (SAT) DVD Audio input on the receiver. Repeat for the Right surround (CD) and Right front (DVD/VLD) audio connection.

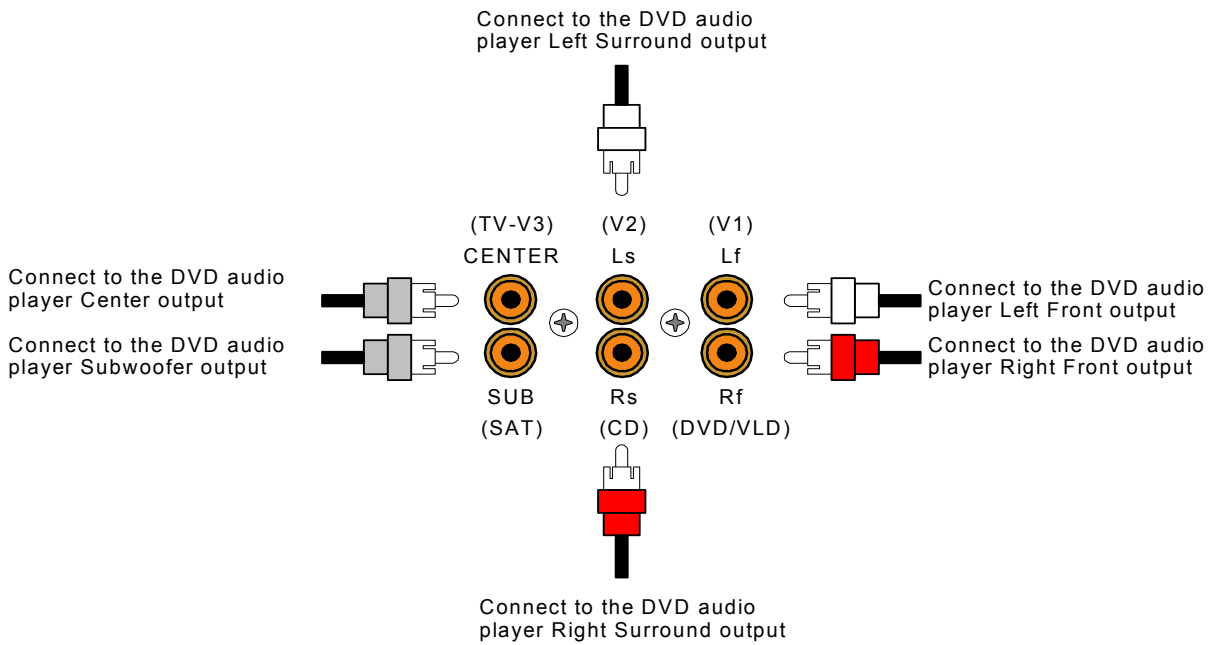

## DIGITAL CONNECTIONS

Connect digital inputs (DVD, VLD, etc.) to the receiver. You will need either coaxial or optical digital inputs to play Dolby Digital (AC-3) or DTS surround sound processing. Digital connections are also recommended for PCM sources. If your source has both optical and coaxial outputs connect only one.

**Coaxial digital inputs** - standard RCA type connectors. Attach one end of your digital coaxial cable to your source coaxial digital out and the other end to the appropriate receiver coaxial digital (orange) input.

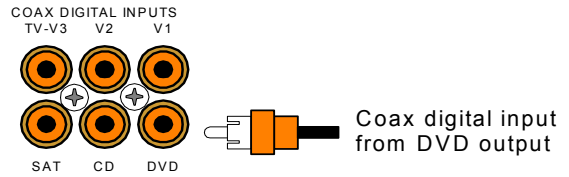

**Optical digital inputs** - First, remove the cap on the optical digital input. Save the cap. Attach one end of your digital optical cable to your source and the other end to the appropriate digital input on the back of the receiver.

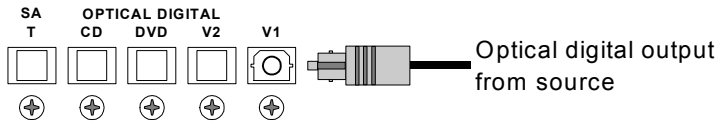

**Connecting A Laser disc Player - Dolby Digital (AC-3) laser discs** use a special technique called AC-3 RF to encode the Dolby Digital bitstream. If the laser disc player is capable of playing back Dolby Digital discs it will have a separate output for this bitstream in addition to the normal coaxial and/or optical outputs. Do not connect the AC3-RF output directly to your receiver. The AC-3 RF bitstream must first be converted to a normal (non-RF) Dolby Digital type signal. It is recommended that a B&K DT-1 be used to convert and select between the Laser's AC-3 RF and PCM/DTS signals. The output from a DT-1 will automatically select between the connected PCM/DTS bitstreams and the converted AC-3 RF Dolby Digital signal. Other AC-3 RF to Dolby Digital decoders may not make this switch

automatically. Connect the laser disc's AC3-RF output to the DT-1's AC-3 RF input. Connect either the laser disc player's PCM coaxial or optical digital output (not both) to the DT-1's coaxial or optical input. Connect the DT-1's coaxial output to the desired coaxial digital input on your receiver.

**Digital Outputs** - Separate and independent coax digital outputs are available for Zone 1 (A) and Zone 2 (B). Connect to a digital recorder (CD-R, mini disc, DAT, personal computer, etc.) These signals are the same as the incoming digital signal from the selected source on each zone. If your digital recorder has both optical and coaxial inputs you need only connect one. Zone 1 (A) selected digital input is converted to both coaxial and optical. You may connect one digital recorder to the optical output and another recorder to the coaxial output.

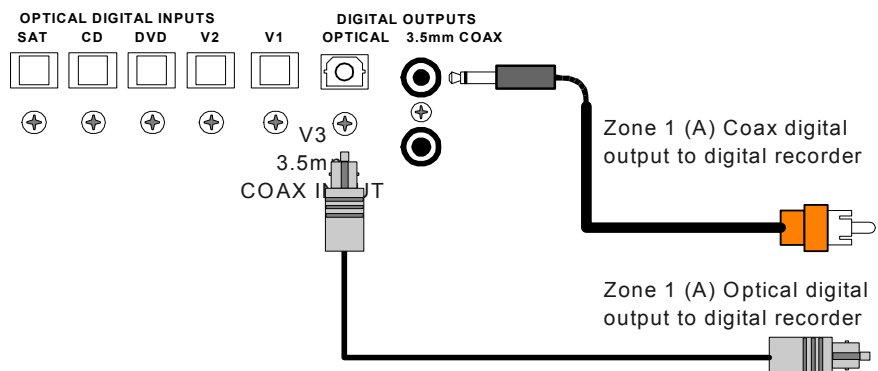

# SURROUND OUTPUTS

Your receiver has multiple surround processor outputs for use with external amplifier(s) or powered speakers. The AVR 202+ receiver allows further processing of the surround channels for the precise decoding of Dolby Digital Surround EX and DTS-ES soundtracks via matrix decoding.

Here is a typical surround output setup:

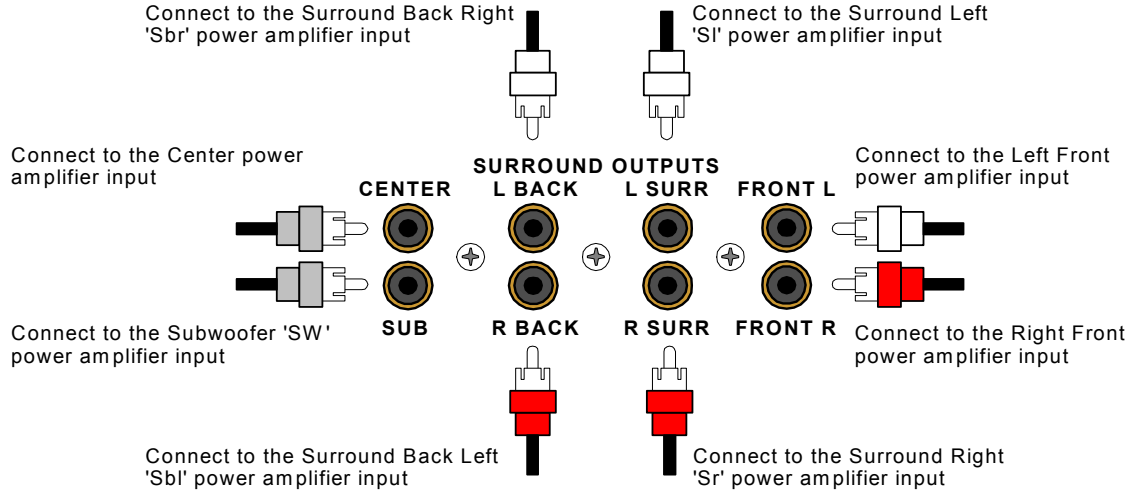

**Subwoofer Output** - Connect an RCA cable from the receiver's SW output (part of the surround outputs). If your subwoofer does not contain its own amplifier you will need to purchase an external B&K or other power amplifier. Connect the receiver's SW output to the audio input of the external amplifier. Connect the external amplifier's speaker output to your subwoofer.

# SPEAKER OUTPUTS

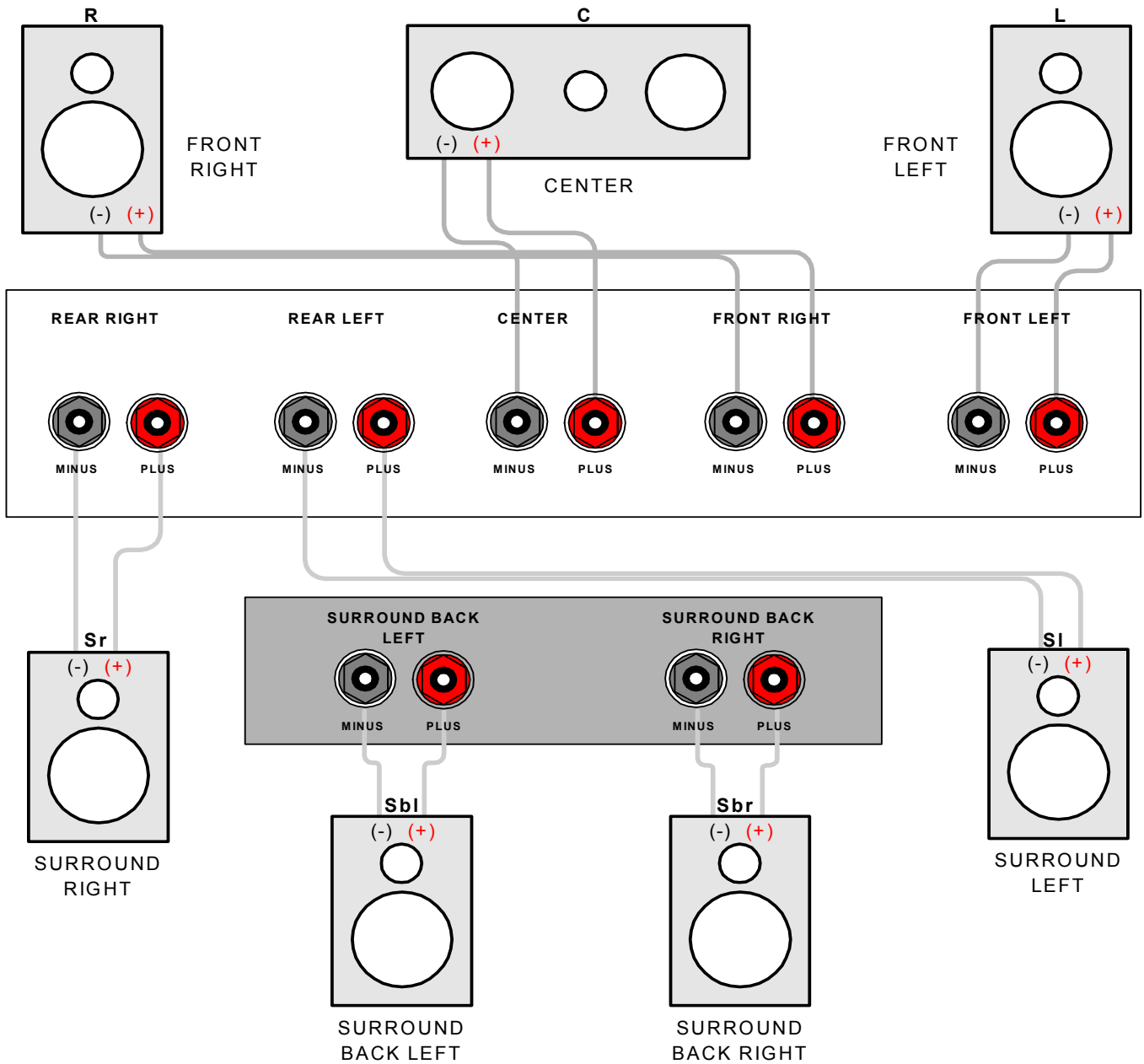

Five-way binding posts are provided, one pair for each channel. They are designed to accept a banana-type plug or spade lug connector (shown below) and are color coded for easy identification. The red (+) post should always be connected to the speaker's red (+) jack. The black (-) post should always be connected to the speaker's black (-) jack.

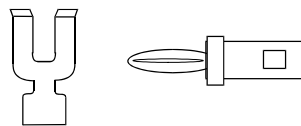

Spade connector    Banana jack

The amplifier section of the receiver will produce 105 watts / channel into 8 ohms. See SPECIFICATIONS for more information. Here is a typical receiver output setup:

## ANTENNA CONNECTIONS

The FM jack is a standard screw on F-type connector. The AM is a push type. Strip ¼ inch of insulation off your AM antenna wires and insert one wire end into each hole while holding the tabs down. Release the tabs to lock in the AM antenna wires.

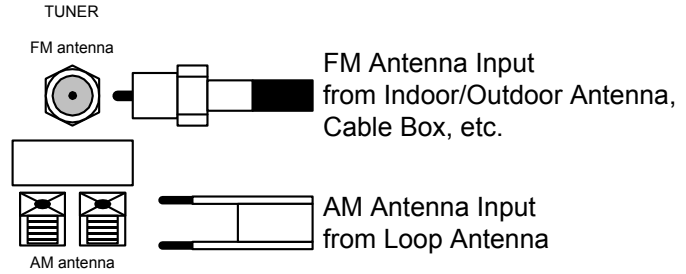

## CONTROL OUTPUTS / IR INPUTS

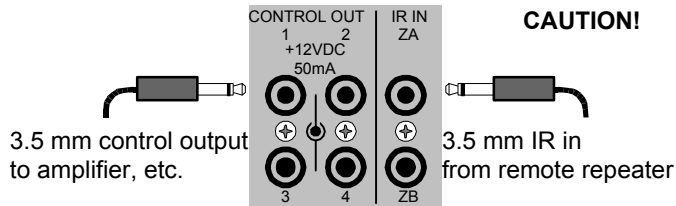

**Control Outputs** - These connections are used for controlling other equipment such as an external B&K Components, Ltd. amplifier, projection screen, etc. Connect your control cable to the receiver using a mono 3.5 mm jack shown at left. The plug must be wired as tip (+) and the long barrel section (-).

The Control outputs are programmable for each source in your system (see "Advanced Setup"). However, the receiver provides the following factory preprogrammed setup that should serve for most standard system applications.

**Control 1 - HEADPHONE** - On (+12 VDC) when Zone 1 (A) is on and not in Headphone mode, off when Zone 1 (A) is off or in Headphone Mode. This mode may be used for controlling external amplifiers or powered subwoofers in Zone 1 (A).

**Control 2 - Zone 2 (B)**. On (+12 VDC) when Zone 2 (B) is on, off (0 VDC) when Zone 2 (B) is off. This mode is used for controlling external amplifiers, projection screens, etc. in Zone 2 (B).

**Control 3 - Z1 + Z2**. On (+12 VDC) when Zone 1 (A), Zone 2 (B), or both zones are turned on. Off (0 VDC) when both zones are off.

**Control 4 -REMOTE**. It will repeat a received 38 kHz modulated IR signal. The receiver will transmit received IR signals even in sleep mode.

Note - The control outputs can output a maximum of 50 mA. Check to see that the source you are connecting to the control out requires 50 mA or less current.

**WARNING - Not all manufacturers adhere to the +12 VDC control specification. Check to see if your sources control inputs are +12 VDC compatible. Do not connect your receiver's control outputs to a source with control or remote inputs rated at +5 VDC or other voltage rating. Damage to your source may result.**

**IR Inputs** - Your receiver can be controlled by a directly connected IR repeater system in combination with or in place of the supplied remote control. Connect your IR input cable to the receiver using a mono 3.5 mm jack shown above. The plug must be wired as tip (+) and the long barrel section (-). The inputs are standard 38kHz modulated IR type with a voltage range of +5 to +12 VDC.

## FREQUENTLY ASKED QUESTIONS

### ***My collection of equipment differs from the labels on the back of my receiver, how can I hook them up?***

Your receiver provides 5 identical sets of inputs - V1, V2, DVD, CD, and SAT. Each of these has analog audio, composite video, S-video, coaxial digital audio, and optical digital audio. It is convenient to connect components as labeled on the back of your receiver, but since all the inputs are identical, you can connect any compatible source to any set of inputs. For example, you can connect a DAT player to V1 instead of a VCR. You can program your receiver to display any 5 character name for any input (see System Setup - Inputs).

The sixth input, TV, is identical to the others except that there is no optical digital. You can also connect portables to any other coaxial digital input using adapters or special cables. If you have a source with only optical digital output don't connect it to TV.

The seventh input, TAPE, has analog audio, composite video and S-video, but has no digital inputs. It is primarily intended for analog recorders such as VCRs or cassette decks. If you have a three-head cassette or reel-to-reel tape deck you will prefer the TAPE input since it allows a full tape monitor capability. Tape monitor allows you to listen to what is actually on the tape as you are recording it. The V2 input also provides full tape monitor capabilities for Zone 2 (B). If you don't use Zone 2 (B) you can use V2 as a second independent analog tape monitor loop. V1 includes a line level output but does not provide true tape monitor capability.

### ***My DVD player (or other source) has both optical and coaxial digital outputs. Should I connect both?***

No, connect only one digital cable per source.

### ***Do I need an AC-3 RF demodulator (B&K DT-1 or equivalent) to playback Dolby Digital DVDs?***

No, this is required only for Dolby Digital laser discs.

### ***Do I need an AC-3 RF demodulator (B&K DT-1 or equivalent) to playback DTS laser discs?***

No, this is required only for Dolby Digital laser discs.

### ***Do I need to connect both analog and digital audio from my DVD player (or other digital audio source) to the receiver?***

In general, it is simpler to connect both. However, if you can meet all of the following criteria you need only connect digital:

1. I do not use Zone 2 (B). (Zone 2 (B) is analog only - if you use Zone 2 (B) you must connect both left and right analog to hear audio.)
2. I do not own any old laser discs. (Early laser discs contained only analog audio tracks - you must connect both left and right analog audio to play these back.)
3. I do not use Tape Monitor. (It is possible to tape digital-only sources. However, if you wish to listen directly to the tape as you are recording - you must connect both left and right analog audio - the tape monitor loops are strictly analog.)

### ***If the tape monitor loop is strictly analog, how do I make an analog recording of a digital-only source?***

Do not select TAPE. Select the source you wish to record. Select STEREO 9, the LtRt mode. If that source is digital, the converted digital-to-analog will appear at the tape and V1 outputs. V2 out, like Zone 2 (B) out, is analog only. (See also Operation - Zone 1 Operation - Mode.)

### ***I want to make direct digital recordings from my CD player (or other digital source) on my CD Recorder, DAT (or other digital recorder). Can my receiver make this connection for me?***

Yes, your receiver's digital outputs act much like the analog tape outputs. When you select a source, if that source has a digital connection to your receiver, then that digital signal will appear on the receiver's coaxial and optical digital outputs. Simply connect all of your sources digital outputs to your receivers digital inputs. You can then connect up to three digital recorder inputs to your receiver's three digital outputs.

***My laser disc player (or other digital source) has only optical output, but my CD recorder (or other digital recorder) has only coaxial input. Do I need some sort of converter to make direct digital recordings?***

No, your receiver will convert optical to coaxial and coaxial to optical. The currently selected digital input (optical or coaxial) will appear at both of the receiver's digital outputs (optical and coaxial).

***Do I need to connect both analog and digital audio from my receiver to my CD, DAT, MD, etc. recorder?***

In general, yes. If all of the sources you wish to record are digital, then you need only connect digital to your recorder. However, your receiver does not provide digital outputs for non-digital inputs. If you wish make a digital recording from an analog-only source you must also connect analog from your receiver (Tape or V1 out) to your recorder.

***Can I connect a phonograph directly to my receiver?***

No, you will need a separate outboard phono preamplifier. The output of the phono preamp can then be connected to any analog input on your receiver. We recommend our Phono 10 phono preamp. In addition to it's superb analog audio processing, it has an option for S/PDIF coax output. Talk to the dealer where you purchased your receiver.

***Do I need to connect both S-video and composite video to my receiver?***

If all of your video equipment has S-video then you need only connect S-video. S-video is a higher quality video format and you will probably not want to use composite. If all or most of your video equipment is composite then it is simplest to just connect the composite and omit S-video.

***Can I connect mixed composite and S-video sources?***

Yes, but your receiver will not convert S-video to composite or composite to S-video. If your monitors and VCRs accept only composite video then there is no point in connecting S-video from other sources. If you use mixed S-video and composite sources you must connect both S-video and composite to your monitors and VCRs. You will need to change your monitor or VCR S-video / composite inputs manually when you change sources. This can normally be done via the monitor's or VCR's remote control (or the supplied universal remote). Some monitors or VCRs may require you to physically disconnect S-video before they will accept composite video. Some monitors are capable of automatic switching between S-video and composite. Your receiver must be setup properly in order to work with auto switching monitors - refer Setup Displays.

To assist you, the receiver's on-screen display will tell you what video is currently selected whenever you change sources or hit the SEL (remote) or ENTER (remote or front panel) key, but it cannot switch your monitor or VCR input for you. *If you are watching S-video, but the source is composite video only, you will see "Switch Monitor to Composite" on your Monitor. If you are watching Composite video but your source is S-video only, you will see "Switch Monitor to S-video" on your monitor.* These displays appear only if your receiver is setup for manual monitors.

***Can I connect mixed composite and S-video monitors and VCRs?***

Yes, but you must connect both S-video and composite from all of your sources - your receiver will not convert between S-video and composite. Refer to the previous question if not all of your sources have both S-video and composite outputs.

For example, it is common to have an S-video monitor and a composite VCR. Connect the monitor to the Zone 1 (A) S-video and composite outputs and the VCR to the V1 or TAPE composite output. The composite inputs will appear at the composite outputs for TAPE and V1. (The S-video inputs also appear at the TAPE and V1 S-video outputs, but, in this example, they are not connected.) To prevent feedback, TAPE IN will not appear on TAPE OUT and V1 IN will not appear on V1 OUT - this also applies to the audio outputs. Zone 2 (B) works the same for Zone 2 (B) OUT and V2 OUT with feedback prevention on V2.

Things get a bit more complicated for the Zone 1 (A) output because it contains your receiver's internal on-screen display system. You must be sure that you tell your receiver if you have a monitor which can automatically switch between S-video and composite outputs, or one which must be manually switched (see Setup Displays)



# SETUP

For best results, perform the following set up procedure when you initially install your receiver and anytime you change or add sources, speakers, etc. or when you rearrange your listening area

## THE MENU SYSTEM

Setup of your receiver will require you to navigate through the menu system. We recommend that you use a video monitor connected to the Zone 1 (A) output along with the remote control provided with your receiver. It is also possible to set up your receiver from the front panel. Do not leave your video monitor on with the receiver in the menu system for long periods of time. This can result in permanently burning the menu display into your monitor's screen. This would take several hours so there is no danger of it happening during normal setup procedures. The following are general instructions for using the menu system. A complete guide to the menu system is included at the back of this manual.

**MENU** - If you are not already in the menu system, the MENU button will activate the menu system. Once you are in the menu system, the MENU button will return you to the next higher level menu or, if you are already at the highest level, it will exit from the menu system.

**UP/DOWN ARROWS** - Once you are in the menu system, use the UP/DOWN ARROWS to move to the desired menu selection. The currently active menu line is highlighted in a contrasting color.

**SEL (remote) or ENTER (remote or front panel)** - Some menu selections cause another menu to be activated. Use the UP/DOWN ARROWS to move to the desired menu line. Pressing SEL or ENTER will activate the next menu.

**NUMERIC KEYS (remote only)** - From the remote control you may also go directly to a menu line by typing the corresponding line number. If there is another menu below that line it will be activated immediately (no ENTER required).

**LEFT/RIGHT ARROWS (remote) or VOLUME KNOB (front panel)** - Some menu selections allow you to change one of the receiver settings. Use the UP/DOWN ARROWS to move to the desired menu line. Pressing the LEFT/RIGHT ARROWS will change the setting. There are no LEFT/RIGHT ARROWS on the front panel. While in the menu system, the VOLUME KNOB acts as the LEFT/RIGHT ARROWS. This means that you will not be able to adjust the volume from the front panel while in the menu system. The remote control volume will work in most menus.

**TEXT EDITING** - some menu selections will require you to edit text. Use the UP/DOWN ARROWS to change the current (blinking) character. Use the LEFT/RIGHT ARROWS (or VOLUME KNOB) to move to another character position.

**EXIT (remote only)** - From the remote control you may instantly EXIT the menu system.

**UNIVERSAL REMOTE** - Remember that when you press a source button (DVD, CD, etc.) the remote now controls the selected device. To return control to your receiver, you must press B&K or AUDIO. **ALWAYS check that your remote is set to B&K or (AUDIO) before attempting to control your receiver. B&K or (AUDIO) will be displayed in the remote's LCD window.**

## SYSTEM SETUP

You should always perform System Setup after first installing your receiver and after adding/changing speakers or sources or rearranging your listening area. Check that the remote is in B&K mode.

	From Remote	From Front Panel	Action
1	B&K or POWER	Ⓞ SLEEP	turn on receiver
2	MENU	∟ MENU	activate menu system
3	▲(PAUSE) or ▼(STOP)	∧ (UP) or ∨ (DOWN)	move to System Setup
4	SEL or ENTER	↵ (ENTER)	activate SETUP SYSTEM

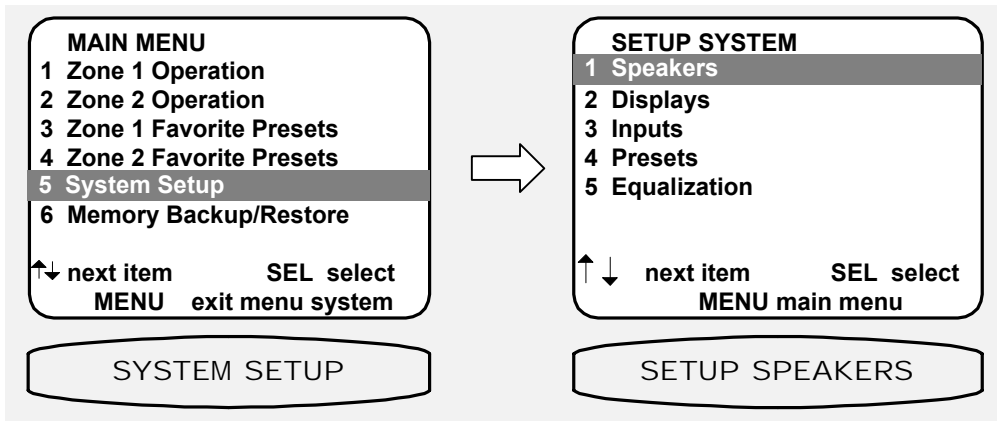

	From Remote	From Front Panel	Action
1	▲(PAUSE) or ▼(STOP)	∧ (UP) or ∨ (DOWN)	move to Speakers
2	SEL or ENTER	↵ (ENTER)	activate SETUP SPEAKERS

## Speakers

The speakers menu lets you tell your receiver how many speakers you have in your system, the relative size of the speakers, and their location in the room. This is the most important setup procedure you will perform. The receiver comes from the factory setup for 7 small speakers and a subwoofer. If this does not match your speakers then audio information will be lost. For example, if you do not currently have a center channel speaker and you do not perform this setup procedure, the center channel information will be lost. If you perform this setup correctly, the receiver will know that you have no center channel speaker and send this information to your front left and right speakers (along with the normal front left and right information) so no audio information is lost.

### Speaker Size

Speaker size generally refers to the size of your speakers. Audio material, particularly Dolby Digital and DTS movies, often contain large amounts of bass. If this bass information is sent to small speakers that are incapable of reproducing so much bass, then the bass information will be lost or distorted. **MANY SMALL SPEAKERS MAY BE DAMAGED BY TOO MUCH BASS.** By telling your receiver the size of your speakers, it will be able to intelligently route the bass to speakers that can reproduce it correctly. Typically, all bookshelf or satellite speakers are considered small. Smaller floor standing speakers with single woofers 8" or less should also be considered small. Floor standing speakers with 10" or larger woofers or multiple smaller woofers may be considered large. These are general guidelines only - if you are unsure consult your speaker manufacturer or check with the dealer if they are unsure. If you have all small speakers we strongly recommend use of a subwoofer. If your front left and right speakers (or more) are large then you may not require a subwoofer, but you may still get better results using a subwoofer, especially with Dolby Digital and DTS movies. All THX certified speakers are small, regardless of their physical size, and should be used in audio systems along with a subwoofer.

Set the size for your front left and right, 'L' and 'R' speakers - You must have front speakers.

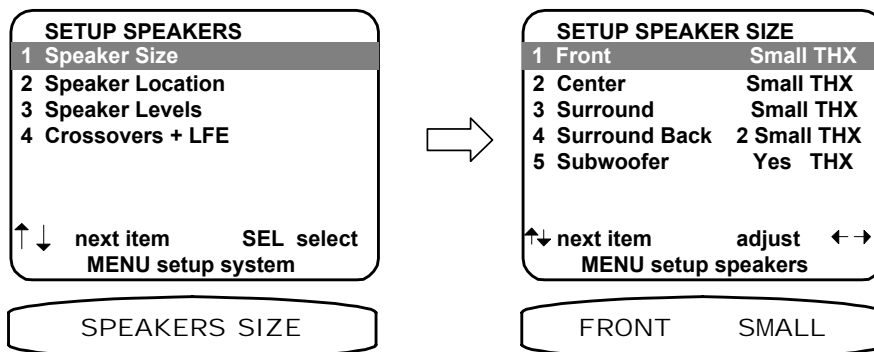

	From Remote	From Front Panel	Action
1	▲(PAUSE) or ▼(STOP)	∧ (UP) or ∨ (DOWN)	move to Speaker Size
2	SEL or ENTER	↵ (ENTER)	activate SETUP SPEAKER SIZE
3	▲(PAUSE) or ▼(STOP)	∧ (UP) or ∨ (DOWN)	move to Front
4	◀(REW) or ▶(FF)	VOLUME KNOB	choose speaker size

Front setting	Subwoofer Ultra	Subwoofer Yes THX	Subwoofer None
Small THX	Front Bass to SW Front Hi-Pass to Front	Front Bass to SW Front Hi-Pass to Front	Front Bass is * Front Hi-Pass to Front
Large	Front Bass to SW Front Full Range to Front	Front Full Range to Front	Front Full Range to Front

Set the size for your center 'C' speaker -

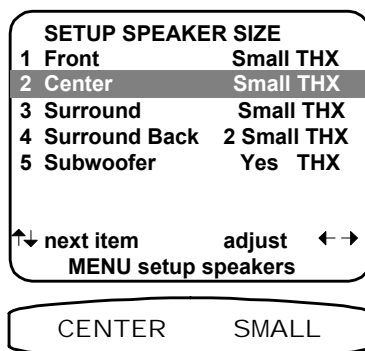

	From Remote	From Front Panel	Action
1	▲(PAUSE) or ▼(STOP)	∧ (UP) or ∨ (DOWN)	move to Center
2	◀(REW) or ▶(FF)	VOLUME KNOB	choose speaker size

Center setting	Subwoofer Ultra	Subwoofer Yes THX	Subwoofer None Front Large	Subwoofer None Front Small
None	Center Bass to SW Center Hi-Pass to Front	Center Bass to SW Center Hi-Pass to Front	Center Full to Front	Center Bass is * Center Hi-Pass to Front
Small THX	Center Bass to SW Center Hi-Pass to Center	Center Bass to SW Center Hi-Pass to Center	Center Bass is * Center Hi-Pass to Center	Center Bass is * Center Hi-Pass to Center
Large	Center Bass to SW Center Full to Center	Center Full to Center	Center Full to Center	Center Full to Center

Set the size for your surround left and right, 'Sl' and 'Sr' speakers -

SETUP SPEAKER SIZE	
1 Front	Small THX
2 Center	Small THX
3 Surround	Small THX
4 Surround Back	2 Small THX
5 Subwoofer	Yes THX
↕ next item      adjust      ← → MENU setup speakers	

SURROUND SMALL

	From Remote	From Front Panel	Action
1	▲(PAUSE) or ▼(STOP)	∧ (UP) or ∨ (DOWN)	move to Surround
2	◀(REW) or ▶(FF)	VOLUME KNOB	choose speaker size

Surround setting	Subwoofer Ultra	Subwoofer Yes THX	Subwoofer None Front Large	Subwoofer None Front Small
None	Surround Bass to SW Surround Hi-Pass to Front	Surround Bass to SW Surround Hi-Pass to Front	Surround Full to Front	Surround Bass is * Surround Hi-Pass to Front
Small THX	Surround Bass to SW Surround Hi-Pass to Surround	Surround Bass to SW Surround Hi-Pass to Surround	Surround Bass is * Surround Hi-Pass to Surround	Surround Bass is * Surround Hi-Pass to Surround
Large	Surround Bass to SW Surround Full to Surround	Surround Full to Surround	Surround Full to Surround	Surround Full to Surround

Set the size for your surround back left and right, 'Sbl' and 'Sbr' speakers -

SETUP SPEAKER SIZE	
1 Front	Small THX
2 Center	Small THX
3 Surround	Small THX
4 Surround Back	2 Small THX
5 Subwoofer	Yes THX
↕ next item      adjust      ← → MENU setup speakers	

SUR BACK 2 SMALL

	From Remote	From Front Panel	Action
1	▲(PAUSE) or ▼(STOP)	∧ (UP) or ∨ (DOWN)	move to Surround Back
2	◀(REW) or ▶(FF)	VOLUME KNOB	choose speaker size

Surround Back setting	Subwoofer Ultra	Subwoofer Yes THX	Subwoofer None Front Large	Subwoofer None Front Small
None	Surround Bass to SW Surround Hi-Pass to Front	Surround Bass to SW Surround Hi-Pass to Front	Surround Full to Front	Surround Bass is * Surround Hi-Pass to Front
1 Small	Sb Bass to SW Sb Hi-Pass to Surround Back Left	Sb Bass to SW Sb Hi-Pass to Surround Back Left	Sb Bass is * Sb Hi-Pass to Surround Back Left	Sb Bass is * Sb Hi-Pass to Surround Back Left
1 Large	Sb Bass to SW Sb Full to Surround Back Left	Sb Full to Surround Back Left	Sb Full to Surround Back Left	Sb Full to Surround Back Left
2 Small THX	Sb Bass to SW Sb Hi-Pass to Sbl and Sbr	Sb Bass to SW Sb Hi-Pass to Sbl and Sbr	Sb Bass is * Sb Hi-Pass to Sbl and Sbr	Sb Bass is * Sb Hi-Pass to Sbl and Sbr
2 Large	Sb Bass to SW Sb Full to Sbl and Sbr	Sb Full to Sbl and Sbr	Sb Full to Sbl and Sbr	Sb Full to Sbl and Sbr

**Setup your subwoofer 'SW'** - In the table above, you have the flexibility to choose how bass information is distributed to your speakers only if you have large speakers and a subwoofer as part of your home theater speaker system. For example, selecting the "Front Large" and "Subwoofer Yes THX" options, bass from the front left and front right channels will go ONLY to the front left and front right speakers. Bass going to the subwoofer will only come from the LFE channel and any channels with speakers that you have designated as "Small". This selection is preferred by THX. However, selecting the "Front Large" and "Subwoofer Ultra" options, you will send the bass from the front left and right channels to the front left, right AND subwoofer speakers simultaneously. To decide which setting is best for your room, once you have positioned all of your speakers, choose the option which gives you the most solid sounding bass.

\* Note: when the subwoofer is set to None, bass is redirected to remaining large speakers. When no speakers are set to Large, and the subwoofer is set to None, bass information is lost.

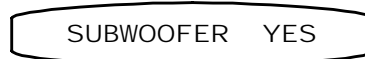
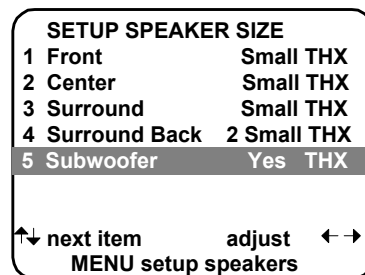

	From Remote	From Front Panel	Action
1	▲(PAUSE) or ▼(STOP)	∧ (UP) or ∨ (DOWN)	move to Subwoofer
2	◀(REW) or ▶(FF)	VOLUME KNOB	choose subwoofer setting
3	MENU	∟ MENU	return to SETUP SPEAKERS

Subwoofer Setting	Front Large	Center Large	Surround Large	Surround Back Large
None	LFE + Bass to Front	LFE + Bass to Center	LFE + Bass to Surround	LFE + Bass to Surround Back
Yes THX	LFE + Bass to SW Front Bass not Duplicated	LFE + Bass to SW Center Bass not Duplicated	LFE + Bass to SW Surround Bass not Duplicated	LFE + Bass to SW Sb Bass not Duplicated
Ultra	LFE + Bass to SW Front Bass is Duplicated	LFE + Bass to SW Center Bass is Duplicated	LFE + Bass to SW Surround Bass is Duplicated	LFE + Bass to SW Surround Back Bass is Duplicated

Note: The subwoofer setting affects the routing of front, center, and surround bass information as shown previously. This table shows the effect of the subwoofer setting with large speakers.

## Speaker Location

Ideally your speakers will be the same distance away from your listening area. However, physical limitations usually require placing the speaker in other than optimum locations. Your receiver contains a means to electronically move each speaker's location. This allows for superior reproduction of the directional cues available during the playback of movie or music. Measure the distance in feet to your speakers and set each speaker location setting to this distance. Your receiver will electronically "move" each speaker to maintain correct time alignment with the listening position. You may also change the units to meters, if you prefer.

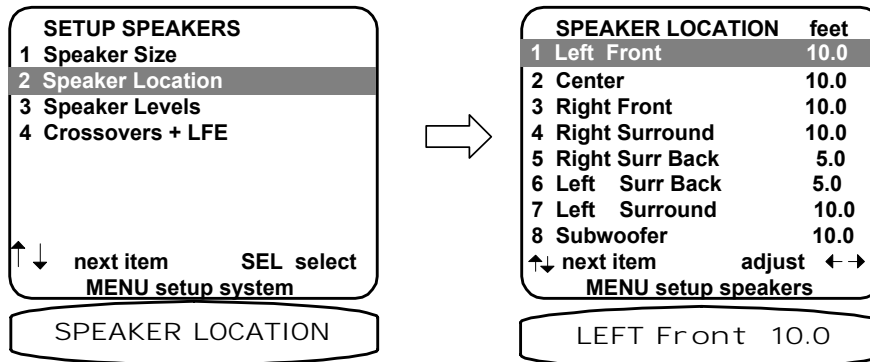

	From Remote	From Front Panel	Action
1	▲(PAUSE) or ▼(STOP)	∧ (UP) or ∨ (DOWN)	move to Speaker Location
2	SEL or ENTER	↵ (ENTER)	activate SPEAKER LOCATION
3	▲(PAUSE) or ▼(STOP)	∧ (UP) or ∨ (DOWN)	move to Left Front
4	◀(REW) or ▶(FF)	VOLUME KNOB	adjust left speaker location
5	▲(PAUSE) or ▼(STOP)	∧ (UP) or ∨ (DOWN)	move to Center
6	◀(REW) or ▶(FF)	VOLUME KNOB	adjust center speaker location
7	repeat 5-6 for each speaker	repeat 5-6 for each speaker	repeat for all speakers
8	MENU	∟ MENU	return to SETUP SPEAKERS

## Speaker Levels

Speaker level calibration allows you to equalize the volume levels of each speaker to make up for differences in speaker characteristics and distances from the listener to the speakers. For best results it is important that you perform this calibration when you initially install your receiver, whenever you change speakers, and whenever you rearrange your listening area. The following adjustment must be done for proper room calibration to THX reference level. Sit or place the SPL (Sound Pressure Level) meter in your normal listening spot. Check that you are in SETUP SPEAKERS and that your remote is in B&K mode. Note that if you have turned a speaker OFF in the SPEAKER SIZE SETUP menu then you will not be able to select that speaker in the SETUP SPEAKER LEVELS menu. Set the SPL meter to use 75 dB SPL, C Weighting and SLOW response. Adjust each speakers level up or down to achieve the desired THX reference level of 75 dB SPL.

Note: if you must do this adjustment with out the aid of an SPL meter, you may do it by ear and adjust each speaker for equal volume. You may wish to go through the speakers several times to get a reasonable result.

Also note that the VOLUME on the remote will not function in this menu.

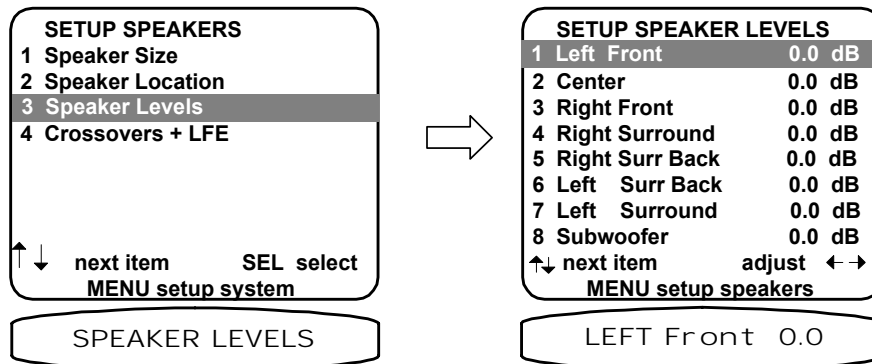

	From Remote	From Front Panel	Action
1	▲(PAUSE) or ▼(STOP)	∧ (UP) or ∨ (DOWN)	move to Speaker Levels
2	SEL or ENTER	↵ (ENTER)	activate SETUP SPEAKER LEVELS
3	▲(PAUSE) or ▼(STOP)	∧ (UP) or ∨ (DOWN)	move to Left Front
4	◀(REW) or ▶(FF)	VOLUME KNOB	adjust left level to a convenient reference level
5	▲(PAUSE) or ▼(STOP)	∧ (UP) or ∨ (DOWN)	move to Center
6	◀(REW) or ▶(FF)	VOLUME KNOB	adjust center level to match left
7	repeat 5-6 for each speaker	repeat 5-6 for each speaker	repeat until all levels match
8	MENU	∟ MENU	return to SETUP SPEAKERS

## Crossovers + LFE

Usually these settings may be left set to the factory defaults. However, your receiver allows 'fine tuning' of the system parameters most useful in setting up a high end audio system.

**Set the high and low pass filters' crossover frequency** - This sets the frequency at which bass tones are removed from the small main speakers and sent to the subwoofer. If you use very small main speakers you may wish to raise the crossover above 80 Hz. You may get better results with fairly large speakers by setting them to small and using a low crossover frequency so only the lowest tones are sent to the subwoofer. THX certified speakers are specifically designed for use with an 80 Hz crossover setting.

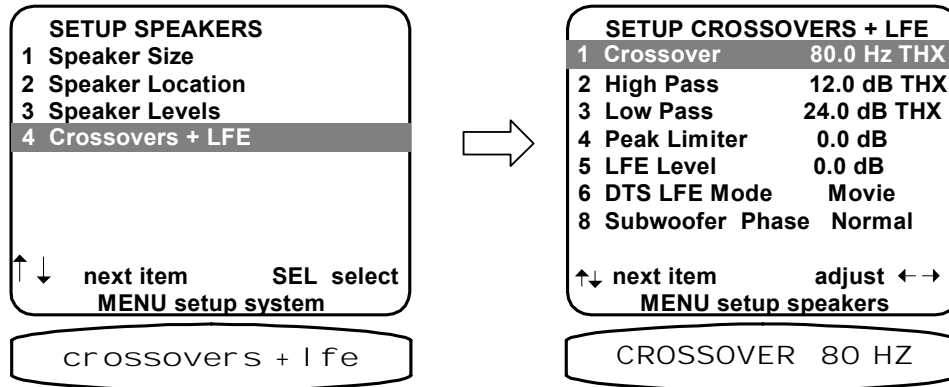

	From Remote	From Front Panel	Action
1	▲(PAUSE) or ▼(STOP)	∧ (UP) or ∨ (DOWN)	move to Crossovers + LFE
2	SEL or ENTER	↵ (ENTER)	activate SETUP CROSSOVERS + LFE
3	▲(PAUSE) or ▼(STOP)	∧ (UP) or ∨ (DOWN)	move to Crossover
4	◀(REW) or ▶(FF)	VOLUME KNOB	adjust frequency to desired value

**Set the high pass filters slope** - A crossover doesn't simply send all content above 81 Hz to the main speakers and all content below 79 Hz to the sub. Instead there is a gradual transition. The crossover point is the frequency at which the amount of information in the sub and main speaker is equal. The crossover slope determines how gradual or abrupt this transition occurs. More gradual slopes generally result in a smoother transition from main to sub. However, gradual transitions can cause distortion in small main speakers because too much bass is sent to them. Gradual transitions with higher crossover settings can also cause the perceived location of a sound to move from the correct main speaker to the sub's location. THX speakers are specifically designed to use a 24 dB slope for the subwoofer and a 12 dB slope for the main speakers.

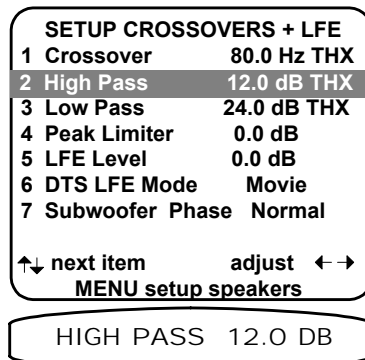

	From Remote	From Front Panel	Action
1	▲(PAUSE) or ▼(STOP)	∧ (UP) or ∨ (DOWN)	move to High Pass
2	◀(REW) or ▶(FF)	VOLUME KNOB	adjust filter slope to desired value



**Set the low pass filters slope -**

**SETUP CROSSOVERS + LFE**

1 Crossover 80.0 Hz THX  
 2 High Pass 12.0 dB THX  
 3 Low Pass 24.0 dB THX  
 4 Peak Limiter 0.0 dB  
 5 LFE Level 0.0 dB  
 6 DTS LFE Mode Movie  
 7 Subwoofer Phase Normal

↑↓ next item      adjust ←→  
**MENU setup speakers**

LO PASS 24.0 DB

	From Remote	From Front Panel	Action
1	▲(PAUSE) or ▼(STOP)	∧ (UP) or ∨ (DOWN)	move to Low Pass
2	◀(REW) or ▶(FF)	VOLUME KNOB	adjust filter slope to desired value

**Set the peak limiter** - The peak limiter is designed to limit the maximum level of bass information. When set to 0.0 dB (default) the limiter is disabled. If your system is being used with a subwoofer not incorporating it's own limiter or have no subwoofer, then the peak limiter may need to be set to allow proper operation.

**Warning - the peak limiter test tone may result in extremely high volume levels**

Peak limiter level calibration allows you to set the maximum obtainable volume sent to the speakers reproducing bass information. For best results it is important that you perform this calibration when you initially install your receiver, or whenever you change speakers. You set this parameter by ear using the test tone supplied when entering the peak limiter. Sit in your normal listening spot. Check that you are in SETUP CROSSOVERS + LFE and that your remote is in B&K mode. Moving to Peak Limiter and pressing SEL or ENTER activates a noise test tone which will aid in adjusting the level to the point at which the bass speakers sound like they are having difficulty reproducing the test tone. Once this level is achieved, reduce the adjustment 1 dB and press the SEL button on the remote to save the peak limit setting. If the level is increased all the way to 0 dB with no perceived distortion, then just leave the setting at 0 dB. If the correct values is known, the peak limiter may be set without the use of the test tone.

**SETUP CROSSOVERS + LFE**

1 Crossover 80.0 Hz THX  
 2 High Pass 12.0 dB THX  
 3 Low Pass 24.0 dB THX  
 4 Peak Limiter 0.0 dB  
 5 LFE Level 0.0 dB  
 6 DTS LFE Mode Movie  
 7 Subwoofer Phase Normal

SEL to setup peak limiter  
 ↑↓ next item      adjust ←→  
**MENU setup speakers**

→

**SETUP CROSSOVERS + LFE**

1 Crossover 80.0 Hz THX  
 2 High Pass 12.0 dB THX  
 3 Low Pass 24.0 dB THX  
 4 Peak Limiter -24.0 dB  
 5 LFE Level 0.0 dB  
 6 DTS LFE Mode Movie  
 7 Subwoofer Phase Normal

SEL to save peak limiter  
 ↑↓ next item      adjust ←→  
**MENU setup speakers**

LIMIT 0.0 DB

LIMIT -24.0 DB

	From Remote	From Front Panel	Action
1	▲(PAUSE) or ▼(STOP)	∧ (UP) or ∨ (DOWN)	move to Peak Limiter
2	SEL or ENTER	∩ (ENTER)	activate the peak limiter test tone
3	◀(REW) or ▶(FF)	VOLUME KNOB	adjust level to desired value
4	SEL or ENTER	∩ (ENTER)	saves the peak limiter value

**Set your LFE (.1) channel level** - Usually this will be set to 0.0 dB (default). However, if you have no subwoofer you may wish to reduce the low frequency effects (LFE) channel to lessen its contribution to the bass going to your remaining large speakers. Or, even with a subwoofer, you may just wish to reduce the overall LFE level, especially in an apartment situation. Note that this affects only the separate LFE (.1) channel available on Dolby Digital and DTS material it has no effect on the reproduction of normal bass from the front, center, or surround channels.

**SETUP CROSSOVERS + LFE**

1 Crossover      80.0 Hz THX  
 2 High Pass     12.0 dB THX  
 3 Low Pass      24.0 dB THX  
 4 Peak Limiter   0.0 dB  
 5 LFE Level      0.0 dB  
 6 DTS LFE Mode   Movie  
 7 Subwoofer Phase Normal

↕ next item      adjust ←→  
**MENU setup speakers**

LFE LVL      0.0 DB

	From Remote	From Front Panel	Action
1	▲(PAUSE) or ▼(STOP)	∧ (UP) or ∨ (DOWN)	move to LFE Level
2	◀(REW) or ▶(FF)	VOLUME KNOB	adjust level to desired value

**Set DTS LFE (.1) channel mode preference** - Usually this will be set to Movie (default). However, some DTS music material is mixed for a reduced LFE setting and may sound more natural with this set to Music. Note that this affects only the separate LFE (.1) channel available on DTS material and has no effect on the reproduction of normal bass from the front, center, or surround channels.

**SETUP CROSSOVERS + LFE**

1 Crossover      80.0 Hz THX  
 2 High Pass     12.0 dB THX  
 3 Low Pass      24.0 dB THX  
 4 Peak Limiter   0.0 dB  
 5 LFE Level      0.0 dB  
 6 DTS LFE Mode   Movie  
 7 Subwoofer Phase Normal

↕ next item      adjust ←→  
**MENU setup speakers**

DTS LFE      movie

	From Remote	From Front Panel	Action
1	▲(PAUSE) or ▼(STOP)	∧ (UP) or ∨ (DOWN)	move to DTS LFE Mode
2	◀(REW) or ▶(FF)	VOLUME KNOB	adjust to desired value

**Set subwoofer phase** - In addition to the subwoofer location adjustment (see Speaker Location above), your receiver has an option to 'invert the phase' of the information sent to the subwoofer. This adjustment is sometimes needed to correct 'lack of low end' problems created with the interaction between the subwoofer and other large speakers in a listening room. The correct subwoofer phase adjustment is the one which allows the loudest listening level.

**SETUP CROSSOVERS + LFE**

1 Crossover            80.0 Hz THX  
 2 High Pass            12.0 dB THX  
 3 Low Pass             24.0 dB THX  
 4 Peak Limiter        0.0 dB  
 5 LFE Level            0.0 dB  
 6 DTS LFE Mode      Movie  
 7 Subwoofer Phase   Normal

↑↓ next item            adjust ←→  
**MENU setup speakers**

SUB PHASE normal

	From Remote	From Front Panel	Action
1	▲(PAUSE) or ▼(STOP)	∧ (UP) or ∨(DOWN)	move to DTS LFE Mode
2	◀(REW) or ▶(FF)	VOLUME KNOB	adjust to desired value
3	MENU	∟ MENU	return to SETUP SPEAKERS
4	MENU	∟ MENU	return to SETUP SYSTEM

## Room Equalization

Usually these settings may be left set to the factory defaults. However, these settings allow you to correct or reduce the various tonal errors that occur during reproduction of audio in a home theater.

The room equalization menu allows for two types of adjustments.

- 1) A notch filter that allows you to 'Notch' or reduce the accentuated bass created in a room with multiple speakers (see Setting up the notch filter).
- 2) Variable bass and treble controls allow you to configure a default 'Variable EQ' setting that best suits your listening room needs.

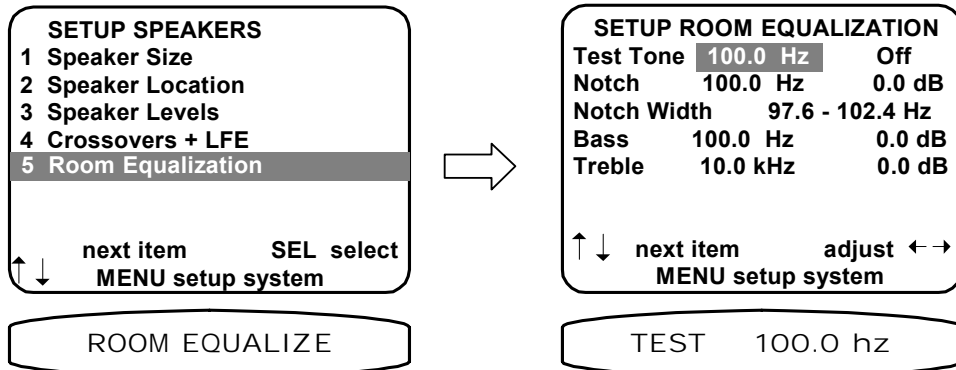

	From Remote	From Front Panel	Action
1	▲(PAUSE) or ▼(STOP)	∧ (UP) or ∨ (DOWN)	move to Room Equalization
2	SEL or ENTER	↵ (ENTER)	activate SETUP EQUALIZATION

**Using the test tone generator** - your receiver has a low frequency sine wave generator (20 to 300 Hz) available as an aid in determining the most offensive frequency to notch. Usually this test tone generator will be used with the aid of an SPL meter in a similar fashion as that described in Setup Speaker Levels. The tone generator may also be used to show up any mechanical room vibrations that should be reduced or eliminated. While active, the generator has adjustable frequency and three selectable output levels.

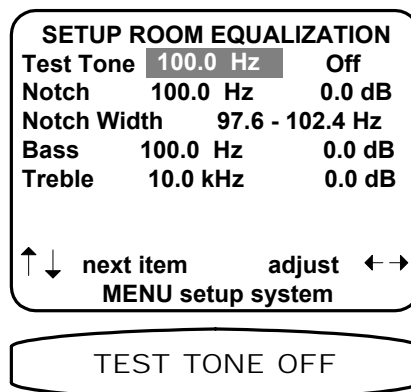

	From Remote	From Front Panel	Action
1	▲(PAUSE) or ▼(STOP)	∧ (UP) or ∨ (DOWN)	move to Test Tone frequency
2	◀(REW) or ▶(FF)	VOLUME KNOB	set to desired frequency
3	▲(PAUSE) or ▼(STOP)	∧ (UP) or ∨ (DOWN)	move to Notch, Bass or Treble adjustments
4	◀(REW) or ▶(FF)	VOLUME KNOB	set to desired values
5	repeat 1 - 4	repeat 1 - 4	repeat until desired result is achieved
6	MENU	∠ MENU	return to SETUP SYSTEM

**Setup up the notch filter** - your receiver may be set to correct accentuated bass information caused by room size and speaker positioning. The notch filter setup is independent of any other EQ settings and is engaged at all times, regardless of the EQ selection.

**SETUP ROOM EQUALIZATION**

Test Tone 100.0 Hz      Off

Notch 100.0 Hz      0.0 dB

Notch Width 97.6 - 102.4 Hz

Bass 100.0 Hz      0.0 dB

Treble 10.0 kHz      0.0 dB

↑ ↓ next item      adjust ← →

MENU setup system

notch 100.0 hz

	From Remote	From Front Panel	Action
1	▲(PAUSE) or ▼(STOP)	∧ (UP) or ∨ (DOWN)	move to Notch Frequency
2	◀(REW) or ▶(FF)	VOLUME KNOB	set to desired notch frequency
3	▲(PAUSE) or ▼(STOP)	∧ (UP) or ∨ (DOWN)	move to Notch Level
4	◀(REW) or ▶(FF)	VOLUME KNOB	set to desired notch level
5	▲(PAUSE) or ▼(STOP)	∧ (UP) or ∨ (DOWN)	move to Notch Width
6	◀(REW) or ▶(FF)	VOLUME KNOB	set to desired notch width
7	repeat 1 - 6	repeat 1 - 6	repeat until bass accentuation is reduced
8	MENU	∠ MENU	return to SETUP SYSTEM

**Setup variable 'EQ 1'** - allows you to set default bass and treble settings for use with all input sources. Many systems allow only adjustment of bass and treble levels at fixed frequency points. Your receiver allows you to adjust level and frequency to aid in adjusting your room for a flat frequency response. Set bass and treble to the values you would like have restored into the variable 'EQ 1' whenever your unit comes out of sleep or whenever manually selecting a source (see Select variable 'EQ 1' under OPERATION Equalization).

**SETUP ROOM EQUALIZATION**

Test Tone 100.0 Hz      Off

Notch      100.0 Hz      0.0 dB

Notch Width      97.6 - 102.4 Hz

Bass      100.0 Hz      0.0 dB

Treble      10.0 kHz      0.0 dB

↑ ↓ next item      adjust ← →

MENU setup system

bass      100.0 HZ

	From Remote	From Front Panel	Action
1	▲(PAUSE) or ▼(STOP)	∧ (UP) or ∨ (DOWN)	move to Bass Frequency
2	◀(REW) or ▶(FF)	VOLUME KNOB	set to desired bass frequency
3	▲(PAUSE) or ▼(STOP)	∧ (UP) or ∨ (DOWN)	move to Bass Level
4	◀(REW) or ▶(FF)	VOLUME KNOB	set to desired bass level
5	▲(PAUSE) or ▼(STOP)	∧ (UP) or ∨ (DOWN)	move to Treble Frequency
6	◀(REW) or ▶(FF)	VOLUME KNOB	set to desired treble frequency
7	▲(PAUSE) or ▼(STOP)	∧ (UP) or ∨ (DOWN)	move to Treble Level
8	◀(REW) or ▶(FF)	VOLUME KNOB	set to desired treble level
9	MENU	∠ MENU	return to SETUP SYSTEM

## Display

This menu allows you to set various aspects of your video and front panel displays. Make sure you are in the SETUP MENUS and your remote is in B&K mode.

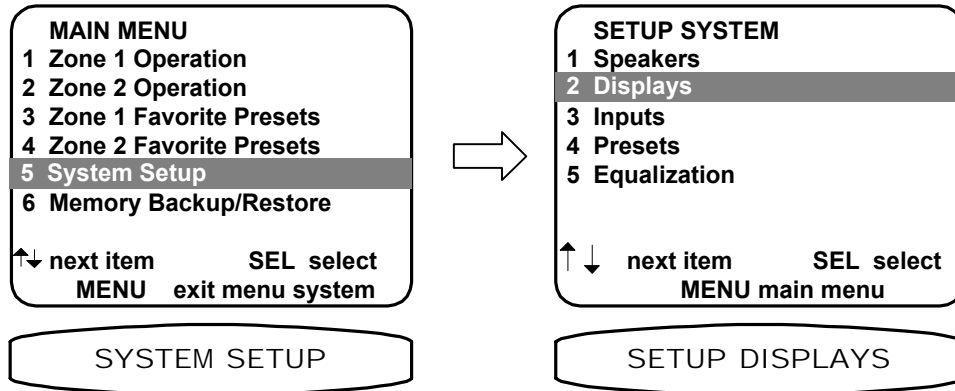

	From Remote	From Front Panel	Action
1	▲(PAUSE) or ▼(STOP)	∧ (UP) or ∨ (DOWN)	move to Displays
2	SEL or ENTER	┘ (ENTER)	activate SETUP DISPLAYS

Set the intensity of the front panel display-

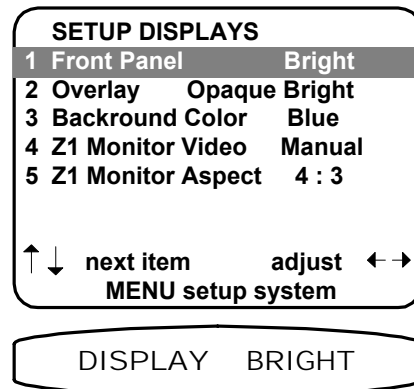

	From Remote	From Front Panel	Action
1	▲(PAUSE) or ▼(STOP)	∧ (UP) or ∨ (DOWN)	move to Front Panel
2	◀(REW) or ▶(FF)	VOLUME KNOB	change display brightness

**Set the intensity of on-screen video overlays** - Overlays will appear when you change a receiver setting or your receiver detects a change in the incoming audio or video information. Transparent mode allows video to be seen behind the overlay.

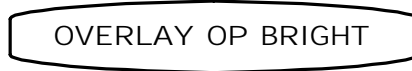
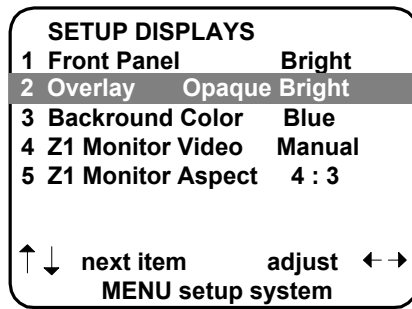

	From Remote	From Front Panel	Action
1	▲(PAUSE) or ▼(STOP)	∧ (UP) or ∨ (DOWN)	move to Overlay
2	◀(REW) or ▶(FF)	VOLUME KNOB	change overlay type

Set the background color for your on-screen display menus -

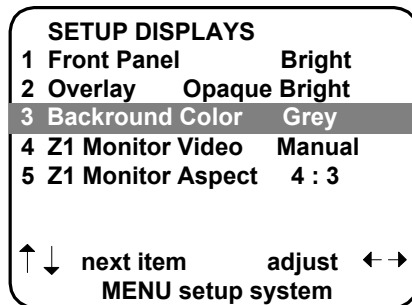

	From Remote	From Front Panel	Action
1	▲(PAUSE) or ▼(STOP)	∧ (UP) or ∨ (DOWN)	move to Background Color
2	◀(REW) or ▶(FF)	VOLUME KNOB	change background color

**Set your Zone 1 (A) monitor video operation** - More than likely you have a composite or S-VIDEO monitor which will be used to view your selected source's video. Your receiver has the capability to process BOTH composite video and S-VIDEO simultaneously. Your receiver DOES NOT convert between composite video and S-VIDEO.

In MANUAL mode your receiver will always send both composite video and S-VIDEO to your Zone 1 (A) monitor. When your receiver first detects video on a selected source it checks to see if it is composite or S-VIDEO or both. It then shows a message which displays the current status as to the incoming video 'Composite', 'S-VIDEO' or 'Both Video', to both video outputs. When no video is available on one of the video formats (composite or S-VIDEO), it will send its internal background screen to the monitor and then prompt you if there is video available using the other video format.

In AUTO mode, your receiver will look for S-VIDEO on the selected source. If it finds S-VIDEO it will send it to your Zone 1 (A) monitor. Your receiver will also look for composite video on the selected source. If it finds composite video it will send it to your Zone 1 (A) monitor. If it finds no S-VIDEO on the selected source it will send no video. Similarly if it finds no composite video on the selected source it will send no video. This allows for the use of your Monitor's auto video detection circuit (if available) to select the proper video format for your viewing.



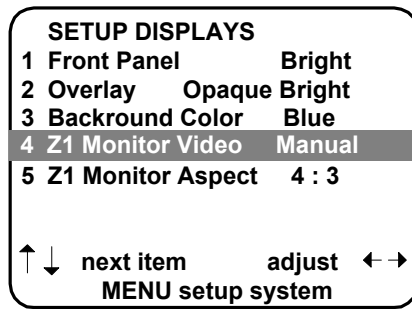

	From Remote	From Front Panel	Action
1	▲(PAUSE) or ▼(STOP)	∧ (UP) or ∨ (DOWN)	move to Zone 1 (A) Video Monitor
2	◀(REW) or ▶(FF)	VOLUME KNOB	adjust for desired operation

**Set the Zone 1 (A) Monitor Aspect Ratio** - During normal operation, your receiver will overlay status information on your video monitor. This information is normally displayed at the bottom of the monitor. However, if you are viewing letterbox material on a 16:9 (widescreen) monitor, this information will be cut off. Selecting the 16:9 monitor aspect ratio will position the status display within the letterbox viewing area. This setting does NOT affect setup menus. Your monitor must be set for normal 4:3 viewing in order to display the entire menu page.

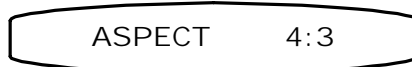
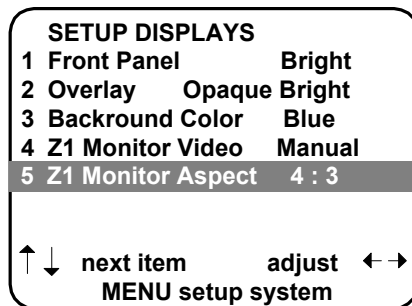

	From Remote	From Front Panel	Action
1	▲(PAUSE) or ▼(STOP)	∧ (UP) or ∨ (DOWN)	move to Zone 1 (A) Monitor Aspect
2	◀(REW) or ▶(FF)	VOLUME KNOB	change aspect ratio
3	MENU	∟ MENU	return to SETUP SYSTEM

## Inputs

Usually these settings may be left set to the factory defaults. However, your receiver allows 'fine tuning' how your receiver operates after the selection of an input source. Make sure you are in the SETUP MENUS and your remote is in B&K mode.

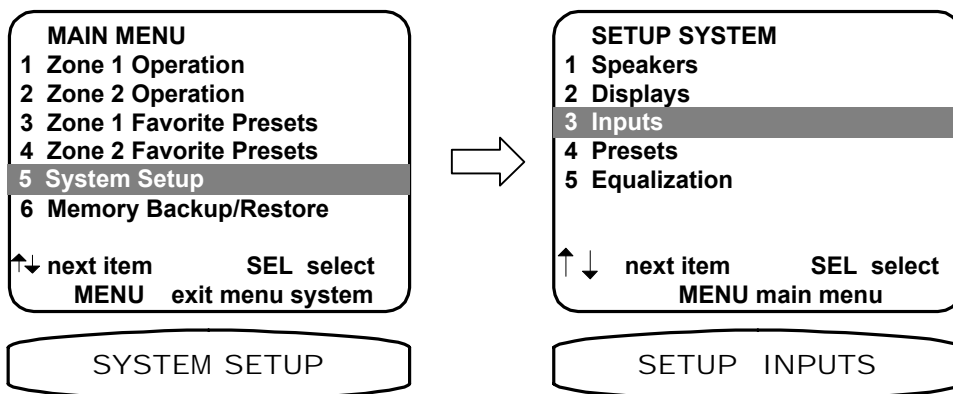

	From Remote	From Front Panel	Action
1	▲(PAUSE) or ▼(STOP)	∧ (UP) or ∨ (DOWN)	move to Inputs
2	SEL or ENTER	┘ (ENTER)	activate SETUP INPUTS

### Select input -

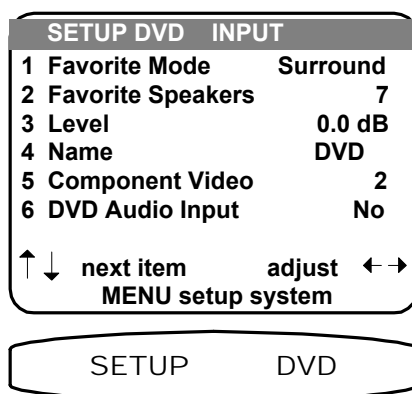

	From Remote	From Front Panel	Action
1	◀(REW) or ▶(FF)	VOLUME KNOB	select source

**Set the favorite audio listening mode** - Your processor provides for 4 audio listening modes Mono, Stereo, Surround and DVD Audio (Optional) (See AUDIO MODES). You may set a default audio mode and speaker selection (excluding selection 0 'Headphone', or selection 9 'LrRt') for each of your input sources. When a source is selected from the remote control or front panel, the audio mode will automatically be set to use this favorite mode and speaker selection. Note that DVDA mode can only be selected if that input is designated as the DVD audio input below and the internal DVDA switch has been set (see DVD Audio using the Coax digital inputs under MAKING THE CONNECTION).

**favorite audio listening mode continued**

Setting a favorite listening mode here will not prevent the system from automatically adjusting the listening mode in response to bitstream information, nor will it prevent the user from changing modes during normal operation. It is merely the mode that is chosen when that input is initially selected and no additional bitstream information is available. You can use the favorite Mode/Speakers along with the systems intelligence to arrive at your optimum listening modes while seldom needing to manually set modes. For example, you use a DVD player to play music CDs and DVD movies. You may prefer to listen to music CDs in their original 2-channel stereo, while you prefer Dolby Digital and DTS DVDs in 6-channel (“MATRIX”) mode. First select Favorite mode surround and favorite speakers 6. Then select favorite mode Stereo and favorite speakers 2. Your system will now automatically playback PCM CDs in two channel stereo and Dolby Digital or DTS DVDs in Surround 6. And if you temporarily want a different mode, you can still change it during normal system operation

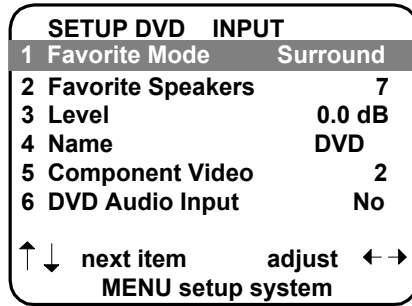

	From Remote	From Front Panel	Action
2	▲(PAUSE) or ▼(STOP)	∧ (UP) or ∨ (DOWN)	move to Favorite Mode
3	◀(REW) or ▶(FF)	VOLUME KNOB	select favorite audio mode for use source

**Set the favorite speakers** - Allows you to set a different default number of speakers (excluding selection 0 'Headphone', or selection 9 'Lt Rt') for each of your input sources. When a source is selected from the remote control or front panel, audio will be sent to the number of speakers set in favorite speakers. See AUDIO MODES and the table below.

Favorite Speakers	Notes	Speakers Used
0 (headphone)	not an allowed favorite mode setting	L, R (always down mixed to stereo)
1	mono with all audio modes	C (always down mixed to mono)
2		L, R
3		L, C, R
4		L, R, Sl, Sr
4B		L, R, Sbl, Sbr
5		L, C, R, Sl, Sr
5B		L, C, R, Sbl, Sbr
6	Allows the MATRIX mode	L, C, R, Sl, Sr, Sbl, Sbr
7	Sbl=Sl and Sbr=Sr	L, C, R, Sl, Sr, Sbl, Sbr
8 (direct)	uses L, R analog inputs	L, R
9 (LtRt)	not an allowed favorite mode setting	L, R (Dolby Surround encoding)

SETUP DVD INPUT	
1 Favorite Mode	Surround
2 Favorite Speakers	7
3 Level	0.0 dB
4 Name	DVD
5 Component Video	2
6 DVD Audio Input	No
↑ ↓ next item      adjust ← → MENU setup system	

DVD SPEAKERS 7

	From Remote	From Front Panel	Action
4	▲(PAUSE) or ▼(STOP)	∧ (UP) or ∨ (DOWN)	move to Favorite Speakers
5	◀(REW) or ▶(FF)	VOLUME KNOB	select favorite speakers for use with source

**Set input source level** - Allows you to match the levels of your input sources so that there are no large changes in volume as you change from one source to another. This is for your convenience only and need not be performed unless you wish to. You may use a SPL meter or your ear to adjust the levels. Note that the levels will depend not only on this setting but also on the source material being played back. You may wish to use a test disc.

SETUP DVD INPUT	
1 Favorite Mode	Surround
2 Favorite Speakers	7
3 Level	0.0 dB
4 Name	DVD
5 Component Video	2
6 DVD Audio Input	No
↑ ↓ next item      adjust ← → MENU setup system	

DVD LVL 0.0 DB

	From Remote	From Front Panel	Action
6	▲(PAUSE) or ▼(STOP)	∧ (UP) or ∨ (DOWN)	move to Level
7	◀(REW) or ▶(FF)	VOLUME KNOB	adjust to desired level

**Set input source name** - From the factory, your receiver will display source names that match those printed on the rear of the receiver and on the supplied remote. However, your receiver allows you to change the displayed names to match the actual sources used. If you do not want to change the names then skip this step. Note that the tuner name cannot be changed.

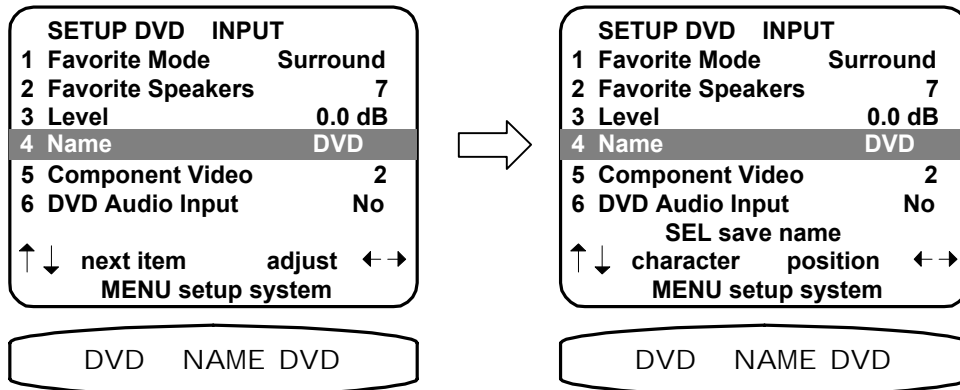

	From Remote	From Front Panel	Action
8	▲(PAUSE) or ▼(STOP)	∧ (UP) or ∨ (DOWN)	move to Name
9	SEL or ENTER	┘ (ENTER)	activate NAME editing
10	◀(REW) or ▶(FF)	VOLUME KNOB	move to character position
11	▲(PAUSE) or ▼(STOP)	∧ (UP) or ∨ (DOWN)	change blinking character
12	◀(REW) or ▶(FF)	VOLUME KNOB	move to new character position
13	repeat 10 - 12	repeat 10 - 12	continue changing characters
14	SEL or ENTER	┘ (ENTER)	deactivate NAME editing

**Set component video** - Allows you to associate one of two component video inputs with each of your input sources. When you choose that source for viewing, the associated component video input will be routed to the component video output **COMPONENT VIDEO SWITCHING IS CURRENTLY NOT SUPPORTED IN THE AVR202 Plus.**

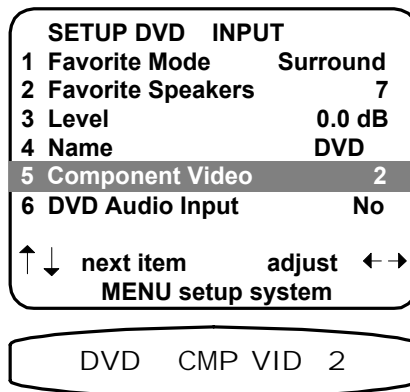

	From Remote	From Front Panel	Action
15	▲(PAUSE) or ▼(STOP)	∧ (UP) or ∨ (DOWN)	move to Component Video
16	◀(REW) or ▶(FF)	VOLUME KNOB	select 1 or 2 for use with source

**Set DVD audio input** - Allows you to select which ONE input source to dedicate for use with the DVD Audio inputs. This setting is not necessary if there is no need for a DVD audio or other 5.1 input source. When you select Yes for a particular input, any previously selected DVD Audio input will be automatically reset to No. When you select No for a particular input, the favorite Mode is automatically set to DVD audio mode. Setting a source to DVD audio mode does not prevent you from using the digital inputs from that source. Simply select one of the other four listening modes to return to digital processing for the designated DVD audio input.

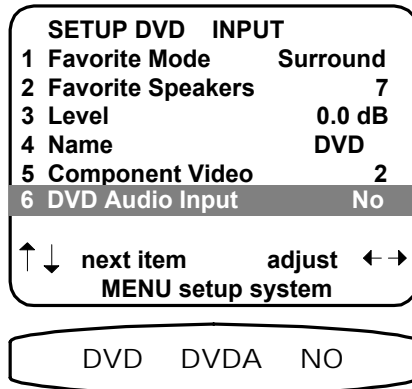

	From Remote	From Front Panel	Action
17	▲(PAUSE) or ▼(STOP)	∧ (UP) or ∨ (DOWN)	move to DVD Audio Input
18	◀(REW) or ▶(FF)	VOLUME KNOB	select Yes or No for use with source
19	repeat 1 - 16	repeat 1 - 16	continue for each input source
20	MENU	∟ MENU	return to SETUP SYSTEM

## Presets

Usually these settings may be left set to the factory defaults. However, your receiver allows 'fine tuning' of how presets operate. Make sure you are in the SETUP MENUS and your remote is in B&K mode.

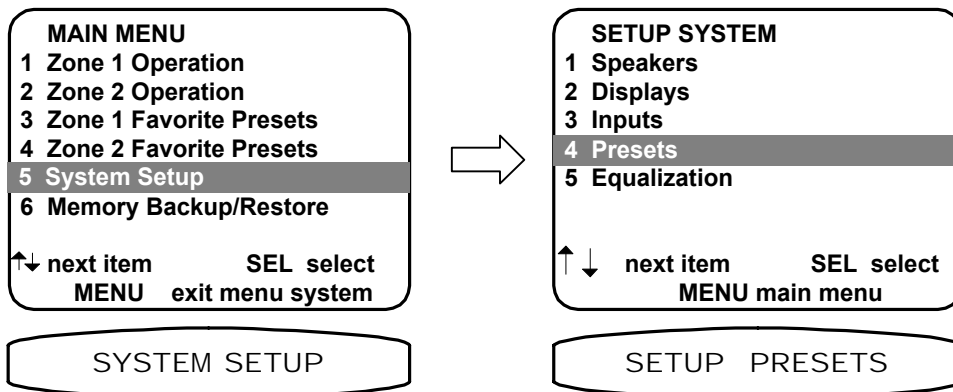

	From Remote	From Front Panel	Action
1	▲(PAUSE) or ▼(STOP)	∧ (UP) or ∨ (DOWN)	move to Presets
2	SEL or ENTER	∟ (ENTER)	activate SETUP PRESETS

**Use volume with presets** - Recalling a preset normally recalls the entire system settings that were present when the preset was saved. However, you may wish to recall presets with the current volume setting, rather than the volume setting when the preset was saved. If so, then set Volume in Presets to No.

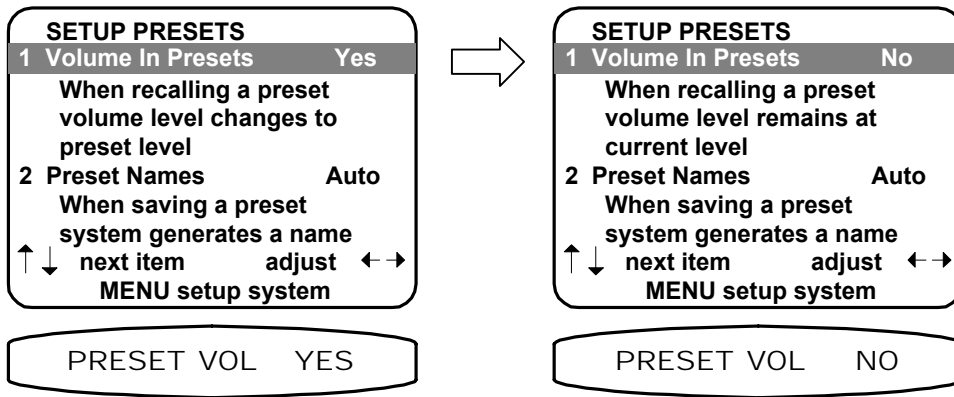

	From Remote	From Front Panel	Action
1	◀(REW) or ▶(FF)	VOLUME KNOB	select Yes or No

**Generating a name when saving a preset** - When you save a preset, your system automatically generates a simple name for the preset, which you can then change before confirming the preset save. You may wish to defeat this automatic naming so that any custom names that you have entered will not get erased each time you save a minor change to a preset. Turning auto naming off means that the name that is already present in the preset will be re-used when you save a new preset to that location. If you turn off auto naming you must be very careful to always enter an appropriate name. Otherwise you can end up with a preset that is named DVD, but actually recalls the V1 input, or is named FM 96.9 but actually recalls AM 1520!

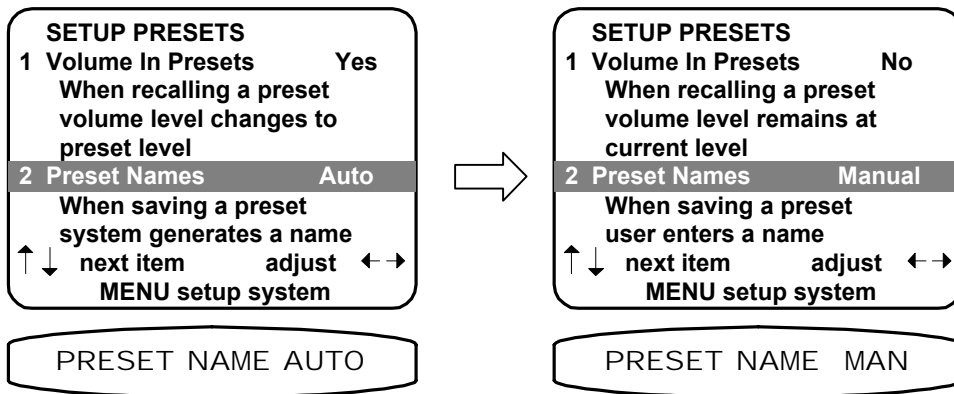

	From Remote	From Front Panel	Action
1	◀(REW) or ▶(FF)	VOLUME KNOB	select Auto or Manual
2	MENU	∠ MENU	return to SETUP SYSTEM

## MEMORY BACKUP

Your receiver continually saves any settings you have made even if power is lost. However, you may wish to save a backup of your settings in case of inadvertent changes to them. To perform a backup follow the procedure below. To restore backup settings perform the same procedure but select restore instead of backup. If you have never made a backup, then performing a restore will call back the original factory settings. Make sure you are in the MAIN MENU and your remote is in B&K mode.

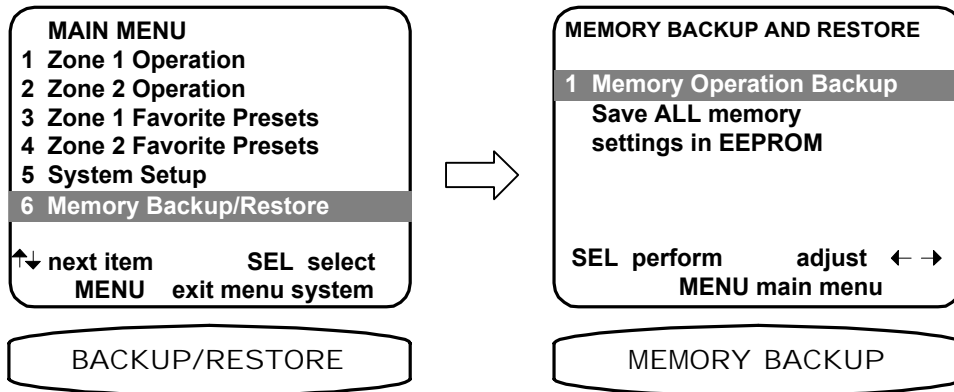

	From Remote	From Front Panel	Action
1	▲(PAUSE) or ▼(STOP)	∧ (UP) or ∨ (DOWN)	move to Memory Backup/Restore
2	SEL or ENTER	⌵ (ENTER)	activate MEMORY BACKUP AND RESTORE
3	◀(REW) or ▶(FF)	VOLUME KNOB	choose Backup or Restore
4	SEL or ENTER	⌵ (ENTER)	perform Backup or Restore
5	MENU	∟ MENU	return to MAIN MENU
6	MENU	∟ MENU	return to normal operation



# OPERATION

The following outlines the normal day-to-day operation of your processor from the supplied universal remote or directly from your processor's front panel. The universal remote is also capable of controlling other equipment and storing sequences of commonly used commands. All operations described below refer to the B&K Components Ltd. AV 7.1 System Remote Controller. Refer to the separate remote manual for details on these functions.

## POWER ON/OFF

The main power switch on the front panel of your receiver must be on for the receiver to operate. When this switch is off all power is removed from your receiver. This prevents turning it back on with the remote control. You can use the main power switch for normal day to day operation but we suggest you use the sleep function instead so that the receiver can be turned on and off from the remote. After turning on the main power you must wait a few seconds while your receiver restores its internal memory. You may want to turn off the main power switch when your receiver will be idle for extended periods of time or during periods of power line fluctuations. Your receiver will not lose its memory while the main power switch is off.

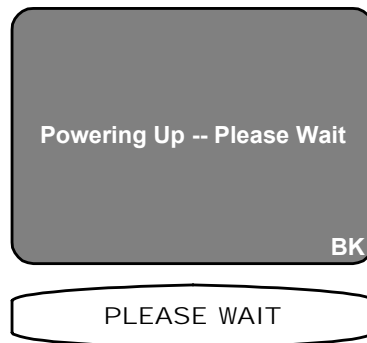

From Remote	From Front Panel	Action
can't turn off main power from remote	POWER ON/OFF	main power on/off

## SLEEP

Normally you will simply put your receiver to sleep (standby) when not in use. Sleep mode keeps a bare minimum of functions running in order to allow remote control operation and fast start up. Note that the front panel SLEEP button is lit while your receiver is asleep and is off when your receiver is operating. Also note that the remote POWER button is a 'power toggle' and will put your receiver in and out of sleep. OFF will always put the receiver into sleep. B&K or AUDIO will always wake up your receiver and set the remote to control the receiver

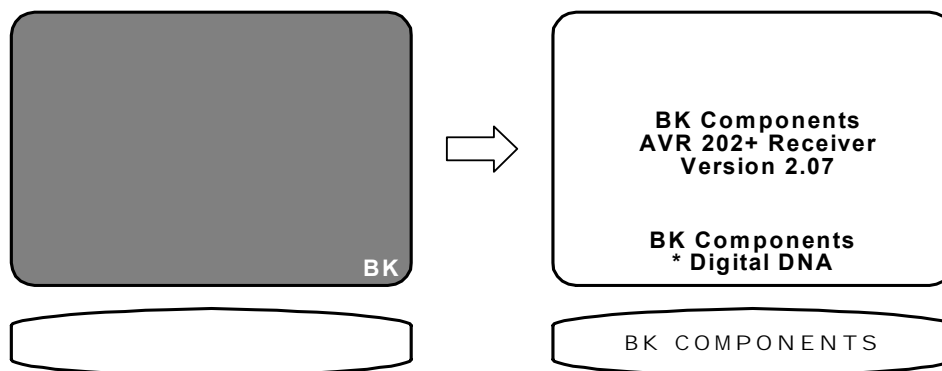

	From Remote	From Front Panel	Action
1	B&K or POWER	Ⓞ SLEEP	wake up receiver (POWER is a toggle)
2	OFF or POWER	Ⓞ SLEEP	put receiver to sleep (standby)

## CHOOSING A SOURCE

In general, the selected source will appear at the Zone 1 (A) output, the TAPE output, and the V1 output. To prevent feedback, TAPE input will not appear at TAPE output and V1 input will not appear at V1 output.

**DVD Surround 7 EQ Variable**  
DVD 5.1 48k Both Video

DVD SURROUND 7

From Remote	From Front Panel	Action
desired source (press twice)	<input type="checkbox"/> (SOURCE) step to source	select desired source - remote now controls source
B&K		return control to receiver if desired

Note: if your source has separate ON and OFF control like your receiver, pressing the source button twice will also turn on that source. If not, you will have to hit POWER while the remote is still set to the desired source.

**TAPE MONITOR** - If you have an analog three-head cassette or reel-to-reel analog tape recorder you may wish to use TAPE MONITOR, which allows you to hear exactly what is on the tape as you are recording.

**TAPE Stereo 7 EQ Variable**  
Analog 2.0 96k Both Video

TAPE SURROUND 7

From Remote	From Front Panel	Action
desired source (press twice)	<input type="checkbox"/> (SOURCE) step to source	select desired source or TUNER source will appear on TAPE and V1 outs
		wait a few seconds while receiver analyzes selected source
TAPE (press twice)	<input type="checkbox"/> (SOURCE) step quickly to TAPE	select TAPE monitor TAPE will appear on Zone 1 (A) out

Note: The tape monitor loop only allows recording of analog inputs. If you simply choose the source you wish to tape without then selecting TAPE MONITOR then you can make analog recordings of digital inputs as well as analog inputs.

## AM/FM TUNER

**TUNER Stereo 7 EQ Variable**  
FM 102.5 2.0 96k Both Video

FM 102.5 STEREO 7

	From Remote	From Front Panel	Action
1	B&K		make sure remote is in B&K mode
2	AM or FM	<input type="checkbox"/> (SOURCE) step to AM or FM	select desired TUNER Band
3	TUNE+ or TUNE-	^ (UP) or v (DOWN)	manually tune up or down to desired frequency see AM/FM TUNER SETTING for DIRECT / SEEK / TUNE
4	SEL or ENTER	↵ (ENTER)	set FM stereo/mono

Note: For a few seconds after performing any tuner operation ( AM, FM, or TUNE+/-) you may directly enter a frequency from the remote control's numeric keypad. The MONO or ST audio mode buttons on the remote control and select mono/stereo.

## ADJUSTING THE VOLUME



From Remote	From Front Panel	Action
VOLUME ▲ or VOLUME ▼	VOLUME KNOB	adjust volume
MUTE	can't do from front panel	instant volume all the way down press MUTE again to restore

Note: The front panel VOLUME KNOB is used to control multiple functions and, therefore, cannot always control the volume. The VOLUME KNOB may control volume in the menu system when not used for parameter adjustments. During normal operation the VOLUME KNOB may switch to controlling other functions but will return to MASTER LEVEL after a few seconds. The remote's VOLUME ▲ or VOLUME ▼ will always change master volume level except in the SETUP SPEAKER LEVELS and SETUP 'Source' INPUT menus.

## TEMPORARY LEVEL ADJUSTMENTS

Occasionally you may find that a you can't hear the dialog very well in a particular movie, or a movie has too much bass, etc. You can temporarily adjust the center, surround, and subwoofer settings without changing the permanent settings you made in the under SETUP SPEAKER LEVELS menu.

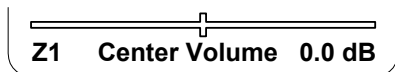



From Remote	From Front Panel	Action
CENTER ▲ or CENTER ▼	see Zone 1 (A) operation	adjust center volume
REAR ▲ or REAR ▼	see Zone 1 (A) operation	adjust surround volume
SUB ▲ or SUB ▼	see Zone 1 (A) operation	adjust subwoofer volume

Note: these settings are temporary and will be lost when you put your receiver to sleep or turn off the main power. If you have particular temporary setting that you use often, you may save them in a preset.

# AUDIO MODES

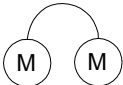
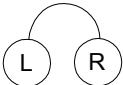
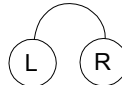
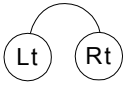
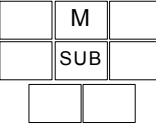
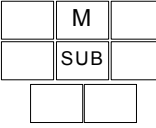
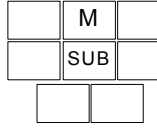
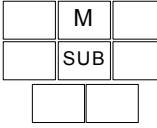
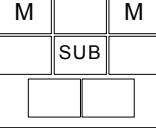
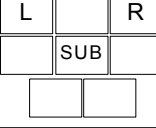
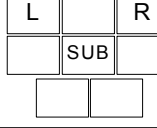
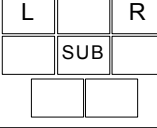
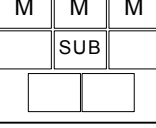
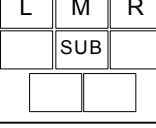
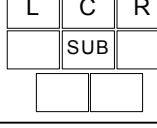
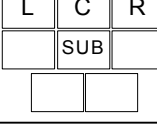
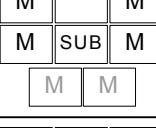
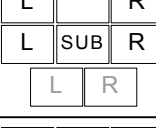
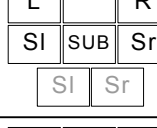
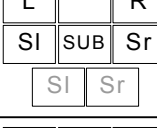
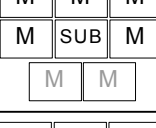
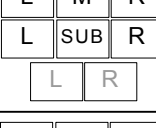
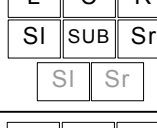
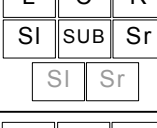
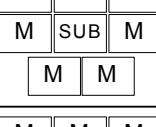
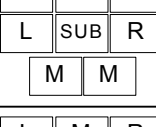
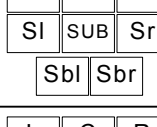
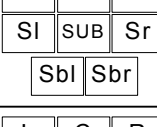
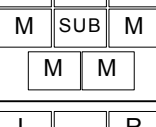
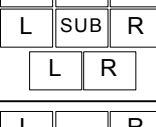
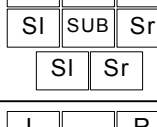
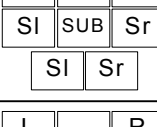
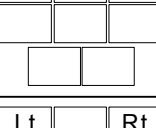
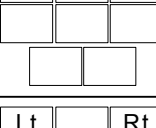
Your receiver is designed to work with 4 audio listening modes. Under normal operation you may simply select Mono, Stereo, Surround or DVD Audio via the remote control. In addition, you may choose an audio listening mode immediately followed by a speaker selection. The table below shows how your receiver will route audio with the various audio modes and speaker selection combinations. This table assumes seven full range speakers plus a subwoofer. If your speaker configuration is different from this make sure you have performed the set up procedures described previously (see SETUP SPEAKER SIZE). When the setup is correctly performed your receiver will route audio to fewer/smaller speakers with the needed corrections to volume and "down mixing" applied automatically.

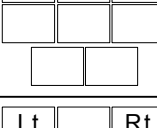
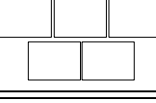
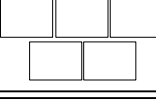
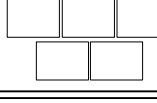
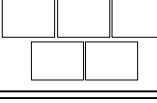
	AUDIO MODE			
Speakers	Mono	Stereo	Surround	DVD Audio
Select 0 Headphone				
Select 1				
Select 2				
Select 3				
Select 4 Select 4B				
Select 5 Select 5B				
Select 6				
Select 7				
Select 8 Direct 'Analog'				
Select 9 (Lt Rt)				

## Audio Mode description

### MONO

Sums the incoming audio information to a single channel and routes it to the desired speaker. Useful during FM tuner operation having weak RF signal strengths. It may also be useful when you have a large group where it is difficult to put everyone near the optimum listening position.

### STEREO

Sums the incoming audio information into Left, Right, and Mono channels and routes them to the desired speaker selection. Useful for purist (STEREO 2) listening and expanding the stereo effect to additional speakers.

### SURROUND

Provides Dolby Pro Logic processing for 2 channel analog or digital audio for the desired number of speakers. Fully decodes Dolby Digital and DTS 5.1 bitstreams and routes to the desired speakers. SURROUND 6 adds matrix processing of surround and back channels for Dolby Digital and DTS 5.1 bitstreams.

### DVD Audio

Use this audio mode with the analog outputs of a DVD Audio player or any other 5.1 audio source device (see Set DVD audio input under SETUP INPUTS). Like all other modes you may choose to route your DVD audio source to 1 - 7 speakers and even add matrix surround/back processing (DVDA 6). Note that DVD Audio mode can only be chosen for the input designated as the DVD Audio input in the setup menu. While no DVD Audio input is assigned (factory default) the DVD Audio mode is inactive.

### Special Considerations

After selecting an audio mode, you may enter 0 - 9 to select the desired number of speakers that will be used to reproduce the processed audio. Three of these selections (0, 8, 9) require extra consideration to fully understand their capability as they do not relate specifically to the number of speakers in your system.

**Speaker selection 0 'HEADPHONE'** - use when the receiver is to be used with Headphones and it is desired to turn off the systems power amplifiers. While in 'HEADPHONE', the equalizer feature of your unit remains operational (see EQUALIZATION 'EQ'). Selecting an audio mode for use with speaker selection 0 'HEADPHONE' effects all inputs simultaneously. This feature allows the 'Headphone' selection to stay in effect until the unit is put to SLEEP, or you select an audio mode for use with other than 0 speakers. Note 'HEADPHONE' is not allowed for use in Favorite Mode setup. Also, Control Out 1 may be turned off (factory default) depending on how your receiver has been set up (see ADVANCED FEATURES), allowing you to turn off any external amplifiers or powered subwoofers with compatible CONTROL inputs. **WARNING: in order to provide full range audio to your headphones, it is necessary to override the bass management processing in your receiver. If you are using external amplifiers or powered speakers with no CONTROL OUT capability then full range audio (including LFE for Dolby Digital and DTS) will also be sent to your front left and right speakers. If you have small front speakers we strongly suggest you manually turn off your external amplifiers or powered speakers before switching to selecting 'HEADPHONE' operation. Otherwise you may damage your speakers.**

**Speaker selection 8 'DIRECT'** - allows selection of the 'analog' signals connected to the currently selected input sources L & R RCA audio inputs overriding the use of optical or coax S/PDIF. No processing is applied to the audio signals other than level control. Use 'DIRECT' when NO audio processing is desired, This may be desirable if you use an outboard digital-to-analog converter or Super Audio CD player. Note, while in 'DIRECT', the equalizer feature of your unit is not available and disabled (see EQUALIZATION 'EQ').

**Speaker selection 9 'LtRt'** - Normally, your tape outputs contain the analog L/R inputs from the selected source. If you wish to make a recording from the digital inputs, select mode 9 (LtRt - Left total, Right total)). Selecting an audio mode for use with speaker selection 9 'LtRt' effects all inputs simultaneously. This feature allows 'LtRt' to stay in effect until the unit is put to SLEEP, or you select an audio mode for use with other than 9 speakers. Speaker selection 9 'LtRt', is not allowed for use in Favorite Mode setup. Your receiver will convert the digital signal to a Dolby Surround compatible 2 channel signal for recording. Upon playback you will get matrix surround encoded sound, even if the original signal was Dolby Digital or DTS. Note that the LtRt signal also appears at your front left and right speakers and is full range. If you use small front speakers it is recommended that you turn down the volume before engaging LtRt mode. Note, while in 'LtRt', the equalizer feature of your unit is not available and disabled (see EQUALIZATION 'EQ').

**Why do I need all these audio modes and speaker selections?**

Many people will be happy leaving their receiver in the SURROUND audio mode all the time. Your receiver will automatically switch back and forth between Dolby Pro Logic, Dolby Digital and DTS. Stereo material will be played back with Pro Logic decoding. Pro Logic's extraction of mono information to the center channel works just as well on stereo (non-Pro Logic encoded) material and may provide improved imaging, especially when sitting away from the "sweet spot" in the center of your speakers. Only Dolby Surround encoded 2-channel material has true surround speaker information. However, Pro Logic's surround speaker processing may provide a pleasing ambiance effect on many stereo (non-Pro Logic) soundtracks.

**Selecting Audio Mode, Surround 7**

DVD Surrnd 7 EQ Variable  
 DVD 5.1 48k Both Video

DVD SURROUND 7

	From Remote	From Front Panel	Action
1	B&K		make sure remote is in B&K mode
2	SURR	○ (MODE)	step to desired mode
3	7	∧ (UP) or ∨ (DOWN)	step to desired speakers

**Selecting Audio Mode, Stereo 4B**

DVD Stereo 4B EQ Variable  
 DVD 5.1 48k Both Video

DVD STEREO 4B

	From Remote	From Front Panel	Action
1	B&K		make sure remote is in B&K mode
2	ST	○ (MODE)	step to desired mode
3	4		Step to desired speakers
4	4 (again)	∧ (UP) or ∨ (DOWN)	select 4B speakers (F, R, Sbl, Sbr)

## EQUALIZATION 'EQ'

**Selecting an EQ function via the remote control** - allows you to override how the audio is currently being processed. This is where you may set the Dynamic Range to either Normal (default) or Limited for late night listening while using Dolby Digital bit streams.

Settings made here are intended for occasional adjustments for a particular source material. They affect all inputs but are temporary. After turning the system off and on, the original parameters from the SETUP menus are restored. If there are temporary settings you use often, you may wish to store them in a preset for instant recall See PRESETS.

You may select EQ, Off 'EQ 0', Variable 'EQ 1', Loudness 'EQ 2' or Theater 'EQ 3'.

The table below shows the various audio modes and how the the EQ feature may be used. Under normal usage a user would select one of these EQs to either correct or enhance their processed audio.

Note, while in 'DIRECT' or 'Ltrt' (speaker selections 8 & 9) the equalizer feature of your unit is not available and disabled (see EQUALIZATION 'EQ').

EQ Name	EQ #	Mono	Stereo	Surround		DVD Audio
Off	0	bypassed	bypassed	bypassed		bypassed
Variable	1	Bass and Treble	Bass and Treble	Bass and Treble		bypassed
Loudness	2	fixed response	fixed response	fixed response		bypassed
Theater	3	fixed response	fixed response	fixed response		bypassed

**Select off 'EQ 0'** - disables the use of any preset equalization curves or bass and treble settings. Note the notch filter settings made under Setup Room Equalization are still in effect.

**Select variable 'EQ 1'** - to allow separate bass and treble settings for use with all input sources.

Many systems allow only adjustment of bass and treble levels at fixed frequency points. Your receiver allows you to adjust level and frequency so you may fine tune your tone controls to provide either very subtle effects at just the right frequency extremes, or for more a pronounced effect at higher bass and lower treble frequencies.

A default setting for bass and treble may be set under Setup Room Equalization.

Selecting variable 'EQ 1' allows you to use the options shown below in VARIABLE EQUALIZATION, and temporarily override the default settings made to bass and treble in setup room equalization (See Room Equalization under Setup Speakers).

**Adjust LFE Level** if you have no subwoofer and you wish to reduce the low frequency effects (LFE) channel to lessen its contribution to the bass going to your remaining large speakers. Or, even with a subwoofer, you may just wish to reduce the overall LFE level, especially in an apartment situation. Note that this affects only the separate LFE (.1) channel available on Dolby Digital and DTS material it has no effect on the reproduction of normal bass from the front, center, or surround channels.

**Select DTS LFE MODE Music** if your DTS material is mixed for a reduced LFE setting and you wish to have a more natural sound. Note that this affects only the separate LFE (.1) channel available on DTS material and has no effect on the reproduction of normal bass from the front, center, or surround channels.

**Select Dynamic Range Limited** for late night listening while using Dolby Digital bit streams and a reduced dynamic range is desired. When the dynamic range is set to limited, compression is used to raise the average loudness of the dialog, and the program peaks will be restricted much in the style of conventional television audio.

**VARIABLE EQUALIZATION**

Frequency	Level
Bass 100.0 Hz	0.0 dB
Treble 10.0 kHz	0.0 dB
LFE Level	0.0 dB
DTS LFE Mode	Movie
Dynamic Range	Normal

↑↓ next item    adjust ← →  
**MENU zone operation**

BASS    100.0 HZ

	From Remote	From Front Panel	Action
1	EQ then 1	not available	select VARIABLE EQUALIZATION
2	SEL or ENTER	↵ (ENTER)	enable VARIABLE EQUALIZATION
3	▲(PAUSE) or ▼(STOP) ◀(REW) or ▶(FF)	∧ (UP) or ∨ (DOWN) VOLUME KNOB	select and adjust desired parameters
3	MENU	∟ MENU	return to Zone 1 (A) operation



**Select loudness 'EQ 2'** - sets the equalizer to use preset filter curves designed for use when using low listening levels. The human ear's frequency response varies with volume level. At high levels it has relatively flat response, while at low levels its sensitivity to high and low frequencies is reduced. The loudness equalizer is designed to cancel the ear's frequency response anomalies to provide consistent tone at all volume levels. Note that you will hear little difference using the loudness control at high volumes as it has its greatest effect at lower volume levels.

**Select theater EQ 'EQ 3'** - sets the equalizer for use with a preset filter curve best suited for small home theaters. Many soundtracks are mixed for a large movie theater with very absorptive surfaces and speakers firing through projection screens. If the soundtrack has not been adjusted for home use, it may sound overly bright or harsh. Theater EQ allows you to apply preset high frequency compensation specifically set for use with this type of material.

## ZONE 'Z'

**Using the Z (zone) function via the remote control** - Your receiver comes equipped with a fully independent 2-channel analog pre-amp for use with a second audio zone. The easiest way to control the second Zone is with a dedicated Z2 remote available from B&K and other universal remote suppliers. You can also control the second zone from your zone 1 remote via the "Z" button.



	From Remote	From Front Panel	Action
1	B&K	See Zone 2 (A) operation	make sure remote is in B&K mode
2	Z	See Zone 2 (A) operation	select alternate zone control
3	2	See Zone 2 (A) operation	select desired zone

Normally, your second zone will be zone 2. However, it is possible to change the zone ID (see Advanced settings). If the second zone (zone B) ID has been changed, enter its current ID here to get control of the second zone. If the zone ID is 10 or larger hit +10 followed by the second digit to gain control.

After a few seconds of inactivity, control will automatically revert to zone 1 (A). If you don't wish to wait, just press Z then 1. You can also control zone 2 (B) from the remote or front panel via the menu system. Refer to ZONE 2 (B) OPERATION.

## PRESETS

Presets allow you to save your favorite settings and recall them instantly. Your receiver can store two banks of 40 presets (0..39) in each of 2 Zones. The saved information includes the selected audio source, selected video source, volume, the audio mode and number of speakers, the tuner station and band settings, and all of the temporary settings and overrides described previously. A convenient set of 40 presets come preprogrammed with your receiver.

### Recalling a Preset

**RECALL PRESET 2**  
**DVD Party**  
 Source DVD      Record DVD  
 Video DVD      Volume - 25.0  
 Mode Surround   Center   0.0  
 Spkrs      7      Rear      0.0  
 Eq 0      Off      Sub      0.0  
 0..9 +10 preset      SEL confirm  
 MENU cancel

2 DVD PARTY

	From Remote	From Front Panel	Action
1	number or +10+ number	◇ (PRESET) step favorite preset	review settings for recall
2	SEL or ENTER	┘ (ENTER)	recall preset

### Saving a Preset

**SAVE PRESET 10**  
**'DVD -25 dB '**  
 Source DVD      Record DVD  
 Video DVD      Volume - 25.0  
 Mode Surround   Center   0.0  
 Spkrs      7      Rear      0.0  
 Eq 0      Off      Sub      0.0  
 ↑ ↓ character      position   ← →  
 0..9 +10 preset      SEL confirm  
 MENU cancel

10 DVD - 25 DB

	From Remote	From Front Panel	Action
1	make all settings you wish to save	make all settings you wish to save	prepare for saving preset
2	SAVE	☑ SAVE	activate preset save
3	▲(PAUSE) or ▼(STOP) ◀(REW) or ▶(FF)	∧ (UP) or ∨ (DOWN) VOLUME KNOB	rename preset if desired
4	SEL or ENTER	┘ (ENTER)	save preset

## ZONE 1 (A)

### Recalling/Saving Presets via the Menu System

You can also recall, save presets and operate your receiver via the menu system from the remote or from the front panel. If using the remote be sure it is in B&K mode and you are in the MAIN MENUS.

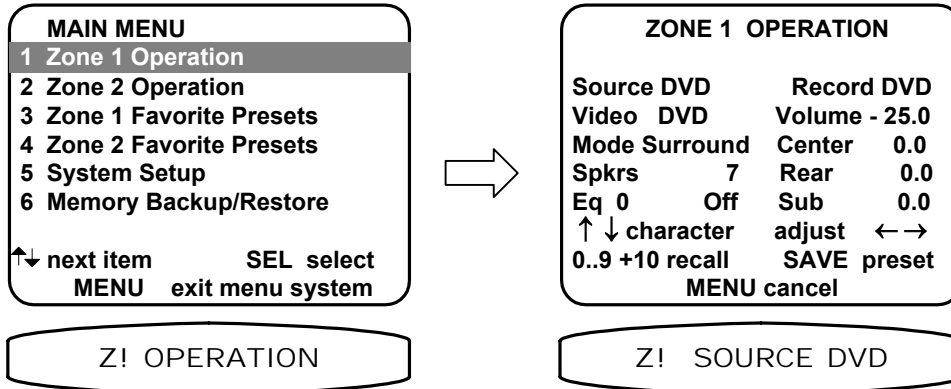

	From Remote	From Front Panel	Action
1	▲(PAUSE) or ▼(STOP)	∧ (UP) or ∨ (DOWN)	move to Zone 1 Operation
2	SEL or ENTER	↵ (ENTER)	activate ZONE 1 OPERATION
3	source then B&K VOLUME ▲ or VOLUME ▼ CENTER ▲ or CENTER ▼ REAR ▲ or REAR ▼ SUB ▲ or SUB ▼ EQ	□ (SOURCE) ○ (MODE)  and or  ∧ (UP) or ∨ (DOWN) (select function) VOLUME KNOB (adjust parameter)	adjust and or edit Zone 1 parameters as desired
4	MENU	∟ MENU	return to main menu

### Recall preset using Zone 1 Operation

	From Remote	From Front Panel	Action
1	MENU	∟ MENU	return to main menu
2	▲(PAUSE) or ▼(STOP)	∧ (UP) or ∨ (DOWN)	move to Zone 1 Operation
3	SEL or ENTER	↵ (ENTER)	activate ZONE 1 OPERATION
4	number or +10+ number	◇ (PRESET) step to desired preset	select a preset for recall
5	ENTER	↵ (ENTER)	recall preset

Save preset using Zone 1 Operation

	From Remote	From Front Panel	Action
1	▲(PAUSE) or ▼(STOP)	∧ (UP) or ∨ (DOWN)	move to Zone 1 Operation
2	SEL or ENTER	↵ (ENTER)	activate ZONE 1 OPERATION
3	source then B&K VOLUME ▲ or VOLUME ▼ CENTER ▲ or CENTER ▼ REAR ▲ or REAR ▼ SUB ▲ or SUB ▼ EQ	□ (SOURCE) ○ (MODE)  and or  ∧ (UP) or ∨ (DOWN) (select function) VOLUME KNOB (adjust parameter)	adjust and or edit Zone 1 parameters as desired
4	SAVE or ENTER or select a different preset number	📖 SAVE and ↵ (ENTER)	start the preset save process. Note: the system will pick the next available preset. You may pick a different preset number if desired.
5	▲(PAUSE) or ▼(STOP) ◀(REW) or ▶(FF)	∧ (UP) or ∨ (DOWN) VOLUME KNOB	rename preset if desired
6	ENTER	↵ (ENTER)	save preset
7	MENU	∟ MENU	return to main menu
8	MENU	∟ MENU	exit menu system

## ZONE 2 (B)

As with Zone 1 (A) operation you may also recall, save presets and operate your receiver's Zone 2 (B) via the menu system via the remote or from the front panel. If using the remote be sure it is in B&K mode and you are in the MAIN MENUS.

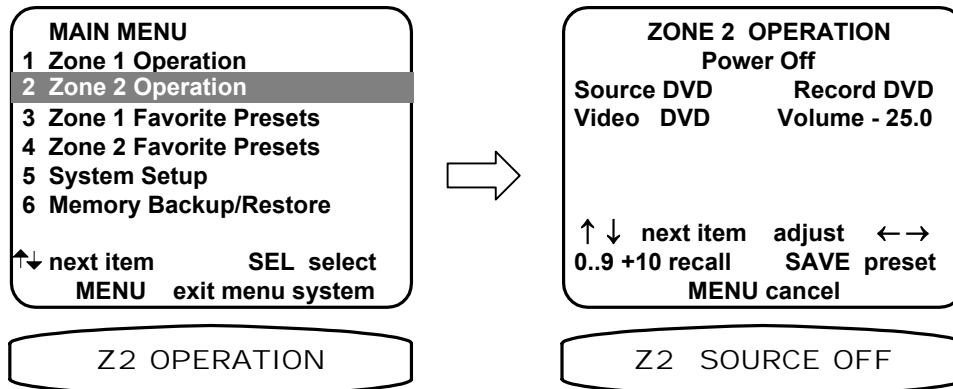

	From Remote	From Front Panel	Action
1	▲(PAUSE) or ▼(STOP)	∧ (UP) or ∨ (DOWN)	move to Zone 2 Operation
2	SEL or ENTER	↵ (ENTER)	activate ZONE 2 OPERATION
3	source then B&K VOLUME ▲ or VOLUME ▼	□ (SOURCE) and or  ∧ (UP) or ∨ (DOWN) (select function) VOLUME KNOB (adjust parameter)	adjust and or edit Zone 2 parameters as desired
4	MENU	∟ MENU	return to main menu

### Recall preset using Zone 2 Operation

	From Remote	From Front Panel	Action
1	MENU	∠ MENU	return to main menu
2	▲(PAUSE) or ▼(STOP)	∧ (UP) or ∨ (DOWN)	move to Zone 2 Operation
3	SEL or ENTER	↵ (ENTER)	activate ZONE 2 OPERATION
4	number or +10 + number	◇ (PRESET) step to desired preset	select a preset for recall
5	ENTER	↵ (ENTER)	recall preset

### Save preset using Zone 2 Operation

	From Remote	From Front Panel	Action
1	▲(PAUSE) or ▼(STOP)	∧ (UP) or ∨ (DOWN)	move to Zone 2 Operation
2	SEL or ENTER	↵ (ENTER)	activate ZONE 2 OPERATION
3	source then B&K VOLUME ▲ or VOLUME ▼	□ (SOURCE) and or ∧ (UP) or ∨ (DOWN) (select function) VOLUME KNOB (adjust parameter)	adjust and or edit Zone 2 parameters as desired
4	SAVE or ENTER or select a different preset number	📄 SAVE and ↵ (ENTER)	start the preset save process. Note: the system will pick the next available preset. You may pick a different preset number if desired.
5	▲(PAUSE) or ▼(STOP) ◀(REW) or ▶(FF)	∧ (UP) or ∨ (DOWN) VOLUME KNOB	rename preset if desired
6	ENTER	↵ (ENTER)	save preset
7	MENU	∠ MENU	return to main menu
8	MENU	∠ MENU	exit menu system

## ZONE 1 FAVORITE PRESETS

Favorite presets need only be setup after adding/changing presets or sources. This feature allows for skipping selected presets when pressing the remote CHANNEL  $\wedge$   $\vee$  buttons or front panel preset (+) button. When you save a preset it will be automatically added to the favorite preset list. If using the remote be sure it is in B&K mode and you are in the MAIN MENU.

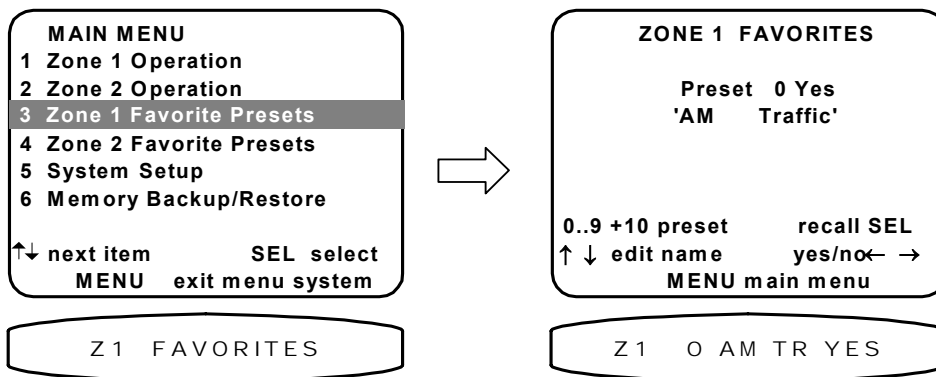

	From Remote	From Front Panel	Action
1	▲(PAUSE) or ▼(STOP)	∧ (UP) or ∨ (DOWN)	move to Zone 1 Favorite
2	SEL or ENTER	↵ (ENTER)	activate ZONE 1 FAVORITE
3	number or +10 + number	◇ (PRESET) step to desired preset	select a preset for no-skip/skip
4	◀(REW) or ▶(FF)	VOLUME KNOB	select yes/no (no-skip/skip)
5	▲(PAUSE) or ▼(STOP)	∧ (UP) or ∨ (DOWN)	rename preset if desired
6	ENTER	↵ (ENTER)	save preset name
7	repeat 3-6	repeat 3-6	modify additional favorite presets
8	MENU	∟ MENU	return to main menu
9	MENU	∟ MENU	exit menu system

## ZONE 2 FAVORITE PRESETS

Favorite presets need only be setup after adding/changing presets or sources. This feature allows for skipping selected presets when pressing the remote CHANNEL  $\wedge$   $\vee$  buttons or front panel preset (+) button. When you save a preset it will be automatically added to the favorite preset list. If using the remote be sure it is in B&K mode and you are in the MAIN MENU.

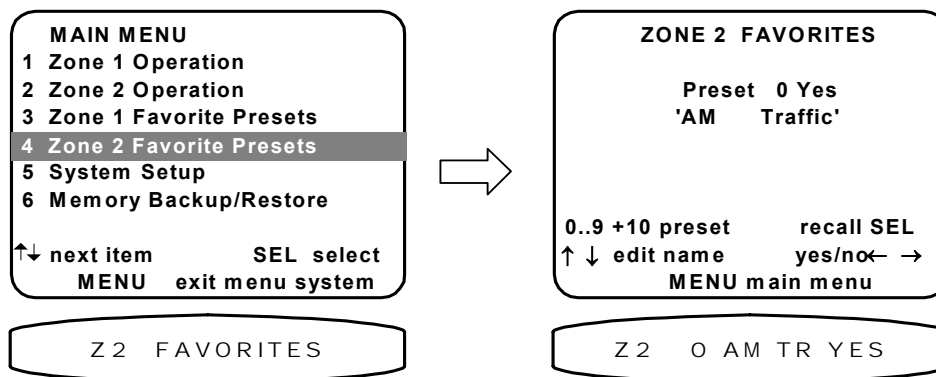

	From Remote	From Front Panel	Action
1	▲(PAUSE) or ▼(STOP)	∧ (UP) or ∨ (DOWN)	move to Zone 2 Favorite
2	SEL or ENTER	↵ (ENTER)	activate ZONE 2 FAVORITE
3	number or +10 + number	◇ (PRESET) step to desired preset	select a preset for no-skip/skip
4	◀(REW) or ▶(FF)	VOLUME KNOB	select yes/no (no-skip/skip)
5	▲(PAUSE) or ▼(STOP)	∧ (UP) or ∨ (DOWN)	rename preset if desired
6	ENTER	↵ (ENTER)	save preset name
7	repeat 3-6	repeat 3-6	modify additional favorite presets
8	MENU	∟ MENU	return to main menu
9	MENU	∟ MENU	exit menu system

## GETTING RECEIVER STATUS

When you are not in a menu, pressing ENTER will bring up a two or three line status message on Zone 1 (A) video outputs. A single line status message is also available on the receiver's front panel display. This display will also pop up automatically whenever you change sources or whenever the selected source information changes. The video type is very important if you are using mixed composite and S-video sources since it will tell you how you must set your monitor for the best picture. The bitstream and channel information is particularly important with DVDs since they may contain multiple soundtracks. When you initially start the DVD you may get a Dolby Digital 2.0 soundtrack. To get the best possible sound, you may have to use the DVD player's menu system to get to a Dolby Digital or DTS 5.1 channel soundtrack. If you ever need to call B&K regarding a problem with your receiver be sure to note this status display before calling.

### ON SCREEN DISPLAY

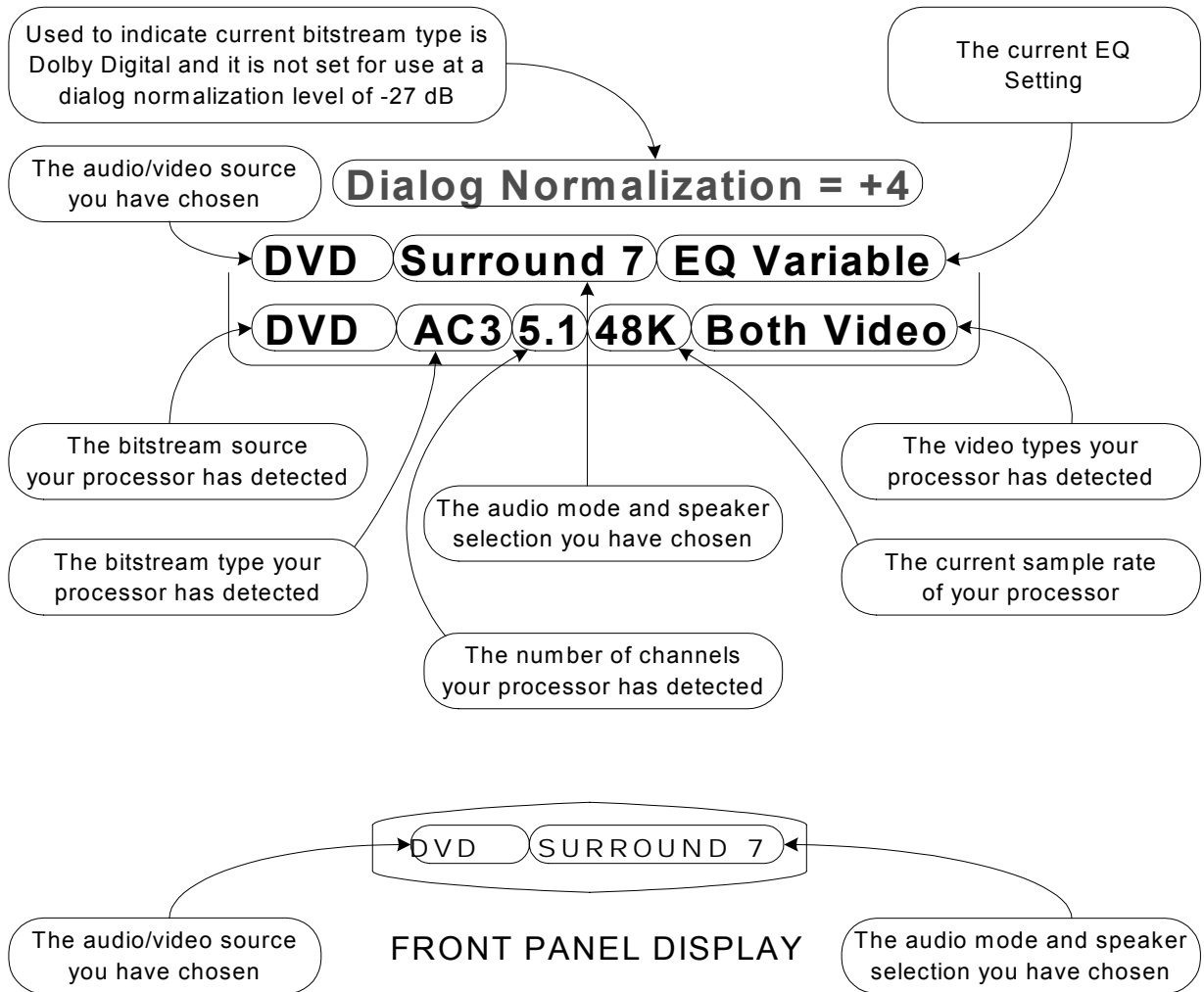

From Remote	From Front Panel	Action
SEL or ENTER	↵ (ENTER)	recall receiver status

# ADVANCED FEATURES

**WARNING** - The following describes the advanced features of the receiver. Since changing some of these functions may cause severe effects such as no sound or no remote control operation, we suggest you leave this menu disabled (hidden) for normal operation. If you are unsure of what you are changing **DO NOT** perform any advanced operations. These features may be activated by simultaneously pressing the SLEEP, DOWN, and UP buttons on the front panel of the receiver.

## Advanced

Usually these settings may be left set to the factory defaults. However, these settings allow additional modifications to the operation of your receiver. Make sure you are in the SETUP SYSTEM MENUS and your remote is in B&K mode.

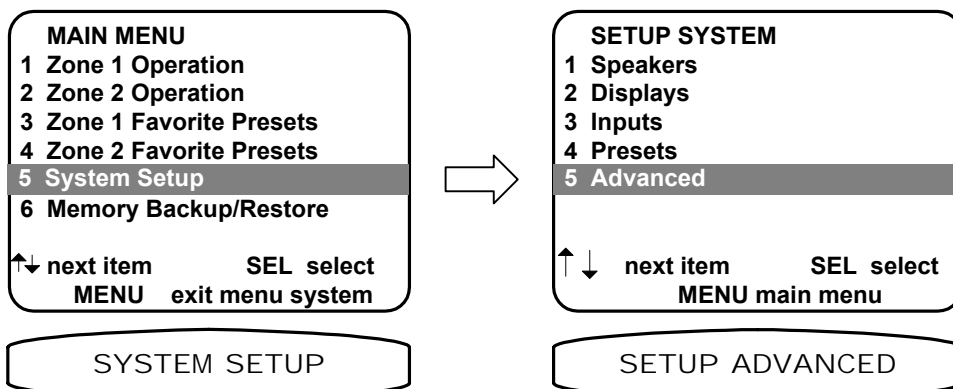

	From Remote	From Front Panel	Action
1	▲(PAUSE) or ▼(STOP)	∧ (UP) or ∨ (DOWN)	move to Advanced
2	SEL or ENTER	↵ (ENTER)	activate ADVANCED SYSTEM SETUP

## Zone 1 Setup (A)

Zone 1 (A) Configuration will allow you to set maximum volume level, remote control 'Zone' ID, OSD enable, V1 tape mode and surround operation for Zone 1 (A). Make sure you are in the ADVANCED SYSTEM SETUP menu and the remote is in B&K mode.

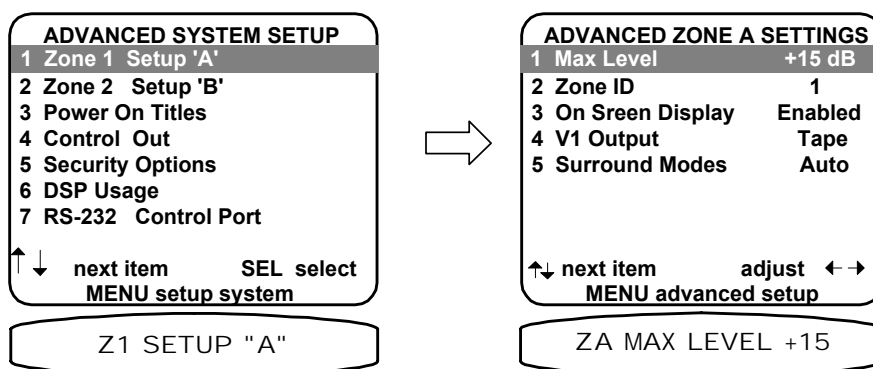



	From Remote	From Front Panel	Action
1	▲(PAUSE) or ▼(STOP)	∧ (UP) or ∨ (DOWN)	move to Zone 1 Setup (A)
2	SEL or ENTER	⌵ (ENTER)	activate ADVANCED ZONE A SETTINGS

**Set the maximum level of Zone 1 (A)** - Max level allows you to set a maximum volume level for Zone 1 (A). This is very useful if you are using speakers that can't handle the maximum power output from your receiver or if you simply wish to limit the volume that can be achieved using normal front panel or remote operation.

**WARNING - If you set this level too low, the receiver may appear broken (no sound).**

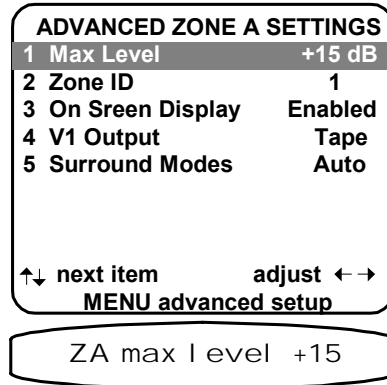

	From Remote	From Front Panel	Action
1	▲(PAUSE) or ▼(STOP)	∧ (UP) or ∨ (DOWN)	move to Max Level
2	◀(REW) or ▶(FF)	VOLUME KNOB	adjust level to desired value

**Set Zone 1 (A) product ID** - Each message transmitted from your remote includes a Product Code, identifying the manufacturer, and Zone product ID code from 1 to 16. The product ID code allows multiple B&K products to be controlled from the same remote. Your receiver actually uses two product ID codes - one for Zone 1 (A) (normally set to ID code 1) and the other for Zone 2 (B) (normally set to ID code 2). If you have a system with multiple B&K products then you may wish to set the Zone product ID codes to other values. Note that you cannot set the Zone 1 (A) product ID to the same setting as Zone 2 (B) or vice versa. If you need to set Zone 1 (A) to the current Zone 2 (B) setting then set Zone 2 (B) to some other value first.

**WARNING - if you change the Zone product ID code in the receiver without making the corresponding change to the remote then the remote will no longer work. Refer to the separate remote manual for details on changing the remote's product ID ("device code").**

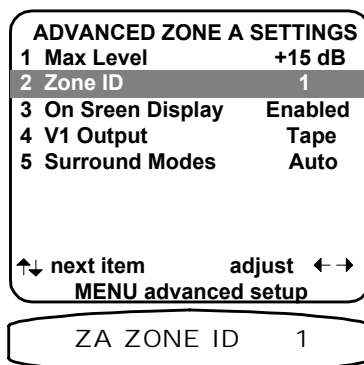

	From Remote	From Front Panel	Action
1	▲(PAUSE) or ▼(STOP)	∧ (UP) or ∨ (DOWN)	move to Zone ID
2	◀(REW) or ▶(FF)	VOLUME KNOB	adjust Zone 1 (A) ID to desired value

**Set Zone 1 (A) On Screen display usage** - During normal operation, when you make a change to a system setting or your receiver detects a change to the incoming audio or video, a message is overlaid along the bottom of your video screen. You can turn off the overlay display from this menu. This will not affect the on-screen displays when you enter the menu system.

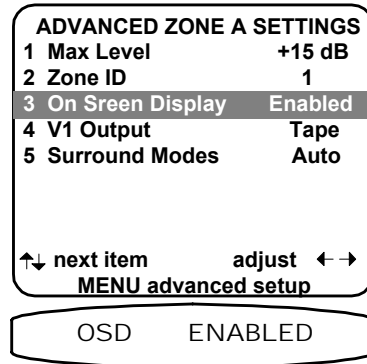

	From Remote	From Front Panel	Action
1	▲(PAUSE) or ▼(STOP)	∧ (UP) or ∨ (DOWN)	move to On Screen Display
2	◀(REW) or ▶(FF)	VOLUME KNOB	set to Enabled or Disabled

**Set V1 line output usage** - V1 output is normally set up as a tape loop. The V1 and Zone 1 (A) output are the current source (V2, TV, CD, DVD, etc.) except when the current selection is V1. When V1 is selected as the source, the Zone 1 (A) output is V1 and the V1 output is off. This prevents feedback when the V1 inputs and outputs are connected to a tape deck or VCR. Feedback can cause high frequency oscillations which may damage your speakers. If you don't connect a tape deck to the V1 input and output you can use the V1 output as an additional line out. In this mode V1 output is always the selected input including V1. Note: The Tape input and output is always set up as a tape monitor for Zone 1 (A).

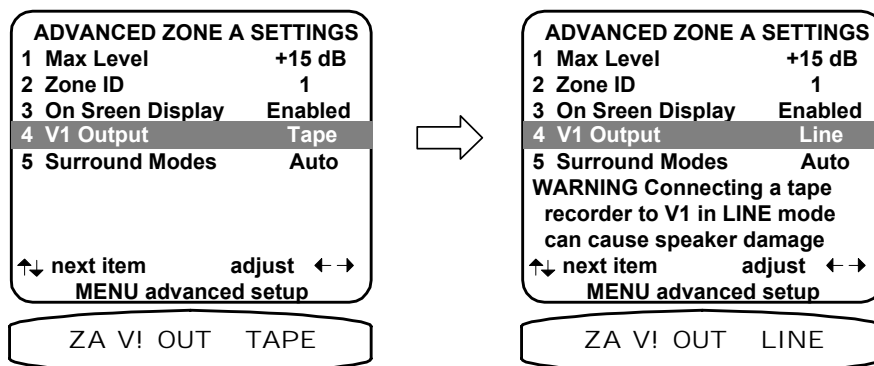

	From Remote	From Front Panel	Action
1	▲(PAUSE) or ▼(STOP)	∧ (UP) or ∨ (DOWN)	move to V1 Output
2	◀(REW) or ▶(FF)	VOLUME KNOB	set for Tape or Line

**Set surround mode operation** - Most users will prefer the factory setting - AUTO. In this mode the receiver automatically sets the surround mode to full 7.1 channel operation (or as many as permitted by your speaker setup) whenever a Dolby Digital or DTS bitstream is detected regardless of what surround mode you have selected. For example, load your CD changer with a normal PCM CD, a DTS CD, and another normal PCM CD and select audio mode SURROUND 3 (see AUDIO MODES above). While the PCM CD is playing you will get sound from the front and center speakers only. When the disc changes to the DTS CD you will get sound from all front, center, and surround speakers. When the third (PCM) CD starts the receiver returns to SURROUND 3. Note that if a Dolby Digital or DTS source is currently playing and you change the audio mode the receiver will stay in the selected audio mode until you select another input or turn the receiver off and on. In MANUAL mode the chosen audio mode remains set regardless of the bitstream detected. In the above example only the front and center speakers would be used on all three CDs even though the DTS CD was capable of providing full 5 channel sound to 7.1 speakers. Note that the surround channel information is not lost. It is simply mixed into the front speakers.

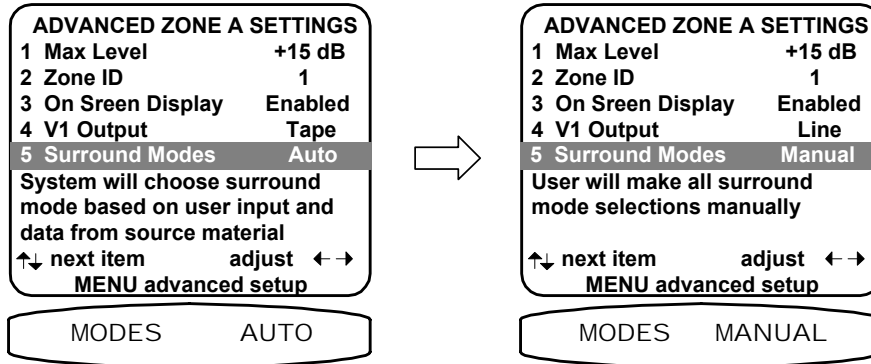

	From Remote	From Front Panel	Action
1	▲(PAUSE) or ▼(STOP)	∧ (UP) or ∨ (DOWN)	move to Surround Modes
2	◀(REW) or ▶(FF)	VOLUME KNOB	set to Auto or Manual
3	MENU	∟ MENU	return to ADVANCED SYSTEM SETUP

## Zone 2 Setup (B)

Configuration will allow you to fix and set maximum volume level, remote control 'Zone' ID, V2 tape mode for Zone 2 (B). Additionally, there are options to set the linking of Zone 2 (B) to Zone 1 (A). Make sure you are in the ADVANCED SYSTEM SETUP menu and the remote is in B&K mode.

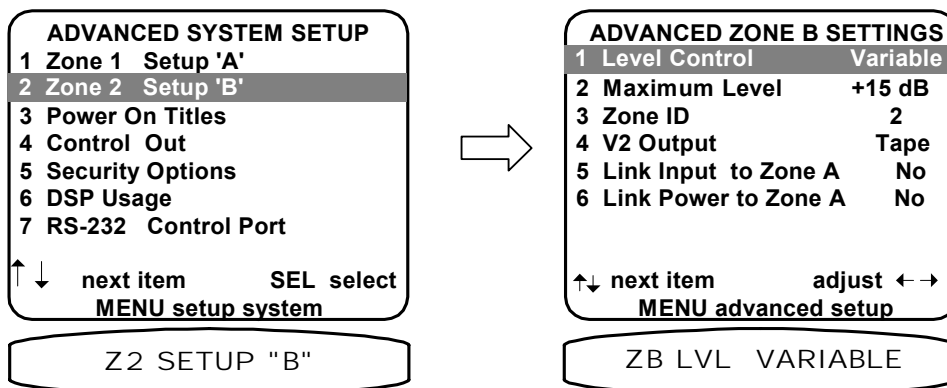

	From Remote	From Front Panel	Action
1	▲(PAUSE) or ▼(STOP)	∧ (UP) or ∨ (DOWN)	move to Zone 2 Setup (B)
2	SEL or ENTER	↵ (ENTER)	activate ADVANCED ZONE B SETTINGS

**Zone 2 (B) Level Control** - You may wish to install an in-wall volume control in your second zone. This can cause confusion between your receiver's internal Zone 2 (B) volume controls and your in-wall controls.

**WARNING - Setting Zone 2 (B) LEVEL CONTROL to FIXED will cause your receiver to immediately send its maximum Zone 2 (B) volume to your second zone (if Zone 2 (B) is on). Turn down your in-wall volume controls before making this change.**

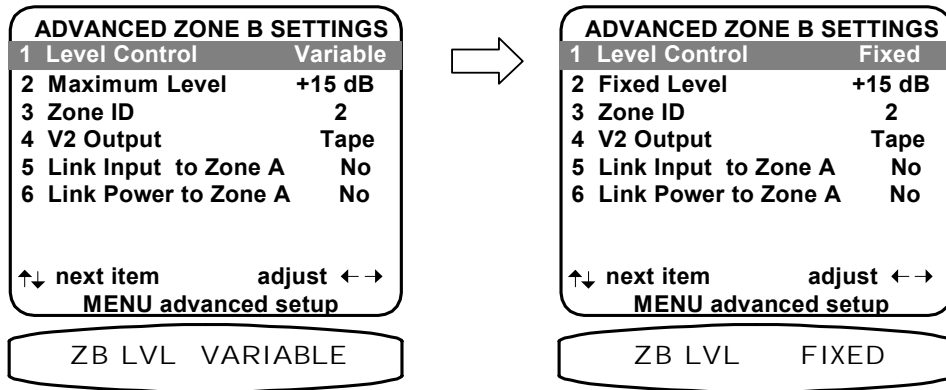

	From Remote	From Front Panel	Action
1	▲(PAUSE) or ▼(STOP)	∧ (UP) or ∨ (DOWN)	move to Level Control
2	◀(REW) or ▶(FF)	VOLUME KNOB	adjust level to desired value

**Zone 2 (B) Max (Fixed or Variable) Level** - Z2 max level allows you to set a maximum volume level for Zone 2 (B). This is very useful if you are using speakers that can't handle the maximum power output from your external amplifier or if you simply wish to limit the volume that can be achieved using normal front panel or remote operation. If you have chosen Zone 2 (B) level control (fixed), then this setting becomes the fixed level for Zone 2 (B). If you have chosen Zone 2 (B) level control (variable) then this setting allows the level for Zone 2 (B) to be adjusted. However, when adjusting this level it cannot exceed the value set in Zone 2 (B) max level.

**WARNING - If you set this level too low, the receiver may appear broken (no sound).**

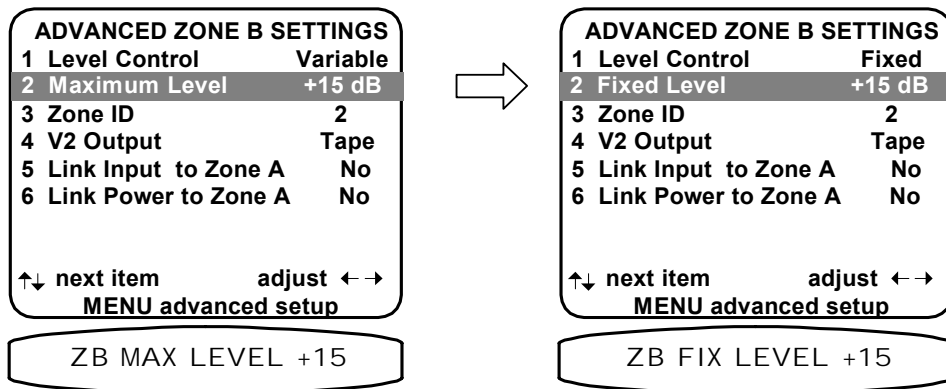

	From Remote	From Front Panel	Action
1	▲(PAUSE) or ▼(STOP)	∧ (UP) or ∨ (DOWN)	move to Fixed Level
2	◀(REW) or ▶(FF)	VOLUME KNOB	adjust level to desired value

**Set Zone 2 (B) product ID** - Each message transmitted from your remote includes a Product Code, identifying the manufacturer, and Zone product ID code from 1 to 16. The product ID code allows multiple B&K products to be controlled from the same remote. Your receiver actually uses two product ID codes - one for Zone 1 (A) (normally set to ID code 1) and the other for Zone 2 (B) (normally set to ID code 2). If you have a system with multiple B&K products then you may wish to set the Zone product ID codes to other values. Note that you cannot set the Zone 1 (A) product ID to the same setting as Zone 2 (B) or vice versa. If you need to set Zone 1 (A) to the current Zone 2 (B) setting then set Zone 2 (B) to some other value first.

**WARNING** - if you change the Zone product ID code in the receiver without making the corresponding change to the remote then the remote will no longer work. Refer to the separate remote manual for details on changing the remote's product ID ("device code").

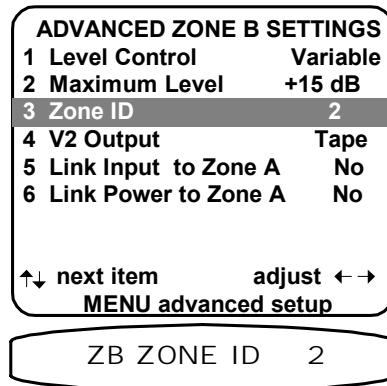

	From Remote	From Front Panel	Action
1	▲(PAUSE) or ▼(STOP)	∧ (UP) or ∨ (DOWN)	move to Zone ID
2	◀(REW) or ▶(FF)	VOLUME KNOB	adjust Zone 2 (B) ID to desired value

**Set V2 line output usage** - V2 output is normally set up as a tape loop. The V2 and Zone 2 (B) output are the current source (V1, TV, CD, DVD, etc.) except when the current selection is V2. When V2 is selected as the source, the Zone 2 (B) output is V2 and the V2 output is the previously selected source. This prevents feedback when the V2 inputs and outputs are connected to a tape deck or VCR. Feedback can cause high frequency oscillations which may damage your speakers. If you don't connect a tape deck to the V2 input and output you can use the V2 output as an additional line out. In this mode V2 output is always the selected input including V2.

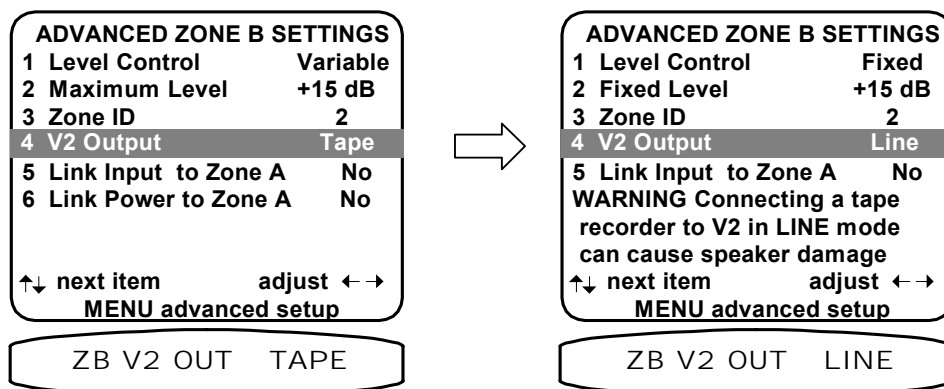

	From Remote	From Front Panel	Action
1	▲(PAUSE) or ▼(STOP)	∧ (UP) or ∨ (DOWN)	move to V2 Output
2	◀(REW) or ▶(FF)	VOLUME KNOB	set for Tape or Line

**Link Zone 2 (B) input to Zone 1 (A) input selection** - Zone 2 (B) input source selection may be linked with Zone 1 (A) source selections. In operation, whenever a source selection is detected (remote, front panel or RS-232) on Zone 1 (A), source linkage will cause the source to be selected on both zones. Independent source selection is still available with Zone 2 (B) remote control, but any Zone 1 (A) source selection supersedes the previous Zone 2 (B) selection.

**ADVANCED ZONE B SETTINGS**

1 Level Control	Variable
2 Maximum Level	+15 dB
3 Zone ID	2
4 V2 Output	Tape
5 Link Input to Zone A	No
6 Link Power to Zone A	No

↑↓ next item          adjust ←→  
**MENU advanced setup**

ZB LINK SRC NO

	From Remote	From Front Panel	Action
1	▲(PAUSE) or ▼(STOP)	∧ (UP) or ∨ (DOWN)	move to Link Input to Zone A
2	◀(REW) or ▶(FF)	VOLUME KNOB	set to Yes or No

**Link Zone 2 (B) power to Zone 1 (A) power** - Zone 2 (B) power On/Off may be linked to Zone 1 (A). In operation, whenever power is set to On in Zone 1 (A) the power linkage feature will cause power to be set accordingly on Zone 2 (B). Zone 2 (B) Independent power on/off is still operational with the Zone 2 (B) remote control, but any Zone 1 (B) power command supersedes the previous Zone 2 (B) power on/off.

**ADVANCED ZONE B SETTINGS**

1 Level Control	Variable
2 Maximum Level	+15 dB
3 Zone ID	2
4 V2 Output	Tape
5 Link Input to Zone A	No
6 Link Power to Zone A	No

↑↓ next item          adjust ←→  
**MENU advanced setup**

ZB LINK PWR NO

	From Remote	From Front Panel	Action
1	▲(PAUSE) or ▼(STOP)	∧ (UP) or ∨ (DOWN)	move to Link Power to Zone A
2	◀(REW) or ▶(FF)	VOLUME KNOB	set to Yes or No
3	MENU	∟ MENU	return to ADVANCED SYSTEM SETUP

## Power On Titles

When you turn your receiver on it displays two lines of text. You can change this text to a personalized message. Make sure you are in the ADVANCED SYSTEM SETUP menu and the remote is in B&K mode.

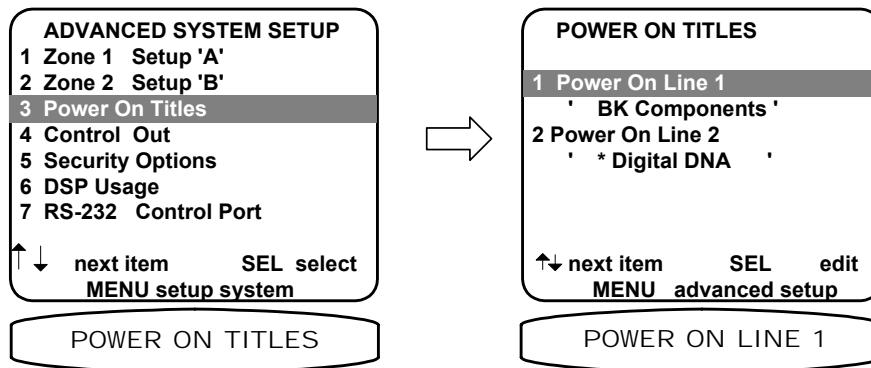

	From Remote	From Front Panel	Action
1	▲(PAUSE) or ▼(STOP)	∧ (UP) or ∨ (DOWN)	move to Power On Titles
2	SEL or ENTER	⌵ (ENTER)	activate ADVANCED POWER ON TITLES
3	▲(PAUSE) or ▼(STOP)	∧ (UP) or ∨ (DOWN)	move to Power On Line 1
4	SEL or ENTER	⌵ (ENTER)	activate Line 1
5	▲(PAUSE) or ▼(STOP)	∧ (UP) or ∨ (DOWN)	change blinking character
6	◀(REW) or ▶(FF)	VOLUME KNOB	move to new character
7	repeat 5 - 6	repeat 5 - 6	continue changing characters
8	SEL or ENTER	⌵ (ENTER)	finish editing line 1
9	▲(PAUSE) or ▼(STOP)	∧ (UP) or ∨ (DOWN)	move to Power On Line 2
10	repeat 4 - 8	repeat 4 - 8	edit Line 2
11	MENU	∟ MENU	return to ADVANCED SYSTEM SETUP

## Control Outputs

Your receiver's control outputs allow you to control up to 4 external devices such as power amplifiers, projection screens, etc. Each control output can be programmed on (a source of 12VDC @ 50 mA) or off (0 VDC) depending on which source is selected. They may also be set to headphone listening, remote repeater or RS-232 (see BKC-DIP documentation). Make sure you are in the ADVANCED SYSTEM SETUP menu and the remote is in B&K mode.

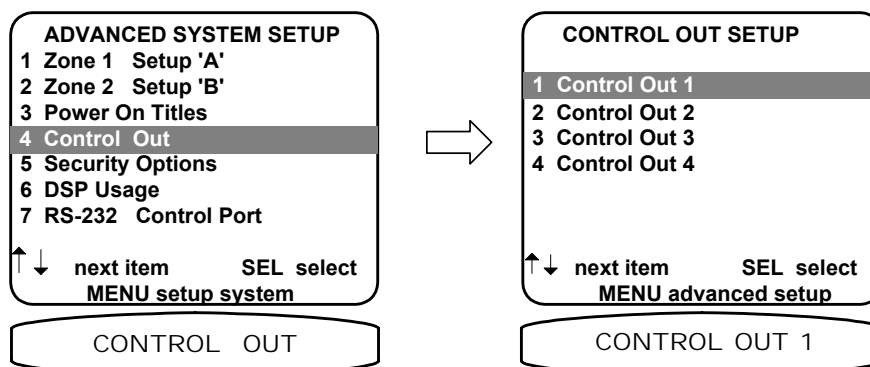

	From Remote	From Front Panel	Action
1	▲(PAUSE) or ▼(STOP)	∧ (UP) or ∨ (DOWN)	move to Control Out
2	SEL or ENTER	↵ (ENTER)	activate CONTROL OUT SETTINGS

### Setup Control Out 1

Control out 1 is dedicated to Zone 1 (A) it can be programmed to be on or off for each source. For example you may wish to use the control out to pull down a projection screen for your V1 and DVD sources but roll it up for Tuner and CD. Control out 1 can also be set to HEADPHONE or RS-232. HEADPHONE mode is intended to control external amplifiers to permit headphone listening without the need for manually turning off your external amplifiers. Select the RS-232 option when Control out 1 is to be set using BKC-DIP.

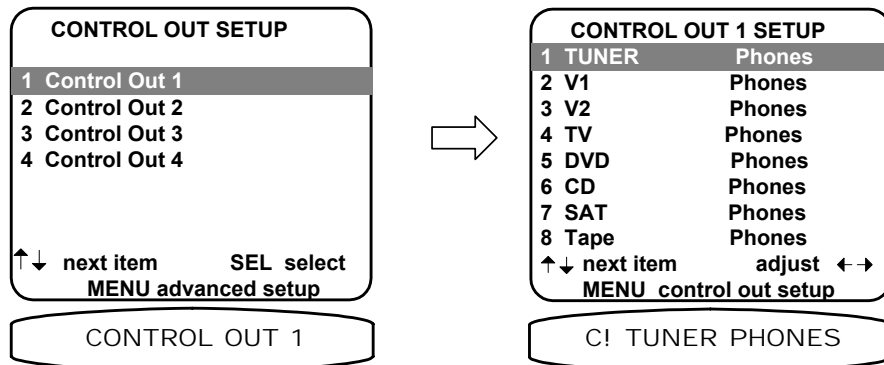

	From Remote	From Front Panel	Action
1	▲(PAUSE) or ▼(STOP)	∧ (UP) or ∨ (DOWN)	move to Control Out 1
2	SEL or ENTER	↵ (ENTER)	activate CONTROL OUT 1 SETUP
3	▲(PAUSE) or ▼(STOP)	∧ (UP) or ∨ (DOWN)	move to desired source
4	◀(REW) or ▶(FF)	VOLUME KNOB	select desired control operation
5	repeat 3 - 4	repeat 3 - 4	set control out 1 for other sources
6	MENU	∟ MENU	return to CONTROL OUT SETTINGS

**Control Out 2, 3, and 4** - Control out 2, 3, and 4 can be used in either zone. For each source they can be programmed to be on when that source is selected in Zone 1 (A), Zone 2 (B), or both zones. If the source is selected in neither zone the control out will be off. Control outs 2, 3, and 4 can also be set to REMOTE. In REMOTE mode your receiver acts like a remote repeater - IR remote signals detected by your receiver are repeated on the control out. Select the RS-232 option when a Control out is to be set using BKC-DIP.

### Setup Control Out 2

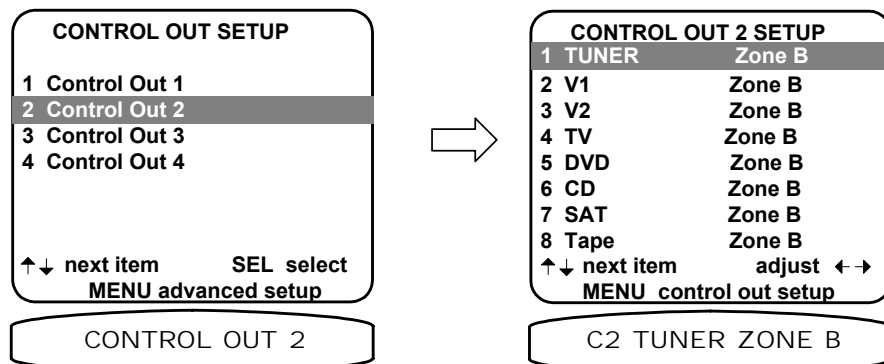



	From Remote	From Front Panel	Action
1	▲(PAUSE) or ▼(STOP)	∧ (UP) or ∨ (DOWN)	move to Control Out 2
2	SEL or ENTER	⌵ (ENTER)	activate CONTROL OUT 2 SETUP
3	▲(PAUSE) or ▼(STOP)	∧ (UP) or ∨ (DOWN)	move to desired source
4	◀(REW) or ▶(FF)	VOLUME KNOB	select desired control operation
5	repeat 3 - 4	repeat 3 - 4	set control out 2 for other sources
6	MENU	∟ MENU	return to CONTROL OUT SETTINGS

### Setup Control Out 3

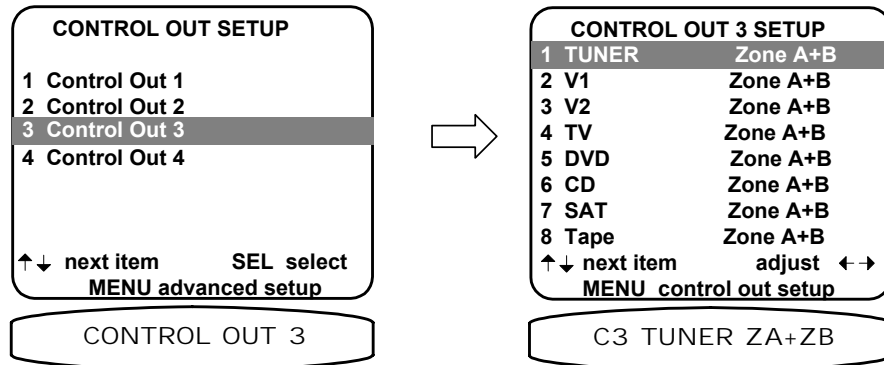

	From Remote	From Front Panel	Action
1	▲(PAUSE) or ▼(STOP)	∧ (UP) or ∨ (DOWN)	move to Control Out 3
2	SEL or ENTER	⌵ (ENTER)	activate CONTROL OUT 3 SETUP
3	▲(PAUSE) or ▼(STOP)	∧ (UP) or ∨ (DOWN)	move to desired source
4	◀(REW) or ▶(FF)	VOLUME KNOB	select desired control operation
5	repeat 3 - 4	repeat 3 - 4	set control out 3 for other sources
6	MENU	∟ MENU	return to CONTROL OUT SETTINGS

### Setup Control Out 4

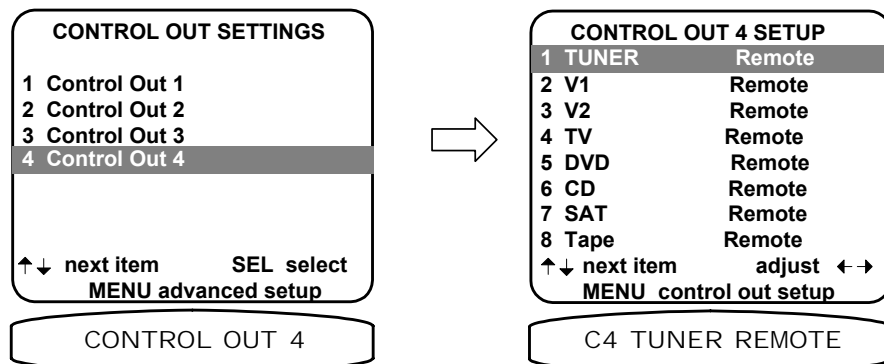

	From Remote	From Front Panel	Action
1	▲(PAUSE) or ▼(STOP)	∧ (UP) or ∨ (DOWN)	move to Control Out 4
2	SEL or ENTER	↵ (ENTER)	activate CONTROL OUT 4 SETUP
3	▲(PAUSE) or ▼(STOP)	∧ (UP) or ∨ (DOWN)	move to desired source
4	◀(REW) or ▶(FF)	VOLUME KNOB	select desired control operation
5	repeat 3 - 4	repeat 3 - 4	set control out 4 for other sources
6	MENU	∠ MENU	return to CONTROL OUT SETTINGS
7	MENU	∠ MENU	return to ADVANCED SYSTEM SETUP

## Security Options

Advanced Security options allow you to hide the ADVANCED SYSTEM SETUP menu to prevent inadvertent changes to advanced system settings. This menu also allows you to lock your preset and system setup settings to prevent inadvertent reprogramming.

**Advanced Menu Visibility** - If you select Advanced Menu Visible then you can return to this menu directly by entering MAIN MENU and selecting System Setup and then Advanced (refer to SETUP). Advanced Systems Settings will appear as line 6 in SETUP MENUS. Make sure your receiver is on and the remote is in B&K mode.

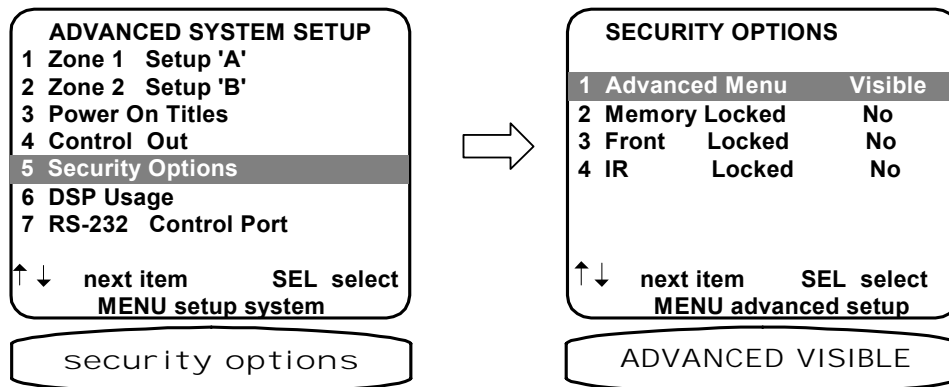

	From Remote	From Front Panel	Action
1	Function not available from remote	⌂ SLEEP, ∧ (UP) and ∨(DOWN) simultaneously	enable advanced features
2	▲(PAUSE) or ▼(STOP)	∧ (UP) or ∨ (DOWN)	move to Advanced Menu
3	◀(REW) or ▶(FF)	VOLUME KNOB	set to Hidden (recommended) or Visible

**Memory Locked** - Locking memory will prevent changing of your presets or system settings.

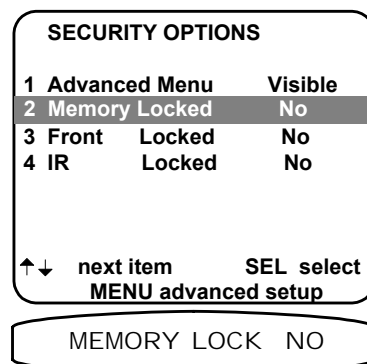

	From Remote	From Front Panel	Action
1	▲(PAUSE) or ▼(STOP)	∧ (UP) or ∨ (DOWN)	move to Memory Lock
2	◀(REW) or ▶(FF)	VOLUME KNOB	No - can change memory Yes - memory is locked

**Front Panel Locked** - Locking the front panel will only allow operation of your receiver with a B&K remote or RS-232 computer interface. Note if you inadvertently lock the front panel, simultaneously pressing SLEEP, UP and DOWN on the front panel will always enter the advanced security options to allow changing these settings.

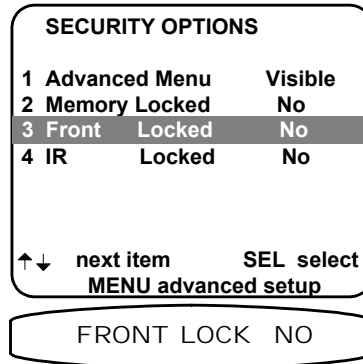

	From Remote	From Front Panel	Action
1	▲(PAUSE) or ▼(STOP)	∧ (UP) or ∨ (DOWN)	move to Front Locked
2	◀(REW) or ▶(FF)	VOLUME KNOB	No - allow front panel operation Yes - DO NOT ALLOW FRONT PANEL OPERATION

**IR Locked** - Locking the IR remote control will only allow operation of your receiver from the front panel or RS-232 computer interface. Note if you inadvertently lock IR, simultaneously pressing SLEEP, UP and DOWN on the front panel will always enter the advanced security options to allow changing these settings.

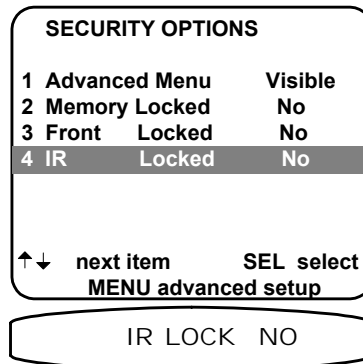

	From Remote	From Front Panel	Action
1	▲(PAUSE) or ▼(STOP)	∧ (UP) or ∨ (DOWN)	move to IR Locked
2	◀(REW) or ▶(FF)	VOLUME KNOB	No - allow IR remote control operation Yes - DO NOT ALLOW IR REMOTE CONTROL OPERATION
3	MENU	∠ MENU	return to ADVANCED SYSTEM SETUP

## DSP Usage

Allows displaying the current DSP usage in MIPS.

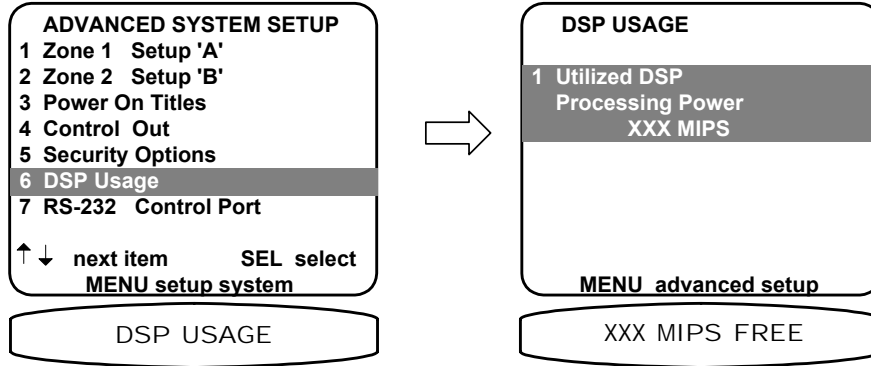

	From Remote	From Front Panel	Action
1	▲(PAUSE) or ▼(STOP)	∧ (UP) or ∨ (DOWN)	move to DSP Usage
2	SEL or ENTER	↵ (ENTER)	activate DSP USAGE
3	▲(PAUSE) or ▼(STOP)	∧ (UP) or ∨ (DOWN)	display currently used DSP MIPS

## RS-232 Control Port

Configure the advanced computer interface control port on your receiver. For further information concerning RS-232 operation, see BKC-DIP for the computer interface protocol, and the AVR202 Plus and Reference 20 Plus device specific appendix's.

### RS-232 port setup -

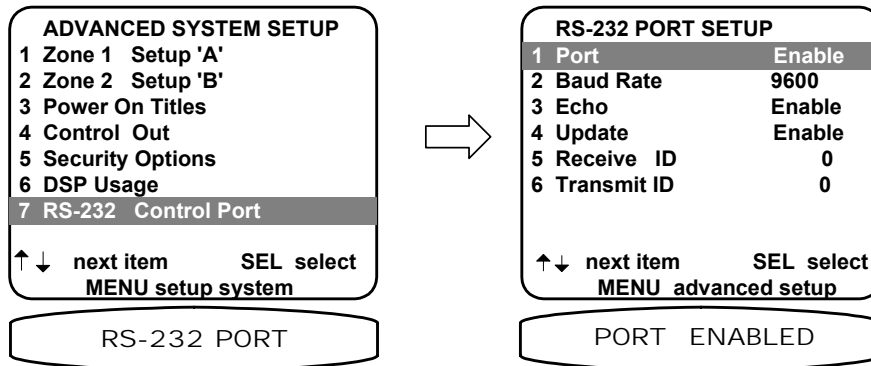

	From Remote	From Front Panel	Action
1	▲(PAUSE) or ▼(STOP)	∧ (UP) or ∨ (DOWN)	move to RS-232 Control Port
2	SEL or ENTER	↵ (ENTER)	activate RS-232 PORT SETUP
3	▲(PAUSE) or ▼(STOP)	∧ (UP) or ∨ (DOWN)	move to Port
4	◀(REW) or ▶(FF)	VOLUME KNOB	select Enabled or Disabled

RS-232 baud rate -

RS-232 PORT SETUP	
1 Port	Enable
2 Baud Rate	9600
3 Echo	Enable
4 Update	Enable
5 Receive ID	0
6 Transmit ID	0
↑↓ next item      SEL select MENU advanced setup	

BAUD RATE 9600

	From Remote	From Front Panel	Action
1	▲(PAUSE) or ▼(STOP)	∧ (UP) or ∨ (DOWN)	move to Baud Rate
2	◀(REW) or ▶(FF)	VOLUME KNOB	select desired baud rate

RS-232 echo -

RS-232 PORT SETUP	
1 Port	Enable
2 Baud Rate	9600
3 Echo	Enable
4 Update	Enable
5 Receive ID	0
6 Transmit ID	0
↑↓ next item      SEL select MENU advanced setup	

ECHO ENABLED

	From Remote	From Front Panel	Action
1	▲(PAUSE) or ▼(STOP)	∧ (UP) or ∨ (DOWN)	move to Echo
2	◀(REW) or ▶(FF)	VOLUME KNOB	select Enable or Disabled

RS-232 update -

RS-232 PORT SETUP	
1 Port	Enable
2 Baud Rate	9600
3 Echo	Enable
4 Update	Enable
5 Receive ID	0
6 Transmit ID	0
↑↓ next item      SEL select MENU advanced setup	

UPDATE ENABLED

	From Remote	From Front Panel	Action
1	▲(PAUSE) or ▼(STOP)	∧ (UP) or ∨ (DOWN)	move to Update
2	◀(REW) or ▶(FF)	VOLUME KNOB	select Enable or Disabled

#### RS-232 receive ID -

**RS-232 PORT SETUP**

1	Port	Enable
2	Baud Rate	9600
3	Echo	Enable
4	Update	Enable
5	Receive ID	0
6	Transmit ID	0

↑↓ next item      SEL select  
 MENU advanced setup

RECEIVE ID 0

	From Remote	From Front Panel	Action
1	▲(PAUSE) or ▼(STOP)	∧ (UP) or ∨ (DOWN)	move to Receive ID
2	◀(REW) or ▶(FF)	VOLUME KNOB	select desired receive ID

#### RS-232 transmit ID -

**RS-232 PORT SETUP**

1	Port	Enable
2	Baud Rate	9600
3	Echo	Enable
4	Update	Enable
5	Receive ID	0
6	Transmit ID	0

move to new line  
 ↑↓ next item      SEL select  
 MENU advanced setup

TRANSMIT ID 0

	From Remote	From Front Panel	Action
1	▲(PAUSE) or ▼(STOP)	∧ (UP) or ∨ (DOWN)	move to Transmit ID
2	◀(REW) or ▶(FF)	VOLUME KNOB	select desired transmit ID
3	MENU	∠ MENU	return to ADVANCED SYSTEM SETUP
4	MENU	∠ MENU	return to SYSTEM SETUP
5	MENU	∠ MENU	return to MAIN MENU

After completing all of your advanced settings you may wish to backup the settings. Refer to Memory Backup/Restore under the MAIN MENU or see the Setup section of this manual

## FACTORY RESET

Should you ever need to completely reset the receiver to the original factory settings from the front panel press the SLEEP, DOWN, and MENU buttons simultaneously. **The receiver will perform a complete reset and erase all user programmed presets, menu settings, and the memory backup if you have performed one.**

# TROUBLESHOOTING

PROBLEM	POSSIBLE CAUSE	POSSIBLE SOLUTION
No sound, display will not light	<ol style="list-style-type: none"> <li>1. Power cord not plugged in.</li> <li>2. Power off at AC source.</li> <li>3. Power switch off.</li> <li>4. AC power inlet fuse blown or faulty. *</li> </ol>	<ol style="list-style-type: none"> <li>1. Reconnect power cord.</li> <li>2. Check power at plug.</li> <li>3. Turn power switch on.</li> <li>4. Check for shorts or overloading. Replace fuse.</li> </ol>
No sound, display on.	<ol style="list-style-type: none"> <li>1. Receiver in mute</li> <li>2. Volume control to minimum.</li> <li>3. Wrong source selected.</li> <li>4. Line stage to amp. cables loose or faulty.</li> <li>5. Source to line stage cables loose or faulty.</li> </ol>	<ol style="list-style-type: none"> <li>1. Unmute receiver.</li> <li>2. Increase volume.</li> <li>3. Select source.</li> <li>4. Tighten, repair, or replace cable.</li> <li>5. Tighten, repair, or replace cable.</li> </ol>
Loud hum or buzz on one or more channels	<ol style="list-style-type: none"> <li>1. Poor ground connection in interconnect cables.</li> <li>2. Poor ground in main AC supply.</li> <li>3. Poor ground on cable box.</li> <li>4. Cables running across back of TV.</li> </ol>	<ol style="list-style-type: none"> <li>1. Check all connectors and repair as necessary.</li> <li>2. Check ground of outlet. Have it checked by qualified serviceman.</li> <li>3. Check ground.</li> <li>4. Reposition cables.</li> </ol>
Surround sound does not sound correct.	<ol style="list-style-type: none"> <li>1. Recordings are not Dolby Surround encoded.</li> <li>2. Recordings are not Dolby Digital.</li> <li>3. Surround processor not in correct mode.</li> <li>4. Check speaker setup.</li> <li>5. Speakers phase wrong.</li> </ol>	<ol style="list-style-type: none"> <li>1. Play a Dolby Surround recording.</li> <li>2. Play a Dolby Digital recording.</li> <li>3. Select proper surround mode.</li> <li>4. Pick correct speaker setup for your system.</li> <li>5. Check wiring of speakers (+) of speaker to (+) on receiver. (-) on speaker to (-) on receiver.</li> </ol>
Remote will not operate unit.	<ol style="list-style-type: none"> <li>1. Batteries missing.</li> <li>2. Batteries dead.</li> <li>3. Batteries inserted wrong.</li> <li>4. Remote signal blocked.</li> <li>5. Lens requires cleaning.</li> <li>6. Wrong programming.</li> </ol>	<ol style="list-style-type: none"> <li>1. Check for batteries inside remote.</li> <li>2. Put in fresh batteries.</li> <li>3. Follow diagram in battery compartment.</li> <li>4. Clear path to front panel of unit.</li> <li>5. Clean lens with a soft cloth.</li> <li>6. Refer to remote manual.</li> </ol>
Video is in Black and White	<ol style="list-style-type: none"> <li>1. Zone 1 (A) video monitor is selected to the wrong signal type.</li> </ol>	<ol style="list-style-type: none"> <li>1. Select the proper video signal type (composite or S-video).</li> </ol>
One or more channels sound bad	<ol style="list-style-type: none"> <li>1. Internal fuses may have blown. * There are two internal fuses per channel</li> </ol>	<ol style="list-style-type: none"> <li>1. Please contact B&amp;K customer service.</li> </ol>

**\* Note:**

If unit continues to blow power inlet fuses, replace only with fuses of same type and rating.

**DO NOT USE A HIGHER RATED FUSE!**, contact B&K customer service.

# RECEIVER SPECIFICATIONS

Audio Specifications		Video Specifications	
Frequency Response:	5 Hz - 20 kHz, +0/-0.5dB	Frequency Response:	20 Hz - 10 MHz $\pm$ 3dB
Input Sensitivity:	2 V in, 1.5 V reference out	Maximum Input Level:	2 V P-P
Maximum Output Level:	3 V rms	Maximum Output Level:	2 V P-P
Signal to Noise Ratio:	98 dB CCIR 2 k Weighted	Input Impedance:	75 Ohms
Input Impedance:	50 k Ohms	Output Impedance:	75 Ohms
Output Impedance:	221 Ohms	Composite Video Inputs	7
Noise Test Reference Level:	46 mV	Composite Video Outputs	5
Surround Outputs	8	SVHS Video Inputs	7
Audio Analog Inputs	7	SVHS Video Outputs	5
Audio Analog Outputs	4		
Multi Channel Input	5.1 format (Optional)		
Digital Inputs coax/optical	6/5		
Digital Outputs coax/optical	1/1 (Zone 1)		
High/Low Pass Crossover Fc	Adjustable 20-200 Hz		
High Pass Crossover Slope	6 or 12 dB/Oct		
Low Pass Crossover Slope	6, 12 or 24 dB/Oct		

Tuner Specifications FM Section		Tuner Specifications AM section	
Frequency Range:	87.5 - 107.9 MHz	Frequency Range:	520 - 1670 kHz
Total Harmonic Distortion:	Less than 0.25%	Total Harmonic Distortion:	Less than 0.3%
Frequency Response	20 Hz - 15 kHz, +1/ -3 dB	Sensitivity:	28 dBf
Capture Ratio:	2 dB	Sensitivity:	28 dBf
IHF (Usable) Sensitivity:	12 dBf	Selectivity:	30 dB
Mono/Stereo Sensitivity:	15 / 35 dBf	Antenna Input Impedance:	300 Ohms
Alternate Channel Selectivity:	65 dB		
Signal to Noise Ratio:	70 dB, A Weighted		
Antenna Input Impedance:	75 Ohms		

Amplifier Specifications		Miscellaneous	
Power rating: 8 ohms:	105 watts @ 1 kHz	Line voltage:	120/220/240 VAC
Frequency response:	5 Hz - 45 kHz	Power consumption:	960 watts max (10 amps @ 120 V) 31 watts standby
THD (S + N):	0.09 % @ 1 kHz	Replacement fuses:	Line -12 Amp/250 Volt Rails - 6 Amp/250 Volt
Damping factor:	150	Dimensions:	17"(w)x15"(d)x5.50"(h)
Current (peak to peak):	28 Amps	Weight:	50 pounds
Slew rate:	14 V/ $\mu$ sec	Warranty:	5 years receiver 1 year remote
Dynamic headroom:	1.4 dB	See Limited Warranty	
S / N (A-weighted):	95 dB		

*Specifications subject to change without notice*



# Limited Warranty

B&K Components Ltd., referred to herein as B&K, warrants your B&K equipment against all defects in material and workmanship for a period of five years from the date of purchase. This warranty applies only to the original purchaser and only to equipment in normal residential use and service. Defective equipment must be returned to B&K, prepaid, accompanied by sufficient payment to cover the cost of return shipping and handling, and will be repaired or replaced at the discretion of B&K whose decision as to the method of reparation will be final.

This warranty shall not apply to any equipment which is found to have been improperly installed, incorrectly fused, misused, abused, or subjected to harmful elements, used in any way not in accordance with instructions supplied with the unit, or to have been modified, repaired or altered in any way without the expressed, written consent of B&K. This warranty does not apply to the cabinet, the remote controller, or appearance items such as the faceplate, control buttons, or display lenses, nor does it cover any expenses incurred in shipping the unit to and from the manufacturer's service depot.

No warranty, implied or otherwise created by State law shall extend beyond the terms of this warranty and B&K shall not be liable for any incidental or consequential damage arising out of a defect in material or workmanship of the unit during the terms of this warranty or thereafter. Some States do not allow the exclusion or limitation of incidental or consequential damages and the foregoing exclusions may not apply to you.

This warranty gives you specific legal rights. You may also have other rights which vary from State to State.

No agent, representative, dealer or employee of B&K has the authority to increase or alter the obligations or terms of this warranty.

## **B&K Components Ltd.**

**Warranty on Remote control is 1 year parts and labor. Customer is responsible for shipping to and from the factory**

## **RETURNING EQUIPMENT**

No equipment may be returned to B&K Components Ltd. without a RETURN AUTHORIZATION. Should you find it necessary to return equipment to B&K, for any reason, a RETURN AUTHORIZATION (RA) number must be issued by B&K in respect of the equipment being returned. You may request an RA number by calling B&K at the numbers below. We will need the following information to issue your RA number. Please have it ready before you call.

1. Your name, address, and phone number.
2. The model and serial number of the equipment being returned.
3. A description of the problem being experienced.
4. Your sales receipt.

Your call will be referred to a Technical Service Representative who will work with you to resolve the problem. If it is determined that the unit must be returned for repair, an RA number will be issued.

**B&K Components Ltd. 2100 Old Union Road, Buffalo New York 14227  
1-800-543-5252 or 1-716-656-0026**

# REAR PANEL ENLARGED VIEW

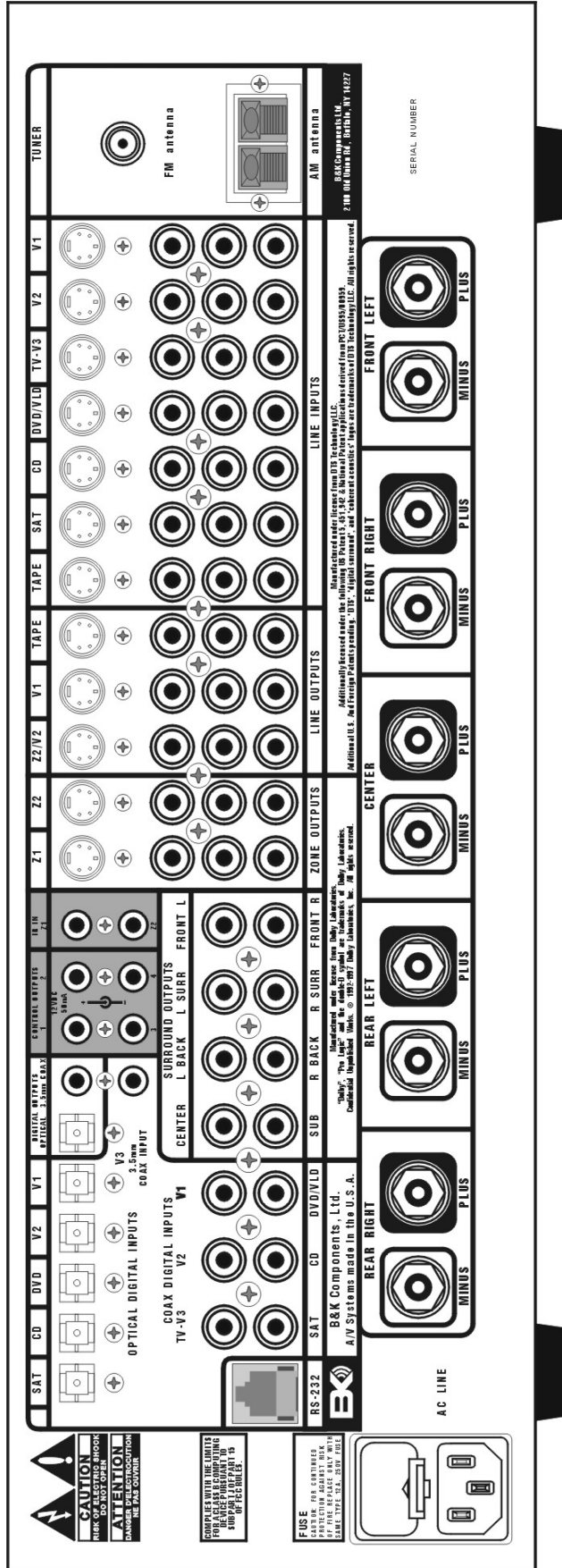

# THE MENU SYSTEM

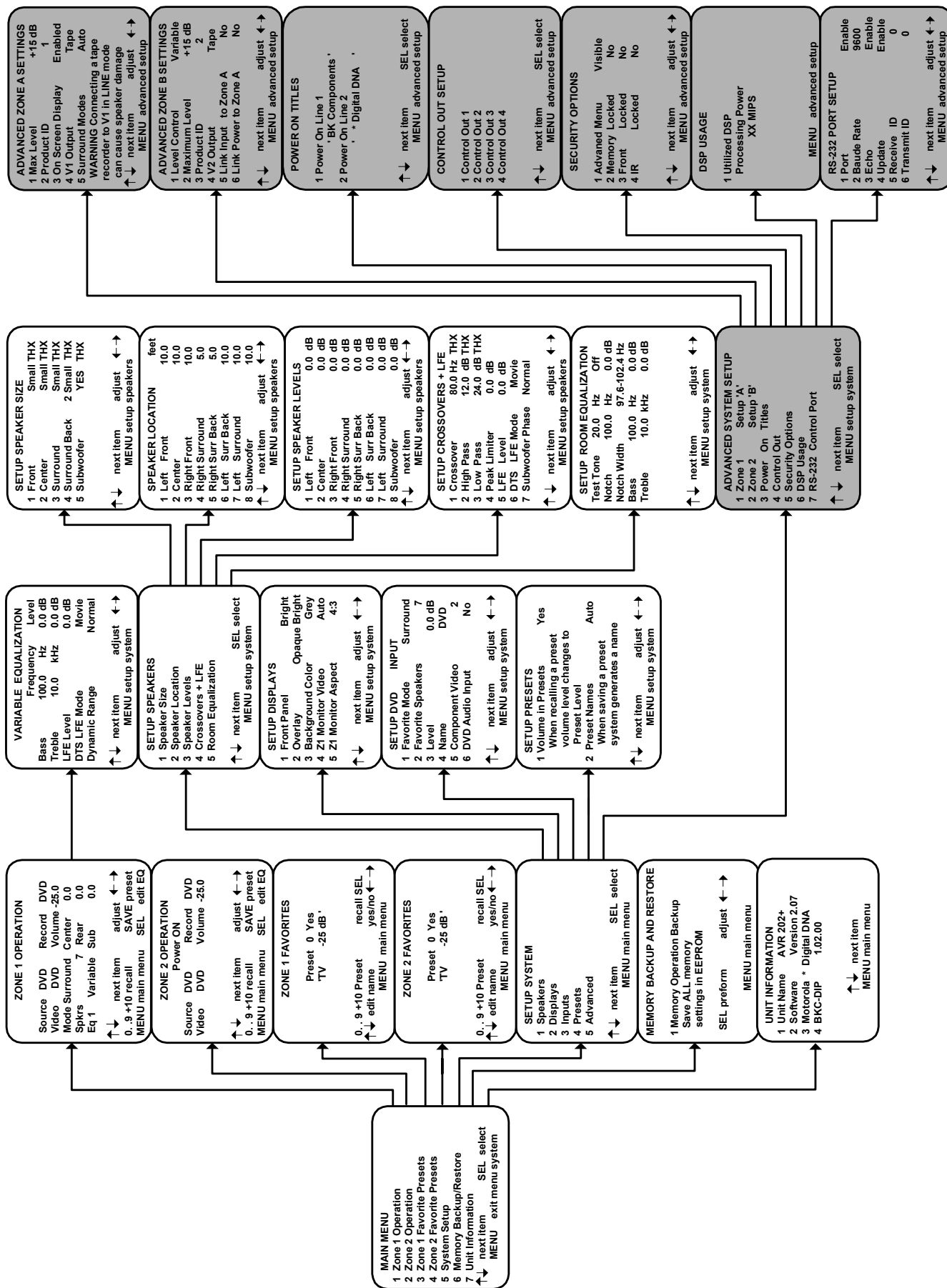

**B&K Components, Ltd.**  
**2100 Old Union Road**  
**Buffalo, New York 14227**  
**Phone: 716 – 656 - 0023**  
**[www.bkcomp.com](http://www.bkcomp.com)**

## Free Manuals Download Website

<http://myh66.com>

<http://usermanuals.us>

<http://www.somanuals.com>

<http://www.4manuals.cc>

<http://www.manual-lib.com>

<http://www.404manual.com>

<http://www.luxmanual.com>

<http://aubethermostatmanual.com>

Golf course search by state

<http://golfingnear.com>

Email search by domain

<http://emailbydomain.com>

Auto manuals search

<http://auto.somanuals.com>

TV manuals search

<http://tv.somanuals.com>