



AMERICA'S MOST LIVEABLE RVs.

Baja

JAY SERIES

SELECT

**Model Year 2006
Camping Trailer
Owner's Manual**



WARNING: Read all instructions in this manual and component manufacturer supplied information before using your RV.

This manual has been provided by Jayco, Inc. for the sole purpose of providing instructions concerning the operation and maintenance of this vehicle and its components. Nothing in this manual creates any warranty, either expressed or implied. The only warranty offered by Jayco, Inc. is as set forth in the limited warranty applicable to this vehicle.

The owner's failure to provide required service and/or maintenance could result in the loss of warranty. The owner should review Jayco's limited warranty and the limited warranties that apply to specific components that are offered with this vehicle.

Instructions are included in the manual for operating various components which are optional on some vehicles. In addition, the owner should refer to individual manufacturer's operating instructions contained in the owner's packet.



WARNING:

- **Review the compatibility of your tow vehicle with the trailer you will be towing. You, as the owner, are responsible for the safety and compatibility of your tow vehicle and trailer selections.**
- **You must not exceed the gross vehicle weight rating (GVWR) of the trailer. Include all additions, cargo and tank fluids when calculating the weight of your trailer.**
- **Do not exceed the towing or cargo capacity of your tow vehicle. You must clearly understand how your tow vehicle's capacities are calculated.**
- **Do not load your trailer so that it is unbalanced from front to rear or from side to side.**
- **Know your loaded hitch weight and select a hitch that is adequate for that weight. Consult your hitch and tow vehicle manufacturers with any questions before you tow your trailer.**
- **You are responsible for the maintenance of your tow vehicle and trailer. Make sure your tow vehicle is mechanically sound for your intended usage. Pay particular attention to suspension components, tires and tire pressure.**
- **We recommend the use of sway control devices and weight distributing hitches with all Jayco towable products (excluding fifth-wheels, which use a different type of hitch).**
- **Obey all traffic laws and use your seatbelts at all times. Many states have lower speed limit requirements for tow vehicle/trailer combinations. We recommend that you do not exceed 55 MPH when towing a trailer.**

Consult an expert for specific driver education when towing a trailer. There are private RV driving schools, and some RV clubs, which offer driving seminars as part of their club activities. Recreation vehicle publications and the Internet can be a source of information regarding RV driver education, as well as many other topics to help you learn to safely use your recreation vehicle.

YOUR NEW JAYCO IS YOUR PASSPORT TO A WHOLE WORLD OF NEW FRIENDS, CAMPING FUN AND TRAVEL ADVENTURE WHEN YOU JOIN THE THOUSANDS OF JAYCO FAMILIES WHO MAKE UP THE . . .

JAYCO JAFARI INTERNATIONAL TRAVEL CLUB

You will find us enjoying the friendship and fellowship of JAFARI CAMPING as we join our local area FLIGHTS at hundreds of weekend camp-outs all over North America each month . . .

WE'RE THE FAMILIES OF JAYCO!

There are special STATE, REGIONAL and INTERNATIONAL RALLIES where you can join with your fellow JAFARIANS and their flights to enjoy a special kind of togetherness . . . fun, games, and entertainment provide memories to last a lifetime.

And . . . how about the exotic surroundings of NEW ORLEANS, the sounds and color of NASHVILLE and the GRAND OLE OPRY, the roar and rush of the INDIANAPOLIS 500, the quiet surroundings of the CANADIAN ROCKIES, the color of the SMOKY MOUNTAINS in the Fall. These and many other adventures can be yours when you join the. . .

JAYCO JAFARI INTERNATIONAL TRAVEL CLUB

Fill in the blanks on the reverse side, cut along dotted line and mail along with a check to:

JAYCO JAFARI INT'L TRAVEL CLUB

ATTN: Membership Coordinator

P.O. Box 192

Osceola, IN 46561-0192

Yes, it's for everyone with a JAYCO RV; young couples just starting out, families spending quality time together, the young at heart expanding their life experiences. Whether you belong to another camping club, have always traveled alone, or are just starting, don't miss out on one of the most priceless benefits of being an RV family . . . meet new friends and spend a bit of your camping life with some of the finest people you will ever have the opportunity to share a campfire or treasure a moment of golden living with a . . . FIFTH-WHEEL TRAVEL TRAILER. . .SPORT UTILITY TRAILER . . . CONVENTIONAL TRAVEL TRAILER . . . TYPE C MOTORHOME . . . FOLDING CAMPING TRAILER . . . it doesn't matter. If you are a JAYCO RV FAMILY, then you are eligible to become a Jayco Jafari Member.

YOU WILL NEVER BE SORRY YOU MADE THE DECISION!

Your membership entitles you to:

- Special international decals for your unit.
- The Hitch newsletter with schedules of upcoming events and activities.
- A membership roster - containing the names and addresses of current members of the club will be sent bi-yearly.
- Discount Cards for several national theme parks including Six Flags and Busch Corp. Parks.
- A special price is available on Wheeler's Campground Guides.
- Discounts with Hertz Rental Car.
- Discounts with Coach Net, an emergency roadside service.
- Farm & City Insurance has RV insurance available at discounted rates to current Jayco Jafari International Club members.
- All of this, plus the joy of meeting new friends and enjoy Jafari adventures around the country.

Start with the first phase of your camping life...just complete the following application and forward it to the Jayco Jafari International Travel Club office. Your membership application may also be completed online, by visiting our website at www.jaycorvclub.com. If you have further questions. contact the club office direct at the website or by calling 800-262-5178. Local calls can be made to 574-258-0571.



WELCOME TO THE JAFARI FAMILY!



TO: Membership Coordinator for the Jayco Jafari International Travel Club

Please enroll us as members in the Jayco Travel Club. We are ready to roll to where the "friends we just haven't met yet" have the coffee on the fire and are waiting for us to arrive: We are ...

Name: _____ Spouse: _____

Address: _____ Phone: _____

City: _____ State: _____ Zip: _____

Email: _____

Ages of Children at Home: _____

Our JAYCO is a: _____ Our Dealer _____
(type & size)

Membership Dues:

One year	\$25.00	Amount enclosed. \$ _____
Two years:	\$45.00	Check #: _____
Three years:	\$65.00	

_____ (signature)

_____ (date)

Table of Contents

Welcome.	1
Warranty/Service.	3
Towable Limited Warranty	4
Extended Transferable Limited Warranty	7
Warranty Registration and Customer Delivery Form	9
Limited Warranty Transfer	10
Service Procedures	12
Basic Service Procedures.	12
Independent, Authorized Dealer	13
Parts	13
Owner's Responsibility	13
Manufacturer's Customer Support Directory.	14
Safety.	15
Safety Considerations	15
Reporting Safety Defects.	15
Safety in Using Propane	16
Checking for Leaks.	16
To Leak Test the Propane System	16
If a Leak is Detected.	17
Carbon Monoxide Detector	17
Electrical System Safety	18
Water System Safety	18
Fire Extinguisher	18
Inspection and Maintenance.	18
Changes, Modifications and Additions.	19
Safety When Emergency Stopping	19
Additional Safety Considerations	20
Cold Weather/Extended Use.	20
Condensation	21
Insurance	21
Before you travel....	23
Weights and Cargo Capacity	23
Loading Cargo.	24
Rear Bumper	25
Front Deck (Baja Trailers Only)	25
Loading Ramps	25
Roof	26
Holding Tank(s) and Trailer Weight.	26
Weighing Instructions	27
To Properly Weigh Your Recreation Vehicle	27
To Determine the Wheel Position Weight	27
Equipment.	28
Tow Vehicle	28
Hitches	29
Weight Distributing System.	29
Sway Control	29

Table of Contents

Hitch Height and Hitch Ball Specifications.	30
The Hitching Procedure	30
The Safety Chain	31
Towing	32
Towing Behind Your Trailer	32
Tires	33
Wheel Lugs	34
Electric Brakes	35
Hydraulic Brakes	36
Backing Your Trailer.	37
Breakaway Protection	37
When the Camping Trailer is New.	37
Pre-Travel Checklist.	38
Setting up Camp...	41
Selecting your Campsite.	41
Additional Considerations with a Baja Trailer	41
Setting Up Your Trailer	42
Front Deck (Baja Trailers Only)	42
Un-Hitching	42
Leveling Your Trailer	43
Stabilizer Jacks	43
Tent Set Up	43
Opening Your Folding Camping Trailer	44
For Models With Slideout	45
To Install Door	46
Closing Your Folding Camping Trailer	47
Inside.	47
Outside.	48
For Models With Slideouts.	48
Canopy Set Up	49
Screen Room Set Up	50
Heated Bed Mat (Option).	50
Dinette to Bed Conversion	51
Dinette Table Exterior Use	51
Utility Hookups	51
Electricity	51
Water	52
To Utilize the City Water Connection	52
To Utilize On Board Water	52
12 Volt DC On-Demand Pump	53
Water Pressure Regulator	53
Waste Water Disposal.	53
Propane Connections and Start Up	54
At Camp...	55
Ice Box	55
Refrigerator (Option)	55
Stove, Range, Oven	55

To Use the Stove Outside	55
Connecting the Propane Line	56
Microwave (Select Models only)	56
Furnace (Option)	56
Water Heater (Option On Some Models)	56
Cassette Toilet (Option)	57
Outside Shower (Some Models)	57
Operation	57
Water Purification System (Option)	57
To replace the filter	58
Air Conditioner Prep (Option)	58
Solar Prep (Option - Baja Only)	59
Entertainment	59
BBQ Grill Prep	59
BBQ Grill (Option)	60
Utilities & Systems	61
Plumbing System	61
Sanitizing the Potable Water System	61
Drainage - Fresh Water	61
Sanitation System (With Bath/Shower Option Only)	62
Propane System	62
Propane Container	63
Installing Propane Cylinders	64
Servicing and Filling Propane Containers	64
OPD Overfill Protection	65
Single Cylinder Mounted On A-Frame	66
Double Cylinder Mounted On A-Frame	66
Main Supply Hose – Low Pressure	67
Regulator	67
Propane Consumption	67
Propane Detector	68
Electrical System	68
General	68
120-Volt AC System	69
Power Cord	69
GFCI	69
Testing Instructions	70
12-Volt DC System	70
Power Converter	70
Interior	71
Auxiliary Battery (Independent, Authorized Dealer Installed Option)	71
Battery Charger	72
Trailer Hitch Plug	72
Bulbs	73
Fuses	73

Preparing to Travel Home...	75
Departing Camp Checklist.	75
Draining Waste Water	76
Drainage Outlet.	76
Gray Water Holding Tank	77
Maintaining your Investment....	79
Maintenance	79
Exterior Finish.	79
Aluminum	79
Fiberglass	79
Sealants	80
Roof Latches.	81
Lifter System	81
Lifter Posts	81
Winch	81
Frame	81
Coupler	81
Tongue Jack	82
E-Z Lube Axle.	82
Wheel Bearings.	82
Wheel Lugs.	82
Electric Brakes and Brake Linings	82
Hydraulic Brake Maintenance and Lubrication	83
Tires	83
Rear Bumper Spare Tire Carrier	83
To remove the tire from the tire carrier	83
To install the tire on the tire carrier	83
Changing Tire	84
Vinyl Tire Cover (Option)	84
Clearance Lights.	84
Doors, Extrusions & Vents	84
ABS Plastics.	84
Bed	85
Bed Slides	85
Bed Braces	85
Heated Bed Mats.	85
Fabric Components	85
Definitions	85
Interior	85
Exterior	86
Fabric Care	86
Cushions/Bed Mats.	86
SoftShades™.	86
Tents	87
Exterior.	87
Interior	87
Condensation.	88

Canopy	88
Screen Room	89
Fiberglass Screening	89
Paneling	89
Vinyl Floor	89
Countertops	90
Hardware and Sink or Shower Fixtures	90
Furnace Maintenance	90
Air Conditioner	90
Propane System	90
Propane Cylinders	91
Carbon Monoxide (CO) Detector	91
Maintenance Checklist	92
Storing your Unit...	95
Storage Checklist	95
Prior to Storage	95
During Storage Period	96
Camping Trailer Covers	96
Winterizing	96
Demand Or Power Plumbing Systems (Fig. 45)	97
Drain Traps	97
Cassette Toilet (With Bath/Shower Option Only)	97
Index	99

WELCOME

Thank you for purchasing your Jayco Recreation Vehicle (RV) and welcome to the world of recreation vehicle travel. Your purchase of a Jayco RV allows you to enter this unique world of camping and leisure in a grand style. Your Jayco RV has been designed and engineered to offer many comforts of home to make your camping experience as enjoyable as possible. Jayco RVs are designed, constructed, warranted and intended to be used as temporary living quarters for recreational, camping and travel uses, as defined in the bylaws of the Recreation Vehicle Industry Association. Our recreation vehicles are not intended for hauling of cargo.

This owner's manual will assist you in understanding the RV's proper use and operation. If you are a newcomer to RV travel, you will appreciate the suggestions and "shop talk" information found throughout this manual.

Keep this manual in your recreation vehicle for handy reference. Get to know your new vehicle and how it operates. The information in this manual reflects the most current available to us at the time of publication. This manual is a supplement to various other instructions supplied by the manufacturers of separately manufactured and warranted component parts. Carefully read, understand and follow this owner's manual and all information supplied by manufacturers of components. This information contains important operating, safety, and maintenance instructions. Direct questions that are not answered by the owner's manual or other booklets, to your independent, authorized dealer. If they cannot satisfactorily answer your questions, they will call or refer you to the component part manufacturer or Jayco.

Your vehicle was manufactured based on the applicable requirements of:

- Federal Motor Vehicle Safety Standards
- State Regulations
- Canadian Standards Associations (CSA) (where applicable)
- Requirements of ANSI Standard A119.2, the nationally recognized Standard For Recreation Vehicles – Installation of Plumbing, Heating and Electrical Systems.

The Recreation Vehicle Industry Association (RVIA) and Canadian Standards Association (CSA) periodically inspect our production line and assist us in maintaining strict compliance with installation and safety standards for those systems.

Periodic safety inspections and a program of preventive maintenance are necessary for the continuation of safe and trouble-free operation.

Camping is a great way to relax and enjoy the outdoors with your friends and family. Please remember to tread lightly on our beautiful land and leave only your footprints so that others may enjoy nature as much as you did.

The Jayco Family

Jayco, Inc.

WARRANTY/SERVICE

The following pages contain warranty information. It is our recommendation that you read through Jayco's warranty and all other warranties. If there is any part which you do not understand, consult with your independent, authorized dealer, appropriate component part manufacturer or Jayco for further explanation. The warranty titles are defined as follows:

- **Towable Limited Warranty** - This warranty comes direct from the manufacturer to the original purchaser. It provides limited coverage for your recreation vehicle, when used only for its intended purpose of recreational travel and camping, for two (2) years. Beyond this, it can be transferred one time only within the warranty period.
- **Extended Transferable Warranty** - Our folding camping trailers come with this warranty, which is also referred to as our Lifetime Coverage Warranty. This warranty provides extended limited warranties on the tent, frame, floor, lifter system and roof of your folding camping trailer as defined in the warranty.
- **Warranty Registration & Customer Delivery Form** - This form is to be completed by the independent, authorized dealer when you pick up your unit. Once it is completed and signed, the independent, authorized dealer will forward the information to us so we can register your trailer.
- **Limited Warranty Transfer Application** - This is the form required to transfer the warranty as indicated above in the Towable Transferable Warranty. This form must be completed and filed as instructed for the transfer to occur. If you have questions, consult with your independent, authorized dealer.

TOWABLE LIMITED WARRANTY

WHAT AND WHO IS COVERED

The Jayco warranty covers this recreational vehicle ("RV"), when used only for its intended purpose of recreational travel and camping, for two (2) years. The warranty period begins on the date that the RV is delivered to the first retail purchaser by an independent, authorized dealer of Jayco, or, if the dealer places the vehicle in service prior to retail sale, on the date the RV is first placed in such service. In the event that a substantial defect in material or workmanship, attributable to Jayco, is found to exist during the warranty period, it will be repaired or replaced, at Jayco's option, without charge to the RV owner, in accordance with the terms, conditions and limitations of this limited warranty.

This limited warranty applies to the first consumer purchaser, and the next subsequent owner, only. This limited warranty may be transferred once during the warranty period. However, the subsequent owner must submit a warranty transfer form to Jayco to make the warranty transfer effective. You may contact an independent, authorized dealer for details. All rights and limitations within this warranty are applicable to the original owner and the subsequent owner of the RV. The subsequent owner's warranty coverage period is the remaining balance of the warranty coverage period that the prior owner was entitled to under this limited warranty.

Jayco's obligation to repair or replace defective materials or workmanship is the sole obligation of Jayco under this limited warranty. Jayco reserves the right to use new or remanufactured parts of similar quality to complete any work, and to make parts and design changes from time to time without notice to anyone. Jayco reserves the right to make changes in the design or material of its products without incurring any obligation to incorporate such changes in any product previously manufactured. Jayco makes no warranty as to the future performance of this RV, and this limited warranty is not intended to extend to the future performance of this RV, or any of its materials, components or parts. In addition, the RV owner's obligation to notify Jayco, or one of its independent, authorized dealers, of a claimed defect does not modify any obligation placed on the RV owner to contact Jayco directly when attempting to pursue remedies under state or federal law.

LIMITATIONS, EXCLUSIONS AND DISCLAIMER OF IMPLIED WARRANTIES

ANY IMPLIED WARRANTY THAT IS FOUND TO ARISE BY WAY OF STATE OR FEDERAL LAW, INCLUDING ANY IMPLIED WARRANTY OF MERCHANTABILITY OR ANY IMPLIED WARRANTY OF FITNESS, IS LIMITED IN DURATION TO THE DURATION SET FORTH IN THIS LIMITED WARRANTY AND IS LIMITED IN SCOPE OF COVERAGE TO THE SCOPE OF COVERAGE OF THIS LIMITED WARRANTY. Jayco makes no warranty of any nature beyond that contained in this limited warranty. Jayco does not authorize any person to create any other obligation or liability for it regarding this RV, and Jayco is not responsible for any representation, promise or warranty made by any dealer or other person beyond what is expressly stated in this limited warranty, and no one has the authority to enlarge, amend or modify this limited warranty. Any selling or servicing dealer is not Jayco's agent, but an independent entity.

JAYCO SHALL NOT BE LIABLE FOR ANY INCIDENTAL OR CONSEQUENTIAL DAMAGES THAT MAY RESULT FROM BREACH OF THIS LIMITED WARRANTY OR ANY IMPLIED WARRANTY. THIS EXCLUSION OF CONSEQUENTIAL AND INCIDENTAL DAMAGES SHALL BE INDEPENDENT OF ANY FAILURE OF THE ESSENTIAL PURPOSE OF ANY WARRANTY, AND THIS EXCLUSION SHALL SURVIVE ANY DETERMINATION THAT THIS LIMITED WARRANTY OR ANY IMPLIED WARRANTY HAS FAILED OF ITS ESSENTIAL PURPOSE.

Some states do not allow limitations on how long an implied warranty lasts, or the exclusion or limitation of incidental or consequential damages, so the above limitations or exclusions may not apply to you.

HOW TO GET SERVICE

To obtain warranty service the owner must do all of the following:

1. Notify an independent, authorized dealer of Jayco, or Jayco, of the substantial defect in material or workmanship attributable to Jayco, within the warranty coverage period designated above;
2. Provide the notification mentioned in (1), above, within ten (10) days of when the owner discovered, or should have discovered, the substantial defect in material or workmanship attributable to Jayco;
3. Promptly schedule an appointment with and take the RV to an independent, authorized dealer of Jayco, or Jayco, for repairs; and
4. Pays any freight or transportation costs, import duties, fees and all incidental expenses associated with obtaining warranty service.

For warranty service, simply contact one of Jayco's independent, authorized service centers for an appointment and then deliver your RV to the service center on the specified appointment date. If you need assistance you may contact Jayco, at P.O. Box 460, Middlebury, Indiana 46540, Attn: Aftermarket Service, (574) 825-0608, or <http://www.jayco.com>.

NOTE: Jayco does not control the scheduling of service work at the independent, authorized dealerships. You may encounter some delay in scheduling or completion of work. Also, you must notify the selling dealer at time of delivery to have work performed on any defect that occurred at the factory during manufacture at no cost to you as provided by this limited warranty. (See below under WHAT IS NOT COVERED).

If two (2) or more service attempts have been made to correct any covered defect that you believe impairs the value, use or safety of the RV, or if it has taken longer than thirty (30) days for those types of repairs to be completed, you must, to the extent permitted by law, notify Jayco directly, in writing, at the above address, of the unsuccessful repair(s) of the alleged defect(s) so that Jayco can become directly involved in making sure that you are provided service pursuant to the terms of this limited warranty.

WHAT IS NOT COVERED

By way of example only, this Limited Warranty does not cover any of the following: defects in materials, components or parts of the RV not attributable to Jayco, items that are added or changed after the RV leaves the possession of Jayco; additional equipment or accessories installed at any dealership, or other place of business, or by any other party, other than Jayco; any RV used for rental or other commercial purposes (Note: It shall be concluded that the RV has been used for commercial and/or business purposes if the RV owner or user files a tax form claiming any business or commercial tax benefit related to the RV, or if the RV is purchased in a business name); any RV not used solely for recreational travel and camping; normal wear, tear or usage, such as tears, punctures, soiling, mildew, fading, or discoloration of exterior plastic or fiberglass, or soft goods, such as upholstery, drapes, carpet, vinyl, screens, cushions, mattresses and fabrics; the effects of condensation or moisture from condensation inside the RV; mold or any damage caused by mold to the inside or outside of the RV; imperfections that do not affect the suitability of the RV for its intended purpose of recreational use or items that are working as designed but that you are unhappy with; problems, including water leaks, related to misuse, mishandling, neglect or abuse, including failure to maintain the RV in accordance with the owner's manual, or other routine maintenance such as inspections, lubricating, adjustments, tightening of screws, tightening of lug nuts, sealing, rotating tires; damage due to accident, whether or not foreseeable, including any acts of weather or damage or corrosion due to the environment, theft, vandalism, fire, or other intervening acts not attributable to Jayco; damage resulting from tire wear or tire failure; defacing, scratches, dents, chips on any surface or fabric of the RV; damage caused by off road use, overloading the RV or alteration of the RV, or any of its components or parts; wheel alignment or adjustments to axles when caused by improper maintenance, loading or damage from road hazards, including off road travel, wheel damage or balancing or damage from tire failures.

In addition, this limited warranty does not cover any material, component or part of the RV that is warranted by another entity, including, by way of example, handling, braking, wheel balance, muffler, tires, tubes, batteries, gauges, generator, jacks, inverter, microwave, television, VCR, CD player, tape player, radio, speakers, television, refrigerator, range, water heater, stove, carbon monoxide detector, smoke detector, furnace or any air conditioner. (Note: The written warranty provided by the manufacturer of the component part is the direct responsibility of that manufacturer).

Defects and/or damage to interior and exterior surfaces, trim, upholstery and other appearance items may occur at the factory. These items are usually detected and corrected at the factory or by the selling dealer prior to delivery to the retail customer. You must inspect your RV for this type of damage when you take delivery. If you find any such defect or damage you must notify the selling dealer at time of delivery to have these items covered by this limited warranty and to have work performed on the items at no cost to you as provided by this limited warranty.

EVENTS DISCHARGING JAYCO FROM OBLIGATION UNDER WARRANTY

Certain things completely discharge Jayco from any obligation under this warranty and void it. By way of example, the following shall discharge Jayco from any express or implied warranty obligation to repair or replace any defect that results from: any rental or other commercial use or purchase of the RV (as defined in this warranty), any defect in a separately manufactured component part, owner neglect or failure to provide routine maintenance (See Owner's Manual), unauthorized alteration, off road use, collision or accident, whether or not foreseeable, including any acts of weather or damage or corrosion due to the environment, theft, vandalism, fire, explosions, overloading in excess of weight ratings, and tampering with any portion of the RV.

LEGAL REMEDIES

Any action to enforce any portion of this limited warranty, or any implied warranty, shall be commenced within six (6) months after expiration of the warranty coverage period designated above. Any performance of repairs shall not suspend any limitation period from expiring. Any performance of repairs after the warranty coverage period has expired, or performance of repairs regarding any thing excluded from coverage under this limited warranty shall be considered "good will" repairs, and they will not alter the express terms of this limited warranty, or extend the warranty coverage period or this limitation period in this paragraph. In addition, this warranty is not intended to extend to future performance, and nothing in this warranty, or any action of Jayco, or any agent of Jayco, shall be interpreted as an extension of the warranty or this limitation period. Some states do not allow a reduction in the statute of limitations, so this reduction may not apply to you.

WARRANTY REGISTRATIONS:

Your warranty registration records should be completed and delivered to the manufacturers of component parts. The selling dealership will assist you in completing and filling out the Jayco product warranty registration form. That form must be returned to Jayco within ten (10) days of your taking delivery of the RV. Your Jayco warranty will not be registered unless this warranty registration is completed and received by Jayco. Failure to file this warranty registration with Jayco will not affect your rights under this limited warranty as long as you can present proof of purchase, but it can cause delays in obtaining the benefits of this limited warranty, and it may inhibit any servicing facility's ability to provide proper repairs and/or part replacement.

CARE AND MAINTENANCE

It is the Owner's responsibility to perform proper care and maintenance of the RV, and to assure correct load distribution. For details regarding this, please see your Jayco owner's manual and the owner's manuals of other component part manufacturers. These outline various care and maintenance that is required to maintain your RV. Please review all manuals supplied with your RV, and contact your selling dealership or supplier of the component part if you have questions. Note: Failure to maintain the RV as noted in those manuals voids this limited warranty, and any damage to the RV as a result of your failure to perform such care, is not covered by this limited warranty.

THIS WARRANTY GIVES YOU SPECIFIC LEGAL RIGHTS, AND YOU MAY ALSO HAVE OTHER RIGHTS THAT VARY FROM STATE TO STATE.

JAYCO, INC.

903 South Main * P.O. Box 460 * Middlebury, IN 46540

Telephone: 574-825-0608

EXTENDED TRANSFERABLE LIMITED WARRANTY

FOLDING CAMPING TRAILERS
TENT, FRAME, FLOOR, LIFTER SYSTEM, ROOF

SUMMARY OF LIMITED WARRANTY:

Jayco provides extended limited warranties on the tent, frame, floor, lifter system, and roof of folding camping trailers as outlined below. Jayco warrants that all parts of our manufacture are free from substantial defects in materials and workmanship during the warranty period under normal use and service, when used for its intended purpose of recreational travel and camping. The warranty period shall begin on the date the vehicle is sold to the first retail consumer purchaser or subsequent transferee or, if the dealer prior to sale first places the vehicle in service, on the date the vehicle is first placed in such service.

This warranty may be transferred one time only within a two (2) year period from the date the vehicle is sold to the first retail consumer purchaser or, if the dealer prior to sale first places the vehicle in service, on the date the vehicle is first placed in such service with proper application.

Lifter System

(1) Jayco extends to the original consumer purchaser and subsequent transferee, a limited warranty on the lifter system against functional defects in material or workmanship for the lifetime of the folding camping trailer.

(1A) Exclusions:

Normal adjustments to the lift system (such as periodic roof height adjustment to compensate for stretch in cables) are covered by this warranty for the first year only.

The installation of a roof air conditioner or any other cargo CANNOT exceed 350 pounds. Exceeding this limit voids the warranty provision on the lift system. Do not lift roof with any load in place and always unlock all roof latches before raising.

Any damages resulting from alterations to the lift system.

Any damages caused by improper maintenance, improper repair, improper use or by use of improper repair parts.

Steel Frame

(2) Jayco extends to the original consumer purchaser and subsequent transferee, a limited warranty on the steel frame against functional defects in material or workmanship for the lifetime of the folding camping trailer.

(2A) Exclusions:

This lifetime provision does not include the frame surface, axle beam, suspension or running gear components.

Floor/Bed Platforms

(3) Jayco extends to the original consumer purchaser or subsequent transferee, a limited warranty on the floor against functional defects in material or workmanship in the structural integrity of the floor for the lifetime of the folding camping trailer. Jayco extends to the original retail purchaser, a limited warranty on the bed wood against functional defects in material or workmanship for the lifetime of the folding camping trailer and applies only to the structural integrity of the bed wood.

(3A) Exclusions:

Functional defects in the vinyl floor covering are covered for the first year of ownership only. The vinyl floor covering is NOT warranted against gouges, cuts or tears. Repair or replacement of the vinyl floor covering will be the sole remedy for defects.

Roof

(4) Jayco extends to the original consumer purchaser or subsequent transferee, a limited warranty on the roof against functional defects in material or workmanship for the lifetime of the folding camping trailer.

(4A) Exclusions:

This warranty provision for the roof does not include maintenance, surface finish, re-sealing, or damage due to the installation of non-standard equipment. NOTE: Snow loads must be removed from the roof to avoid damage to the roof. **All roof seams and moldings must be resealed (cap sealed) at least once each year.**

Tent Material

(5) Jayco extends to the original consumer purchaser or subsequent transferee, a limited warranty on the tent material for five (5) years from the date of retail purchase against functional defects in material or workmanship on the folding camping trailers. During the first two years, parts, labor and freight are covered. During year three, four and five, parts, Jayco factory labor and return freight from Jayco are covered. Dealer labor to remove and reinstall the tent plus shipping costs to Jayco is not covered. (In simple terms, you send it to us, we will fix it and send it back during year three, four and five).

(5A) Exclusions:

The tent is not warranted against fading, discoloration, soiling, leaking due to contaminants, mildew from condensation or storing tent when wet, or problems resulting from misuse or abuse. Rips, tears and damage caused by insects and/or rodents are not covered under any warranty.

Extended Transferable Limited Warranty Page 1 of 2

COMPANY'S OBLIGATIONS:

If the manual lifter system, steel frame, floor or roof is determined to have a functional defect in material or workmanship during the warranty term, Jayco will remedy the defect without charge for parts or labor, within a reasonable time after receipt of notice, either by repair or replacement at Jayco's sole option. Coverage for the tent is for the pro-rated duration as noted in Policy 5 of this warranty. Warranty service may be obtained from Jayco or its authorized dealers, or repair centers designated and authorized by Jayco or its dealers. In the event the purchaser discovers a functional defect in the manual lifter system, steel frame, floor or roof, and has one of those components repaired by an unauthorized service person and said repairs are covered by this Warranty, Jayco shall be liable only for costs of those repairs up to the amount that Jayco would have incurred if Jayco or an authorized dealer had made the repairs. Warranty performance will commence within a reasonable time after Jayco's receipt of notice of the defect and will be completed within a reasonable time, subject to availability of parts and scheduling.

ITEMS EXCLUDED FROM WARRANTY:

This warranty does not cover defects caused by:

- (A) Negligence in operation and maintenance.
- (B) Misuse
- (C) Damage not resulting from defect or malfunction (act of God)
- (D) Any damage caused by alterations or additions to original equipment.
- (E) Claims relating to unauthorized repair, damage or defects.
- (F) Commercial or residential use.

PURCHASER'S OBLIGATIONS:

Purchaser shall give notice on this warranty within ten days after discovery of the defect to either an authorized Jayco dealer or Jayco. Notice should contain the name and mailing address, proof of date of purchase, model, year and serial number of the unit, name and address of the selling dealer and a description of the defect. All costs incurred by Purchaser in transporting the Jayco folding camping trailer for warranty service shall be borne by Purchaser. No action to enforce this Warranty shall be commenced later than three (3) months after the expiration of the warranty period.

DISCLAIMER OF CONSEQUENTIAL AND INCIDENTAL DAMAGES:

You and any other user of Jayco products shall not be entitled to any consequential or incidental damages, including without limitation, loss of use of the unit, inconvenience, lodging, damage to personal property, phone calls, meals, lost income or earnings. This warranty gives you specific legal rights and you may also have other rights, which vary from state to state.

DISCLAIMER AND LIMITATION OF IMPLIED WARRANTIES:

Jayco does not authorize any person to create for it any other obligation or liability in connection with this vehicle. Any implied warranty of merchantability or fitness for a particular purpose applicable to this vehicle is limited in duration to the duration of this written warranty. The performance of repairs is the exclusive remedy under this written warranty or any implied warranty. Jayco shall not be liable for incidental or consequential damages resulting from breach of this written warranty or any implied warranty. Some states do not allow limitations on how long an implied warranty will last or the exclusion or limitation of incidental or consequential damages, so the above limitations or exclusions may not apply to you.

PARTS AND DESIGN CHANGES:

Jayco may make parts and design changes from time to time without notice and repairs or replacements may be made with new or different parts. Jayco reserves the right to make changes in the design or material or its products without incurring any obligation to incorporate such changes in any product previously manufactured.

All inquiries regarding this Warranty should be sent to:

JAYCO, INC.

903 South Main * P.O. Box 460 * Middlebury, IN 46540

WARRANTY REGISTRATION AND CUSTOMER DELIVERY FORM

Jayco, Inc.
P.O. Box 460
903 South Main Street
Middlebury, IN 46540
(574) 825-0608

Dealer is to assure that this form is properly completed and returned to Jayco within ten (10) working days after delivery.

OWNER'S NAME			DEALER'S NAME		
ADDRESS			ADDRESS		
CITY	STATE	ZIP CODE	CITY	STATE	ZIP CODE
DELIVERY DATE		PHONE NUMBER (DAYTIME)	ODOMETER READING (MUST BE COMPLETED FOR MOTORHOMES)		
JAYCO SERIAL NUMBER			CHASSIS VIN (VEHICLE I.D. NUMBER) (SEVENTEEN DIGITS REQUIRED)		

ALL ITEMS MUST BE MARKED OFF BY THE DEALER IN THE CUSTOMER'S PRESENCE INDICATING PERFORMANCE OR INSTRUCTION AS REQUIRED. PLEASE MARK EACH ITEM OK OR NA (NOT APPLICABLE).

1. ELECTRICAL SYSTEM

- 120-Volt System
- 120-Volt Auxiliary Generator Operation
- 12-Volt System
- Ground Fault Circuit Interrupter (GFCI)
- All Interior Lights/Recepts/Switches
- All Exterior Lights/Recepts/Switches
- Battery System
- Monitor Panel
- Slideout Operation and Maintenance
- Phone and Cable TV
- Audio/Video Entertainment System
- Converter Operation and Use
- Solar Panel
- Interior Fans - All

a. Motorized Only

- Inverter Operation and Use
- Driver Dash Controls/Switches
- Hydraulic Leveling Jacks
- Power Cord/Reel
- Backup Camera and Monitor

2. PROPANE SYSTEM

- Location and Maintenance of Propane Lines and Connections
- Maintenance and Operation of Regulator
- Propane Monometer Test (Check for leaks - repair if needed and retest) Set Pressure at _____ in. Water Column
- Outside Grill Use and Operation

3. WATER/PLUMBING SYSTEM

- Water Intake/Drain Lines
- Demand Pump
- Faucet(s)/Fixture(s)
- Winterizing/Bypass
- Outside Shower
- Shower

3. WATER/PLUMBING SYSTEM CONT.

- Black Holding Tank(s)
- Grey Holding Tank(s)
- Fresh Water Holding Tanks(s)
- Toilet

4. APPLIANCES

- Furnace and Thermostat
- Range/Oven/Hotplate
- Water Heater
- Refrigerator
- Air Conditioner
- Microwave
- Central Vacuum
- Heat Pump
- Washer/Dryer

5. INTERIOR

- Curtain/Drapes/Valances/Blinds
- Beds/Couches/Tables
- Fire Extinguisher (Check CHARGE ONLY)
- Interior Trim and Sealants
- Windows - Crank Mechanisms/Slides/etc.

6. EXTERIOR

- Doors and Locks - all keys
- Screen Door
- Entrance Step
- Finish - spot paint, touch up and rub out if necessary
- TV and/or Satellite Antenna Mechanism
- Vents - all
- Compartment Doors
- Trim and Sealants
- Awnings
- Bumper/A-Frame - touch up as needed
- Window and Roof Sealants

7. CHASSIS - MOTORIZED ONLY

- Check all Fluid Levels
- Chassis Prep as Recommended by the Manufacturer
- Tires - Condition and Pressure
- Wheel Lugs - as outlined in Chassis manual

8. RUNNING GEAR - TOWABLE ONLY

- Brake Adjustment and Maintenance
- Bearing Lubrication and Maintenance
- Brake Wire Connections
- Hydraulic Brake Fluid and Maintenance
- A-Frame/Coupler Operation
- Operate and Lube Jacks
- Tires - Condition and Pressure Set
- Tire Pressure _____ psi
- Wheel Lugs - (Tighten to specs for ft. lb. torque) Review Maintenance - tighten at 10,25,50 miles

9. FOLDING CAMPING TRAILER ONLY

- Complete Set Up and Closing
- Demonstration, Proper Leveling

10. GENERAL

- Wash Vehicle
- Be certain that all required literature is in the vehicle
- Be certain that all accessories including remotes are in the vehicle
- Be certain that all Owner's Manuals are in the vehicle
- Be certain that the Warranty Forms are completed

DEALER (If this is a dealer inspection, options are not covered under Jayco's limited warranties.)

OWNER/DEALER INSPECTOR

1. Exterior and interior finish.
2. Operate all appliances, optional equipment and accessories and discuss maintenance.
3. Review operation, maintenance and safety of Propane System.
4. Explain weight ratings, limitations and proper load distribution and maintenance.

5. Operate all fresh water and plumbing components including faucets, shower, toilet and drain locations.
 6. Review tow vehicle, hitch and sway control set-up - test drive. (towables only)
- Complete review of owner's manuals and highlight safety issues.

I HAVE COMPLETED THE ABOVE INSPECTION ON THIS FAMILY CAMPING VEHICLE AND HAVE TAKEN A TEST DRIVE AT THE TIME OF PURCHASE. I NOTED:

I RECEIVED A COPY OF THE JAYCO LIMITED WARRANTY BEFORE I PURCHASED THIS VEHICLE AND I UNDERSTAND THAT IT IS DESIGNED TO BE USED ONLY FOR RECREATIONAL CAMPING AND TRAVEL.

THE PURCHASER HAS INSPECTED OR BEEN GIVEN THE OPPORTUNITY TO INSPECT THE VEHICLE AND TAKE THE TEST DRIVE, SUPPLIED THE INFORMATION ABOUT HIS/HER NAME AND ADDRESS, BEEN GIVEN THE OPPORTUNITY TO MAKE NOTATIONS IN THE SPACE PROVIDED AND OBSERVED OR RECEIVED SATISFACTORY EXPLANATIONS ABOUT ALL ITEMS LISTED ABOVE.

DATE

PURCHASER'S SIGNATURE

DEALER'S SIGNATURE

LIMITED WARRANTY TRANSFER

The warranty on your unit is transferable one (1) time during the warranty period. This form as shown here and on the next page must be completed and sent to Jayco, Attention: After Market Services. If you have questions, consult with your independent, authorized dealer for assistance.



LIMITED WARRANTY TRANSFER APPLICATION

Mail original copy of Jayco, Inc. Limited Warranty Transfer Application to:

Jayco, Inc.
Warranty Dept.
P.O. Box 460
Middlebury, IN 46540

REQUIRED FIELD

Vehicle Identification Number _____

Transfer Coverage To:

A NEW OWNER INFORMATION

Last Name _____

First Name _____

Owner Address 1 _____

Owner Address 2 _____

Owner Address 3 _____

City _____

State _____

Zip _____

Phone Number _____

____/____/____ Date of Transfer _____ Odometer Reading at Transfer **MUST BE COMPLETED ON ALL MOTORIZED VEHICLES**

Transfer Coverage From:

B PRIOR OWNER INFORMATION

Last Name _____

First Name _____

C SELLING DEALER INFORMATION (IF APPLICABLE)

Dealership Name _____

Dealer Address 1 _____

Dealer Address 2 _____

Dealer Address 3 _____

City _____

State _____

Zip _____

Phone Number _____

PLEASE READ TERMS AND REPRESENTATIONS PRIOR TO SIGNING .

D ALL TITLED OWNER SIGNATURES

I HAVE READ AND AGREE TO THE TERMS AND CONDITIONS ON THE BACK OF THIS FORM.

New Owner's Signature _____

New Owner's Signature _____

New Owner's Signature _____

Selling Dealer's Signature _____

THE LIMITED WARRANTY MAY BE TRANSFERRED ONE (1) TIME DURING THE WARRANTY PERIOD WITH THIS APPLICATION.

TERMS AND REPRESENTATIONS

By my signature(s) on the face side of this form, and in order to induce Jayco, Inc. to transfer its Limited Warranty, I represent the following:

1. That I have received and read a copy of the Jayco Limited Warranty and Owner's Manual.
2. I understand that the unit is to be used only for recreational camping and travel.
3. That all information provided by me on the face side of this form is true and correct.
4. I understand that I am purchasing a pre-owned recreational vehicle and Jayco, Inc. does not make any representation as to its present condition.

SERVICE PROCEDURES

Basic Service Procedures

We are interested in your satisfaction. Only by having your complete confidence and satisfaction with our product and its service can we assure our continued success as manufacturers of recreation vehicles. We have found that continuing a pleasant and effective relationship through our independent, authorized dealers is equally as important as maintaining the technical excellence of our product. Your independent, authorized dealer will cordially assist you in providing service, maintenance, selection of options and instructions concerning the operation of your vehicle.

If you have a problem with your trailer that requires service, please follow these instructions in sequence.

1. **Contact your selling independent, authorized dealer's service department for an appointment.** Describe to the best of your knowledge the nature of the problem.
2. Contact the owner or General Manager of the independent, authorized dealership if the initial attempt fails with the service department.
3. If further assistance is needed, contact:

After Market Services

Jayco Incorporated

P.O. Box 460

Middlebury, IN 46540

Email: service@jayco.com

Business Hours: Monday – Friday 8:00 – 5:00 EST

Give all the above information as requested, along with the serial number of the unit in question and we will make every attempt to help you resolve your repair needs. **It is important that you contact your selling independent, authorized dealer before Jayco. In most cases, the independent, authorized dealer can provide the service you require.**

If you are traveling and are unable to locate an independent, authorized Jayco dealer, or an authorized dealer for the component part needing service, contact your selling independent, authorized dealer for assistance.

(N) NOTE: Service at a non-authorized Jayco dealer needs prior authorization. You will be asked to return any mechanical parts replaced before reimbursement consideration is made. Unauthorized or improper repairs may void Jayco's warranty and the warranty on the component part.

Please keep your owner's manual, your copy of the warranty registration form and any other related papers in your RV.

Please bear in mind that most problems arise from misunderstandings concerning warranty coverage and service. In most instances, you will be referred to the independent, authorized dealer level and your repair needs will be resolved at the independent, authorized dealer's facilities.

CALIFORNIA LEMON LAW NOTICE: If you have determined that your vehicle has nonconformities under the California Lemon Law, you must provide written notice of the claimed defects directly to Jayco in Middlebury,

Indiana at the address for warranty service, and permit Jayco to perform a final repair attempt.

Independent, Authorized Dealer

When you purchased your Jayco RV, we trust you had a pleasant experience. We consider the network of independent, authorized Jayco dealers to be some of the best in the RV business. This group of independent contractors is an integral part of Jayco's continued success.

Throughout this manual, we will refer you to your independent, authorized dealer for assistance with certain component parts or procedures. If you are traveling outside your independent, authorized dealer's area, you are never far from another independent, authorized Jayco dealer with over 300 dealerships in our network.

Your independent, authorized dealer has inspected and serviced your new Jayco RV. The independent, authorized Jayco dealers are available for service and maintenance to your camping trailer. All warranty repairs should be performed by an independent, authorized Jayco dealer unless Jayco gives prior approval.

Some RV dealers may be a service center for manufacturers of products warranted separately. To reduce delays, contact your independent, authorized dealer for service available through them. If your independent, authorized dealer is not a service center for the product or component part in question, they can assist you in finding service.

Parts

Parts are available at dealerships or your independent, authorized dealer can order parts for you as needed. **All retail parts inquiries should be routed through your independent, authorized dealer.**

Owner's Responsibility

As a new owner of a Jayco recreation vehicle, you are responsible for understanding how your trailer, and its various component parts, work and need to be maintained. You are also responsible for the regular and proper maintenance of your RV. This will help you prevent conditions arising from neglect that are not covered by your Jayco Limited Warranty.

Maintenance service should be performed in accordance with this owner's manual and any other applicable manuals.

As the owner, it is your responsibility and obligation to return the RV to an independent, authorized dealer for repairs and service. Reference your Jayco Limited Warranty for additional information. Because the dealer where you purchased your RV is responsible for its servicing before delivery and has an interest in your continued satisfaction, we recommend that inspection, warranty and maintenance services be performed by that independent, authorized dealership.

Manufacturer's Customer Support Directory

The following chart provides information to contact individual manufacturers of appliances/component parts that may be part of your trailer. The information listed in this chart is the latest available at the time of publication of this manual. If you have questions or concerns on component parts not listed here, contact your independent, authorized dealer for further assistance.

Component Part	Manufacturer	Website	Phone #
Attic Fan	Ventline	www.ventline.com	574-848-4491
Axle	Dexter Axle	www.dexteraxle.com	574-295-7888
Carbon Monoxide Detector	Quantum	www.qginc.com/index.html	800-432-5599
Converter	Elixir	www.elixirind.com/product.php?pid34	800-443-5473
Furnace	Hydro-Flame/Atwood	www.atwoodmobile.com	815-877-5700
Heated Bed Mats	Flair Interiors	www.flairinteriors.com	574-534-2163
Loading Ramps (Baja)	Highland	www.highlandusa.com	800-234-6992
Outside Grill	Vitco	www.vitco.com	877-736-2635
Outside Shower	B & B Molders	www.bandbmolders.com	574-259-7838
Propane Cylinder	Manchester Tank	www.manchestertank.com	800-877-8265
Propane Detector	MTI	www.mtiindustries.com	800-383-0269
Propane Regulator	Marshall Brass	www.marshallbrass.com/rv.htm	800-447-9513
Radio (Baja & Select Models)	Mito	www.mitocorp.com	800-433-6486
Range/Oven (Select Option)	Atwood	www.atwoodmobile.com	815-877-5700
Refrigerator	Norcold	www.norcold.com/norcold_home.cfm	800-543-1219
Roof Vent	Ventline	www.ventline.com	574-848-4491
Smoke Detector	MTI	www.mtiindustries.com	800-383-0269
Stove	Suburban	www.suburbanmanufacturing.com	423-775-2131
Thermostat	Coleman	www.rvcomfort.com/rvp/products/accessories/accessories.php	316-832-4357
Tires	Contact your local tire distributor for assistance		
Trailer Frame	Leland Engineering	www.lelandengineering.com	800-669-7681
Water Filter	Flowmatic	www.flowmatic.com	800-461-4406
Water Heater	Atwood	www.atwoodmobile.com	815-877-5700
Water Pump	Shur-Flo	www.shurflo.com	800-854-3218

SAFETY

SAFETY CONSIDERATIONS

The safe operation of your trailer requires that you use common sense and follow safety procedures as defined in this manual and all supplied information from specific component part manufacturers. In this manual, there are specific terms and symbols to indicate areas of potential hazards, which are based upon the ANSI Z535 series of safety information. Make sure you understand the use of these terms and symbols as defined here.

(N) NOTE provides additional information to make a step or procedure easier or clearer. Disregarding a NOTE could cause inconvenience, and would not be likely to cause damage or personal injury.

Caution used without the safety alert symbol indicates a potentially hazardous situation which, if not avoided, may result in property damage.

! - This is the safety alert symbol. It is used to alert you to potential personal injury hazards. Obey all safety messages that follow to avoid possible injury or death.

! CAUTION: Indicates a potentially hazardous situation which, if not avoided, could result in minor or moderate injury. It may also be used to alert against unsafe practices.

! WARNING: Indicates a potentially hazardous situation which, if not avoided, could result in death or serious injury.

! DANGER: Indicates an imminently hazardous situation which, if not avoided, will result in death or serious injury. This signal word is limited to the most extreme situations.

Reporting Safety Defects

If you believe that your vehicle has a defect, which could cause a crash, injury or death, immediately inform the appropriate agency, in addition to notifying Jayco, Inc. If similar complaints are received, the agency may open an investigation. If they find a safety defect exists in a group of vehicles, a recall and remedy campaign may be ordered. The agency cannot become involved in individual problems between you, your independent, authorized dealer or Jayco, Inc.

NHTSA	Transport Canada	Customer Relations Dept.
U.S. Department of Transportation	Road Safety (ASFAD)	Jayco Incorporated
Washington, D.C. 20590	2780 Sheffield Road Ottawa, Ontario K1B 3V9	P.O. Box 460, Middlebury, IN 46540
Phone: 1-800-424-9393	Fax (613) 993-3632	Email: service@jayco.com
Washington, D.C. Area: 368-0123	(613) 991-5802	Business Hours: 8:00-5:00 Mon.–Fri.

You can obtain other information about motor vehicle safety from the NHTSA Hotline.

Safety in Using Propane

We recommend that all work on the propane system be performed by your independent, authorized dealer. The following information is provided to give a basic understanding of propane.

Your recreation vehicle is equipped with a propane system to help provide some of the comforts of home. This system is very dangerous. Proper handling of propane, knowledge of your system and routine maintenance are key factors to your safety and that of others around you. The following list provides basic information for propane safety:

- Propane is heavier than air. Leaking propane tends to flow to and pocket in low areas, such as the trailer floor.
- Propane is colorless and odorless. A chemical odorant, smelling similar to rotten eggs, is added by the propane manufacturer to make sure leaks are identifiable, which can normally be smelled if there is a leak.
- Never light a match or allow any open flame in the presence of leaking propane or the smell of propane.
- Turn off propane while refueling the tow vehicle.
- Some states prohibit propane appliances to be operated during travel, especially in tunnels. Make sure you know the laws for the areas where you travel.
- Never allow propane containers to be filled above the liquid capacity as indicated on the container. If a container is overfilled, liquid propane may flow through the regulator causing it to freeze and/or create dangerously excessive pressure in the lines. Make sure that an overfilled container is taken care of by a propane professional before it is put into service.
- An overfilled container placed in sunlight may expel excess propane through the relief valve. This causes susceptibility to ignition by nearby open flame.

Taking time to become educated about propane and how it should be handled are critical to your camping experience. If you have questions, consult with your independent, authorized dealer or propane professional.

Checking for Leaks

Propane is both colorless and odorless. For your safety, a chemical agent is added by the propane manufacturer, which smells similar to rotten eggs. If you are not accustomed to the smell of propane, ask your independent, authorized dealer or propane service personnel to help you and your family become familiar with it.

Vibration from travel can cause connections to loosen. This requires that the propane system be checked periodically for leaks. The system has been tested by the manufacturer and Jayco recommends that the independent, authorized dealer test the system as well. However, continued maintenance is recommended for safe operation.

TO LEAK TEST THE PROPANE SYSTEM

- Use an appropriate propane detector solution, or create a soapy water solution. **If soapy water is used, make sure that the soap used does not contain ammonia or chlorine.**
- Apply the solution to all propane piping connections.
- If a leak is present, the soap will bubble at the connections.

 **WARNING: DO NOT USE A FLAME OR LIGHTED MATCH TO TEST FOR LEAKS.**

IF A LEAK IS DETECTED

- Turn off all appliances which utilize propane.
- Make sure that everyone is out of the RV, including pets.
- Turn off the propane at the cylinder(s).
- Take your RV to your independent, authorized dealer and have the system repaired before using it again.

 **WARNING: WE STRONGLY RECOMMEND THAT YOU HAVE A PROFESSIONAL TEST YOUR PROPANE SYSTEM FOR LEAKS ONE TIME EACH YEAR AS PART OF NORMAL MAINTENANCE.**

Carbon Monoxide Detector

Carbon monoxide (CO) is an odorless, colorless, tasteless propane that is extremely dangerous to humans and animals. The following symptoms are indicative of individuals exposed to carbon monoxide:

Symptoms of Carbon Monoxide Exposure		
Mild	Medium	Extreme
Headache	Fatigue (often described as “flu” like symptoms)	Unconsciousness
Running nose	Dizziness	Convulsions
Sore eyes	Drowsiness	Brain damage
Nausea	Confusion	Cardio respiratory failure
Vomiting	Fast heart rate	Death

 **DANGER: Any amount of exposure to CO is dangerous and must be taken care of before reentering the RV. If anyone develops symptoms as listed, make sure that everyone gets to an area of fresh air. Failure to do so could result in death or serious injury.**

A carbon monoxide detector has been installed in your RV. It is designed to detect the presence of CO. It is not designed to function as a detector or alarm for other gases such as propane, fire or smoke. Information has been supplied by the carbon monoxide detector manufacturer for operation, safety and maintenance. Make sure that you read, understand and follow all information supplied by the CO detector manufacturer with your RV.

Electrical System Safety

Circuit breakers and fuses are installed to protect electrical circuits from overloading. Do not make unauthorized changes to circuitry or add fixed appliances. If you wish to make changes, consult your independent, authorized dealer and they will assist you in obtaining a safe installation.

An approved power cord has been supplied with the vehicle. Always use this cord for hook-up to 120-volt shoreline power. The cord has a three pin plug, which provides proper grounding through the third (round) pin. Grounding is personal protection from electrical shock.



WARNING: Do not use an adapter, cheater, or extension cord that will break the continuity of the grounding circuit connected to the third pin. NEVER remove the grounding pin to connect a non-grounded, two-prong receptacle. Any deviation from this will potentially cause a fire from overheating.

Water System Safety

The following warning label is placed on the exterior of your trailer at each water tank inlet. Make sure you read, understand and follow this label and all applicable instructions.



WARNING: POTABLE WATER ONLY. SANITIZE, FLUSH AND DRAIN BEFORE USING. SEE INSTRUCTION MANUAL. FAILURE TO COMPLY COULD RESULT IN DEATH OR SERIOUS INJURY.

Fire Extinguisher

A fire extinguisher is installed in each vehicle and is located near the entrance door in the trailer. Be familiar with its location, operating instructions as printed on the extinguisher and any material from the extinguisher supplier or manufacturer. It is too late to become familiar with an extinguisher when an emergency is at hand.

The fire extinguisher is a dry chemical, nonrefillable extinguisher. Do not test this extinguisher by partially discharging. Doing so will cause loss of pressure making the extinguisher unusable. The extinguisher must be discarded and replaced by a new one if any use has occurred.

INSPECTION AND MAINTENANCE

To insure that your fire extinguisher will be ready when needed:

- Read and follow all instructions on label and in owner's manual.
- Inspect the extinguisher AT LEAST once a month - more frequently if exposed to weather or possible tampering.
- Check pressure by pressing in white indicator button. If button does not spring back, extinguisher will not work properly and must be discarded.
- Be sure the yellow lock pin is firmly in place.
- Keep the extinguisher clean. Check for dents, scratches, corrosion or any other damage.
- Check the discharge nozzle. Make sure it is clean and free of obstructions.

 **CAUTION:** Under certain fire and heat conditions, the dry chemical powder in this extinguisher (and similar units) will cause damage or prove extremely difficult to remove from oven surfaces, including self-cleaning models. Do not use self-cleaning feature to remove ABC Powder.

 **CAUTION:** Avoid inhaling the dry chemical agent contained in the extinguisher. It is not toxic, but may cause skin irritation. In case of contact, flush affected area with clean, cool water. If irritation persists, contact a physician immediately. Chemical name of agent is printed on extinguisher label.

Changes, Modifications and Additions

Your RV has been built/designed with a specific floor plan and equipment. It is recommended that you do not make changes, modifications, alterations or additions to your unit. If any changes or additions are made after delivery of your trailer to you, it may cause a hazardous condition. Consult your independent, authorized dealer before making any changes, modifications, alterations or additions. Only qualified technicians should attempt to make changes or additions to the RV, using only approved materials, component parts, and employing approved methods of installation, which meet safety and code requirements.

 **CAUTION:** Any installation not properly performed, or that does not meet the criteria of the manufacturer's specification or code requirements, may damage the RV, including component parts and **VOIDS THE WARRANTY** on the RV.

 **WARNING:** Improper installation of equipment to your trailer creates potential for a hazardous situation and personal injury. Make sure that a qualified RV technician performs modifications if you choose to make them.

Safety When Emergency Stopping

Pull off the roadway as far as possible for emergency situations and turn on the tow vehicle's warning flashers. If necessary, display your road flags and/or reflective triangles.

 **NOTE:** Always carry road flags and/or reflective triangles to be displayed when necessary.

Additional Safety Considerations



WARNING: For traveling safety, it is extremely important to read, understand and follow the towing, hitching and loading cargo information provided in the “Before You Travel...” chapter. If you do not understand the information provided, please consult your independent, authorized dealer.

- Sanitize the fresh water supply system periodically (see sanitizing instructions).
- Prevent water connections from coming in contact with the ground or drain hose to reduce chance of contamination.
- Have a certified RV technician repair and maintain the propane or electrical appliances.
- Always have a serviceable fire extinguisher placed in an easily accessible location.
- Carefully read the loading section in the “Before You Travel...” chapter related to your trailer.
- Ensure that the tires are in good condition and properly inflated. Monitor the tire pressure closely for proper inflation. Neglecting to do so could result in overheating of a tire, which could result in a blowout.
- Check and tighten the wheel lugs after the first 10 miles, 25 miles and then again after 50 miles (16, 40 and 80 kilometers). Check periodically as described in the axle manufacturer’s owner’s manual thereafter.
- Check the brakes in a safe area - not while traveling on a busy highway.
- Always block the trailer wheels solidly before unhitching from the tow vehicle.
- Never move the unit while people are inside.
- Before leaving a camping area towing a trailer, refer to the “Preparing to Travel Home...” chapter and review all applicable instructions.
- Observe the warning labels attached to your vehicle concerning propane, water, electricity and loading.
- Observe the maintenance chart in this manual and all applicable information supplied by component part manufacturers related to your respective unit.

COLD WEATHER/EXTENDED USE

Your trailer has been built for enjoyment in a recreational manner. It is not intended to be used as full-time living quarters.

Caution: *Continuous living in your trailer could cause accelerated wear and damage to component parts. It also voids the warranty.*

- Use of this trailer during cold weather will require more protection. Using skirting or insulation below floor level will provide additional protection if you are camped in one area for an extended period.
- Proper care should be taken with the fresh water and drainage systems to avoid freezing problems. Consult with your independent, authorized dealer or RV supply house for advice on heat tapes, etc.

- Adequate propane and electrical supply is needed along with protection from possible freeze-ups on the propane regulator. The furnace will substantially increase battery draw and propane use.
- During cool weather usage, ventilation or the addition of a dehumidifier may be required to reduce condensation. See the next section for important information on controlling condensation.

CONDENSATION

Condensation is a natural phenomenon. The amount of condensation will vary with the climate conditions, particularly the relative humidity. Condensation occurs because there is water vapor present in the air, which is added by breathing, bathing and cooking. The water vapor collects where there is available air space, and when the temperature reaches the 'dew point' the water vapor in the air condenses and changes to liquid form. Most people have experienced a similar phenomenon when moisture forms on kitchen windows and bathroom mirrors during cool weather.

Proper ventilation and, if needed, the use of a dehumidifier will assist in controlling the condensation. Many RV and marine dealers carry small dehumidifiers especially sized for recreation use. Condensation causes dampness, mildew, staining and if allowed to continue at high levels, damage to the paneling and wood structures. It is the owner's responsibility to make sure that condensation is properly removed from the air.

INSURANCE

As with your automobile, it is important that you protect yourself and others with insurance coverages for personal liability, theft, collision, property damage, etc. Your independent, authorized dealer can assist you in obtaining appropriate insurance for your protection or you may check with the company which provides your automobile insurance or other insurance companies.

BEFORE YOU TRAVEL...

WEIGHTS AND CARGO CAPACITY

The safety of your travel will be affected by your understanding of weights and cargo distribution for your trailer. Read, understand and follow all information related to the weight of your trailer. We provide the following labels on your trailer (copies are printed here):

- The “Federal Certification” label (Fig. 1) is affixed to the roadside front corner of your trailer. It lists the vehicle weights as well as the tire and axle rating information.
- The “Trailer Weight Information” label (Fig. 2) is typically located inside a lower cabinet close to the entrance door. This label is critical in understanding trailer weight definitions. Please read, understand and follow all of these definitions. In addition to the label information, the GAWR is the maximum weight rating that component parts of each axle are designed to support (i.e. tires, brakes, springs, axle). Information that seems unclear should be discussed with your independent, authorized dealer.

The weights of your unit are the model’s dry weights with standard equipment. **It is critical that you do not exceed the gross vehicle weight rating (GVWR) of your trailer.** As you begin to load your personal cargo, remember that what you load as well as options that have been added will affect the overall weight. **Never exceed the gross vehicle weight rating of your unit.**

MANUFACTURED BY: FABRIQUÉ PAR:		JAYCO, INC.		DATE _____	
INC. VEHICLE MFG. BY: VÉHICULE FABRIQUÉ PAR:		_____		_____	
GVWR/PNBV: KG		V.I.N./N.I.V.		PRESS./COLD INFL. PRESS. DE GONFL. À FROID	
_____		_____		_____	
GAWR/PNBE: KG		SIZE/DIMENSION		PSI/LPC KPA	
_____		TIRE/PNEU RIMS/JANTE		_____	
_____		_____		_____	
_____		_____		_____	
FRONT/DEVANT		_____		_____	
INT./CENTRAL		_____		_____	
REAR/ARRIÈRE		_____		_____	
TYPE OF VEHICLE/TYPE DE VÉHICULE: TAILER / CARAVANE MULTIPURPOSE PASSENGER VEHICLE/VÉHICULE DE TOURISME À USAGES MULTIPLES					
THIS VEHICLE CONFORMS TO ALL APPLICABLE U.S. FEDERAL MOTOR VEHICLE SAFETY STANDARDS AND STANDARDS PRESCRIBED UNDER THE CANADIAN MOTOR VEHICLE SAFETY REGULATIONS EFFECT ON THE DATE OF MANUFACTURE SHOWN ABOVE.			CE VÉHICULE CONFORME À TOUTES LES NORMES QUI LUI SONT APPLICABLES EN VERTU DU RÈGLEMENT SUR LA SECURITÉ DES VÉHICULES AUTOMOBILE DU CANADA EN VIGUER À LA DATE SA FABRICATION CI-DESSUS.		

Fig. 1

TRAILER WEIGHT INFORMATION	
VIN or SERIAL NUMBER _____	_____
MODEL _____	_____
<p><u>GVWR</u> (Gross Vehicle Weight Rating) is the maximum permissible weight of this trailer when separated from the tow vehicle.</p> <p><u>UVW</u> (Unloaded Vehicle Weight) is the total weight of this trailer as manufactured at the factory when separated from the tow vehicle. If applicable, it includes full generator fuel, engine oil, and coolants.</p> <p><u>CCC</u> (Cargo Carrying Capacity) is equal to GVWR minus each of the following: UVW, full fresh (potable) water weight (including the water heater), full propane weight.</p> <p><u>GCWR</u> (Gross Combination Weight Rating) means the value specified by the trailer manufacturer as the maximum allowable weight of this trailer with its towed trailer or towed vehicle.</p> <p>**The GCWR of this trailer is:</p>	
CARGO CARRYING CAPACITY (CCC) COMPUTATION	
	Pounds / Kilograms (kg.)
GVWR.....
Minus UVW.....
Minus fresh water weight of _____ gallons @ 8.33 Lbs./gal.
Minus propane weight of _____ gallons @ 4.24 Lbs./gal.
CCC for this trailer*.....
*Dealer installed equipment will reduce the CCC.	
**This trailer is not recommended or intended to be used to tow any other vehicle or trailer.	
CONSULT OWNER MANUAL(S) FOR SPECIFIC WEIGHING INSTRUCTIONS AND TOWING GUIDELINES.	

Fig. 2



WARNING: Do not add accessories or component parts that are not safe and appropriate for this product. These changes will effect weight specifications, void the warranty and adversely effect handling and stability of the unit, as well as accelerate wear to other component parts. Jayco, Inc. DOES NOT provide warranty coverage for equipment installed by the independent, authorized dealer or owner.



WARNING: Do not exceed your GVWR. Your recreation vehicle's load capacity is designed by weight, not by volume. You can not necessarily use all available space when loading the vehicle.

LOADING CARGO

After you have read and understood the overall weight definitions and limits to your trailer, you are ready to load it for travel. With the excitement of awaiting adventures, everyone will want to take along everything they might possibly need. This is where careful planning and preparation will help to insure a safe trip. As you develop a routine for loading your cargo, it may be helpful to utilize checklists and other resources. You will find a list of items which are often used at campsites at the end of this chapter. This list will give you a place to start when preparing your trailer for travel. Keep in mind that your preferences and specific camping situation will determine items you would eliminate or add to this list.

Of most importance, above personal preferences, is the overall amount of cargo packed and the way it is placed in the trailer. As cargo is placed in the unit, pay particular attention to where you place it. Follow these rules of thumb:

- Observe ALL capacity ratings to avoid problems and make sure that you never load your trailer or tow vehicle in a manner that cause them to exceed the GVWR, GCWR, GAWR (of any axle) or weight ratings of an individual tire.
- Heaviest items must be stored in lower cabinets and storage areas.
- Keep the majority of the cargo weight over the axles and toward the front of the unit.
- Maintain the proper tongue weight of the trailer. Stay within the target range of 10-15% of the overall gross weight (trailer weight plus contents).
- Always pack items evenly from side to side to maintain trailer balance.
- Make sure that all items are secured in place to prevent shifting during travel.



WARNING: Ensure you are loading the unit as evenly as you can for the best possible handling. All items must be secured to avoid shifting during travel.

Rear Bumper



CAUTION: Do not add items to the trailer's rear bumper. Attachments to the bumper could damage the trailer and lead to adverse driving and towing conditions.

Your trailer's rear bumper is not designed to accommodate items attached to or carried on it. Damage from improper modifications to the trailer is not covered by the Jayco Limited Warranty.

Front Deck (Baja Trailers Only)

Your trailer is equipped with a front deck for hauling extra cargo. Make sure that you stay within all weight limits for the deck and the loading ramps, as supplied with your trailer, when utilizing this deck. It is critical for proper handling and trailer maintenance that you weigh your trailer completely loaded before heading out on your trip. Refer to the instructions provided in this manual for weighing your trailer.

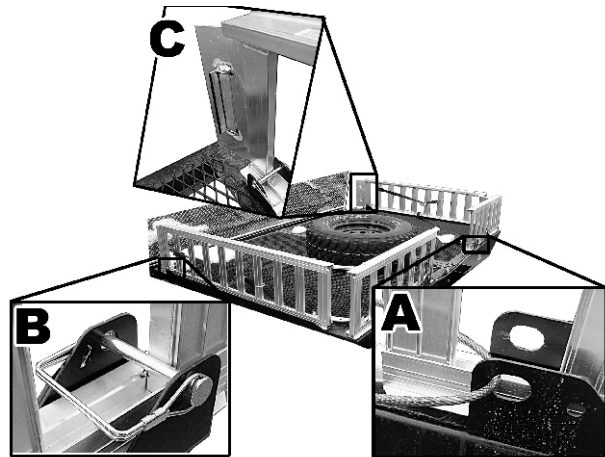

Fig. 3

LOADING RAMPS

Your Baja trailer is equipped with aluminum folding ramps to load equipment onto the trailer's front deck. These ramps are secured to the front deck to create a railing during travel.

1. Unlock the padlock securing the cable at the front edge of the front deck. Remove the cable (Fig. 3A) from the ramps and the front deck and place it with the lock in a storage area.
2. Remove the two snap pins (Fig. 3B) securing the other end of the ramps to the front deck. Place these in the storage area along with the cable and lock.
3. Remove one ramp from the front deck and place it on the edge you will be using to load the front deck. Make sure that the angle (Fig. 3C) is securely in place for loading. Repeat for the other ramp.
4. Refer to instructions provided by the ramp manufacturer with your trailer for proper set up and use instructions for the ramps. Read, understand and follow all information supplied by the ramp manufacturer. If you have further questions, consult with your independent, authorized dealer and/or visit the ramp manufacturer's website at www.highlandusa.com.
5. When you have loaded your equipment onto the front deck for travel, make sure that you reverse the above procedures and secure the ramps for travel.



WARNING: It is important that you secure the loading ramps and any equipment on the front deck before travel. Failure to properly secure items to the front deck could lead to property damage and personal injury.

Roof

Additional items secured to the roof of your trailer must be added into the over all trailer weight. The load capacity of the roof must not be exceeded when loading the trailer. The maximum weight of equipment secured to the roof of your trailer (in the travel mode) must not exceed 350#.

It is your responsibility to be aware of the weight of items or equipment that may have been added to your trailer after leaving the factory. Added equipment will reduce the available cargo capacity of your trailer. The maximum weight that the roof can lift is 250#. This maximum includes all attached equipment, such as bike rack, canopy, air conditioner, boat rack, etc. The following list provides approximate empty weights for Jayco provided brands. If you purchase other brands, obtain their weights from their literature or sales people.

Equipment	Pounds	Kilograms
Canopy	23-28	11-18
Bike Rack	22	10
Boat Rack	19	9
Additional Bike Kits	7	3
13,500 BTU Air Conditioner	Average 100	45

Never mount a storage pod directly to the roof. It is necessary to provide a rack system which secures to the outer edges of the roof to support and evenly distribute the weight of the storage pod. Consult with your independent, authorized dealer for proper installation.

Never walk on the roof. The roof of a folding camping trailer is not designed to accommodate the weight, scratches, dents and punctures that can occur from walking on the roof.



CAUTION: Never attempt to raise the roof with cargo secured to it.

HOLDING TANK(S) AND TRAILER WEIGHT



WARNING: We recommend that you DO NOT travel with waste in your holding tanks. With one or more full or nearly full holding tank(s), the towing characteristics of your trailer could change and may result in property damage or personal injury.

The weight of holding tank contents are not calculated into the cargo carrying capacity of the trailer. The extra weight will diminish the cargo capacity available to you. Traveling with full holding tank(s) could possibly causing you to exceed the gross axle weight rating(s), individual tire ratings and/or the gross vehicle weight rating (GVWR) of the unit. Potential damage to suspension components, such as springs, tires and axles, could result.

If your trailer's holding tank(s) are located behind the axles, the weight of the full tank(s) will reduce the hitch weight. Trailer sway and other handling difficulties can be the result of the hitch weight being too light.

If you are dry camping and cannot immediately empty the tank(s), use caution when towing. Maintain lower speeds for better control of the trailer until you reach the nearest dumping station.

WEIGHING INSTRUCTIONS

As your packing and loading routine becomes more familiar from experience, physically weighing your trailer may not be necessary before each trip. While you are developing a process, it is imperative that you verify compliance within the weight ratings. Overloading your RV voids the Jayco limited, express warranty and the warranties of many component part manufacturers. The following process will aid with weighing your trailer. Keep in mind that individual scales will operate differently. The surroundings of the scale need to be adequate to accommodate weighing each side of your trailer. Please read through all weighing instructions before you begin. If you have further questions, consult with your independent, authorized dealer or the scale operator.

Your recreation vehicle must be weighed fully loaded, that is, with food, clothing, fuel, water, propane, supplies, etc.

TO PROPERLY WEIGH YOUR RECREATION VEHICLE

1. First, weigh the recreation vehicle including the tongue weight, while detached from the tow vehicle. This actual overall weight must be less than or equal to the GVWR for safe operation. If the overall weight is greater than the GVWR, some contents must be removed until the actual overall weight is less than or equal to GVWR.
2. Next, hitch the recreation vehicle to your tow vehicle. Weigh the recreation vehicle and the tow vehicle to determine the GCW. Make sure that this rating is less than or equal to the GCWR as specified by the manufacturer of your tow vehicle. If this overall weight is greater than the GCWR, some contents must be removed to bring the combination into compliance with the listed ratings.
3. Next, weigh the recreation vehicle, while attached, but excluding the tow vehicle. This will result in the actual weight that is exerted on all of the recreation vehicle tires. This weight may be subtracted from the overall recreation vehicle weight GVWR to determine the actual "tongue" weight.
4. Next, with the recreation vehicle still attached to the tow vehicle, each wheel position should then be weighed separately to ensure each tire is not overloaded.

To Determine the Wheel Position Weight

- Pull the recreation vehicle onto the scale so only one tire is on the scale. Record the weight. Your trailer must remain as level as possible on the scale (even though an axle or side is not physically on the scale). Obviously, to obtain the side-to-side weights, there must be enough space on either side of the scale to accommodate the recreation vehicle being partially off the scale.
- To calculate the opposite side of the vehicle wheel position weight, subtract the first side's weight from the weight determined in step #3.

If there is a difference in the weights on one side of the vehicle as compared to weights on the other side, components (tires, wheels, brakes, springs, etc.) on the heavier side could be overloaded, even though the total axle load is within the GAWR. It is important to redistribute the load to avoid component failure, to improve the handling characteristics of the vehicle and to not void the warranty.

With these actual weights, it is now possible to compare them against the GAWR, GVWR and tire capacities.

EQUIPMENT

The compatibility of your tow vehicle to the load you are towing is of utmost priority for safety during your travel. There are many resources available to become educated about tow vehicles and what you will need. Make sure that you understand what it will take to tow your trailer, and that your tow vehicle matches those needs. If you are unsure of your particular needs, consult with your independent, authorized dealer or hitch professionals for assistance.

The following sections are designed as review topics that you need to understand for a safe and enjoyable traveling experience. They are not intended as a replacement for consulting your independent, authorized dealer and hitch professionals.

Tow Vehicle

- Crucial to finding the correct tow vehicle, is knowing the actual load weight you are towing. Refer to the sections found later in this chapter for this calculation on your trailer.
- When purchasing a tow vehicle, know its tow rating. As a minimum requirement, the gross vehicle weight rating (GVWR) of your trailer must not exceed your tow vehicle's rated towing capacity. To obtain this information, consult the following resources:
 - › Tow vehicle owner's manual
 - › Manufacturer's towing guide
 - › Auto Dealer
 - › Manufacturer's information office
 - › Reliable Internet Source
- Know what the definition is for the tow rating. Adding after market accessories, camping supplies, liquids (i.e. water, propane, etc.) and people will affect the tow rating. Read, understand and follow all trailer weight definitions.
- The best way to make sure your tow vehicle/trailer combination does not exceed the GCWR is to weigh it fully loaded.
- Some vehicles can be purchased with a towing package. This will enhance the vehicles towing capacity. Make sure that any information given on the vehicle's maximum towing capacity is clarified to be with or without the towing package.
- Towing packages are available at different levels. Vehicles can be purchased with no, light or heavy duty towing packages. Make sure you are purchasing a towing package that will fit your needs and your camper.
- Most vehicles require additional equipment for towing. Consult with your independent, authorized dealer for assistance with added requirements. Becoming familiar with the extra engine requirements from towing will provide you with vehicle longevity and a more pleasant towing experience.
- Make sure your tow vehicle is mechanically sound for towing your trailer. Pay particular attention to suspension components, tires and tire pressure.



WARNING: Be prepared to drive slower. If you must pass, do so with the utmost care, particularly in strong winds. When being passed or passing semi-trailers or large buses, be prepared for displaced air, as it can be severe enough to cause trailer sway. Understand how trailer brakes, tow vehicle brakes, acceleration, the proper hitch and sway

controls can affect your control of the trailer when you experience trailer sway.

Hitches



CAUTION:

- **Using an oversized or undersized hitch can cause damage to the frame of your trailer.**
- **Jayco, Inc. cannot be responsible for the suspension system of the tow vehicle.**
- **The final ball height after the trailer is completely hooked up is a factor to be considered when towing a trailer. It is important that your trailer be level when hitched to your tow vehicle.**
- **To avoid overloading your trailer axles and maximize possible handling difficulties, your trailer should be level when hooked to your tow vehicle.**
- **Do not overload your tow vehicle.**

There are many kinds of hitches available for various uses and assuring that you have the correct hitch installed is critical to a safe towing experience. Your trailer requires a frame mounted hitch. This type of hitch is assigned a class number, by the manufacturer. The class is based on the capacity the hitch has for towing and a weight classification. The weight classification is determined from the hitch's weight carrying capacity, which is also known as the tongue weight. Before selecting a hitch, you must know the total towed weight (trailer weight and all contents of the trailer) and the tongue weight of the trailer. The rating of the hitch package should be equal to or greater than the trailer's GVWR and the hitch weight.

Equipment that sometimes gives autos, trucks and sport utility vehicles a softer ride can accentuate swaying when pulling a trailer. Conversely, suspension that is too stiff will increase vibration, bounce and accelerate wear of your tow vehicle and trailer. It is important that your trailer be level when hitched to your tow vehicle. Educate yourself to protect you, your family and other motorists.

WEIGHT DISTRIBUTING SYSTEM

A weight distributing hitch system provides a more stable tow vehicle/trailer combination. This system will spread the weight evenly to distribute it to the tow vehicle front and rear axles and the trailer axle. Consult with your tow vehicle dealer and or hitch installer to familiarize yourself with the operation and requirements of the weight distributing hitch system.

SWAY CONTROL

Sway can be a major factor while traveling. It can be caused by a number of factors, including gusty wind, air displacement while passing a semi-truck, incorrect weight distribution and often excessive speed. The use of a sway control device will help to control the side-to-side movement and keep sway in check.

Suggestions for sway situations:

- Slowly ease your foot off the accelerator.

Before you travel...

- Turn the steering wheel as little as possible. Natural lag time reaction when counter-steering to correct sway could possibly make it worse.
- If the trailer is equipped with electric brakes, using the hand control will help to keep the vehicles aligned.
- As soon as possible, stop to determine the cause of the sway. Check all equipment and load distribution.
- If the problem can not be solved immediately, take the equipment to a service center. Travel at a reduced speed on your way there.



WARNING: A sway control device should be used with your tow vehicle/trailer combination. Consult with a trained hitch installer to obtain the proper equipment for your needs.

Hitch Height and Hitch Ball Specifications

To determine the hitch height for your model, make sure that the trailer is level. Measure from inside the hitch coupler to the ground. Record this number in the box at the side for future reference. If you have additional questions, consult with your independent, authorized dealer.

This unit hitch height is:

Jayco, Inc. cannot be responsible for the suspension system of any tow vehicle. There are a variety of suspension systems available on tow vehicles today which will affect the ball height, stability and levelness of the RV when hooked to the vehicle. Make certain your independent, authorized dealer is aware of the type of tow vehicle that will be used so a compatible hookup can be achieved.

Your trailer's hitch ball size is 2".

The Hitching Procedure

Hooking up a camping trailer is not difficult and will become easier with practice. The following procedure will help you until you become more experienced.

1. Make sure the trailer wheels are blocked.
2. Turn the jack crank to raise the trailer tongue above the hitch ball.
3. Open the coupler latch on the trailer hitch.
4. Back the tow vehicle into the proper position.
5. Turn the jack crank to lower the coupler onto the hitch ball.
6. Close the coupler latch after it is completely seated.
7. Install the weight distributing bars (equalizers) as per recommendations from the hitch supplier, when required.
8. Remove the dolly wheel or platform and retract the tongue jack to its maximum height.
9. Attach the breakaway switch cable to the tow vehicle.
10. Attach the safety chains as shown in Fig. 4.
11. Plug in the seven (7) pin connector from the tow vehicle to trailer.
12. Remove the trailer wheel blocks.

Refer to the complete list of suggested items in this manual for pre-trip planning and departing from camp for additional items to complete before traveling.

The Safety Chain

There are different safety chain requirements determined by the various state laws. Your vehicle is equipped with chains to meet SAE standard requirements for maximum gross trailer weight. Always have the safety chains attached when towing. Install them as shown below (Fig. 4) so they do not restrict sharp turns, but tight enough so they do not drag on the ground.

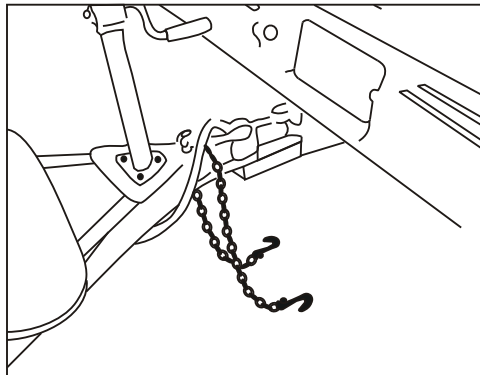

1. Inspect chains to determine if they are properly attached to trailer frame.

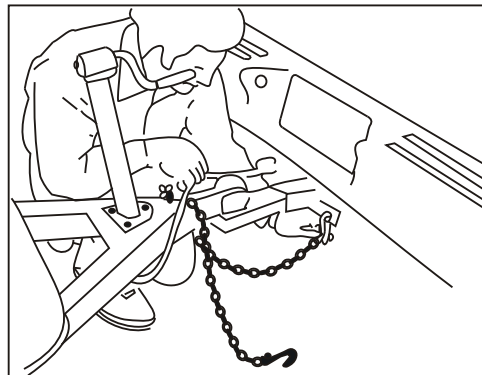

2. Criss-cross left chain and attach to right mounting slot in tow vehicle hitch.

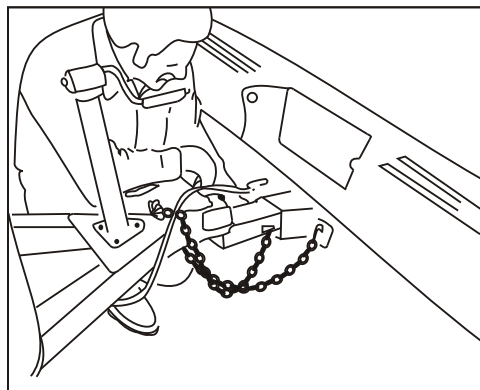

3. Repeat step 2 with right chain. Slack for each length should be the same but not more than necessary to permit the vehicle to turn at their minimum radius.

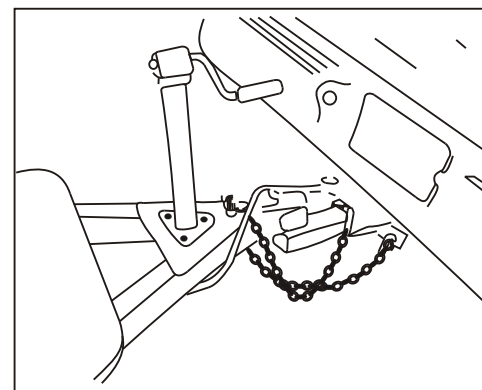

4. Properly mounted safety chains. Note that the jack is fully raised and dolly wheel removed.

Fig. 4



WARNING: It is critical to read, understand and follow all instructions for hitching and towing your trailer. Improper hitching creates the potential for trailer sway, towing difficulties and the possibility of the trailer becoming unhitched from the tow vehicle. Failure to properly hitch the trailer could lead to property damage, personal injury and death.

TOWING

While towing your trailer, you need to be aware of the extra weight behind your vehicle. The following list contains some pointers to remember while traveling, but is not a substitute for consulting with your independent, authorized dealer and hitch professionals.

- With the trailer attached, you will have slower acceleration and require greater distance to stop.
- Make sure you have enough area at corners when turning. Wider turns are necessary. Use your turn signals for your own safety.
- When passing or changing lanes, take into consideration the overall length of your trailer and allow ample distance and time. **DO NOT SPEED AND BE PREPARED FOR DISPLACED AIR WHEN PASSING OR BEING PASSED BY LARGE TRUCKS.**
- Use your rearview mirrors frequently to observe your vehicle, trailer and traffic conditions.
- When being passed by a large truck or bus, be prepared for displaced air as it may cause you to sway slightly. Steer straight and use your trailer brakes, if necessary, to slow slightly or control the sway of the trailer.
- Upon climbing steep, long grades and again descending, use lower gears even before it seems necessary. Use your brakes smoothly and evenly.
- Decrease your speed for safety! Most states require vehicles pulling trailers to maintain slower speeds, usually the same as truck traffic.
- Drive slowly during wet or icy conditions to ensure better control of your vehicle.
- Check all exterior lights before and during each trip.
- Obey traffic laws, allow extra time for stopping and decrease speed when visibility is limited or roads are wet.
- Have a safe and wonderful trip!

If towing a trailer is new for you, please take time to practice towing, parking and backing skills prior to traveling. Your independent, authorized dealer can answer many of your questions, but nothing replaces practice. We recommend that you find a large and quiet parking lot to practice your skills.

Towing Behind Your Trailer

DO NOT tow anything behind your RV. The RV frame and bumper are NOT designed for towing.



WARNING: Towing items behind your trailer, or overloading the rear, will void the warranty and result in:

- **Damage to the trailer or add-on items.**
- **Towing difficulties.**
- **Property damage.**
- **Personal injury.**

TIRES

The tires on your RV are specially constructed for the unique requirements of recreation vehicle travel. They are tested under Department of Transportation (D.O.T.) standards at the allowed highway speed limits. Proper care and maintenance of your tires is essential to ensure your safety, as well as the safety of others, as you travel. Taking time to become educated on the special qualities of RV tires and care they require will enhance your travel enjoyment. Refer to tire information supplied with your units literature.

Some guidelines to follow for routine tire maintenance include:

- Always follow the recommended tire pressure which is stamped on the tire sidewall. Keep the air pressure at the recommended psi. You must follow the manufacturer's inflation guidelines for maximum load capacity. Underinflation is just as dangerous as overinflation.

 **NOTE:** Tires are warranted by the tire manufacturer and are to be serviced and warranted by an appropriate service center. They are not to be returned to the independent, authorized dealer or trailer manufacturer.

- Always check the tire pressure when they are cold. As tires are in motion, the temperature will rise. This will cause the air pressure to increase. DO NOT release air pressure as tires become hot.
- Check the tire pressure and condition of the tires every day while traveling. Make sure to look for cracking, bulging, uneven tread wear, etc. If you are parked for an extended period, check the tire pressure at least once a week.
- Examine your tires frequently for unusual wear. Alignment, balance and bearing wear will effect tire wear.



WARNING: It is recommended that the tire pressure be checked at the beginning of each journey to obtain the maximum life of the tire. Follow the instructions listed on the certification label, affixed to the roadside front corner of your trailer, to determine the correct tire pressure. Underinflation may cause tire failures and swaying. This will result in loss of control, injury, death or property damage.

- If a tire needs to be replaced, make sure it is the same size and load capacity as those originally supplied with your trailer. Refer to the unit's Federal Certification Label for the proper tire size and load range. If you have further questions, consult with your independent, authorized dealer or local tire store.



WARNING: Be sure to use only tires that are rated for trailer use. The use of passenger tires should be avoided. The load rating/ range embossed on the sidewall of passenger tires must be de-rated accordingly they do not have the same load capability as tires that are specifically identified for trailer use. Failure to use tires that are properly matched to your recreation vehicle could lead to premature tire wear or less than optimum trailer handling.

WHEEL LUGS



WARNING: Wheel lug nuts must be applied and maintained at the proper torque levels to prevent loose wheels, broken studs, and possible separation of the wheel(s) from your trailer. The lug nuts on the wheels of your Jayco trailer must be maintained according to the torque values listed in the chart on the following page. Over torquing and/or under torquing wheels may result in component failure.

After your first trip, check the wheel lugs periodically for safety. Check the wheel lugs after winter storage, before starting a trip or following extensive braking. The proper procedure and sequence for attaching the wheels and torquing lug nuts is as follows.

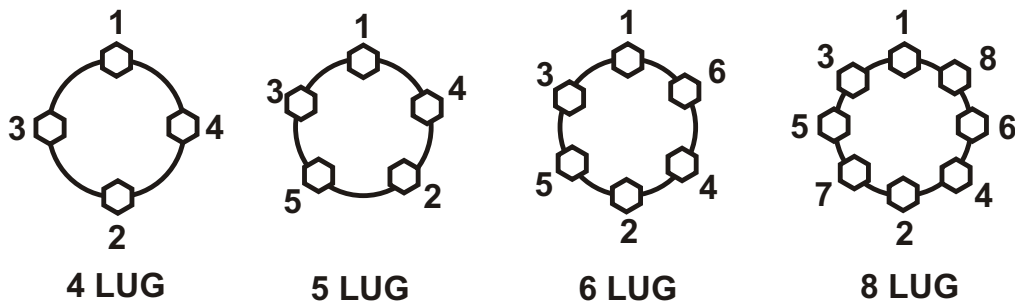

Fig. 5

1. Start all nuts by hand to prevent cross threading.
2. Tighten the nuts in the sequence shown in Fig. 5.
3. Tighten the lug nuts equally in stages as indicated for your trailer's wheels in the chart.
4. Torque the wheel lug nuts before the first road use and after each wheel removal. Check and re-torque after the first 10, 25 and 50 miles (16, 40 and 80 kilometers). Thereafter, check and maintain the torque as defined in the chart on the following page.



WARNING: Failure to maintain proper torque of the wheel lug nuts could lead to separation of the tire and wheel while driving, possibly resulting in property damage or personal injury.

Wheel Torque Requirements					
Lug Nut	Rim	Type	Stage 1	Stage2	Stage 3
4-Lug Nuts	12"	Steel	20-25 ft/lbs	35-40 ft/lbs	50-75 ft/lbs
5-Lug Nuts	13"	Steel	20-25 ft/lbs	35-40 ft/lbs	50-75 ft/lbs
5-Lug Nuts	13"	Chrome	20-25 ft/lbs	35-40 ft/lbs	50-75 ft/lbs
5-Lug Nuts	14"	Steel	20-25 ft/lbs	50-60 ft/lbs	90-120 ft/lbs
5-Lug Nuts	14"	Chrome	20-25 ft/lbs	50-60 ft/lbs	90-120 ft/lbs
5-Lug Nuts	14"	Aluminum	20-25 ft/lbs	50-60 ft/lbs	90-120 ft/lbs
5-Lug Nuts	15"	Chrome	20-25 ft/lbs	50-60 ft/lbs	90-120 ft/lbs
6-Lug Nuts	15"	Steel	20-25 ft/lbs	50-60 ft/lbs	90-120 ft/lbs
6-Lug Nuts	15"	Aluminum	20-25 ft/lbs	50-60 ft/lbs	90-120 ft/lbs
6-Lug Nuts	15"	Chrome	20-25 ft/lbs	50-60 ft/lbs	90-120 ft/lbs
6-Lug Nuts	16"	Steel	20-25 ft/lbs	50-60 ft/lbs	90-120 ft/lbs
6-Lug Nuts	16"	Chrome	20-25 ft/lbs	50-60 ft/lbs	90-120 ft/lbs
8-Lug Nuts	16"	Steel	20-25 ft/lbs	70-80 ft/lbs	110-130 ft/lbs
8-Lug Nuts	16"	Aluminum	20-25 ft/lbs	70-80 ft/lbs	110-130 ft/lbs

A torque wrench is the best way to assure the proper amount of torque is being applied. Also review the axle manufacturer's operation and service manual supplied with your trailer or contact your independent, authorized dealer for further assistance.

ELECTRIC BRAKES

Your trailer's electric brakes are designed to work with your tow vehicle's hydraulic brakes. To maintain proper braking performance, both trailer and tow vehicle brakes must be used together. Separate use of the systems will cause accelerated wear and damage.

WHEN YOUR TRAILER IS NEW, IT IS IMPOSSIBLE TO ADJUST YOUR BRAKE SHOES PRECISELY. IT TAKES APPROXIMATELY 1,000 MILES AND/OR 50 MEDIUM TO HEAVY STOPS TO "BURNISH" FIT OR "SEAT" THE SHOES TO THE BRAKE DRUM. AFTER THE INITIAL BREAK IN PERIOD YOUR SHOES MUST BE ADJUSTED ACCURATELY FOR BEST PERFORMANCE AND INCREASED DURABILITY.

Braking system components include:

- Tow vehicle battery
- Brake controller
- Wire harness/connector plug
- Trailer battery
- Breakaway switch

Tow vehicle battery - The tow vehicle battery is the primary source of power for your trailer brake operation. To ensure available power when needed, keep your tow vehicle battery and charging system working properly.

Before you travel...

Brake Controller - The controller is installed on the tow vehicle dashboard to work in conjunction with the trailer brakes. Hydraulic or electronic controllers are available. Consult with your independent, authorized dealer or the controller manufacturer to decide what is right for you and your trailer.

Wire Harness/Connector Plug - A seven way plug is wired into your trailer to connect electrical power to the tow vehicle for travel. This supplies power to the brakes, exterior lights, etc. Wiring to operate your brakes must be the same size in both the tow vehicle and the trailer. Your trailer is wired with 12 gauge wire.

Make sure the plug is kept clean and protected from road elements as you travel. Consult the Electrical Section of this manual for further information.

Trailer Battery - A 12-volt auxiliary battery is required to operate the breakaway switch. Consult with your independent, authorized dealer to purchase a battery and have it installed.



WARNING: For the breakaway switch to be operational, an auxiliary battery needs to be installed on your trailer. Consult with your independent, authorized dealer to purchase the battery and have it installed.

Breakaway Switch - The breakaway switch is a crucial part of the braking system. Located on the trailer tongue, this switch will apply the trailer brakes if it becomes detached from the tow vehicle. Attach the breakaway switch lanyard to a permanent part of the tow vehicle (do not attach it to the hitch ball or similar removable parts) when hitching the trailer. If the trailer is detached from the tow vehicle, the pull pin will be pulled from the switch. This automatically causes the switch to “close” and activates the trailer brakes.

Refer to the manufacturer’s supplied information for the breakaway switch. Consult with your independent, authorized dealer or the switch manufacturer if you have questions.

Caution: NEVER use the breakaway switch and trailer brake system as a parking brake. Doing so would create a high amp draw on the battery and converter. This can cause damage to wiring, connectors and the breakaway switch.

HYDRAULIC BRAKES

Your trailer may be equipped with hydraulic surge brakes. These brakes operate automatically as the tow vehicle’s brakes are applied. When the tow vehicle operator begins to decrease speed and apply the brakes, the weight of the moving trailer pushes forward and the coupler moved downward. This pressure moves the plunger, which in turn pushes the piston and rubber cup inside the master cylinder. Brake fluid presses inside of the wheel cylinder and activates the brake shoes against the drum.

Backing Your Trailer

As designed, the weight of a trailer pushing forward will activate the surge brake system. When backing a trailer up hill, the weight of it may activate the brakes, making it difficult to continue to reverse.

1. Prior to backing up a slope or through soft ground, pull the trailer forward slightly to assure that the actuator socket is in the forward position.
2. Move the lever knob on the side of the actuator downward from the “towing position” along the curved slot in the actuator frame to the “backup position”. The slot has a notch at the bottom of its travel. Push the lever down to engage the locking notch.
3. The trailer will now back up. This lever knob will slide into the correct position when pulling forward.

N NOTE: It is extremely important to keep the master cylinder full at all times. An empty cylinder invites moisture.

Breakaway Protection

The hydraulic brake system is equipped with a breakaway cable or chain. When towing, this cable or chain must be attached loosely to a frame member of the tow vehicle, leaving enough clearance so the trailer can turn freely without actuating the breakaway device.

If the trailer separates from the tow vehicle, the breakaway cable will actuate the master cylinder, locking the brakes. This will stop the trailer in the shortest possible distance.



CAUTION: Breakaway protection must be fully released during the vehicle operation. Check this before towing. Do not use the breakaway protection as a parking brake.

WHEN THE CAMPING TRAILER IS NEW

Caution: *The following process to “season” your trailer tent is important. If you do not follow this procedure, you may experience some water seepage during the first few exposures to rain.*

1. Well in advance of any trip, set up your folding camping trailer.
2. Using a garden hose, thoroughly soak the tent with a light spray of water. DO NOT spray directly on the canvas with a high pressure hose.
3. After the tent dries, repeat the soaking process three additional times.

If you note any water seepage or leaks after seasoning your tent, let the tent dry then spray water repellent on the INSIDE of the seam where seepage occurs. One or two applications of water repellent may be necessary to stop all water seepage in seams where thread enters the fabric.

N NOTE: Touching the tent canvas when it is wet can cause leakage. If leakage persists, please contact your independent, authorized dealer for assistance.

PRE-TRAVEL CHECKLIST

In order to enjoy your travel, having all the right tools and supplies will help. A checklist may be beneficial to avoid forgetting something essential. This list is meant to be a starting point, while realizing that personal preference will also play a large roll in your packing. There are items here which may not apply for you and items which could trigger other ideas. As you expand your camping experience, you may wish to develop your own list of needs.

Tow Vehicle/Trailer

- Check fluids
 - oil
 - coolant
 - transmission fluid
 - washer fluid
 - power steering fluid
 - brake fluid
 - battery terminal
- Check belts
- Check wheel lugs
- Check tire pressure (include inner wheel and spare, if applicable)
- Check tire wear (uneven wear pattern)
- Check lights
 - headlights
 - brake lights
 - clearance lights
 - turn signals
- Trailer safety chains connected
- Breakaway switch and lanyard connected
- Coupler locking pin connected
- Trailer electric cable secure
- Tongue jack fully up
- Dolly wheel removed
- Retract stabilizer jacks
- Retract steps (if applicable)
- Proper tongue weight maintained (10-15% of gross weight - trailer and contents)
- Trailer is level
- Wheel blocks removed
- Test brakes for proper operation

- Tools
 - jack
 - torque wrench
 - tire pressure gauge
 - jumper cables
 - duct tape
 - fuses and light bulbs (compatible with your RV)
 - shovel (small folding)
 - axe
 - saw (bow or folding)
 - work gloves
 - AC voltage tester
 - tool kit (screws, hammer, pliers, etc.)
 - rope, cord, bungee cord(s) or wire
- Electrical cord
- Water hose
- Disposable rubber gloves
- Sewer hose
- Surge protector
- Telephone and/or cable wire (if applicable)

Supplies

- First aid kit
- Flashlight(s)
- Toilet paper
- Bug spray
- Sun screen

Recreation

- Games - cards, board, dice
- Outdoor activity equipment (fishing poles, tennis rackets, etc.)
- Lawn chairs
- Campfire supplies
 - smores - marshmallows, chocolate, graham crackers
 - skewers, pie irons, etc.
 - fire grate for cooking
 - firewood, newspapers and/or kindling
 - matches in waterproof container and/or utility lighter

Bedding

- Sheets
- Blankets
- Comforters
- Pillows
- Sleeping bags

Before you travel...

Kitchen

- Pots & pans
- Cooking utensils
- Trash bags and/or paper sacks
- Aluminum foil, plastic wrap, etc.
- Paper plates, towels, napkins, coffee filters, etc.
- Dish towels and rags
- Dish soap
- Food supplies
- Charcoal and lighter fluid

Personal Supplies

- Clothing
- Toiletries
- Towels - beach and bath
- Laundry detergent

Before leaving home

- All list items packed in trailer/tow vehicle
- Refrigerator door locked
- Loose items secured
- Membership cards
- Trailer keys
- Vehicle registration
- Proof of insurance
- Roadside assistance phone number, membership card and/or policy
- Road flares
- Map/road atlas/campground directory
- Owner's manual for RV
- Owner's manual and information regarding component parts
- Arrange for pet care, mail/newspaper pickup
- Leave itinerary with neighbor/family/friend
- Security watch for house (neighbor/family/friend)
- Weigh fully loaded trailer (cargo and liquids included) and maintain proper weight distribution (redistribute as necessary)

SETTING UP CAMP...

SELECTING YOUR CAMPSITE

In some cases, searching for the right campground prior to traveling might be the first step in selecting your site. Some campgrounds will allow reservations made in advance. Depending on the area you are headed to and the time of year (i.e. around a holiday), reservations may limit your frustration upon arrival.

Your trip experience will be effected by the site you choose to park your RV. With time, you will know what you are looking for and what best fits your needs. A few items to keep in mind when selecting your campsite are:

- Arrive before dark, if possible, to make the site selection easier.
- Is the ground level? This will help with leveling your RV and making your stay more comfortable.
- Is there plenty of space?
 - › Will it accommodate slideouts, canopy, etc.? (if applicable)
 - › Is there room for picnic tables, lawn chairs, campfire, etc.?
 - › Is it void of hanging limbs that may damage your unit?
- Is it located in a convenient area?
 - › Will you be able to park close enough to hookups (water, sewer, electric)?
 - › Are you away from noisy areas or things that might detract from a positive experience?
 - › Is there plenty of shade?
 - › Is there good drainage in case of bad weather?

Beyond finding a site that best suits your needs, it is also helpful to keep in mind how you are affecting your camping neighbors' experience. Some etiquette items to keep in mind are:

- Observe the quiet times as posted and abide by the rules of the campground.
- Don't play loud music or make noise which is going to be disturbing to others around you.
- If pets are allowed, keep them restrained.
- Show respect to others, don't make shortcuts through occupied campsites.
- Keep your campsite clean and pick up all trash before departing from the campground.

Additional Considerations with a Baja Trailer

With your purchase of a Baja Folding Camping Trailer, a new world to camping experience is open for exploration. As you venture to remote locations, the Baja trailer will provide some added benefits for the off road experience.

When traveling off main roads to discover where the trails lead, there are additional safety concerns to consider. Take time to read, understand and follow the owner's manual as well as any information that is provided for the safe operation of your trailer.

Information and education that you obtain about traveling off road could help to insure a safe and enjoyable experience. While experience is a good teacher, there are resources and schools available to provide insight into the additional requirements of off road travels.

Some basic items to keep in mind are:

- There are trails that will lead to incredible adventure if you keep the limitations of your tow vehicle and trailer in mind. Travel only on trails which will accommodate your tow vehicle and trailer combination.
- While your trailer is built to travel on more rugged trails, taking extra time and traveling slower will ensure that you do not damage the trailer.
- There are areas you will be able to explore with your tow vehicle that will not accommodate a trailer. Be aware of where a trail is leading before attempting to tow your trailer there.
- Make sure that all safety information in this manual and component manufacturers' manuals has been reviewed and understood before you begin your travels. Preparation before departing may help to avoid issues as you travel.

SETTING UP YOUR TRAILER

Front Deck (Baja Trailers Only)

Your Baja trailer is equipped with a front deck for hauling extra cargo. Make sure that you unload the front deck before unhitching your trailer from the tow vehicle. Refer to information supplied in the "Before you travel..." chapter in this manual and information supplied by the loading ramp manufacturer for proper use of the front deck and loading ramps.

Un-Hitching

1. Position the trailer as desired.
2. Level the trailer (side to side). Refer the leveling paragraph below.
3. Block the wheels to prevent the trailer from rolling.
4. Unhook the trailer/tow vehicle electrical connection, safety chains and breakaway switch cable (if applicable).
5. Install the dolly wheel.
6. Release the weight distributing bars as recommended by the hitch supplier.
7. Open the coupler latch.
8. Turn the jack crank to raise the coupler above the hitch ball.
9. Level the trailer (front to back) with the jack crank.
10. Lower the stabilizer jacks (if applicable). Refer to the steps below.
11. Pull the tow vehicle away, as desired.

Leveling Your Trailer

Leveling your RV is critical for several reasons. Your camping experience will be more pleasant in a level unit. It is important for your RV to be level for proper operation of items such as the refrigerator, the slideout system and draining tanks, if applicable.

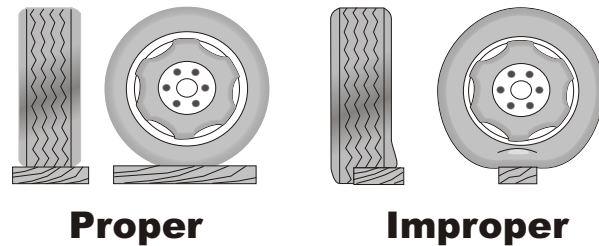

Fig. 6

Using blocks under the RV tires is a common way to level the unit. Blocks for this purpose can be purchased from various RV resources or made out of wood. The proper size of blocks are required to prevent causing damage to the tires. Make sure the blocks used cover the entire footprint of the RV tire. Refer to Fig. 6 for proper tire blocking.

Stabilizer Jacks

1. Insert the crank onto the stabilizer jack shaft.
2. Turn it clockwise to lower the jack. Continue lowering the jack until the frame of the trailer begins to rise slightly.
3. Equalize the jacks for best support. This may require that you adjust each jack several times. When not parked on cement, you may wish to place a wood or hard plastic block under the jack for convenience.



WARNING: DO NOT USE THE STABILIZER JACKS TO LEVEL THE UNIT. It is important to remember that the stabilizer jacks are to be used only for support while occupying and moving around the trailer. They are not designed to bear the weight of the trailer.

Tent Set Up



WARNING: Never leave your folding camping trailer plugged into the 120-volt AC outlet while it is folded down. This would make the converter continue to run, which can cause overheating and present a fire hazard.



CAUTION: To prevent damage to the lifter system, never move your folding camping trailer unless the roof is lowered as in the travel position and the roof latches are fastened.





NOTE: Make sure that you have followed the procedures for seasoning the folding camping trailer tent the first time you use it. Refer to the “Before You Travel...” chapter for instructions to follow.

OPENING YOUR FOLDING CAMPING TRAILER

Park your camping trailer on level ground and block the tires so the trailer will not roll away. After parking the trailer, disconnect it from the tow vehicle. If your camping trailer is not level, you may experience difficulty with its set up, particularly with the fit of the entrance door.

1. Lower the stabilizer jacks. Place the jack crank onto the jack shaft. Turn it clockwise. Lower the jacks until the frame begins to rise slightly. Equalize the stabilizer jacks for best support. You may need to adjust the stabilizer jacks two or three times.

 **CAUTION: DO NOT USE THE STABILIZER JACKS TO LEVEL THE CAMPING TRAILER. THEY ARE INTENDED TO STABILIZE THE UNIT AND WILL NOT SUPPORT ITS WEIGHT.**

 **NOTE:** Road dirt and grime will sometimes make jacks difficult to operate. You may need to clean them out before operating. To maintain the stabilizer jacks, keep them clean. Lubricate them twice a year using only silicone lubricants. Oils will attract dirt and cause additional problems.

Do not place excessive weight on these jacks as they are intended to stabilize, not support the folding camping trailer. Make sure the folding camping trailer is level.

2. Unfasten each roof latch. (Fig. 7)

 **CAUTION: Never attempt to crank up the roof until all corner latches are unlocked and free. (Fig. 7) NEVER LIFT THE ROOF WITH CARGO IN PLACE.**

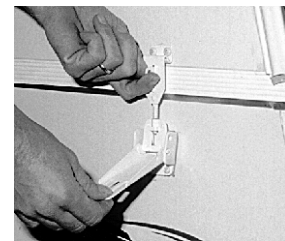



Fig. 7

3. Turn the thumb latch and open the door at the crank compartment.
4. Insert the crank into the square tube and turn it in a clockwise direction. (Fig. 8)
5. Raise the roof until the tent is loosely extended.

 **NOTE:** At this point, the roof needs to be high enough to ensure that the tent will not be in the path of the bed slide during the bed setup.

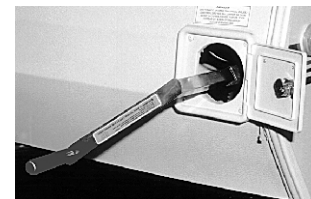



Fig. 8

 **NOTE:** The bed braces and bed bow braces are stored under the bed mattress. (Fig. 9)

Caution: For slideout models, pull the slideout tent outside of the unit BEFORE pulling the beds out. Make sure that all tent material is clear from the bed slide.

6. Before pulling out the front bed, place the flat end of the bed brace into the slot provided on the frame.

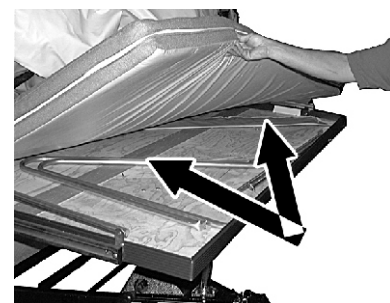

Fig. 9

- Place the bent hook into the bracket attached to the front wall. (Fig. 10)
- Pull the beds out until the rail hits the bed stop. Distribute the awning panel over the bunk and place the corners of the tent over the bed corner. Again, be sure the beds are extended all the way out against the stops.

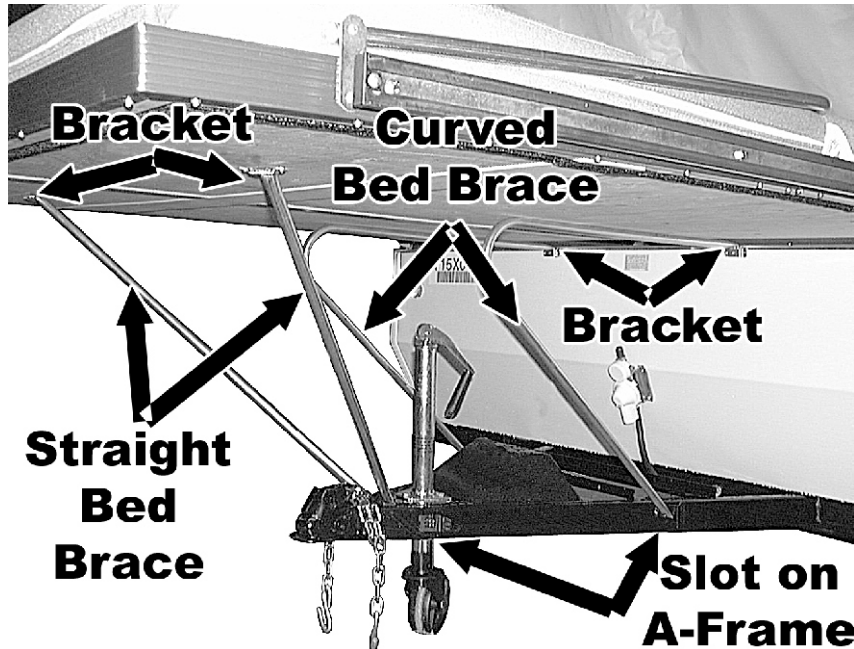

Fig. 10

WARNING: Do not use bed braces if they are bent or damaged. Replace all damaged braces.

- Place the flattened end of the straight bed brace into the slot provided on the frame of the camper. Place the angled and smashed end of the straight bed brace into the bed bracket near the outer corner under the plywood bunk bed. (Fig. 10)
- Now, complete raising the roof until the gray limit cable is almost tight and the tent is almost taut. DO NOT OVERTIGHTEN. (Fig. 11)

Caution: If the limit cable is raised too high, lifter system/tent damage could occur and the door will not fit properly.

For Models With Slideout

- Pull out the slideout using the handle(s) located on the side of the slideout.

Caution: Do not extend the slideout before pulling the beds out.

- Pull the tent flaps located on the side of the slideout out over edge and attach them to the Velcro.
- Enter the unit and set up the kitchen flip-top. Attach the stove grate.

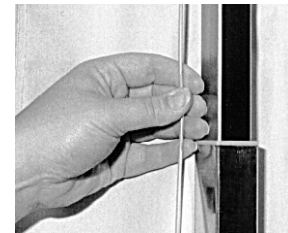

Fig. 11

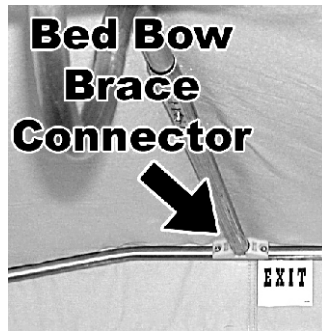

Fig. 12



Fig. 13

11. Inside the unit, for the bed and slideout tent set up, insert the bed bow brace at the bed bow connector. (Fig. 12) Push the bed bow outward and upward while pressing on the button farthest from the end and slip it into the bracket mounted on the roof. Release the button. (Fig. 13)

To Install Door

12. Unsnap the ties holding the door to the roof (Fig. 14).
13. Rotate the turn button (Fig. 15) located on the bottom of the door 1/4 turn to unlock it.

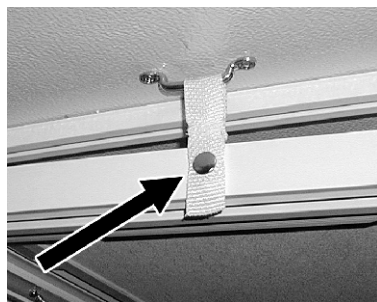

Fig. 14



Fig. 15

14. Swing the door down following the ceiling tracks (Fig. 16) and place the bottom of the door in the threshold opening of the entrance door.
15. Insert the top of the door and rotate the twist locks (Fig. 17) 1/4 turn.
16. Lock the four turn buttons (Fig. 18) on the side of the door.

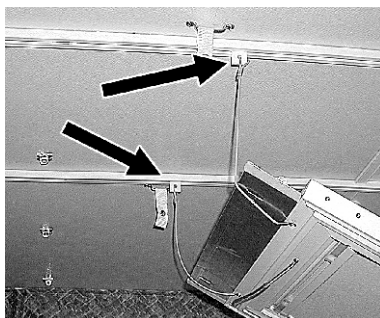

Fig. 16

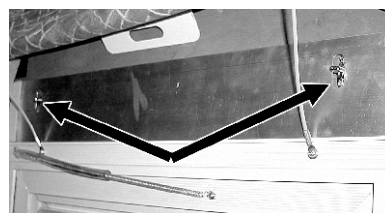

Fig. 17



Fig. 18

17. Attach the Velcro® edges of the door to the door frame.
18. On units without a slideout, set up the kitchen flip top and attach the stove grate.
19. Exit the unit and pull bed flaps over the bed corners until the flaps are extended under the bed. Securely attach all Velcro.



WARNING: Ensure that all Velcro® fasteners are mated and securely fastened. Loose areas could result in openings large enough for an infant, child or adult to fall through. Never leave small children in the camper unattended.



CAUTION: The roof has a weight limit of 350 pounds in the travel mode. The maximum weight that can be lifted is 250 pounds.

CLOSING YOUR FOLDING CAMPING TRAILER

Caution: Let the tent dry thoroughly before storing to prevent mildew and odors. If it is necessary to put the tent away wet or damp, at the earliest possible time, open the tent and allow it to dry thoroughly. Mildew is not covered by your warranty.

Inside

1. Enter the camping trailer, make sure all equipment is properly stored and will not obstruct the roof when lowered.
2. Remove the canvas from the screen door by detaching the Velcro®.
3. Remove the door from the top and bottom tracks. Slide the door to the travel position along the tracks (Fig. 16) located on the ceiling and lock it in place with the turn button (Fig. 15) located on the bottom of the door by turning 1/4 turn. Snap the ties holding the door to the roof (Fig. 14).

Caution: When securing the bottom of the door, insure that the door valance is placed between the door and the ceiling to avoid damage to the valance.

4. Zip all windows closed.
5. Roll all privacy drapes upward by pressing both buttons on either side of the black locks and drawing the locks upward.
6. Remove the bow braces located in the bed and slideout areas from the roof bracket and pull the brace to the center of the trailer. Remove the bow brace from the saddle plug on the bed bow. Place the bow braces under the bed mattress. (Fig. 9)
7. Remove the stove grate and stove. Place the kitchen flip top in the travel position.

Caution: Failure to properly position the kitchen flip-top for travel can result in roof damage and prevent the roof from lowering properly.

Outside

Caution: DO NOT push the beds or slideout in until ALL Velcro® is detached. Push the bed and slideout in COMPLETELY before beginning to lower the roof. Failure to push in the beds and slideout completely BEFORE lowering the roof can damage the tent components. Your warranty does not cover this damage.

For Models With Slideouts

- a. Unfasten the Velcro® and snaps from the slideout and place the tent inside the slideout.
- b. Push the slideout into the travel position.
- c. Pull the tent out of the slideout to ensure that the bed slides do not rip the tent.

Caution: Make sure the slideout tent is pulled to the outside of the unit before the beds are pushed in. Failure to do this could result in cutting the slideout area tent.

8. Unfasten all Velcro® located under beds.
9. Remove the straight bed braces and push the beds in carefully and completely.
10. Remove the curved bed braces. Place all braces under the bed mattresses carefully. (Fig. 9)
11. Lower the roof half to two-thirds down. Reach inside and distribute the awning panel of the tent and drape it EVENLY across the beds and slideout (if applicable).
12. Continue to lower the roof until the final 6-8". Using both hands and arms, push the tent from each side, front and rear, into the center of camper evenly and carefully continue to lower roof.
13. Attach the roof latches to the clips (Fig. 7). Due to air pockets, the roof may need to be pushed down with your hand the last 1-2".
14. Before removing the crank, tighten the cable system by turning the crank in the "UP" movement to make it taut taking caution not to overtighten. This will place slight tension on the cable system and avoid cables becoming loose and entangled.

Caution: It is very important to place tension on the cable system to prevent them from becoming tangled. If the cables become tangled, it could lead to breakage of the lifter cables when the roof is raised.

15. Remove the crank and place it in the storage area inside the camper.
16. Close and latch the door to the crank compartment.
17. Raise the stabilizer jacks to their upright position. Insert the crank and turn it counterclockwise until the jack is tight, then turn crank an additional 1/8 of a turn (snug tight).

Canopy Set Up

Your canopy has been designed and built with quality material to give you years of trouble free service with low maintenance. Read these instructions fully before beginning the setup. Become familiar with each pole, its description and where it belongs. (Fig. 19)

One person can do the setup, but two people will make it easier.

1. Open the zipper and unroll the canopy fabric.
2. Insert the two end divider bars "C" (with gray caps) and the center spacer bar "D" (7/8" tube) into the front pocket of the canopy. These bars may be left in the canopy during travel or storage, but make sure they are removed during winter storage to avoid corrosion.
3. Assemble the two parts of a tension rafter, Pole "A." Insert the peg through the "eye" of the snap button pole "B" and then through the hole in the middle of the center spacer bar "D." Compress the tension rafter and place it in the center of the roof side board, as pictured. The metal tip from the tension rafter will rest against the roof metal or the canopy bag.
4. If no screen room is being installed, repeat step #3 on the front and rear tension rafter, inserting the end of the tension rafter through the snap button poles "B" and the end divider bars "C." Position the tension rafter as in step #3.
5. After all the poles are installed:
 - a. Adjust the canopy to fit properly.
 - b. Adjust the height of the canopy with the snap button poles.
 - c. Install the three stakes to anchor the canopy in case of strong winds.

Caution: Always install the stakes to avoid wind damage to the poles and the fabric. In severe wind it is best to remove the canopy. Wind and rain damage are not covered by the Jayco Limited Warranty.

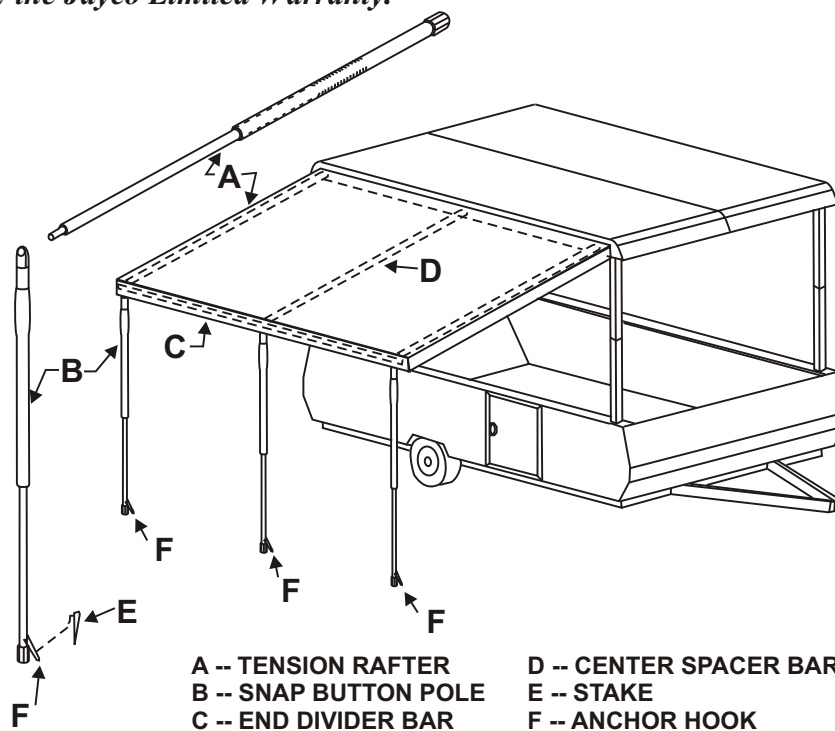

Fig. 19

Screen Room Set Up

1. The canopy must be set up through step #3 before attempting to attach the screen room. (See Canopy Setup.)
2. Open, unfold and spread the screen room under the canopy area. The enclosure must be on the outside of the snap button poles. A grassy area or clean floor is suggested.
3. Each upper side panel has a pocket sewn into the fabric. Slide a two-piece tension rafter into the pocket with the white crutch tip to be placed against the side panel of the roof. Insert the crutch tip at the outer edge, and push in toward the unit.
4. Insert the peg through the “eye” of the snap button pole “B” and then through the hole at the outer end of the end divider bar “C”. The white rubber crutch tip will rest against the roof metal or the canopy bag. Install both ends.
5. Attach the Velcro hook sewn to the inner side of the canopy to the Velcro loop sewn to the outer side of the screen room, full length.
6. Wrap the lifter post covers around the posts and attach them with the Velcro.
7. Ensure that all snaps are securely fastening the skirt to the frame of the unit.
8. Attach the Velcro from the skirt to the Velcro on the screen room lower corners.
9. Adjust the three snap button poles “B” so the bottom of the screen room is just touching the ground.
10. Install the seven (7) stakes through the screen room loops to protect against wind damage.

Heated Bed Mat (Option)

Your heated RV Bedding has been carefully designed and manufactured to provide years of relaxing, comfortable sleep. The bedding is manufactured to reach gentle, soothing heat warmth, NOT the pain relieving heat of a heating pad. At first touch it may seem only slightly warm because it's conserving energy inside for you, but as your body weight presses onto the bedding, and a blanket covers you, it will feel considerably warmer and comfortable.

Caution: Be sure to read all instructions carefully before using this bedding.

- YOUR BEDDING SHOULD ALWAYS REMAIN FLAT, NEVER FOLDED, ROLLED OR BUNCHED. EXCESSIVE HEATING MAY OCCUR FROM MISUSE.
- Place the bedding on the mattress, box spring or platform with the label and connector up.
- The cord should be at the head of the bed.
- Do not tuck in the wired area of the bedding.
- Let the cord hang free - DO NOT route electrical cords between the heated RV bedding and the mattress, box spring or base platform. Do not allow the cords to be pinched. NEVER pull the mat by its cord.
- Keep the control away from an open window.
- Do not use pins or any heavy, sharp pointed objects on the bedding. They may damage the heating elements.
- Be sure this bedding is used on 120 Volt AC circuit
- Turn off the electric current when this bedding is not in actual use.

- If improper operation of this bedding is observed, discontinue its use immediately and consult your independent, authorized dealer or the manufacturer. The bed mat is manufactured by Flair Interiors. They can be reached at 574-534-2163 or at their website, www.flairinteriors.com.
- This appliance has a polarized plug (one blade is wider than the other) as a safety feature. This plug will fit into a polarized outlet only one way. If the plug does not fit fully into the outlet, reverse the plug. If it still does not fit, contact a qualified electrician. Do not attempt to defeat this safety feature.
- Refer to the maintenance chapter for complete care instructions.

Dinette to Bed Conversion

1. Remove the table top and cushions. Place them to the side.
2. Remove the table legs from the floor brackets and place them in one of the storage compartments of the dinette seats. Place the storage cover back on the dinette seat.
3. Place the table top across the middle from one dinette seat to the other resting on the front edge bracket. For comfort, make sure the table top is level with the top of the dinette bench.
4. Position the dinette bench cushions in place across the benches and the table top.

To convert back to the booth dinette, reverse the procedures above.

DINETTE TABLE EXTERIOR USE

The dinette table is portable for use on the exterior of the trailer. To set the table up on the exterior of the trailer:

1. Place the dinette table on the bracket installed on the exterior of the trailer at a 45° angle.
2. Extend the leg attached to the bottom of the table out.
3. Lower the table to rest on the extended table leg. Make sure the leg is securely supporting the table before placing items on it.

UTILITY HOOKUPS

To complete the unit set-up, the utilities should be hooked to the proper sources as supplied by the campground. Make sure that you read, understand and follow all information provided for complete operation of the utility systems.

Electricity

By connecting the trailer electric system to the campground electric source, or “shoreline” power, electricity will be supplied to operate the 120-volt AC and 12-volt DC electrical systems. When hooking up to electricity, follow these steps:

1. Make sure that all lights and electric equipment is turned off in the trailer.
2. Locate the power cord and pull it from the RV to the length required.
3. Plug into the campground power source



WARNING: Do not use an adapter, cheater or extension cord that will break the continuity of the grounding circuit. NEVER remove the

grounding pin to connect to a non-grounded receptacle. Any deviation from this will potentially cause a fire from overheating.

Caution: Power surges experienced while plugged in at a campground could potentially damage electronic component parts in your recreation vehicle. Damage from power surges are not covered by your Jayco warranty. Consult the component manufacturer's owner's manual and/or your independent, authorized dealer for recommendations on power surge protection.

Water

A complete fresh water system is included in your RV. Fresh water is supplied to the system from two sources:

- City fill connection hooked to an exterior water source.
- A gravity fill tank installed on your trailer.

TO UTILIZE THE CITY WATER CONNECTION

1. Attach a fresh water hose from the city water connection (Fig. 20) to the campground water source.
2. When the water is turned on, you may experience some air in the water lines. Make sure to let all this air escape before turning off the faucet.

Caution: The handle should be in the tank water position when connecting the city water to avoid a city water spill.



Fig. 20

TO UTILIZE ON BOARD WATER

1. Remove the cap from the gravity fill connection. (Fig. 21)
2. From an exterior water source, insert the fresh water hose into the gravity fill connection.
3. Fill the tank as desired. The size of the tank will vary based on your unit's floor plan. It is equipped with an overflow outlet. Make sure that you do not leave the tank unattended while filling it. Do not overfill the tank.



Fig. 21

Caution: Be careful not to overfill the tank. It can pressurize the tank, causing leakage and water damage and void the warranty. DO NOT leave the tank unattended while filling.

12 VOLT DC ON-DEMAND PUMP

To extract water from your water tank, you need 12 volt-DC power to operate the on-demand water pump. Energy for the pump is supplied by the auxiliary battery or converter. Depending on your trailer model, the pump will be located under the bed, in a cupboard, under the unit or under the sink. The switch to operate the pump is located on the monitor panel or a wall near the pump.

Refer to instructions supplied by the pump manufacturer with your trailer. If you have questions, consult with your independent, authorized dealer and/or visit the manufacturer's website at www.shurflo.com.

N NOTE: The water pump switch should be in the off position when the camper is left unattended for any amount of time. If something would happen to the water system, this will help limit water damage to a smaller area.

WATER PRESSURE REGULATOR

Excessive pressure from water supply systems may be encountered in some parks, especially in mountain regions. Water pressure regulators are available to protect your system against such high pressure. A regulator of this type is recommended to prevent damage to the plumbing system or component parts.

Caution: Not using a water pressure regulator when using city water may cause the o-rings to blow. It is advisable to always use a water pressure regulator when using the city water connection.

WASTE WATER DISPOSAL

Proper disposal of waste water is important. Most campgrounds and some states prohibit waste water drainage onto the open ground. Refer to the information in the "Preparing to Travel Home..." chapter for instructions on waste water disposal. If you have further questions, consult with your independent, authorized dealer.

Propane Connections and Start Up



WARNING: Propane can be extremely dangerous. Make sure that you read, understand and follow all information supplied in this manual and all component part manufacturers' manuals before operating your propane system.

After the camper is completely set up and you are prepared for camping enjoyment, follow these steps for propane operation.

1. Close all the burner valves, controls and pilot light valves.
2. Open the main valve on the propane container slowly to avoid a fast rush through the excess flow valve causing a "propane freeze." If you experience a propane "freeze-up," close the main valve and wait 15 minutes before trying again.
3. Listen carefully as the propane begins to flow. If "hissing" is heard for more than one or two seconds, this may indicate a leak. Immediately close the valve and search for the leak.
4. Light the appliances as needed and directed in the appliance manufacturers instructions.

Make sure that you read and fully understand ALL safety requirements for handling and operation of the propane system. Literature is supplied with your unit from the manufacturer of the various appliances hooked to your propane system. The propane system provides added benefits to your camping enjoyment, however, it must be handled with care. If you have any questions or concerns, consult with your independent, authorized dealer and/or the specific appliance manufacturer.

If you have double cylinders on your trailer, use only one at a time. Otherwise the propane supply will be drawn equally from both cylinders until the supply has been totally exhausted. Using one cylinder until it is empty, then using the second cylinder will allow you to fill the empty cylinder at your convenience without being totally out of propane.

AT CAMP...

Your camping trailer is designed with equipment to enhance your outdoor experience. The features of your individual trailer will vary based on the options purchased and built into the unit. Make sure that you review all information supplied with your trailer to safely operate the individual components.

All appliances in your trailer are name brand quality built equipment, guided by current codes and standards. For propane operation, the appliances in your trailer will operate on propane only, not on natural gas. All safety precautions for propane, found in this manual and additional information supplied by appliance manufacturers with your unit, must be followed during operation of the appliances. Please familiarize yourself with this information before proceeding.

ICE BOX

If your trailer is equipped with a ice box, make sure you understand its functionality. Read, understand and follow all information supplied with your trailer from the ice box manufacturer. If you have further questions, consult with your independent, authorized dealer.

REFRIGERATOR (OPTION)

A refrigerator may have been installed when your trailer was built. It will provide the same functions as your home refrigerator, but will operate differently. Make sure that you read, understand and follow all the information supplied by the refrigerator manufacturer, Norcold. Consult with your independent, authorized dealer for further information, or visit their website at www.norcold.com/norcold_home.cfm.

STOVE, RANGE, OVEN

Your trailer may be equipped with a drop in stove or range with oven option (certain models only). This equipment is designed to operate with propane. Make sure you read, understand and follow all information supplied by the appliance manufacturer and in this manual about the use of propane. The appliance will operate similar to a gas cooking appliance in your home. If you have questions or concerns, consult with your independent, authorized dealer and/or visit the appliance manufacturer's website.

To Use the Stove Outside

1. Unhook the propane hose and carry the stove out. Always carry the cabinet assembly with both hands.
2. Mount the cabinet onto the rail at a 30° angle and slowly lower the outer side until it is in a horizontal position.
3. If applicable, attach the brace to the underside of the stove and unit.
4. Propane connections are made with a "Quick Coupler" system. This system has a positive shut-off valve as required by code and standards. See the instructions below for attaching the propane line.
5. Each stove assembly will has a hinged wind guard attached. Raise the hinged assembly to a vertical position. The end panels are also hinged and will swing to the

outer edge of the stove for wind protection, preventing flames from reaching the tent material.

Connecting the Propane Line

 **WARNING: Make sure that you read, understand and follow all information supplied with your RV about propane before operating the stove. The propane hose must be correctly connected before lighting the stove. Failure to follow instructions supplied by the stove manufacturer with your RV or to use any other components than those originally supplied with the grill could lead to death or serious injury from fire or explosion.**

1. Place the handle in the “OFF” position and push the sleeve back. The valve handle must be in the “OFF” position to make the connection. (Fig. 22)
2. Insert the plug and release the sleeve. (Fig. 23)
3. Push the plug in until the sleeve snaps forward. This will lock the plug in the socket. Turn the handle to the “ON” position to turn propane on. (Fig. 24)
4. To disconnect; reverse the order of connection.

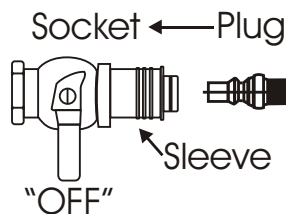

Fig. 22

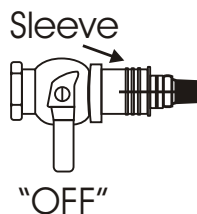

Fig. 23

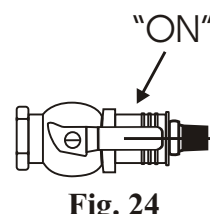

Fig. 24

MICROWAVE (SELECT MODELS ONLY)

Your microwave has been installed above the range and operates similar to your microwave at home. Make sure you have reviewed and understand all information supplied with your unit from the microwave manufacturer. Contact your independent, authorized dealer if you have more questions, or consult with a Samsung appliance dealer.

FURNACE (OPTION)

Your trailer may be equipped with a propane furnace. Make sure you understand the properties of propane and follow all safety instructions to operate this appliance. The furnace manufacturer has supplied an operation manual to guide you with understanding how to operate your furnace. Refer to this information for complete instructions. If you have further questions, consult with your independent, authorized dealer.

WATER HEATER (OPTION ON SOME MODELS)

Your trailer may be equipped with a water heater that is manufactured by Atwood Mobile Products. Complete safety, operating and maintenance instructions are supplied by Atwood with your trailer. Make sure you read, understand and follow all instructions before operating the water heater. If you have further questions, consult with your independent, authorized dealer and/or visit Atwood's website at www.atwoodmobile.com.

CASSETTE TOILET (OPTION)

Depending on the trailer floor plan, you may have a cassette toilet installed on your trailer. Review all instructions as supplied by the toilet manufacturer for its proper operation and care. If you have questions, consult with your independent, authorized dealer and/or visit the manufacturer's website at www.thetford.com.

OUTSIDE SHOWER (SOME MODELS)

A convenient exterior faucet assembly (Fig. 25) with hot and cold water may be installed on your trailer. This will allow for washing and rinsing on the outside of the trailer.

Operation

1. Activate pump.
2. Open door with key and allow to hinge down.
3. Remove shower head and open valve.
4. Open faucet valves and adjust to temperature as desired.
5. To cease operation, close valve(s) on faucet and allow water to drain from shower head.
6. Close valve on shower head.

Water remaining in the hose will drip or run out of vacuum breaker. This is NOT a leak, but performs as intended. Water in A.B.S. plastic box will drain out along outer edge. The shower head can be removed to drain the hose faster. If you choose to remove the shower head to drain the hose, reassemble it for storage. Coil the hose and arrange it with the shower head inside the faucet assembly. Make sure that the hose is not being pinched and the shower head is not being damaged when the door is closed. Keep the door closed when not in use for sanitary reasons.

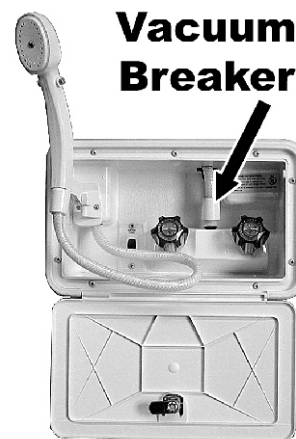

Fig. 25

WATER PURIFICATION SYSTEM (OPTION)

A water purification may be installed as an option on your trailer. This system is equipped with a long-life cartridge to effectively reduce chlorine, taste, odor, sediment, organic chemicals and inhibit bacteria growth. Whenever the water system has not been used for some time, allow water to flow for several minutes to flush the system. When the system is not in use, store the water filter cartridge in the mounting bracket located near the water system, and when necessary, out of freezing temperatures.

RV antifreeze will damage the water filter cartridge. A clear plastic bypass hose with fittings on either end is supplied with your trailer to replace the water filter when the trailer is winterized. The hose should be stored when the filter is in use and kept available to reuse.

The filter should be replaced the sooner of: reduced water flow causing an inconvenience, or one time each year.

To replace the filter

1. Drain the water system.
2. Remove the cartridge by disconnecting the fitting at either end of the filter and pull it out of the fittings. It may be helpful to have a container available under the filter to catch any water left in the lines or filter.
3. If winterizing the unit, install the bypass hose and store the filter as is appropriate.
4. If replacing the filter, install the new filter and tighten the fittings at either end.



CAUTION: Never allow the filter to freeze or come in contact with RV antifreeze when the trailer water system is winterized. Refer to complete instructions supplied by the water purification system manufacturer.

AIR CONDITIONER PREP (OPTION)

Your trailer is equipped with wiring to install an air conditioner. It is recommended that you have the installation performed by a qualified RV technician only. Refer to the “Safety” chapter regarding changes, modifications and additions to your trailer.

To comply with State, Federal, ANSI/NFPA codes and (if applicable) Canadian Standards, as well as Jayco standards, optional air conditioning units must be installed using the following:

1. 20-amp receptacle with 12 gauge wire.
2. 20-amp power cord to feed air conditioner.
3. Two twist caps.

The weight limit for air conditioners is 110 lbs. It is your responsibility to insure that an air conditioner installed on your trailer does not exceed the weight limit. Exceeding this weight can damage the roof and lifter system which will not be covered by your Jayco Limited Warranty. Verify that the brand of air conditioner installed on your trailer complies with all necessary codes and weight limits.

1. Follow the air conditioner installation instructions as supplied with the air conditioner.
2. Connect the 20-amp power cord to the air conditioner as listed in the above warning.
3. Notch the interior air conditioner shroud so the cord can pass between it and the roof. The 120-volt cord is held up to the ceiling using the two-part wire cover provided.
4. Measure the distance from the air conditioner shroud to the outer edge of the ceiling and cut both pieces of the wire cover to this length.
5. The base side of the wire cover has an adhesive tape attached to it. Peel off the protective film covering the adhesive.
6. Line up the wire cover between the air conditioner shroud and the outer edge of the ceiling. Press it firmly in place.
7. Place the 120-volt cord in the wire cover base and snap the wire cover cap into the base.

SOLAR PREP (OPTION - BAJA ONLY)

Your trailer may be equipped with wiring for solar panel installation. Please consult with your Jayco dealer for assistance with installation of solar panels. Refer to the “Safety” chapter regarding changes, modifications and additions to your trailer.

ENTERTAINMENT

Your trailer may be equipped with component parts for your entertainment. Each component part is supplied with an operation and maintenance manual in your unit’s information packet. Make sure that you are familiar with the information and how it operates. Any questions should be directed to the component part manufacturer and/or your independent, authorized dealer. A Manufacturer’s Customer Support Directory appears in this manual. It provides some websites and phone numbers for component part manufacturers.

BBQ GRILL PREP

Your unit is equipped with a propane “quick coupler” connection and support bracket for easy installation of the optional BBQ grill. The “quick coupler” is directly connected to the propane system of your trailer. Make sure that you read, understand and follow all information about propane supplied with your unit by various component manufacturers and this manual.

 **WARNING: Make sure that you read, understand and follow all information supplied with your RV about propane before operating the BBQ grill. The propane hose must be correctly connected before lighting the grill. Failure to follow instructions supplied by the grill manufacturer with your RV or to use any other components than those originally supplied with the grill could lead to death or serious injury from fire or explosion.**

The “quick coupler” connection can be attached to the BBQ grill as follows:

1. Place the “quick coupler” handle in the OFF position and push back the sleeve. The valve handle must be OFF to make the connection. (Fig. 26)
2. Insert the plug at the end of the BBQ grill propane hose and release the sleeve.
3. Push the plug until the sleeve snaps forward, locking the plug into the socket. (Fig. 27)
4. Turn the handle ON to allow propane to flow to the BBQ grill. (Fig. 28)

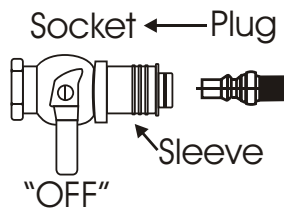

Fig. 26

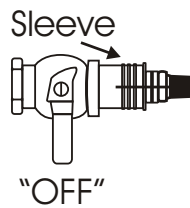

Fig. 27

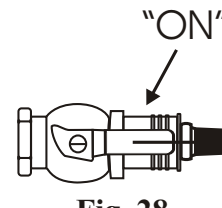

Fig. 28

BBQ Grill (Option)



WARNING: The maximum weight limit for the bracket on the side of your trailer is 50 lbs. This limit includes the weight placed on the BBQ grill. Exceeding this weight limit could cause damage to the unit and possibly cause personal injury from hot equipment.

An option for your trailer is a BBQ grill. This grill is for use outside of the trailer. **Never use this grill inside a compartment or the trailer.** The bracket and “quick coupler” propane connection are installed on your trailer as standard equipment. The following list will supply basic operations for the grill. Make sure to read, understand and follow all instructions included with the BBQ grill.

1. Install the grill bracket on the support bracket installed on the side of your trailer. Make sure that it is securely placed on the support bracket.
2. Place the BBQ grill into the grill bracket. (Fig. 29)
3. Attach the propane hose from the grill to the “quick coupler” propane connection as directed above.
4. Open the lid to the BBQ grill.
5. Using an electric match, light the grill using the following procedures:
 - › Light the electric match.
 - › Insert it into the middle slot on the bottom of the BBQ grill.
 - › On the BBQ grill control knob, depress and turn the knob to the desired temperature.
 - › The grill should light at this point.
6. If the grill does not light, turn the propane off, wait five (5) minutes and repeat the above steps.
7. Use the temperature control knob to adjust the grill to the desired temperature. (Fig. 30)

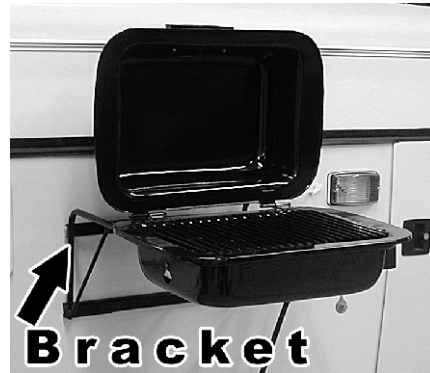

Fig. 29

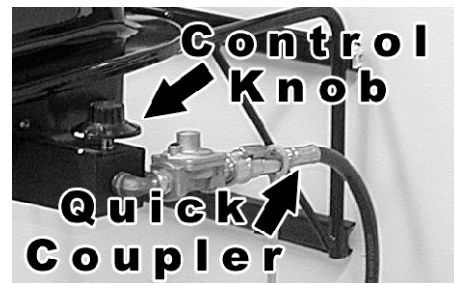

Fig. 30

The BBQ grill grate is coated with standard grill enamel and can be cleaned as you would a grill at home. Underneath the grate, there is a heat diffuser. This is formed and ventilated to distribute the heat from the burner. Do not use lava rocks in this grill.

To disconnect the BBQ grill, turn the temperature control to OFF. Reverse the above propane hose hookup procedures. Wait until the grill is completely cooled, then store it in the supplied carrying case. This carrying case will ONLY accommodate a cool grill. The grill carrying case has a pocket for accessories such as the propane hose in the lid. The bracket will not fit inside the carrying case and will need to be stored in a separate location.



CAUTION: The BBQ grill must be COMPLETELY cooled before storing to avoid damaging the carrying case and causing injury from handling the grill when it is hot.

UTILITIES & SYSTEMS

N NOTE: Make sure you read, understand and follow all safety information found in this manual and manufacturer supplied information.

PLUMBING SYSTEM

For set up instructions of your plumbing system, refer to the “Setting Up Camp...” chapter. If you have further questions on setting up the system, consult with your independent, authorized dealer.

Sanitizing the Potable Water System



WARNING: Failure to sanitize the potable water system could result in death or serious injury.

Potable water systems require periodic maintenance to deliver a consistent flow of fresh water. Depending on use, and the environment the system is subject to, sanitizing is recommended prior to storing and before using the water system after a period of storage.

Systems with new components, or ones that have been subjected to contamination, should also be disinfected as follows:

1. Use one of the following methods to determine the amount of common household bleach needed to sanitize the tank.
 - › Multiply “gallons of tank capacity” by 0.13; the result is the ounces of bleach needed to sanitize the tank.
 - › Multiply “liters of tank capacity” by 1.0; the result is the milliliters of bleach needed to sanitize the tank.
2. Mix the proper amount of bleach into a container of water.
3. Pour the solution (water/bleach) into the tank and fill the tank with potable water.
4. Open all faucets allowing water to run until the distinct odor of chlorine is detected.
5. The standard solution must have four (4) hours of contact time to disinfect completely. Doubling the solution concentration allows for contact time of one (1) hour.
6. When the contact time is completed, drain the tank. Refill with potable water and purge the plumbing of all sanitizing solution.

If there is a problem of excessive chlorine odor and taste after the sanitizing process, follow the above procedures using a solution of baking soda (1/2 cup added to one gallon (4 liters) of water per 15 gallons (60 liters) of tank capacity) or vinegar (one quart added to five gallons (20 liters) of water per 15 gallons (60 liters) of tank capacity.)

Your demand water system is now ready for use. Refer to instructions on filling the tank and utilizing the system in the “Setting Up Camp...” chapter.

Drainage - Fresh Water

Permanent water tanks may be drained through a valve located near the tank. Any camper with a demand pressure pump system will have low-point drains attached to the water lines normally located near the water tank. These low-point drains will release water in the supply lines by opening the valves and all faucets. The water heater has its own drain plug.

SANITATION SYSTEM (WITH BATH/SOWER OPTION ONLY)

Refer to manufacturer's information for complete operating instructions of the cassette toilet if applicable to your trailer. If you have questions, consult your independent, authorized dealer or the toilet manufacturer's website at www.thetford.com.

Caution: *For the protection of your sanitation system and the environment, always use biodegradable toilet paper that is specifically rated for recreation vehicles. If you have questions, consult with your independent, authorized dealer.*

PROPANE SYSTEM



WARNING: Propane can be extremely dangerous. Improper use of the propane system will present an immediate hazard situation where death or serious injury will result. It is possible that mechanical or property damage will also occur. Make sure you read, understand and follow all information supplied with your unit in this manual and all component part manufacturer's literature.

It is because of the propane system that your RV has the convenience of a refrigerator, stove, water-heater, and furnace. The components of the propane system are:

- Propane container or cylinder
- A two stage regulator
- Pipes, hoses and tubing to deliver the propane to appliances

When correctly used, the propane system is a safe and effective way to operate the appliances in your RV. This system is also potentially very dangerous and should be used with care. Carefully read, understand and follow all information supplied with your trailer for the propane system and its components and consult with your independent, authorized dealer about the proper operation of the propane system.

A warning label has been placed in your RV to warn against asphyxiation (inability to breathe). The label has been located in the cooking area to remind you to provide an adequate amount of fresh air for combustion. Please read, understand and follow the information in the label.



WARNING: IT IS NOT SAFE TO USE THE COOKING APPLIANCE FOR COMFORT HEATING.

- 1. Cooking appliances need fresh air for safe operation. Before operation:**
 - a. Open overhead vent or turn on exhaust fan.**
 - b. Open window.**
- 2. Unlike homes, the amount of oxygen supply is limited due to the size of the recreation vehicle, and proper ventilation when using the cooking appliance(s) will avoid dangers of asphyxiation. It is especially important that cooking appliances not be used for comfort heating, as the danger of asphyxiation is greater when the appliance is used for long periods of time.**

FAILURE TO COMPLY COULD RESULT IN EXPLOSION RESULTING IN DEATH OR SERIOUS INJURY.

The following label has been placed in the trailer near the range area. Please read, understand and follow the information in this label.

! **DANGER**
IF YOU SMELL PROPANE

1. Extinguish any open flames, pilot lights, and all smoking materials.
2. Do not touch electrical switches.
3. Shut off the propane supply at the cylinder valve(s) or propane supply connection.
4. Open doors and other ventilating openings.
5. Leave area until odor clears.
6. Have the propane system checked and leakage source corrected before using again.

**FAILURE TO COMPLY COULD RESULT IN EXPLOSION
RESULTING IN DEATH OR SERIOUS INJURY.**

As noted above, the presence of any propane smell is dangerous. Make sure that everyone, including pets, are out of the RV. Do not return to the RV until the source of the propane odor has been determined and corrected by a propane professional.

Propane Container

The container or “cylinder” is a D.O.T. approved container to hold propane in liquid form, and is normally a 20# or 30# (9 or 14 kilograms) capacity. The open/close valve is to be closed at all times unless hooked up to the propane system or filling the container. When the container is disconnected from the hose, install the valve cover that is attached to the container. This is required by the National Fire Protection Association (NFPA), other applicable local codes and for your own safety. Do not allow the container (filled or empty) to move or roll around while transporting to and from the filling location.

! **DANGER: All pilot lights, appliances and their igniters (see operating instructions) must be turned off before refueling of motor fuel tanks and/or propane containers. FAILURE TO COMPLY COULD RESULT IN DEATH OR SERIOUS INJURY.**

The components of the propane container are:

1. Knob to open valve to fill or to use camper.
2. Complete valve assembly.
3. “10%” valve, small brass knob or slot screw.
4. Container mounting stand.

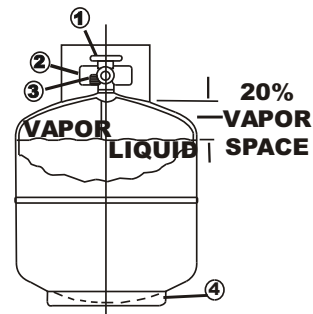

The following warning label has been located near your trailer's propane container(s). Make sure you read and follow all information on this label. Failure to do so could result in death or serious injury.

 **WARNING:**

THIS PROPANE PIPING SYSTEM IS DESIGNED FOR USE OF PROPANE ONLY. DO NOT CONNECT NATURAL GAS TO THIS SYSTEM. DO NOT FILL CONTAINER(S) TO MORE THAN 80 PERCENT OF CAPACITY. FAILURE TO COMPLY COULD RESULT IN A FIRE OR PERSONAL INJURY. Securely cap inlet(s) when not connected for use. After turning on propane, except after normal container replacement, test propane piping and connections to appliances for leakage with soapy water or bubble solution. Do not use products that contain ammonia or chlorine. AS-34

INSTALLING PROPANE CYLINDERS

1. Place the cylinder onto the steel angle rack. (Fig. 31)
2. Insert 2-1 / 4 x 1 / 2 " bolts through the hole in center of angle.
3. Attach lock washer and nut onto bolt.

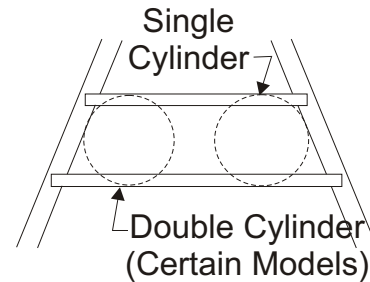

Fig. 31

 **WARNING: Ensure that all fasteners are secured before traveling.**

SERVICING AND FILLING PROPANE CONTAINERS

Your propane containers should only be serviced and filled by a qualified person who know the proper inspection and safety procedures. If a propane container is new, make sure the service person is aware of it so they can be purged prior to being filled. Propane containers must never be filled beyond 80% of capacity to allow for expansion with increases in temperature. The following warning label is located near the propane container(s). Make sure that you read, understand and follow these warning labels.

 **WARNING: DO NOT FILL CONTAINER(S) TO MORE THAN 80 PERCENT OF CAPACITY.**

- **Overfilling the propane container can result in uncontrolled propane flow, which can cause fire or explosion.**
- **A properly filled container will contain approximately 80 percent of its volume as liquid propane.**

 **WARNING: Propane cylinders shall not be placed or stored inside the vehicle. Propane cylinders are equipped with safety devices that relieve excessive pressure by discharging propane to the atmosphere. FAILURE TO COMPLY COULD RESULT IN DEATH OR SERIOUS INJURY.**

 **WARNING: Do not bring or store propane cylinders, gasoline, or other flammable liquids inside the vehicle because a fire or explosion can result.**

 **WARNING: Portable fuel-burning equipment, including wood and charcoal grills and stoves, shall not be used inside the recreation vehicle. The use of this equipment inside the recreation vehicle may cause fires or asphyxiation.**

When a propane cylinder gets low, sometimes there is a concentration of garlic-like odor, which may be mistaken for a propane leak. After a change over to a full cylinder, the odor usually will disappear. If not, turn off the propane cylinder and have the system checked by a qualified technician.

 **WARNING: DO NOT use tools to open or close the cylinder valve. HAND TIGHTEN ONLY. The use of tools to tighten the cylinder valve creates the potential to overtighten the valve. This could cause damage to the interior seals on the cylinder valve seat. If damage occurs, you will not be able to close the cylinder properly, creating a false sense of security that the propane cylinder is shut off. Consult with your independent, authorized dealer or a qualified propane dealer if you have further questions.**

 **DANGER: Never smoke during the filling of propane cylinders. Keep the RV away from the immediate filling area when possible or extinguish all propane pilot lights. Failure to follow this safety rule could lead to death or serious injury from fire or explosion.**

OPD OVERFILL PROTECTION

Your propane cylinder(s) are equipped with Type 1 ACME propane connections. No tools are required to tighten or loosen the connections. They are designed so propane will not flow from the cylinder unless the correct connection is made.

Make sure you read, understand and follow the information supplied with your unit that is relevant to the propane cylinder connections for your safety and convenience of use of the OPD overfill protection.

The position of the propane cylinder(s) and the hoses are critical to proper operation and propane flow. Follow these instructions to make sure your propane cylinder(s) are connected properly.

Single Cylinder Mounted On A-Frame

1. Connect the 3/8" low pressure hose to the outlet of the two stage regulator.
2. Attach the regulator with the "Z" bracket on the center of the front wall with the vent pointing down.
3. Attach the protective plastic cover to the regulator.
4. The regulator has a 90° elbow that directs the inlet toward the trailer curbside.
5. Place the cylinder on the bracket provided on the A-frame and position is so the outlet of the cylinder valve is pointed directly outward to the curbside wall.
6. If a vinyl cylinder cover is provided, slip it over the cylinder and leave the zipper open.
7. Attach the 1/4" inverted flare x 24" Type 1 pigtail hose to the regulator inlet and the right hand swivel nut to the cylinder valve.
8. If applicable, close the cylinder cover zipper up to the hose.
9. Secure the cylinder to the A-frame bracket using the bolts, nuts and washers provided.

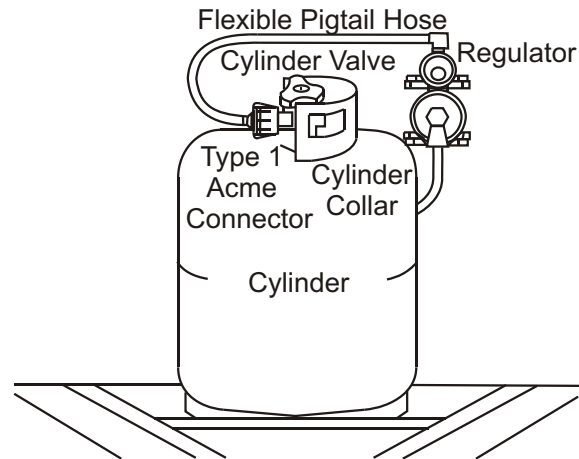

Fig. 32

Double Cylinder Mounted On A-Frame

When a second cylinder is installed, a tee check is used to replace the 90° elbow at the top of the regulator and another 1/4" inverted flare x 24" Type 1 pigtail is added. The regulator stays in the original position.

1. Place the second cylinder on the A-frame bracket so the cylinder valve is pointed to the roadside of the folding camping trailer.
2. Secure the second cylinder to the A-frame using the bolts, nuts and washers provided.
3. If a vinyl cylinder cover is used, slip it over the new single cylinder, or a double cylinder cover may be used in lieu of single covers.
4. Attach the second 24" hose to the tee check on the regulator and the right handed swivel nut to the cylinder valve.

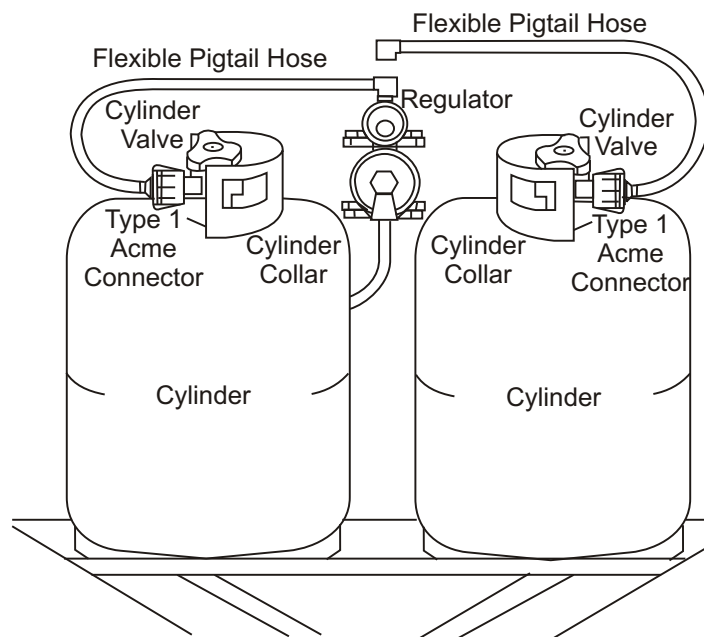
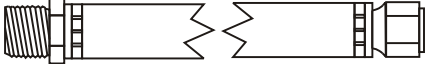

Fig. 33

Main Supply Hose – Low Pressure

The main supply hose (Fig. 34) will be attached from the regulator to the brass manifold fitting in the frame of the trailer. The swivel brass nut on the main hose will be your final attachment.

Fig. 34  3/8" MPT x 1/2" Female Flare Swivel

Several things to remember each time the propane container is removed:

1. Check that ALL fittings are tight.
2. Check that ALL connections are tested with leak solution. Consult with your independent, authorized dealer or propane service personnel.
3. Open the main valve slowly to avoid a fast rush of propane to excess flow valve causing propane freeze up. If you experience a propane “freeze-up,” close the main valve and wait at least fifteen (15) minutes before trying again. Refer to the document found with your trailer literature from the regulator manufacturer.
4. Listen carefully - a “hissing” sound longer than one second may indicate a propane leak. Close the valve and search for the leak.

Regulator

The regulator is in integral part of the propane system. It is required to reduce the pressure of the propane before it is sent to the system to operate your appliances. It is critical to your safety that you read, understand and follow all literature supplied with your unit on the operation and maintenance of the regulator.



WARNING: Propane regulators must always be installed with the diaphragm vent facing downward. Regulators that are not in a compartment have been equipped with a protective cover. Make sure that the regulator vent faces downward and that the cover is kept in place to minimize vent blockage, which could result in excessive propane pressure causing fire, explosion, death or serious injury.

PROPANE CONSUMPTION

Most propane appliances are operated intermittently. Unless there is heavy use of hot water, the water heater consumption is minimal. During freezing weather and high wind conditions, furnace consumption can be extremely high.

Propane consumption depends upon the length of time appliances are operated. Each gallon (3.86 liters) of propane produces about 91,500 BTUs (46,514 kilojoules) of heat energy.

(N) NOTE: The following chart is an example of RV appliances that may be part of your trailer. Consult your independent, authorized dealer or appliance manufacturer’s information for complete information.

Appliance	Average BTU Consumption Per Hour	Kilojoules/Hour
Water Heater	8,800	9,280
Refrigerator	640	672
Furnace	16,000-20,000	16,880-21,100
Stove	6,500 - 9,000	6,825 - 9,450
Outside Grill	10,000	10,550

Propane Detector

All recreation vehicles with a propane system require a propane leak detection device (Fig. 35) for safety protection. A converter or auxiliary battery is required to supply 12-volt DC energy to operate the leak detector. Carefully read, understand and follow the information supplied by the propane detector manufacturer which is supplied with your trailer. Consult with your independent, authorized dealer and/or visit the manufacturer’s website at www.mtiindustries.com if you have any questions on the operation or maintenance of this detector.

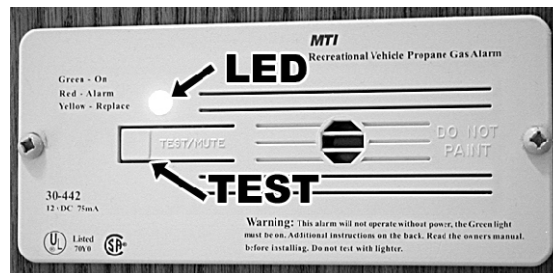

Fig. 35



WARNING: For your safety, make sure that the propane detector is properly maintained and functioning. The detector requires 12-volt DC energy through the converter or from an auxiliary battery to operate. Without a proper energy source, the detector will not work and you will not be warned of leaking propane.

ELECTRICAL SYSTEM

General

The electrical system in your trailer consists of 120-volt AC (alternating current) and 12-volt DC (direct current) circuits and components. All installations are made in compliance with safety requirements of ANSI standard A.1192, National Electric Code, and Canadian Standards Association.

All trailers will have 30-amp service pre-wired into the breaker box.

Caution: Power surges experienced while plugged in at a campground could potentially damage electronic component parts in your recreation vehicle. Damage from power surges are not covered by your Jayco warranty. Consult the component part manufacturer’s owner’s manual and/or your independent, authorized dealer for recommendations on power surge protection.

Fig. 36

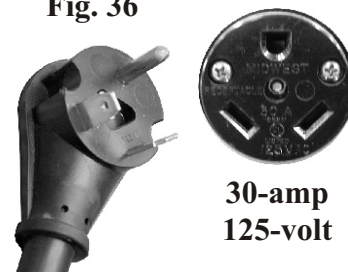

30-amp
125-volt

120-Volt AC System

POWER CORD

Your trailer is equipped with a 30-amp power cord pre-wired into the breaker box. By opening the cable hatch door, you can pull the power cord from the compartment and attach it to the campground power source. For Canadian units, the power cord is protected with a 30-amp main circuit breaker. Power is distributed through circuit breakers to receptacles built into walls and cabinets. The cord extends approximately 25' (7 meters) from the trailer depending on the floor plan. Your RV power cord must be fully extended and not left coiled in the compartment or on the ground. If the cord is left coiled, it creates potential for heat to melt the cord's casing together.

To prevent accidental electrical shock, insure that the ground pin on the attachment plug cap is intact to the earth ground through the RV park receptacle. Any accidental short of a live circuit conductor will trip the circuit breaker indicating a shorted circuit. Make sure that the polarity of the external power is not reversed, in order to avoid harm to appliances and personal electrical shock. Polarity indicators may be purchased in most electrical and hardware stores.

It is strongly recommended to avoid the use of extension cords. Using an improper extension cord will cause overheating of the cord and equipment, and it voids the warranty. It may also cause premature failure of the AC equipment. If you choose to use an extension cord, it **MUST** be the same amperage rating as the RV power cord and be identified for heavy-duty outdoor use. However, the use of an extension cord can still cause all of the problems discussed here and will void the warranty.



WARNING: Do not use an adapter, cheater or extension cord that will break the continuity of the grounding circuit connected to the third pin. NEVER remove the grounding pin to connect a non-grounded, two-prong receptacle. Any deviation from this will potentially cause a fire from overheating.

GFCI



WARNING: Make sure you read, understand and follow all instructions supplied by the GFCI receptacle manufacturer with your RV. Failure to follow these instructions could lead to death or serious injury from shock or electrocution.

Each trailer has a GFCI receptacle installed. These initials mean "Ground Fault Current Interrupter." This special receptacle has been designed to reduce the possible injury caused by electrical shock.

An example of ground fault current is the current which would flow through a person who is using or touching an appliance with faulty insulation and, at the same time, is in contact with an electrical ground such as a plumbing fixture, wet floor, or earth.

When this GFCI receptacle is tripped, it has interrupted ground fault current caused by such things as faulty insulation or wet wiring inside some appliance or equipment connected to the circuit. The faulty equipment should be repaired before it is used again.

This GFCI receptacle will not protect against short circuits or overloads. The circuit breaker or fuse in the electrical panel which supplies power to the circuit provides this protection.

The GFCI receptacle should be tested monthly while the trailer is being used. Any suspected problems with the GFCI should be checked by an independent, authorized dealer.

Testing Instructions

1. Plug a 120 volt electrical device into the receptacle on the face of the GFCI.
2. Push and release the RESET button.
3. The 120 volt electrical device should operate at this time.
4. Press the TEST button.
5. The RESET button should pop out indicating it has been “tripped” and the 120 volt electrical device should go out. (If the GFCI is manufactured with an indicator light, the light should glow when the GFCI has tripped.)
6. If the GFCI did not trip, do not use the outlet. Call a qualified electrician to service or replace the receptacle. The ground fault protection is no longer working properly.
7. To restore power after “tripping”, press in the RESET button. It must remain in. (If an indicator light is furnished, it will be off.)

12-Volt DC System

The 12-volt DC system is composed of numerous items such as a power converter, battery, fuses, wire, and bulbs, both interior and exterior lighting. Explanation on these items will follow in this section.



WARNING: For the breakaway switch to be operational, an auxiliary battery needs to be installed. Consult with your independent, authorized dealer to purchase the battery and have it installed.

Caution: Your camping trailer has many 12-volt DC loads. When combined, they total more power consumption than is available with the 12-volt DC converter. Periodic overloads can be handled with the optional auxiliary battery for short periods of time. It is suggested to conserve your 12-volt DC system at most times. Prolonged overload may shorten the performance life of the power converter.

POWER CONVERTER

(N) NOTE: The power converter is a complicated feature. There are no customer serviceable parts in or on the converter. If the converter is opened, it will void the converter warranty. If you have questions or concerns, consult with your independent, authorized dealer.

A power converter utilizes 120-volt AC power and transforms this energy into 12-volt DC power, which is used inside of your trailer. 12-volt DC energy supplies power to all interior

lights and various appliances. The floor plan, and size of the camping trailer dictates the model and output size of the converter required.

Inside the converter is an electronic device which converts 120-volt AC incoming power to 12-volt DC output power. An auxiliary battery as correctly installed will be charged when the trailer is connected to 120-volt AC power. The converter will supply power to individual components through fuses located behind the converter face plate.



WARNING:

- **Turn off all interior lights before folding the camping trailer to transit as the bulbs may cause a fire hazard in the stored position and burn holes in the tent.**
- **Do not block power converter ventilation.**

Interior

All 12-volt power comes from the converter or the black lead in the wire harness from the tow vehicle battery. Remember, to receive power from the converter, you must have a 120-volt energy source available. 120-volt power may be turned off or on by switching the 120-volt breaker in the converter.

The “bunk” light will attach to the bed bow brace with a clip on the back of the light. To operate the light with 12-volt power, plug the cord into the receptacle located on the ceiling light, front or rear. A switch to control the bunk light is built into the light assembly.

A camping trailer with a porch light will have the on/off switch built into the light assembly. The bunk light may also be used outside by clipping it to the optional canopy. When attached to the canopy, the bunk light will be connected to the porch light receptacle.

Auxiliary Battery (Independent, Authorized Dealer Installed Option)

All camping trailers are prewired to accept an auxiliary battery. The battery must be hooked up directly to the red (positive) and white (negative) wires at the battery hold down bracket near the trailer hitch.

The auxiliary battery will help minimize tow vehicle battery discharge when 120-volt power is not available.

A battery is required to operate the breakaway switch and also provides a source of energy when traveling and camping.

All battery packages require an “in-line” fuse and holder attached to the battery for circuit protection. Consult with an independent, authorized dealer for correct installation of the auxiliary battery.



CAUTION: When drawing current from the tow vehicle battery, avoid discharging the battery to a level at which the tow vehicle will not start.

All camping trailers have a ceiling light circuit fed through a master shut-off switch which prevents 12-volt current from flowing to the ceiling lights with the roof lowered. Periodically test the light and switch to be sure the switch adjustment is correct. The switch is located along the bottom edge of the roof on the roadside of the unit.

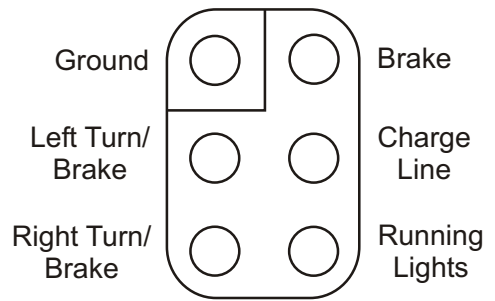

Bulbs

WARNING: Replacement light bulbs must be of the type, voltage and wattage listed on the lamp fixture. Use of incorrectly sized bulbs can overload lamp circuits and may create a fire hazard by overheating the fixture.

Bulbs	Interior	Ceiling, Bunk Lights	#921
	Exterior	Porch Light	#912
	Exterior	Tail Light/Signal	#1157
	Exterior	Clearance	#194

Fuses

WARNING: Do not replace circuit breakers or fuses with a higher current rating than those supplied with the camping trailer. Over fusing can cause a fire hazard by overheating the electrical wiring.

Fuses	Operation	Location	Circuit Number	Fuse Size	Type
	Interior Lights, Water Pump, Radio	In converter	1	15	Blade
	Refrigerator	In converter	2	15	Blade
	Furnace	In converter	3	15	Blade
	Battery Charge	In converter	4	15/20/30*	Blade
	Battery Prep	In line by battery	--	30	Blade
	Propane Detector	Behind propane Detector	N/A	1	Blade
*15-amp with 12-amp converter *20-amp with 20-amp converter *30-amp with 30-amp converter					

When attaching wire leads to your tow vehicle, carefully insulate all connections for protection. Follow the instructions on the instruction sheet provided with the covered harness.

PREPARING TO TRAVEL HOME...

DEPARTING CAMP CHECKLIST

When the time arrives to return home, it is again critical that you complete the necessary procedures to ensure a safe trip. As you develop a routine, it is possible that a checklist will be helpful. This is a general list, which you may want to customize as you determine your own needs. In addition, make sure you follow the hitching procedures listed in the “Before You Travel...” section of this manual.

Safety

- Make sure you follow all safety precautions noted in this manual and in any information from component part manufacturers when preparing to travel home.

Interior

- Counter items put away or tied down
- Latch drawers, cabinets & doors
- Refrigerator door locked
- Set refrigerator to 12-volt (if applicable)
- Close windows & latch blinds
- Close roof vents
- Lower antenna & satellite dish (if applicable)
- Position the booth dinette in the bed position for travel (if applicable)
- Furnace turned off
- Water heater turned off
- Water pump turned off
- Lights turned off
- Move slideout in and lock it in place (if applicable)

Exterior

- Retract awning and secure in place
- Retract slideout (if applicable)
- Retract step
- Pack equipment into compartments and secure it
- Propane turned off
- Water hose & electric cord unhooked and stored
- Visually look under RV for items missed
- Lock all exterior compartments
- Empty gray holding tank (if applicable)

Tow Vehicle/Trailer

- Check fluids
 - oil
 - coolant
 - transmission fluid
 - washer fluid
 - power steering fluid
 - brake fluid
 - battery terminal
- Check belts

- Check wheel lugs
- Check tire pressure (include inner wheel and spare, if applicable)
- Check tire wear (uneven wear pattern)
- Check lights
 - headlights
 - brake lights
 - clearance lights
 - turn signals
- Safety pin or locking lever must be seated
- Trailer safety chains connected
- Breakaway switch and lanyard connected
- Coupler locking pin connected
- Trailer electric cable secure
- Tongue jack fully up
- Dolly wheel removed
- Retract stabilizer jacks
- Proper tongue weight maintained (5-10% of gross weight - trailer and contents)
- Trailer is level
- Test brakes for proper operation

DRAINING WASTE WATER

(N) NOTE: Make sure you review the information in the “Before You Travel...” chapter for specific information related to the weight of holding tank contents.

Depending on your trailer floor plan and options purchased, there are several options for waste water disposal. Determine which option applies to your trailer and follow the instructions listed below.

Drainage Outlet

Connect a hose to the drainage outlet. (Fig. 38) This connection may be located on the sidewall or under the trailer. Drain the sink either into a container to hold the waste water or to a direct sewer inlet supplied by some campgrounds.

(N) NOTE: Most campgrounds and some states prohibit sewer water drainage onto the open ground.

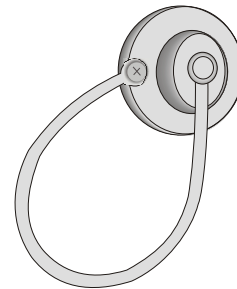

Fig. 38

Gray Water Holding Tank With Bath/Shower Option

A permanent gray water tank may be installed on your folding camping trailer. To drain this tank:

1. Pull the trailer to an approved dump station.
2. Remove the cap and attach a hose to the outlet of the trailer and place the other end in the dump station drain.
3. Pull the gray tank drain lever on the termination valve (Fig. 39) to release the water from the tank.
4. When the tank is empty, push in on the drain lever to close the termination valve.
5. Replace the cap.

No special initial preparation is required. However, placing a small quantity of chemicals into this tank, such as baking soda or a Thetford chemical, will reduce odors from food particles in the system.



Fig. 39

MAINTAINING YOUR INVESTMENT...

MAINTENANCE

Your trailer is designed to be as maintenance free as possible. However, maintenance is important to retain its condition as near new as possible and preserve the warranty. The information in the following pages is supplied to provide guidance for your maintenance routine. Many of the component part manufacturers supply information for their equipment. The features of your trailer will vary based on the floor plan and options. Refer to all instructions supplied with your trailer when performing maintenance. Proper maintenance will give you many trouble free miles.

(N) NOTE: Some areas in this chapter may not be applicable to your trailer.

(N) NOTE: Failure to properly maintain your trailer can cause numerous problems and it voids Jayco's warranty as well as the warranties of many of the component part manufacturers.

Caution: We recommend that you do not take your recreation vehicle through automatic car washes. Extreme caution should be used if utilizing any type of pressure sprayer around all attachments, doors, windows, appliance vents, etc. Avoid forcing water inside the unit, which could possibly damage component parts.

EXTERIOR FINISH

Depending on your trailer's features, the exterior is constructed of aluminum or fiberglass. Refer to the general instructions that follow for care information.

Aluminum

The aluminum on the outside of your trailer can be cleaned and washed the same as an automobile finish. It is suggested that a spray wax or wash and wax combination be used for waxing due to the texture of the aluminum. The textured aluminum siding will reduce excess scratching. The roof aluminum skin material should be washed and polished to maintain its finish.

Fiberglass

Fiberglass parts are very durable and easy to maintain. To keep them looking nice, wax and buff them once a year. Standard automotive cleaning soaps and waxes work well for general cleaning and maintenance. In addition, do not dry wipe the surface. Special cleaners and waxes are available at automotive and RV stores.

Scratches, chips and other cosmetic cracks can be easily fixed by an experienced fiberglass repair shop. Any major damage should be repaired as soon as possible to keep cracks from spreading.

SEALANTS

Water is a recreation vehicle's worst enemy when it is allowed to enter where it is not intended. Sealants perform a very important function, must be inspected closely and regularly maintained. We incorporate many different types of sealants, including butyl/putty, black butyl-encapsulated foam, silicone (clear and colored), roof sealant and foam. In general, sealants do not have "set" lifetimes. Varying environmental factors affect the pliability and adhesiveness of sealants. Sealants can be affected by ultraviolet exposure, air pollution, extreme temperatures and exposure to other elements. Conditions such as rain, salt, dust and pollution may increase the need to maintain your RV's sealants.

Checking your sealants is routine maintenance. It is recommended that you or your independent, authorized dealer:

- Inspect all sealants, a minimum of every six months. Make sure to check the roof and all four sides of the RV including all moldings, windows, doors, vents, and exterior attachments. Reseal as necessary and at least one time each year as preventative maintenance.
- Cap seal (if applicable) or replace the sealant if you notice any cracks, gaps, lifting, looseness, peeling, shrinkage, voids or any sign of physical deterioration. Complete repairs immediately to prevent damage to your RV.
- Always use the same type of sealant originally used to build your RV. Consult with your independent, authorized dealer for the proper sealant(s) to use on your RV.
- If you notice water inside the unit, immediately have the independent, authorized dealership check for the source of the leak. Failure to correct the leak may result in serious damage to your RV. This damage will not be covered under the limited warranty.

Caution: To check the exterior sidewall sealants, use a stepladder placed safely beside the RV. Do not prop a ladder against the body of the RV as it may damage the finish.

Caution: Failure to properly maintain or reseal your RV may result in serious water damage to the roof and other parts of the unit. This damage will not be covered under the warranty.

(N) NOTE: Although Fig. 40 may not accurately reflect the exact model of your RV, make sure you inspect all sealants as indicated in the text. If you have questions and/or need assistance with sealing your RV, consult with your independent, authorized dealer.

Fig. 40

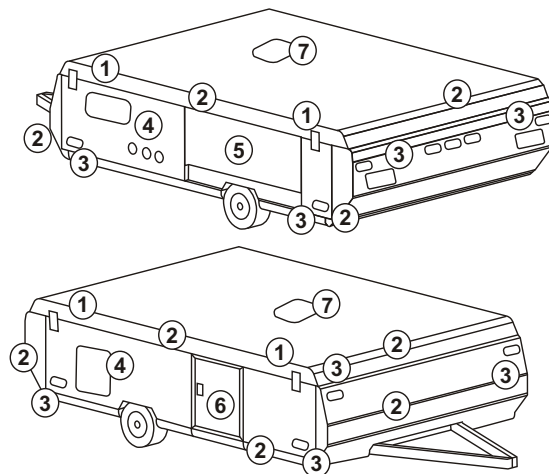

- 1 = Roof Latches
- 2 = All metal extrusions (including box top and corner moldings)
- 3 = Clearance & Tail Lights
- 4 = Appliances & Utility Hook ups
- 5 = Slideout (if applicable)
- 6 = Entrance Door
- 7 = Roof Attachments

ROOF LATCHES

Inspect the roof latches to make sure they are tight and have not been damaged. Periodically adjust them to maintain tension. If the latches become damaged, have them replaced.

LIFTER SYSTEM

Lifter Posts

The telescoping posts should be lubricated semi-annually. Use a light coat of silicone spray to insure smooth, trouble-free operation. Do not permit the the spray to come in contact with the tent. Do not use grease or oil on the posts. Grease and oil will attract dirt, causing the tent to become dirty.

Winch

The winch should be lubricated one time each year, preferably at the beginning of the camping season.

Access the winch through the lifter system crank door, or if necessary, inside the cupboard opposite the crank door on the interior of the trailer. If accessing the winch from the interior of the trailer, you will need to remove the winch cover. For ease of access to the winch from the interior, perform this maintenance just prior to closing the camping trailer.

Utilizing an oil can, place a small quantity of light oil on the pressure washer and tubing spacer (Fig. 41) before operating the lifter system to set up or close the trailer. As you raise/lower the roof of the trailer, the oil will be distributed to lubricate these components.

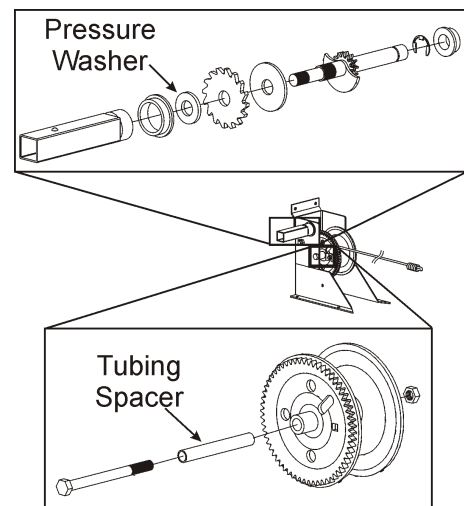

Fig. 41

FRAME

It is recommended you periodically inspect the exterior exposed areas, clean and repaint the steel members, occasionally and whenever you notice rust or paint chipped away, to insure long life. Road debris will chip paint, inviting rust and other deterioration. To prevent rust or corrosion, you may wish to purchase a commercially available rust treatment application. If damage would occur, the frame needs to be painted with e-coat paint and not a gloss black paint. This type of paint is available in a spray can from the vendor, Leland. Contact the vendor at their website, www.lelandengineering.com or by phone at 800-669-7681. Rust or frame damage resulting from lack of routine maintenance voids the warranty.

COUPLER

Use a small quantity of silicone spray on the moving mechanisms of the coupler. Also lubricate all moving parts in the actuator to insure ease of operation. It is recommended that you use conventional grease on the hitch ball.

TONGUE JACK

Lubricate the tongue jack by extending it to the full down position and insert SAE 30 oil through the oil hole in the top of the jack. Do this several times per camping season.

E-Z LUBE AXLE

The E-Z Lube feature on your axles provides the ability for the bearings to be periodically lubricated without removing the hubs from the axle. This feature consists of axle spindles that have been specially drilled and fitted with grease zerks in their ends. When grease is pumped into the zerk, it is channeled to the inner bearing and then flows back to the outer bearing and eventually back out the grease cap hole.

A manual is supplied with your trailer which covers the maintenance of your axles. Refer to this information for information regarding how and when to maintain the axle. If you have further questions, consult with your independent, authorized dealer and/or visit the manufacturer's website at www.dexteraxle.com.

(N) NOTE: The convenient lubrication provisions of the E-Z Lube and the oil lubrication must not replace periodic inspection of the bearings.

Wheel Bearings

Your trailer wheel bearings require axle maintenance just as any vehicle wheel bearings. Make sure you read, understand and follow the manufacturer's information on maintenance requirements. If you have further questions, consult with your independent, authorized dealer and/or visit the manufacturer's website at www.dexteraxle.com.

Wheel Lugs

Refer to the specific instructions supplied by the axle manufacturer and information found in this manual. Make sure that all instructions are understood and followed to insure safe operation of your trailer. If you have further questions, consult with your independent, authorized dealer and/or visit the manufacturer's website at www.dexteraxle.com.



WARNING: DO NOT ignore checking the wheel lug nuts. Failure to do so can cause wheel loss, an accident, injury or death.

Electric Brakes and Brake Linings

Refer to the brake manufacturer's supplied information for a complete maintenance schedule on the brakes and brake linings. Information may also be obtained by visiting their website at www.dexteraxle.com. Make sure that your brakes are in good working condition before each trip.

(N) NOTE: Canadian transportation laws require that brake linings be replaced if there is any cracking for semi-tractor and trailers only. This does not apply to recreation vehicles.

! **WARNING:** Failure to maintain the brakes in proper working condition as specified in the manual supplied by the axle manufacturer will cause property damage, personal injury, and possibly death. Consult with your independent, authorized dealer for assistance.

Hydraulic Brake Maintenance and Lubrication

- Lubricate the hitch ball with standard automotive grease.
- Remove the master cylinder fill cap (Fig. 42) and ensure that it is full of automotive brake fluid.
- Check and adjust the brakes at least once per year. Consult your individual brake owner's manual for additional information or consult your independent, authorized dealer regarding this item.

Caution: Check the fill cap before each trip for tightness. A loose cap can allow moisture to contaminate the brake fluid.

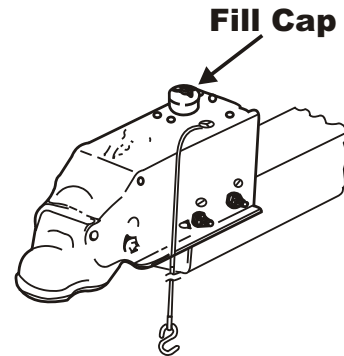

Fig. 42

TIRES

Your trailer tires are specifically manufactured for recreation vehicle use. Make sure you understand the specific needs of RV tires. Consult with your tire supplier, independent, authorized dealer or the tire manufacturer for complete information and maintenance instructions. Basic guidelines for your tires are also listed in this manual's "Before You Travel..." chapter.

Rear Bumper Spare Tire Carrier

The optional spare tire for your unit is mounted on the rear bumper.

TO REMOVE THE TIRE FROM THE TIRE CARRIER

1. Remove the lug nuts holding the tire in place.
2. Pull the tire from the tire carrier.

TO INSTALL THE TIRE ON THE TIRE CARRIER

1. Place the tire on the tire carrier .
2. Install the lug nuts.
3. Make sure the lug nuts are tightened securely before returning to travel.



Fig. 43

Changing Tire

1. Keep the trailer attached to the tow vehicle. Block the tire on the opposite side of the unit from the tire you are changing.
2. Loosen the wheel lug on the tire you are changing before jacking up the trailer. DO NOT remove the lug nuts, only loosen them for ease of removal when the tire is off the ground.
3. Locate the main frame rail of the trailer. It spans from the front to the back just inside the tires.
4. To raise the trailer, place the jack (hydraulic or screw) under the main frame rail. It must be just ahead of the front tire or just behind the rear tire.



WARNING: Never raise the trailer by placing the jack under the axle beam, springs or any attachment parts. Failure to comply could result in property damage, personal injury or death.

Vinyl Tire Cover (Option)

Your tires are manufactured with components that cause “bleeding” onto the tire cover. To prevent this, it is recommended to use a separator (garbage bag, paper, cloth, etc.) between the tire and the cover.

CLEARANCE LIGHTS

Inspect all exterior lights to make sure they do not have moisture trapped inside. The “weep” holes at the bottom of the lights must be kept open to allow moisture to escape from the light fixture.

DOORS, EXTRUSIONS & VENTS

Locks on entrance and baggage doors need biannual lubrication. Silicone lubricant is recommended. Conditions such as rain, salt, dust and pollution may increase the maintenance needs.

ABS PLASTICS

Various components of your trailer are made of ABS plastic, which is light, strong and rust proof. A few suggestions are given here to ensure long cap life.

- Wash ABS plastic with detergent and water, followed by a water rinse. Always mix the detergent with the water before washing. If you squirt detergent directly on the cap, you may discolor the cap.
- Do not wax ABS plastic. Excess wax will be trapped in the textured surface finish. The wax will trap dirt.
- Do not apply any product containing petroleum, as oil softens the plastic. Examples of products to avoid are bug and tar remover, mineral spirits or similar solvents, motor oil, charcoal lighter or any industrial cleaner that contains petroleum distillates.
- Abrasive cleaners will dull the surface and may rub through the weatherproof outer covering. When the cover is damaged, the plastic may yellow and become brittle.

Caution: Avoid using “Citrus” or biodegradable cleaners which contain “D-Limonene.” They will damage plastic materials.

BED

Bed Slides

Lubricate the bed slides two times each year. Use only a silicone spray to avoid attracting dirt and soiling the bed mats.

Bed Braces

Inspect the bed braces prior to each camping trip. Never use the braces if they are bent or damaged.

HEATED BED MATS

Caution: Do not use dry cleaning fluid on this bedding. Cleaning solvents may have a deteriorating effect on the insulation of the heating element.

Unplug the unit first. Wipe gently or blot the soiled area, using a damp cloth treated with a mild detergent. DO NOT IMMERSE. Allow to dry thoroughly before plugging in for use.

FABRIC COMPONENTS

Your folding camping trailer is a combination of several fabric components used to enclose the living area. The canvas used to construct the bunk end and side panels is made of 10.10 ounce army duck cotton, treated to pass the required Federal Fire Retardant Standards. The folding camping trailer awning (refer to awning definition) is made of an embossed vinyl with textile backing. On the interior of the folding camping trailer tent, the material is a 100% polyester backing. The following definitions will assist you in providing the proper care for your folding camping trailer tent components.

Definitions

INTERIOR

1. Bed mat - Upholstery covered foam mattress which provides softness to the bed extensions.
2. Cushions - Upholstery covered foam pad used in the dinette area for your comfort.
3. Upholstery - Fabric used to cover the interior cushions and bed mats of the folding camping trailer.
4. SoftShades™ - Window covers with a valance used to help create privacy for your camping experience.
5. Privacy Curtains - Fabric panels provided between bed extensions and the folding camping trailer area to provide a “bedroom” area.

EXTERIOR

1. Awning - Top or “roof” part of the folding camping trailer tent that is located over the bed extensions.
2. Window Panels - Side and end panels of the folding camping trailer which are made of canvas or charcoal vinyl with a zip down section to provide light and ventilation through an attached “screen” panel.
3. Tent - Complete assembly of the folding camping trailer “soft” wall and roof areas. The tent is made up of the awning and the window panels.
4. Canopy - Added feature to create a shaded area around your folding camping trailer door for outside enjoyment.
5. Screen Room - Available feature to enhance the canopy area by providing an added “room” to your folding camping trailer. This “room” is attached to the canopy and the camper.

FABRIC CARE

Cushions/Bed Mats

Please use common sense and treat your furniture as you would at home. Remember, your folding camping trailer is a small living area, so soiling may occur more frequently and the fabric will probably need more attention than your furniture at home. Please follow these guidelines for cleaning upholstery fabrics on the cushions/bed mats.

Frequent vacuuming with a brush attachment or a light hand brushing will help remove dust, hair, sand and other particles which may dull the look of the fabric and accelerate wear.

Water base cleaners are recommended. If a spill does occur, blot up the spot, but do not rub it in. Solvents are not recommended since they may have an adverse reaction to the specific backing of your upholstery fabric. Do not saturate the area. Clean it in a well ventilated area and avoid products containing toxic materials. Always pre-test a small area before proceeding. Use a professional furniture cleaning service for an overall cleaning.

A reminder: The upholstery fabrics have been manufactured using quality materials. However, if abused, they are not completely resistant to damage.

Caution: Do not dry clean the covers of the cushions/bed mats. If the covers are dry cleaned, the vinyl will become hard and crack.

SoftShades™

SoftShades™ should be dry cleaned by a professional for best results. However, they may be washed in cool water on the delicate cycle. Line dry only.

Caution: Care must be taken to follow the above instructions or results may not be satisfactory.

Tents

Caution: The tent fabric of your folding camping trailer is a mildew resistant fabric. This does not, however, mean that it is mildew proof. Priority in taking proper care of your tent will help to prolong its life. For warranty coverage, it is imperative that you read and follow the listed recommendations in this manual and all related literature.

Proper care and maintenance are important for the life of your folding camping trailer's tent. Be aware that the canvas portion of the tent will take longer to dry than the vinyl. If you are forced to store the tent wet, we recommend that the camping trailer be set up at the earliest possible convenience and left for several days to dry completely. After the tent is dry, brush all dirt and debris from the fabric, taking care in corners and crevices. Make sure the entire tent is completely dry before refolding it and storing the camping trailer. We recommend the following list of suggestions to adhere to when there is a need to clean the tents.

Exterior

- If the tent becomes dirty, use a damp cloth or sponge with water. **Do not use detergents, soaps or solvents since they may remove water repellency, fire retardants and damage the surface or color.**
- Do not use aerosol type cleaners.
- Do not use insect repellent, hair sprays or suntan lotions around the fabrics as they may stain them and damage or destroy the water repellency. If accidental contact occurs, apply a fabric protector or utilize a professional to provide water repellent treatment.
- Be sure to clean bird droppings, tree sap, dirt and soot from campfires off of the tent.
- **Assure that your canvas and trailer have good ventilation, especially after a rainy period. The most common cause of a damaged canvas is mildew, which is the result of storing your unit for any period of time with a damp or wet canvas, even for short periods. This is even more important in humid climates. If the tent must be stored wet, open the unit and allow it to dry thoroughly as soon as possible.**
- For the vinyl awning, use only non-abrasive cleaners with warm water and a sponge to remove excess dirt and grime. Do not use cleaners with a bleach ingredient. Chlorine or bleach will strip the finish and color from your vinyl.
- If water seepage occurs in the seams of the vinyl awning, you may want to apply a spray type water sealant on sewn seams.

Interior

The material used on the interior of the tents is a 100% polyester backing. This material contains inhibitors that help prevent the growth of mildew on the fabric. **It is not mildew-proof.** Mildew or fungus may attach to the material, however, the material will aid in preventing the growth. If mildew does attach itself to the fabric, brush the mildew dust with a soft bristle brush making sure there is plenty of ventilation and air circulation. Using a mild soap and water solution, thoroughly clean the area. Rinse with clean water.

Caution: Use of bleach or products containing bleach could potentially damage the tent material causing it to rot away. If such products are used, make sure that the cleaning is followed by several thorough rinses with clean water.

Condensation

Condensation can be prevalent in folding camping trailers if proper ventilation is not used. It can exist whether or not a heater is used. During periods of rain, avoid contact with the tent. The natural body oils in skin

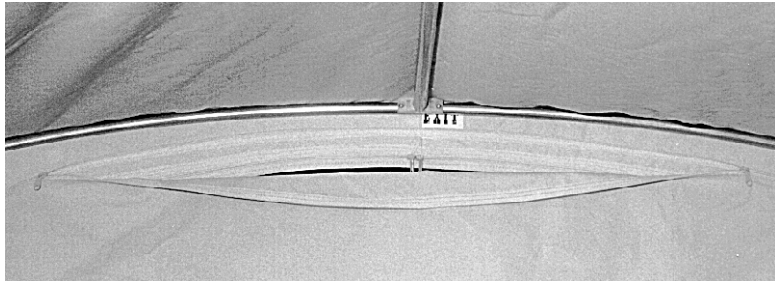

Fig. 44

will neutralize the tent waterproofing and cause the rain to soak through. We recommend that you leave a small opening (Fig. 44) in each bunk zipper to permit air to flow through and allow the tent to “breathe.” This will help minimize moisture gathering above the bunk area on the vinyl.

Use only breathable fabric camper covers, such as those available through your independent, authorized dealer, when storing your camping trailer.

Canopy

Heavy rain can damage both the canopy fabric and the poles if it is allowed to “pocket” on the fabric. It is very important to have the correct slope in the canopy. The side of the canopy at the twist poles should be about 19” lower than the side that is attached to the awning rail on the roof. If heavy rain is anticipated, lower one side to allow adequate run off.

The canopy is to be removed for winter storage due to winter condensation accumulation. ALWAYS roll up your canopy dry. If you ever need to roll up the canopy when it is wet, unroll it within 24 hours and allow it to dry. Mildew will develop on damp and wet canopies.

Be sure to follow the list of Do’s and Don’ts below when caring for your canopy.

DO...

- ...Keep your canopy clean. This is the best protection against mildew. Even on mildew resistant fabric, mildew can grow on accumulated dirt or foreign materials which remain on the top or bottom surface. This will eventually damage or stain the fabric. We cannot be responsible for such damage.
- ...Wash down your canopy; brushing lightly with a cloth or soft brush.
- ...Hose your canopy down occasionally (every month) with a garden hose. We recommend doing this on a hot, sunny day.
- ...Keep the underside of your canopy clean by simply brushing it with a clean household broom. The underside can be washed in the same manner as the top.
- ...Keep shrubbery and vines away from the canopy, as many bushes contain acid which can be harmful.

DO NOT...

- ...Fold or roll in extreme cold temperatures.
- ...Drag your canopy across any abrasive surfaces, such as a cement drive.
- ...Get insect spray on the fabric, as some solutions may impair the water repellency of the fabric and cause staining.
- ...Allow water to stand on the canopy, causing pocketing and possible stretching.
- ...Wash your canopy with a harsh strong solution, or scrub too vigorously with an abrasive cleaner.
- ...Force or yank your canopy when raising or lowering it. Do it gradually.
- ...Charcoal grill underneath the canopy.
- ...Store the canopy when it is damp or wet. Mildew is a fabric's greatest enemy and is caused by dampness. Mildew may grow on the surface of a damp canopy and permanently stain the fabric.
- ...Permit leaves, twigs, etc. To remain on your canopy as they might cause a staining of the fabric.
- ...Wrap steel or aluminum hardware with the canopy.

Screen Room

Care should be taken when setting up and putting the screen room away to avoid tears and cuts. When putting away the deluxe screen room, the curtains should be in the down position and secured to the bottom with their strings.

1. Wash off any droppings or foreign matter from trees with clear water and keep the vinyl clean when putting away.
2. DO not roll stakes or hardware with the screen room.
3. Never roll the vinyl screen room up wet for any extended period of time.
4. If mildew is apparent, it should be treated promptly with a light solution of Naphtha soap and water. A soft brush or cloth is recommended for cleaning vinyl.

FIBERGLASS SCREENING

When possible, the fiberglass screening should be loosely folded, not crushed when opening and putting away the screen room. Do not allow poles and stakes to punch holes in the screen.

PANELING

The wall paneling in your trailer is a vinyl covered wood panel. If deep scratches occur, putty sticks can be used to cover them. These can be obtained from hardware stores and lumber yards. For decor paneling, replacement vinyl covering can be purchased for repairs if needed. Your independent, authorized dealer's parts department can assist you with this.

To clean, use a mild solution of soap and lukewarm water with a soft sponge or cloth. DO NOT use abrasive cleaners. It could cause the vinyl to scratch and turn dull. Grease spots and stubborn dirt can be cleaned off with an all-purpose spray cleaner.

VINYL FLOOR

To care for the vinyl floor covering, use a damp mop with water and a mild cleaner. DO NOT SOAK FLOORING.

Caution: To avoid problems of “yellowing” linoleum, the manufacturer recommends to avoid using cleaners that contain oil based solvents (i.e. cleaners containing lemon oil, Murphy’s Oil Soap, etc.).

COUNTERTOPS

Glass rings, food spills, water spots and smudges usually wipe off with a damp sponge. Stubborn stains can be removed with a general purpose spray cleaner. Some stains can be removed by squeezing fresh lemon juice over the stain and allowing the juice to soak for approximately forty-five minutes. After forty-five minutes, sprinkle baking soda over the lemon juice and rub with a soft cloth.

Hot pots and pans should be placed on hot pads. Never place a hot iron or lighted cigarettes on the countertop.

For lasting beauty, avoid using harsh abrasives, scouring powders, peroxide or bleaches. These may dull the surface making it more susceptible to staining.

HARDWARE AND SINK OR SHOWER FIXTURES

Use mild dish soap and water to clean these fixtures. Never use harsh chemicals or sprays. A mild solution of vinegar and water works well to remove hard water spots and stains from the sink or shower fixtures.

FURNACE MAINTENANCE

Preventive maintenance and safety checks should be performed by a qualified technician at least once a year, or more, depending on the use of the furnace. Failure to properly maintain the furnace may void the furnace warranty and can result in unsafe furnace operation. Preventive maintenance is NOT covered under the warranty. Power should be disconnected before servicing. Refer to the furnace manufacturer’s supplied instructions for information regarding the furnace and its maintenance.

(N) NOTE: To increase motor life, the furnace should be wired directly to the battery.

AIR CONDITIONER

If you have an air conditioner that was installed by your independent, authorized dealer, consult the information supplied by the air conditioner manufacturer for maintenance information.

PROPANE SYSTEM

Your propane system is designed to function properly with regular maintenance and inspection. Make sure that you regularly check for any propane leaks as outlined in the safety information in this manual, as well as any appliance manufacturer’s supplied information. It is recommended that you have your system inspected at least annually by a qualified independent, authorized dealer or propane supplier.



DANGER: DO NOT smoke while changing cylinders or working on your propane system. See the use, danger and warning instructions throughout this manual for the propane system.

Propane Cylinders

1. The propane cylinder must be painted with a light color, such as white or silver plate, to reflect heat and light.
2. Rust, scratches, and/or dents can affect the safety of the cylinder. The D.O.T. requires that a visual inspection be made prior to each filling.
3. Any cylinder that has been exposed to fire, leaks or appears to be damaged should not be refilled.
4. A propane cylinder must always be placed in an upright position. Assure that the cylinder is secured in place prior to moving the vehicle.
5. The D.O.T. requires that propane cylinders be inspected, certified and labeled when they are twelve years old. (The number of years for certification may vary in your area.) Following the initial twelve-year period, the cylinder must be certified every five years.
6. The valve of the cylinder must be CLOSED at all times except when it is connected to the recreation vehicle propane system or is being refilled.
7. Inspect the cylinder at regular intervals. If there is a problem, have it evaluated by a qualified technician and discard it, if necessary. Verify with your local propane dealer that all required inspections and certifications have been completed on the propane cylinder within the correct time period before refilling the cylinder.

CARBON MONOXIDE (CO) DETECTOR

Maintenance and testing information for your carbon monoxide (CO) detector are supplied by the CO detector manufacturer. Make sure you read, understand and follow all instructions and safety requirements to maintain the unit's proper operation. If you have questions, consult with your independent, authorized dealer and/or contact the CO detector manufacturer.



WARNING: If the CO detector is not maintained and functioning properly according to the CO detector manufacturer's supplied instructions, you will not be warned if CO is present in the air. Death or serious illness could result from asphyxiation (inability to breathe) if CO is present.

MAINTENANCE CHECKLIST

This list is a quick reference sheet for suggested areas of regular maintenance. Make sure that you review all literature supplied with your trailer by the various component manufacturers. To perform maintenance items as suggested here, refer to specific information found in literature supplied with your unit from component part manufacturers and in this manual.

Prior to First Trip

- Check propane lines for leaks.
- Test propane, smoke and carbon monoxide detectors.
- Sanitize fresh water system.
- Check wheel nuts at specified intervals to listed torque values. Re-torque as needed. Refer to the axle manufacturer's manual.
- Open all windows and the door and start the furnace. Leave the windows and door open and the furnace on until the odor from the initial use of the furnace is fully dissipated.

First Two-Hundred Miles

- Check wheel nuts at specified intervals to listed torque values. Re-torque as needed. Refer to the axle manufacturer's manual.
- Have brakes adjusted by a qualified service technician.

Each Trip

- Check propane lines for leaks.
- Test propane, smoke and carbon monoxide detectors.
- Check battery water level. (If equipped with battery.)
- Check tire pressure and wear. Make sure the tires are cold when checking the tire pressure.
- Check running lights.
- Inspect safety chains for signs of wear.
- Test brakes.
- Flush out water heater tank.

After Every Tire Change

- Tighten wheel nuts to specified torque values at 10, 25 and 50 miles (16, 40, and 80 kilometers) to assure that they are correctly "seated" after the tire change. Refer to the axle manufacturer's manual.

Daily

- Recharge battery after each use.
- Ensure propane detector operation light is green in color.

Weekly

- Check propane lines for leaks.
- Test propane, smoke and carbon monoxide detectors.
- Check tire pressure and wear. Make sure tires are cold when checking the tire pressure.

Monthly

- Clean and lubricate the coupler.
- Check fire extinguisher pressure. Refer to the fire extinguisher label for specific instructions.
- Test the ground fault circuit interrupter (GFCI)

Every Three Months or 3,000 Miles

- Compare water heater pilot flame with ideal flame. Refer to the water heater owner's manual for ideal flame. Have cleaned and adjusted as necessary by a qualified technician.
- Compare refrigerator pilot flame with ideal flame. Refer to the refrigerator owner's manual for ideal flame. Have cleaned and adjusted as necessary by a qualified technician. (RV type refrigerator only)
- Inspect refrigerator door seals.
- Inspect refrigerator combustion seals. Have cleaned and adjusted as necessary by a qualified technician. (RV type refrigerator only)
- Check propane lines for leaks.
- Inspect propane cylinders for rust, pits, gouges, scrapes or sharp dents. Repaint cylinders if rust is present.
- Drain and sanitize fresh water system.
- Check, clean, tighten and lubricate battery cables.
- Check wheel nuts at specified intervals to listed torque values. Re-torque as needed. Refer to the axle manufacturer's manual.
- Examine the tires for unusual wear, sidewall defects from possible cuts, bulging and abrasions.
- Lubricate tongue jack.
- Lubricate hitch ball.
- Have brakes adjusted by a qualified service technician.

Every Six Months or 6,000 Miles

- Clean drains with approved drain cleaners.
- Check pipe connections for tightness. Tighten if necessary.
- Lubricate all moving parts on the entrance steps.
- Lubricate entrance and baggage door locks.
- Clean and lubricate stabilizer jacks.
- Inspect wheels for cracks, dents or distortion.
- Inspect and reseal your trailer as defined earlier in this chapter.
- Have suspension system serviced by a qualified service technician.
- Perform routine preventative maintenance on entire trailer and all component parts.

Every Year or 12,000 Miles

- Lubricate moving parts on the awning hardware. (Awning option only.)
- Manually operate the pressure-temperature control lever on the water heater.
- Clean city water entry strainer.
- Check demand tank vent for obstructions.
- Check water pump connections and mountings for tightness.
- Rotate fluorescent tubes in the light fixtures.
- Replace battery on the carbon monoxide detector. (if applicable)
- Have propane system inspected and serviced by a qualified technician.
- Have the refrigerator inspected and serviced by a qualified technician.
- Have brakes inspected and serviced by a qualified technician.
- Repack wheel bearings.
- Have furnace inspected and serviced by a qualified technician.
- Inspect and reseal your trailer as defined earlier in this chapter.
- Perform routine preventative maintenance on entire trailer and all component parts.

Every Five Years

- Replace propane and carbon monoxide detectors.

STORING YOUR UNIT...

Depending upon your area and where your unit is stored, your camper may be a target for damage from rodents and insects. To protect your camper, never leave food inside the unit and ensure that all surfaces are clean. You may want to place rodent control products in the unit during periods of storage. Mice and other rodents can do a tremendous amount of damage to the tent, drapes, cushions, etc. particularly during the winter months. Storing units in fields make them particularly inviting to rodents. Periodically inspect your unit during storage and seal off any areas which can offer an entry point to rodents or insects. Please remember to remove any screens or tape you have used to seal openings before you use the camper again. Special interest publications, such as articles and books offered through TL Enterprises (Trailer Life, Motorhome, etc.) can offer additional and practical advice on the proper storage of your camper. Damage from rodents or insects is not covered under your Jayco Limited Warranty.

(N) NOTE: When storing your trailer, it is recommended that the battery be unhooked to avoid draining the battery.

STORAGE CHECKLIST

Prior to Storage

(N) NOTE: If storing for the winter, be sure all winterizing steps are followed. Refer to winterizing section.

- Drain and flush all holding tanks; fresh water, gray water, black water and hot water tanks. (if applicable)
- Drain all water lines.
- Close the propane cylinder valve(s). If your cylinders do not already have a cover, purchase at least a vinyl propane cylinder cover. Make sure the regulator is covered.
- Disconnect 120-volt electric power to the RV.
- Remove all batteries from the RV and store in a place where they won't freeze. Batteries that have been frozen will never hold a proper charge.
- Check your roof and other surfaces to ensure there is no damage and potential leakage that might otherwise go unnoticed until it is too late.
- Inspect and reseal your trailer as defined in the "Maintaining Your Investment..." chapter of this manual.
- Turn off 12-volt/120-volt/propane to the refrigerator; defrost and clean. Use crumpled newspaper or open boxes of baking soda in the refrigerator to eliminate odors during storage.
- Remove all perishable items from the interior. Include in this any items that are susceptible to freezing, if storing during the winter months.
- Cover all external outlets, such as furnace, exhaust, etc. to prevent "critters" from entering.
- Thoroughly wash the interior and the exterior of your RV.
- Close all windows and roof vents.

- Cover tires that are exposed to sunlight to prevent weather checking and other UV damage.
- Cover the roof air conditioner.
- Store your RV indoors, under a roof or purchase a tarp to cover your RV during storage. Make sure you invest in a good tarp that can “breathe.”
- Turn all cushions on edge to prevent the entrapment of moisture/mildew during long term storage.
- Do not use hydraulic leveling jacks during storage.

During Storage Period

- Remove snow loads from the top of your RV to prevent damage to the unit’s structure.

Caution: Excessive snow, 8" or more, or ice, 2" or more, places excessive weight on roof. Remove excessive snow or ice as needed. Care MUST be exercised to not damage the roof material when removing snow & ice. Excessive weight can damage the roof, seals, etc. Water leaks and poor fit or operation are the results of this damage.

CAMPING TRAILER COVERS

Use only breathable fabric camper covers, such as those available through your independent, authorized dealer, when storing your folding camping trailer.

Caution: DO NOT store the camping trailer under a dark colored cover. Use only light colored breathable covers to prevent extreme heat. Consult with your independent, authorized dealer for the proper products to use.

WINTERIZING

Preparing your recreation vehicle for winter is very important for most states and Canada. Failure to prepare the trailer will cause the supply lines and the water heater to freeze causing breakage. Repairs due to freezing are not covered under the terms of your Jayco Limited Warranty.

Please keep in mind that your trailer was not designed for use during sub-freezing weather.

There is no commodity or product that can be added to the fresh water system to ensure freeze protection while the system is in use, other than RV antifreeze. Do not drink water that contains antifreeze. This includes non-toxic RV antifreeze.



WARNING: Do not use Ethylene Glycol (automotive antifreeze) or Methanol (windshield washer antifreeze) in your fresh water system. They are harmful to the water system and may be fatal if swallowed.

Demand Or Power Plumbing Systems (Fig. 45)

1. Drain all tanks and fresh water lines by opening the tank drain valve V3 & V4. The tank drain is outside of the left front corner of the camper. Also open all faucet valves for air to replace the water space. The lines may not drain completely if the faucets are not open.
2. Close valve V3 & V4.
3. Close Valve V1 to prevent anti-freeze from entering the tank.
4. Open valve V2 and insert the siphon hose into a container full of non-toxic RV anti-freeze.
5. Start the demand pump to circulate anti-freeze throughout the system.

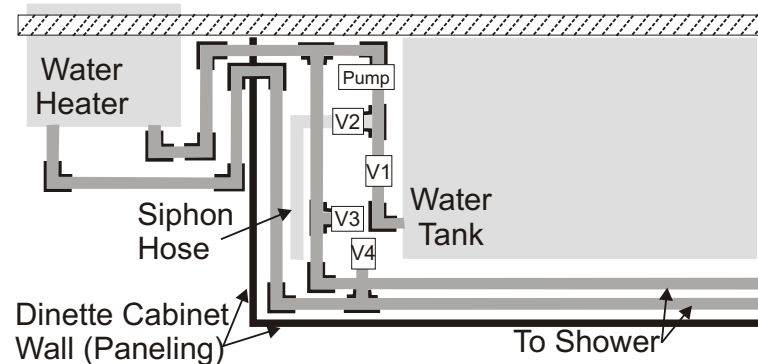

V1 = Valve that isolates water tank system
 V2 = Valve to siphon hose
 V3 & V4 = Low point drain valves

Fig. 45**Drain Traps**

Since all water can not be drained from the sink and optional shower trap assemblies, pour one (1) pint of non-toxic anti-freeze into the traps.

Cassette Toilet (With Bath/Shower Option Only)

If your trailer is equipped with the optional cassette toilet, refer to the toilet manufacturer's supplied instructions for winterizing the cassette toilet. If you have questions, consult your independent, authorized dealer or the toilet manufacturer's website at www.thetford.com.

INDEX

A			
ABS Plastics	84	Brakes	
Additional Considerations-Baja	41	breakaway	
Additions	19	electric	36
Air Conditioner		hydraulic	37
maintenance	90	electric	35
prep	58	electric brake controller	36,72
Aluminum Exterior	79	hydraulic.	36
Appliances		maintenance	82
furnace.	56	Breakaway	
ice box	55	and auxiliary battery.	70
microwave.	56	electric brakes	36
oven	55	hitching	30
range.	55	hydraulic brakes.	37
refrigerator	55	unhitching	42
stove	55	Bumper - Rear	25
water heater	56	C	
Awning		Canadian Standards Association.	1
definition	86	Campsite Selection	41
Axle Maintenance	82	Canopy	
B		campsite selection	41
Backing Your Trailer-hydraulic brakes	37	definition	86
Baja		maintenance	88
additional considerations	41	set up	49
camp set up	42	Carbon Monoxide Detector	
front deck	25	maintenance	91
loading ramps	25	safety	17
Battery		Cargo Capacity	23
auxiliary	36,70,71	Cargo Carrying Capacity	23
auxiliary - propane related	68	Cassette Toilet	
charger.	72	operation.	57
tow vehicle	35	winterizing	97
trailer	36	Caution	
BBQ Grill Prep and Operation	59	personal injury related - definition	15
Bed		property related - definition	15
brace maintenance.	85	Changes, Modifications and Additions.	19
dinette to bed conversion	51	Changing Tire	84
heated mat		Checklist	
maintenance	85	departing camp	75
operation	50	maintenance	92
mat definition	85	pre-travel	38
mat maintenance.	86	storage	95
slide maintenance	85	City Fill Connection	52
Biodegradable Toilet Paper	62	Clearance Lights	84
Booth Dinette.	51	Closing Your Trailer	47
		Cold Weather Use	20
		Condensation	21,88

H	M
Heated Bed Mats	Maintenance 79
maintenance 85	checklist 92
operation. 50	exterior 79
Hitch 29	Master Cylinder Fill Cap 83
ball size 30	Microwave 56
coupler	Mildew Prevention & Removal 87
hitching. 30	Modifications 19
unhitching 42	N
coupler maintenance 81	National Highway Transportation Safety
dolly wheel 30	Administration 15
height specifications. 30	Note - definition 15
hitching procedures 30	O
sway control 29	Outside Shower. 57
tongue jack 82	Oven 55
weight distributing 29	Owner's Responsibility. 13
hitching. 30	P
unhitching 42	Paneling 89
Holding Tank	Parts Ordering 13
draining 77	Plumbing 61
weight of full tank 26	Potable Water System
Hydraulic Brakes 36	sanitizing 61
backing your trailer 37	Power Cord 69
breakaway protection 37	Power Surges 52,68
lubrication 83	Privacy Curtains 85
maintenance 83	Propane 62
master cylinder maintenance 83	BBQ grill 59
I	checking for leaks 16
Ice Box 55	connections 54
Insurance 21	consumption. 67
L	container
Leaking Tent 37	servicing & filling 64
Leveling Trailer 43	correcting a leak. 17
Lifter System	cylinder
maintenance 81	components of 63
Light Bulbs 72	description 63
Limited Warranty Transfer	hook up. 66
definition 3	installing 64
form 10	maintenance 91
Linoleum 89	detector 68
Load Capacity-Roof 26	freeze up. 67
Loading Cargo 24	if you smell propane. 63
Loading Ramps-Baja 25	leak test 16
Low Point Drains. 61	main supply hose 67
Lugs	maintenance 90
maintenance 82	OPD overfill protection 65
proper torquing 34	

Tire 33
 changing 84
 covers 84
 pressure 33
 safety 20
 spare 83
 Toilet 57
 winterizing 97
 Toilet Paper 62
 Tongue
 jack maintenance 82
 weight 24
 Tow Rating 28
 Tow Vehicle 28
 battery 35
 brake controller 36
 Towable Limited Warranty
 definition 3
 Towing
 behind your RV 32
 your RV 32
 Trailer
 additions 19
 battery 36
 changes 19
 cover 96
 frame 81
 hitch plug 72
 hitching 30
 leveling 43
 modifications 19
 set up 42
 unhitching 42
 weight & holding tank 26
 weight information label 23
 Trailer Weight Information Label 23
 Transport Canada/Road Safety 15

U

Unhitching 42
 Unloaded Vehicle Weight 23
 Upholstery 85
 Utility Hookups 51

V

Vacuum Breaker 57
 Vinyl Floor 89

W

Warning - definition 15
 Warranty
 extended transferable warranty
 definition 3
 extended transferable warranty form 7
 limited warranty transfer application
 definition 3
 limited warranty transfer application
 form 10
 registration & customer delivery
 definition 3
 registration & customer delivery form 9
 towable transferable warranty
 definition 3
 towable transferable warranty form 4
 Warranty Registration & Customer Delivery
 definition 3
 form 9
 Washing Trailer 79
 Waste Water
 disposal 53
 draining 76
 Water
 campsite selection 41
 city fill connection 52
 demand pump 53
 draining fresh water 61
 filter cartridge 57
 heater 56
 hook up 52
 pressure regulator 53
 safety 18
 seepage 37
 waste water disposal 53
 water tank usage 52
 Water Seepage in Tent 37
 Weighing Instructions 27
 Weight
 BBQ grill capacity 60
 capacity 23
 capacity rating 24
 cargo carrying capacity definition 23
 distributing hitch 29
 gross axle weight rating 23,24
 gross combination weight rating 23,24,28

gross vehicle weight		Wheel	
rating	23,24,26,27,28,29	bearings	82
of full holding tanks	26	lugs	34,82
tongue weight	24	torque requirements	34
unloaded vehicle weight.	23	Winch Maintenance	81
Weight Capacity	23	Window Panels	86
Weight Distributing Bars		Winterizing	96
hitching	30	demand plumbing system	97
unhitching	42	water purification system	58
		Wire Harness	36

Free Manuals Download Website

<http://myh66.com>

<http://usermanuals.us>

<http://www.somanuals.com>

<http://www.4manuals.cc>

<http://www.manual-lib.com>

<http://www.404manual.com>

<http://www.luxmanual.com>

<http://aubethermostatmanual.com>

Golf course search by state

<http://golfingnear.com>

Email search by domain

<http://emailbydomain.com>

Auto manuals search

<http://auto.somanuals.com>

TV manuals search

<http://tv.somanuals.com>