

# Encore Presentation System



## User's Guide

- Manual # 26-0313000-00
- Revision 04



---

# Encore Presentation System • User's Guide

## Copyright

© Barco, Inc. February 5, 2010

All rights reserved. No part of this document may be copied, reproduced or translated. It shall not otherwise be recorded, transmitted or stored in a retrieval system without the prior written consent of Barco.

## Notice

Barco provides this manual "as is" without warranty of any kind, either expressed or implied, including but not limited to the implied warranties or merchantability and fitness for a particular purpose. Barco may make improvements and/or changes to the product(s) and/or the program(s) described in this publication at any time without notice.

This publication could contain technical inaccuracies or typographical errors. Changes are periodically made to the information in this publication; these changes are incorporated in new editions of this publication.

## Federal Communications Commission (FCC) Statement

This equipment has been tested and found to comply with the limits for a class A digital device, pursuant to Part 15 of the FCC rules. These limits are designed to provide reasonable protection against harmful interference when the equipment is operated in a commercial environment. This equipment generates, uses, and can radiate radio frequency energy and, if not installed and used in accordance with the instruction manual, may cause harmful interference to radio communications. Operation of this equipment in a residential area may cause harmful interference, in which case the user will be responsible for correcting any interference.

## Guarantee and Compensation

Barco provides a guarantee relating to perfect manufacturing as part of the legally stipulated terms of guarantee. On receipt, the purchaser must immediately inspect all delivered goods for damage incurred during transport, as well as for material and manufacturing faults. Barco must be informed immediately in writing of any complaints.

The period of guarantee begins on the date of transfer of risks, in the case of special systems and software on the date of commissioning, at latest 30 days after the transfer of risks. In the event of justified notice of complaint, Barco can repair the fault or provide a replacement at its own discretion within an appropriate period. If this measure proves to be impossible or unsuccessful, the purchaser can demand a reduction in the purchase price or cancellation of the contract. All other claims, in particular those relating to compensation for direct or indirect damage, and also damage attributed to the operation of software as well as to other services provided by Barco, being a component of the system or independent service, will be deemed invalid provided the damage is not proven to be attributed to the absence of properties guaranteed in writing or due to the intent or gross negligence or part of Barco.

If the purchaser or a third party carries out modifications or repairs on goods delivered by Barco, or if the goods are handled incorrectly, in particular if the systems are commissioned operated incorrectly or if, after the transfer of risks, the goods are subject to influences not

agreed upon in the contract, all guarantee claims of the purchaser will be rendered invalid. Not included in the guarantee coverage are system failures which are attributed to programs or special electronic circuitry provided by the purchaser, e.g. interfaces. Normal wear as well as normal maintenance are not subject to the guarantee provided by Barco either.

The environmental conditions as well as the servicing and maintenance regulations specified in this manual must be complied with by the customer.

## Trademarks

Brand and product names mentioned in this manual may be trademarks, registered trademarks or copyrights of their respective holders. All brand and product names mentioned in this manual serve as comments or examples and are not to be understood as advertising for the products or their manufactures.

---

## Company Address



**Barco, Inc.**  
11101 Trade Center Drive  
Rancho Cordova, California 95670  
USA

- Phone: (916) 859-2500
- Fax: (916) 859-2515
- Website: [www.barco.com](http://www.barco.com)

**Barco N.V.**  
Noordlaan 5  
8520 Kuurne  
BELGIUM

- Phone: +32 56.36.82.11
- Fax: +32 56.35.16.51
- Website: [www.barco.com](http://www.barco.com)

### Technical Support

- Tech Line: (866) 374-7878 — 24 hours per day, 7 days per week
- E-mail: [folsomsupport@barco.com](mailto:folsomsupport@barco.com)

---

## Operators Safety Summary

The general safety information in this summary is for operating personnel.

### Do Not Remove Covers or Panels

There are no user-serviceable parts within the unit. Removal of the top cover will expose dangerous voltages. To avoid personal injury, do not remove the top cover. Do not operate the unit without the cover installed.

### Power Source

This product is intended to operate from a power source that will not apply more than 230 volts rms between the supply conductors or between both supply conductor and ground. A protective ground connection by way of grounding conductor in the power cord is essential for safe operation.

### Grounding the Product

This product is grounded through the grounding conductor of the power cord. To avoid electrical shock, plug the power cord into a properly wired receptacle before connecting to the product input or output terminals. A protective-ground connection by way of the grounding conductor in the power cord is essential for safe operation.

### Use the Proper Power Cord

Use only the power cord and connector specified for your product. Use only a power cord that is in good condition. Refer cord and connector changes to qualified service personnel.

### Use the Proper Fuse

To avoid fire hazard, use only the fuse having identical type, voltage rating, and current rating characteristics. Refer fuse replacement to qualified service personnel.

### Do Not Operate in Explosive Atmospheres

To avoid explosion, do not operate this product in an explosive atmosphere.

---

## Terms In This Manual and Equipment Marking



### WARNING

Highlights an operating procedure, practice, condition, statement, etc., which, if not strictly observed, could result in injury to or death of personnel.

### Note

Highlights an essential operating procedure, condition or statement.



### CAUTION

The exclamation point within an equilateral triangle is intended to alert the user to the presence of important operating and maintenance (servicing) instructions in the literature accompanying the appliance.



### AVERTISSEMENT!

Le point d'exclamation dans un triangle équilatéral signale à alerter l'utilisateur qu'il y a des instructions d'opération et d'entretien très importantes dans la littérature qui accompagne l'appareil.



### VORSICHT

Ein Ausrufungszeichen innerhalb eines gleichwinkligen Dreiecks dient dazu, den Benutzer auf wichtige Bedienungs- und Wartungsanweisungen in der dem Great beiliegenden Literatur aufmerksam zu machen.

---

## Change History

The table below lists the changes to the Encore Presentation System User's Guide.

**Table 0-1.** Change History

Rev	Date	ECP #	Description	Approved By
A	12/10/04	1360	Released	R. Pellicano
B	10/24/06	1704	Updated features and menus	R. Pellicano
03	1/22/10	575245	Updated features and menus	R. Pellicano
04	2/5/10	575810	Updated features and menus	R. Pellicano

# Table of Contents

<b>Chapter 1</b>	<b>Introduction</b> .....	<b>17</b>
	Software Version .....	18
	Chapter Structure .....	18
	How to Use This Guide .....	19
	Navigating .....	19
	Table of Contents and Index .....	19
	General Instructions .....	19
	Conventions .....	20
	Terms and Definitions .....	20
	System Overview .....	22
	Advanced Video Processing .....	22
	Encore Features .....	23
	The Encore Video Processor .....	24
	Input Flexibility .....	24
	Scaling and Keying .....	25
	Output Flexibility .....	25
	A Word About Layers .....	26
	A Word About Destinations .....	27
	Effect Combinations .....	28
	Single Mixer Effects .....	28
	Dual Mixer Effects .....	30
	Triple Mixer Effects .....	31
	Integration with Signal Routers .....	32
	Event Management .....	32
	Configuration Applications .....	33
	Encore Configurator .....	33
	Barco Backup and Restore Utility .....	33
	Product Differentiation .....	34
	New Feature Review .....	35
	Software Version 1.24 Features .....	35
	Software Version 1.22 Features .....	36
	Software Version 1.19 Features .....	38
<b>Chapter 2</b>	<b>Hardware Orientation</b> .....	<b>43</b>
	In This Chapter .....	43
	Video Processors .....	44
	Video Processor Front Panel .....	44
	VPx Front Panel .....	45
	Video Processor Rear Panel .....	45
	VPx Rear Panel .....	48
	A Word About M/E Connector Priority .....	50
	M/E Connectors (VP) .....	52
	M/E Connectors (VPx) .....	54

## Table of Contents

M/E Input Notes . . . . .	56
Program Output Notes . . . . .	57
Analog Input Flexibility . . . . .	57
Controller Rear Panels . . . . .	58
<b>Chapter 3</b>	<b>Hardware Installation . . . . . 61</b>
In This Chapter . . . . .	61
Safety Precautions . . . . .	62
Unpacking and Inspection . . . . .	62
Site Preparation . . . . .	62
Rack-Mount Installation . . . . .	62
Cable and Adapter Information . . . . .	63
Installation . . . . .	64
Single Screen Configuration . . . . .	65
Triple Screen Configuration . . . . .	68
Wide Screen Configuration . . . . .	72
Wide Screen Configuration Plus Wide Screen Preview . . . . .	76
Completing Wide Screen Preview Setup . . . . .	78
Single Screen Stack Configuration . . . . .	80
Wide Screen Stack Configuration . . . . .	84
Connection Charts . . . . .	89
Connection Overview . . . . .	89
Chart Instructions . . . . .	90
Sample Connection Charts . . . . .	91
Blank Connection Charts . . . . .	92
Router I/O Charts . . . . .	92
Direct Encore Input Chart . . . . .	96
Encore Destination Chart . . . . .	97
Program and Source Link Connections . . . . .	98
Overview of Edge-Blending Technology . . . . .	98
Content Creation . . . . .	98
Video Processing . . . . .	100
Projector Setup and System Adjustments . . . . .	101
Connecting Program and Source Links . . . . .	102
Left Justified Configuration . . . . .	102
Center Justified Configuration . . . . .	104
<b>Chapter 4</b>	<b>Controller Orientation . . . . . 107</b>
In This Chapter . . . . .	107
Controller LC Front Panel . . . . .	108
Controller SC Front Panel . . . . .	111
Use of Color . . . . .	113
Controller Sections . . . . .	114
Touch Screen Section . . . . .	115
System Keypad . . . . .	117
Alphanumeric Keypad . . . . .	119
Joystick Section . . . . .	120
Machine Control Section . . . . .	122
Console Lighting . . . . .	122
Preset Section . . . . .	123



## Table of Contents

Destination Bus . . . . .	125
Source Selection Bus . . . . .	126
Layer Control Section . . . . .	128
Layer Functions Section . . . . .	131
Live Switch Section . . . . .	134
Transition Section . . . . .	135
Group Control Section . . . . .	137
Program Preset Section . . . . .	139
Layer/Aux Control Section . . . . .	140
Transition Functions Section . . . . .	142
User Key Section . . . . .	144

## Chapter 5

### Menu Orientation . . . . . 145

In This Chapter . . . . .	145
Conventions in this Chapter . . . . .	146
Global Rules . . . . .	146
Home Menu . . . . .	147
Input Menu . . . . .	148
Input Menu Tree . . . . .	148
Input Menu Description . . . . .	149
Input Menu Functions . . . . .	150
Input Sub Menus . . . . .	153
Input Configuration Menu . . . . .	153
Aspect Ratio Menu . . . . .	154
Sizing Menu . . . . .	155
1:1 Sizing Menu . . . . .	155
Oversample Sizing Menu . . . . .	156
Color Balance Menu . . . . .	157
Output Menu . . . . .	158
Output Menu Tree . . . . .	158
Output Menu Description . . . . .	159
Output Menu Functions . . . . .	160
Output Sub Menus . . . . .	160
Enhanced Output Menu . . . . .	161
Enhanced Output Settings Menu . . . . .	162
Enhanced Output Test Pattern Menu . . . . .	163
Genlock Menu . . . . .	164
Settings Menu . . . . .	165
Test Pattern Menu . . . . .	166
Wide Screen Settings Menu . . . . .	167
Wide Screen Settings Menu (H Array) . . . . .	168
Wide Screen Settings Menu (V Array) . . . . .	169
Feather Setup Menu . . . . .	171
System Menu . . . . .	172
System Menu Tree . . . . .	172
System Menu Description . . . . .	173
System Sub Menus . . . . .	174
System Reset Menu . . . . .	175
Software Version Menu . . . . .	176
Diagnostics Setup Menu . . . . .	177
Widescreen Link Diagnostics Menu . . . . .	178

## Table of Contents

Rotary Encoder Menu . . . . .	179
TBar & Joystick Menu . . . . .	180
Key Detect Menu . . . . .	181
Destination Setup Menu . . . . .	182
Aux Setup Menu . . . . .	184
Network Setup Menu . . . . .	187
Input Source Patch Menu . . . . .	188
Router Specification Menu . . . . .	190
Comm Setup Menus . . . . .	191
Ethernet Setup Menu . . . . .	191
RS-232 Setup Menu . . . . .	192
Lantronix Setup Menu . . . . .	193
Output Patch Menu . . . . .	194
Miscellaneous Menu . . . . .	196
Miscellaneous Menu Tree . . . . .	196
Miscellaneous Menu Description . . . . .	197
Miscellaneous Sub Menus . . . . .	198
Console Port Setup Menu . . . . .	198
Lockout Code Menu . . . . .	199
EDID DVI Input Format Menu . . . . .	200
Video Processors ID Definition Menu . . . . .	202
LCD Settings Menu . . . . .	203
User Preference Menu . . . . .	204
Backup/Restore Menu . . . . .	206
Current Backup Menu . . . . .	207
Preset Recall Options Menu . . . . .	208
Effects Menu . . . . .	209
Copy Setup Menu . . . . .	210
User Key Copy Setup Menu . . . . .	211
Status Menu . . . . .	212
PIP Adjustment Menu . . . . .	213
PIP Adjustment Menu Tree . . . . .	213
PIP Adjustment Menu Description . . . . .	214
PIP Adjustment Menu Functions . . . . .	214
PIP Joystick Functions . . . . .	215
PIP Adjustment Sub Menus . . . . .	215
Clone Setup Menu . . . . .	216
Border Menu . . . . .	218
Shadow Menu . . . . .	219
Image Effects Menu . . . . .	220
Custom Border Menu . . . . .	222
Key Menu . . . . .	224
Key Menu Tree . . . . .	224
Key Menu Description . . . . .	225
Key Menu Functions . . . . .	225
Luma Key Functions . . . . .	226
Color Key Functions . . . . .	226
Cut + Fill Key Functions . . . . .	227
Key Sub Menus . . . . .	228
Matte Menu . . . . .	228
Key Adjustment Menu . . . . .	229
Key Joystick Functions . . . . .	230

## Table of Contents

Crop Menu .....	231
Source Adjustment Menus .....	232
Source Adjustment Menu Trees .....	233
Source Adjustment Menu Description .....	234
Source Adjustment Menu Functions .....	235
Source Joystick Functions .....	236
Background Input Setup Menu .....	237
Background Input Setup Menu Tree .....	238
Shared Background Menu Functions .....	239
Background Menu Functions — Matte Type .....	240
BG Matte Menu .....	241
Background (and DSK) Menu Functions — DVI Type .....	242
Background (and DSK) Menu Functions — Analog Type .....	243
Background (and DSK) Menu Functions — FG Type .....	244
Frame Grab Menu .....	245
Frame Grab Menu Tree .....	245
Frame Grab Overview .....	246
Frame Grab Menu Description .....	246
Frame Grab Sub Menus .....	247
Frame Grab Name Menu .....	248
Frame Erase Menu .....	249
Frame Save Menu .....	250
Frame Delete Menu .....	251
Frame Recall Menu .....	252
DSK Menus .....	253
DSK Menu Tree .....	253
DSK Adjustment Menu .....	254
DSK Luma Key Functions .....	254
DSK Color Key Functions .....	255
DSK Input Setup Menu .....	257

## Chapter 6 System Setup.....259

In This Chapter .....	259
Setup Prerequisites .....	260
System Setup Sequence .....	261
ID Setup and Remote Enable .....	262
Peripheral Power Up and Status Check .....	264
Downloading Code .....	265
Return to Factory Default .....	266
Touch Screen Calibration .....	267
Programming EDID .....	268
Restore from Flash Memory Card .....	269
Router Setup .....	270
D/A Setup .....	274
Input Patching .....	275
Destination Setup .....	277
Standard and Stack Destination Setup .....	277
Vertical Blend Setup .....	278
ScreenPRO-II Destination Setup .....	279
ScreenPRO-II with EOC .....	280
AUX Destination Setup .....	281

## Table of Contents

Aux Destination Overview . . . . .	281
Aux Destination Setup . . . . .	282
ImagePRO or PrePRO-II Aux Destination Setup . . . . .	283
Aux Destination Setup Notes . . . . .	284
Output Format Setup . . . . .	285
Sync Setup . . . . .	286
Genlock Setup . . . . .	287
Projector Setup . . . . .	288
Single Screen Projector Setup . . . . .	288
Wide Screen Projector Setup . . . . .	289
Background Setup . . . . .	291
Input Setup . . . . .	293
Input Setup — Quick Start . . . . .	293
Input Setup — Comprehensive Method . . . . .	293
Input Setup Notes . . . . .	296
DSK Setup . . . . .	296
Saving the Setup . . . . .	299
Back up System . . . . .	300

## Chapter 7

<b>Operations . . . . .</b>	<b>301</b>
In This Chapter . . . . .	301
Prerequisites . . . . .	302
Operational Configuration . . . . .	303
Monitor Layout . . . . .	303
Touch Screen Calibration . . . . .	305
Wide Screen Markers . . . . .	305
Lookahead Preview . . . . .	306
Understanding Raster Boxes . . . . .	307
A Word About LOS . . . . .	308
Setting User Preferences . . . . .	308
Understanding Input File Mapping . . . . .	309
Using the Alphanumeric Keypad . . . . .	310
Using the PS/2 Keyboard . . . . .	311
Working with Groups . . . . .	312
Learning a Group . . . . .	312
Adding or Removing Destinations from a Group . . . . .	313
Activating a Group . . . . .	313
Clearing a Group . . . . .	313
Unlearning a Group . . . . .	314
Group Notes . . . . .	314
Working with Destinations . . . . .	315
Activating and Deactivating Destinations . . . . .	315
Clearing Destinations . . . . .	315
Routing Sources to Aux Destinations . . . . .	316
Pending and Completing an Aux Route . . . . .	316
Live Switch Aux Routing . . . . .	317
Program/Preview Aux Routing . . . . .	317
Viewing Aux Routes . . . . .	318
Working with Layers . . . . .	319
Switching Sources . . . . .	319
Background Transitions . . . . .	320

# Table of Contents

Understanding Split and Mix Modes . . . . .	321
Split Mode . . . . .	321
Mix Mode . . . . .	321
Working with PIPs in Split Mode . . . . .	322
Working with PIPs in Mix Mode . . . . .	323
Modifying PIPs . . . . .	323
Working with Keys in Split Mode . . . . .	324
Working with Keys in Mix Mode . . . . .	325
Using Cut & Fill . . . . .	325
Modifying Keys . . . . .	326
Clearing Layers from Program . . . . .	327
Modifying Layers On Program . . . . .	328
Working with Layer Functions . . . . .	329
Changing the Layer Mode . . . . .	329
Using Full Screen . . . . .	329
Using Clone . . . . .	330
Using Swap Z-order . . . . .	330
Using Copy . . . . .	331
Using Shift Layers . . . . .	331
Using Freeze . . . . .	332
Using Black Preview . . . . .	332
Using Ext Trigger . . . . .	333
Using Source Preview . . . . .	333
Using Reset . . . . .	334
Using Join Mode . . . . .	335
Using Move . . . . .	336
Programming Moves . . . . .	336
Program a Move on Preview . . . . .	336
Program a Move on Program . . . . .	337
Pending and Triggering Moves . . . . .	337
Pend on Preview . . . . .	337
Pend on Program . . . . .	338
Move Notes . . . . .	338
Working with Live Modes . . . . .	340
Using Live Switch Program/Preview Mode . . . . .	340
Using Live Switch Source Mode . . . . .	341
Live Mode Source Timing . . . . .	342
Working with Transitions . . . . .	343
Cut . . . . .	343
Mix . . . . .	343
Wipe . . . . .	344
Manual Transitions . . . . .	344
Working with Presets . . . . .	345
A Word About Resources . . . . .	345
Storing Presets . . . . .	346
Recalling Presets . . . . .	347
Deleting Presets . . . . .	347
Using Next and Previous . . . . .	347
Presets and Moves . . . . .	348
Preset Notes . . . . .	348
Layer and Aux Control . . . . .	349
Working with User Keys . . . . .	350

## Table of Contents

Storing User Keys . . . . .	350
Applying User Keys . . . . .	350
User Key Notes . . . . .	350
Working with Tallies . . . . .	351
Enable/Disable Controller Lockout . . . . .	352
Using Backup and Restore . . . . .	353
System Backup . . . . .	353
System Restore . . . . .	354
Working with Frame Grabs . . . . .	355
Frame Capture Overview . . . . .	355
Capturing Frames from a Background or DSK Input . . . . .	357
Capturing Frames from a Layer . . . . .	358
Saving Frames in Permanent Memory . . . . .	359
Naming a Saved Frame . . . . .	360
Erasing and Deleting Frames . . . . .	361
Working with the DSK . . . . .	362

## Appendix A Specifications . . . . .363

In This Appendix . . . . .	363
Input Specifications . . . . .	364
Output Specifications . . . . .	366
Physical and Electrical Specifications . . . . .	367
Communications Specifications . . . . .	368
Pinouts . . . . .	369
DVI Connector Pinouts . . . . .	369
DVI-I Connector Pinouts . . . . .	370
Analog 15-pin D Connector . . . . .	371
Ethernet Connector . . . . .	372
Serial Connector . . . . .	373
Tally Connector . . . . .	374
Input and Output Resolutions . . . . .	375
Input Resolutions . . . . .	375
Output Resolutions . . . . .	379

## Appendix B Contact Information . . . . .383

In This Appendix . . . . .	383
Warranty . . . . .	383
Return Material Authorization (RMA) . . . . .	383
Contact Information . . . . .	384

## Appendix C Upgrading Software . . . . .385

In This Appendix . . . . .	385
Software Upgrade Overview . . . . .	386
Hardware Requirements . . . . .	386
Software Requirements . . . . .	386
Downloading Software . . . . .	387
Via FTP Site . . . . .	387

## Table of Contents

	Via Web Site . . . . .	387
	Serial Upgrade Method. . . . .	388
	Ethernet Upgrade Method . . . . .	390
	Troubleshooting Ethernet Communication . . . . .	391
<b>Appendix D</b>	<b>Working With Destinations . . . . .</b>	<b>393</b>
	In This Appendix. . . . .	393
	ScreenPRO-II Configurations. . . . .	393
	Internal Router Configuration. . . . .	394
	External Serial Router Configuration . . . . .	395
	External Ethernet Router Configuration. . . . .	396
	External Serial and Ethernet Router Configuration . . . . .	397
	PresentationPRO-II Aux Configuration. . . . .	398
	ImagePRO Aux Configuration . . . . .	399
<b>Appendix E</b>	<b>Application Notes . . . . .</b>	<b>401</b>
	In This Appendix. . . . .	401
	Encore Controller to Router Connections. . . . .	402
	EXT COMM Pinouts . . . . .	403
	Cable Connection — Straight Through . . . . .	404
	Cable Connection — Null Modem . . . . .	405
	Lantronix Ethernet to Serial Cable Connection . . . . .	406
	Router Connection Table. . . . .	407
	Router Interface Notes . . . . .	409
	Extron Router Support. . . . .	409
	DVILink and DPI Router Support. . . . .	409
	Sierra Video Systems Router Support. . . . .	409
	Leitch Router Support . . . . .	409
	FSR Router Support . . . . .	410
	AutoPatch Router Support. . . . .	410
<b>Index</b>	<b>. . . . .</b>	<b>411</b>

## Table of Contents



# 1. Introduction

This chapter is designed to introduce you to the Encore Presentation System. Areas to be covered are:

- [Software Version](#)
- [Chapter Structure](#)
- [How to Use This Guide](#)
- [Conventions](#)
- [Terms and Definitions](#)
- [System Overview](#)
- [New Feature Review](#)

**Note**

Once you have reviewed all of the sections in this chapter, please continue with Chapter 2, "[Hardware Orientation](#)" on page 43.

# 1. Introduction

Software Version

---

## Software Version

This version of the Encore User's Guide is based on **software version 1.24**. All new features in this version (and all previous versions) are listed in the ["New Feature Review"](#) section on page 35.

---

## Chapter Structure

The following chapters provide instructions for all aspects of Encore Presentation System operations:

- Chapter 1, ["Introduction"](#) provides a system overview, and a list of important new features in this version of the User's Guide.
- Chapter 2, ["Hardware Orientation"](#) on page 43 explains the Encore Presentation System's Video Processor (and VPx) hardware in detail.
- Chapter 3, ["Hardware Installation"](#) on page 61 provides comprehensive system installation instructions.
- Chapter 4, ["Controller Orientation"](#) on page 107 describes each section of the system's two controllers — the models LC and SC.
- Chapter 5, ["Menu Orientation"](#) on page 145 explains the system's configuration, setup and adjustment menus, and provides basic menu "navigation" procedures.
- Chapter 6, ["System Setup"](#) on page 259 outlines procedures for setting up and configuring the Encore Presentation System.
- Chapter 7, ["Operations"](#) on page 301 provides basic operating instructions.
- Appendix A, ["Specifications"](#) on page 363 lists the Encore Presentation System's input, output, video, mechanical and power specifications.
- Appendix B, ["Contact Information"](#) on page 383 lists important Barco contact, RMA, warranty and technical support details.
- Appendix C, ["Upgrading Software"](#) on page 385 provides a detailed procedure for upgrading Encore Presentation System software.
- Appendix D, ["Working With Destinations"](#) on page 393 outlines the steps required when Encore is connected to external destinations.
- Appendix E, ["Application Notes"](#) on page 401 provides important application-related information regarding system setup and operations.

---

## How to Use This Guide

Following are tips for streamlining your use of this User's Guide in its electronic "PDF" form.

### Navigating

Use Acrobat Reader's "bookmarks" to navigate to the desired location. All chapter files have the same bookmark structure for instant navigation to any section. Please note:



- Extensive hyperlinks are provided within the chapters.
- Use Acrobat's "**Go to Previous View**" and "**Return to Next View**" buttons to trace your complete navigational path.
- Use the "**Previous Page**" and "**Next Page**" buttons to go to the previous or next page within a file.
- Use Acrobat's extensive search capabilities, such as the "**Find**" tool and "**Search Index**" tool to perform comprehensive searches as required.

### Table of Contents and Index

Use the **Table of Contents** bookmarks to navigate a desired topic. Click any item to instantly jump to that section of the guide. You can also use the **Index** to jump to specific topics within a chapter. Each page number in the **Index** is a hyperlink.

### General Instructions

To ensure trouble-free installation, setup and operations, please follow all procedures as listed below:

- For an overview of all new features, refer to the "[New Feature Review](#)" section on page 35.
- For comprehensive hardware orientation, refer to Chapter 2, "[Hardware Orientation](#)" on page 43.
- For complete installation instructions, refer to Chapter 3, "[Hardware Installation](#)" on page 61.
- For details on both Encore Controllers, refer to Chapter 4, "[Controller Orientation](#)" on page 107.
- For a comprehensive review of all menus and menu trees, refer to Chapter 5, "[Menu Orientation](#)" on page 145.
- For system setup instructions, refer to Chapter 6, "[System Setup](#)" on page 259.
- For operating instructions, refer to Chapter 7, "[Operations](#)" on page 301.

Should you have any questions regarding the installation or operation of the Encore Presentation System, please consult with the factory. Refer to Appendix B, "[Contact Information](#)" on page 383 for contact information.

# 1. Introduction

## Conventions

---

## Conventions

The following conventions are used throughout this guide:

- The symbol ■ denotes an operations procedure.
- The symbol ▲ denotes an example.
- Entries written in bold-face letters denote physical Controller buttons or chassis (Video Processor) connectors.
  - ▲ Press **Split** to ...
- When two buttons together are required for an operation or function, the plus (+) sign is used between the buttons. This procedure requires that you hold down the first button, then press the second.
  - ▲ **Learn + 12** (hold down **Learn**, then press the button labeled **12**)
- Button labels on the **Touch Screen** are shown in bold uppercase letters between braces.
  - ▲ Press {**BORDER**} to ...

---

## Terms and Definitions

The following terms and definitions are used throughout this guide:

- A “**Background**” is an unscaled source (typically originating from a computer's multi-head graphics card), or a frame grab from a scaled source. Encore provides two background sources (**BG A** and **BG B**), each of which appears at the system's lowest priority — visually in back or underneath all other sources.
- A “**Destination**” is a location to which you can route the output of Encore. A destination can be configured as:
  - ~ a single screen (one projector)
  - ~ multiple screens (such as a wide screen application)
  - ~ an “**Aux**” destination (such as a monitor, a **PresentationPRO-II** or an **ImagePRO** system)
  - ~ an external processor (such as a **ScreenPRO-II**)
- A “**Key**” is an electronic (and visual) process whereby one image is electronically superimposed over another source or background. Keys are typically used for titles, logos, and banners.
- A “**Layer**” is an image display element (such as a PIP, Key or Background) that has an associated visual priority — either in front (or in back) of another layer.
- A “**Mixer**” is the electronic circuitry that enables you to transition (and scale) PIPs and Keys over a background.
- “**M/E**” (Mix/Effects) is synonymous with “**mixer**.” Each Encore M/E is capable of layering either two PIPs, two keys, or one of each.
  - ~ When discussing system hardware, the term “**M/E**” will be used to describe the Processor's physical input boards.

- ~ When discussing Encore operations, the term “**mixer**” will be used — specifically because the term “mixer” is silk-screened on the panel.

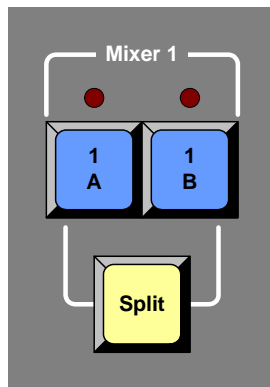


Figure 1-1. Mixer Label in the Layer Control Section

- “**Operator**” refers to the person who uses the system.
- “**PIP**” refers to Picture-in-Picture, an on-screen setup in which one picture (typically of reduced size) is positioned over another background image — or another PIP. PIPs can be reduced, enlarged, bordered, shadowed, and mixed on and off Program. PIPs can overlap each other, depending on their visual priority.
- A “**Preset**” is a register in which you can store (and recall) the entire Controller’s configuration or “look.” On the Controller LC, 900 presets are available. On the Controller SC, 64 are available. Dedicated “Preset” buttons are provided.
- “**Screen**” and “**Menu**” both refer to the Touch Screen menus.
- “**System**” refers to the Encore Presentation System.
- A “**Scaler**” is the electronic circuitry that enables you to reduce or enlarge source images, thus creating PIPs and Keys that can be positioned (and transitioned).
- Because the system supports two Video Processor models:
  - ~ “**VP**” refers to Video Processor, the system’s full-input Video Processor.
  - ~ “**VPx**” refers to the Video Processor chassis with a reduced set of inputs. VPx is used only for widescreen configurations, and a special widescreen “preview” configuration.

Refer to the “[The Encore Video Processor](#)” section on page 24 for details on each Video Processor.

## System Overview

The following topics are discussed in this section:

- [Advanced Video Processing](#)
- [Encore Features](#)
- [The Encore Video Processor](#)
- [A Word About Layers](#)
- [A Word About Destinations](#)
- [Effect Combinations](#)
- [Integration with Signal Routers](#)
- [Event Management](#)
- [Configuration Applications](#)
- [Product Differentiation](#)

## Advanced Video Processing

The Encore Presentation System is the most advanced video processing and presentation control system on the market today. The system provides source selection, windowing, seamless switching, video effects and integrated control for professional presentations. Encore's modular, scalable architecture allows the system to support a wide variety of show configurations. The system can efficiently support from 1-32 screens (or "destinations") with any combination of independent display or seamless wide screen display elements.

Encore incorporates universal inputs that accept both analog and digital video. Motion adaptive de-interlacing is provided for both standard and HD source video. Incoming video is processed by Barco Folsom's proprietary Athena scaler, which supports smooth real-time PIP (Picture-In-Picture) movements and re-sizing.

A fully-loaded Encore can support 12 independent PIP or Key images, or six transitioning PIP images. Seamless transition effects, Z-order control, borders, drop shadows and a variety of key effects are fully supported. Two un-scaled background channels provide a high resolution backdrop that also supports seamless transition effects. Downstream Key (DSK) effects are supported by a third un-scaled high-resolution input.

Two different Encore Controllers are offered:

- The **Encore Controller SC** supports 24 inputs and controls 1 to 6 destinations.
- The **Encore Controller LC** supports 64 inputs and controls 1 to 32 destinations.

Both controllers can control external routers for external source selection. The controllers can also be used with **Barco Events Manager** software to synchronize operation with external devices and to run pre-programmed sequences. Refer to the "[Event Management](#)" section on page 32 for more information on **Barco Events Manager**.

## Encore Features

Following is a detailed list of Encore features:

- Up to 12 independent windows or 6 windows with seamless transitions.
- Two native high resolution background channels provide background video underneath PIPs and Keys. Background transitions are standard.
- PIP effects, including:
  - ~ A full range of transitions, such as dissolves and wipes.
  - ~ Smooth moves, with keyframe-controlled sizing and positioning.
  - ~ Adjustable aspect ratio.
  - ~ Adjustable borders, including drop shadows and soft edge.
  - ~ Clone mode (mirror and offset).
- Keying effects, including:
  - ~ Luminance keys.
  - ~ Invert keys (key source luminance video inverted).
  - ~ Color keys (using absolute luminance values of Red Green And Blue).
  - ~ Split keys (key cut and fill).
  - ~ “Join” mode to lock mixer layers together (e.g., key cut and fill).
- One native high resolution Downstream Key (DSK) channel, independent of the PIP/KEY processing channels.
- Superior video processing:
  - ~ 10-bit processing, with 1:1 pixel sampling.
  - ~ Motion adaptive de-interlacing (SD & HD).
  - ~ 3:2 and 2:2 pull down detection.
  - ~ Image cropping and aspect ratio correction.
- Low video delay — less than 3 input fields.
  - ~ 60ms @ 50Hz
  - ~ 50ms @ 60Hz
- Athena proprietary high-performance scaling.
- Z-order control for assigning overlay priorities to each PIP or key.
- Dynamically re-assignable mixer layers:
  - ~ In **Mix** mode, a mixer’s two layers are ganged together.
  - ~ In **Split** mode, a mixer’s two layers operate independently.
- Frame grab “captures” still frames for use as backgrounds and downstream key sources, with internal storage of up to 100 frames.
- Complete lookahead preview.
- Blended wide screen projection support.
  - ~ 10-bit processing
  - ~ Variable overlap and edge blending (feathering)
- Multiple output sync modes: free-run or vertically locked to NTSC/PAL black burst.

# 1. Introduction

## System Overview

### The Encore Video Processor

The Encore Video Processor is a compact chassis that provides the Encore Presentation System's input and output circuitry. Two models are available:

- The "standard" Video Processor (**VP**) is a full-featured model that includes all input, output, genlock and link circuitry.
- The **VPx** is a VP with a reduced set of inputs (DVI only). The VPx is used for widescreen configurations, and a special widescreen "preview" configuration. VPx includes all output and link circuitry, no genlock circuitry, and only a small subset of the standard VP's input circuitry.

#### Important

In a widescreen configuration, a VPx cannot function in a standalone manner, but must always work *downstream* of a standard VP. Here, a VPx cannot be the first processor in an Encore configuration.

In the special widescreen "preview" configuration, a VPx *can* be used as a standalone destination that accepts DVI input signals only — but no other input types are accepted, and no genlock circuitry is provided.

Both units provide a 3RU rack-mount chassis that can be configured with one, two or three M/E (mixer) boards. One or two M/E systems can be upgraded with additional M/E boards.

#### Input Flexibility

Each M/E board provides two independent Athena scalers with universal inputs that handle both analog and digital video sources.

The figure below illustrates a block diagram of the VP's M/E.

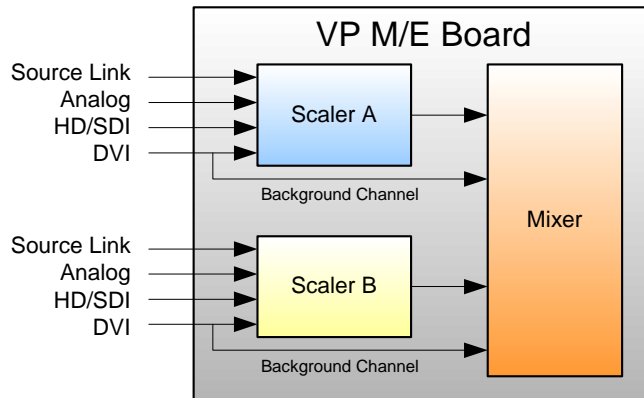


Figure 1-2. M/E Board Block Diagram, VP

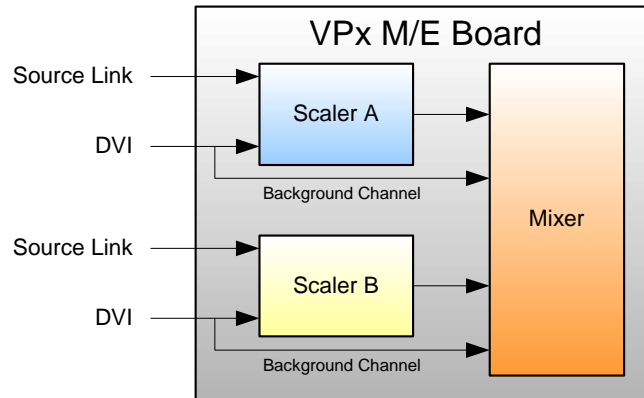
The VP accepts the following inputs:

- Standard component and composite analog video formats (NTSC, PAL, SECAM)
- SDI video
- Computer input resolutions up to 1920 x 1200 (analog or digital)
- Analog HD formats including 720p, 1080i, 1080p
- HD-SDI Video



- 2048 x 1080p Digital Cinema video
- Plasma display resolutions

The figure below illustrates a block diagram of the VPx's M/E.



**Figure 1-3.** M/E Board Block Diagram, VPx

The VPx accepts the following inputs:

- Computer input resolutions up to 1920 x 1200, via DVI

### Scaling and Keying

For both Processor models, the Athena scaler features the following:

- 1:1 pixel sampling
- Motion adaptive de-interlacing for both standard and high definition sources
- 3:2 and 2:2 pull down detection
- Aspect ratio correction and image cropping
- Real-time window resizing and positioning
- Full support for seamless transitions, window borders, drop shadows and keying

### Output Flexibility

Each Encore VP and VPx incorporates one output board, which provides all output interface functions as well as the blending and data-doubling functions required to support wide screen applications. Supported output resolutions include:

- Computer output resolutions up to 1600 x 1200
- Analog HDTV resolutions including 720p, 1080I, 1080p
- HD-SDI video
- 2048 x 1080p digital cinema video
- Plasma display resolutions.

Output synchronization is supported to lock the output frame rate to an externally applied NTSC/PAL black burst signal.

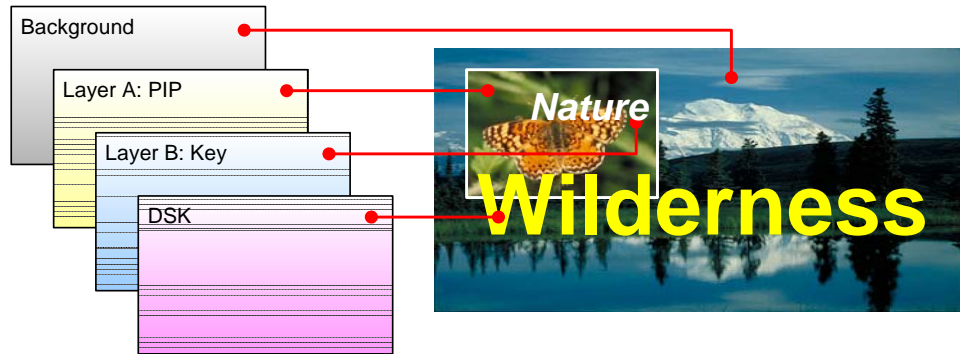
# 1. Introduction

## System Overview

### A Word About Layers

Within the Encore system, each mixer has two layers, **A** and **B**, and each can be assigned to either **PIP** or **Key** functionality.

A typical single mixer application (including the DSK) is illustrated below.

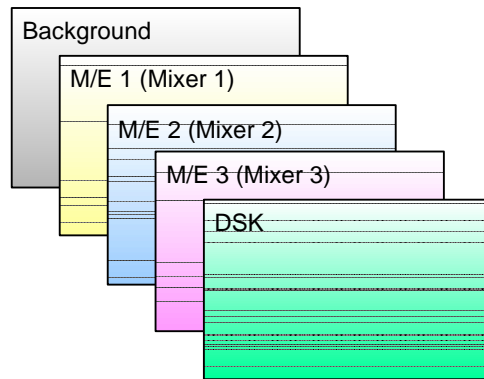


**Figure 1-4.** Layer Illustration — Background, Single Mixer + DSK

Please note the following important points:

- The **Downstream Key** (DSK) is the highest priority layer, using an unscaled DVI input or a scaled frame grab. The DSK visually appears over all other images (PIPs and keys) on all mixers.
- The high resolution **Background** layer has the lowest priority, using an unscaled DVI input or a scaled frame grab. This layer visually appears behind all other PIPs, keys, and the DSK. The system can transition between two background sources — both of which must be at the projector's native resolution.
- On any mixer, a **PIP** layer appears over backgrounds and under the DSK. Effects include mixes and wipes, smooth moves and resizing, adjustable aspect ratio, borders, drop shadows and soft edges, and PIP “clone” mode (mirror and offset).
- On any mixer, a **Key** layer also appears over backgrounds and under the DSK. Key effects include luminance keys, split keys (key alpha and fill), invert keys and color keys (graphics).
- Within a single mixer, layer **B** has priority over layer **A**, but you can change that priority as desired by pressing the **Swap Z-Order** button.
- On a triple mixer system, up to six inputs can be scaled to produce PIP or Key images that can be transitioned independently or in pairs.

- Between mixers, the hierarchy of priorities is easy:



**Figure 1-5.** Mixer Priority

- ~ The **Background** layer is always at the bottom.
- ~ All effects on **Mixer 1** are visually in front of the background.
- ~ All effects on **Mixer 2** are in front of Mixer 1.
- ~ All effects on **Mixer 3** are in front of Mixers 1 and 2.
- ~ The **DSK** is visually in front of Mixers 1, 2, 3 and background.

## A Word About Destinations

The Encore Presentation System offers complete flexibility with regard to destinations. Examples of each destination “type” are listed below:

- **Single Screen Destination** — this is a “single projector” destination that takes its input from a VP. A VPx can only be used as a single destination in a special widescreen “preview” configuration.
- **Wide Screen Destination** — this is a “multiple projector” destination that takes its inputs from two (or more) VP or VPx units.
- **ScreenPRO-II Destination** — this is a standalone ScreenPRO-II that takes its inputs via direct connections or routers. When the ScreenPRO-II output is connected to a “side” projector (or monitor), its “look” can be controlled from the Encore Controller as a unique destination.
- **Aux Destination** — this is a monitor that takes its input from a router output (in a single format). When you select an Aux destination and a source on the Controller, you are talking *directly* to a router output via RS-232 or Ethernet communications — and making the selected source-to-destination connection.
- **ImagePRO Aux Destination** — this is an ImagePRO that takes its input(s) from multiple routers in multiple formats. When connected to a monitor or projector, a scaled signal is provided in one format. Whereas an Aux Destination’s input is single format, an ImagePRO Aux Destination’s input is multi-format.
- **PresentationPRO-II Aux Destination** — this is a PresentationPRO-II that takes its input(s) from up to two routers — one analog and one SDI. When connected to a single monitor or projector, a scaled signal is provided in one format. The transition “type” between sources is selected on the PresentationPRO-II itself.

In Chapter 6, refer to the “[Destination Setup](#)” section on page 277 for details on standard destination setup procedures. Refer to the “[AUX Destination Setup](#)” section on page 281 for details on Aux destination setup procedures.

# 1. Introduction

## System Overview

### Effect Combinations

A fully-loaded Encore VP or VPx is a unit with three mixer (M/E) boards. A unit configured in this way can scale six input sources to create PIPs and/or Keys. These in turn can be sized and positioned on the screen in real-time.

This section illustrates the many (but not all) combinations of image effects that you can create on 1, 2 and 3 mixer systems. Please note:

- In the following illustrations, the specific layers used in creating each effect are labeled (e.g., **PIP 1A**, **PIP 1B**). For example, **1A** denotes the first PIP or key on Mixer 1, **1B** denotes the second PIP or key on Mixer 1, etc.
- The symbol  $\leftrightarrow$  denotes a PIP or a key that can transition. For example, PIP 2A  $\leftrightarrow$  2B indicates that you can dissolve between sources within the PIP.

The following topics are discussed:

- [Single Mixer Effects](#)
- [Dual Mixer Effects](#)
- [Triple Mixer Effects](#)

#### Single Mixer Effects

A single Mixer Encore system provides two backgrounds, two scalable layers in the Mixer plus an unscaled DSK. Please note:

- If the DSK is in use, the background cannot transition between A and B — it's all a matter of “available resources.”
- The DSK and backgrounds are unscaled, in all cases.

In Chapter 7, refer to the “[A Word About Resources](#)” section on page 345 for additional information.

- **Single Mixer Effect 1**

This effect includes a non-transitioning background (either A or B), one transitioning PIP and the DSK.

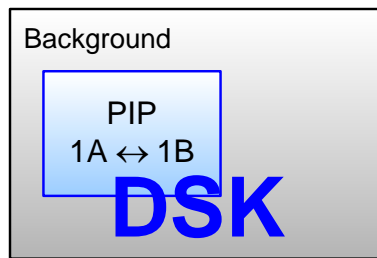


Figure 1-6. Single Mixer Effect 1 Diagram

- **Single Mixer Effect 2**

This transition is similar to effect 1, but because the DSK is not in use, the background can transition from source A to B, and the PIP can transition between layers A and B.

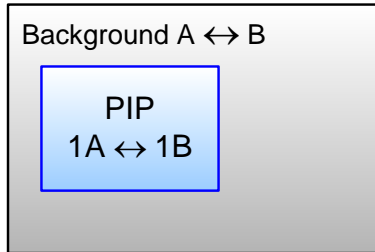


Figure 1-7. Single Mixer Effect 2 Diagram

- **Single Mixer Effect 3**

In this effect, because the DSK is in use, the background cannot transition. Here, you can independently fade (or cut) one scaled PIP and one scaled key, with complete size and position flexibility.

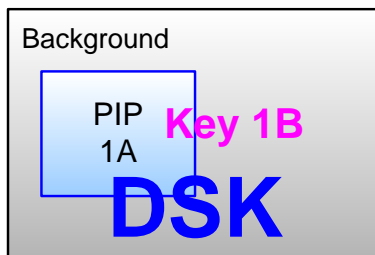


Figure 1-8. Single Mixer Effect 3 Diagram

- **Single Mixer Effect 4**

This transition is similar to effect 3, but because the DSK is not in use, the background can transition between sources A and B. You can also independently fade, cut, size and position both the PIP and the key.

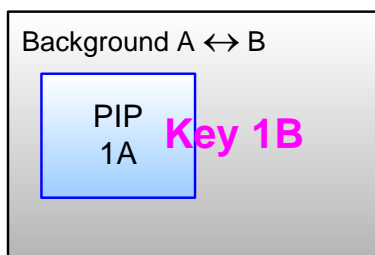


Figure 1-9. Single Mixer Effect 4 Diagram

# 1. Introduction

## System Overview

- **Single Mixer Effect 5**

In this effect, because the DSK is in use, the background cannot transition — you can use either A or B. Here, you can independently fade two scaled PIPs up and down — with or without the DSK on screen.

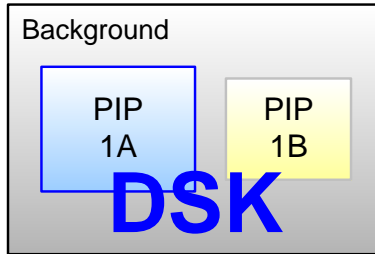


Figure 1-10. Single Mixer Effect 5 Diagram

- **Single Mixer Effect 6**

This transition is similar to effect 5, but because the DSK is not in use, the background can transition. You can also independently fade the two PIPs.

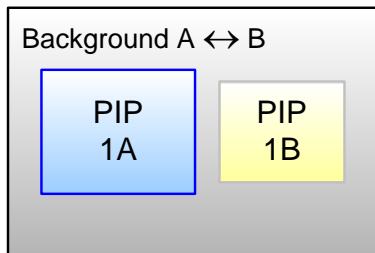


Figure 1-11. Single Mixer Effect 6 Diagram

## Dual Mixer Effects

A dual Mixer Encore system provides two backgrounds, a total of four scalable layers in the two Mixers, plus an unscaled DSK.

- **Dual Mixer Effect 1**

Using the capabilities of two Mixers, this effect enables you to transition backgrounds, in addition to transitioning the PIPs on both Mixer 1 and 2 — with or without the DSK on screen.

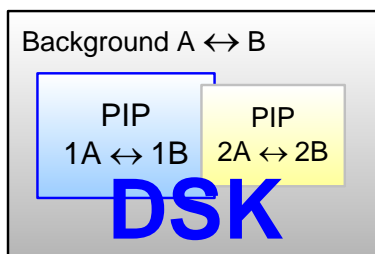
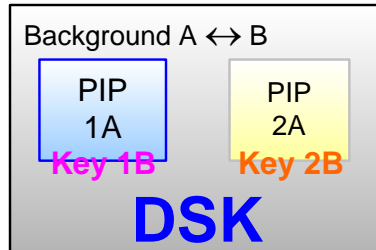


Figure 1-12. Dual Mixer Effect 1

- **Dual Mixer Effect 2**

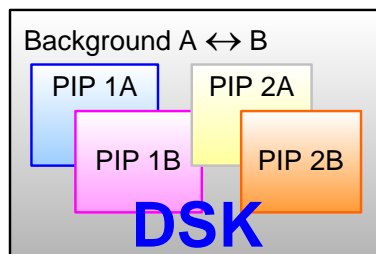
With this dual Mixer effect, you can transition backgrounds between sources A and B, plus independently size, position, cut or fade a PIP and key on each Mixer. Transitions within the PIPs cannot be performed. The DSK can be used without restriction.



**Figure 1-13.** Dual Mixer Effect 2

- **Dual Mixer Effect 3**

This effect enables you to transition between backgrounds, and size/position four PIPs on screen — with or without the DSK. In addition, any PIP could be substituted for a key, but transitions within a PIP (or transitions between keys) cannot be performed.



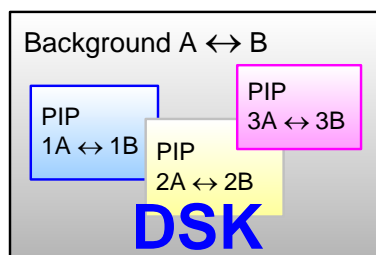
**Figure 1-14.** Dual Mixer Effect 3

### Triple Mixer Effects

A triple Mixer Encore system provides two backgrounds, a total of six scalable layers in the three Mixers plus an unscaled DSK.

- **Triple Mixer Effect 1**

With this three Mixer effect, you can transition between backgrounds, fade or cut the DSK as desired, and independently transition within three PIPs.



**Figure 1-15.** Triple Mixer Effect 1

# 1. Introduction

## System Overview

- **Triple Mixer Effect 2**

This effect enables you to transition between backgrounds sources, plus independently size, position, cut or fade a PIP and key on each of the three Mixers. Transitions within the PIPs or transitions between keys cannot be performed.

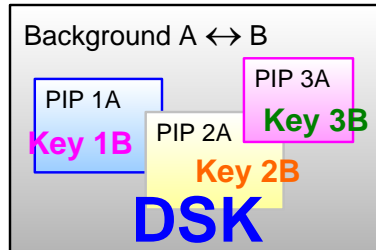


Figure 1-16. Triple Mixer Effect 2

- **Triple Mixer Effect 3**

Here, you can transition between backgrounds, and size/position six PIPs on screen — with or without the DSK. Any PIP can be substituted for a key, but transitions within PIPs (or transitions between keys) cannot be performed.

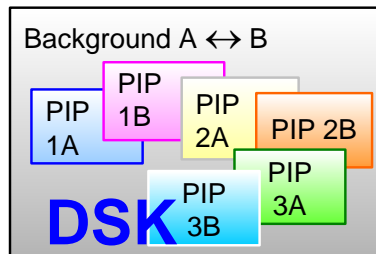


Figure 1-17. Triple Mixer Effect 3

## Integration with Signal Routers

The use of high quality routers (routing switchers) is an integral part of the Encore system. Barco offers a complete line of routers for use with Encore, including models in analog, SDI, HD/SDI and DVI formats. All of our routers are designed and tested to ensure quality, reliability, and ease of use.

Encore is also compatible with other manufacturers' routers. In Chapter 5, refer to the ["Router Specification Menu"](#) section on page 190 for details.

## Event Management

The Encore Presentation System is compatible with **Barco Events Manager** software, which complements Encore's real-time control by supporting enhanced external device control and sophisticated pre-programmed sequences. Please note:

- **Barco Events Manager** treats Encore as a peripheral device and sends commands to the controller to execute timeline programmed sequences. This allows Encore's functions to be fully integrated with other show effects.
- Because there is bi-directional communications between Barco Events Manager and Encore, the Encore system can also trigger the Events Manager software.



- The range of external devices that can be controlled is greatly increased, permitting users to automate entire shows. The Events Manager software also supports the management of digital media sources.

## Configuration Applications

Two configuration applications are available to assist with system setup, backup and restore functions.

- [Encore Configurator](#)
- [Barco Backup and Restore Utility](#)

### Encore Configurator

The **Encore Configurator** enables you to create basic Encore system setups offline. Using the Configurator, you can define wide and single screen parameters, router patching, basic input setup and basic destination setup. Once complete, the “configuration” can be sent to the Controller, saving overall setup time. The application also enables you to remotely access the Encore Configuration Loader.

### Barco Backup and Restore Utility

The **Barco Backup and Restore Utility** enables you to perform complete system backup and restore operations to a PC (or laptop) connected via Ethernet. Backup and restore functions include the Controller, the VP(s) and the VPx(s).

# 1. Introduction

## System Overview

### Product Differentiation

The table below illustrates the differences between the small (SC) and large (LC) Encore controllers.

**Table 1-1.** Product differentiation between SC and LC controllers

Feature	Small Controller (SC)	Large Controller (LC)
Encore VP and VPx supported	32	32
Wide screen support	Yes	Yes
External router control	Yes	Yes
Inputs supported	24	64
Destinations supported	6	32
Available presets	64	900
Layers supported	1 DSK 6 Scaled Inputs (PIP or Key) 1 Transitioning background	1 DSK 12 Scaled Inputs (PIP or Key) 1 Transitioning background
User-selectable transitions	Yes	Yes
Available groups	4	8
Available user-definable keys	None	100
Joystick and T-Bar	Yes	Yes
320 x 240 graphic displays	1	2
Light sticks	2	3
PS/2 keyboard support	Yes	Yes
Communication	Ethernet, RS-232	Ethernet, RS-232
Program sequencing	Yes	Yes
Field upgradable	Yes	Yes
Ethernet control interfaces	Yes	Yes
Tally support	8	8

---

## New Feature Review

This section lists the new features that have been implemented in recent versions of Encore software. Reference links are provided.

- [Software Version 1.24 Features](#)
- [Software Version 1.22 Features](#)
- [Software Version 1.19 Features](#)

### Software Version 1.24 Features

The following new features have been implemented in software version 1.24.

- **Stacked Configuration Support**

Stacked configuration support has been added to the Encore Controller SC.

- ~ In Chapter 3, refer to the "[Single Screen Stack Configuration](#)" section on page 80 for instructions on installing single screen stack configurations, and the "[Wide Screen Stack Configuration](#)" section on page 84 for instructions on wide screen stack configurations.
- ~ In Chapter 6, refer to the "[Standard and Stack Destination Setup](#)" section on page 277 for stack setup instructions.

- **Feature Enhancements**

The following feature and interface enhancements are provided in the version:

- ~ ImagePRO AUX transitions are now smooth when switching between any inputs routed to an ImagePRO. This feature requires ImagePRO software 2.43 or higher.
- ~ For analog NTSC and PAL inputs, the default sync slice is now 80mV. This change improves the system's ability to maintain a stable lock to video sources where signal integrity is less than ideal.
- ~ Support has been added for Grass Valley native protocol.
- ~ Programmable DVI output sync polarity adjustments have been added. In Chapter 5, refer to the "[Settings Menu](#)" section on page 165.
- ~ The following input and output resolutions have been added:
  - 1280x720 @60
  - 1280x720 II @60
  - 1280x800 @60
  - 1280x800 II @60
  - 1360x768 @60
  - 1440x900 @60, @75, @85
  - 1680x1050 @60
  - 1920x1080pSF @29.97, @30
  - 1920x1200 @50, @59.94, @60
  - 2048x1200 @59.94

In Appendix A, refer to the "[Input and Output Resolutions](#)" section on page 375 for a complete list of all input and output resolutions.

## Software Version 1.22 Features

The following features were implemented in software version 1.22.

- **Vertical Blending**  
Vertical Array blending is supported, and all cabling to the VP and VPx is the same as a standard widescreen setup. In Chapter 6, refer to the [“Vertical Blend Setup”](#) section on page 278 for instructions.
- **ScreenPRO-II EOC Support**  
When a ScreenPRO-II is used as a destination, Encore supports the Enhanced Output Card (EOC) option of the ScreenPRO-II. This option is a factory installed card that provides additional output formats, and expands the unit’s still store capabilities. In Chapter 6, refer to the [“ScreenPRO-II with EOC”](#) section on page 280 for instructions.
- **Enhanced ScreenPRO-II Routing**  
When a ScreenPRO-II is used as a destination, Encore supports the internal and external routing capability of the ScreenPRO-II. In Chapter 6, refer to the [“ScreenPRO-II Destination Setup”](#) section on page 279 for details.
- **Input Auto Acquire**  
By default, the Controller attempts to Auto Acquire an input as soon as the source is selected, provided it does not currently have a saved input config file. In Chapter 5, refer to the [“User Preference Menu”](#) section on page 204 for details.
- **Custom Borders**  
In the **Border Menu**, the **Custom Border Menu** enables you to select any pre-configured border style as a starting point, and then configure a custom border from a variety of parameters. In Chapter 5, refer to the [“Border Menu”](#) section on page 218 for details.
- **Preset Recall Options**  
From the **Home Menu**, the **Preset Recall Menu** enables you to select from a variety of preset recall options. In Chapter 5, refer to the [“Preset Recall Options Menu”](#) section on page 208 for details.
- **Mix, User Effect and User Trans Buttons**  
In the **Transition Functions** sections on both controllers, the **Mix**, **User Effect** and **User Trans (1, 2, and 3)** buttons have been implemented. In Chapter 4, refer to the [“Transition Functions Section”](#) heading on page 142 for details.
- **Patch Next**  
On the **Output Patch Menu**, the {PATCH NEXT} soft key enables you to enter output patch data quickly, provided that the physical output connections to the VP and VPx units have been performed logically. In Chapter 5, refer to the [“Output Patch Menu”](#) section on page 194 for details.
- **Previous Button**  
In the **Preset Section**, the **Previous** button has been implemented. In Chapter 4, refer to the [“Preset Section”](#) heading on page 123 for details.
- **New Routers Supported**  
Routers from FSR, AutoPatch and NVision are supported. In Chapter 5, refer to the [“Router Specification Menu”](#) section on page 190 for details.

- **Enhanced Source Preview**

The **Source Preview** function has been enhanced. After the button has been pushed for the first time, the next press sizes the PIP to 1:1, with respect to the source's input resolution. In Chapter 7, refer to the "[Using Source Preview](#)" section on page 333 for details.

- **900 Presets Fully Active**

All Presets starting with Page 15, Preset 1 (and above) can be saved, provided that an MMC or MMCPlus card (512MB or larger) is installed in the Controller's Multi-media card slot. In Chapter 7, refer to the "[Working with Presets](#)" section on page 345 for details.

- **Enhanced Events Manager Support**

Based on the support of 900 Presets, the "**Events Manager Support**" function on the **User Preference Menu** addresses a Preset Recall issue, when more than 500 Presets are saved in the Controller. In Chapter 5, refer to the "[User Preference Menu](#)" section on page 204 for details.

- **Widescreen Menu Shortcuts**

New shortcuts have been added between the **Test Pattern Menu** and the **Widescreen Menu**. In Chapter 5, refer to the "[Test Pattern Menu](#)" section on page 166 for details.

- **Stacked Configuration Frame Grab**

When Encore is functioning in a stacked configuration, Frame Grab captures have been disabled on the bottom M/E board of the top VP or VPx. This change is required because the background channels of the M/E board are in use to facilitate the transfer of data between processors. In Chapter 7, refer to the "[Working with Frame Grabs](#)" section on page 355 for details.

- **Numeric PIP Entry**

On the Large Controller, numeric entry of PIP size and position has been enhanced to allow you to enter numbers up to 8 digits in length. In Chapter 7, refer to the "[Using the Alphanumeric Keypad](#)" section on page 310 for details.

- **Joystick and T-Bar Calibration**

New tools are provided for calibrating the Joystick and T-Bar. In Chapter 5, refer to the "[Diagnostics Setup Menu](#)" section on page 177 for details.

- **VPx**

Support is provided for the VPx, a new processor with a reduced set of input circuits, for use in widescreen configurations, and special widescreen "preview" configurations. Refer to Chapter 2, "[Hardware Orientation](#)" on page 43.

**Note**

Software version 1.22 (or later) is required for VPx control.

- **Encore GC**

Support is provided for the Encore GC, a graphical user interface (GUI) designed to control the Encore and ScreenPRO-II processors without the need for an Encore LC or SC. The system also includes the ECU (Encore Control Unit), an advanced server that connects video processors, routers, and the PC (which runs the Encore GC) together. Refer to the "**Encore GC User's Guide**" for details.

- **Support for Lantronix UDS2100**

Support is provided for the Lantronix **UDS2100**, a serial-to-Ethernet device that replaces the **UDS200** — which Lantronix is phasing out. Both models will continue to be supported by Encore. In Chapter 3, refer to the [“Installation”](#) section on page 64 for details on using the Lantronix to connect two (or more) serial routers to Encore.

## Software Version 1.19 Features

The following features were implemented in software version 1.19.

- **Wide Screen Preview Configuration**

Instructions are provided for configuring a system with a fourth VP or VPx, which is then used to create a combined wide screen program/preview display. In Chapter 3, refer to the [“Wide Screen Configuration Plus Wide Screen Preview”](#) section on page 76 for details.

- **Live Switch Modes**

Two Live Switch modes are available:

- ~ The **Live Switch “Source”** mode turns both rows of the **Source Selection Bus** into a live “Program” bus. In Chapter 7, refer to the [“Using Live Switch Source Mode”](#) section on page 341.
- ~ The **Live Switch “Program/Preview”** mode turns both rows of the **Source Selection Bus** into a live “Program/Preview” bus. The top row acts as **Program**, and the bottom row acts as **Preview**. In Chapter 7, see the [“Using Live Switch Program/Preview Mode”](#) section on page 340 for details.

- **Tally Mapping**

Using the **Input Patch menu**, you can assign any of the eight available tallies to any input source. In Chapter 5, refer to the [“Input Source Patch Menu”](#) section on page 188 for details.

- **Invalid Video and LOS**

New methods have been implemented to handle invalid video signals and LOS (loss of video) conditions. In Chapter 5, refer to the [“User Preference Menu”](#) section on page 204, and in Chapter 7, refer to the [“A Word About LOS”](#) section on page 308 for details.

- **Wide Screen Definition Flexibility**

You can create wide screen destinations using VP or VPx units that do not contain the same number of M/E boards. In Chapter 6, refer to the [“Destination Setup”](#) section on page 277 for details.

- **Frame Grabs**

The **Frame Grab** button accesses the **Frame Grab Menu**, which enables you to store up to 100 frames. Frames can be captured from any layer (including the Background and DSK), for use on Program in either the Background or DSK channels. In Chapter 7, refer to the [“Working with Frame Grabs”](#) section on page 355 for details.

- **Destination Flexibility**

The Encore system offers comprehensive destination flexibility. In addition to standard single screen and wide screen destinations, you can configure **ScreenPRO-II** units as destinations, plus three types of Aux destinations:

standard **Aux** (monitors), **ImagePRO Aux** and **PresentationPRO-II Aux**. Refer to Appendix D, "[Working With Destinations](#)" on page 393 for details.

- **Support for VP or VPx IDs 17 - 32**

Using the **Miscellaneous Menu**, you can re-define VP or VPx IDs using numbers 17 - 32. Only processors that are *not* currently defined as destinations can be re-defined. In Chapter 5, refer to the "[Miscellaneous Menu](#)" section on page 196 for details.

- **External Trigger Function**

When Encore is used in conjunction with **Barco Events Manager**, the following functionality is provided:

- ~ Timeline tasks can be triggered when specific Presets are recalled.
- ~ Playback of a paused timeline can be resumed (using **Ext Trigger**).

In Chapter 7, refer to the "[Using Ext Trigger](#)" section on page 333 for details.

- **Wide Screen Link Diagnostics**

The **Diagnostics Menu** contains a **{LINKS}** softkey that accesses the **Wide Screen Link Diagnostics Menu**. This menu enables you to test the Program and Source link cables that are required for wide screen operation. In Chapter 5, refer to the "[Diagnostics Setup Menu](#)" section on page 177.

- **Third Party Router Support**

Additional third party routers are supported in the Encore Controller. In Chapter 5, refer to the "[Router Specification Menu](#)" section on page 190 for details.

- **Copy Function**

The copy function enables you to copy PIP and Key parameters between mixers. In Chapter 7, refer to the "[Using Copy](#)" section on page 331 for details.

- **Downstream Key (DSK)**

Encore's DSK function enables you to use an unscaled DVI source or a scaled frame grab as the downstream key. The **DSK Setup Menu** allows you to set up either a Luma or Color DSK. In Chapter 7, refer to the "[Modifying Keys](#)" section on page 326 for details.

- **Color Keying using the Color Picker**

Color Keying enables you to key off a color instead of a luminance value. The color can be selected via RGB parameters or by using the "**Pick Color**" feature. In Chapter 7, refer to the "[Modifying Keys](#)" section on page 326 for details.

- **Keyframe Effects for Moves**

Numerous predefined keyframe effects are available for "moves," including linear, linear accelerations, arches and boomerangs motion types. In Chapter 7, refer to the "[Using Move](#)" section on page 336 for details.

- **Clone Function**

For wide screen configurations (only), the Clone function enables you to clone a PIP or a Key on a particular M/E, creating a copy of the effect on the opposite screen. All attributes are cloned, including size, source, border and shadow. In Chapter 7, refer to the "[Using Clone](#)" section on page 330 for details.

- **LCD Calibration**

The LCD calibration function improves the accuracy of the Touch Screens. In Chapter 7, refer to the "[Touch Screen Calibration](#)" section on page 305.

- **Support for Analog Backgrounds**

Using the **Background Input Setup Menu**, you can choose between Analog, DVI Matte and “frame grab” backgrounds. In Chapter 5, refer to the [“Background Input Setup Menu”](#) section on page 237 for details.
- **Support for Two Separate Matte Colors**

Two separate matte colors can be defined, one for **BG A** and one for **BG B**. In Chapter 5, refer to the [“Background Menu Functions — Matte Type”](#) section on page 240 for details.
- **EDID**

The EDID (Extended Display Identification Data) programming procedure is a prerequisite for background and DSK setup. The procedure guarantees proper communications at the preferred resolution between Encore’s DVI inputs and your external equipment. In Chapter 6, refer to the [“Programming EDID”](#) section on page 268 for details.
- **User Keys**

On the Controller LC, **User Keys** are available when you press **User Copy**. This action accesses the **User Key Copy Setup Menu**, which enables you to select all (or a portion) of the current effect’s attributes, such as border color, PIP size, aspect ratio, etc. In Chapter 7, refer to the [“Working with User Keys”](#) section on page 350 for instructions.
- **Group Buttons**

All **Group** buttons operate with “toggle” functionality rather than “additive” functionality. In Chapter 7, refer to the [“Working with Groups”](#) section on page 312 for instructions.
- **Layer Join Mode**

The “Join” mode enables you to create a fixed relationship between a mixer’s two layers. Whenever the mixer is selected, the two joined layers move as one. In Chapter 7, refer to the [“Using Join Mode”](#) section on page 335 for instructions.
- **Key Cut and Fill**

The “Key Cut and Fill” function enables you to cut a key in Layer B and fill it with video from Layer A — within the same Mixer. The two Layers can be manipulated independently or joined using the “Join” function. In Chapter 7, refer to the [“Using Cut & Fill”](#) section on page 325 for instructions.
- **Source Preview**

For any selected Layer, press **Source Preview** in the **Layer Functions Section** to quickly focus or “isolate” that layer for sizing and adjustment purposes in Preview only. In Chapter 7, refer to the [“Using Source Preview”](#) section on page 333 for instructions.
- **Alphanumeric Keypad**

On the Controller LC only, the Alphanumeric Keypad enables you to enter and change numeric fields without having to use a rotary knob. In Chapter 7, refer to the [“Using the Alphanumeric Keypad”](#) section on page 310 for instructions.
- **PS/2 Keyboard**

Standard PS/2 style keyboards can be used with both Controllers for numeric entry and “naming” of certain functions (such as frame grabs). In Chapter 7, refer to the [“Using the PS/2 Keyboard”](#) section on page 311 for details.



- **Programmable Controller Lockout**

You can lock the Controller, thus preventing key presses from changing the system. While locked, serial commands can still be sent via the Console Port. To unlock the Controller, a lockout code is required. In Chapter 7, refer to the [“Enable/Disable Controller Lockout”](#) section on page 352 for instructions.
- **Destination Based Effects Menu**

The **Effects Menu** allows you to modify and manage effects on a destination-by-destination basis, including the ability to define key frames, transition rates, paths and effect properties. In Chapter 5, refer to the [“Effects Menu”](#) section on page 209 for details.
- **Programmable Raster Box Size**

In the **Settings Menu**, users can adjust the size of the raster box that surrounds PIPs and Keys — on a destination by destination basis. In Chapter 5, refer to the [“Settings Menu”](#) section on page 165 for details.
- **Flicker Reduction for Interlaced Formats**

When using Encore to output an interlaced format, a **Flicker Reduce** label appears in the **Settings Menu**. The range is **OFF** (no reduction) or 1 (minimum reduction) through 20 (maximum reduction). In Chapter 5, refer to the [“Settings Menu”](#) section on page 165 for details.
- **Output Formats**

Additional output formats are available. In Appendix A, refer to the [“Input and Output Resolutions”](#) section on page 375 for details.
- **VP or VPx Stacking**

“**Stacking**” is a configuration method that provides access to six mixers, with the ability to display up to 12 PIPs simultaneously. VP or VPx units can be stacked in single or wide screen configurations, and Controller operations are identical to “non-stacked” systems. Stacking is only available with the Controller LC. In Chapter 3, refer to the [“Installation”](#) section on page 64 for details. In Chapter 6, refer to the [“Destination Setup”](#) section on page 277 for setup details.

# 1. Introduction

New Feature Review

## 2. Hardware Orientation

---

### In This Chapter

This chapter provides detailed information about Encore's hardware, including the **Video Processor**, **VPx**, and the **Controller** (rear panel only).

The following topics are discussed:

- [Video Processors](#)
- [M/E Input Notes](#)
- [Program Output Notes](#)
- [Analog Input Flexibility](#)
- [Controller Rear Panels](#)

**Note**

Once you have reviewed all of the sections in this chapter, please continue with Chapter 3, "[Hardware Installation](#)" on page 61.

## 2. Hardware Orientation

### Video Processors

---

## Video Processors

The following topics are discussed in this section:

- [Video Processor Front Panel](#)
- [VPx Front Panel](#)
- [Video Processor Rear Panel](#)
- [VPx Rear Panel](#)
- [A Word About M/E Connector Priority](#)
- [M/E Connectors \(VP\)](#)
- [M/E Connectors \(VPx\)](#)

### Video Processor Front Panel

The figure below illustrates the Video Processor (VP) front panel:



Figure 2-1. VP Front Panel

1) <a href="#">Chassis Handles</a>	2) <a href="#">Air Intake Ports</a>	3) <a href="#">Status LED</a>
------------------------------------	-------------------------------------	-------------------------------

Following are descriptions of each front panel control feature:

#### 1) Chassis Handles

Two **Chassis Handles** are provided for ease of installation and transportation. When transporting the chassis by its handles, **do not** set it down with the rear connectors towards the ground. If you do, you may damage the rear connectors.

#### 2) Air Intake Ports

Two **Air Intake Ports** are provided for chassis cooling. The direction of airflow is from the front to the rear. To prevent overheating, do not block the air intake ports.

#### 3) Status LED

The **Status LED**, behind the right-hand **Air Intake Port**, indicates the following:

- ~ **Solid Red:** the unit is initializing
- ~ **Solid Green:** the unit is ready for use
- ~ **Blinking Red:** an error has occurred

### VPx Front Panel

The **VPx** front panel is identical to the “standard” VP front panel, with the exception of the VPx product label, as shown below:



Figure 2-2. VPx label

### Video Processor Rear Panel

The figure below illustrates the VP rear panel:

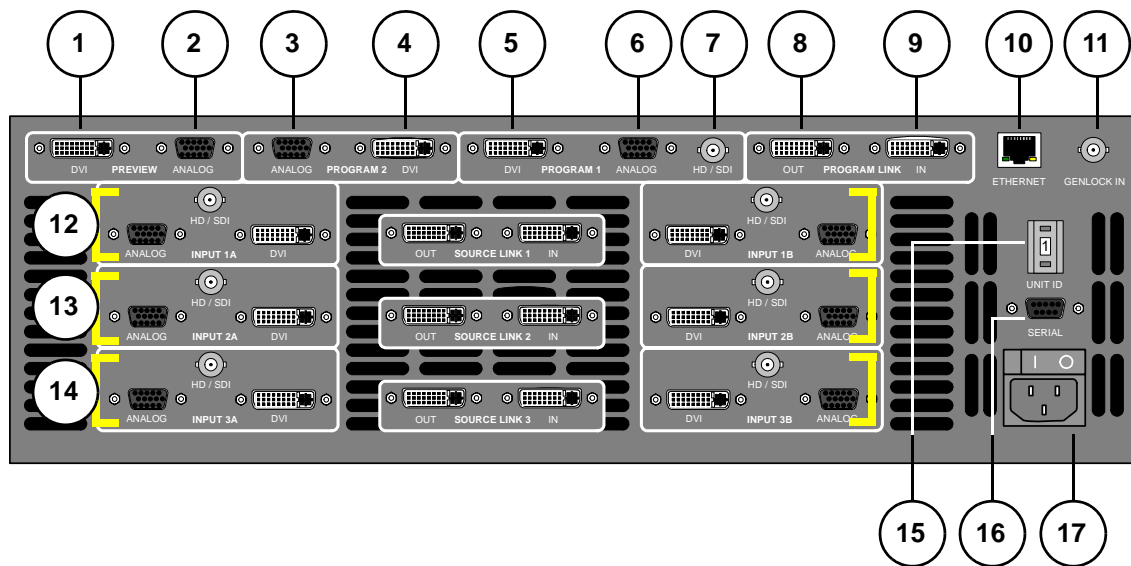


Figure 2-3. VP Rear Panel

1) <a href="#">Preview Out DVI</a>	7) <a href="#">Program Out HD/SDI</a>	13) <a href="#">M/E 2 Connectors</a>
2) <a href="#">Preview Out Analog</a>	8) <a href="#">Program Link Out</a>	14) <a href="#">M/E 3 Connectors</a>
3) <a href="#">Program 2 Out Analog</a>	9) <a href="#">Program Link In</a>	15) <a href="#">Unit ID Selector</a>
4) <a href="#">Program 2 Out DVI</a>	10) <a href="#">Ethernet Port</a>	16) <a href="#">Serial Port</a>
5) <a href="#">Program 1 Out DVI</a>	11) <a href="#">Genlock</a>	17) <a href="#">AC Connector</a>
6) <a href="#">Program 1 Out Analog</a>	12) <a href="#">M/E 1 Connectors</a>	

Please note:

- Connectors 1 through 11 are part of the VP’s output board, and all output connections are standard.
- All program and preview DVI output connectors are digital only, and do not include analog pins.

Following are descriptions of each rear panel connector and section on the VP.

## 2. Hardware Orientation

### Video Processors

#### 1) Preview Out DVI

One DVI connector is provided for **Digital Preview Output**. In Appendix A, refer to the "[DVI Connector Pinouts](#)" section on page 369 for pinouts.

#### 2) Preview Out Analog

One 15-pin D connector is provided for **Analog Preview Output**. In Appendix A, refer to the "[Analog 15-pin D Connector](#)" section on page 371 for pinouts.

#### 3) Program 2 Out Analog

One 15-pin D connector is provided for the **Analog Program 2 Output**. This output is identical to the analog **Program 1 Output**, except that it does not include edge feathering and data doubling components. In Appendix A, see the "[Analog 15-pin D Connector](#)" section on page 371 for pinouts.

#### 4) Program 2 Out DVI

One DVI connector is provided for the **Digital Program 2 Output**. This output is identical to the digital **Program 1 Output**, except that it does not include edge feathering and data doubling components. In Appendix A, refer to the "[DVI Connector Pinouts](#)" section on page 369 for pinouts.

#### 5) Program 1 Out DVI

One DVI connector is provided for the **Digital Program 1 Output**. This output includes all edge feathering and data doubling components, and is designed for a digital connection to your projector. In Appendix A, refer to the "[DVI Connector Pinouts](#)" section on page 369 for pinouts.

#### 6) Program 1 Out Analog

One 15-pin D connector is provided for the **Analog Program 1 Output**. This output includes all edge feathering and data doubling components, and is designed for an analog connection to your projector. In Appendix A, see the "[Analog 15-pin D Connector](#)" section on page 371 for pinouts.

#### 7) Program Out HD/SDI

One BNC connector is provided for the **HD/SDI** (High Definition/Serial Digital Interface) output. Refer to the "[Program Output Notes](#)" section on page 57 for additional information on video outputs.

#### 8) Program Link Out

One DVI connector is provided for the **Program Link Output**. To ensure proper data doubling in wide screen configurations, this output connects to the **Program Link Input** on another VP (or VPx).

~ In Chapter 3, refer to the "[Program and Source Link Connections](#)" section on page 98 for details on the proper use of the connectors in wide screen configurations.

~ In Appendix A, refer to the "[DVI Connector Pinouts](#)" section on page 369 for pinouts.

#### 9) Program Link In

One DVI connector is provided for the **Program Link Input**. To ensure proper data doubling in wide screen configurations, this input connects to the **Program Link Output** from another VP (or VPx).

~ In Chapter 3, refer to the "[Program and Source Link Connections](#)" section on page 98 for details on wide screen configurations.

~ In Appendix A, refer to the "[DVI Connector Pinouts](#)" section on page 369 for pinouts.

## 2. Hardware Orientation

Video Processors

### 10) Ethernet Port

One RJ-45 connector is provided for 10/100BaseT **Ethernet** communications. For multiple connections, use an Ethernet switch on an isolated network.

### 11) Genlock

One BNC connector is provided for an analog **Genlock** connection. PAL or NTSC black burst or composite sync signals are recommended. Please note:

- ~ In wide screen applications, all VPs must be locked together. If you provide Genlock to the first VP in your configuration, Genlock is distributed to the other VPs and VPx units via **Program Link**.
- ~ If you do not use Genlock in a wide screen application, Encore automatically makes the first VP in your configuration the master.
- ~ Genlock is recommended in configurations that use camera sources.

### 12) M/E 1 Connectors

### 13) M/E 2 Connectors

### 14) M/E 3 Connectors

Six analog and digital connectors are provided for each M/E. Please note:

- ~ All M/E boards are identical. See "[M/E Connectors \(VP\)](#)" on page 52.
- ~ Refer to the "[A Word About M/E Connector Priority](#)" section on page 50 for information on M/E connector priority.

### 15) Unit ID Selector

One 16-position selector (with physical digits **0 - 15**) is provided for setting each VP's unique **ID**. The selector enables you to assign logical IDs **1 to 16**.

#### Note

Physical digit **0** equates to logical ID **16**.

By default, a VP is configured as an **DHCP Client**, and it automatically obtains an IP address when it sees a **DHCP Server**. Controller Models SC and LC are configured (by default) as DHCP Servers.

#### Note

Always ensure that each VP has a unique **ID**. During setup, the **ID** is used during various configuration procedures.

- ▲ In a single VP setup, set the ID to **1**. In a three-chassis setup, set the IDs to **1, 2 and 3**, respectively.

#### Note

Using the **Miscellaneous Menu**, you can re-define IDs using numbers **17 - 32**. In Chapter 5, refer to the "[Miscellaneous Menu](#)" section on page 196 for details.

### 16) Serial Port

One 9-pin D connector is provided for RS-232 serial communications with the VP. In Appendix A, refer to the "[Serial Connector](#)" section on page 373 for pinouts.

### 17) AC Connector

One **AC Connector** is provided to connect the VP to your AC source.

Refer to the "[Program Output Notes](#)" section on page 57 for additional information on Processor outputs.

## 2. Hardware Orientation

### Video Processors

#### VPx Rear Panel

The figure below illustrates the VPx rear panel:

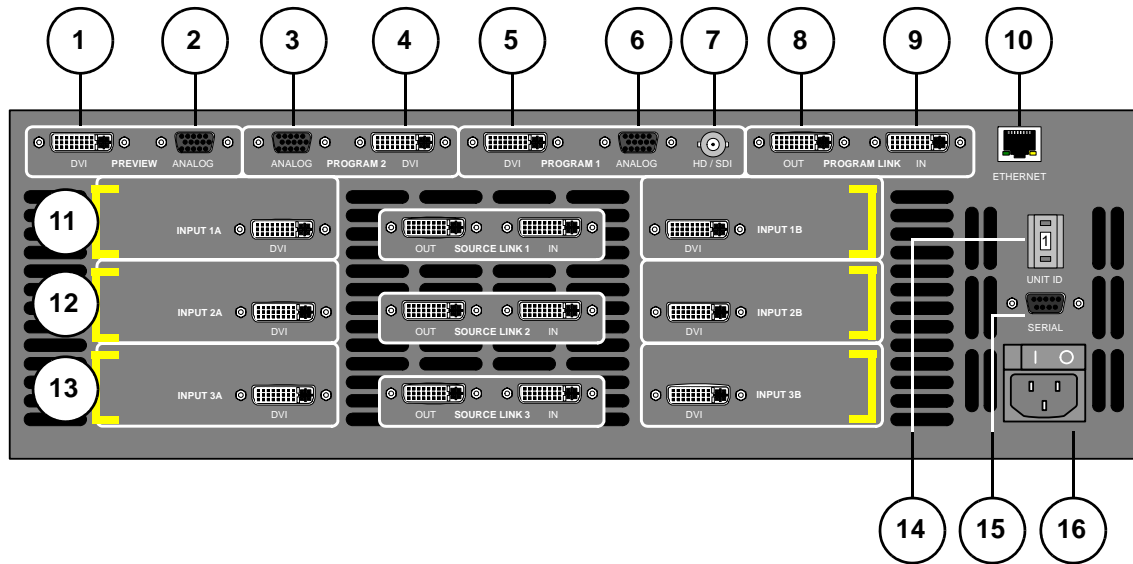


Figure 2-4. VPx Rear Panel

1) <a href="#">Preview Out DVI</a>	7) <a href="#">Program Out HD/SDI</a>	13) <a href="#">M/E 3 Connectors</a>
2) <a href="#">Preview Out Analog</a>	8) <a href="#">Program Link Out</a>	14) <a href="#">Unit ID Selector</a>
3) <a href="#">Program 2 Out Analog</a>	9) <a href="#">Program Link In</a>	15) <a href="#">Serial Port</a>
4) <a href="#">Program 2 Out DVI</a>	10) <a href="#">Ethernet Port</a>	16) <a href="#">AC Connector</a>
5) <a href="#">Program 1 Out DVI</a>	11) <a href="#">M/E 1 Connectors</a>	
6) <a href="#">Program 1 Out Analog</a>	12) <a href="#">M/E 2 Connectors</a>	

Please note:

- Connectors 1 through 10 are part of the VPx's output board, and all output connections are standard.
- All program and preview DVI output connectors are digital only, and do not include analog pins.
- In a widescreen configuration, a VPx cannot function in a standalone manner, but must always work *downstream* of a standard VP. Here, a VPx cannot be the first processor in an Encore configuration.
- In the special widescreen "preview" configuration, a VPx *can* be used as a standalone destination that accepts DVI input signals only — but no other input types are accepted, and no genlock circuitry is provided.

Following are descriptions of each rear panel connector and section on the VPx.

#### 1) Preview Out DVI

One DVI connector is provided for **Digital Preview Output**. In Appendix A, refer to the "[DVI Connector Pinouts](#)" section on page 369 for pinouts.

#### 2) Preview Out Analog

One 15-pin D connector is provided for **Analog Preview Output**. In Appendix A, refer to the "[Analog 15-pin D Connector](#)" section on page 371 for pinouts.



### 3) Program 2 Out Analog

One 15-pin D connector is provided for the **Analog Program 2 Output**. This output is identical to the analog **Program 1 Output**, except that it does not include edge feathering and data doubling components. In Appendix A, see the "[Analog 15-pin D Connector](#)" section on page 371 for pinouts.

### 4) Program 2 Out DVI

One DVI connector is provided for the **Digital Program 2 Output**. This output is identical to the digital **Program 1 Output**, except that it does not include edge feathering and data doubling components. In Appendix A, refer to the "[DVI Connector Pinouts](#)" section on page 369 for pinouts.

### 5) Program 1 Out DVI

One DVI connector is provided for the **Digital Program 1 Output**. This output includes all edge feathering and data doubling components, and is designed for a digital connection to your projector. In Appendix A, refer to the "[DVI Connector Pinouts](#)" section on page 369 for pinouts.

### 6) Program 1 Out Analog

One 15-pin D connector is provided for the **Analog Program 1 Output**. This output includes all edge feathering and data doubling components, and is designed for an analog connection to your projector. In Appendix A, see the "[Analog 15-pin D Connector](#)" section on page 371 for pinouts.

### 7) Program Out HD/SDI

One BNC connector is provided for the **HD/SDI** (High Definition/Serial Digital Interface) output. Refer to the "[Program Output Notes](#)" section on page 57 for additional information on video outputs.

### 8) Program Link Out

One DVI connector is provided for the **Program Link Output**. To ensure proper data doubling in wide screen configurations, this output connects to the **Program Link Input** on another VPx.

~ In Chapter 3, refer to the "[Program and Source Link Connections](#)" section on page 98 for details on the proper use of the connectors in wide screen configurations.

~ In Appendix A, refer to the "[DVI Connector Pinouts](#)" section on page 369 for pinouts.

### 9) Program Link In

One DVI connector is provided for the **Program Link Input**. To ensure proper data doubling in wide screen configurations, this input connects to the **Program Link Output** from another VP (or VPx).

~ In Chapter 3, refer to the "[Program and Source Link Connections](#)" section on page 98 for details on wide screen configurations.

~ In Appendix A, refer to the "[DVI Connector Pinouts](#)" section on page 369 for pinouts.

## 2. Hardware Orientation

### Video Processors

#### 10) Ethernet Port

One RJ-45 connector is provided for 10/100BaseT **Ethernet** communications. For multiple connections, use an Ethernet switch on an isolated network.

#### 11) M/E 1 Connectors      12) M/E 2 Connectors      13) M/E 3 Connectors

Six analog and digital connectors are provided for each M/E. Please note:

- ~ All M/E boards are identical on a VPx. See the "[M/E Connectors \(VPx\)](#)" section on page 52 for details.
- ~ Refer to the "[A Word About M/E Connector Priority](#)" section on page 50 for information on M/E connector priority.

#### 14) Unit ID Selector

One 16-position selector (with physical digits **0 - 15**) is provided for setting a unique **ID** on a VPx. The selector enables you to assign logical IDs **1 to 16**.

##### Note

Physical digit **0** equates to logical ID **16**.

By default, a VPx is configured as an **DHCP Client**, and it automatically obtains an IP address when it sees a **DHCP Server**. Controller Models SC and LC are configured (by default) as DHCP Servers.

##### Note

Always ensure that each VPx has a unique **ID**. During setup, the **ID** is used during various configuration procedures.

##### Note

Using the **Miscellaneous Menu**, you can re-define IDs using numbers **17 - 32**. In Chapter 5, refer to the "[Miscellaneous Menu](#)" section on page 196 for details.

#### 15) Serial Port

One 9-pin D connector is provided for RS-232 serial communications with the VPx. In Appendix A, see the "[Serial Connector](#)" section on page 373 for pinouts.

#### 16) AC Connector

One **AC Connector** is provided to connect the VPx to your AC source.

See the "[Program Output Notes](#)" section on page 57 for more information on VPx outputs.

## A Word About M/E Connector Priority

Depending on your VP or VPx configuration, the M/E connectors on the rear of the chassis do not necessarily relate 1:1 to the layer buttons in the Controller's **Layer Control Section**. Please note:

- The Controller's layer buttons are arranged left-to-right in order of visual priority, from the lowest (**Mixer 1**) to the highest (**Mixer 3**).
- The M/E boards are arranged in order of *electronic* priority, from the lowest (M/E 3) to the highest (M/E 1).
- Electronic priority does not equate 1:1 to visual priority, with regard to the silk-screened labels on the Controller.

## 2. Hardware Orientation

### Video Processors

With this in mind, the information below lists how the physical connectors relate to the various mixers on different VP and VPx configurations. Keep this correlation in mind when you are making rear-panel connections.

- In a **3 M/E** system:
  - ~ **M/E 1** connectors are the highest priority. They appear as **Mixer 3** on the Controller. The DSK will be connected to the M/E 1 board.
  - ~ **M/E 2** connectors have middle priority. They appear as **Mixer 2**.
  - ~ **M/E 3** connectors are the lowest priority. They appear as **Mixer 1**. Background sources will be connected to the M/E 3 board.
- In a **2 M/E** system:
  - ~ **M/E 1** connectors are the highest priority, and appear as **Mixer 2**. The DSK will be connected to the M/E 1 board.
  - ~ **M/E 2** connectors are the lowest priority, and appear as **Mixer 1**. Background sources will be connected to the M/E 2 board.
  - ~ **M/E 3** connectors are *not installed*.
- In a **1 M/E** system:
  - ~ **M/E 1** connector priorities are relative to the connectors being used:
    - The **DVI Input A** or **Analog Input A** connector could be set up as a Background input (lowest priority).
    - The **DVI Input B** or **Analog Input B** connector could be setup as a DSK input (highest priority).

This leaves the other connectors to fall in between Background and DSK. The rule stating that “**A**” connectors are lower in priority than “**B**” connectors still holds.
  - ~ **M/E 2** and **3** connectors are *not installed*.

## 2. Hardware Orientation

### Video Processors

## M/E Connectors (VP)

The figure below illustrates a close-up of the M/E connectors on the VP. Even though the figure uses M/E 1's board, all M/E connections are identical.

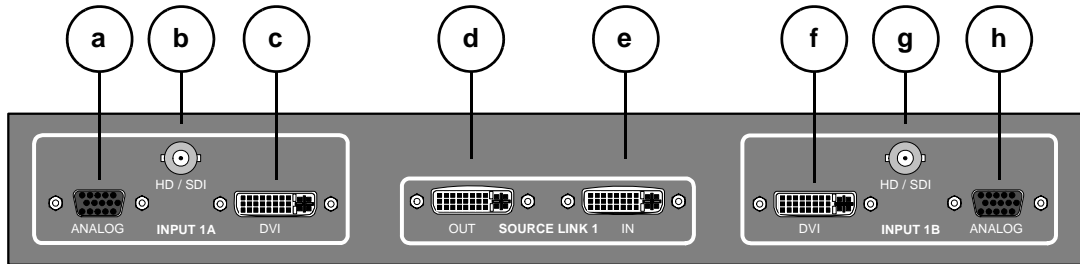


Figure 2-5. M/E Connectors, VP

a)	<a href="#">Analog Input A</a>	d)	<a href="#">Source Link Out</a>	g)	<a href="#">HD/SDI Input B</a>
b)	<a href="#">HD/SDI Input A</a>	e)	<a href="#">Source Link In</a>	h)	<a href="#">Analog Input B</a>
c)	<a href="#">DVI Input A</a>	f)	<a href="#">DVI Input B</a>		

On each M/E, three input connections are provided for layer **A**, three are provided for layer **B**, and two “Link” connectors are provided for inter-Processor communications.

Following are descriptions of each M/E connector.

#### a) Analog Input A

One 15-pin D connector is provided for the input to the M/E’s **Layer A** — visually, the lower priority of the two layers. Connect a VGA source directly, or connect the output of a VGA router. This input can also be used for composite and component video. See the “[M/E Input Notes](#)” section on page 56 for additional information.

In Appendix A, see the “[Analog 15-pin D Connector](#)” section on page 371 for pinout details.

#### b) HD/SDI Input A

One BNC connector is provided for the **HD/SDI** input to **Layer A**. Connect an SDI or HDTV source directly, or connect the output of an SDI or HDTV router. Refer to the “[M/E Input Notes](#)” section on page 56 for more information.

#### c) DVI Input A

One DVI-I connector is provided for both digital and analog inputs to the M/E’s **Layer A** and background channel.

~ **Digital** — connect a digital graphics source directly, or connect the output of a digital graphics router.

~ **Analog** — using the appropriate adapter cable, connect an analog VGA source directly, or connect the output of a VGA router.

Refer to the “[M/E Input Notes](#)” section on page 56 for important details on the use of this connector’s analog component. In Appendix A, refer to the “[DVI-I Connector Pinouts](#)” section on page 370 for pinout details.

#### d) Source Link Out

One DVI connector is provided for the M/E’s **Source Link Output**. For wide screen and multi-screen applications, this connector loops your inputs to the *next* VP or VPx in the chain. Because all analog and digital inputs reside in the digital domain inside the VP, each “link” output loops inputs to the next VP’s scalars.

An M/E's **Source Link Output** must *always* be connected to its associated M/E **Source Link Input** on the next chassis, and never cross-routed.

- ▲ Connect M/E 2's **Source Link Output** on Processor 1 to M/E 2's **Source Link Input** on Processor 2.

Please note:

- ~ In a multi-chassis configuration, the link can extend to all chassis.
- ~ In all cases, the looped inputs are "pre-scaler."

In Chapter 3, refer to the "[Program and Source Link Connections](#)" section on page 98 for details on proper connector usage in wide screen configurations.

In Appendix A, refer to the "[DVI Connector Pinouts](#)" section on page 369 for pinout details.

### e) Source Link In

One DVI connector is provided for the M/E's **Source Link Input**. For wide screen and multi-screen applications, this connector accepts the looped outputs from the previous VP or VPx in the chain. An M/E's **Source Link Input** must *always* be connected to its associated M/E **Source Link Output** on the previous chassis, and never cross-routed.

In Chapter 3, refer to the "[Program and Source Link Connections](#)" section on page 98 for details on proper connector usage in wide screen configurations.

In Appendix A, refer to the "[DVI Connector Pinouts](#)" section on page 369 for pinout details.

### f) DVI Input B

One DVI-I connector is provided for both digital and analog inputs to the M/E's **Layer B** and background channel.

- ~ **Digital** — connect a digital graphics source directly to this input, or more typically, connect the output of a digital graphics router.
- ~ **Analog** — using the appropriate adapter, connect an analog VGA source or the output of a VGA router directly to this input.

Refer to the "[M/E Input Notes](#)" section on page 56 for details on the use of this connector's analog component. In Appendix A, refer to the "[DVI-I Connector Pinouts](#)" section on page 370 for pinout details.

### g) HD/SDI Input B

One BNC connector is provided for the **HD/SDI** input to **Layer B**. Connect an SDI or HDTV source directly, or connect the output of an SDI or HDTV router. Refer to the "[M/E Input Notes](#)" section on page 56 for additional information.

### h) Analog Input B

One 15-pin D connector is provided for the input to the M/E's **Layer B** — visually, the higher priority of the two by default. Connect a VGA source or the output of a VGA router. This input can also be used for composite and component video. See the "[M/E Input Notes](#)" section on page 56 for information about video inputs.

In Appendix A, see the "[Analog 15-pin D Connector](#)" section on page 371 for pinout details.

## 2. Hardware Orientation

### Video Processors

## M/E Connectors (VPx)

The figure below illustrates a close-up of the M/E connectors on the VPx. Even though the figure uses M/E 1's board, all M/E connections are identical on the VPx.

### Note

The M/E connectors on a VPx are identical to those on a VP, minus the analog and HD/SDI connectors.

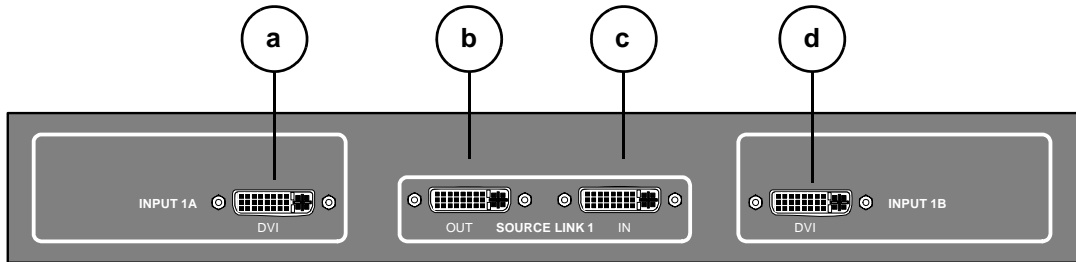


Figure 2-6. M/E Connectors, VPx

a)	<a href="#">DVI Input A</a>	c)	<a href="#">Source Link In</a>	d)	<a href="#">DVI Input B</a>
b)	<a href="#">Source Link Out</a>				

On each M/E, one input connection is provided for layer **A**, one for layer **B**, and two “Link” connectors for inter-Processor communications.

### Important

In a widescreen configuration, a VPx cannot function in a standalone manner, but must always work *downstream* of a standard VP. Here, a VPx cannot be the first processor in an Encore configuration.

In the special widescreen “preview” configuration, a VPx *can* be used as a standalone destination that accepts DVI input signals only — but no other input types are accepted, and no genlock circuitry is provided.

Following are descriptions of each M/E connector on a VPx.

#### a) DVI Input A

One DVI-I connector is provided for both digital and analog inputs to the M/E's **Layer A** and background channel.

- ~ **Digital** — connect a digital graphics source directly, or connect the output of a digital graphics router.
- ~ **Analog** — using the appropriate adapter cable, connect an analog VGA source directly, or connect the output of a VGA router.

Refer to the “[M/E Input Notes](#)” section on page 56 for important details on the use of this connector's analog component. In Appendix A, refer to the “[DVI-I Connector Pinouts](#)” section on page 370 for pinout details.

### b) Source Link Out

One DVI connector is provided for the M/E's **Source Link Output**. For wide screen and multi-screen applications, this connector loops your inputs to the *next* VP or VPx in the chain. Because all analog and digital inputs reside in the digital domain, each "link" output loops those inputs to the next Processor's scalars.

An M/E's **Source Link Output** must *always* be connected to its associated M/E **Source Link Input** on the next chassis, and never cross-routed.

Please note:

- ~ In a multi-chassis configuration, the link can extend to all chassis.
- ~ In all cases, the looped inputs are "pre-scaler."

In Chapter 3, refer to the "[Program and Source Link Connections](#)" section on page 98 for details on proper connector usage in wide screen configurations.

In Appendix A, refer to the "[DVI Connector Pinouts](#)" section on page 369 for pinout details.

### c) Source Link In

One DVI connector is provided for the M/E's **Source Link Input**. For wide screen and multi-screen applications, this connector accepts the looped outputs from the previous VP or VPx in the chain. An M/E's **Source Link Input** must *always* be connected to its associated M/E **Source Link Output** on the previous chassis, and never cross-routed.

In Chapter 3, refer to the "[Program and Source Link Connections](#)" section on page 98 for details on proper connector usage in wide screen configurations.

In Appendix A, refer to the "[DVI Connector Pinouts](#)" section on page 369 for pinout details.

### d) DVI Input B

One DVI-I connector is provided for both digital and analog inputs to the M/E's **Layer B** and background channel.

- ~ **Digital** — connect a digital graphics source directly to this input, or more typically, connect the output of a digital graphics router.
- ~ **Analog** — using the appropriate adapter cable, connect an analog VGA source directly to this input, or more typically, connect the output of a VGA router.

Refer to the "[M/E Input Notes](#)" section on page 56 for details on the use of this connector's analog component. In Appendix A, refer to the "[DVI-I Connector Pinouts](#)" section on page 370 for pinout details.

## 2. Hardware Orientation

### M/E Input Notes

---

## M/E Input Notes

Please note the following important points regarding M/E inputs:

- **Single Processor Configurations** (VP and VPx) — Inputs are connected to the VP in the normal manner. You can connect a total of six inputs to each M/E:
  - ~ Three inputs can connect to layer **A** (HD/SDI, analog and DVI).
  - ~ Three inputs can connect to layer **B** (HD/SDI, analog and DVI).

### Note

In a widescreen configuration, a VPx cannot function in a standalone manner, but must always work *downstream* of a standard VP. Here, a VPx cannot be the first processor in an Encore configuration.

In the special widescreen “preview” configuration, a VPx can be used as a standalone destination that accepts DVI input signals only — but no other input types are accepted, and no genlock circuitry is provided.

Using the setup menus, each input can be assigned to a source button on the Controller, but only two inputs can be used “on air” from an M/E at a time — the one assigned to layer A and the one assigned to layer B.

Thus, in a three-M/E configuration, you can populate all 18 physical inputs, but only six PIPs can be used “on air” — using both layers on each mixer.

- **Multiple Processor Configurations** (VP and VPx) — In these configurations, you only need to connect inputs to the first Processor. Inputs are automatically looped to all other Processors via the **Source Link** connections.
- **Routers** (VP only) — You can connect sources directly to the M/E inputs, or for the greatest flexibility, you to connect router outputs to the M/E inputs. In this manner, one input represents any number of video or graphic sources.
- **HD/SDI Inputs** (VP Only) — For the two HD/SDI input connectors on an M/E, you can set the input to accept **SDI** (SMPTE 259M-C, NTSC or PAL) or **HD-SDI** (SMPTE 292M, HDTV).
- **DVI-I Connectors** (VP and VPx) — There are two DVI-I input connectors for each M/E (**A** and **B**), and each contains both a digital and an analog input. Depending upon your application (and the location of the M/E), you can use the input for a scaled or an unscaled source:
  - ~ The “digital” side accepts connections from a standard DVI output or digital graphic router. This side of the input can be used as both a scaled input source or as an unscaled **Background / DSK** source.
  - ~ Using a breakout cable, the “analog” side accepts connections from a VGA output or VGA router. This side is designed for inputting the system’s unscaled sources — **Background** and **DSK**.
    - The lowest priority M/E in your system must be used for inputting the **Background** source.
    - The highest priority M/E in your system must be used for inputting the **DSK** source.



## Program Output Notes

For both VP and VPx units, please note the following important points regarding the Processor's program outputs:

- **HD/SDI Outputs** — For the HD/SDI output, you can set the output to be **SDI** (SMPTE 259M-C, NTSC or PAL) or **HD-SDI** (SMPTE 292M, HDTV). When you set this output resolutions, all output connectors will output that same resolution.
- **DVI Program Outputs** — DVI Program outputs are digital only. They do not have analog connections.
- **Program 1 Outputs** — Edge feathering and data doubling are present on all Program 1 Outputs, provided that those features are enabled in the system's **Output Menu**.

## Analog Input Flexibility

For VPs only, each M/E's Analog Input connectors (**A** and **B**) accept a variety of analog formats including VGA, low-resolution composite, S-video and YUV component video.

- For RGB with H and V sync, use the VGA connector directly.
- Using a (customer supplied) VGA to 5xBNC breakout cable, five input combinations are possible. Cells with check marks denote the connections required for the indicated format.

**Table 2-1.** Analog Input Combinations using Breakout Cable

Breakout Cable Wire Color	Composite Video	S-Video (Y/C)	YUV (Y <sub>P</sub> P <sub>r</sub> )	RGB Sync on Green	RGB Comp Sync	RGB Separate H V
R		✓ (Chrom)	✓ (P <sub>r</sub> )	✓	✓	✓
G	✓	✓ (Lum)	✓ (Lum)	✓	✓	✓
B			✓ (P <sub>b</sub> )	✓	✓	✓
H Sync					✓	✓
V Sync						✓

## 2. Hardware Orientation

### Controller Rear Panels

## Controller Rear Panels

The figure below illustrates the rear panel connectors on both Controllers (**SC** and **LC**). The panels are identical on both models.

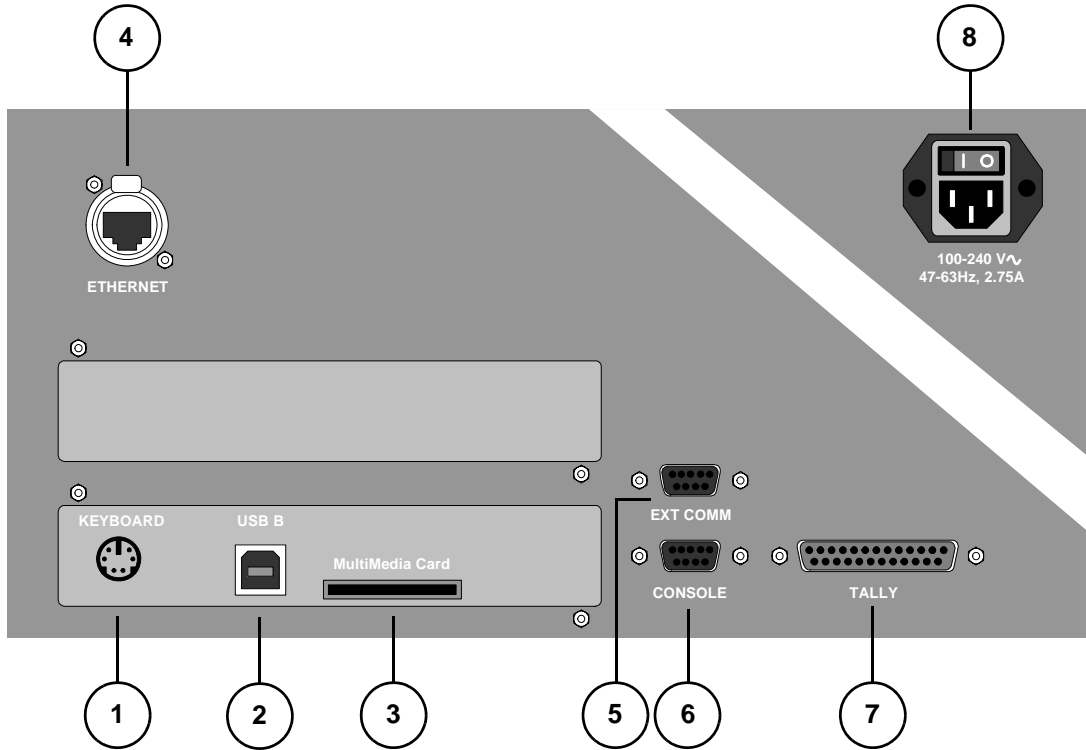


Figure 2-7. Controller Rear Panel Connectors

1) <a href="#">Keyboard Port</a>	4) <a href="#">Ethernet Port</a>	7) <a href="#">Tally Connector</a>
2) <a href="#">USB B Port</a>	5) <a href="#">Ext Comm</a>	8) <a href="#">AC Power</a>
3) <a href="#">MultiMedia Card Slot</a>	6) <a href="#">Console Port</a>	

Following are descriptions of each rear panel connector:

#### 1) Keyboard Port

One standard PS/2 connector is provided for the **Keyboard Port**. When a customer-supplied PS/2 style keyboard is connected, certain numeric entry and “naming” functions can be performed. In Chapter 7, refer to the “[Using the PS/2 Keyboard](#)” section on page 311 for details.

#### 2) USB B Port

#### Note

This connector is not implemented.

## 2. Hardware Orientation

### Controller Rear Panels

#### 3) MultiMedia Card Slot

One **MultiMedia Card Slot** is provided for a Flash Memory Card connection to the Controller. The flash card enables you to store and recall system configurations, and transfer them between Controllers as required. In Chapter 5, refer to the "[Miscellaneous Menu](#)" section on page 196 for details on backup and restore.

#### 4) Ethernet Port

One RJ-45 connector is provided for 10/100BaseT **Ethernet** communications with the Encore Processor. The Ethernet connector is compatible with:

- ~ Standard RJ-45 Ethernet cables
- ~ Neutrik EtherCon<sup>®</sup> series cables

For multiple connections in an Encore system, an Ethernet switch on an isolated network is recommended. In Appendix A, refer to the "[Ethernet Connector](#)" section on page 372 for pinout details.

#### 5) Ext Comm

One 9-pin D connector is provided for RS-232 serial communications with a serial device, such as a router. In Appendix A, refer to the "[Serial Connector](#)" section on page 373 for pinout details.

#### 6) Console Port

One 9-pin D connector is provided for RS-232 serial communications with an ASCII terminal for command-line control of the Encore system. In Appendix A, refer to the "[Serial Connector](#)" section on page 373 for pinout details.

#### 7) Tally Connector

One 25-pin D connector is provided for issuing tally "relay closure" commands to external devices such as cameras. Eight tally circuits are provided. In Appendix A, refer to the "[Tally Connector](#)" section on page 374 for pinout details.

#### 8) AC Power

Use the **AC Power** connector to connect the Controller to your facility's AC power source. The integral switch turns the Controller on and off.

## 2. Hardware Orientation

Controller Rear Panels

## 3. Hardware Installation

---

### In This Chapter

This chapter provides comprehensive installation instructions for the Encore system's hardware. The following topics are discussed:

- [Safety Precautions](#)
- [Unpacking and Inspection](#)
- [Site Preparation](#)
- [Rack-Mount Installation](#)
- [Cable and Adapter Information](#)
- [Installation](#)
- [Connection Charts](#)
- [Program and Source Link Connections](#)

**Note**

Once you have reviewed all of the sections in this chapter, please continue with Chapter 4, "[Controller Orientation](#)" on page 107.

### 3. Hardware Installation

#### Safety Precautions

---

## Safety Precautions

For all Encore Presentation System installation procedures, observe the following important safety and handling rules to avoid damage to yourself and the equipment:

- To protect users from electric shock, ensure that the power supplies for each VP, VPx and Control Panel connect to earth via the ground wire provided in the AC power Cord.
  - The AC Socket-outlet should be installed near the equipment and be easily accessible.
- 

## Unpacking and Inspection

Before opening the boxes, inspect them for damage. If you find any damage, notify the shipping carrier immediately for all claims adjustments. As you open each box, compare its contents against the packing slips. If you find any shortages, contact your Barco sales representative.

Once you have removed all the components from their packaging and checked that all the listed components are present, visually inspect each Controller and Processor to ensure there was no damage during shipping. If there is damage, notify the shipping carrier immediately for all claims adjustments.

---

## Site Preparation

The environment in which you install your Encore Presentation System should be clean, properly lit, free from static, and have adequate power, ventilation, and space for all components.

---

## Rack-Mount Installation

Encore VP and VPx units are designed to be rack mounted, and are supplied with front rack-mount hardware. Rear rack-mount brackets are available as a kit, and are recommended when units are mounted in transit cases.

When rack mounting VP and VPx units, remember the following important points:

- Maximum ambient operating temperature for the unit is 40 degrees C.
- Leave at least one inch of space (front and rear) to ensure that the airflow through the fan and vent holes is not restricted.
- Distribute the units evenly to prevent hazardous conditions that may be created by uneven weight distribution.
- Rack mount the units from the front rack ears using four rack screws (not supplied). Threads may be metric or otherwise — depending upon the rack type.
- Install the *lower* of the two mounting holes first.

---

## Cable and Adapter Information

The table below provides cable and adapter information:

**Table 3-1.** Encore Presentation System Cables and Adapters

Cable	Description
DVI-to-VGA Analog Adapters	Included *
DVI Program and Source Link Cables	Included, DVI-M to DVI-M, 1 Meter length *
Analog Input Cables	Customer Supplied
DVI Input Cables	Customer Supplied
Analog Breakout Cables	Customer Supplied
RJ-45 Ethernet Cable	Customer Supplied
Ethernet Switch	Customer Supplied
Additional DVI-to-VGA Adapters	Optional
DVI Extension Cables	Optional, 1.5 ft. length
DVI to 5xBNC Breakout Cable	Optional

\* Cable and adapter quantities depend on the number of M/Es purchased in each VP or VPx.

### 3. Hardware Installation

Installation

---

## Installation

Detailed installation procedures are provided for the Encore configurations listed below. Select the desired configuration, and follow all procedures as listed:

- [Single Screen Configuration](#)
- [Triple Screen Configuration](#)
- [Wide Screen Configuration](#)
- [Wide Screen Configuration Plus Wide Screen Preview](#)
- [Single Screen Stack Configuration](#)
- [Wide Screen Stack Configuration](#)



### Single Screen Configuration

The figure below illustrates a block diagram of a single screen Encore configuration. Use this diagram for reference in the following procedure. Please note:

- Aux destinations are not shown in the diagram below.

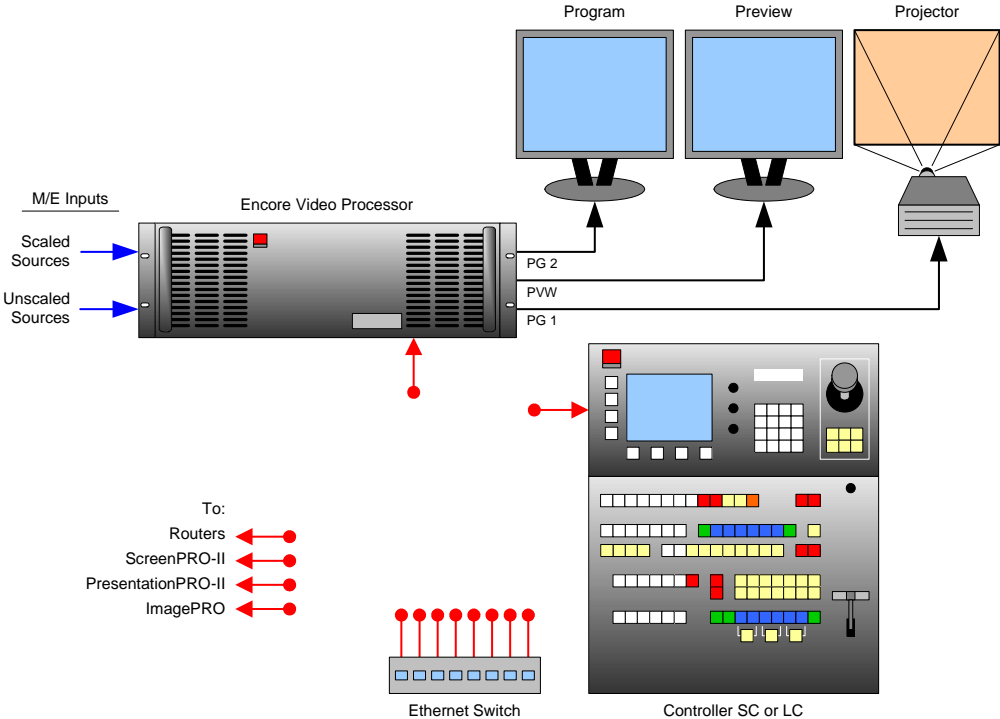


Figure 3-1. Block Diagram, Single Screen Encore Configuration

For this configuration, you will need:

Table 3-2. Equipment List, Single Screen Encore Configuration

Qty.	Item	Note
1	VP	VPx cannot be used
1	Controller	Model LC or SC
1	Video Projector	Customer supplied
2	DVI or Analog Monitors	Program and Preview (customer supplied)
1	Ethernet Switch	Customer supplied
2	Ethernet cables	Customer supplied. Additional cables required for routers.
TBD	Sources, routers, cables	Analogue, Video and/or DVI as required (customer supplied)

- Use the following steps to install a single screen Encore configuration:
  1. Follow the unpacking procedures as listed in the [“Unpacking and Inspection”](#) section on page 62.

### 3. Hardware Installation

#### Installation

2. In Appendix A, refer to the “[Physical and Electrical Specifications](#)” section on page 367 for electrical and mechanical details.
3. In Chapter 2, refer to the “[Video Processor Rear Panel](#)” section on page 45 and the “[Controller Rear Panels](#)” section on page 58 for all connector locations.
4. For the VP, follow the rack mount procedures as outlined in the “[Rack-Mount Installation](#)” section on page 62.

#### Note

A VPx can only be used in a single processor configuration in the special widescreen “preview” mode. Refer to the “[Wide Screen Configuration Plus Wide Screen Preview](#)” section on page 76 for details.

5. **Ethernet Connections** — a totally “local” network connection is recommended. Using Ethernet cables:
  - a. Connect the VP and Controller to the Ethernet Switch, then connect router(s) to the Switch.
  - b. As required, connect ScreenPRO-II, PresentationPRO-II and ImagePRO systems to the Switch.
6. **Direct Source Connections** — if you elect to use direct connections in place of (or in addition to) router connections:
  - a. As an important prerequisite, complete your “[Connection Charts](#)” on page 89 to streamline your source installation procedure.
  - b. Using the information from the chart, connect the desired “direct” sources to each M/E’s input connectors as required.
  - c. As required, connect unscaled background and DSK sources, as provided from a PC’s single head graphics card.
7. **D/A Connections** —
  - a. If your system includes analog, SDI or DVI D/As, connect video inputs to the D/As as required.
  - b. Connect D/A outputs to the to the desired M/E input connectors.
8. **Router Connections** — if you elect to use router connections in place of (or in addition to) direct connections:
  - a. For Ethernet controlled routers, ensure that the router(s) are connected to the same Ethernet Switch as the Controller and Processor. Ensure that each router has a unique IP address.
  - b. To connect a single serial controlled router, use an RS-232 cable to connect the router to the Controller’s **EXT COMM** port. In Chapter 2, refer to the “[Controller Rear Panels](#)” section on page 58 for details.
  - c. To connect two (or more) serial routers, a third-party Ethernet-to-Serial converter is required, such as the **Lantronix** model **UDS100**, **UDS200** or **UDS2100** (<http://www.lantronix.com>). Each **UDS2100** can control two serial routers.
    - Using RS-232 cables, connect each router to the **UDS2100**.
    - Set up a static IP address on the Lantronix. The recommended range is **192.168.0.191 - 192.168.0.240** — so as not to conflict with Encore devices. See the **Lantronix User’s Guide**.
    - Using an Ethernet cable, connect the **UDS2100** to the same Ethernet Switch as the Controller and Processor(s).

### 3. Hardware Installation

#### Installation

- d. Ensure that all sources are properly connected to your router(s).
  - e. Connect all selected router outputs to the desired M/E inputs.
9. **ScreenPRO-II Connections** — if your system includes one (or more) destination ScreenPRO-II units, you can configure the unit for internal or external routing:
- a. When **External** routers are used, connect two outputs from an Analog router to **any two HD-15 inputs** on the ScreenPRO-II. An SDI router can also be connected to BNC inputs **1** and **2**. During setup, these specific patches will be defined using the **Output Patch Menu**.
  - b. When **Internal** routing is used, connect Analog sources to inputs **1 - 8** on the HD-15 connectors, and SDI sources to BNC inputs **1** and **2**. During setup, these patches will be defined using the **Input Patch Menu**.

In Chapter 6, refer to the "[ScreenPRO-II Destination Setup](#)" section on page 279 for more information.

10. **Output Connections** —

- a. Connect the VP's analog or digital **Preview Output** to the input of your Preview Monitor.
- b. Connect the VP's analog or digital **Program 2 Output** to the input of your Program Monitor.
- c. Connect the analog or digital **Program 1 Output** to the projector input.
- d. Connect the **Program Out HD/SDI** connector to an SDI or HDTV monitor, or to the proper video distribution equipment.

**Note**

This output only works if the selected output resolution is a valid SDI or HD/SDI format.

11. **Aux Destinations** — you can configure three types of Aux destinations: **Aux** (monitors), **ImagePRO Aux** and **PresentationPRO-II Aux**. Refer to Appendix D, "[Working With Destinations](#)" on page 393 for interconnection details.
12. **Power Connection** — connect AC power cords to the AC Power Connectors on the rear of the VP and Controller, and then to AC outlets. Connect AC Power cords (or AC adapters) to all peripheral equipment. Please note:
- ~ Connect each unit only to a properly rated supply circuit.
  - ~ Reliable grounding of rack-mounted equipment should be maintained.
13. **Tally Connection** — the Controller provides one 25-pin D connector for issuing "relay closure" commands to external devices. Eight circuits are provided. In Appendix A, refer to the "[Tally Connector](#)" section on page 374 for details.
14. **System ID** — Using the **Unit ID Selector**, set the ID of the VP to **1**.

**Note**

Using the **Miscellaneous Menu**, you can redefine IDs using numbers **17 - 32**. In Chapter 5, refer to the "[Miscellaneous Menu](#)" section on page 196 for details.

15. If your system includes remote destinations such as **ScreenPRO-II** units, refer to Appendix D, "[Working With Destinations](#)" on page 393 for connection details.
16. **Power On** — all power on instructions are covered in Chapter 6.

Please continue with Chapter 4, "[Controller Orientation](#)" on page 107.

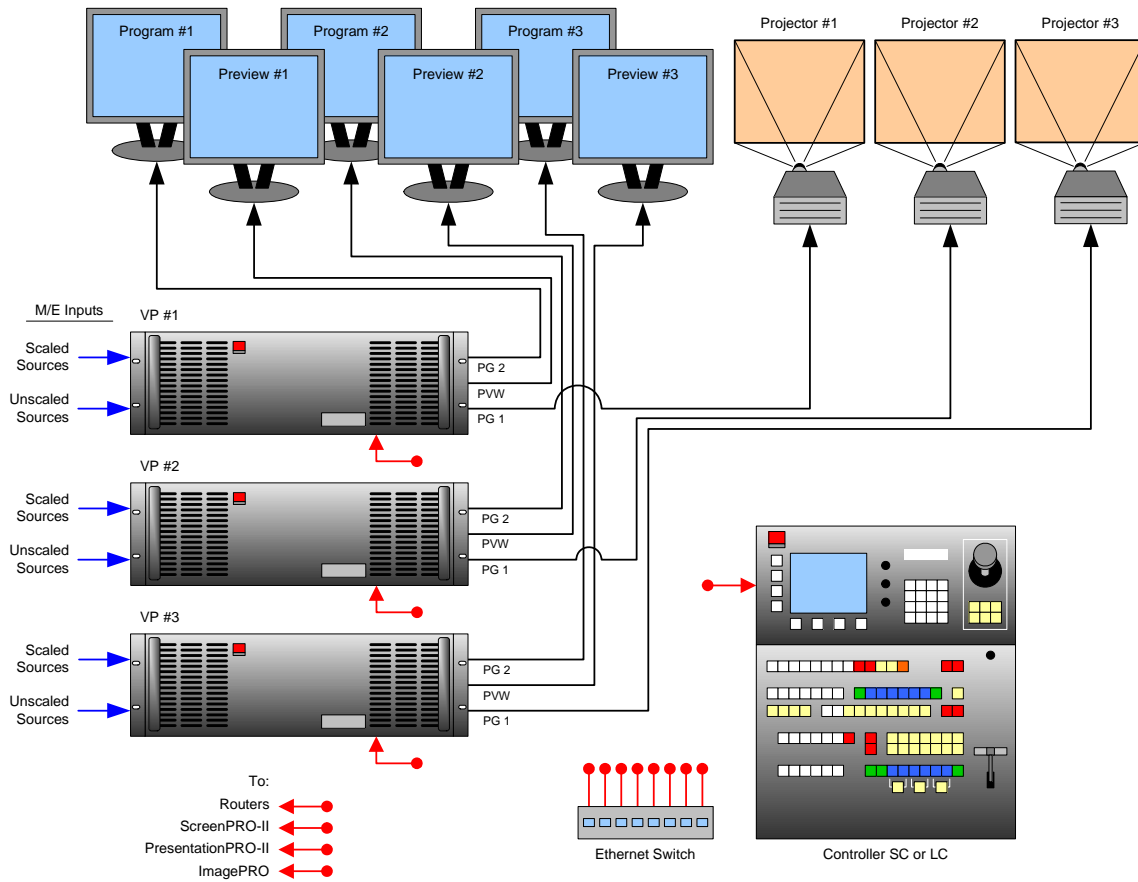
### 3. Hardware Installation

#### Installation

## Triple Screen Configuration

The figure below illustrates a block diagram of a triple screen Encore configuration. This diagram can be used as reference in the procedure. Please note:

- Aux destinations are not shown in the diagram below.
- This procedure can be used for configurations consisting of from 2 to 32 screens.
- A VP must be used for each single destination. VPx cannot be used.



**Figure 3-2.** Block Diagram, Triple Screen Encore Configuration

For this configuration, you will need:

**Table 3-3.** Equipment List, Triple Screen Encore Configuration

Qty.	Item	Note
3	VP	VPx cannot be used.
1	Controller	Model LC or SC
3	Video Projectors	Customer supplied.
6	DVI or Analog Monitors	Program and Preview (customer supplied).
1	Ethernet Switch	Customer supplied

### 3. Hardware Installation

Installation

**Table 3-3.** Equipment List, Triple Screen Encore Configuration (Continued)

Qty.	Item	Note
4	Ethernet cables	Customer supplied. Additional cables required for routers.
TBD	Sources, routers, cables	Analog, Video and/or DVI as required (customer supplied)

- Use the following steps to install a triple screen Encore configuration:
  1. Follow the unpacking procedures as listed in the [“Unpacking and Inspection”](#) section on page 62.
  2. In Appendix A, refer to the [“Physical and Electrical Specifications”](#) section on page 367 for electrical and mechanical details.
  3. In Chapter 2, refer to the [“Video Processor Rear Panel”](#) section on page 45 and the [“Controller Rear Panels”](#) section on page 58 for all connector locations.
  4. For each VP, follow the rack mount procedures as outlined in the [“Rack-Mount Installation”](#) section on page 62.

**Note**

A VPx cannot be used in a single processor configuration.

5. **Ethernet Connections** — a totally “local” network connection is recommended:
  - a. Connect the VPs and Controller to the Ethernet Switch.
  - b. Connect router(s) to the Switch.
  - c. As required, connect ScreenPRO-II, PresentationPRO-II and ImagePRO systems to the Switch.
6. **Direct Source Connections** — if you elect to use direct connections, in place of (or in addition to) router connections:
  - a. As an important prerequisite, complete your [“Connection Charts”](#) on page 89 to streamline your source installation procedure.
  - b. Using information from the chart, connect the desired “direct” sources to each M/E’s input connectors as required — on each Processor.
  - c. As required, connect unscaled background and DSK sources, as provided from a PC’s single head graphics card.
7. **D/A Connections** —
  - a. If your system includes analog, SDI or DVI D/As, connect video inputs to the D/As as required.
  - b. Connect D/A outputs to the to the desired M/E input connectors.
8. **Router Connections** — if you elect to use router connections, in place of (or in addition to) direct connections:
  - a. For Ethernet controlled routers:
    - Ensure that the router(s) are connected to the same Ethernet Switch as the Controller and VPs.
    - Ensure that each router has a unique IP address.
  - b. To connect a single serial controlled router, use an RS-232 cable to connect the router to the Controller’s **EXT COMM** port. In Chapter 2, refer to the [“Controller Rear Panels”](#) section on page 58 for details.

### 3. Hardware Installation

#### Installation

- c. To connect two (or more) serial routers, a third-party Ethernet-to-Serial converter is required, such as the **Lantronix** model **UDS100**, **UDS200** or **UDS2100** (<http://www.lantronix.com>). Each **UDS2100** can control two serial routers.
    - Using RS-232 cables, connect each router to the **UDS2100**.
    - Set up a static IP address on the Lantronix. The recommended range is **192.168.0.191 - 192.168.0.240** — so as not to conflict with Encore devices. See the **Lantronix User's Guide**.
    - Using an Ethernet cable, connect the **UDS2100** to the same switch as the Controller and VPs.
  - d. Ensure that all sources are connected to your router(s).
  - e. Connect all selected router outputs to the desired M/E inputs.
9. **ScreenPRO-II Connections** — if your system includes one (or more) destination ScreenPRO-II units, you can configure them for internal or external routing:
- a. When **External** routers are used, connect two outputs from an Analog router to **any two HD-15 inputs** on the ScreenPRO-II. An SDI router can also be connected to BNC inputs **1** and **2**. During setup, these specific patches will be defined using the **Output Patch Menu**.
  - b. When **Internal** routing is used, connect Analog sources to inputs **1 - 8** on the HD-15 connectors, and SDI sources to BNC inputs **1** and **2**. During setup, these patches will be defined using the **Input Patch Menu**.

In Chapter 6, refer to the "[ScreenPRO-II Destination Setup](#)" section on page 279 for more information.

10. **Output Connections** —

- a. For each VP, connect the analog or digital **Preview Output** to the input of the associated Preview Monitor.
- b. For each VP, connect the analog or digital **Program 2 Output** to the input of the associated Program Monitor.
- c. For each VP, connect the analog or digital **Program 1 Output** to the input of the associated projector.
- d. Connect the **Program Out HD/SDI** connector to an SDI or HDTV monitor as required, or to the proper video distribution equipment.

**Note**

This output only works if the selected output resolution is a valid SDI or HD/SDI format.

11. **Aux Destinations** — you can configure three types of Aux destinations: **Aux** (monitors), **ImagePRO Aux** and **PresentationPRO-II Aux**. Refer to Appendix D, "[Working With Destinations](#)" on page 393 for interconnection details.
12. **Power Connection** — connect AC power cords to the AC Power Connectors on the rear of each VP and Controller, and then to AC outlets. Connect AC Power cords (or AC adapters) to all peripheral equipment. Please note:
- ~ Connect each unit only to a properly rated supply circuit.
  - ~ Reliable grounding of rack-mounted equipment should be maintained.
13. **Tally Connection** — the Controller provides one 25-pin D connector for issuing tally "relay closure" commands to external devices. Eight circuits are provided. In Appendix A, refer to the "[Tally Connector](#)" section on page 374 for details.

### 3. Hardware Installation

Installation

- 14. System ID** — Using the **Unit ID Selector**, set the ID of VP #1 to **1**, VP #2 to **2**, VP #3 to **3**. Each Processor must have a unique ID.

**Note**

Using the **Miscellaneous Menu**, you can redefine IDs using numbers **17 - 32**. In Chapter 5, refer to the "[Miscellaneous Menu](#)" section on page 196 for details.

- 15. Power On** — all power on instructions are covered in Chapter 6.

With all connections made, continue with Chapter 4, "[Controller Orientation](#)" on page 107.

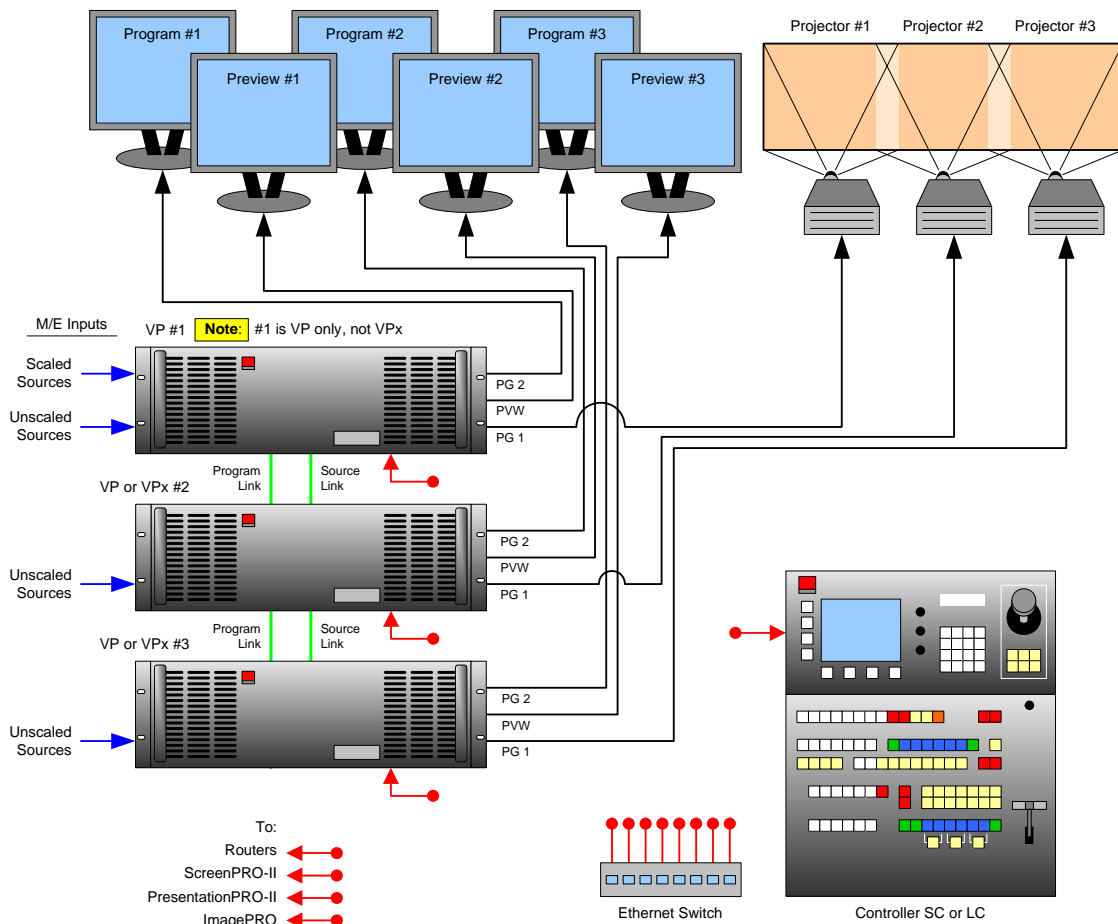
### 3. Hardware Installation

#### Installation

## Wide Screen Configuration

The figure below illustrates a block diagram of a “triple” wide screen configuration. Use this diagram for reference in the following procedure. Please note:

- Aux destinations are not shown in the diagram below.
- This procedure can be used for wide screen configurations consisting of from 2 to 32 screens. Horizontal, vertical, and “array” blending is set using the **Destination Setup Menu**.
- A VP must be used as the “master” processor. Thereafter, either a VP or a VPx can be used.



**Figure 3-3.** Block Diagram, Wide Screen Encore Configuration

For this procedure, you will need:

**Table 3-4.** Equipment List, Wide Screen Encore Configuration

Qty.	Item	Note
1	VP	VPx cannot be used as the “master” processor
2	VP or VPx	Use either processor as a “slave” unit in a widescreen configuration



### 3. Hardware Installation

Installation

**Table 3-4.** Equipment List, Wide Screen Encore Configuration (Continued)

Qty.	Item	Note
1	Controller	Model LC or SC
3	Video Projectors	Customer supplied.
6	DVI or Analog Monitors	Program and Preview (customer supplied).
1	Ethernet Switch	Customer supplied
4	Ethernet cables	Customer supplied. Additional cables required for routers.
TBD	Program Link Cables (DVI-I)	Use 1 for double wide screen application, <b>left justification</b>
		Use 2 for triple wide screen application, <b>left justification</b>
		Use 2 for double wide screen application, <b>center justification</b>
		Use 3 for triple wide screen application, <b>center justification</b>
TDB	Source Link Cables (DVI-I)	Dependent on the number of M/Es installed in the Processors
TBD	Sources, routers and cables	Analog, Video and/or DVI as required (customer supplied)

- Use the following steps to install a wide screen Encore configuration:
  1. Follow the unpacking procedures as listed in the [“Unpacking and Inspection”](#) section on page 62.
  2. In Appendix A, refer to the [“Physical and Electrical Specifications”](#) section on page 367 for electrical and mechanical details.
  3. In Chapter 2, refer to the [“Video Processor Rear Panel”](#) section on page 45 and the [“Controller Rear Panels”](#) section on page 58 for all connector locations.
  4. For each VP and VPx, follow the rack mount procedures as outlined in the [“Rack-Mount Installation”](#) section on page 62.
  5. **Ethernet Connections** — a totally “local” network connection is recommended:
    - a. Connect the VP(s), VPx(s) and Controller to the Switch.
    - b. Connect router(s) to the Switch.
    - c. As required, connect ScreenPRO-II, PresentationPRO-II and ImagePRO systems to the Switch.
  6. **Direct Source Connections** — if you elect to use direct connections, in place of (or in addition to) router connections:
    - a. As a prerequisite, complete your [“Connection Charts”](#) on page 89.
    - b. Connect the desired “direct” sources to each M/E’s input connectors on each VP or VPx. In a wide screen system, scaled sources only connect to Processor 1. “Links” carry the signals to the other VP or VPx units.
    - c. Unscaled **Backgrounds** must originate from computers with multi-head graphics cards, and connect to the same input on each VP or VPx.
      - ▲ To connect an unscaled background source in a triple processor system (each VP or VPx with three M/Es):
        - Connect the computer’s “head 1” to processor 1, input 3A
        - Connect the computer’s “head 2” to processor 2, input 3A

### 3. Hardware Installation

#### Installation

- Connect the computer's "head 3" to processor 3, input 3A

**Note**

Input 3A resides on the lowest priority M/E in a 3 M/E system. To connect a *second* background, use input 3B.

- d. The **DSK** source *may* originate from a computer with a multi-head graphics card, but it is not a requirement.

- ▲ Connecting a single-head graphics card to processor 3 only would enable a bug to be placed *only* in that screen space.

**Note**

The **DSK Setup Menu** allows you to pick an individual ID within a widescreen on which to perform DSK setup.

To use a multi-head graphics card for the DSK, connect it to the same input on each VP or VPx — to the highest priority M/E (M/E 1).

- ▲ To connect an unscaled DSK source in a triple processor system (each processor with three M/Es):

- Connect the computer's "head 1" to processor 1, input 1A
- Connect the computer's "head 2" to processor 2, input 1A
- Connect the computer's "head 3" to processor 3, input 1A

**Note**

Input 1A resides on the highest priority M/E in a 3 M/E Encore system. If you wish to connect a *backup* DSK, use input 1B.

#### 7. D/A Connections —

- a. If your system includes analog, SDI or DVI D/As, connect video inputs to the D/As as required.
- b. Connect D/A outputs to the to the desired M/E input connectors.

#### 8. Router Connections — if you elect to use router connections, in place of (or in addition to) direct connections:

- a. For Ethernet controlled routers, ensure that they are connected to the same Switch as the Controller and processors. Ensure that each router has an unique IP address.
- b. To connect a single serial controlled router, use an RS-232 cable to connect the router to the Controller's **EXT COMM** port. In Chapter 2, refer to the "[Controller Rear Panels](#)" section on page 58 for details.
- c. To connect two (or more) serial routers, a third-party Ethernet-to-Serial converter is required, such as the **Lantronix** model **UDS100**, **UDS200** or **UDS2100** (<http://www.lantronix.com>). Note that each **UDS2100** can control two serial routers.
  - Using RS-232 cables, connect each router to the **UDS2100**.
  - Set up a static IP address on the Lantronix. The recommended range is **192.168.0.191 - 192.168.0.240**. Refer to the **Lantronix User's Guide** for instructions.
  - Using an Ethernet cable, connect the **UDS2100** to the same switch as the Controller and processors.

### 3. Hardware Installation

Installation

- d. Ensure that all sources are connected to your router(s).
  - e. Connect all selected router outputs to the desired M/E inputs on VP 1.
9. **ScreenPRO-II Connections** — if your system includes one (or more) destination ScreenPRO-II units, you can configure them for internal or external routing:
- a. When **External** routers are used, connect two outputs from an Analog router to **any two HD-15 inputs** on the ScreenPRO-II. An SDI router can also be connected to BNC inputs **1** and **2**. During setup, these specific patches will be defined using the **Output Patch Menu**.
  - b. When **Internal** routing is used, connect Analog sources to inputs **1 - 8** on the HD-15 connectors, and SDI sources to BNC inputs **1** and **2**. During setup, these patches will be defined using the **Input Patch Menu**.

In Chapter 6, see the [“ScreenPRO-II Destination Setup”](#) section for details.

10. **Output Connections** —

- a. For each VP or VPx, connect the analog or digital **Preview Output** to the input of the associated Preview Monitor.
- b. For each VP or VPx, connect the analog or digital **Program 2 Output** to the input of the associated Program Monitor.
- c. For each VP or VPx, connect the analog or digital **Program 1 Output** to the input of the associated projector.
- d. Connect the **Program Out HD/SDI** connector to an SDI or HDTV monitor as required, or to the proper video distribution equipment.

**Note**

This output only works if the selected output resolution is a valid SDI or HD/SDI format.

- 11. **Link Connections** — in a widescreen application, the **Program Link** and **Source Link** connections (DVI-I) are used to connect processors together, and bridge inputs and outputs for the proper “overlap” between projectors. Refer to the [“Program and Source Link Connections”](#) section on page 98 for instructions.
- 12. **Aux Destinations** — you can configure three types of Aux destinations: **Aux** (monitors), **ImagePRO Aux** and **PresentationPRO-II Aux**. Refer to Appendix D, [“Working With Destinations”](#) on page 393 for interconnection details.
- 13. **Power Connection** — connect AC power cords to all Encore and peripheral equipment, and then to AC outlets.
- 14. **Tally Connection** — the Controller provides one 25-pin D connector for issuing “relay closure” commands to external devices. Eight circuits are provided. In Appendix A, refer to the [“Tally Connector”](#) section on page 374 for details.
- 15. **System ID** — Using the **Unit ID Selector**, set the ID of Processor #1 to **1**, Processor #2 to **2**, and Processor #3 to **3**. Each must have a unique ID. Remember that you can redefine IDs using numbers **17 - 32**. In Chapter 5, see the [“Miscellaneous Menu”](#) section on page 196 for details.
- 16. **Power On** — all power on instructions are covered in Chapter 6.

With all connections made, continue with Chapter 4, [“Controller Orientation”](#) on page 107. Remember that you can create widescreen destinations using processors that do not contain the same number of M/E boards. These procedures are covered in Chapter 6, [“System Setup.”](#)

### 3. Hardware Installation

#### Installation

## Wide Screen Configuration Plus Wide Screen Preview

The figure below illustrates a “triple” wide screen configuration that includes a fourth VP or VPx, which is used to create a combined wide screen program/preview display.

Please note:

- Because the fourth VP or VPx provides up to 6 PIPs, this procedure is ideal for displaying a double or triple wide screen configuration on a single monitor.

#### Note

This is the only configuration in which a VPx can be used in a single processor, standalone mode.

- For configurations using more than 3 processors, additional dedicated “preview” processors may be required, along with additional monitors.

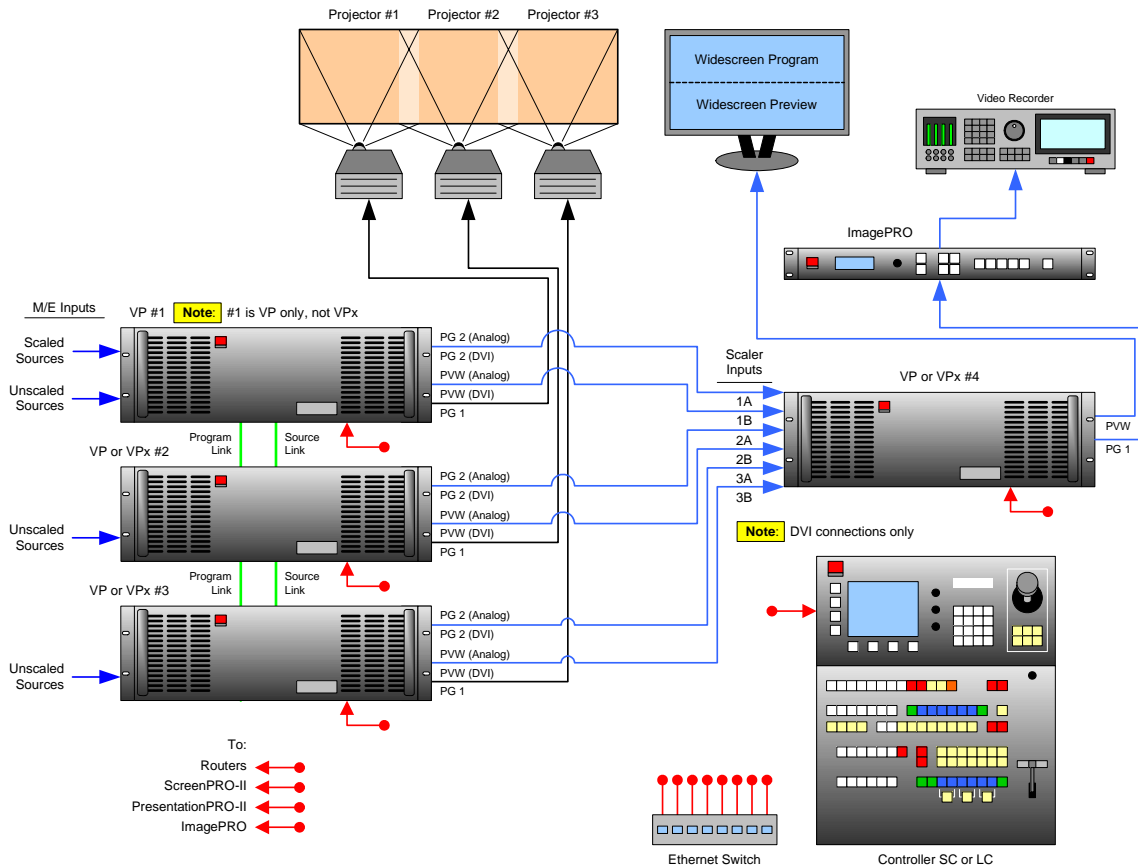


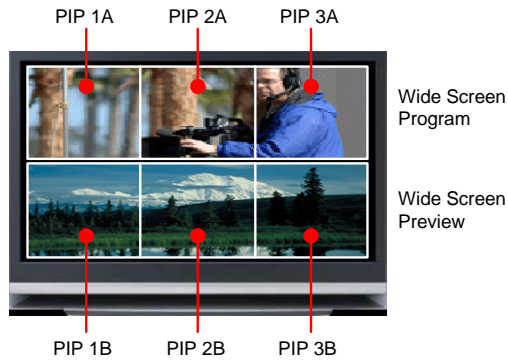
Figure 3-4. Block Diagram, Wide Screen Encore Configuration with Wide Screen Preview

### 3. Hardware Installation

#### Installation

Please note the following points regarding this configuration:

- Processor #4 receives DVI Program and Preview feeds from processors #1, #2 and #3.
- Using Processor #4, three PIPs are scaled and positioned to create the wide screen Program display, and three more are scaled to create the Preview display.



**Figure 3-5.** Wide Screen Program/Preview Monitor PIPs

- Processor #4's **Preview** output is routed to the display for viewing the combined wide screen program/preview output.
- Processor #4's **Program** output is routed to an ImagePRO for scaling, and then to an SDI or HD-SDI recorder. This configuration enables you to record the combined wide screen program/preview output.

In addition to the equipment listed in [Table 3-4](#) on page 72, you will also need:

**Table 3-5.** Equipment List, Additional Wide Screen Program/Preview Requirements

Qty.	Item	Note
1	VP or VPx	Assigned as Video Processor #4
1	DVI or Analog Monitor	For wide screen program/preview display
1	Ethernet cable	Customer supplied
6	DVI interconnect cables	Inputs to video processor #4 (customer supplied)
2	Interconnect cables	Video processor #4 outputs (Analog, Video and/or DVI as required)
1	ImagePRO	Optional, for use as output scaler (customer supplied)
1	SDI or HD-SDI Video Recorder	Optional, to record combined wide screen output (customer supplied)

- Use the following steps to install an Encore system that includes a combined wide screen program/preview display:
  1. Follow all steps to install a **Wide Screen Encore Application**, as outlined in the "[Wide Screen Configuration](#)" section on page 72. You do not need to install the six individual monitors for program and preview displays, because you will be using *one* monitor instead.
  2. Rack mount processor #4.
  3. Connect **Ethernet** from processor #4 to the Ethernet Switch.

### 3. Hardware Installation

#### Installation

4. **Source Connections** — connect DVI outputs from processors one, two and three to processor #4's scaler inputs:
  - ~ Connect processor #1 DVI Program 2 output to processor #4 input **1A**.
  - ~ Connect processor #1 DVI Preview 2 output to processor #4 input **1B**.
  - ~ Connect processor #2 DVI Program 2 output to processor #4 input **2A**.
  - ~ Connect processor #2 DVI Preview 2 output to processor #4 input **2B**.
  - ~ Connect processor #3 DVI Program 2 output to processor #4 input **3A**.
  - ~ Connect processor #3 DVI Preview 2 output to processor #4 input **3B**.

**Note**

Program 2 output is used because it is a clean feed, without any edge feathering or data doubling in the signal.

5. **Output Connections** —
  - ~ Connect processor #4's analog or digital **Preview Output** to the input of your widescreen preview monitor.
  - ~ (Optional, for video recording) Connect processor #4's analog or digital **Program Output 1** or **2** to the input of the ImagePRO. Connect the ImagePRO's output to the input of your recorder. Refer to the "**ImagePRO User's Guide**" for connection and setup details.
6. **Power Connection** — connect AC power cords to the AC Power connectors on the rear of processor #4, the monitor and the ImagePRO.
7. **System ID** — Using the **Unit ID Selector**, set the ID of processor #4 to **4**.

**Note**

Each processor must have a unique ID.

8. **Power On** — all power on instructions are covered in Chapter 6.

With all connections made, continue with Chapter 4, "[Controller Orientation](#)" on page 107.

#### Completing Wide Screen Preview Setup

Once you are familiar with the Controller, all system setup procedures and basic Encore operations, you must complete the following operational setup steps — in order to properly configure processor #4 and its Preview output.

**Note**

Two different methods are available for connecting processor sources: **multi-button** and **single button**.

- **Multi-button method** — Use the following steps to complete your wide screen preview setup, using *six individual buttons* for processor sources:
  1. Set up processor #4 as a unique Encore destination. In Chapter 6, refer to the "[Destination Setup](#)" section on page 277.
  2. On the Controller, identify six buttons on the **Source Selection Bus** that you want to use as the inputs from processors 1, 2 and 3.
  3. Set up these designated inputs as direct DVI connections. In Chapter 6, refer to the "[Input Setup](#)" section on page 293 for details.

### 3. Hardware Installation

Installation

4. Select the destination that you assigned to processor #4.
  5. Scale and align three PIPs for the “Preview” portion of the display, and three PIPs for the “Program” portion, as illustrated in [Figure 3-5](#) on page 77.
- **Single-button method** — Use the following steps to complete your wide screen preview setup, using *one button* for all six processor sources.

#### Note

This method sets up a “phantom” DVI D/A router, which takes advantage of the fact that all processor DVI outputs have identical resolutions — and thus only one input configuration file is required. This method only uses one source button on the Controller, instead of six buttons on the source bus.

1. Set up processor #4 as a unique Encore destination. In Chapter 6, refer to the “[Destination Setup](#)” section on page 277.
2. On the Controller, identify *one button* on the **Source Selection Bus** that you want to use for all DVI D/A inputs to processor #4.
3. In the **Router Specification Menu**, create a DVI D/A router. In Chapter 6, refer to the “[D/A Setup](#)” section on page 274.
4. On the “**Number of Outputs**” line, specify **6**.
5. Using the **Output Patch Menu**, patch all 6 outputs (from processors 1, 2 and 3) to processor #4. In Chapter 6, refer to the “[Router Setup](#)” section on page 270.
6. Using the **Input Patch Menu**, select the DVI D/A source button (as identified in step 2 above), and patch it to the DVI D/A router. In Chapter 6, refer to the “[Input Patching](#)” section on page 275.
7. Select the destination that you assigned to processor #4.
8. In the **Layer Control Section**, select **Layer 1A**, then select the DVI D/A source. Be sure to save an input configuration file for this source.
9. Scale and align the first PIP for the “Preview” portion of the display, then repeat this step for the remaining layers (**2A** through **3B**). Use [Figure 3-5](#) on page 77 for reference.

### 3. Hardware Installation

#### Installation

## Single Screen Stack Configuration

“Stacking” is a configuration method that provides access to six mixers, with the ability to display up to 12 PIPs on screen simultaneously. Please note:

- Video Processors (VP) must be used as “master” units in a stack.
- Both VP and VPx units can be used as “slave” units in a wide screen stack.
- Stacking is available for both the Controller SC and LC.
- A stack configuration does *not* add any additional video delay.

To make 12 PIPs available, processors are combined in pairs. The first processor’s Program and Preview outputs are connected to the second processor’s Background (BG) A and B inputs. In this manner, two “Three M/E” systems are stacked to create a six M/E processor. Using the six PIPs from each processor, 12 PIPs are available.

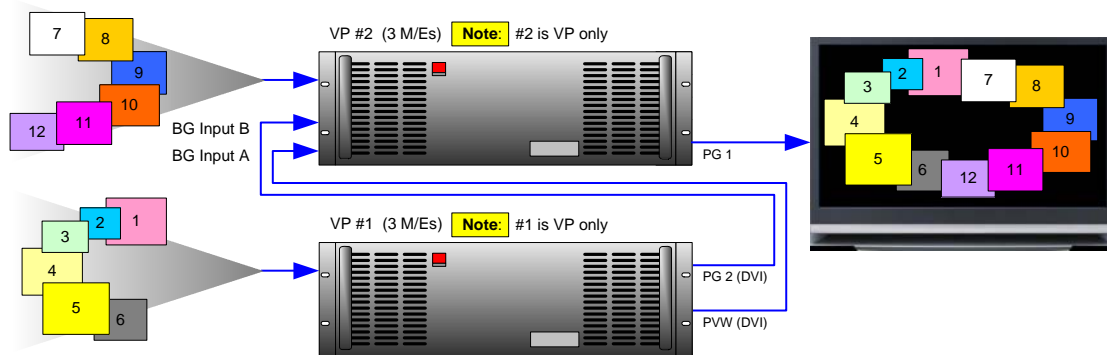


Figure 3-6. Single Screen Stack with 12 PIPs

The figure below illustrates a block diagram of a single screen “stack” configuration. Aux destinations are not shown. Use this diagram for reference in the following procedure.

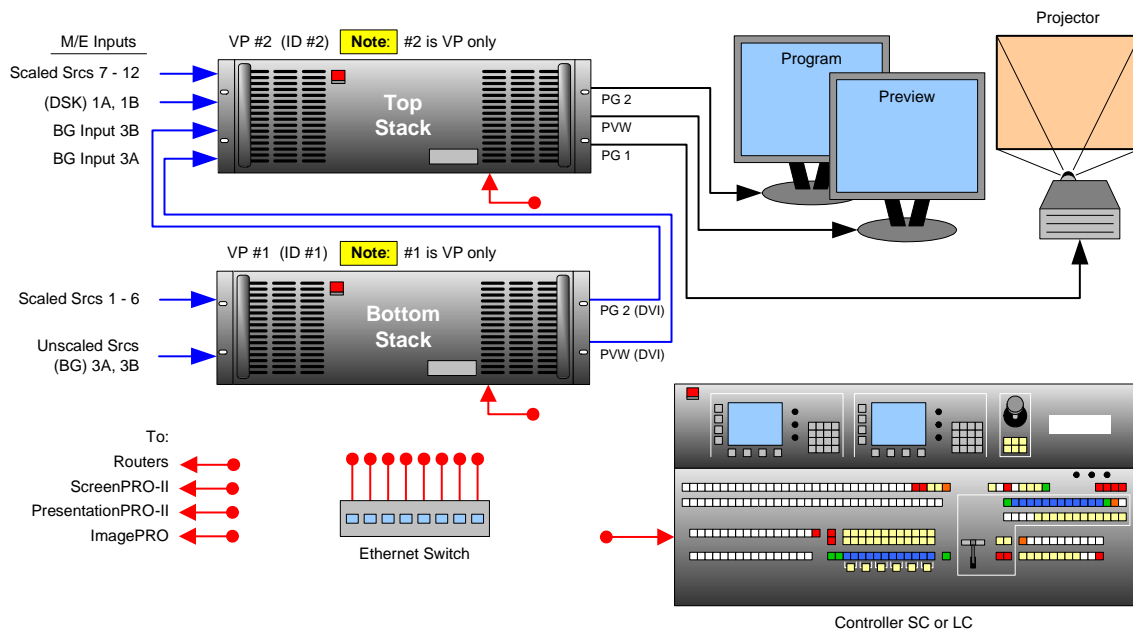


Figure 3-7. Block Diagram, Single Screen Stack Configuration



### 3. Hardware Installation

#### Installation

For this procedure, you will need:

**Table 3-6.** Equipment List, Single Screen Stack Configuration

Qty.	Item	Note
2	VP	Master units (ID#1 and ID#2) must be VP, not VPx. The ID of the bottom stack VP must always be lower than the ID of the top stack VP.
1	Controller	Model SC or LC
1	Video Projector	Customer supplied
2	DVI or Analog Monitors	Program and Preview (customer supplied)
1	Ethernet Switch	Customer supplied
3	Ethernet cables	Customer supplied. Additional cables required for routers.
2	DVI Interconnect cables	Connects bottom stack Processor to top stack Processor
TBD	Sources, routers, cables	Analog, Video and/or DVI as required (customer supplied)

- Use the following steps to install a single screen “stack” configuration:

#### Important

It is recommended that each stack consists of two “fully loaded” processors, each with three M/Es. If necessary, you *can* use a mis-matched configuration (e.g., two M/Es in the bottom stack, three in the top), but the top stack *must always* have three M/Es installed. In this way, your stacked set will never have anything less than four M/Es available.

1. Follow the unpacking procedures as listed in the “[Unpacking and Inspection](#)” section on page 62.
2. In Appendix A, refer to the “[Physical and Electrical Specifications](#)” section on page 367 for electrical and mechanical details.
3. In Chapter 2, refer to the “[Video Processor Rear Panel](#)” section on page 45 and the “[Controller Rear Panels](#)” section on page 58 for all connector locations.
4. For each VP, follow the rack mount procedures as outlined in the “[Rack-Mount Installation](#)” section on page 62. Remember that Master units (ID#1 and ID#2) must be VP, not VPx.
5. **Ethernet Connections** — a totally “local” network connection is recommended. Using Ethernet cables:
  - a. Connect the processors and Controller to the Ethernet Switch.
  - b. Connect router(s) to the Switch.
  - c. As required, connect ScreenPRO-II, PresentationPRO-II and ImagePRO systems to the Switch.
6. **Direct Source Connections** — if you elect to use direct connections, in place of (or in addition to) router connections:
  - a. As an important prerequisite, complete your “[Connection Charts](#)” on page 89 to streamline your source installation procedure.

### 3. Hardware Installation

#### Installation

- b. Using the information from the chart:
  - Connect “direct” sources 1 - 6 to each M/E’s input connectors on the “**bottom stack**” processor.
  - Connect “direct” sources 7 - 12 to each M/E’s input connectors on the “**top stack**” processor.
- c. Connect unscaled **Background** sources to the bottom stack:
  - Connect background source 1 to input 3A.
  - Connect background source 2 to input 3B.
- d. Connect unscaled **DSK** sources to the top stack:
  - Connect DSK source 1 to input 1A.
  - Connect DSK source 2 to input 1B.

#### 7. Stack Interconnections —

- a. Connect the bottom stack’s **DVI Preview Output** to the top stack’s Background 1 input (**3A**).
- b. Connect the bottom stack’s **DVI Program Output** to the top stack’s Background 2 input (**3B**).

#### 8. D/A Connections —

- a. If your system includes analog, SDI or DVI D/As, connect video inputs to the D/As as required.
- b. Connect D/A outputs to the to the desired M/E input connectors.

#### 9. Router Connections — if you elect to use router connections, in place of (or in addition to) direct connections:

- a. For Ethernet controlled routers:
  - Ensure that the router(s) are connected to the same Ethernet Switch as the Controller and processors.
  - Ensure that each router has an unique IP address.
- b. To connect a single serial controlled router, use an RS-232 cable to connect the router to the Controller’s **EXT COMM** port. In Chapter 2, refer to the “[Controller Rear Panels](#)” section on page 58 for details.
- c. To connect two (or more) serial routers, a third-party Ethernet-to-Serial converter is required, such as the **Lantronix** model **UDS100**, **UDS200** or **UDS2100** (<http://www.lantronix.com>). Each **UDS2100** can control two serial routers.
  - Using RS-232 cables, connect each router to the **UDS2100**.
  - Set up a static IP address on the Lantronix. The recommended range is **192.168.0.191 - 192.168.0.240**.
  - Using an Ethernet cable, connect the **UDS2100** to the same Ethernet Switch as the Controller and processors.
- d. Ensure that all sources are connected to your router(s).
- e. Connect all selected router outputs to the desired M/E inputs:
  - For PIPs 1 - 6, connect router outputs to the desired M/E inputs on the “**bottom stack**” processor.
  - For PIPs 7 - 12, connect router outputs to the desired M/E inputs on the “**top stack**” processor.

### 3. Hardware Installation

#### Installation

- 10. ScreenPRO-II Connections** — if your system includes one (or more) destination ScreenPRO-II units, you can configure the units for internal or external routing:
- When **External** routers are used, connect two outputs from an Analog router to **any two HD-15 inputs** on the ScreenPRO-II. An SDI router can also be connected to BNC inputs **1** and **2**. During setup, these specific patches will be defined using the **Output Patch Menu**.
  - When **Internal** routing is used, connect Analog sources to inputs **1 - 8** on the HD-15 connectors, and SDI sources to BNC inputs **1** and **2**. During setup, these patches will be defined using the **Input Patch Menu**.

In Chapter 6, see the "[ScreenPRO-II Destination Setup](#)" section for details.

- 11. Output Connections** — all output monitor and projector connections originate from the "**top stack**" processor:
- Connect the analog or digital **Preview Output** to the input of the associated Preview Monitor.
  - Connect the analog or digital **Program 2 Output** to the input of the associated Program Monitor.
  - Connect the analog or digital **Program 1 Output** to the input of the associated projector.
  - Connect the **Program Out HD/SDI** connector to an SDI or HDTV monitor as required, or to the proper video distribution equipment.

**Note**

This output only works if the selected output resolution is a valid SDI or HD/SDI format.

- If you elect to output in an interlaced format (e.g., 1920 x 1080i), connect the top stack's **H Sync Output** signal (located on the **Program 2 Out Analog** connector) to the **Genlock** input on the bottom stack.

**Note**

Using a VGA to 5xBNC breakout cable, the **H Sync Output** line is typically a white or gray cable.

- 12. Aux Destinations** — you can configure three types of Aux destinations: **Aux** (monitors), **ImagePRO Aux** and **PresentationPRO-II Aux**. Refer to Appendix D, "[Working With Destinations](#)" on page 393 for interconnection details.
- 13. Power Connection** — connect AC to all Encore and peripheral equipment.
- 14. Tally Connection** — the Controller provides one 25-pin D connector for issuing "relay closure" commands to external devices. Eight circuits are provided. In Appendix A, refer to the "[Tally Connector](#)" section on page 374 for details.
- 15. System ID** — Using the **Unit ID Selector**, set the ID of the bottom stack processor (VP only) to **1**. Set the ID of the top stack processor to **2** (VP or VPx).

**Important**

The ID of the bottom stack processor must *always* be lower than the ID of the top stack processor. Remember that Master units (ID#1 and ID#2) must be VP, not VPx.

- 16. Power On** — all power on instructions are covered in Chapter 6.

Continue with Chapter 4, "[Controller Orientation](#)" on page 107.

### 3. Hardware Installation

#### Installation

## Wide Screen Stack Configuration

The figure below illustrates a block diagram of a wide screen “stack” configuration. Aux destinations are not shown. Use this diagram for reference in the following procedure.

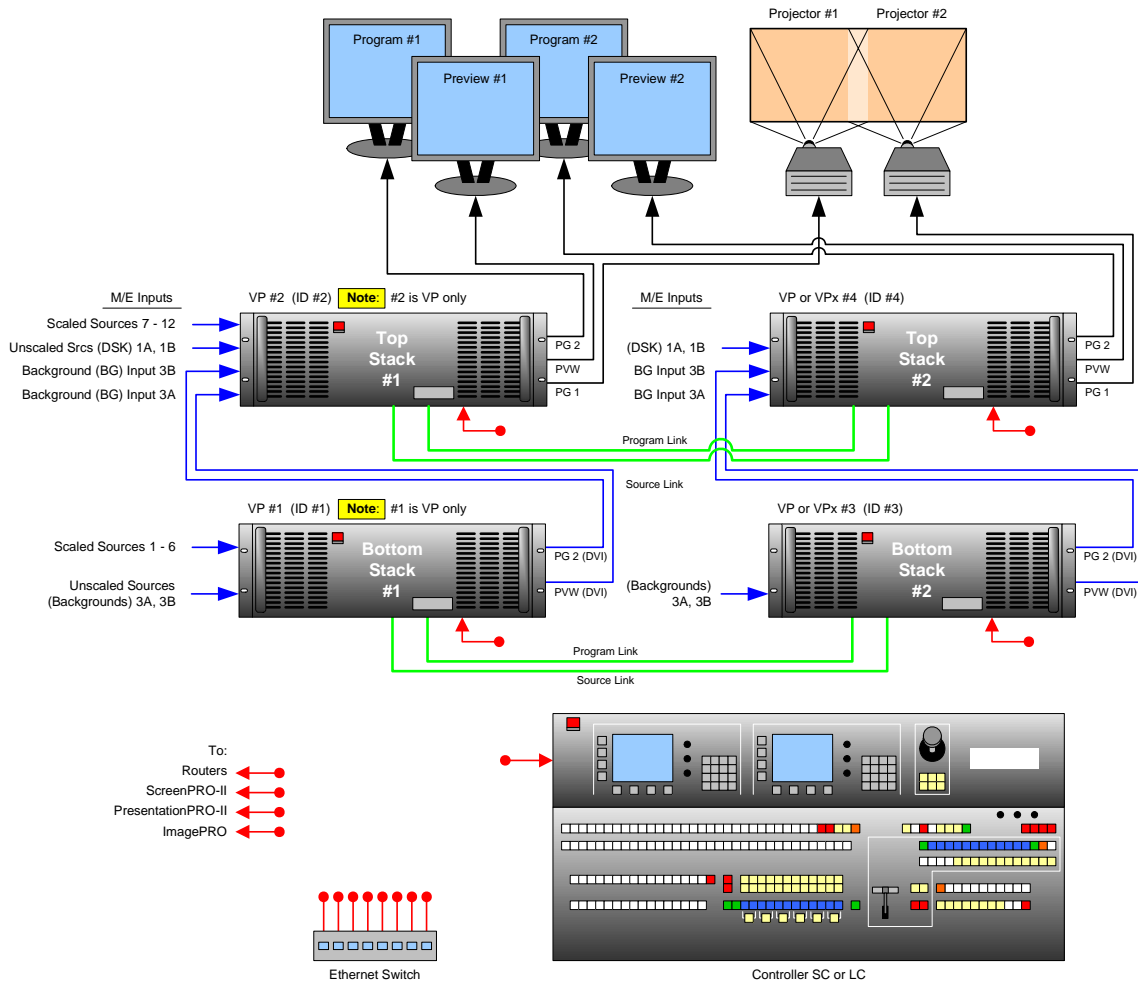


Figure 3-8. Block Diagram, Wide Screen Stack Configuration

For this procedure, you will need:

Table 3-7. Equipment List, Wide Screen Stack Configuration

Qty.	Item	Note
2	VP	Master units (ID#1 and ID#2) must be VP, not VPx.
2	VP or VPx	The ID of the bottom stack processor must always be lower than the ID of the top stack processor. Use 6 total processors for triple wide screen, use 8 for quadruple wide, etc.
1	Controller	Model SC or LC
2	Video Projectors	Customer supplied
4	DVI or Analog Monitors	Program and Preview (customer supplied)

Table 3-7. Equipment List, Wide Screen Stack Configuration (Continued)

Qty.	Item	Note
1	Ethernet Switch	Customer supplied
5	Ethernet cables	Customer supplied. Additional cables required for routers.
TBD	Program Link Cables (DVI-I)	Use 2 for double wide screen application, <b>left justification</b>
		Use 4 for triple wide screen application, <b>left justification</b>
		Use 4 for double wide screen application, <b>center justification</b>
		Use 6 for triple wide screen application, <b>center justification</b>
TDB	Source Link Cables (DVI-I)	Minimum 4 for double wide screen application.
TBD	Sources, routers, cables	Analog, Video and/or DVI as required (customer supplied)

- Use the following steps to install a wide screen “stack” configuration:

**Important**

It is recommended that each stack consists of two “fully loaded” processors, each with three M/Es. If necessary, you *can* use a mis-matched configuration (e.g., two M/Es in the bottom stack, three in the top), but the top stack *must always* have three M/Es installed. In this way, your stacked set will never have anything less than four M/Es available.

1. Follow the unpacking procedures as listed in the “[Unpacking and Inspection](#)” section on page 62.
2. In Appendix A, refer to the “[Physical and Electrical Specifications](#)” section on page 367 for electrical and mechanical details.
3. In Chapter 2, refer to the “[Video Processor Rear Panel](#)” section on page 45 and the “[Controller Rear Panels](#)” section on page 58 for all connector locations.
4. For each processor, follow the rack mount procedures as outlined in the “[Rack-Mount Installation](#)” section on page 62. Remember that master units (ID#1 and ID#2) must be VP, not VPx.
5. **Ethernet Connections** — a totally “local” network connection is recommended. Using Ethernet cables:
  - a. Connect the processors and Controller to the Ethernet Switch.
  - b. Connect router(s) to the Switch.
  - c. As required, connect ScreenPRO-II, PresentationPRO-II and ImagePRO systems to the Switch.
6. **Direct Source Connections** — if you elect to use direct connections, in place of (or in addition to) router connections:
  - a. As an important prerequisite, complete your “[Connection Charts](#)” on page 89 to streamline the source installation procedure.
  - b. Using information from the charts, connect the desired “direct” sources to each M/E’s input connectors on each stack. Note that in a wide screen stack system, scaled sources only connect to stack #1. The “link” connections carry the signals to the other stacks:

### 3. Hardware Installation

#### Installation

- On stack #1 only, connect “direct” sources 1 - 6 to each M/E’s input connectors on the “**bottom stack**” processor.
  - On stack #1 only, connect “direct” sources 7 - 12 to each M/E’s input connectors on the “**top stack**” processor.
- c. Unscaled **Backgrounds** must originate from computers with multi-head graphics cards, and connect to the same input on each “bottom stack” processor.

▲ To connect an unscaled background source in a double widescreen stack system (each processor with three M/Es):

- On the first stack, connect the computer’s “head 1” to the bottom stack processor, input 3A
- On the second stack, connect the computer’s “head 2” to the bottom stack processor, input 3A

#### Note

Input 3A resides on the lowest priority M/E in a 3 M/E system. To connect a *second* background source, use input 3B on both stacks.

- d. The **DSK** source *may* originate from a computer with a multi-head graphics card, but it is not a requirement.

▲ Connecting a single-head graphics card to processor 4 only would enable a bug to be placed *only* in that screen space.

#### Note

The **DSK Setup Menu** allows you to pick an individual ID within a widescreen on which to perform DSK setup.

If you elect to use a multi-head graphics card for the DSK, ensure that you connect to the same input on each processor — to the highest priority M/E.

▲ To connect an unscaled DSK source in a double widescreen stack system (each processor with three M/Es):

- On the first stack, connect the computer’s “head 1” to the top stack processor, input 1A
- On the second stack, connect the computer’s “head 2” to the top stack processor, input 1A

#### Note

Input 1A resides on the highest priority M/E in a 3 M/E Encore system. If you wish to connect a backup (or alternate) DSK, use input 1B on both stacks.

#### 7. Stack Interconnections —

- a. On the first stack:

- Connect the bottom stack’s **DVI Preview Output** to the top stack’s Background 1 input (**3A**).
- Connect the bottom stack’s **DVI Program Output** to the top stack’s Background 2 input (**3B**).

### 3. Hardware Installation

Installation

- b. On the second stack:
  - Connect the bottom stack's **DVI Preview Output** to the top stack's Background 1 input (**3A**).
  - Connect the bottom stack's **DVI Program Output** to the top stack's Background 2 input (**3B**).

#### 8. D/A Connections —

- a. If your system includes analog, SDI or DVI D/As, connect video inputs to the D/As as required.
- b. Connect D/A outputs to the to the desired M/E input connectors on the first stack only.

#### 9. Router Connections — if you elect to use router connections, in place of (or in addition to) direct connections:

- a. For Ethernet controlled routers, ensure that they are connected to the same Switch as the Controller and processors. Ensure that each router has an unique IP address.
- b. To connect a single serial controlled router, use an RS-232 cable to connect the router to the Controller's **EXT COMM** port. In Chapter 2, refer to the "[Controller Rear Panels](#)" section on page 58 for details.
- c. To connect two (or more) serial routers, a third-party Ethernet-to-Serial converter is required, such as the **Lantronix** model **UDS100**, **UDS200** or **UDS2100** (<http://www.lantronix.com>). Each **UDS2100** can control two serial routers.
  - Using RS-232 cables, connect each router to the **UDS2100**.
  - Set up a static IP address on the Lantronix. The recommended range is **192.168.0.191 - 192.168.0.240** — so as not to conflict with other devices.
  - Using an Ethernet cable, connect the **UDS2100** to the same Ethernet Switch as the Controller and processors.
- d. Ensure that all sources are connected to your router(s).
- e. Connect all selected router outputs to the desired M/E inputs on the first stack only:
  - For PIPs 1 - 6, connect router outputs to the desired M/E inputs on the "**bottom stack**" processor.
  - For PIPs 7 - 12, connect router outputs to the desired M/E inputs on the "**top stack**" processor.
- f. If your configuration includes one (or more) destination ScreenPRO-II units, connect two outputs from each router to each ScreenPRO-II.

#### 10. ScreenPRO-II Connections — if your system includes one (or more) destination ScreenPRO-II units, you can configure them for internal or external routing:

- a. When **External** routers are used, connect two outputs from an Analog router to **any two HD-15 inputs** on ScreenPRO-II. An SDI router can also be connected to BNC inputs **1** and **2**. During setup, these specific patches will be defined using the **Output Patch Menu**.
- b. When **Internal** routing is used, connect Analog sources to inputs **1 - 8** on the HD-15 connectors, and SDI sources to BNC inputs **1** and **2**. During setup, these patches will be defined using the **Input Patch Menu**.

In Chapter 6, see the "[ScreenPRO-II Destination Setup](#)" section for details.

### 3. Hardware Installation

#### Installation

11. **Output Connections** — all output monitor and projector connections originate from the “**top stack**” processors:
  - a. On each “top stack” processor, connect the analog or digital **Preview Output** to the input of the associated Preview Monitor.
  - b. On each “top stack” processor, connect the analog or digital **Program 2 Output** to the input of the associated Program Monitor.
  - c. On each “top stack” processor, connect the analog or digital **Program 1 Output** to the input of the associated projector.
  - d. Connect the “top stack” **Program Out HD/SDI** connector to an SDI or HDTV monitor, or to the proper video distribution equipment.

**Note**

This output only works if the selected output resolution is a valid SDI or HD/SDI format.

- e. If you elect to output in an interlaced format (e.g., 1920 x 1080i), connect each top stack’s **H Sync Output** signal (located on the **Program 2 Out Analog** connector) to the **Genlock** input on the bottom stack.

**Note**

Using a (customer supplied) VGA to 5xBNC breakout cable, the **H Sync Output** line is typically a white or gray cable.

12. **Aux Destinations** — you can configure three types of Aux destinations: **Aux** (monitors), **ImagePRO Aux** and **PresentationPRO-II Aux**. Refer to Appendix D, “[Working With Destinations](#)” on page 393 for interconnection details.
13. **Link Connections** — in a widescreen application, the **Program Link** and **Source Link** connections (DVI-I) are used to connect processors together, and bridge inputs and outputs for the proper “overlap” between projectors. Refer to the “[Program and Source Link Connections](#)” section on page 98 for instructions.
14. **Power Connection** — connect AC power cords to all Encore and peripheral equipment, and then to AC outlets.
15. **Tally Connection** — the Controller provides one 25-pin D connector for issuing “relay closure” commands to external devices. Eight circuits are provided. In Appendix A, refer to the “[Tally Connector](#)” section on page 374 for details.
16. **System ID** — Using the **Unit ID Selector**:
  - a. On the first stack, set the ID of the bottom stack Processor to **1** (VP only). Set the ID of the top stack Processor to **2** (VP or VPx).
  - b. On the second stack, set the ID of the bottom stack Processor to **3** (VP or VPx). Set the ID of the top stack Processor to **4** (VP or VPx).

**Important**

In each stack, the ID of the bottom stack Processor must *always* be lower than the ID of the top stack Processor. Remember that master units (ID#1 and ID#2) must be VP only, not VPx.

17. **Power On** — all power on instructions are covered in Chapter 6. Continue with Chapter 4, “[Controller Orientation](#)” on page 107.



---

# Connection Charts

A series of **Connection Charts** are provided on the following pages to assist with your input connections. The following topics are discussed:

- [Connection Overview](#)
- [Chart Instructions](#)
- [Sample Connection Charts](#)
- [Blank Connection Charts](#)

## Connection Overview

Please remember the following important points regarding system interconnection:

- Each M/E has two scalers, each with three inputs: **Analog**, **HD/SDI** and **DVI-I**. The DVI-I connector has both an **analog** and a **digital** connection.

**Note**

The analog connection on the DVI connector can only be used for unscaled inputs. It cannot be sent to the scaler. The digital side can go to either the scaled or unscaled channel.

- You can connect sources and assign them to Controller buttons — but only one source can be assigned to a scaler at a time. For unscaled sources, connect a maximum of two backgrounds and two DSK sources.

**Note**

Two DSK sources can be connected to the system on **1A** and **1B** — but only one can be used at a time.

- You can connect a source *directly* to an input, or you can connect the output of a router to an input. The use of routers offers less restrictions with regard to assigning sources to layers.
- **Analog** inputs can be used to connect composite, S-Video (Y/C) and component video sources. Customer supplied breakout cables are required.
- The **DSK** source *always* connects to one of the two **DVI-I** inputs on the M/E 1 board — electronically, the highest priority board in the system.
- **Background** sources always connect to the lowest priority board in your system, but that board varies depending upon the number of M/E boards present. In Chapter 2, see the "[A Word About M/E Connector Priority](#)" section on page 50.
- Remember that **VPx** is designed for widescreen and stack configurations. A VPx cannot be used in a single processor configuration.

## 3. Hardware Installation

### Connection Charts

## Chart Instructions

Following are instructions for using the connection charts:

- **Router I/O Charts**

Complete one chart for each video router in your system (up to the maximum 8).

- ~ Column 1: list the sources that are connected to the router inputs.
- ~ Column 2: list the Encore button(s) to which the source will be patched.
- ~ Column 4: list where each router output will be connected.

**Note**

The router charts can also be used for D/A connections.

- **Direct Encore Input Chart**

Complete the chart for any sources that will be connected directly to Encore.

- ~ Column 1: list the direct connection source name.
- ~ Column 2: list the Encore button(s) to which the source will be patched.
- ~ Column 3: list the VP or VPx to which the source is connected.
- ~ Column 4: list the specific M/E input (and format) to which the source is connected: DVI, HD-SDI or Analog.

- **Encore Destination Chart**

Complete the chart for all Encore destinations.

- ~ Column 1: list the VP(s) or VPx(s) that comprise the destination.
- ~ Column 2: list the Encore destination assignment.
- ~ Column 3: list the screen to which the destination is routed.
- ~ Column 4: list any notes as necessary.

## Sample Connection Charts

Following are sample connection charts for an Encore system comprised of 1 x analog router, 2 x direct inputs, and 6 x destinations.

**Table 3-8.** Router I/O Chart #1 (sample)

Router #1		Router Type: <input type="checkbox"/> Analog <input type="checkbox"/> Digital <input type="checkbox"/> DVI	
Source Name	Encore Input #	Router Input/Output	Connects to:
DVD A	1 / 33	1	VP 1 - 1A
DVD B	2 / 34	2	VP 1 - 1B
Flash CPU	3	3	VP 1 - 2A
		4	VP 1 - 2B
Multi A	4	5	VP 1 - 3A
Multi B	5	6	VP 1 - 3B
Multi C	6	7	ScreenPRO 5 - In 1
Multi D	7 / 39	8	ScreenPRO 5 - In 2
Key Dell 1	8	9	VP 3 - 2A
Key Dell 2	9	10	VP 3 - 2B
		11	VP 3 - 3A
		12	VP 3 - 3B
ImagePRO 2	13	13	
ImagePRO 1	14	14	ImagePRO 2 - In 3
ScreenPRO 2 Preview	15	15	ImagePRO 1 - In 2
BEM CPU	16	16	Bottom LC40

**Table 3-9.** Direct Encore Input Chart (sample)

Direct Encore Inputs			
Source Name	Encore Input #	Video Processor	Encore Port
Comp 1	59	1	1A, DVI
Comp 2	60	1	1B, DVI

**Table 3-10.** Encore Destination Chart (sample)

Destination	Device	Screen	Notes	
Controller SC	1	VP 1, VP 2	FLM Wide	DVI to FLM L and R
	2	VP 3	XLM Single	DVI to XLM
	3	VP 4	LC 40 Top	Pvw / Pgm Monitor
	4	ImagePRO 1	Any	A-14, HD-16, D-1
	5	SP 5	FLM Single	
	6	Router Aux 12	Downstage Mon	

### 3. Hardware Installation

#### Connection Charts

## Blank Connection Charts

The following blank connection charts are provided:

- [Router I/O Charts](#)
- [Direct Encore Input Chart](#)
- [Encore Destination Chart](#)

### Router I/O Charts

Complete one chart for each video router in your system. Encore supports up to eight routers. Note that these charts can also be used for D/As.

Table 3-11. Router I/O Chart #1

Router #1	Router Type: ___ Analog ___ Digital ___ DVI	
Source	Router Input/Output	Destination
	1	
	2	
	3	
	4	
	5	
	6	
	7	
	8	
	9	
	10	
	11	
	12	
	13	
	14	
	15	
	16	

### 3. Hardware Installation

Connection Charts

Table 3-12. Router I/O Chart #2

Router #2	Router Type: ___ Analog ___ Digital ___ DVI	
Source	Router Input/Output	Destination
	1	
	2	
	3	
	4	
	5	
	6	
	7	
	8	
	9	
	10	
	11	
	12	
	13	
	14	
	15	
	16	

Table 3-13. Router I/O Chart #3

Router #3	Router Type: ___ Analog ___ Digital ___ DVI	
Source	Router Input/Output	Destination
	1	
	2	
	3	
	4	
	5	
	6	
	7	
	8	
	9	
	10	
	11	
	12	
	13	
	14	
	15	
	16	

### 3. Hardware Installation

#### Connection Charts

Table 3-14. Router I/O Chart #4

Router #4	Router Type: ___ Analog ___ Digital ___ DVI	
Source	Router Input/Output	Destination
	1	
	2	
	3	
	4	
	5	
	6	
	7	
	8	
	9	
	10	
	11	
	12	
	13	
	14	
	15	
	16	

Table 3-15. Router I/O Chart #5

Router #5	Router Type: ___ Analog ___ Digital ___ DVI	
Source	Router Input/Output	Destination
	1	
	2	
	3	
	4	
	5	
	6	
	7	
	8	
	9	
	10	
	11	
	12	
	13	
	14	
	15	
	16	

### 3. Hardware Installation

Connection Charts

Table 3-16. Router I/O Chart #6

Router #6	Router Type: ___ Analog ___ Digital ___ DVI	
Source	Router Input/Output	Destination
	1	
	2	
	3	
	4	
	5	
	6	
	7	
	8	
	9	
	10	
	11	
	12	
	13	
	14	
	15	
	16	

Table 3-17. Router I/O Chart #7

Router #7	Router Type: ___ Analog ___ Digital ___ DVI	
Source	Router Input/Output	Destination
	1	
	2	
	3	
	4	
	5	
	6	
	7	
	8	
	9	
	10	
	11	
	12	
	13	
	14	
	15	
	16	

### 3. Hardware Installation

#### Connection Charts

Table 3-18. Router I/O Chart #8

Router #8	Router Type: ___ Analog ___ Digital ___ DVI	
Source	Router Input/Output	Destination
	1	
	2	
	3	
	4	
	5	
	6	
	7	
	8	
	9	
	10	
	11	
	12	
	13	
	14	
	15	
	16	

#### Direct Encore Input Chart

Complete the following chart for any sources that will be connected directly to Encore (such as a computer for a DVI background).

Table 3-19. Direct Encore Input Chart

Direct Encore Inputs		
Source	Video Processor	Encore Port



### 3. Hardware Installation

Connection Charts

#### Encore Destination Chart

Complete the following chart for all Encore destinations.

Table 3-20. Encore Destination Chart

		Destination	Device	Screen	Notes
Controller SC		1			
		2			
		3			
		4			
		5			
		6			
		7			
		8			
		9			
		10			
Controller LC		11			
		12			
		13			
		14			
		15			
		16			
		17			
		18			
		19			
		20			
		21			
		22			
		23			
		24			
		25			
		26			
		27			
		28			
		29			
		30			
		31			
		32			

### 3. Hardware Installation

#### Program and Source Link Connections

---

## Program and Source Link Connections

The following topics are discussed in this section:

- [Overview of Edge-Blending Technology](#)
- [Connecting Program and Source Links](#)

### Overview of Edge-Blending Technology

Edge-blending technology is becoming increasingly popular for supporting very large high-resolution displays. The technology is very flexible and supports a wide range of screen configurations. A typical three projector system is illustrated below. As shown in the figure, multiple projectors are used to project on a common surface to create one high-resolution image. The creation of a seamless image requires careful attention to detail. High quality results are dependent upon a system-level approach that integrates content creation, video processing, projector setup and system adjustments as described below.

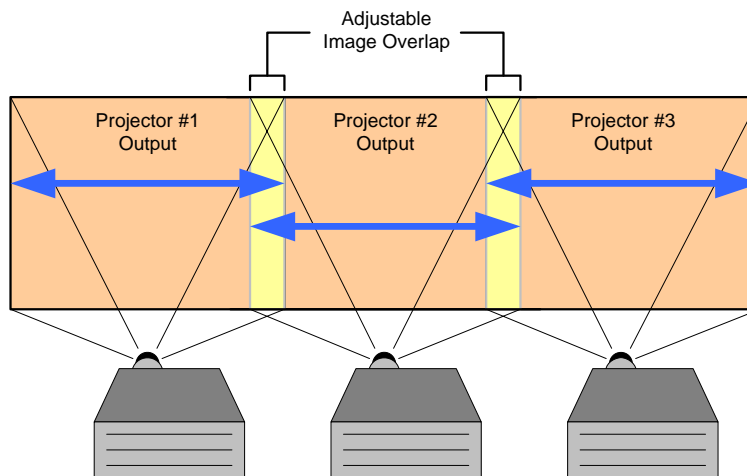


Figure 3-9. Typical three projector system

### Content Creation

When projecting an image across a large screen, it is important to maintain sufficient resolution to obtain a crisp, clear image from the perspective of the viewer. Generally, high-resolution source material is used to maintain content that is pleasing to the eye. There are two methods that are commonly used to generate wide-screen source material, each of these methods is explained below.

- **Use of a Single High Definition Image**

High Definition source material has a resolution of 1920 pixels x 1080 lines. Images of this type can be reformatted to drive multiple screens. The reformatting is usually performed by a seamless switching system such as the Encore Presentation System.

Reformatting allows the resultant images to be processed for providing seamless switching, integration of picture-in-picture video and keying features. Note that the input image can be effectively spread to multiple screens, however, the

### 3. Hardware Installation

#### Program and Source Link Connections

inherent resolution of the output image remains that of the source material, 1920x1080 pixels.

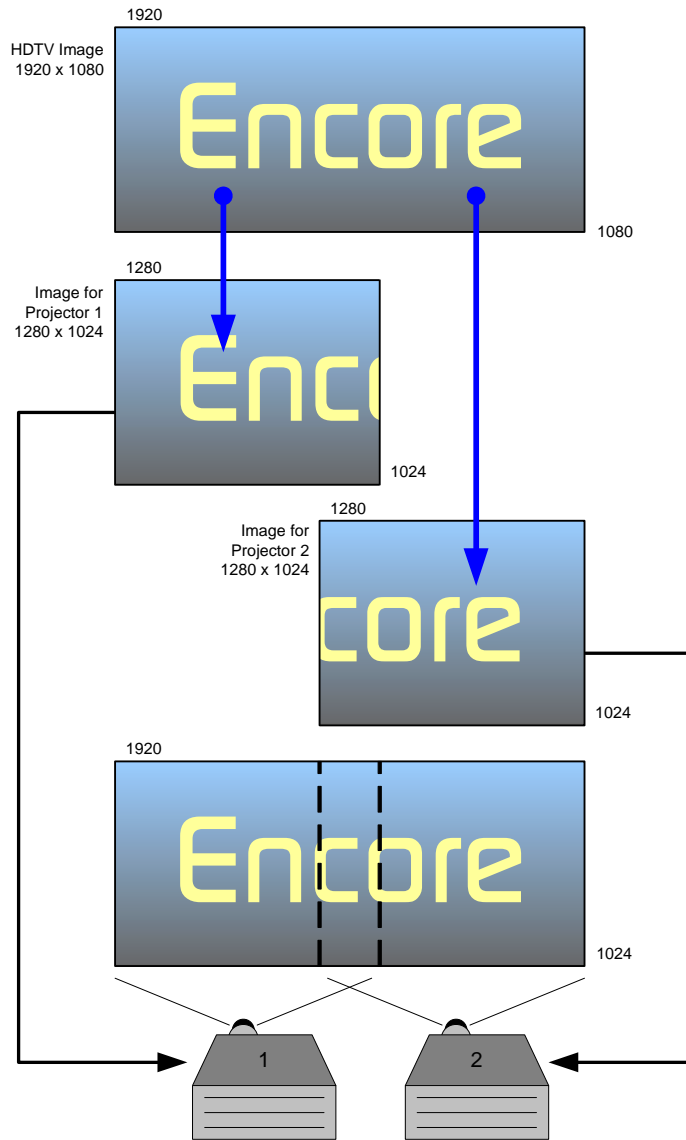


Figure 3-10. HD Source Material Formatting

- **Use Of Multi-Head Graphics Boards**

Standard multi-head graphics boards can be used to directly generate image data to drive multiple screens. In this case, the computer generates one very high-resolution image and the image is output by multiple graphics heads. The inherent resolution of the output image is limited only by the processing power of the multi-head graphics board. Image resolutions with up to 10,000 pixels of horizontal resolution can be achieved with current technology.

### 3. Hardware Installation

#### Program and Source Link Connections

#### Video Processing

The purpose of the edge-blending process is to provide a smooth transition for the eye over the blending region. To provide a smooth transition, identical image data from two different projectors must be superimposed and the output from each projector must be edge feathered to provide seamless optical mixing of the two source images. There are two video processing functions that are required specifically to support wide-screen edge blended displays: **Image Overlap** and **Edge Feathering**.

- **Image Overlap**

Source images consist of a single HD image that has been split into multiple channels, or a series of images from a multi-head graphics card. In either case, the source images must be re-formatted to provide image overlap to support the edge-blending process. The Image Overlap processing is illustrated below. The width of the blending region determines the amount of required image overlap and this must be programmable to support different applications.

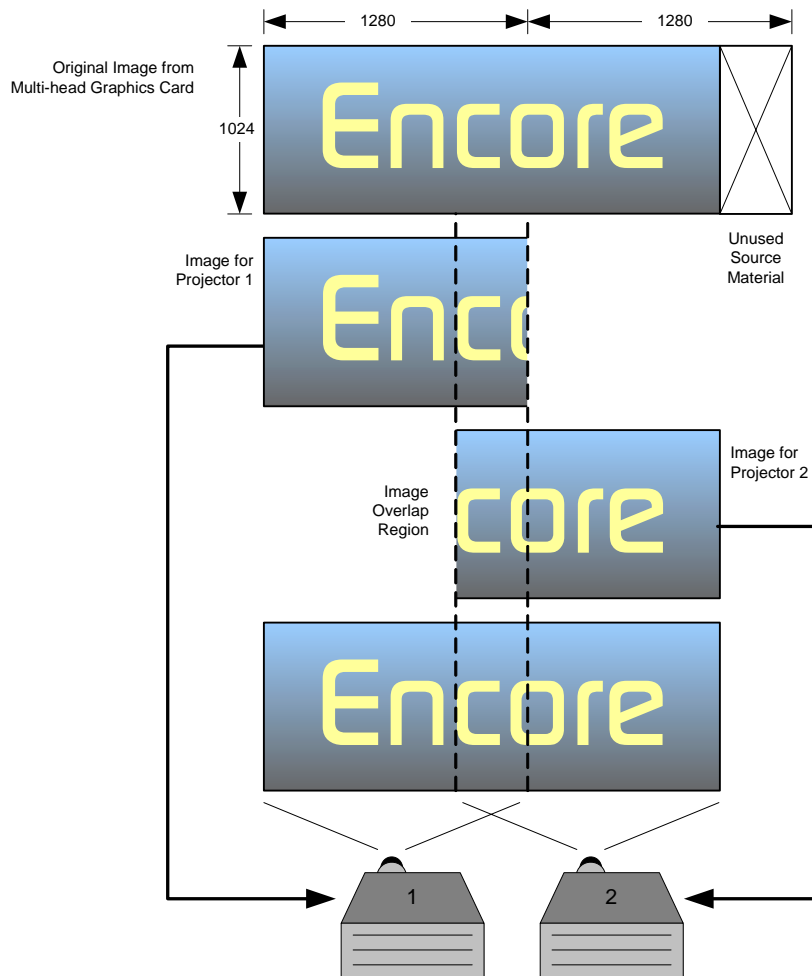


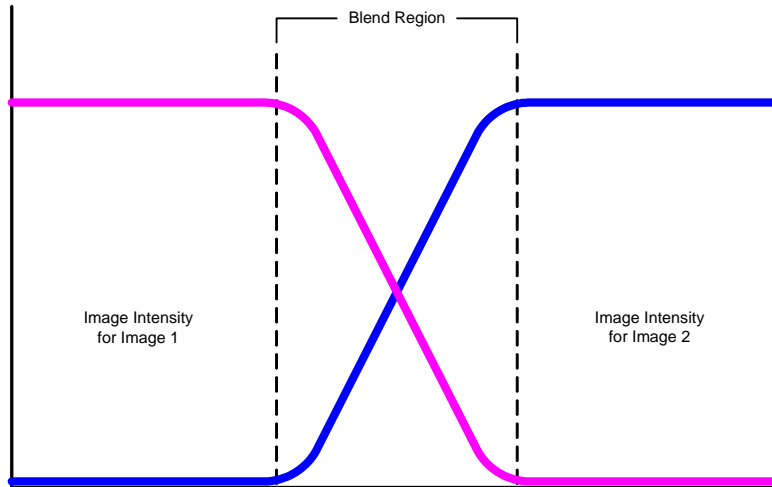
Figure 3-11. Image Overlap and Data Doubling

### 3. Hardware Installation

#### Program and Source Link Connections

- **Edge Feathering**

The overlapping image data in the blend region must be edge-feathered to support a seamless optical blend. The transfer function must be programmable to support blend regions of different widths and adjust to different video characteristics. A typical blend function is illustrated below.



**Figure 3-12.** Typical Blend Function

#### Projector Setup and System Adjustments

Accurate projector setup is essential for creating seamless images. Please note the following important guidelines:

- The projectors must be precisely aligned to overlap the adjacent blending regions.
- The brightness, contrast and color balance of the projectors must be adjusted to provide a uniform appearance across the entire screen.
- Custom test patterns and an alignment procedure are used to simplify this process and provide an optimal result.
- Mixing and matching projectors is not recommended as it makes the adjustment process much more difficult.

### 3. Hardware Installation

#### Program and Source Link Connections

## Connecting Program and Source Links

This section provides instructions for connecting **Program Link** and **Source Link** connections (DVI-I) in a variety of Encore configurations.

- [Left Justified Configuration](#)
- [Center Justified Configuration](#)

#### Important

Secure all cable connections tightly to ensure reliable operation. This is important especially for the Program and Source links — as box-to-box synchronization is relayed in these cables for wide screen setups.

### Left Justified Configuration

Left justification means that the first pixels of the projected image begin immediately at the left, and that unused source material is removed from the far right of the image. A two-projector sample is illustrated below.

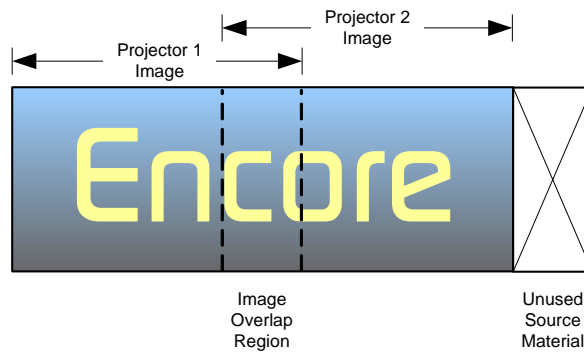


Figure 3-13. Left Justification

Please note:

- Left justified systems are connected in daisy-chain fashion.
- Up to 32 Encore processors are supported (both VP and VPx).
- A VP must be used as processor 1 (master). Thereafter, either a VP or VPx can be used.

■ Use the following steps to connect Program and Source Links for left justification:

#### 1. Program Link Connections (DVI-I)

Connect the **Program Link Out** connector on processor 1 to the **Program Link In** connector on processor 2, as illustrated below.

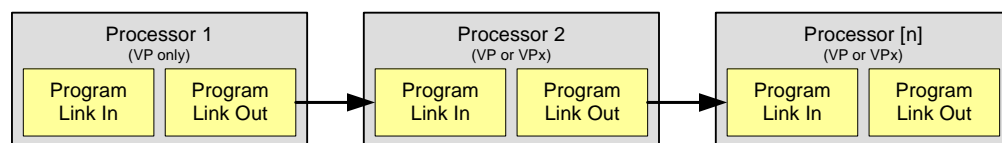


Figure 3-14. Program Link Connections

2. Repeat the procedure for all remaining processors in your configuration.

### 3. Hardware Installation

#### Program and Source Link Connections

3. For the last processor in the chain, do not connect the **Program Link Out** connector.

4. **Source Link Connections (DVI-I)**

For processor 1, connect each M/E's **Source Link Out** connector to the associated **Source Link In** connector on processor 2, as illustrated below.

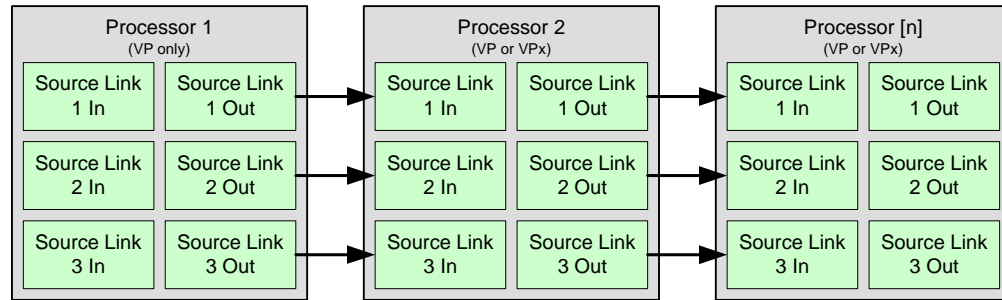


Figure 3-15. Source Link Connections

#### Important

An M/E's **Source Link Out** must *always* be connected to its associated M/E **Source Link In** on the next chassis, and never cross-routed.

5. Repeat the procedure for all remaining processors in your configuration.
6. For the last processor in the chain, do not connect the **Source Link Out** connectors.

### 3. Hardware Installation

#### Program and Source Link Connections

#### Center Justified Configuration

Center justification means that the projected image is properly centered within the available number of pixels, and that unused source material is removed from the far left and far right of the image. A two-projector sample is illustrated below.

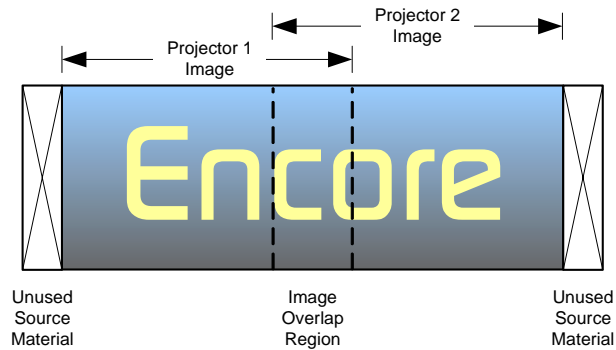


Figure 3-16. Center Justification

#### Important

Center justified systems are only supported in two, three, and four-projector configurations.

- Use the following steps to connect Program and Source Links for left justification:

#### 1. Program Link Connections (DVI-I), Two Projectors

Use the following diagram for reference:

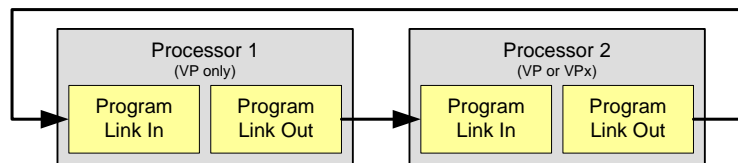


Figure 3-17. Program Link Connections, Two Projectors

Connect:

- ~ Processor 1 **Program Link Out** > Processor 2 **Program Link In**
- ~ Processor 2 **Program Link Out** > Processor 1 **Program Link In**

#### 2. Program Link Connections (DVI-I), Three Projectors

Use the following diagram for reference:

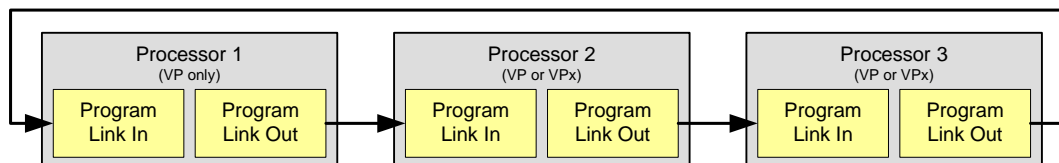


Figure 3-18. Program Link Connections, Three Projectors



### 3. Hardware Installation

#### Program and Source Link Connections

Connect:

- ~ Processor 1 **Program Link Out** > Processor 2 **Program Link In**
- ~ Processor 2 **Program Link Out** > Processor 3 **Program Link In**
- ~ Processor 3 **Program Link Out** > Processor 1 **Program Link In**

#### 3. Program Link Connections (DVI-I), Four Projectors

Use the following diagram for reference:

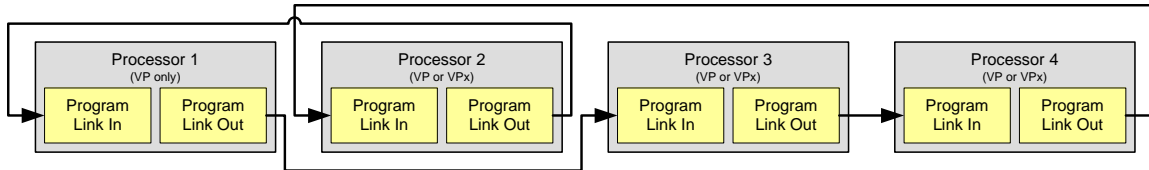


Figure 3-19. Program Link Connections, Four Projectors

Connect:

- ~ Processor 1 **Program Link Out** > Processor 3 **Program Link In**
- ~ Processor 2 **Program Link Out** > Processor 1 **Program Link In**
- ~ Processor 3 **Program Link Out** > Processor 4 **Program Link In**
- ~ Processor 4 **Program Link Out** > Processor 2 **Program Link In**

#### 4. Source Link Connections (DVI-I), All Configurations

For Processor 1, connect each M/E's **Source Link Out** connector to the associated **Source Link In** connector on processor 2, as illustrated below.

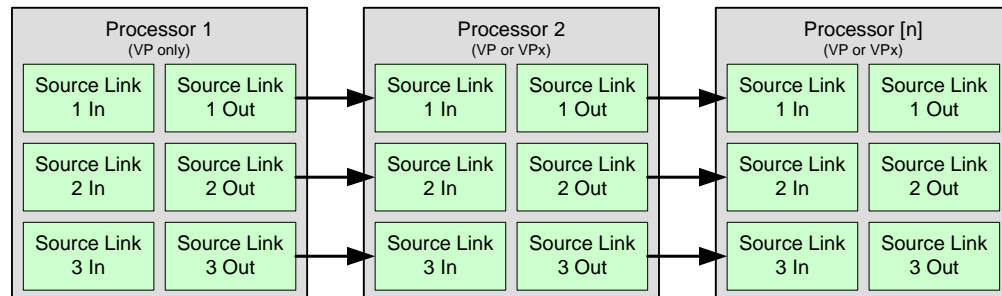


Figure 3-20. Source Link Connections

#### Important

An M/E's **Source Link Out** must *always* be connected to its associated M/E **Source Link In** on the next chassis, and never cross-routed.

5. Repeat the procedure for all remaining processors in your configuration.
6. For the last processor in the chain, do not connect the **Source Link Out** connectors.

Once you have reviewed all of the sections in this chapter, please continue with Chapter 4, "[Controller Orientation](#)" on page 107.

### **3. Hardware Installation**

Program and Source Link Connections

## 4. Controller Orientation

---

### In This Chapter

This chapter describes each section of the system's two controllers — the models LC and SC. The descriptions are designed to familiarize you with each section, the buttons within the sections, and basic information about each button's function. Full operating procedures are provided in Chapter 7, and hyperlinks are provided where appropriate.

The following topics are discussed in this chapter:

- [Controller LC Front Panel](#)
- [Controller SC Front Panel](#)
- [Use of Color](#)
- [Controller Sections](#)

**Note**

If you are using the Controller LC panel, please start with the "[Controller LC Front Panel](#)" section on page 108.

If you are using the Controller SC panel, please start with the "[Controller SC Front Panel](#)" section on page 111.

**Note**

Once you have reviewed all of the sections in this chapter, please continue with Chapter 5, "[Menu Orientation](#)" on page 145.

## 4. Controller Orientation

Controller LC Front Panel

### Controller LC Front Panel

The figure below illustrates the Controller LC front panel:

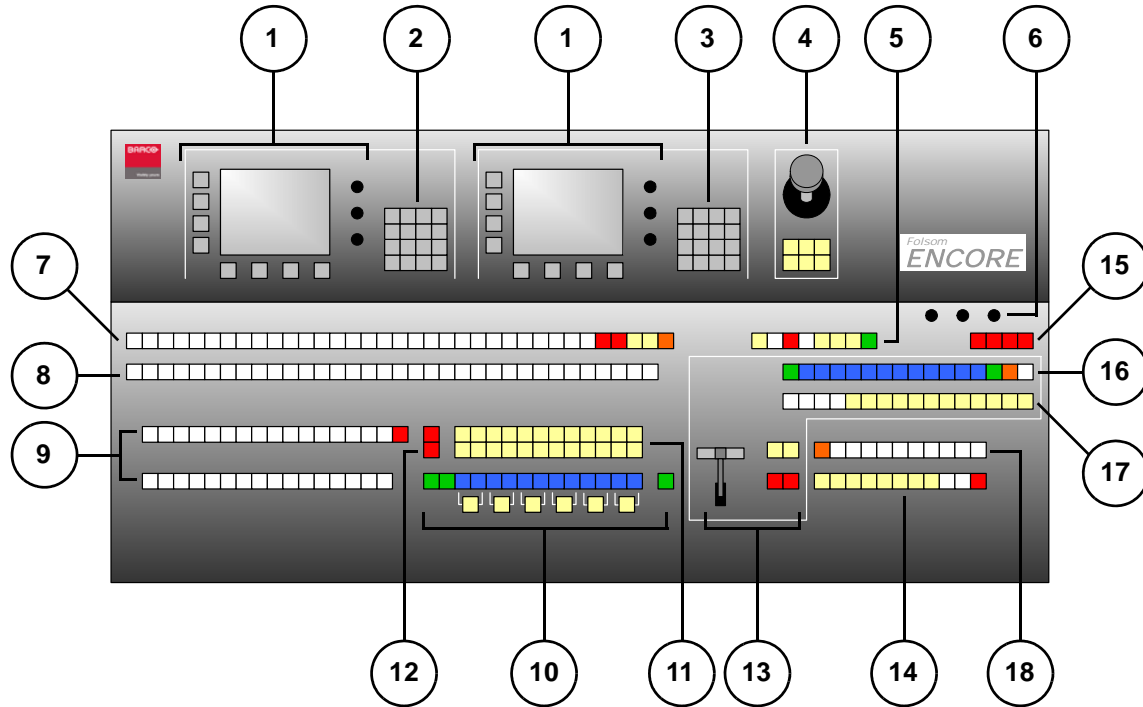


Figure 4-1. Controller LC Front Panel

1) <a href="#">Touch Screen Section</a>	7) <a href="#">Preset Section</a>	13) <a href="#">Transition Section</a>
2) <a href="#">System Keypad</a>	8) <a href="#">Destination Bus</a>	14) <a href="#">Group Control Section</a>
3) <a href="#">Alphanumeric Keypad</a>	9) <a href="#">Source Selection Bus</a>	15) <a href="#">Program Preset Section</a>
4) <a href="#">Joystick Section</a>	10) <a href="#">Layer Control Section</a>	16) <a href="#">Layer/Aux Control Section</a>
5) <a href="#">Machine Control Section</a>	11) <a href="#">Layer Functions Section</a>	17) <a href="#">Transition Functions Section</a>
6) <a href="#">Console Lighting</a>	12) <a href="#">Live Switch Section</a>	18) <a href="#">User Key Section</a>

Following are descriptions of each front panel section on the model LC Controller:

#### 1) Touch Screen Section

The Controller LC has two identical **Touch Screen Sections**. The left-hand section is reserved for system configuration and setup functions, while the right-hand section is reserved for operational adjustments. Refer to the "[Touch Screen Section](#)" heading on page 115 for details.

#### 2) System Keypad

The **System Keypad** provides direct access to system configuration and setup menus, as an alternate to using the Touch Screen. Refer to the "[System Keypad](#)" section on page 117 for details.

## 4. Controller Orientation

Controller LC Front Panel

### 3) Alphanumeric Keypad

The **Alphanumeric Keypad** is reserved for numeric functions. This section is only available on the LC Controller. Refer to the "[Alphanumeric Keypad](#)" section on page 119 for additional details.

### 4) Joystick Section

The **Joystick Section** includes a 3-axis joystick that enables you to adjust PIPs, Keys and additional system parameters. The section also includes dedicated buttons that change the Joystick's function. Refer to the "[Joystick Section](#)" heading on page 120 for details.

### 5) Machine Control Section

The **Machine Control Section** is reserved for controlling external devices. This functionality is only available on the Controller LC. Refer to the "[Machine Control Section](#)" heading on page 122 for details.

### 6) Console Lighting

The **Console Lighting Section** enables you to control the three low-voltage "script" lights. Refer to the "[Console Lighting](#)" section on page 122 for details.

### 7) Preset Section

The **Preset Section** enables you to store and recall Controller setups, called "presets." Each button represents a single "look" of the overall projected image. On the Controller LC, you have access to 900 presets — 30 pages of 30 presets each. Refer to the "[Preset Section](#)" heading on page 123 for details.

### 8) Destination Bus

The **Destination Bus** enables you to route the Controller's output to one or more destinations, such as projectors, ScreenPRO-IIs and auxiliary monitors. On the Controller LC, 32 destinations are available. Refer to the "[Destination Bus](#)" section on page 125 for details.

### 9) Source Selection Bus

The **Source Selection Bus** allows you to choose the sources that are routed into PIPs and Keys. On the Controller LC, up to 64 sources can be mapped to buttons. Refer to the "[Source Selection Bus](#)" section on page 126 for details.

### 10) Layer Control Section

The **Layer Control Section** enables you to assign sources to PIPs and Keys on each layer. Here, you control the overall look on Preview, prior to transitioning the setup to Program. On the LC, up to 12 layers on six mixers can be controlled. Refer to the "[Layer Control Section](#)" heading on page 128 for details.

### 11) Layer Functions Section

When a layer is active (and blinking) in the **Layer Control Section**, all buttons in the **Layer Function Section** now apply to that selected layer, enabling you to change its mode and manipulate the source. Refer to the "[Layer Functions Section](#)" heading on page 131 for details.

### 12) Live Switch Section

The two buttons in the **Live Switch Section** temporarily change the function of the **Source Selection Bus**, enabling you to take sources "live" to Program. Refer to the "[Live Switch Section](#)" heading on page 134 for details.

## 4. Controller Orientation

### Controller LC Front Panel

#### 13) Transition Section

The **Transition Section** includes the **T-Bar** for manually mixing sources on and off Program, plus dedicated buttons for cuts, auto-transitions and sequencing. Refer to the "[Transition Section](#)" heading on page 135 for details.

#### 14) Group Control Section

The **Group Control Section** enables you to take one or more destinations and assign them to a single button, simplifying the task of selecting destinations. On the Controller LC, eight **Group** buttons are available. Refer to the "[Group Control Section](#)" heading on page 137 for details.

#### 15) Program Preset Section

The buttons in the **Program Preset Section** allow you to take a preset *directly* to Program, without first viewing it on Preview. Refer to the "[Program Preset Section](#)" heading on page 139 for details.

#### 16) Layer/Aux Control Section

The buttons in the **Layer/Aux Control Section** provide additional "on air" layer control. Refer to the "[Layer/Aux Control Section](#)" heading on page 140 for details.

#### 17) Transition Functions Section

The buttons in the **Transition Functions Section** enable you to set a variety of parameters for the current transition and mode. Refer to the "[Transition Functions Section](#)" heading on page 142 for details.

#### 18) User Key Section

The buttons in the **User Key Section** are programmable, and can be assigned to map a set of stored parameters to the active PIP or Key. On the Controller LC only, 100 user keys are available — 10 pages of 10 keys each. Refer to the "[User Key Section](#)" heading on page 144 for details.

Please continue with the "[Use of Color](#)" section on page 113.

### Controller SC Front Panel

The figure below illustrates the Controller SC front panel. This panel includes many of the same sections as the Controller LC — the difference is that the sections are more compact, and some LC capabilities are not provided.

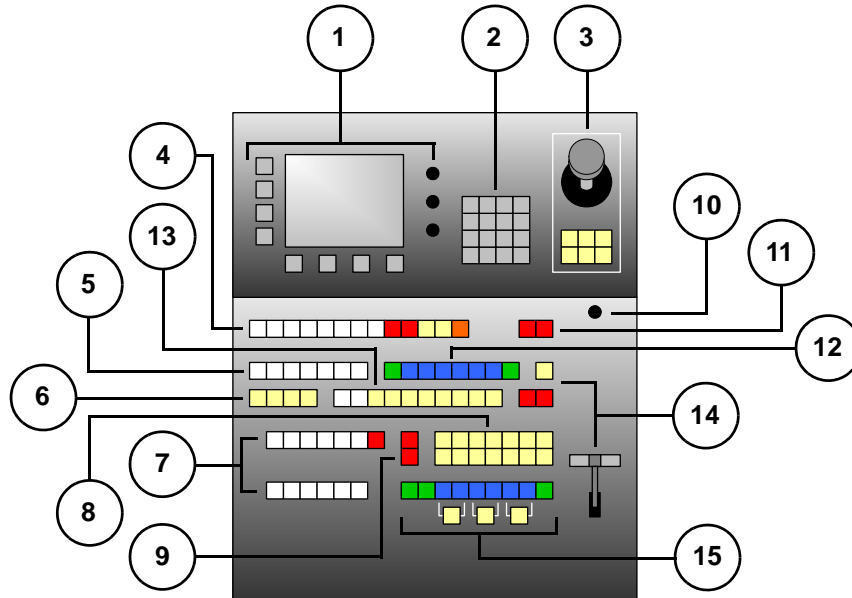


Figure 4-2. Controller SC Front Panel

1) <a href="#">Touch Screen Section</a>	6) <a href="#">Group Control Section</a>	11) <a href="#">Program Preset Section</a>
2) <a href="#">System Keypad</a>	7) <a href="#">Source Selection Bus</a>	12) <a href="#">Layer/Aux Control Section</a>
3) <a href="#">Joystick Section</a>	8) <a href="#">Layer Functions Section</a>	13) <a href="#">Transition Functions Section</a>
4) <a href="#">Preset Section</a>	9) <a href="#">Live Switch Section</a>	14) <a href="#">Transition Section</a>
5) <a href="#">Destination Bus</a>	10) <a href="#">Console Lighting</a>	15) <a href="#">Layer Control Section</a>

Following are descriptions of each front panel section on the model LC Controller:

#### 1) Touch Screen Section

The Controller SC has a single **Touch Screen Section** which is used for system configuration, setup and operational adjustments. Refer to the "[Touch Screen Section](#)" heading on page 115 for details.

#### 2) System Keypad

The **System Keypad** provides direct access to system configuration and setup menus. Refer to the "[System Keypad](#)" section on page 117 for details.

#### 3) Joystick Section

The **Joystick Section** includes a 3-axis joystick that enables you to adjust PIPs, Keys and additional system parameters. The section also includes buttons that modify the assigned Joystick function. Refer to the "[Joystick Section](#)" heading on page 120 for details.

## 4. Controller Orientation

### Controller SC Front Panel

#### 4) Preset Section

The **Preset Section** enables you to store and recall Controller setups, called “presets.” On the Controller SC, you have access to 64 presets — 8 pages of 8 presets each. Refer to the [“Preset Section”](#) heading on page 123 for details.

#### 5) Destination Bus

The **Destination Bus** allows you to route the Controller’s output to one or more destinations. On the Controller SC, six destinations are available. Refer to the [“Destination Bus”](#) section on page 125 for details.

#### 6) Group Control Section

The **Group Control Section** enables you to take one or more destinations and assign them to a single button. On the Controller SC, four Group buttons are available. See the [“Group Control Section”](#) heading on page 137.

#### 7) Source Selection Bus

The **Source Selection Bus** allows you to choose the sources that are routed into PIPs and Keys. On the Controller SC, up to 24 sources can be mapped to individual buttons. See the [“Source Selection Bus”](#) section on page 126.

#### 8) Layer Functions Section

When a layer is active in the **Layer Control Section**, all buttons in the **Layer Functions Section** apply to that layer, enabling you to manipulate the source. Refer to the [“Layer Functions Section”](#) heading on page 131 for details.

#### 9) Live Switch Section

The two buttons in the **Live Switch section** temporarily change the function of the **Source Selection Bus**, enabling you to take sources “live” to Program. Refer to the [“Live Switch Section”](#) heading on page 134 for details.

#### 10) Console Lighting

The **Console Lighting Section** enables you to control the two low-voltage “script” lights. See the [“Console Lighting”](#) section on page 122 for details.

#### 11) Program Preset Section

The buttons in the **Program Preset Section** allow you to take a preset *directly* to Program, without first viewing it on Preview. Refer to the [“Program Preset Section”](#) heading on page 139 for details.

#### 12) Layer/Aux Control Section

The buttons in the **Layer/Aux Control Section** provide additional “on air” layer control. Refer to the [“Layer/Aux Control Section”](#) heading on page 140.

#### 13) Transition Functions Section

The buttons in the **Transition Functions Section** enable you to manipulate the current transition and mode. Refer to the [“Transition Functions Section”](#) heading on page 142 for details.

#### 14) Transition Section

The **Transition Section** includes the **T-Bar** for manually mixing sources on and off Program, plus dedicated buttons for cuts, automatic transitions and sequencing. Refer to the [“Transition Section”](#) heading on page 135 for details.

#### 15) Layer Control Section

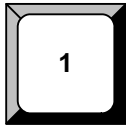
The **Layer Control Section** enables you to assign sources to PIPs and Keys on each layer. On the Controller SC, six layers on three mixers can be controlled. See the [“Layer Control Section”](#) heading on page 128 for details.



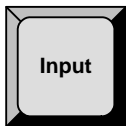
---

### Use of Color

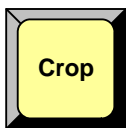
Color plays an important role with each Controller's array of buttons:



**White** buttons are used for sources, destinations, presets and user keys.



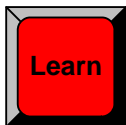
**Gray** buttons are used for softkeys (in the Touch Screen section) and for keypad buttons.



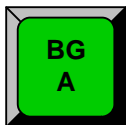
**Yellow** buttons are almost exclusively reserved for "mode" control. They are used to change the joystick mode, PIP and Key functions, the transition mode and the layer control mode. They are also used for "group" functionality.



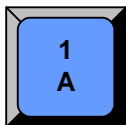
**Orange** buttons are used to control pages of presets and user keys, and for special Aux control on the Controller LC.



**Red** buttons are designated "important." They are most often used in dual-button sequences such as shift, learn or delete, and also used in critical "live" situations where a button affects Program directly — without first being used on Preview.



**Green** buttons indicate *unscaled* sources, such as backgrounds and the DSK source. Green is also used for "play" in the **Machine Control Section**.



**Blue** buttons indicate *scaled* sources, in all cases.

## 4. Controller Orientation

### Controller Sections

---

## Controller Sections

This section provides detailed descriptions of each Controller section. Illustrations for both Controller models are provided, and the differences in functionality are clearly noted.

The following topics are discussed:

- [Touch Screen Section](#)
- [System Keypad](#)
- [Alphanumeric Keypad](#)
- [Joystick Section](#)
- [Machine Control Section](#)
- [Console Lighting](#)
- [Preset Section](#)
- [Destination Bus](#)
- [Source Selection Bus](#)
- [Layer Control Section](#)
- [Layer Functions Section](#)
- [Live Switch Section](#)
- [Transition Section](#)
- [Group Control Section](#)
- [Program Preset Section](#)
- [Layer/Aux Control Section](#)
- [Transition Functions Section](#)
- [User Key Section](#)

### Touch Screen Section

The figure below illustrates the **Touch Screen Section**, which is identical on both Controller models. The model LC has two Touch Screen sections, while the model SC has one. A sample menu is shown below.

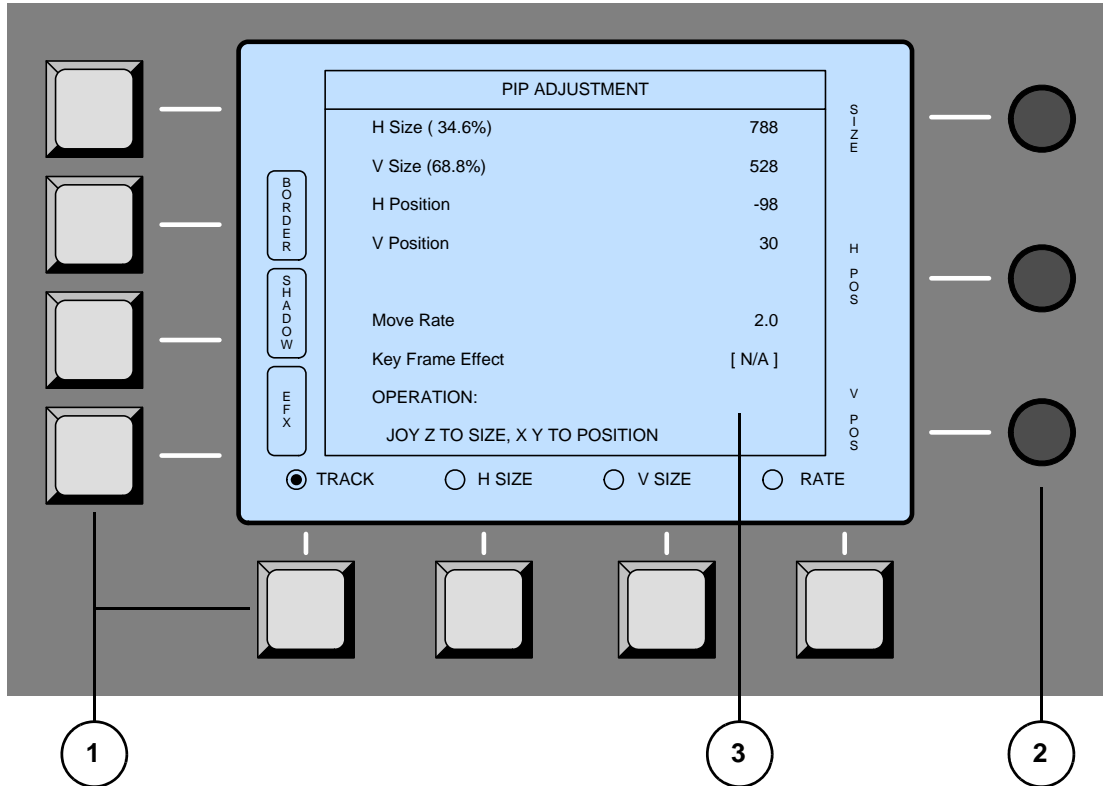


Figure 4-3. Touch Screen Section

1) <a href="#">Softkeys</a>	2) <a href="#">Rotary Knobs</a>	3) <a href="#">Touch Screen</a>
-----------------------------	---------------------------------	---------------------------------

Following are descriptions of each area:

#### 1) Softkeys

Eight un-labeled softkeys are provided — four to the left of the Touch Screen and four below. Softkey labels (when present) appear on the Touch Screen itself. Press the adjacent softkey to access the menu or activate the indicated function.

#### 2) Rotary Knobs

Three **Rotary Knobs** are provided to the right of the Touch Screen. Each knob controls (or adjusts) the function that is labeled on the Touch Screen itself, immediately adjacent to the knob. Please note:

- ~ The **Top Knob** is generally assigned to navigating menu fields. For example, turning the knob moves a highlight up and down a list of parameters, allowing you to adjust the highlighted function. This knob also adjusts adjacent parameters.
- ~ The **Middle** and **Bottom** knobs are generally assigned to adjusting the adjacent parameters, as labeled on the Touch Screen.

## 4. Controller Orientation

### Controller Sections

#### 3) Touch Screen

All menus and functions can be accessed in a variety of ways:

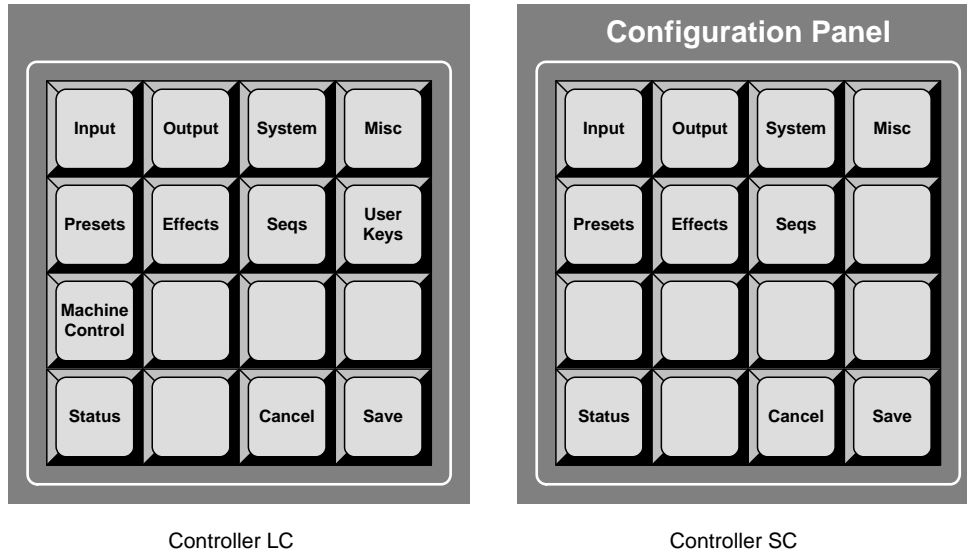
- ~ Touch the desired label on the Touch Screen itself (for example, the **{BORDER}** button) to access the menu.
- ~ Press a **Softkey** that is directly adjacent to a label.
- ~ Use the top **NAV** knob to move the highlight to the desired line, then use the **ADJ** rotary knob (or the Joystick's **Z-Axis Knob**) to adjust the value.
- ~ Touch a particular line to move the highlight to that line, then use the **ADJ** rotary knob (or the Joystick's **Z-Axis Knob**) to adjust the value.
- ~ Press a button in the **System Keypad** to jump directly to a top level menu. Refer to the "[System Keypad](#)" section on page 117 for details.

Please note the following important points regarding the adjustment of parameters:

- If you adjust a parameter using the **ADJ** knob or the Joystick's **Z-Axis Knob**, there is no **Enter** button. Using this method, the modified value is *immediately* active in Preview.
- If you adjust a parameter using the **Alphanumeric Keypad** (on the Controller LC only), press **Enter** on the keypad to activate the value. In Chapter 7, refer to the "[Using the Alphanumeric Keypad](#)" section on page 310 for details.

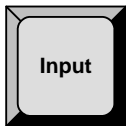
### System Keypad

The figure below illustrates the **System Keypad**, which provides direct access to system configuration and setup menus. The keypads for the models LC and SC are slightly different in functionality, as noted below.

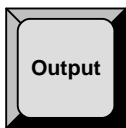


**Figure 4-4.** System Keypads for LC and SC Controllers

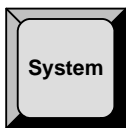
Following are descriptions of each button:



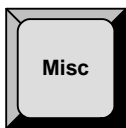
**Input** — press to display the **Input Menu** on the Touch Screen. This menu is used to adjust physical sources connected to the VP or VPx, and to set configuration options for the selected input. In Chapter 5, refer to the [“Input Menu”](#) section on page 148 for details.



**Output** — press to display the **Output Menu**. This menu allows you to configure Encore’s outputs (or Destinations). Setup parameters include screen resolution, wide screen setup, overlap, feathering and test patterns. In Chapter 5, refer to the [“Output Menu”](#) section on page 158 for details.



**System** — press to display the **System Menu**. This menu accesses setup functions such as destination setup, router control, network setup, input patching, diagnostics and reset functions. In Chapter 5, refer to the [“System Menu”](#) section on page 172 for details.



**Misc** — press to display the **Miscellaneous Menu**. This menu accesses a variety of functions such as backup and restore, copy setups, display settings, Video Processor IDs, EDID setup and user preferences. In Chapter 5, refer to the [“Miscellaneous Menu”](#) section on page 196 for details.

## 4. Controller Orientation

### Controller Sections



**Presets** — press to display the **Preset Recall Options Menu**, which enables you to recall all (or part) of a stored preset. In Chapter 5, refer to the [“Preset Recall Options Menu”](#) section on page 208 for details.



**Effects** — press to display the **Effects Menu**, which allows you to modify PIP and Key transition effects, including the ability to define keyframes, paths and effect properties. In Chapter 5, refer to the [“Effects Menu”](#) section on page 209 for details.

**Seqs** —



**Note**

The **Sequences Menu** is currently not implemented.



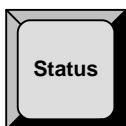
**User Keys** — (Controller LC only) press to display the **User Keys Menu**, which enables you to program, manage, modify, store and recall up to 100 user-defined operations. In Chapter 5, refer to the [“User Key Copy Setup Menu”](#) section on page 211 for details.

**Machine Control** — (Controller LC only)



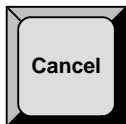
**Note**

The **Machine Control Menu** is currently not implemented.



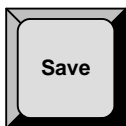
**Status** — press to display the **Status Menu**, which provides a summary of system hardware components, such as VPs, ScreenPRO-IIs, ImagePROs, PresentationPRO-IIs and Routers. In Chapter 5, refer to the [“Status Menu”](#) section on page 212 for details.

**Cancel** —



**Note**

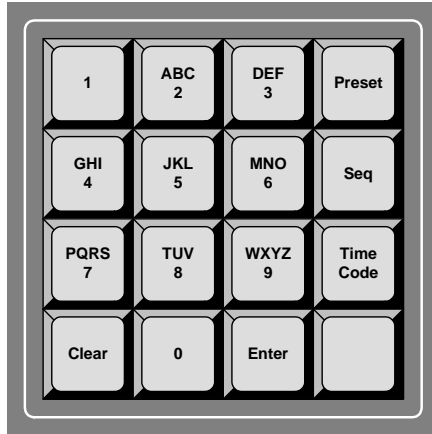
The **Cancel** function is currently not implemented.



**Save** — press to save the state of the Encore Controller in non-volatile memory. Once pressed, the Touch Screen reads **“Saving System Configuration.”** If you cycle power, the Controller returns to its state at the time of the “save.” In Chapter 6, refer to the [“Saving the Setup”](#) section on page 299 for complete details.

### Alphanumeric Keypad

The figure below shows the **Alphanumeric Keypad** which is used for certain numeric functions on the Controller LC only.



**Figure 4-5.** Alphanumeric Keypad, Controller LC

The **Alphanumeric Keypad** enables you to enter and change numeric fields (on the Touch Screen) without having to use a rotary knob (e.g., **ADJ**), the Joystick's **Z-Axis Knob** or a customer supplied **PS/2 Keyboard**.

**Note**

The **Preset**, **Seq** and **Time Code** buttons are not currently implemented.

In Chapter 7, refer to the "[Using the Alphanumeric Keypad](#)" section on page 310 for detailed instructions.

## 4. Controller Orientation

### Controller Sections

## Joystick Section

The figure below illustrates the **Joystick Section**, which is identical on both Controllers.



**Figure 4-6.** Joystick Section

When a PIP or Key is selected in the **Layer Control Section**, the buttons in the **Joystick Section** are automatically assigned to manipulate that feature on Preview. When none of the six buttons are lit, the 3-axis Joystick has the following functions:

- **X-Axis Control** — Move the Joystick left and right to move the PIP (or Key) left and right respectively.
- **Y-Axis Control** — Move the Joystick up and down to move the PIP (or Key) up and down on Preview.
- **Z-Axis Control** — Twist the Joystick's top knob clockwise and counterclockwise to size the PIP (or Key) larger or smaller.

### Note

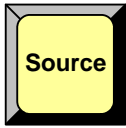
The **Z-Axis Control** can also be used to increase or decrease the value of a highlighted parameter.

Descriptions of each button in the **Joystick Section** are listed on the following page.



## 4. Controller Orientation

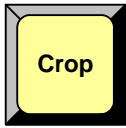
Controller Sections



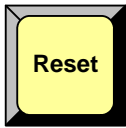
**Source** — press to assign the Joystick to sizing and positioning the source image *within* the PIP or Key boundaries. Please note:

- In Source mode, the PIP or Key's placement on screen remains static, while the image is adjusted within.
- If a PIP is selected, the **Input Source Adjustment Menu** appears when **Source** is enabled.
- If a Key is selected, the **Key Source Adjustment Menu** appears when **Source** is enabled.

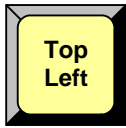
To return to normal PIP adjustment, turn the button off. In Chapter 5, refer to the "[Source Adjustment Menus](#)" section on page 232.



**Crop** — press to assign the Joystick to cropping the boundaries of the PIP or Key. When enabled, the **Top Left** and **Bottom Right** buttons are also enabled, and the **Crop Adjustment Menu** appears. To return to normal PIP adjustment, toggle the button off. In Chapter 5, refer to the "[Crop Menu](#)" section on page 231 for details.



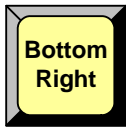
**Reset** — this is a *momentary* function. Press to reset the *current effect* (e.g., PIP, Key, crop, etc.) to its default value. The function is "context sensitive," as it resets only the current effect, without affecting other modifications. In Chapter 7, refer to the "[Using Reset](#)" section on page 334 for additional details.



**Top Left** — when the **Crop** button is lit, press to crop the PIP's top and left edges:

- Move the Joystick left and right to crop the left edge.
- Move the Joystick up and down to crop the top edge.

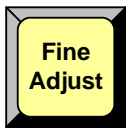
In Chapter 5, refer to the "[Crop Menu](#)" section on page 231 for additional information.



**Bottom Right** — when **Crop** is lit, press to crop the PIP's bottom and right edges:

- Move the Joystick left and right to crop the right edge.
- Move the Joystick up and down to crop the bottom edge.

In Chapter 5, refer to the "[Crop Menu](#)" section on page 231 for additional information.



**Fine Adjust** — in any PIP or key adjustment mode, press to increase the precision of the Joystick's adjustment range.

## 4. Controller Orientation

### Controller Sections

## Machine Control Section

The figure below illustrates the **Machine Control Section**, which is reserved for controlling external devices. The section is only available on the Controller LC.

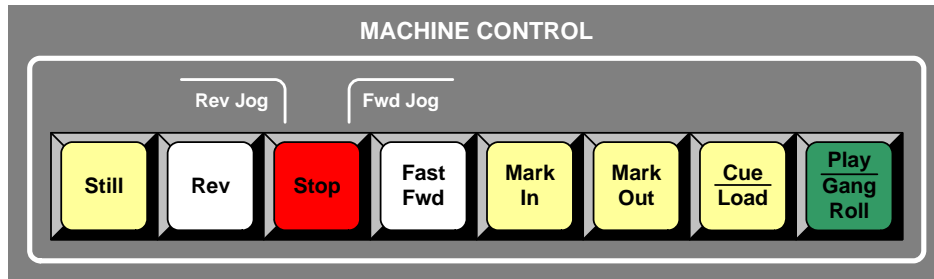


Figure 4-7. Machine Control Section

### Note

**Machine Control** functionality is currently not implemented.

## Console Lighting

The figure below illustrates the **Console Lighting Section**, which is slightly different on each Controller model.

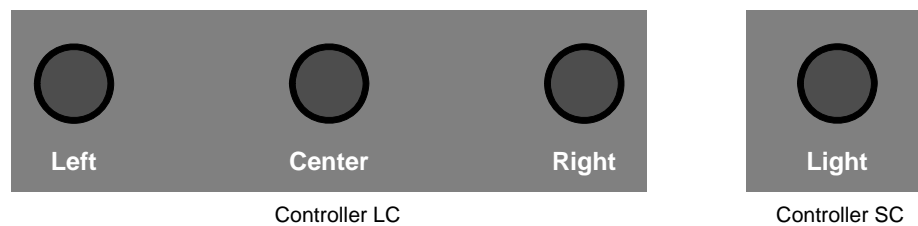


Figure 4-8. Console Lighting Sections

To adjust console lighting:

- **Controller LC** — use the three knobs to individually adjust the brightness of the left, center and right-hand console script lights, respectively.
- **Controller SC** — use the single knob to simultaneously adjust the brightness of the left and right-hand console script lights.

### Preset Section

The figures below illustrate the **Preset Sections** on each Controller model.

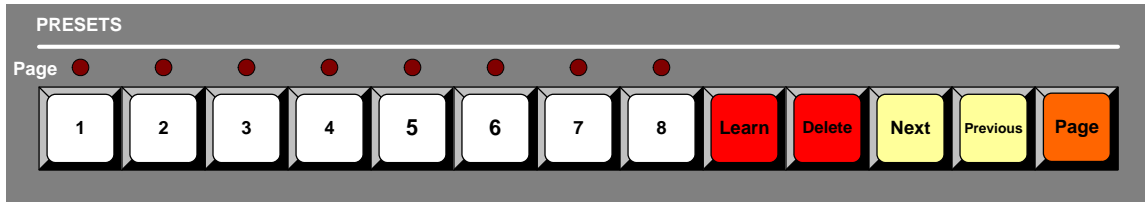


Figure 4-9. Preset Section, Controller SC

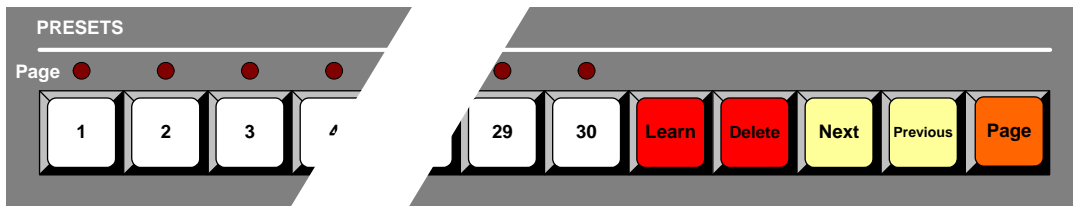
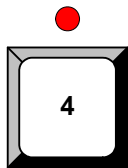


Figure 4-10. Preset Section, Controller LC

A **Preset** is a register in which you can store and recall entire Controller setups. In basic terms, one preset represents a single “look” of the Controller — including the current state of all mixers, layers, sources and the DSK. Please note:

- The **Controller SC** includes buttons for 64 Presets (8 pages of 8 presets each).
- The **Controller LC** has buttons for 900 Presets (30 pages of 30 presets each).

Following are descriptions of each button’s function in the **Preset Section**.



**Preset Buttons** — press to recall a Preset to Preview. If “resources” are available, the “look” stored with that preset will be recalled. If the button does not light, system resources are not currently available to process the request.

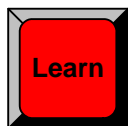
When lit, the **Red LED** above a button indicates the currently selected page.

- ▲ If **LED 3** and button **30** are lit, the 30th Preset on page 3 is active.

#### Important

All Preset recall functions are affected by the settings on the **Preset Recall Options Menu**. This menu (accessed by pressing **Presets** on the **System Keypad**) enables you to select all or a portion of the stored Preset for recall.

In Chapter 5, refer to the “[Preset Recall Options Menu](#)” section on page 208 for information about the **Preset Recall Options Menu**. In Chapter 7, refer to the “[A Word About Resources](#)” section on page 345 for additional information about resources.

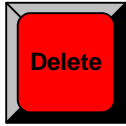


**Learn** — hold down **Learn**, then press the desired Preset button to store the overall look of the Controller into that register.

- ▲ To store the Controller setup in preset register 2, press **Learn + 2**.

## 4. Controller Orientation

### Controller Sections



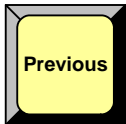
**Delete** — hold down **Delete**, then press the desired Preset button to delete that register from memory.

▲ To delete preset 8 from memory, press **Delete + 8**.



**Next** — press to recall the next valid Preset in sequential order. Please note:

- If a Preset is undefined, it will be skipped when **Next** is pressed.
- **Next** includes the ability to “wrap” to the next page (e.g., from Preset 30 on page 2 to Preset 1 on page 3).



**Previous** — press to recall the previous valid Preset in sequential order. Please note:

- If a Preset is undefined, it will be skipped when **Previous** is pressed.
- **Previous** includes the ability to “wrap” to the previous page (e.g., from Preset 1 on page 3 to Preset 30 on page 2).



**Page** — hold down **Page**, then press the desired Preset button to switch to that page of Presets. The **Red LED** above the button lights to indicate the selected page.

▲ To switch to page 7, press **Page + 7**.

In Chapter 7, refer to the [“Working with Presets”](#) section on page 345 for complete instructions on all Preset modes.

### Destination Bus

The figures below illustrate the **Destination Bus** on each Controller model.

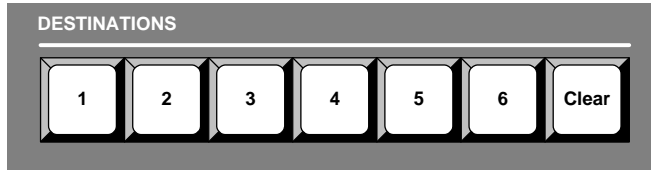


Figure 4-11. Destination Bus, Controller SC

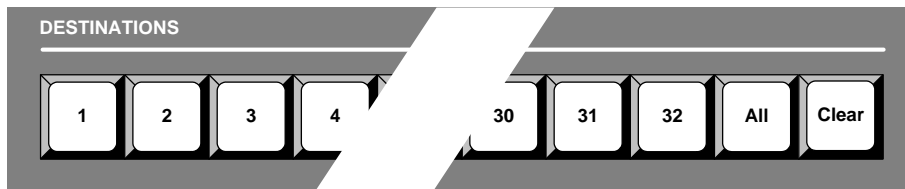
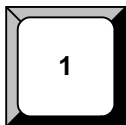


Figure 4-12. Destination Bus, Controller LC

Each button on the **Destination Bus** represents a *location* to which you can route *some form* of Controller (or router) output. The transitions that you perform will affect only the selected destinations, leaving the unselected destinations as they were. The **Controller SC** provides six destinations — the **Controller LC** provides 32. All destinations are assigned using the **Destination Setup Menu**. Please note:

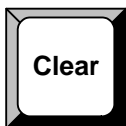
- In Chapter 1, refer to the “[A Word About Destinations](#)” section on page 27 for examples of each destination “type.”
- In Chapter 6, refer to the “[Destination Setup](#)” section on page 277 for details on standard destination setup procedures.
- In Chapter 6, refer to the “[AUX Destination Setup](#)” section on page 281 for details on Aux destination setup procedures.

Following are descriptions of each button’s function on the **Destination Bus**.



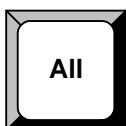
**Destination Buttons** — press to select the desired destination. Any combination of destinations can be selected — the buttons are *not* mutually exclusive. The transitions and switches that you perform affect only the selected destination(s). Please note:

- If multiple destinations are active, press and hold *one* destination button to momentarily isolate that destination for modification. Release to return to the “group” selection.



**Clear** — hold down **Clear**, then press the desired button to remove (de-select) the destination. The next transition will not be routed to it.

- ▲ If destinations 1, 2 and 3 are lit, press **Clear + 2** to clear destination 2 from the group. The next transition will be routed to destinations 1 and 3 only.



**All** — (Controller LC only) press **All** to activate all valid destinations.

- Press **Clear + All** to clear all valid destinations.

In Chapter 7, refer to the “[Working with Destinations](#)” section on page 315 for complete instructions on all destination modes.

## 4. Controller Orientation

### Controller Sections

## Source Selection Bus

The figures below illustrate the **Source Selection Bus** on each Controller.

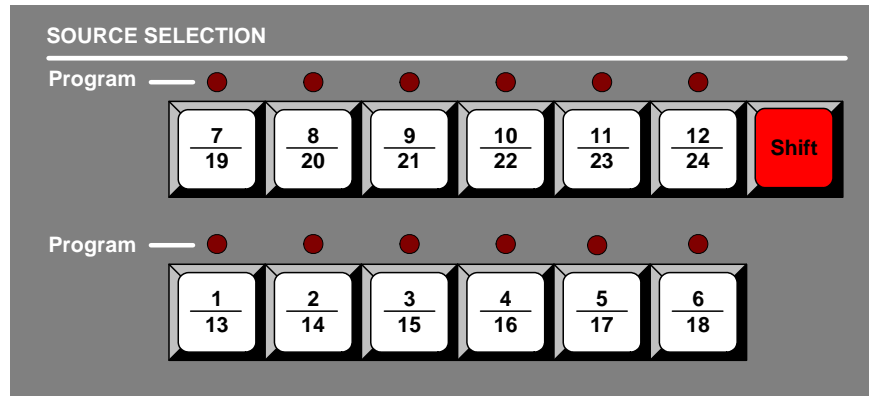


Figure 4-13. Source Selection Bus, Controller SC

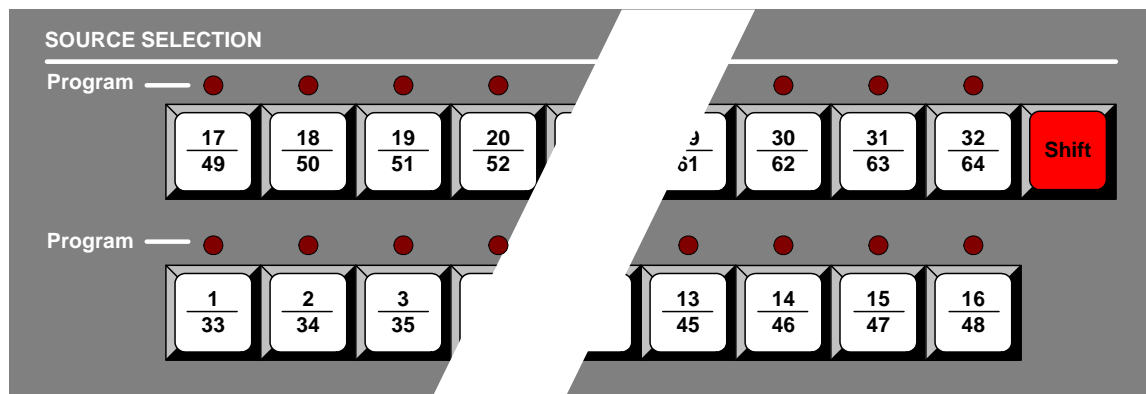


Figure 4-14. Source Selection Bus, Controller LC

Please note the following important points:

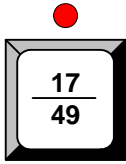
- Each numbered button represents two sources — one shifted and one un-shifted.
- The **Controller SC** includes buttons for 24 sources.
  - ~ Sources 1 - 12 are accessed directly.
  - ~ Sources 13 - 24 are accessed by pressing **Shift + source**.
- The **Controller LC** has buttons for 64 sources.
  - ~ Sources 1 - 32 are accessed directly.
  - ~ Sources 33 - 64 are accessed by pressing **Shift + source**.
- Each source button represents an input that you can assign to a PIP or Key, or route to a specified destination. Each input is either a “direct” connection to the Processor or an assigned router input.

In Chapter 6, refer to the “[Input Setup](#)” section on page 293 for details on source setup procedures.

## 4. Controller Orientation

Controller Sections

Following are descriptions of each button's function on the **Source Selection Bus**.



**Source Buttons** — press to assign the source to the blinking “mixer” button in the **Layer Control Section**.

- When the source button is lit and *blinking*:
    - ~ The source is on Preview.
    - ~ The associated layer is active for modification.
    - ~ The associated layer's raster box is blinking on Preview.
  - When lit solid, the source is on Preview — but its associated layer is *not* active for modification.
  - Multiple source buttons can be lit simultaneously, but only one source button can be blinking — with its associated layer active for modification and the associated raster box blinking on Preview.
  - When the **Red LED** above a source button is lit solid, the source is on Program.
  - When the **Red LED** above a source button is *blinking*:
    - ~ The associated mixer is set to **Mix Mode**.
    - ~ In the mixer, the blinking **Red LED** indicates the layer that is on Program.
    - ~ In the associated mixer, the *layer opposite to* the blinking **Red LED** is enabled for modification, with the associated raster box blinking.
- ▲ The **Red LED** above source 1 is blinking, and the **Red LED** above layer 1A is blinking. This indicates that mixer 1 is set to **Mix Mode**, with source 1 on Program in layer 1A and layer 1B active for modification.

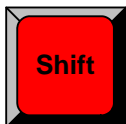
### Note

Without the blinking **Red LEDs** in Mix Mode, you would not be able to tell which layer/source combination was on Program in the selected mixer.

- Multiple **Red LEDs** can be lit simultaneously, but only one **Red LED** can be blinking — indicating a “Mix Mode” association.
- Source buttons cannot be selected if they have not been assigned during the source setup procedure. The button(s) will not light.

Source buttons are also used in the following modes:

- Source buttons can be used to route inputs to **Aux** destinations. In Chapter 7, see the [“Routing Sources to Aux Destinations”](#) section on page 316 for details.
- In “live switch” mode, source buttons can be used to switch the input to a PIP directly on Program. In Chapter 7, refer to the [“Working with Live Modes”](#) section on page 340 for complete instructions on all destination modes.



**Shift** — the **Shift** button is a toggle: press once to light, press again to turn off. When lit, press the desired source button to access the *second row* of numbered sources (e.g., 13 - 24 on the Controller SC).

In Chapter 7, refer to the [“Switching Sources”](#) section on page 319 for additional details.

## 4. Controller Orientation

### Controller Sections

## Layer Control Section

The figures below illustrate the **Layer Control Section** on each Controller.

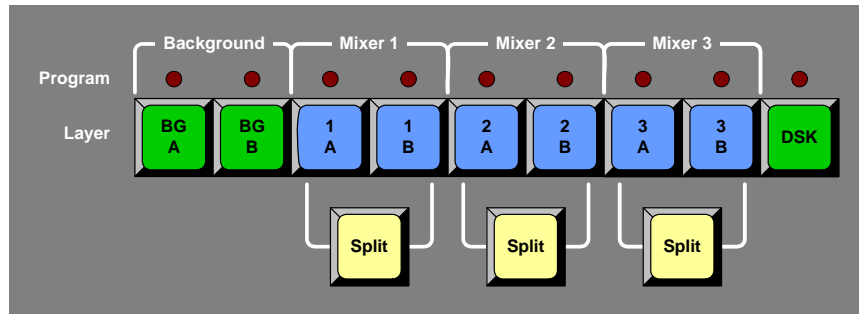


Figure 4-15. Layer Control Section, Controller SC

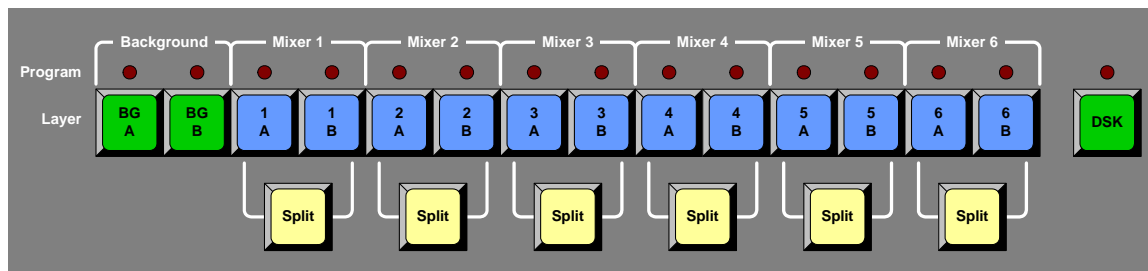


Figure 4-16. Layer Control Section, Controller LC

The buttons in the **Layer Control Section** enable you to select (on Preview) the sources that will transition to or from Program — including backgrounds, layers and the DSK. When you select a blue “layer” button, you are electronically selecting a scaler that you want to assign as a PIP or Key, or modify in some manner. In this way, you control the overall look on Preview before you transition that look to Program.

Please note the following points:

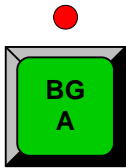
- The **Controller LC** can control up to 12 layers on six mixers in a “stack” configuration.
- Using the **Shift Layers** button in the **Layer Functions Section**, the **Controller SC** can also control up to 12 layers on six mixers in a “stack” configuration. Refer to the [“Layer Functions Section”](#) heading on page 131 for details
- Two background sources and one DSK are provided.
- Each identical mixer is comprised of two layers (**A** and **B**) and a **Split** button.
- The buttons are arranged left-to-right in order of visual priority — **backgrounds** (lowest priority), **mixers** (in order of priority), and the **DSK** (highest priority).
- Any combination of backgrounds, layers and DSK can be selected on Preview for transition to or from Program, provided that resources are available. In Chapter 7, refer to the [“A Word About Resources”](#) section on page 345 for more details.



Following are descriptions of each button in the **Layer Control Section**.

### Important

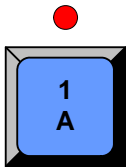
Encore uses a “lookahead” Preview monitor that fully represents how the Program output will appear *next*. By selecting combinations of PIPs, Keys, backgrounds and the DSK, you are composing a Preview image that will appear on Program — after the next transition. A “lit” button does not necessarily mean that the source will transition on or off — it simply means that it is part of the “look” on Preview.



**Background Buttons** — press to select an unscaled background (**A** or **B**) on Preview for transition to or from Program. The button blinks when selected, and the **BG Input Setup Menu** appears. Here, you can select a DVI input, an analog input, a matte color or a captured frame as the background source.

Please note:

- When blinking, the background is active for manipulation on Preview. When lit solid, the background is on Preview — but it is not active for manipulation. It is, however, ready to be transitioned to Program or cleared from Preview.
- If the **Red LED** is lit, the selected background is on Program.
- Both backgrounds cannot be on Program simultaneously.
- If neither background is on Program, the matte color for the last selected background is the on-air background source — but the **Red LED** will not be lit.
- If a background is on Program and the *same background* is selected in Preview, there will be no background change on the next transition.
- To clear a background from Preview (so that it will transition off Program), press the desired background, then press **Clear Layer**. This action turns the button off, and if the **Red LED** above the button is lit, the background transitions off Program.
- Toggle mode affects background transitions. In Chapter 7, refer to the [“Background Transitions”](#) section on page 320 for complete instructions.



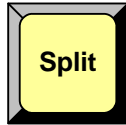
**Layer Buttons** — press to select a layer on Preview for transition to or from Program. The button blinks when selected, and either the **PIP Adjustment Menu** or **Key Menu** appears.

- When lit and blinking:
  - ~ The layer is active for modification, and its raster box blinks on Preview.
  - ~ A source can be assigned to the layer from the **Source Selection Bus**.
  - ~ The layer can be assigned as a PIP or Key using the buttons in the **Layer Function Section**.
- When lit solid, the layer is on Preview — but it is not active for manipulation. It is, however, ready to be transitioned to Program or cleared from Preview.
- When the **Red LED** above a layer button is lit, the layer is on Program.
- When the **Red LED** above a layer button is *blinking*:
  - ~ The associated mixer is set to **Mix Mode**.
  - ~ The layer (with the blinking LED) is on Program.
  - ~ On the **Source Selection Bus**, the blinking **Red LED** indicates the associated source on Program.
  - ~ In the mixer, the *layer opposite to the* blinking **Red LED** is enabled for modification, and its associated raster box is blinking on Preview.

## 4. Controller Orientation

### Controller Sections

- To clear a layer from Preview (so that it will transition off Program), press the desired layer button, then press **Clear Layer**. This action turns the button off, and if the **Red LED** above the button is lit, the layer transitions off Program.

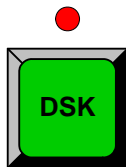


**Split** — this important button determines how the mixer's two layers work.

- **Mix Mode** — the **Split** button is off. In this mode, the two layers are ganged together, offering a variety of additional transitions including the **Toggle**, **Mix Source** and **Swap** functions.
  - ~ Refer to the "[Transition Functions Section](#)" heading on page 142 for details on the **Toggle**, **Mix Source** and **Swap** buttons.
  - ~ In Chapter 7, refer to the "[Working with Layers](#)" section on page 319 for additional Mix Mode information.
- **Split Mode** — the **Split** button is on. In this mode, each layer works independently. You have the freedom to size, position, manipulate and transition each layer independently of the other. In Chapter 7, refer to the "[Working with Layers](#)" section on page 319 for additional Split Mode information.
- **Join Mode** — the **Split** button is on. The layer button that is currently blinking is considered the "master." *Press and hold* the **Split** button, then press the other (non-blinking) layer button to "join" the two layers together. Both layer buttons blink, and in this mode, both are now joined.
  - ~ Any manipulation that you perform to the "master" layer is also performed to the joined layer. Both can be sized, positioned, moved and manipulated as if they are one.
  - ~ To separate the two layers, press and hold the **Split** button, then press either **Layer** button.

In Chapter 7, refer to the "[Using Join Mode](#)" section on page 335 for additional information.

- **Blinking** — if the **Split** button is blinking (after a Preset recall), the mixer will change modes after the next transition.



**DSK** — press to select the unscaled **DSK** on Preview for transition to or from Program. The button lights when selected. Please note:

- Using the **DSK Input Setup Menu**, you can select a DVI input, an analog input or a captured frame as the DSK source.
- When the **Red LED** above the button is lit, the DSK is on Program.
- To clear the DSK from Preview (so that it will transition off Program), select the DSK then press **Clear Layer**. This action causes the button to turn off. If the red led above the DSK button is lit, it will transition off of Program.

In Chapter 7, refer to the "[Modifying Keys](#)" section on page 326 for additional DSK information.

### Layer Functions Section

The figures below illustrate the **Layer Functions Section** on each Controller.

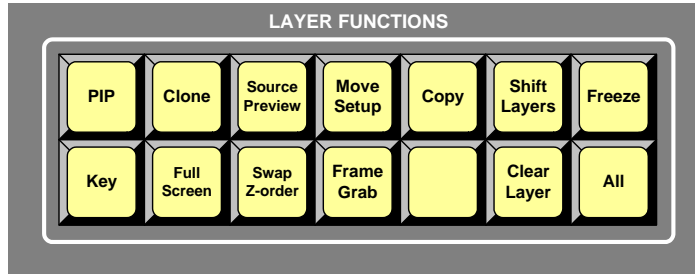


Figure 4-17. Layer Functions Section, Controller SC

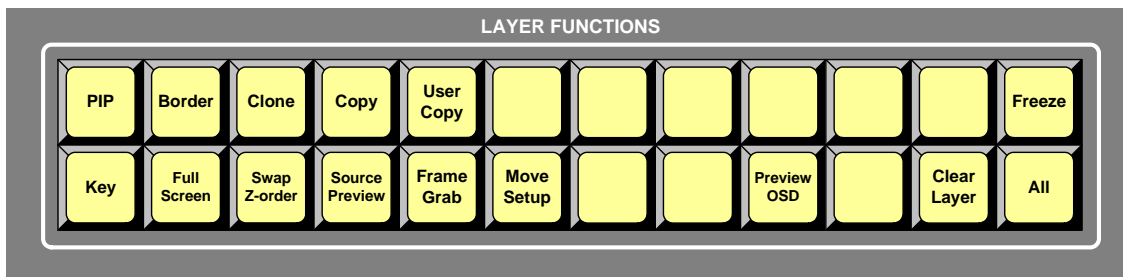
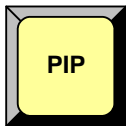
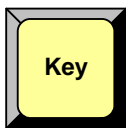


Figure 4-18. Layer Functions Section, Controller LC

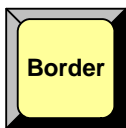
The buttons in the **Layer Function Section** enable you to modify the selected layer.



**PIP** — press to change the selected layer (in the **Layer Control Section**) and its associated source to a PIP. The **PIP Adjustment Menu** appears on the Touch Screen. In Chapter 5, refer to the [“PIP Adjustment Menu”](#) section on page 213 for details.



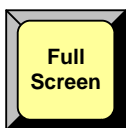
**Key** — press to change the selected layer (in the **Layer Control Section**) and its associated source to a Key. The **Key Adjustment Menu** appears on the Touch Screen. In Chapter 5, refer to the [“Key Menu”](#) section on page 224 for details.



**Border** — (Controller LC only)

- Press to modify the PIP’s border. The **Border Menu** appears.
- Double-punch to turn the border on or off for the selected layer.

In Chapter 5, refer to the [“Border Menu”](#) section on page 218 for information.



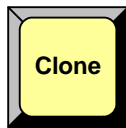
**Full Screen** — press to take the active PIP or Key to full screen. In each case, the source’s height is used to define the full screen size.

- ▲ If a source’s original dimension is 1280 x 1024, pressing **Full Screen** expands (or reduces) that PIP to fill the output screen vertically. If borders are **ON**, they will be taken into account so that they are visible.

In Chapter 7, refer to the [“Using Full Screen”](#) section on page 329 for instructions.

## 4. Controller Orientation

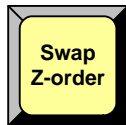
### Controller Sections



**Clone** — for widescreen configurations only, press to make an exact copy of a layer onto the opposite screen. All parameters of the PIP or Key are cloned, including the source's shadow, key effects, border and size. Once cloned, you can select between a "mirror" or an "offset" clone.

- ▲ In a three-screen configuration, if layer **1A** is a PIP on screen 1, press **Clone** to make an exact copy of the PIP on screen 3. When you adjust the PIP, both the original and the "cloned" copy are adjusted simultaneously.

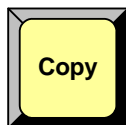
In Chapter 7, refer to the "[Using Clone](#)" section on page 330 for instructions.



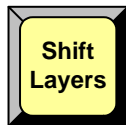
**Swap Z-order** — press to change the visual priority (on Preview) of the two layers in a given mixer. The PIPs or keys remain at their current locations, only the priority changes.

- ▲ If PIP **1B** is visually on top of PIP **1A**, press **Swap Z-order** to place PIP **1A** on top of **1B**.

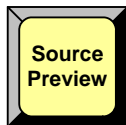
In Chapter 7, refer to the "[Using Swap Z-order](#)" section on page 330 for instructions.



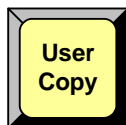
**Copy** — press to copy the properties of the active PIP or Key to another PIP or Key — on the same (or different) mixer. The **Copy Setup Menu** appears. All (or a portion) of the source's parameters can be copied. Copy differs from **Clone**, because once the function has been performed, the two effects will not be locked together. In Chapter 7, refer to the "[Using Copy](#)" section on page 331 for instructions.



**Shift Layers** — (Controller SC only) In stack configurations only on the Controller SC, press to access layers 4A to 6B plus the DSK on mixers 4, 5 and 6. When the **Shift Layers** button is off, you can access layers 1A to 3B plus backgrounds A and B. In Chapter 7, refer to the "[Using Shift Layers](#)" section on page 331 for instructions. Note that the button only functions when the destination is a stack.

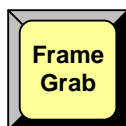


**Source Preview** — For any selected Layer, press **Source Preview** to isolate that layer for sizing and adjustment purposes — in Preview only. All other PIPs and Keys are hidden, the background switches to a neutral gray, and the **Input Menu** for the selected source appears. When the button is toggled off, the previous "look" is restored. In Chapter 7, refer to the "[Using Source Preview](#)" section on page 333 for instructions.

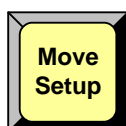


**User Copy** — (Controller LC only) press to display the **User Key Copy Setup Menu**, which enables you to select all (or a portion) of the effect's parameters that you wish to store on one of the Controller's 100 User Keys. By selecting a PIP or Key in Preview and then pressing a user key, the stored parameters are instantly applied to the effect.

- Refer to the "[User Key Section](#)" heading on page 144 for information on the User Key section.
- In Chapter 7, refer to the "[Working with User Keys](#)" section on page 350 for operational instructions.



**Frame Grab** — press to display the **Frame Grab Menu**, which enables you to capture up to 100 frames into the system's three internal frame stores. Once captured, the frames can be used as background or DSK sources. In Chapter 7, refer to the "[Working with Frame Grabs](#)" section on page 355 for instructions.



**Move Setup** —

- Press to set up a "move" that enables you to fly a PIP or Key from one location to another on the next auto transition.
- Double-punch to delete the move setup for the selected layer.

In Chapter 7, refer to the "[Using Move](#)" section on page 336 for complete instructions.

## 4. Controller Orientation

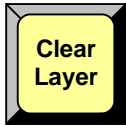
Controller Sections

Preview OSD —

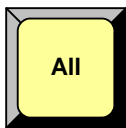


### Note

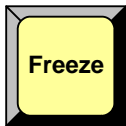
The **Preview OSD** function is currently not implemented.



**Clear Layer** — press to remove the currently selected (blinking) layer from Preview — in preparation for transitioning it off Program. The button can be used to clear backgrounds, PIPs, Keys and the DSK. In Chapter 7, refer to the [“Clearing Layers from Program”](#) section on page 327 for instructions.



**All** — press **All + Clear Layer** (or **Clear Layer + All**) to remove all layers from Preview — in preparation for transitioning them all off Program. In Chapter 7, refer to the [“Clearing Layers from Program”](#) section on page 327 for instructions.



**Freeze** — press to freeze a PIP or Key.

- In **Split Mode**, PIPs or Keys can be frozen on both Program and Preview.
- In **Mix Mode**, PIPs or Keys can only be frozen on Preview — prior to transitioning them to Program.

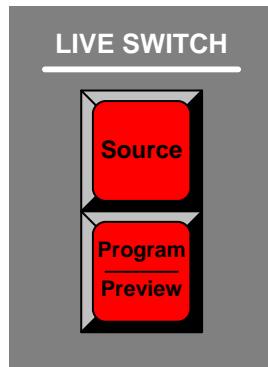
In Chapter 7, refer to the [“Using Freeze”](#) section on page 332 for instructions.

## 4. Controller Orientation

### Controller Sections

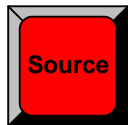
## Live Switch Section

The figure below illustrates the **Live Switch Section** on both Controller models.



**Figure 4-19.** Live Switch Section

The buttons in the **Live Switch Section** enable you to enter two types of “live” modes, temporarily bypassing Encore’s “lookahead” preview capability.



**Source** — press **Shift + Source** to activate the **Live Switch Source** mode, which turns both rows of the **Source Selection Bus** into a live Program bus.

- For the selected layer, when a source button is pressed, the layer cuts to the new source within the selected layer.
- In Chapter 7, refer to the [“Using Live Switch Source Mode”](#) section on page 341 for complete details.

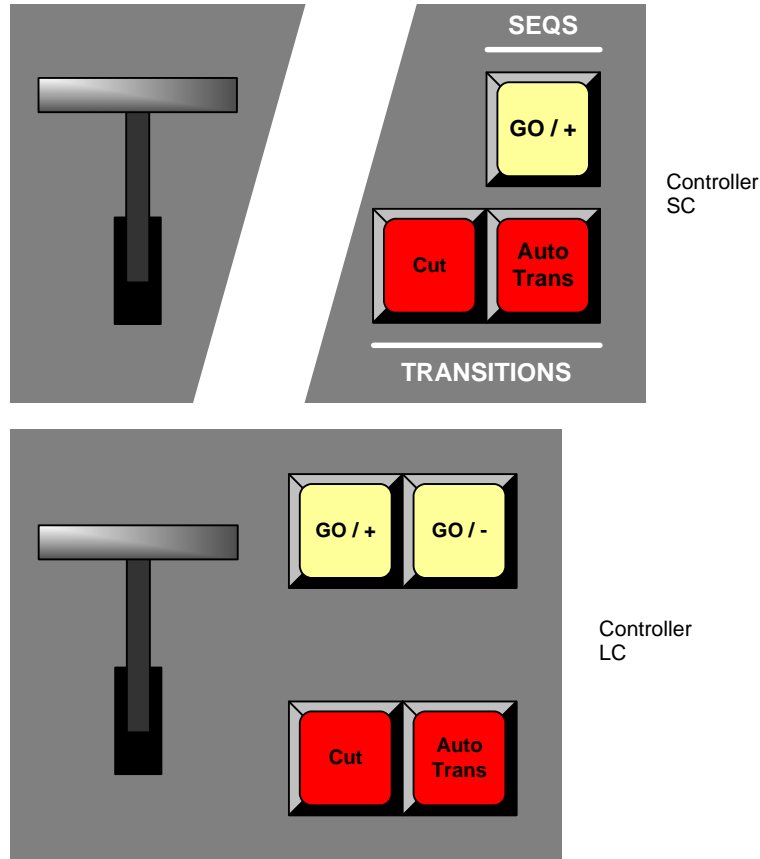


**Program/Preview** — Press **Shift + Program/Preview** to activate the **Live Switch Program/Preview** mode, which turns both rows of the **Source Selection Bus** into a live Program/Preview bus.

- In this mode, the top row acts as **Program**, and the bottom row acts as **Preview**.
- For the selected layer, when a source is pressed on Program, the layer cuts to the new source within the selected layer. However, you can also use the live **Preview** bus in the normal way, and then transition to **Program**.
- In Chapter 7, refer to the [“Using Live Switch Program/Preview Mode”](#) section on page 340 for details.

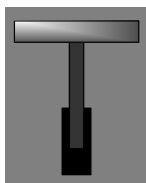
### Transition Section

The figures below illustrate the **Transition Section** on each Controller. The sections are essentially identical.



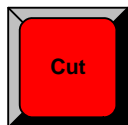
**Figure 4-20.** Transition Sections

Descriptions of each button and control are provided below:

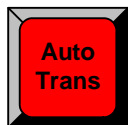


**T-Bar** — enables you to perform smooth, manual transitions. Each time the **T-Bar** is moved from limit to limit, the “look” on Preview transitions to Program using the selected transition type (as chosen on the **Effects Menu**). Note:

- The **T-Bar** cannot be used to execute PIP “moves.”



**Cut** — press to instantly cut the setup (or “look”) from Preview to Program.

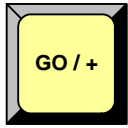


**Auto Trans** — press to transition automatically from Preview to Program at a pre-defined rate as chosen on the **Effects Menu**. In Chapter 5, refer to the [“Effects Menu”](#) section on page 209 for menu details. In Chapter 7, refer to the [“Working with Transitions”](#) section on page 343 for operational procedures.

## 4. Controller Orientation

### Controller Sections

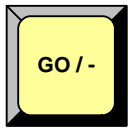
Go / + —



**Note**

The **Go / +** function is currently not implemented.

Go / - —



**Note**

The **Go / -** function is currently not implemented.



### Group Control Section

The figures below illustrate the **Group Control Section** on each Controller. The sections are essentially identical, except that the Controller SC has fewer group buttons.

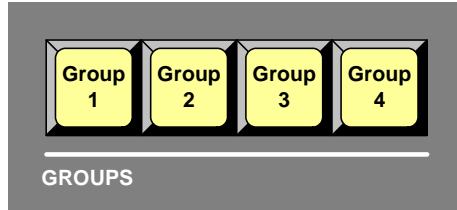


Figure 4-21. Group Control Section, Controller SC

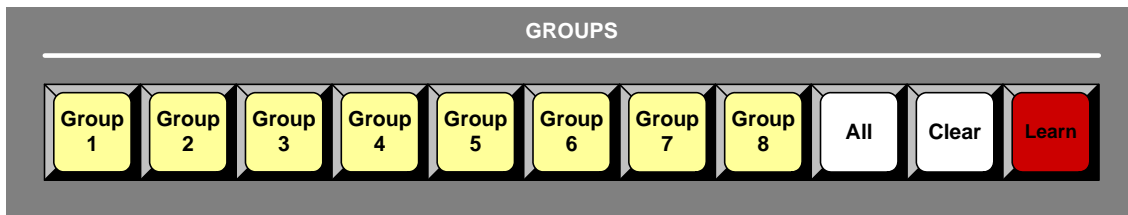
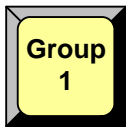


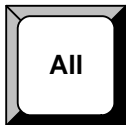
Figure 4-22. Group Control Section, Controller LC

A single “group” button can be programmed to represent one or more destinations. This feature simplifies the method by which you activate destinations. Descriptions of each button are provided below.



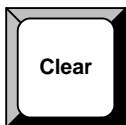
**Group Buttons** — four groups are available on the Controller SC; eight on the Controller LC. Any combination of **Group** buttons can be enabled, but all group selections (whether individual or multiple) are mutually exclusive.

- Press a numbered **Group** button *by itself* to enable the assigned destination(s) and toggle all other groups (and destinations) off. When pressed, the assigned destination buttons immediately light on the **Destination Bus**.
- Press two or more **Group** buttons simultaneously to enable multiple groups of destinations (e.g., Groups 1, 3 and 4), and toggle all other active groups (and destinations) off.



**All** — (Controller LC only)

- Press **All** to activate (enable) all assigned groups of destinations.
- On the Controller SC, you must simultaneously press all assigned **Group** buttons to perform the “all enable” function.



**Clear** — (Controller LC only)

- Press **Clear** + a selected **Group** button to clear that *one group only*.
- Press **Clear** + **ALL** to clear *all* active groups.
- On the Controller SC, there are two ways to clear a group:
  - ~ Press the group(s) that you wish to *remain* enabled (which will, in turn, clear the other un-selected groups).
  - ~ Press and hold the **Clear** button (on the **Destination Bus**), then press the button(s) for the destination(s) that you wish to clear.

## 4. Controller Orientation

### Controller Sections



#### Learn — (Controller LC only)

- To learn (program) a group button, activate the desired destinations on the **Destination Bus**, press and hold **Learn**, then press the desired **Group** button. This same method can be used to add (or remove) destinations from the group — simply by re-learning the button with a new array of destinations.
- To unlearn (completely clear) a group button so that it no longer lights, clear all destinations on the **Destination Bus (Clear + All)**, press and hold **Learn**, then press the desired **Group** button. Here, you are essentially programming the button with “no destinations.”

#### Learn method — (Controller SC only)

- To learn a group button, press and hold the desired **Group** button, then press the desired destination button(s) on the **Destination Bus**.
- To add a destination to an existing group, first select the group, press and hold the **Group** button, then press the desired new destination.
- To remove destinations from a group, first select the group, press and hold the **Group** button, then press the lit destination button that you want to remove. This method can also be used to unlearn (completely clear) a group button so that it no longer lights.

In Chapter 7, refer to the “[Working with Groups](#)” section on page 312 for instructions on all group functions.

Please note the following important points regarding group buttons:

- If you enable a group that *fully contains* all the destinations from another group, both group buttons will light.
  - ▲ **Group 1** contains destinations **1** and **2**, **Group 2** contains destinations **3** and **4**, and **Group 3** contains destinations **1**, **2**, and **4**. When you press the **Group 3** button by itself, it lights, and the **Group 1** button also lights — because both **Group 1** destinations are fully included in **Group 3**.

### Program Preset Section

The figures below illustrate the **Program Preset Section** on each Controller.

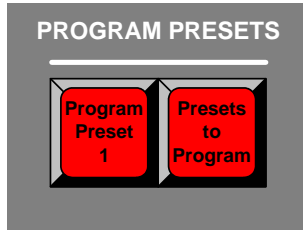


Figure 4-23. Program Preset Section, Controller SC

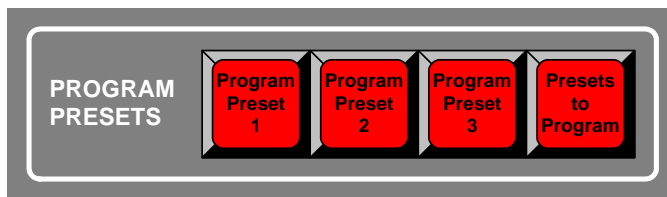


Figure 4-24. Program Preset Section, Controller LC

Descriptions of each button are provided below:

#### Program Preset Buttons —



#### Note

The functionality of **Program Preset** buttons 1, 2 and 3 is currently not implemented.

#### Presets to Program —



#### Note

The **Presets to Program** button is currently not implemented.

## 4. Controller Orientation

### Controller Sections

## Layer/Aux Control Section

The figures below illustrate the **Layer/Aux Control** section on each Controller model.

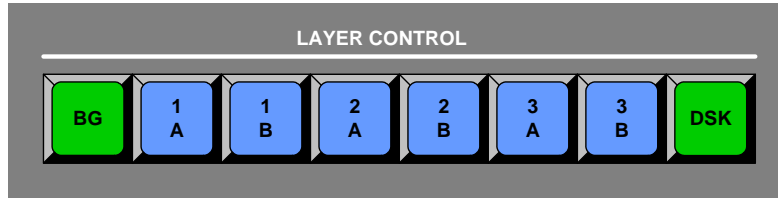


Figure 4-25. Layer/Aux Control Section, Controller SC

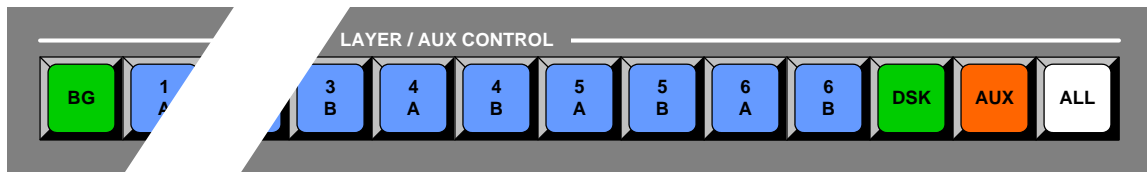
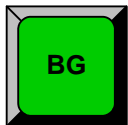


Figure 4-26. Layer/Aux Control Section, Controller LC

The buttons in the **Layer/Aux Control Section** provide additional “on air” layer control. Descriptions of each button are provided below:

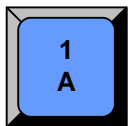
**BG** —



**Note**

The **BG** button in the **Layer/Aux Control Section** is not currently implemented.

**Layer Buttons** —



**Note**

The **Layer Buttons** in the **Layer/Aux Control Section** are not currently implemented.

**DSK** —



**Note**

The **DSK** button in the **Layer/Aux Control Section** is not currently implemented.

## 4. Controller Orientation

### Controller Sections

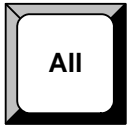
**AUX** — (Controller LC only)



**Note**

The **AUX** button in the **Layer/Aux Control Section** is not implemented.

**All** — (Controller LC only)



**Note**

The **ALL** button in the **Layer/Aux Control Section** is not currently implemented.

## 4. Controller Orientation

### Controller Sections

## Transition Functions Section

The figures below illustrate the **Transition Functions Section** on each Controller.

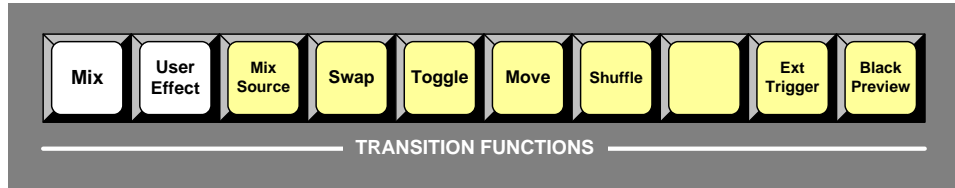


Figure 4-27. Transition Functions Section, Controller SC

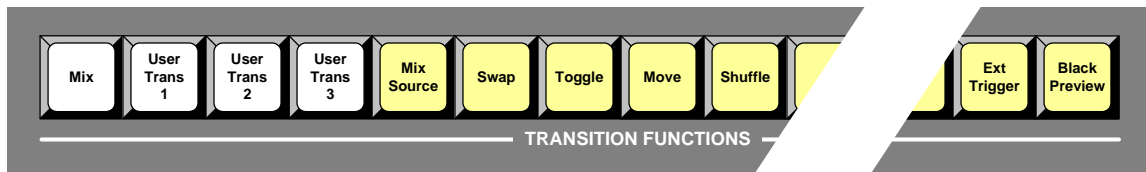
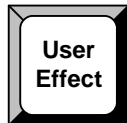


Figure 4-28. Transition Functions Section, Controller LC

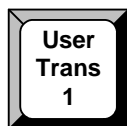
The buttons in the **Transition Functions Section** enable you to manipulate the transition itself. Descriptions of each button are provided below:



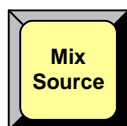
**Mix** — press to change the current transition type to a mix. The transition rate is defined on the **User Preference Menu**. In Chapter 5, refer to the [“User Preference Menu”](#) section on page 204 for details.



**User Effect** — (Controller SC only). Press to change the current transition type to a mix or a selected wipe, at a selected transition rate. All options for the **User Effect** button are defined on the **User Preference Menu**. In Chapter 5, refer to the [“User Preference Menu”](#) section on page 204 for details.



**User Trans 1, 2, 3** — (Controller LC only). Press to change the current transition type to a mix or a selected wipe, at a selected transition rate. All options for the three **User Trans** buttons are defined on the **User Preference Menu**. In Chapter 5, refer to the [“User Preference Menu”](#) section on page 204 for details.



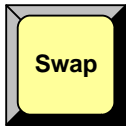
**Mix Source** — in “Mix Mode” for a given layer (with the **Split** button off), press **Mix Source** to co-locate both PIPs in the mixer.

- After a transition, layers **A** and **B** will be exactly the same size — in exactly the same position.
- Prior to a transition, the PIP on Preview can be changed in any manner — even if the other side of the mixer is on Program.
- **Mix Source** and **Swap** modes are mutually exclusive.

In Chapter 7, refer to the [“Understanding Split and Mix Modes”](#) section on page 321 for complete instructions on using mix mode.

## 4. Controller Orientation

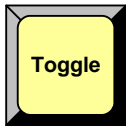
Controller Sections



**Swap** — in “Mix Mode” for a given layer (with the **Split** button off), press **Swap** to allow both PIPs in the mixer to be located independently.

- Layers **A** and **B** can be positioned and sized anywhere as desired.
- **Mix Source** and **Swap** modes are mutually exclusive.

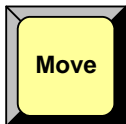
In Chapter 7, refer to the “[Understanding Split and Mix Modes](#)” section on page 321 for complete instructions.



**Toggle** — press to toggle sources back and forth with each transition. Once a source transitions off of Program within a PIP, it “flip-flops” to Preview.

- **Toggle** is used with both the **Mix Source** and **Swap** modes, and also functions with background transitions.

In Chapter 7, refer to the “[Understanding Split and Mix Modes](#)” section on page 321 for details on the Toggle mode.

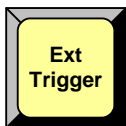
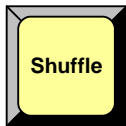


**Move** — press to pend a “move” for a PIP or key, enabling you to fly the PIP or key from one location to another on the next auto transition. In Chapter 7, refer to the “[Using Move](#)” section on page 336 for complete instructions.

**Shuffle** —

### Note

The **Shuffle** function is currently not implemented.



**Ext Trigger** — This function is only used with the **Barco Events Manager** or **Barco Stage Manager** applications. With these two products, operators can pause the timeline which in turn causes the **Ext Trigger** button to flash. Pressing **Ext Trigger** starts the timeline again. In Chapter 7, refer to the “[Using Ext Trigger](#)” section on page 333 for details.



**Black Preview** — This function enables you to transition all layers, backgrounds and the DSK to black, across all configured screens and all enabled destinations. The button is a toggle — press to enable black on Preview, press again to restore the previous “look.” In Chapter 7, refer to the “[Using Black Preview](#)” section on page 332 for details.

## 4. Controller Orientation

### Controller Sections

## User Key Section

The figure below illustrates the **User Key** section on the Controller LC. The Controller SC does not have User Keys.

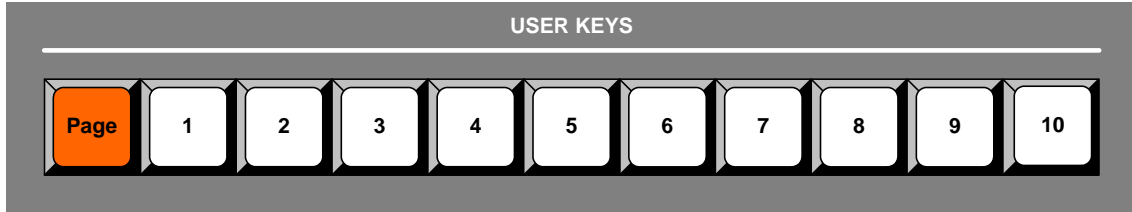


Figure 4-29. User Key Section, Controller LC

The buttons in the **User Key Section** are programmable. On the Controller LC, 100 user keys are available — 10 pages of 10 keys each.

When the **User Copy** button is pressed, the **User Key Copy Setup Menu** enables you to select all (or a portion) of the current effect's attributes (such as border color, size, aspect ratio, effects, etc.) The selected attributes can be stored on a **User Key** — and subsequently applied to any active layer.

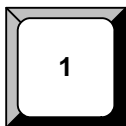
#### Note

If the selected layer is a Key, when a **User Key** is learned, it remembers the state of the Key (e.g., clip, gain, etc.) even though those options are not listed in the menu. If you then apply this **User Key** to a PIP, it changes to a Key.

Descriptions of each button are provided below:



**Page** — press and hold the **Page** button, then press the desired **User Key** (1 to 10) to switch to that page of user keys.



**User Keys** —

- To store the current layer's attributes in a user key, press and hold **User Copy** (in the **Layer Functions Section**) then press the desired **User Key**. All or a portion of an layer's attributes can be selected on the **User Key Copy Setup Menu**.
- To apply stored attributes to an active layer, activate the desired layer, then press the desired **User Key**.

In Chapter 7, refer to the "[Working with User Keys](#)" section on page 350 for additional operating instructions.

#### Note

Once you have reviewed all of the sections in this chapter, please continue with Chapter 5, "[Menu Orientation](#)" on page 145.



# 5. Menu Orientation

---

## In This Chapter

This chapter describes all Encore system menus, including how they are accessed, the functions that are available, and descriptions of each menu tree (in block diagram format).

The following topics are discussed:

- [Conventions in this Chapter](#)
- [Global Rules](#)
- [Home Menu](#)
- [Input Menu](#)
- [Output Menu](#)
- [System Menu](#)
- [Miscellaneous Menu](#)
- [Preset Recall Options Menu](#)
- [Effects Menu](#)
- [Copy Setup Menu](#)
- [User Key Copy Setup Menu](#)
- [Status Menu](#)
- [PIP Adjustment Menu](#)
- [Key Menu](#)
- [Crop Menu](#)
- [Source Adjustment Menus](#)
- [Background Input Setup Menu](#)
- [Frame Grab Menu](#)
- [DSK Menus](#)

**Note**

Once you have reviewed all of the sections in this chapter, please continue with Chapter 6, "[System Setup](#)" on page 259.

## 5. Menu Orientation

Conventions in this Chapter

---

### Conventions in this Chapter

Please note the following important conventions used in this chapter:

- Button labels on the **Touch Screen** are shown in bold uppercase letters between braces.  
▲ Press **{BORDR}** to ...
- The term **Processor** is used to represent both the “standard” **Video Processor (VP)** and **VPx**, unless otherwise noted.

---

### Global Rules

The following global rules apply to all menus:

- **Brackets** — parameters and values displayed between brackets (e.g., **[525]**) cannot be changed.
- **ID “All”** — For widescreen destinations, when the value “All” is shown for the **ID** parameter, it represents the lowest numbered ID in the destination, as configured (typically, number 1).
- **Alphanumeric Keypad** — On the Controller LC, the **Alphanumeric Keypad** can be used globally for certain numeric functions. In Chapter 7, refer to the [“Using the Alphanumeric Keypad”](#) section on page 310 for detailed instructions.
- **PS/2 Keyboard** — On both Controllers, a standard PS/2 style keyboards can be used globally for numeric entry, and also for “naming” certain functions. In Chapter 7, refer to the [“Using the PS/2 Keyboard”](#) section on page 311 for details.
- Press **{HOME}** to return to the **Home Menu**.
- Press **{BACK}** to return to the menu from which you accessed the current menu.

**Note**

The **{HOME}** and **{BACK}** buttons will not be explained again in this chapter.

## Home Menu

The figure below illustrates the **Home Menu** (on the Controller LC):

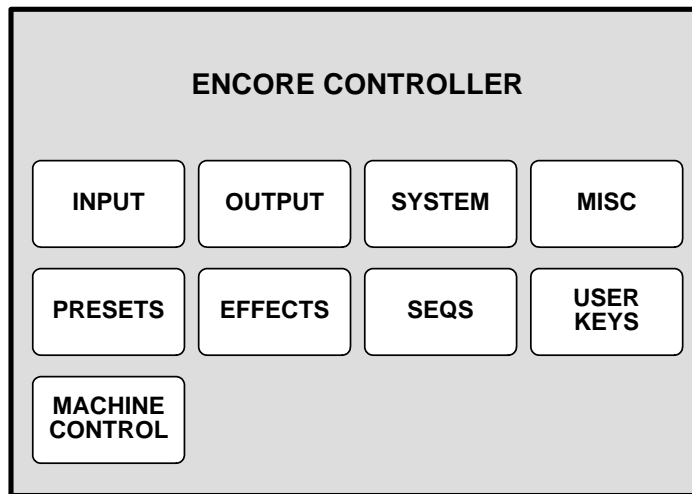


Figure 5-1. Home Menu, Controller LC

The **Home Menu** is the system's top level menu. To access a menu, press the desired button on the Touch Screen or in the **System Keypad**. You can return to the **Home Menu** by pressing the **{HOME}** softkey, which appears in the top left position of *almost* all menus.

**Note**

The **USER KEYS** and **MACHINE CONTROL** buttons are not available on the Controller SC's **Home Menu**.

The following menus can be accessed from the **Home Menu**:

- Press **{INPUT}** to access the **Input Menu**. Refer to the "[Input Menu](#)" section on page 148 for details.
- Press **{OUTPUT}** to access the **Output Menu**. Refer to the "[Output Menu](#)" section on page 158 for details.
- Press **{SYSTEM}** to access the **System Menu**. Refer to the "[System Menu](#)" section on [page 172](#) for details.
- Press **{MISC}** to access the **Miscellaneous Menu**. Refer to the "[Miscellaneous Menu](#)" section on page 196 for details.
- Press **{PRESETS}** to access the **Preset Recall Options Menu**. Refer to the "[Preset Recall Options Menu](#)" section on page 208 for details.
- Press **{EFFECTS}** to access the **Effects Menu**. Refer to the "[Effects Menu](#)" section on page 209 for details.
- Press **{USER KEYS}** to access the **User Key Copy Setup Menu** (Controller LC only). See the "[User Key Copy Setup Menu](#)" section on page 211 for details.

**Note**

The **Sequence** and **Machine Control** menus are currently not implemented.

## 5. Menu Orientation

### Input Menu

## Input Menu

The following topics are discussed in this section:

- [Input Menu Tree](#)
- [Input Menu Description](#)
- [Input Menu Functions](#)
- [Input Sub Menus](#)

## Input Menu Tree

The figure below illustrates the **Input Menu Tree**:

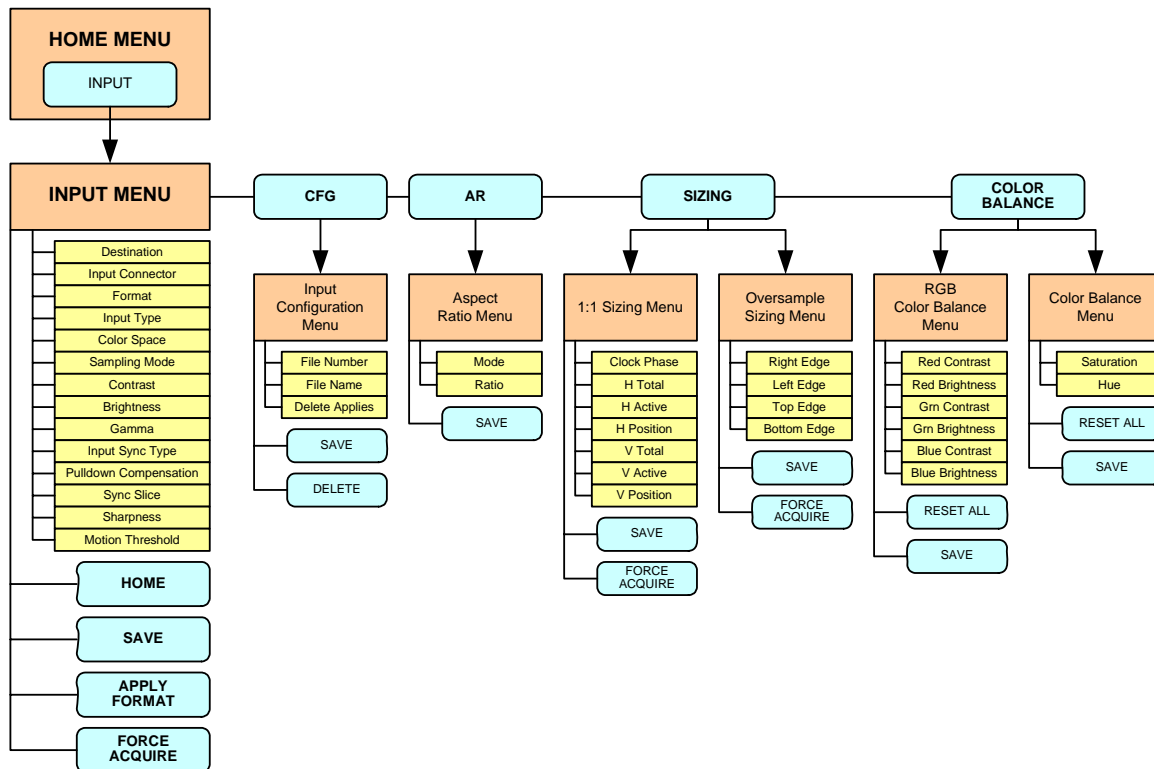


Figure 5-2. Input Menu Tree

All functions and sub menus are discussed in the following sections.

## Input Menu Description

The figure below illustrates the **Input Menu**:

HOME CFG AR SAVE	<b>INPUT MENU</b>		SRC_1	NAV ADJ
	<b>Destination</b>		1	
	<b>Input Connector</b>		HD-15	
	<b>Format</b> NTSC <480i>			
	<b>Input Type</b>		YPbPr	
	<b>Color Space</b>		[ SMPTE ]	
	<b>Sampling Mode</b>		[ 1:1 ]	
	<b>Contrast</b> <% >		100.0	
	<b>Brightness</b> <% >		100.0	
	<b>Gamma</b>		1.0	
APPLY FORMAT		SIZING	COLOR BALANCE	FORCE ACQUIRE

Figure 5-3. Input Menu (sample)

The **Input Menu** is used to adjust all parameters relating to both dedicated and routed inputs, including the physical sources connected to the Processor. The menu enables you to set all configuration options for the selected input.

To access the menu:

- Press a layer button in the **Layer Control Section** (the button blinks).
- Select an input on the **Source Selection Bus** (the button blinks).
- Press {INPUT} on the **Home Menu**, or press **Input** in the **Keypad Section**.

### Note

A layer must be selected in order to access the menu.

The currently selected input appears in the menu's upper right corner. The menu tracks the selected input, thus, if you switch inputs on the **Source Selection Bus**, the menu is immediately re-assigned to the new input.

## 5. Menu Orientation

### Input Menu

## Input Menu Functions

The following **Input Menu** functions are provided:

- **Destination** — indicates the destination on which you are currently working (as selected on the **Destination Bus**). This field is used for reference only, and cannot be adjusted on this menu.
- **Input Connector** — selects the physical connector to which the input is connected on the M/E, either **HD-15**, **DVI** or **BNC**. Please note:

#### Note

The choice of available formats varies depending on the selected connector and the destination device.

- ▲ When **BNC** is selected, only **Standard Definition** and **High Definition** resolutions can be selected.
- ▲ When a **VPx** destination is selected, **HD-15** and **BNC** connectors do not appear.

- **Format** — this line performs two functions:
  - ~ Displays the resolution that is automatically determined by the **FORCE ACQUIRE** function.
  - ~ Enables you to manually set the resolution of the incoming source. Once the format is selected, press **{APPLY FORMAT}** to accept.

In Appendix A, refer to the "[Input and Output Resolutions](#)" section on page 375 for details on all available resolutions.

#### Note

Selecting a format manually automatically defaults the **Input Type** and **Color Space**. In some cases, these two parameters cannot be changed due to the resolution.

- **Input Type** — sets the type of input connected to the M/E. Available choices *change* depending on the selected **Format**, and the choice affects the **Color Space** selection. Input types include:
  - ~ **RGB**
  - ~ **YP<sub>b</sub>P<sub>r</sub>**
  - ~ **Composite/S-Vid**
  - ~ **HD SDI**
  - ~ **SDI**
  - ~ **DVI Digital**
- **Color Space** — sets the input's color space, either **SMPTE** or **RGB**. The system automatically sets the Color Space based on the selected Format and/or Input Connector and Input Type — but in some cases, color space can be changed.
- **Sampling Mode** — sets the sampling mode for the selected input.
  - ~ When **1:1 Sampling** is selected, the system provides pixel-for-pixel sampling, and generally better image quality.
  - ~ When **Oversample** is selected, the system performs multiple samples for every pixel, with a resulting "softer" image.

- **Contrast** — sets the input's contrast.
  - ~ **Adjustment range:** 75% to 125%
- **Brightness** — sets the input's brightness.
  - ~ **Adjustment range:** 75% to 125%
- **Gamma** — sets the input gamma, enabling you to match the source's gamma.
  - ~ **Adjustment range:** 1.0 to 3.0
- **Input Sync Type** — sets the type of sync used by the source. Choices include:
  - ~ H/V
  - ~ CSync (composite sync)
  - ~ SOG (sync on green)
  - ~ Auto
- **Pulldown Compensation** — (On/Off) This function is applicable only for standard video (component, s-video, composite) inputs. The default mode is off. The feature should be turned on to process video derived from film material.
- **Sync Slice <mv>** — This function selects the sync comparator threshold for RGsB (RGB with Sync on Green) or YP<sub>b</sub>P<sub>r</sub> analog component video sources.
  - ~ **Adjustment range:** from 20mV to 280mV, adjustable in steps of 10mV. The default value is 160mV.

When Encore Presentation System detects Macrovision<sup>®</sup> copy protection on the incoming YP<sub>b</sub>P<sub>r</sub> NTSC/PAL video, the Sync Slice value is repositioned to 60mV to account for the reduced amplitude sync pulse.

#### Note

The default Sync Slice level has been optimized for virtually all sources that will be encountered and should rarely, if ever, require adjustment. However, you can adjust the level to improve sync detection and synchronization in cases of extremely noisy RGsB or YP<sub>b</sub>P<sub>r</sub> video signals.

- **Sharpness** — sets the input's sharpness.
  - ~ **Adjustment range:** -10 (very smooth) to 10 (very sharp).
- **Motion Threshold** — for interlaced sources only, this function adjusts the threshold of the motion adaptive de-interlacer. Because adjustment is rarely required, it is recommended that you leave the function at its default setting.
  - ~ **Adjustment range:** 0 to 15. The default value is 4.
- Press {**CFG**} to display the **Input Configuration Menu**. Refer to the "[Input Configuration Menu](#)" section on page 153 for details.
- Press {**AR**} to display the **Aspect Ratio Menu**. Refer to the "[Aspect Ratio Menu](#)" section on page 154 for details.
- Press {**SAVE**} to save the input in the designated input file. Using an automatic "copy down" function, the saved file will be transferred to all active destinations.

#### Note

Every submenu under the **Input Menu** includes a {**SAVE**} button, which enables you to save the input at any point in the adjustment process. The "save" uses the information selected on the **Input Configuration Menu**.

## 5. Menu Orientation

### Input Menu

**Note**

While in the **Input Menu** or any of its sub-menus, the **SAVE** button in the **System Keypad** also saves the configuration.

- Press {**APPLY FORMAT**} to “accept” a manually selected input format. In Appendix A, refer to the “[Input and Output Resolutions](#)” section on page 375 for details on all available resolutions.
- Press {**SIZING**} to display the **Sizing Menu**. Refer to the “[Sizing Menu](#)” section on page 155 for details.
- Press {**COLOR BALANCE**} to display the **Color Balance Menu**. Refer to the “[Color Balance Menu](#)” section on page 157 for details.
- Press {**FORCE ACQUIRE**} to force the system to perform the optimum image setup. Use this feature as a good starting point for setup.

**Note**

**FORCE ACQUIRE** only works on the selected input connector. Be sure to select the correct connector type before issuing the **FORCE ACQUIRE** command.



## Input Sub Menus

The following sub menus can be accessed from the **Input Menu**:

- [Input Configuration Menu](#)
- [Aspect Ratio Menu](#)
- [Sizing Menu](#)
- [Color Balance Menu](#)

### Input Configuration Menu

From the **Input Menu**, press {CFG} to display the **Input Configuration Menu**.

INPUT CONFIGURATION		SRC_1
File Number	1	
File Name	IFILE_001	
Delete Applies To:	Dest 1	

Navigation: BACK (left), NAV (right), ADJ (bottom right)

Buttons: SAVE, DELETE

**Figure 5-4.** Input Configuration Menu (sample)

Each input has an associated file that stores all input parameters and settings. Each time an input is selected on the **Source Selection Bus**, its associated file is recalled in the instant before it appears on Preview.

The **Input Configuration Menu** enables you to save or delete the input's associated file — which guarantees that the exact parameters you set are those that are used on air.

The following functions are provided:

- **File Number** — sets the file number into which data is stored. In the current version, the file number defaults to the input number and cannot be changed.
- **File Name** — sets the alphanumeric file name. In the current version, the file name automatically defaults to the input name and cannot be changed.
- **Delete Applies To** — because inputs may be set up differently depending upon the destination, this parameter enables you to identify the destination from which you want to delete the associated file.

## 5. Menu Orientation

### Input Menu

- Press {**SAVE**} to save the selected input in the designated input file.

#### Note

Two important modes on the **User Preference Menu** affect the way that sources are acquired and saved: **Auto Source Acquire** and **Auto Input Save**. Refer to the "[User Preference Menu](#)" section on page 204 for details.

- Press {**DELETE**} to delete the selected input file from the designated destination.

### Aspect Ratio Menu

From the **Input Menu**, press {**ASPECT RATIO**} to display the **Aspect Ratio Menu**.

B A C K	ASPECT RATIO	SRC_1	N A V
	Mode	Custom	
	Ratio	1.118	
S A V E			A D J

Figure 5-5. Aspect Ratio Menu (sample)

The **Aspect Ratio Menu** enables you to change the image's aspect ratio to pre-defined configurations, or enter a "custom" configuration.

- **Mode** — select **16:9**, **5:4**, **4:3**, **3:2**, **1:1** or **Custom** aspect ratios.
- **Ratio** — when **Custom** is selected in the **Mode** field, use the **ADJ** knob to enter a custom aspect ratio. The field is hidden when pre-defined ratios are selected.

## Sizing Menu

From the **Input Menu**, press {**SIZING**} to display one of two “context sensitive” **Sizing Menus** — they *change* depending on the **Sampling Mode** selected on the **Input Menu**.

- If **1:1 Sampling** is selected, the [1:1 Sizing Menu](#) appears.
- If **Oversample** is selected, the [Oversample Sizing Menu](#) appears.

Each menu and function is described below.

### 1:1 Sizing Menu

The figure below illustrates the **1:1 Sizing Menu**.

#### Note

The **1:1 Sizing Menu** can also be accessed from the **BG Input Setup Menu**, if “**Analog**” is the background type.

1:1 SIZING		SRC_1
<b>BACK</b>	<b>Clock Phase</b>	<b>0</b>
	H Total	800
	H Active	640
	H Position	116
	V Total	[ 525 ]
	V Active	475
	V Position	37
<b>SAVE</b>		
		<b>FORCE ACQUIRE</b>

Figure 5-6. 1:1 Sizing Menu (sample)

- **ID** — this field appears only when the menu is accessed via the **BG Input Setup Menu**, when “**Analog**” is selected as the input type. The field displays the ID(s) of the selected destination’s associated Video Processor.
- **Clock Phase** — sets the system’s A/D converter, allowing you to select where pixels are sampled (ideally, on the pixel’s peak).

~ **Adjustment range:** -16 to 15

For optimum visual results when adjusting high-resolution sources, project a burst test pattern and adjust the sampling for the minimum noise. Refer to the “[Test Pattern Menu](#)” section on page 166 for information on test patterns.

- **H Total** — sets the total pixel count per line.

#### Note

This field is not adjustable for digital sources (including digital signals on the DVI and BNC connectors), and not adjustable for NTSC and PAL sources, regardless of connection type.

## 5. Menu Orientation

### Input Menu

- **H Active** — sets the width of the active area.
- **H Position** — sets the start of the active area's horizontal offset from H sync.
- **V Total** — fixed value which cannot be adjusted.
- **V Active** — sets the number of vertical lines in the image.
- **V Position** — sets the start of the active area's vertical offset from V sync.
- Press **{SAVE}** to save the selected input in the designated input file.
- Press **{FORCE ACQUIRE}** to force the system to perform the optimum image setup. After the Force Acquire function is performed, the system remains on the **1:1 Sizing Menu**.

#### Note

If you switch to another input and there is no valid input video, the settings are not applicable and **N/A** is displayed.

### Oversample Sizing Menu

The figure below illustrates the **Oversample Sizing Menu**.

OVERSAMPLE SIZING		SRC_1
<b>Right Edge</b>	<b>4062</b>	<b>N/A</b>
<b>Left Edge</b>	<b>606</b>	
<b>Top Edge</b>	<b>36</b>	
<b>Bottom Edge</b>	<b>519</b>	

BACK

SAVE

FORCE ACQUIRE

ADJ

Figure 5-7. Oversample Sizing Menu (sample)

With **Oversample** enabled, four timing parameters are provided that enable you to adjust the image to properly fit the image's raster box.

- Select and adjust **Right Edge**, **Left Edge**, **Top Edge** or **Bottom Edge** as required, to fit the image precisely in its raster box.
- Press **{SAVE}** to save the selected input in the designated input file.
- Press **{FORCE ACQUIRE}** to force the system to perform the optimum image setup. After the Force Acquire function is performed, the system remains on the **Oversample Sizing Menu**.

#### Note

If you switch to another input and there is no valid input video, the settings are not applicable and **N/A** is displayed.

## Color Balance Menu

From the **Input Menu**, press {**COLOR BALANCE**} to display the **Color Balance Menu**.

**Note**

The **Color Balance Menu** can also be accessed from the **BG Input Setup Menu**, if “**Analog**” is the selected background.



Figure 5-8. Color Balance Menu (sample)

The **Color Balance Menu** changes depending on the selected **Input Type**.

- **ID** — this field appears only when the menu is accessed via the **BG Input Setup Menu**, when “**Analog**” is selected as the input type. The field displays the ID(s) of the selected destination’s associated Processor.
- When **RGB** sources are selected, the **Color Balance Menu** provides individual contrast and brightness adjustments for red, green and blue.
  - ~ **Adjustment range:** -25% to +25%
- When **Composite**, **S-Video** or **YP<sub>b</sub>P<sub>r</sub>** is selected, adjust Saturation and Hue:
  - ~ **Adjustment range (Saturation):** 75% to 125%
  - ~ **Adjustment range (Hue):** -90.0 to 90.0, in degrees

**Note**

When the **Input Type** is **YP<sub>b</sub>P<sub>r</sub>**, the **Hue** field reads **N/A** because Hue does not apply to this type of source.

- Press {**SAVE**} to save the selected input in the designated input file.
- Press {**RESET ALL**} to return all parameters to **0** (zero).

## 5. Menu Orientation

### Output Menu

---

## Output Menu

The following topics are discussed in this section:

- [Output Menu Tree](#)
- [Output Menu Description](#)
- [Output Menu Functions](#)
- [Output Sub Menus](#)

### Output Menu Tree

The figure below illustrates the **Output Menu Tree**:

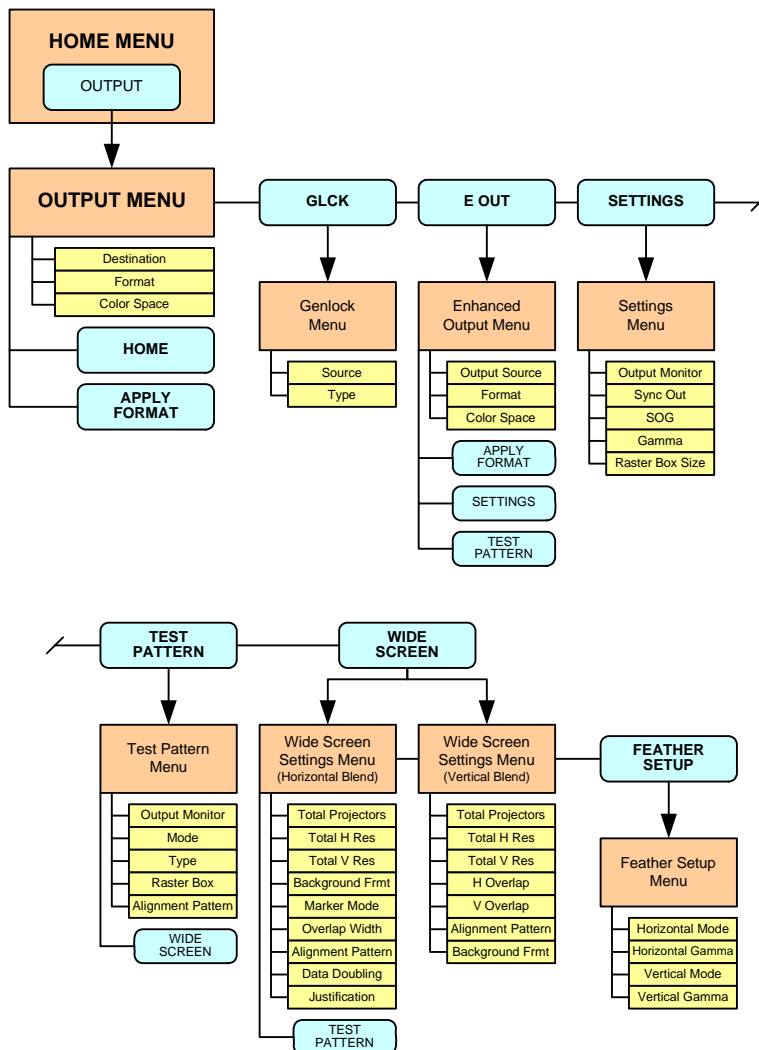


Figure 5-9. Output Menu Tree

All functions and submenus are discussed in the following sections.

## Output Menu Description

The figure below illustrates the **Output Menu**:



**Figure 5-10.** Output Menu (sample)

The **Output Menu** enables you to configure Processor and ScreenPRO-II outputs, including the ability to set widescreen parameters and display test patterns.

To access the menu:

- Select a destination on the **Destination Bus**.
- Press **{OUTPUT}** on the **Home Menu**, or press **Output** in the **Keypad Section**.

The menu cannot be accessed unless a destination is selected. The currently selected destination is shown in the menu's upper right corner. The menu tracks the destination, thus, if you switch destinations, the menu is immediately re-assigned.

## 5. Menu Orientation

### Output Menu

## Output Menu Functions

The following **Output Menu** functions are provided:

- **Destination** — indicates the destination on which you are currently working (as selected on the **Destination Bus**). If multiple destinations are active, you can select one of them using this field.

#### Note

A selected Processor destination can be configured as a single screen or multiple screens (in a widescreen application). In this situation, all changes to the **Output Menu** affect all Processors in a widescreen definition. ScreenPRO-II destinations are single screen.

- **Format** — sets the resolution and frame rate at which you want to drive your projector(s). To minimize synchronization problems, select a frame rate that is consistent with your input sources.
  - ▲ If you are using 59.94 NTSC video inputs, run the output at the same rate in order to reduce jutter artifacts.After selecting a format, press **{APPLY FORMAT}** to accept the selection. In Appendix A, refer to the [“Input and Output Resolutions”](#) section on page 375 for details on all available resolutions.
- **Color Space** — sets the output’s color space, either RGB or YP<sub>b</sub>P<sub>r</sub> — per the specifics of your projector.
- For **ScreenPRO-II**s with the **EOC** option installed, press **{E OUT}** to display the **Enhanced Output Menu**. The label does not appear for **SP-II**s that do not have the option. Refer to the [“Enhanced Output Menu”](#) section on page 161.
- For **VP**s only, press **{GLCK}** to display the **Genlock Menu**. The label does not appear for **VPx** destinations. Refer to the [“Genlock Menu”](#) section on page 164 for details.
- Press **{APPLY FORMAT}** to accept a selected output format.
- Press **{SETTINGS}** to display the **Settings Menu**. Refer to the [“Settings Menu”](#) section on page 165 for details.
- Press **{TEST PATTERN}** to display the **Test Pattern Menu**. Refer to the [“Test Pattern Menu”](#) section on page 166 for details.
- Press **{WIDE SCREEN}** to display the **Wide Screen Menu**. Refer to the [“Wide Screen Settings Menu”](#) section on page 167 for details. This softkey label only appears when a widescreen destination is selected.

## Output Sub Menus

The following sub menus can be accessed from the **Output Menu**:

- [Enhanced Output Menu](#)
- [Genlock Menu](#)
- [Settings Menu](#)
- [Test Pattern Menu](#)
- [Wide Screen Settings Menu](#)



## Enhanced Output Menu

From the **Output Menu**, press {E OUT} to display the **Enhanced Output Menu**.

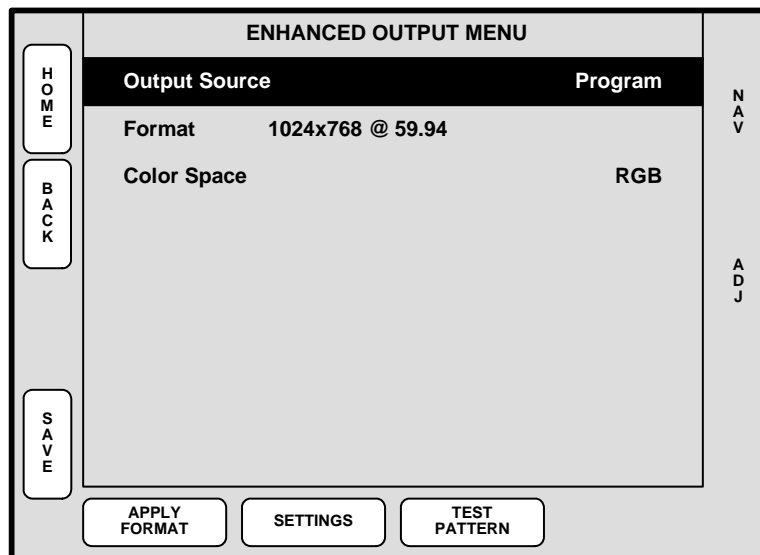


Figure 5-11. Enhanced Output Menu (sample)

The **Enhanced Output Menu** sets up basic parameters for SP-II's enhanced output.

**Note**

The menu is only available for ScreenPRO-II units that have the **EOC** (Enhanced Output Card) option installed.

- **Source** — selects the source of the SP-II's enhanced output signal. Select between **Program** and **Preview**.
- **Format** — sets the resolution and frame rate at which you want to drive the enhanced output. The EOC supports the following resolutions:
 

~ NTSC (480i)	~ 1400 x 1050
~ PAL (576i)	~ 1600 x 1200
~ 800 x 600	~ 1280 x 720p @ 50, 59.94, 60
~ 1024 x 768	~ 1920 x 1080i @ 50, 59.94, 60
~ 1280 x 1024	~ 1920 x 1080p @ 25, 29.97, 30
- **Color Space** — sets the output's color space to either **RGB** or **YP<sub>b</sub>P<sub>r</sub>**.
- Press {**SAVE**} to save all enhanced output parameters.
- Press {**APPLY FORMAT**} to accept a selected output format.
- Press {**SETTINGS**} to display the **Enhanced Output Settings Menu**. Refer to the "[Enhanced Output Settings Menu](#)" section on page 162 for details.
- Press {**TEST PATTERN**} to display the **Enhanced Output Test Pattern Menu**. Refer to the "[Enhanced Output Test Pattern Menu](#)" section on page 163 for complete details.

## 5. Menu Orientation

### Output Menu

#### Enhanced Output Settings Menu

From the **Enhanced Output Menu**, press {**SETTINGS**} to display the **Enhanced Output Settings Menu**.

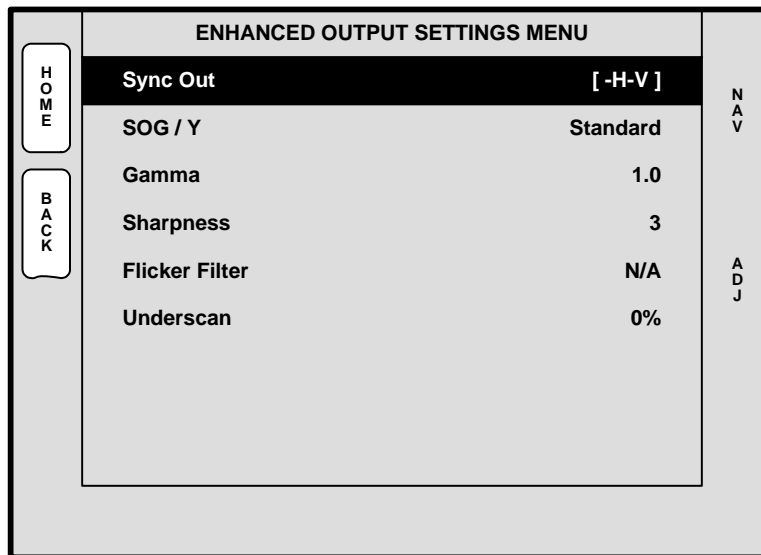


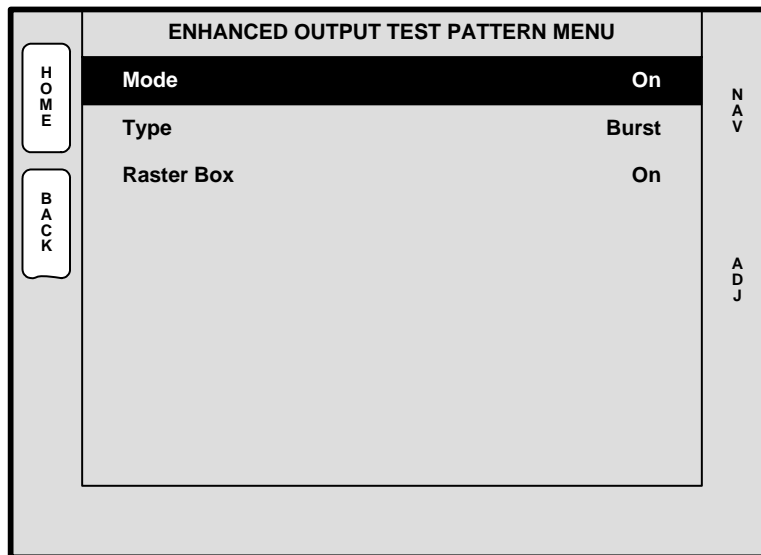
Figure 5-12. Enhanced Output Settings Menu (sample)

The **Enhanced Output Settings Menu** enables you to set specific parameters for the ScreenPRO-II's enhanced output.

- **Sync Out** — sets the desired sync value. Choose between **+H+V**, **-H-V**, **+H-V**, **-H+V** or **CSync**.
- **SOG / Y** — selects a specific “sync on green” signal. Choose between **Off**, **Standard** or **Tri-Level** (for certain HD devices).
- **Gamma** — sets the output gamma.
- **Flicker Filter** — this option enables you to reduce flicker, only when interlaced formats are selected.
  - ~ **Adjustment range:** OFF (no reduction) or 1 (minimum reduction) through 20 (maximum reduction).
- **Underscan** — enables you to visually expand the output, typically to mask unwanted edges of the video signal. The value is a percentage of the selected output resolution.

**Enhanced Output Test Pattern Menu**

From the **Enhanced Output Menu**, press {TEST PATTERN} to display the **Enhanced Output Test Pattern Menu**.



**Figure 5-13.** Enhanced Output Test Pattern Menu (sample)

The **Enhanced Output Test Pattern Menu** enables you to display SP-II test patterns for projector or monitor alignment.

- **Mode** — enables you to turn SP-II test patterns on or off.
- **Type** — sets the test pattern. Choose between **H Ramp, V Ramp, 100% Color Bars, 16x16 Grid, 32x32 Grid, Burst, 75% Color Bars, 50% Gray, Gray Steps 1, Gray Steps 2, White, Black, Red, Green, Blue** and **Gray Bars**.
- **Raster Box** — when enabled, displays a raster box defined by the exact outer edges of the selected output resolution.

## 5. Menu Orientation

### Output Menu

#### Genlock Menu

From the **Output Menu**, press {GLCK} to display the **Genlock Menu**.

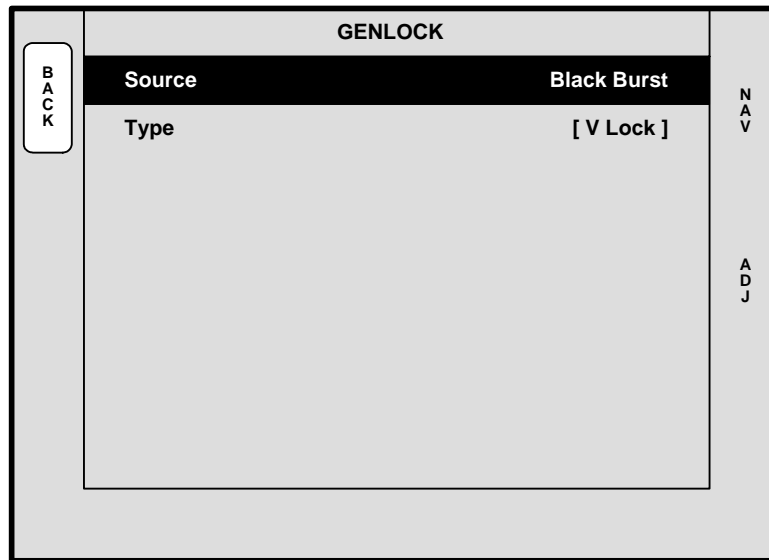


Figure 5-14. Genlock Menu (sample)

The **Genlock Menu** tells the VP which type of analog genlock signal is connected to the Processor's **Genlock** connector.

#### Note

The menu is only available for **VP** destinations. The label does not appear for **VPx** destinations.

- **Source** — sets the genlock source, either **Black Burst**, **CSync** or **None**.
- **Type** — displays the type of genlock provided:
  - ~ When Source = **None**, Type = **[Free-Run]**
  - ~ When Source = **Black Burst**, Type = **[V Lock]**
  - ~ When Source = **CSync**, Type = **[V Lock]**

Please note:

- PAL or NTSC black burst or composite sync signals are recommended.
- In wide screen applications, all Processors must be locked together. If you provide genlock to the first Processor in your configuration, genlock is automatically distributed to the other Processors via **Program Link** connections.
- If you do not use genlock in a wide screen application, Encore automatically makes the first Processor in your configuration the master.
- In single screen applications, each Processor requires its own genlock signal.
- Genlock is highly recommended in configurations that utilize camera sources.

## Settings Menu

From the **Output Menu**, press {**SETTINGS**} to display the **Settings Menu**.

SETTINGS				
B A C K	<b>Output Monitor</b>	All	N A V	
	Analog Sync Out	-H-V		
	DVI Sync Out	-H-V		
	SOG / Y	Off		
	Gamma	1.0		A D J
	Raster Box Size	3		
	Flicker Filter	1		

Figure 5-15. Settings Menu (sample)

The **Settings Menu** sets sync parameters for your system's monitors and projectors.

- **Output Monitor** — selects the monitor(s) that are affected by the sync settings, either **All**, **Program 1**, **Program 2** or **Preview**.
- **Analog Sync Out** — sets the desired analog output sync value. Choose between **+H+V**, **-H-V**, **+H-V**, **-H+V** or **CSync**.
- **DVI Sync Out** — sets the desired DVI output sync value. Choose between **+H+V**, **-H-V**, **+H-V**, **-H+V** or **CSync**.
- **SOG / Y** — selects a specific “sync on green” signal. Choose between **Off**, **Standard** or **Tri-Level** (for certain HD devices).
- **Gamma** — sets the output gamma to match that of your projector(s).
- **Raster Box Size** — sets the size of the raster box that appears around PIPs and Keys.
  - ~ **Adjustment range** (in pixels): 0 to 8
- **Flicker Filter** — this option only appears when an interlaced output format is selected (e.g., 1920x1080i @ 60).
  - ~ **Adjustment range**: OFF (no reduction) or 1 (minimum reduction) through 20 (maximum reduction).

## 5. Menu Orientation

### Output Menu

#### Test Pattern Menu

From the **Output Menu**, press {**TEST PATTERN**} to display the **Test Pattern Menu**.

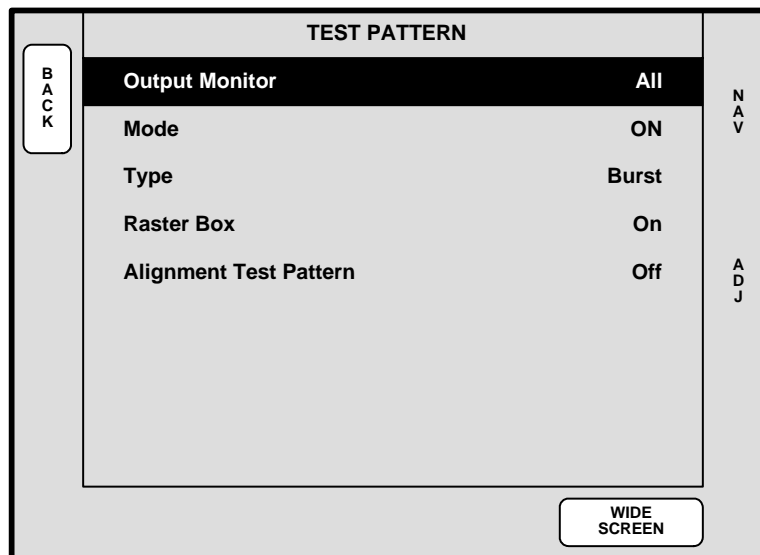


Figure 5-16. Test Pattern Menu (sample)

The **Test Pattern Menu** enables you to display test patterns for projector alignment.

- **Output Monitor** — selects the monitor(s) that are affected by the test pattern settings, either **All**, **Program 1**, **Program 2** or **Preview**.
- **Mode** — enables you to turn test patterns on or off.
- **Type** — sets the test pattern. Choose between **H Ramp**, **V Ramp**, **100% Color Bars**, **16x16 Grid**, **32x32 Grid**, **Burst**, **75% Color Bars**, **50% Gray**, **Gray Steps 1**, **Gray Steps 2**, **White**, **Black**, **Red**, **Green**, **Blue** and **Gray Bars**.
- **Raster Box** — when enabled, displays a raster box defined by the exact outer edges of the selected output resolution.
  - ▲ If the output is 1024 x 768, the raster box encapsulates that format.

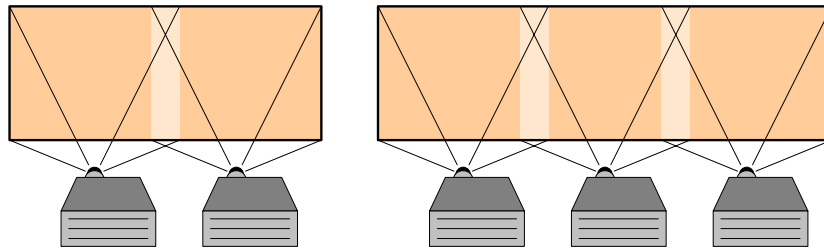
Please note:

- ~ The **Burst** test pattern is the only pattern that is smaller than the selected output resolution. When the **Raster Box** is enabled, the Burst pattern will appear within its boundaries.
- ~ The **Raster Box** can be enabled when the test pattern is **Off**.
- **Alignment Test Pattern** — this field appears in wide screen mode only.
  - ~ Select **Off** to turn the alignment test pattern off.
  - ~ Select **Hor** to display a test pattern of horizontal lines.
  - ~ Select **Ver** to display a test pattern of vertical lines.
  - ~ Select **Both** to display a test pattern of both horizontal and vertical lines.
- Press {**WIDE SCREEN**} to display the **Wide Screen Menu**. Refer to the "[Wide Screen Settings Menu](#)" section on page 167 for details. This softkey label only appears when a widescreen destination is selected.

### Wide Screen Settings Menu

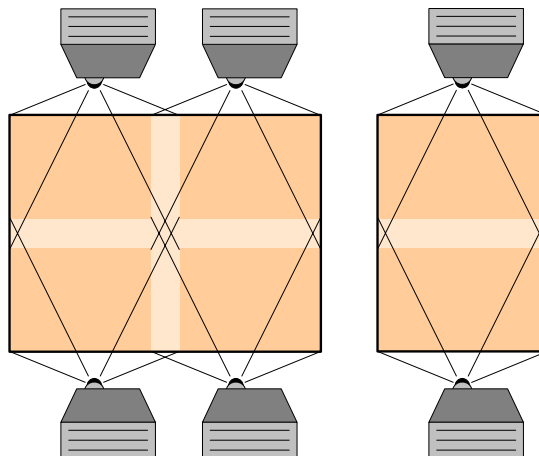
From the **Output Menu**, press {**WIDE SCREEN**} to display the **Wide Screen Settings Menu**. Two different menus can appear, depending on the selected “array” of destinations, as configured on the **Destination Setup Menu**.

- If the widescreen destination is a horizontal array of projectors, the **Wide Screen Settings Menu (H Array)** appears. Refer to the [Wide Screen Settings Menu \(H Array\)](#) section on page 168 for details.



**Figure 5-17.** Sample horizontal arrays (Array dimensions: 2W x 1H, 3W x 1H)

- If the widescreen destination includes any vertical blending element, the **Wide Screen Settings Menu (V Array)** appears. Refer to the [Wide Screen Settings Menu \(V Array\)](#) section on page 169 for details.



**Figure 5-18.** Sample vertical arrays (Array dimensions: 2W x 2H, 1W x 2H)

#### Note

Barco offers the **Configurator** application to assist with wide screen setup.

## 5. Menu Orientation

### Output Menu

#### Wide Screen Settings Menu (H Array)

The **Wide Screen Settings Menu (H Array)** provides tools for wide screen setup and adjustment for horizontal arrays of destinations.

WIDE SCREEN SETTINGS	
<b>Total Projectors</b>	<b>[ 2 ]</b>
<b>Total H Res</b>	<b>1808</b>
<b>Total V Res</b>	<b>[ 768 ]</b>
<b>Background Format</b>	<b>Edge-Butted</b>
<b>Marker Mode</b>	<b>On</b>
<b>Overlap Width</b>	<b>240</b>
<b>Alignment Test Pattern</b>	<b>Off</b>
<b>Data Doubling</b>	<b>On</b>
<b>Justification</b>	<b>Center</b>

Navigation buttons: B A C K (left), N A V (right), A D J (right), TEST PATTERN (bottom left), FEATHER SETUP (bottom right)

Figure 5-19. Sample Wide Screen Settings Menu (H Array)

The following functions are provided:

- **Total Projectors** — indicates the total number of Processors as defined in the wide screen configuration. This field is for information only.
- **Total H Res** — sets the total number of horizontal pixels in the overall wide screen display. The formula is:

$$\# \text{ screens} * \text{horizontal output resolution} - (\text{overlap width} * (\# \text{ screens} - 1))$$

- ▲ If two screens are used, each with an output resolution of 1024 x 768 and an overlap of 200 pixels, the **Total H Res** is:

$$2 * 1024 - (200 * 1) = 1848$$

As you adjust the **Total H Res**, the **Overlap Width** value tracks and the wide screen markers adjust accordingly.

- **Total V Res** — displays the vertical resolution. In an array that is exclusively horizontal, this field is fixed.
- **Background Format** — selects the method by which your background graphics were originally produced:
  - ~ **Edge-butted** — choose this option if your background graphics were produced with no pre-data doubling (e.g., typically from a multi-head graphics card).
  - ~ **Overlapped** — choose this option if your backgrounds were produced using pre-data doubling (e.g., from a Dataton<sup>®</sup> Watchout system).



## 5. Menu Orientation

Output Menu

- **Marker Mode** — enables and disables the wide screen markers, to show the boundaries of active data. In Chapter 7, refer to the [“Wide Screen Markers”](#) section on page 305 for details.

### Note

Markers apply to horizontal blends (e.g., **3W x 1H**), and to horizontal + vertical arrays (e.g., **2W x 2H**), but do not apply to vertical blends (e.g., **1W x 3H**).

- **Overlap Width** — sets the horizontal overlap (in pixels) between projectors. As you adjust, the **Total H Res** value tracks, and wide screen markers adjust.
- **Alignment Test Pattern** — selects the desired alignment test pattern used for performing projector lens shift and registration adjustments.
- **Data Doubling** — enables or disables data doubling. Typically, the function is only disabled when unscaled background sources are pre-data doubled. In Chapter 3, refer to the [“Overview of Edge-Blending Technology”](#) section on page 98 for more information.
- **Justification** — sets the desired wide screen justification, either **Center** or **Left**. Once set, wide screen markers adjust accordingly.
- Press **{TEST PATTERN}** to display the **Test Pattern Menu**. Refer to the [“Test Pattern Menu”](#) section on page 166 for details.
- Press **{FEATHER SETUP}** to display the **Feather Setup Menu**. Refer to the [“Feather Setup Menu”](#) section on page 171 for details.

### Wide Screen Settings Menu (V Array)

The **Wide Screen Settings Menu (V Array)** provides tools for wide screen setup and adjustment for arrays of destinations that include any vertical blending element.

WIDE SCREEN SETTINGS	
<b>Total Projectors</b>	<b>[ 2W x 2H ]</b>
<b>Total H Res</b>	<b>1848</b>
<b>Total V Res</b>	<b>1336</b>
<b>H Overlap</b>	<b>200</b>
<b>V Overlap</b>	<b>200</b>
<b>Alignment Test Pattern</b>	<b>Off</b>
<b>Background Format</b>	<b>[ Overlapped ]</b>

BACK

NAV

ADJ

FEATHER SETUP

Figure 5-20. Sample Wide Screen Settings Menu (V Array)

The following functions are provided:

- **Total Projectors** — indicates the total number of Processors in the array, and provides the array's dimensions (e.g., 2W x 2H, 1W x 2H). This field is for information only.

## 5. Menu Orientation

### Output Menu

- **Total H Res** — sets the total number of horizontal pixels in the overall wide screen display. The formula is:

$$\# \text{ screens} * \text{horizontal output resolution} - (\text{H overlap} * (\# \text{ screens} - 1))$$

As you adjust the **Total H Res**, the **H Overlap** value tracks. Note that this field is fixed in an exclusive vertical array.

- **Total V Res** — sets the total number of vertical lines in the overall vertical array. The formula is:

$$\# \text{ screens} * \text{vertical output resolution} - (\text{V overlap} * (\# \text{ screens} - 1))$$

As you adjust the **Total V Res**, the **V Overlap** value tracks. Note that this field is fixed in an exclusive horizontal array.

- **H Overlap** — sets the horizontal overlap (in pixels) between projectors. As you adjust, the **Total H Res** value tracks.
- **V Overlap** — sets the vertical overlap (in lines) between projectors. As you adjust, the **Total V Res** value tracks.
- **Alignment Test Pattern** — selects the desired test pattern used for performing projector lens shift and registration adjustments.
- **Background Format** — displays the **[Overlapped]** method, because the system cannot perform data doubling when the destination includes a vertical blend. In this mode, your backgrounds must be produced using pre-data doubling (e.g., from a Dataton<sup>®</sup> Watchout system).
- Press **{FEATHER SETUP}** to display the **Feather Setup Menu**. Refer to the "[Feather Setup Menu](#)" section on page 171 for details.

**Feather Setup Menu**

From the **Wide Screen Settings Menu**, either (**V Array**) or (**H Array**), press **{FEATHER SETUP}** to display the **Feather Setup Menu**.

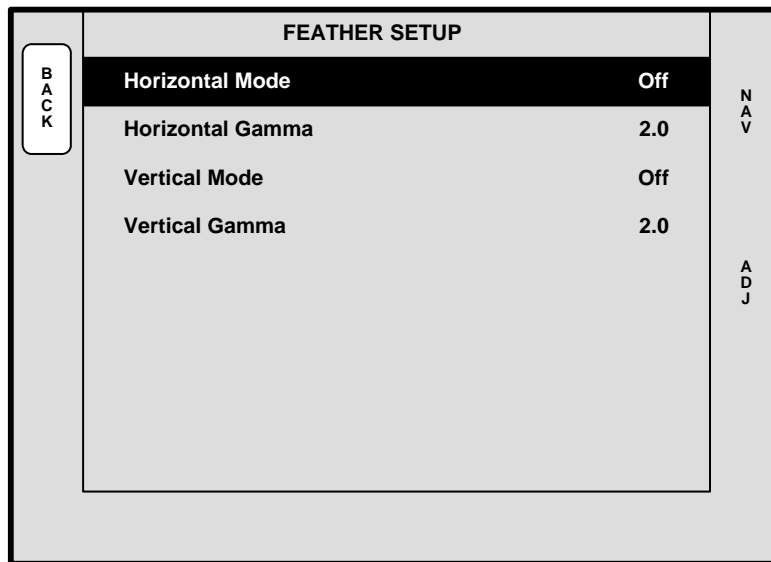


Figure 5-21. Feather Setup Menu (sample)

The **Feather Setup Menu** enables you to adjust the horizontal and vertical feathering between projectors, with precision. The following functions are provided:

- **Horizontal Mode** — enables or disables edge feathering between projectors in a destination that includes a horizontal blend. If the array does not include a horizontal blend, this function is bracketed.
- **Horizontal Gamma** — sets gamma for the feathered regions in a horizontal blend. If the array does not include a horizontal blend, this function is bracketed.  
~ **Adjustment range:** 1.0 to 5.0
- **Vertical Mode** — enables or disables edge feathering between projectors in a destination that includes a vertical blend. If the array does not include a vertical blend, this function is bracketed.
- **Vertical Gamma** — sets gamma for the feathered regions in a vertical blend. If the array does not include a vertical blend, this function is bracketed.  
~ **Adjustment range:** 1.0 to 5.0

## 5. Menu Orientation

### System Menu

## System Menu

The following topics are discussed in this section:

- [System Menu Tree](#)
- [System Menu Description](#)
- [System Sub Menus](#)

## System Menu Tree

The figure below illustrates the **System Menu Tree**:

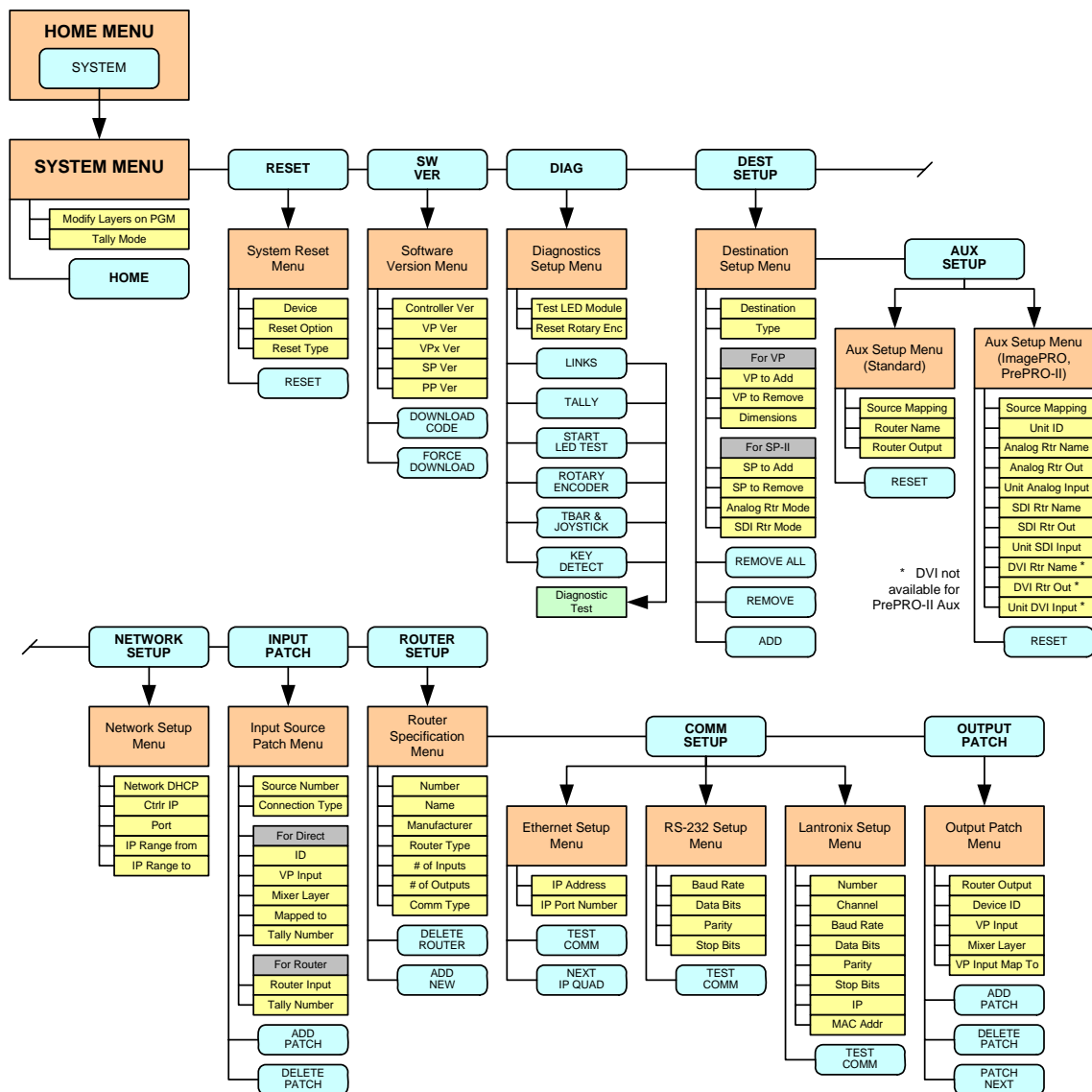


Figure 5-22. System Menu Tree

All functions and sub menus are discussed in the following sections.

## System Menu Description

The figure below illustrates the **System Menu**:

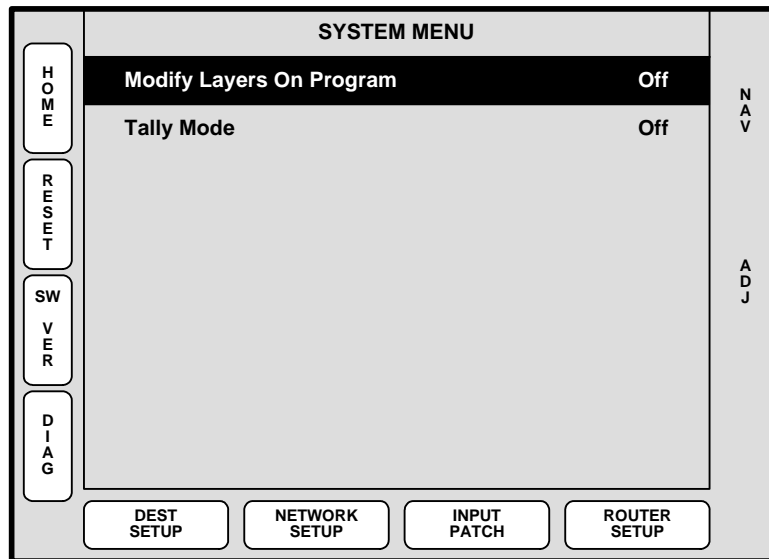


Figure 5-23. System Menu (sample)

To access the menu:

- Press **{SYSTEM}** on the **Home Menu**, or press **System** in the **Keypad Section**.

The **System Menu** enables you to configure the Controller:

- **Modify Layers On Program** — when enabled, you can change PIPs and Keys directly on Program, without first setting up your “look” on Preview. When disabled, you must use Preview to set up the next look. In Chapter 7, refer to the [“Modifying Layers On Program”](#) section on page 328 for details.
- **Tally Mode** — enables or disables the tally function.
  - ~ When enabled, all eight tallies are activated, and can be triggered by pressing a source button.
  - ~ When disabled, all tallies are deactivated (but tally setups remain as configured).

In Chapter 6, refer to the [“Output Format Setup”](#) section on page 285 for tally setup details. In Chapter 7, refer to the [“Working with Tallies”](#) section on page 351 for tally operating instructions.

- Press **{RESET}** to display the **System Reset Menu**. Refer to the [“System Reset Menu”](#) section on page 175 for details.
- Press **{SW VER}** to display the **Software Version Menu**. Refer to the [“Software Version Menu”](#) section on page 176 for details.
- Press **{DIAG}** to display the **Diagnostics Setup Menu**. Refer to the [“Diagnostics Setup Menu”](#) section on page 177 for details.
- Press **{DEST SETUP}** to display the **Destination Setup Menu**. Refer to the [“Destination Setup Menu”](#) section on page 182 for details.
- Press **{NETWORK SETUP}** to display the **Network Setup Menu**. Refer to the [“Network Setup Menu”](#) section on page 187 for details.

## 5. Menu Orientation

### System Menu

- Press {INPUT PATCH} to display the **Input Source Patch Menu**. Refer to the "[Input Source Patch Menu](#)" section on page 188 for details.
- Press {ROUTER SETUP} to display the **Router Specification Menu**. Refer to the "[Router Specification Menu](#)" section on page 190 for details.

## System Sub Menus

The following sub menus can be accessed from the **System Menu**:

- [System Reset Menu](#)
- [Software Version Menu](#)
- [Diagnostics Setup Menu](#)
- [Destination Setup Menu](#)
- [Network Setup Menu](#)
- [Input Source Patch Menu](#)
- [Router Specification Menu](#)

## System Reset Menu

From the **System Menu**, press {**RESET**} to display the **System Reset Menu**:

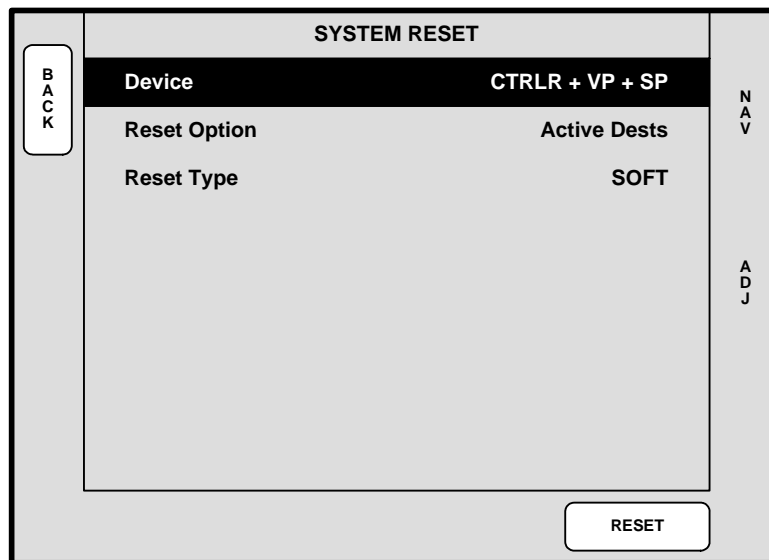


Figure 5-24. System Reset Menu (sample)

The **Reset Menu** enables you to perform various system reset functions. The following functions are provided:

- **Device** — selects which device(s) to reset. Choose between **CTRLR+VP+SP**, **CONTROLLER**, **VP** or **SP**.

**Note**

**CTRLR** = Controller  
**VP** = Video Processor and VPx  
**SP** = ScreenPRO-II

- **Reset Option** — for the selected device(s), chooses the subset that you wish to reset. Choose between **All VPs and SPs**, **All Detected VPs**, **All Detected SPs**, or **Active Dests**.
- **Reset Type** — selects the type of reset that you wish to perform. Choose between **SOFT** or **FACTORY**. Note that selecting **SOFT** will not delete any user defined configurations, while **FACTORY** deletes all user configurations.
- Press {**RESET**} to perform the selected reset operation. When the confirmation screen appears:
  - ~ Press {**YES**} to start the procedure.
  - ~ Press {**NO**} to cancel the procedure.

## 5. Menu Orientation

### System Menu

#### Software Version Menu

From the **System Menu**, press {SW VER} to display the **Software Version Menu**.

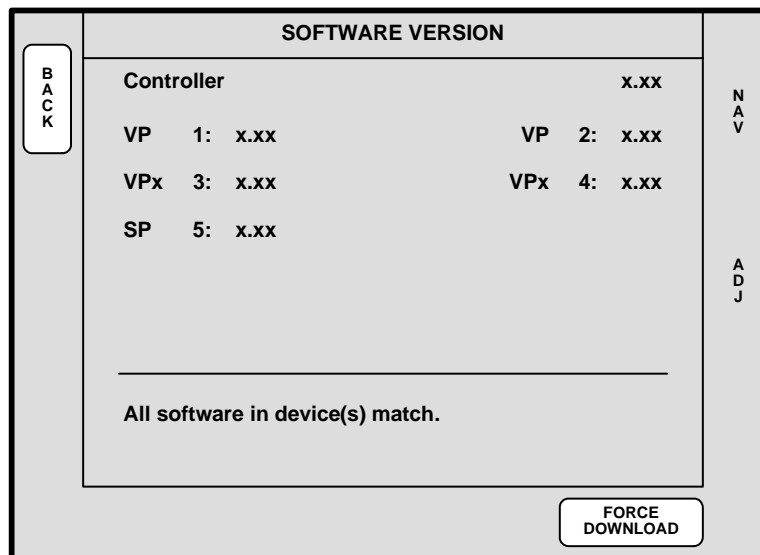


Figure 5-25. Software Version Menu (sample)

The **Software Version Menu** displays the software versions for all connected Video Processors and ScreenPRO-IIs. The following functions are provided:

- **Controller** — displays the Controller's software version.
- **VP** and **VPx** — these lines display each VP and VPx's software version. One line is shown for each active destination.
- **SP** — these lines display each ScreenPRO-II's software version. One line is shown for each active destination.
- In the lower portion of the menu, the system actively compares all software versions to that of the Controller:
  - ~ If all software versions match the Controller's version, the display indicates "**All Software in device(s) match**"
  - ~ If a mismatch is present, the display indicates "**Software version mismatch!**," and the {**DOWNLOAD CODE**} label appears.
- Press {**DOWNLOAD CODE**} to begin the software download process, downloading code from the Controller to only those "mismatched" units. The entire process takes several minutes to complete.
- Press {**FORCE DOWNLOAD**} to download code to *all* connected devices, typically for troubleshooting purposes, or to simply guarantee identical code in your entire system. This process also takes several minutes to complete.

#### Note

**PG UP** and **PG DN** softkeys will appear when the device list gets too long to display on one page.



## Diagnostics Setup Menu

From the **System Menu**, press {DIAG} to display the **Diagnostics Setup Menu**.

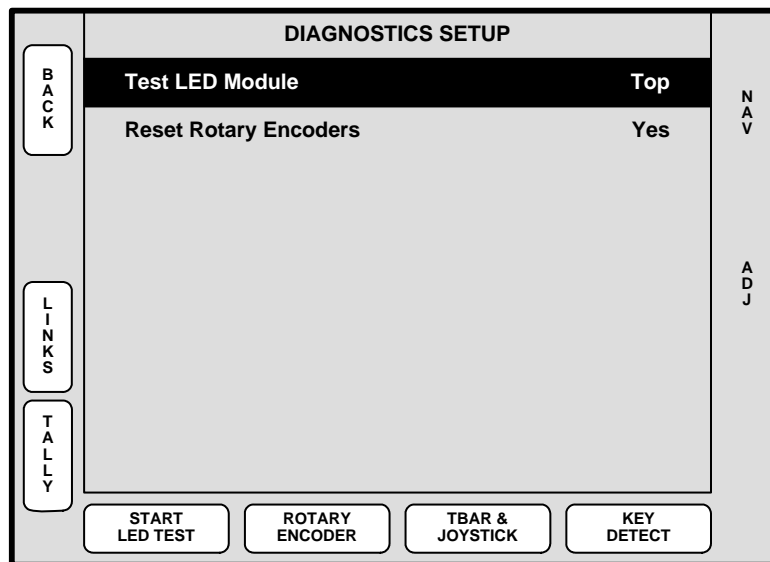


Figure 5-26. Diagnostics Setup Menu (sample)

The **Diagnostics Setup Menu** enables you to perform a variety of diagnostic tests on the Controller. The following functions are provided:

- **Test LED Module** — selects the region of the Controller that you wish to test.
  - ~ Controller SC: select **All**, **Bottom** or **Top**.
  - ~ Controller LC: select **Left**, **Right**, **Middle** or **Top**.
- **Reset Rotary Encoders** — (Yes/No) determines whether or not you wish to reset the rotary encoder values when you exit the **Rotary Encoder Menu**.
- Press {LINKS} to display the **Widescreen Link Diagnostics Menu**. Refer to the "[Widescreen Link Diagnostics Menu](#)" section on page 178 for details.
- Press {TALLY} to display the **Tally Diagnostic Menu**, and *immediately* start a test of all eight tally relays. This procedure takes several seconds to complete. Press {EXIT} when complete.
- Press {START LED TEST} to begin testing the selected LED module. This procedure takes several seconds to complete. Press {EXIT} when complete.
- Press {ROTARY ENCODER} to display the **Rotary Encoder Menu**. Refer to the "[Rotary Encoder Menu](#)" section on page 179 for details.
- Press {TBAR & JOYSTICK} to display the **TBar & Joystick Menu**. Refer to the "[TBar & Joystick Menu](#)" section on page 180 for details.
- Press {KEY DETECT} to display the **Key Detect Menu**. Refer to the "[Key Detect Menu](#)" section on page 181 for details.

## 5. Menu Orientation

### System Menu

#### Widescreen Link Diagnostics Menu

From the **Diagnostics Setup Menu**, press {LINKS} to display the **Widescreen Link Diagnostics Menu**.

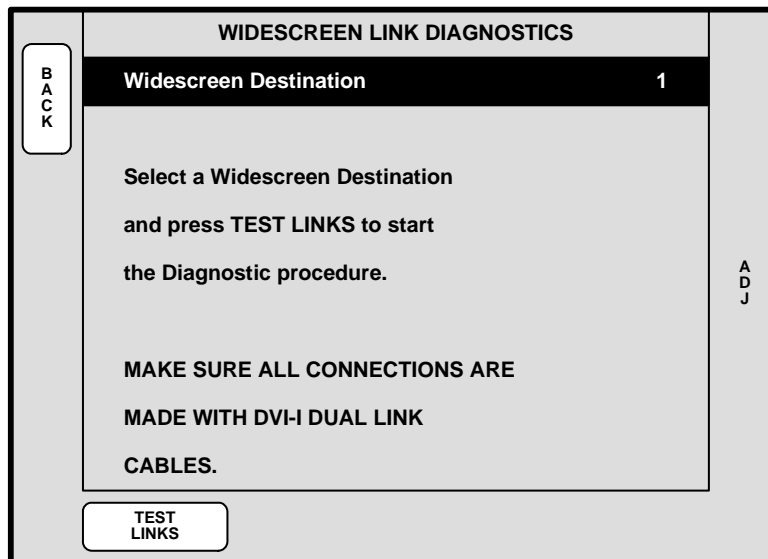


Figure 5-27. Widescreen Link Diagnostics Menu (sample)

The **Widescreen Link Diagnostics Menu** enables you to test the program and source link cables that are required for wide screen operation. This menu only appears when a defined wide screen destination is active.

- Press {**TEST LINKS**} to perform the link diagnostics. You will be asked to confirm your selection.

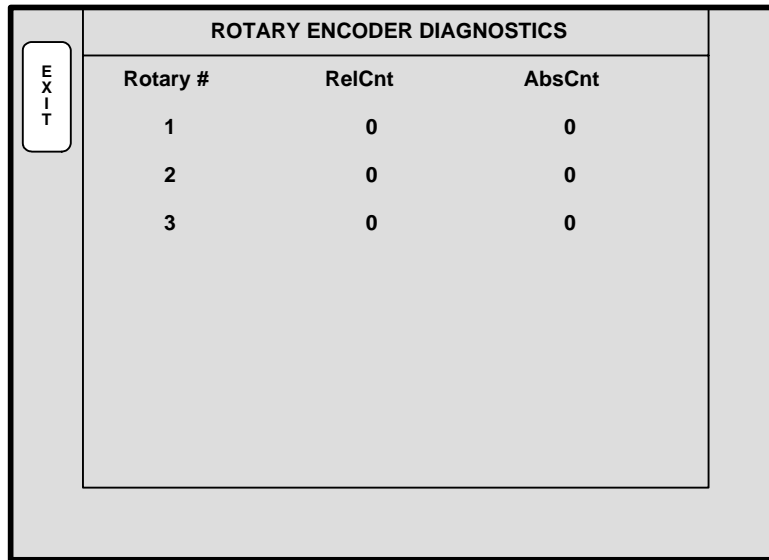
#### **Note**

This test affects the Program output.

When the test is complete, Preview and Program outputs are fully restored and the test results are displayed on the menu. If any cables fail, the complete connection list will be shown in the display for reference when troubleshooting the cable connections.

### Rotary Encoder Menu

From the **Diagnostics Setup Menu**, press {**ROTARY ENCODER**} to display the **Rotary Encoder Menu**.



ROTARY ENCODER DIAGNOSTICS		
Rotary #	RelCnt	AbsCnt
1	0	0
2	0	0
3	0	0

The screenshot shows a menu titled "ROTARY ENCODER DIAGNOSTICS" with a table of data. To the left of the table is a vertical button labeled "EXIT".

**Figure 5-28.** Rotary Encoder Menu (sample)

The **Rotary Encoder Menu** enables you to test the functionality of each rotary encoder, displaying both relative and absolute counts for each.

- Press {**EXIT**} to return to the **Diagnostics Setup Menu**.

## 5. Menu Orientation

### System Menu

#### TBar & Joystick Menu

From the **Diagnostics Setup Menu**, press {**TBAR & JOYSTICK**} to display the **TBar & Joystick Diagnostics Menu**.

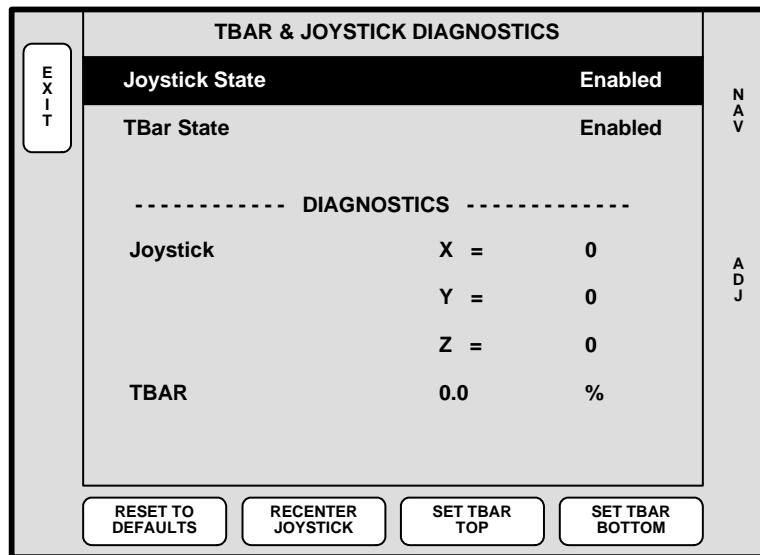


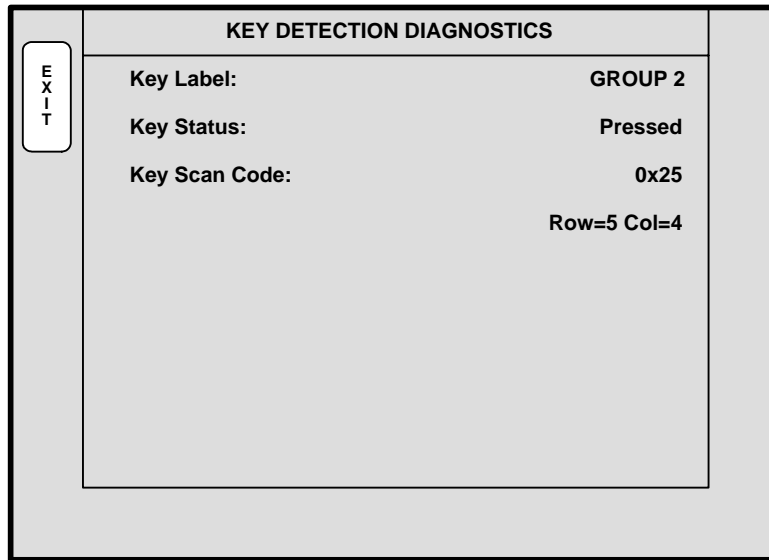
Figure 5-29. TBar & Joystick Diagnostics Menu (sample)

The **TBar & Joystick Diagnostics Menu** enables you to test the functionality of the TBar and Joystick. The T-Bar's range is 0 to 100%. The Joystick's range is -100 to 100 on each axis. The following functions are provided:

- **Joystick State — Enabled** is the default state. Select **Disabled** if you encounter an error with the Joystick, and wish to continue operating with the Joystick off. In this mode, the **Rotary Knobs** or direct numeric entry can be used to change PIP or KEY position.
- **TBar State — Enabled** is the default state. Select **Disabled** if you encounter an error with the T-Bar, and wish to continue operating with the T-Bar off. In this mode, use the **AUTO TRANS** button.
- Press {**RESET TO DEFAULTS**} to reset both the T-Bar and Joystick to their default values.
- Press {**RECENTER JOYSTICK**} to re-center the Joystick to a true zero value on all three axes. Use this function if you notice a PIP or KEY moving on its own, with the Joystick resting at center.
- Press {**SET TBAR TOP**} to set a true top limit that matches electronic and physical T-Bar positions. When the **Set TBar Top Menu** appears, follow the instructions to set the top limit.
- Press {**SET TBAR BOTTOM**} to set a true bottom limit that matches electronic and physical T-Bar positions. When the **Set TBar Bottom Menu** appears, follow the instructions to set the bottom limit.
- Press {**EXIT**} to return to the **Diagnostics Setup Menu**.

### Key Detect Menu

From the **Diagnostics Setup Menu**, press {**KEY DETECT**} to display the **Key Detect Menu**.



**Figure 5-30.** Key Detect Menu (sample)

The **Key Detect Menu** shows you the key that is pressed, its status (pressed or released) its scan code and its location in the row and column matrix.

- Press {**EXIT**} to return to the **Diagnostics Setup Menu**.

## 5. Menu Orientation

### System Menu

#### Destination Setup Menu

From the **System Menu**, press {**DEST SETUP**} to display the **Destination Setup Menu**.

The screenshot shows a menu titled "DESTINATION SETUP". On the left is a vertical "BACK" button. On the right is a vertical "NAV" button. The main content area shows "Destination - 3 ME(s)" with the value "1". Below this are fields for "Type" (Widescreen VP), "VP to Add" ([ N/A ]), "VP to Remove" (1), and "Dimensions" (4W x 1H). Below these fields is a section titled "VPs assigned to Destination 1:" with the value "1, 2, 3, 4". At the bottom are three buttons: "REMOVE ALL", "REMOVE", and "ADD".

DESTINATION SETUP	
Destination - 3 ME(s)	1
Type	Widescreen VP
VP to Add	[ N/A ]
VP to Remove	1
Dimensions	4W x 1H
VPs assigned to Destination 1: 1, 2, 3, 4	
REMOVE ALL REMOVE ADD	

Figure 5-31. Destination Setup Menu (sample)

The **Destination Setup Menu** enables you to define each destination. The following functions are provided:

- **Destination** — sets the destination that you want to define. The field corresponds to the numbered buttons on the **Destination Bus**, rather than the currently selected destination.

Once VPs and VPx units have been assigned for widescreen usage, the system displays (on the top "**Destination**" line) how many M/Es are installed.

#### Important

Encore can create wide screen configurations with VP and VPx units that *do not* have the same number of M/Es — in which case, the system operates at the lowest common denominator. For example, in a system consisting of a single-M/E VP and a three-M/E VP, Encore creates a single-M/E widescreen configuration.

- **Type** — sets the selected destination type. Choices include:
  - ~ Single Screen VP (VPx)
  - ~ Wide Screen VP (VPx)
  - ~ Single Screen VP Stack
  - ~ Wide Screen VP (VPx) Stack
  - ~ Single Screen SP
  - ~ Aux
  - ~ ImagePRO Aux
  - ~ PrePRO-II Aux

### Note

When an **Aux**, **ImagePRO Aux** or **PrePRO-II Aux** destination is selected, the **{AUX SETUP}** button appears, which enables you to set the parameters of the Aux destination. Refer to the [“Aux Setup Menu”](#) section on page 184 for details.

- **VP (SP) to Add** — lists all available VP, VPx or ScreenPRO-II's that can be assigned to the destination. If a Processor is currently assigned to another destination, it will not appear in the list. **Processors are identified by ID.**

### Note

The following rules apply to VPx:

- A VP must be used as the “master” processor. Thereafter, either a VP or a VPx can be used.
- A VPx can only be used in a single processor configuration in the widescreen “preview” mode.

- **VP (SP) to Remove** — lists all assigned VP, VPx or ScreenPRO-II's that can be removed from the destination. **Processors are identified by ID.**
- **Dimensions** — When two or more VP or VPx units are added to a destination, the Dimensions field appears. This field enables you to select any combination of the available VP or VPx units, and lay them out in a horizontal only, vertical only, or horizontal plus vertical array. The selected dimension is expressed in a **W** (width) x **H** (height) formula, e.g., 2W x 2H.

### Note

If the widescreen destination includes any vertical blending element, it affects the **Wide Screen Settings Menu**. Refer to the [“Wide Screen Settings Menu”](#) on page 167 for details

- **Analog Routing Mode** — if **Single Screen SP** is selected as the “Type,” this field enables you to set the routing mode for ScreenPRO-II's analog inputs.
  - ~ Select **Internal** to use ScreenPRO-II's internal 8x2 matrix to select analog sources. Use the [“Input Source Patch Menu”](#) to patch inputs.
  - ~ Select **External** to use an external analog router that is connected to ScreenPRO-II to select your analog sources. Use the [“Output Patch Menu”](#) to patch your inputs.
- **SDI Routing Mode** — if **Single Screen SP** is selected as the “Type,” this field enables you to set the routing mode for ScreenPRO-II's SDI inputs.
  - ~ Select **Internal** to use ScreenPRO-II's internal 2x2 matrix to select SDI sources. Use the [“Input Source Patch Menu”](#) to patch inputs.
  - ~ Select **External** to use an external SDI router that is connected to ScreenPRO-II to select SDI sources. Use the [“Output Patch Menu”](#) to patch your inputs.
- At the bottom of the menu, the **Status** section dynamically lists the Processor IDs assigned to the current destination.
- Press **{ADD}** to add the selected VP, VPx or ScreenPRO-II (on the **VP [SP] to Add** line) to the current destination configuration.

## 5. Menu Orientation

### System Menu

- Press {**REMOVE**} to remove the selected VP, VPx or ScreenPRO-II (on the **VP [SP] to Remove** line) from the current destination configuration.
- Press {**REMOVE ALL**} to remove all units from the current destination.

#### Note

If you have defined a destination as a **Wide Screen**, preliminary wide screen setup information will be sent to the VP and VPx units when you exit this menu.

#### Aux Setup Menu

From the **Destination Setup Menu**, select an Aux destination type, then press {**AUX SETUP**} to display the **Aux Setup Menu**. Please note:

- The {**AUX SETUP**} button appears when an **Aux**, **ImagePRO Aux** or **PrePRO-II Aux** destination is selected on the **Destination Setup Menu**.
- The **Aux Setup Menu** *changes*, depending upon the selected type of destination.
- In Chapter 1, refer to the “[A Word About Destinations](#)” section on page 27 for examples of each Aux destination “type.”

When a standard **Aux** destination “type” is selected on the **Destination Setup Menu**, the **Aux Setup Menu** appears in this form:

AUX SETUP		DEST_2
<b>Source Mapping</b>	<b>Direct Map</b>	
Router Name	MATRIXPRO1	
Router Output	7	

BACK

NAV

ADJ

RESET

Figure 5-32. Aux Setup Menu — Aux Destination (sample)

The following functions are provided:

- **Top Line** — displays the type of Aux destination and its number.
- **Source Mapping** — two selections are available:
  - ~ **Input Patch** — maps Aux sources according to how your inputs are patched to buttons in the console’s **Source Selection** section.
  - ~ **Direct Map** — maps Aux sources according to how your inputs are connected to the router.
- **Router Name** — selects the router from which the Aux sources will be output.



## 5. Menu Orientation

### System Menu

- **Router Output** — selects the specific router output designated as an Aux (as assigned on the router's **Output Patch Menu**).
- Press **{RESET}** to return all fields to **<UNDEFINED>**.

When an **ImagePRO Aux** or **PrePRO-II Aux** destination “type” is selected on the **Destination Setup Menu**, the **Aux Setup Menu** appears in this form:

AUX SETUP		DEST_2
<b>Source Mapping</b>		<b>Input Patch</b>
ImagePRO ID:		17
-----		
ANALOG Router Name		MATRIXPRO1
ANALOG Router Output		7
ImagePRO Input:		1
-----		
SDI Router Name		MATRIXPRO2
SDI Router Output		8

BACK NAV  
ADJ  
RESET

Figure 5-33. Aux Setup Menu — ImagePRO Aux Destination (sample)

The following functions are provided:

- **Top Line** — displays the type of Aux destination and its selected number.
- **Source Mapping** — two selections are available:
  - ~ **Input Patch** — maps Aux sources according to how your inputs are patched to buttons in the console's **Source Selection** section.
  - ~ **Direct Map** — maps Aux sources according to how your inputs are connected to the router.
- **ImagePRO ID (or PrePRO-II ID)** — selects the ID of the ImagePRO or PrePRO-II, to which you want to route Aux sources.
- **Analog Router Name** — selects the router from which analog sources will be routed to the ImagePRO or PrePRO-II.
- **Analog Router Output** — selects the specific router output designated as Aux (as assigned on the router's **Output Patch Menu**).
- **ImagePRO Input (or PrePRO-II input)** — selects the ImagePRO or PrePRO-II input to which the router output is connected.
- **SDI Router Name** — selects the router from which SDI sources will be routed to the ImagePRO or PrePRO-II.
- **SDI Router Output** — selects the specific router output designated as Aux (as assigned on the router's **Output Patch Menu**).
- **ImagePRO Input (or PrePRO-II input)** — selects the ImagePRO or PrePRO-II input to which the router output is connected.
- **DVI Router Name** — selects the router from which DVI sources will be routed to the ImagePRO. (Not applicable to PrePRO-II Aux destinations.)

## 5. Menu Orientation

### System Menu

- **DVI Router Output** — selects the Aux router output (as assigned on the router's **Output Patch Menu**). (Not applicable to PrePRO-II Aux destinations.)
- **ImagePRO Input** — selects the ImagePRO input to which the router output is connected. (Not applicable to PrePRO-II Aux destinations.)
- Press **{RESET}** to return all fields to **<UNDEFINED>**.

Please note the following important points regarding Aux destinations:

- For proper operation, ImagePRO and PrePRO-II devices must be connected to Encore via Ethernet.

#### Note

Once the connection is made and verified in the **Status Menu**, the next step is to define the router outputs that will be used with the Aux unit. Once that step is done, use the **Destination Setup Menu** to define the Aux Destination itself. In Chapter 6, full setup details are provided in the "[AUX Destination Setup](#)" section on page 281.

- ImagePRO and PrePRO-II output setups must be performed locally on the units.
- Only one router of each type (Analog, DVI, SDI) can be connected to ImagePRO.
- Only one Analog and one SDI router can be connected to a PrePRO-II unit.
- Automatic "copy down" takes place once the Aux Destination is defined and set up, and once ImagePRO and PresentationPRO-II inputs have been configured.

## Network Setup Menu

From the **System Menu**, press {**NETWORK SETUP**} to display the **Network Setup Menu**.

NETWORK SETUP	
<b>Network DHCP</b> [ Server ]	
Ctrlr IP	: [ 192.168.000.01 ]
Port	: [ 3000 ]
IP Range from	[ 192.168.0.11 ]
to	[ 192.168.0.191 ]

Navigation buttons: BACK (left), NAV (right), ADJ (right)

**Figure 5-34.** Network Setup Menu (sample)

For reference only, the **Network Setup Menu** displays the available IP range for the Encore system. The following information is provided:

- **Network DHCP** — this non-selectable field confirms that the Controller is a DHCP server, by showing the [SERVER] label.
- **Ctrlr IP** — this non-selectable field shows the Controller's IP address.
- **Port** — this non-selectable field shows the Controller's port.
- **IP Range from / to** — these non-selectable fields show the system's available IP range that the server can provide.

## 5. Menu Orientation

### System Menu

#### Input Source Patch Menu

From the **System Menu**, press {INPUT PATCH} to display the **Input Source Patch Menu**.

The screenshot shows the 'INPUT SOURCE PATCH' menu. On the left is a 'BACK' button. On the right is a vertical 'NAV' knob. The main area contains the following fields:

Source Number	1
Connection Type	MATRIXPRO1
Router Input	1
Tally Number	1

Below the fields is the instruction: 'Press "ADD PATCH" to log change'. At the bottom are two buttons: 'ADD PATCH' and 'DELETE PATCH'.

Figure 5-35. Input Source Patch Menu (sample)

The **Input Source Patch Menu** enables you to patch router inputs to specific source buttons on the Controller. The menu also enables you to assign tallies, and select "direct" connections to the Processors (such as those from computers).

#### Important

The fields that appear on the **Input Source Patch Menu** change depending upon the selected **Connection Type**.

The following functions are provided:

- **Source Number** — selects the source button on the Controller that you want to patch. The selection ranges are **1 - 24** (Controller SC) and **1 - 64** (Controller LC). The source is chosen with the **ADJ** knob — *not* with the source buttons.
- **Connection Type** — determines how the selected source is connected to the Processor — either via router, direct connection, or ScreenPRO-II:
  - ~ **Via router** — choose between **MATRIXPRO1**, **MATRIXPRO2**, or a third party router (e.g., **SIERRA1**, **LEITCH1**, etc.) as selected on the **Router Specification Menu**.
  - ~ **Via ScreenPRO-II with internal routing** — choose a ScreenPRO-II by its ID (e.g., **SP6**).
  - ~ **Via ScreenPRO-II with external routing** — choose **ALL SP**. This enables all connected ScreenPRO-IIs to switch simultaneously to the same input.
  - ~ **Via direct connection** — choose between **DIRECT ANALOG**, **DIRECT DVI** and **DIRECT SDI**.

## 5. Menu Orientation

### System Menu

- **Router Input** — **Applies to Router connections** — selects the router input that you wish to associate with the source. The range depends on the number of inputs defined in the **Router Specification Menu**.

#### Note

The same router input can be chosen for different source numbers.

- **ID** — **Applies to direct connections** — this option selects the ID of the selected Encore or ScreenPRO-II Processor.

#### Note

If asterisks appear around an ID (e.g., \* 6 \*), the ID has not been detected by the system.

- **SP Input** — **Applies to direct ScreenPRO-II connections** — this option selects a specific input connector on the ScreenPRO-II.
- **VP Input** — **Applies to direct Video Processor connections** — this option selects a specific M/E input connector on the Video Processor.
- **Mixer Layer** — **Applies to direct connections** — this “information only” field displays the mixer layer that corresponds to the specific M/E input connector.
- **SP Input is mapped to** — **Applies to direct ScreenPRO-II connections** — this “information only” field shows the current ScreenPRO-II input mapping, if present.
- **VP Input is mapped to** — **Applies to direct Video Processor connections** — this “information only” field shows the current Processor input mapping, if present.
- **Tally Number** — **Applies to all connections** — this option enables you to assign any of the eight available tallies to any input source. There are no restrictions on tally usage. For example, inputs **8** and **23** could both map to tally **4** if desired.
- Press **{ADD PATCH}** to confirm any change that you make. As you dial through the choices, the status at the bottom of the menu shows if the current choice is already in use.
- Press **{DELETE PATCH}** to delete all input patch registers for the selected Controller input. When pressed:
  - ~ The **Connection Type** setting changes to “**UNDEFINED**”
  - ~ The **Router Input** line is cleared.

This procedure is a good starting point if you are uncertain about specific patches.

In Chapter 6, refer to the “[Output Format Setup](#)” section on page 285 for important information about the system’s default Input Patch Table.

## 5. Menu Orientation

### System Menu

#### Router Specification Menu

From the **System Menu**, press {**ROUTER SETUP**} to display the **Router Specification Menu**.

ROUTER SPECIFICATION	
<b>Number</b>	1
<b>Name</b>	[ MATRIXPRO1 ]
<b>Manufacturer</b>	FOLSOM
<b>Router Type</b>	ANALOG
<b>Number of Inputs</b>	16
<b>Number of Outputs</b>	8
<b>Communication Type</b>	ETHERNET

BACK

NAV

ADD

COMM SETUP    DELETE ROUTER    ADD NEW    OUTPUT PATCH

Figure 5-36. Router Specification Menu (sample)

The **Router Specification Menu** enables you to define input, output and communication parameters for all connected routers and D/As.

#### Note

A D/A is an abbreviation for “**Distribution Amplifier**,” a device which has one input and multiple outputs.

The following functions are provided:

- **Number** — sets an arbitrary configuration number for a selected router. The system supports up to eight router definitions. Each default router specification has an associated **OUTPUT PATCH** definition.
- **Name** — this non-selectable field shows the router’s assigned name. After a factory reset, router number 1 defaults to [MATRIXPRO1] and router number 2 defaults to [MATRIXPRO SDI].

#### Note

When a router number is undefined, [ROUTER #] appears, and in the **Number** field, “EMPTY” appears.

- **Manufacturer** — identifies the router manufacturer. Choose between **FOLSOM**, **EXTRON**, **SIERRA**, **LEITCH**, **ISIS**, **DVILINK**, **DPI**, **FSR**, **AUTOPATCH**, **NVISION RTR**, and **NVISION 9000**. In Appendix E, refer to the “[Router Interface Notes](#)” section on page 409 for additional details.
- **Router Type** — identifies the type of router being used. The choices are **ANALOG**, **DVI**, **SDI**, **D/A ANALOG**, **D/A DVI** and **D/A SDI**.
  - ~ {**COMM SETUP**} must be set for Analog, DVI and SDI routers.

## 5. Menu Orientation

### System Menu

~ D/As must be set up like routers. This enables you to define which D/A outputs are patched to which specific Video Processor connectors.

- **Number of Inputs** — identifies the number of inputs on the selected router.
- **Number of Outputs** — identifies the number of outputs on the selected router.
- **Communication Type** — sets the router's communication type, either **RS-232**, **ETHERNET** or **LANTRONIX**.
- Press {**COMM SETUP**} to display one of three **Comm Setup Menus**, depending on the selected **Communication Type**. Refer to the "[Comm Setup Menus](#)" section on page 191 for details.
- Press {**DELETE ROUTER**} to change the selected router **Number** to undefined.
- Press {**ADD NEW**} after choosing an "**EMPTY**" router number to begin the definition process — in order to create a valid router specification.
- Press {**OUTPUT PATCH**} to display the **Output Patch Menu**. Refer to the "[Output Patch Menu](#)" section on page 194 for details.

### Comm Setup Menus

Information is provided for three different Comm Setup Menus:

- [Ethernet Setup Menu](#)
- [RS-232 Setup Menu](#)
- [Lantronix Setup Menu](#)

#### Ethernet Setup Menu

On the **Router Specification Menu**, when **Communication Type** is set to **ETHERNET**, press {**COMM SETUP**} to display the **Ethernet Setup Menu**:

ETHERNET SETUP	
IP Address	192.168.0.241
IP Port Number	23

Navigation: BACK (left), NAV (right), ADJ (right)

Buttons: TEST COMM, NEXT IP QUAD

Figure 5-37. Ethernet Setup Menu (sample)

The **Ethernet Setup Menu** enables you to set the router's IP address and port number.

- **IP Address** — sets the router's IP address.
- **IP Port Number** — sets the router's IP port number, if applicable.

## 5. Menu Orientation

### System Menu

- Press {**NEXT IP QUAD**} to advance to the next 3-digit set of numbers in the address. Use the **ADJ** knob in the normal manner to change the digits.
- Press {**TEST COMM**} to test communications with the defined router:
  - ~ If the test is successful, a “**ROUTER CONNECTED**” message will appear that includes the Router name and version.
  - ~ If the test is unsuccessful, a “**ROUTER FAILED**” message will appear. In this condition, re-check all connections and settings, and repeat the test.

#### RS-232 Setup Menu

On the **Router Specification Menu**, when **Communication Type** is set to **RS-232**, press {**COMM SETUP**} to display the **RS-232 Setup Menu**:

RS232 SETUP	
<b>Baud Rate</b>	<b>115200</b>
<b>Data Bits</b>	<b>[ 8 ]</b>
<b>Parity</b>	<b>[ NONE ]</b>
<b>Stop Bits</b>	<b>[ 1 ]</b>

Navigation buttons: **B A C K** (left), **N A V** (right), **A D J** (right), **TEST COMM** (bottom center)

Figure 5-38. RS-232 Setup Menu (sample)

The **RS-232 Setup Menu** enables you to set the router's RS-232 baud rate only. All other parameters are fixed.

- **Baud Rate** — sets the desired baud rate (**9600, 14400, 19200, 28800, 38400, 57600, 115200**).
- **Data Bits** — fixed at **8**.
- **Parity** — fixed at **None**.
- **Stop Bits** — fixed at **1**.
- Press {**TEST COMM**} to test communications with the defined router:
  - ~ If the test is successful, a “**ROUTER CONNECTED**” message will appear that includes the Router name and version.
  - ~ If the test is unsuccessful, a “**ROUTER FAILED**” message will appear. In this condition, re-check all connections and settings, and repeat the test.



**Lantronix Setup Menu**

On the **Router Specification Menu**, when **Communication Type** is set to **LANTRONIX**, press {**COMM SETUP**} to display the **Lantronix Setup Menu**:

LANTRONIX SETUP	
<b>Number</b>	< EMPTY >
<b>Channel</b>	[ N/A ]
<b>Baud rate</b>	[ N/A ]
<b>Data bits</b>	[ N/A ]
<b>Stop bit</b>	[ N/A ]
<b>Parity</b>	[ N/A ]
IP: N/A	
MAC Addr: [ N/A ]	
DISCOVER LTRX	

Figure 5-39. Lantronix Setup Menu (sample)

The **Lantronix Setup Menu** enables you to set parameters for multiple Lantronix Ethernet-to-Serial device servers. Encore supports Lantronix models **UDS100**, **UDS200** and **UDS2100**. The menu appears blank until the Lantronix device is “discovered.”

**Important**

Prior to pressing {**DISCOVER LTRX**}, set up a static IP address on the Lantronix device itself. The recommended range is **192.168.0.191 - 192.168.0.240**. Refer to the **Lantronix User’s Guide** for details.

- **Number** — selects the number of the Lantronix device that you wish to set up.
- Press {**DISCOVER LTRX**} to set up communications with the Lantronix device.
- **Channel** — sets the specific Lantronix channel (**1** or **2**) that you wish to set up.
  - ~ The Lantronix **UDS 100** can control one serial router.
  - ~ The Lantronix **UDS 200** can control two serial routers.
  - ~ The Lantronix **UDS 2100** can control two serial routers.
- **Baud Rate** — sets the selected channel’s baud rate.
- **Data Bits** — sets the selected channel’s data bits.
- **Stop Bit** — sets the selected channel’s stop bit.
- **Parity** — sets the selected channel’s parity.
- **IP** — displays the IP address of the Lantronix. This parameter must be set at the device itself.
- **MAC Addr** — displays the hard-coded MAC address of the Lantronix.

## 5. Menu Orientation

### System Menu

#### Output Patch Menu

From the **Router Specification Menu**, press {**OUTPUT PATCH**} to display the **Output Patch Menu**.

OUTPUT PATCH		MATRIXPRO1
Router Output		1
Device ID		VP 1
VP Input		1A
Mixer Layer		[ 2A ]
VP Input is mapped to MATRIXPRO1 Output 1		
Set Device ID to NONE to define the Router Output as an AUX.		

ADD PATCH      DELETE PATCH

Figure 5-40. Output Patch Menu (sample)

After a router is selected on the **Router Specification Menu**, the **Output Patch Menu** enables you to associate router and D/A outputs with VP IDs and inputs. This process creates a unique “**Output Patch Table**” for each defined router.

The following functions are provided:

- **Router Output** — selects the specific router output that is being patched. The selectable range is 1 to the number of outputs defined in the **Router Specification Menu**.
- **Device ID** — selects the physical VP ID to which the router’s output will be connected. The selectable range is 1 - 32.

#### Note

If asterisks appear around the Device ID (e.g., \* 6 \*), the ID has not been detected by the system.

- **VP Input** — selects the physical VP input to which the router’s output is being patched. Selections are 1A, 1B, 2A, 2B, 3A, and 3B.
- **Mixer Layer** — this non-selectable field shows the Mixer Layer button (on the Controller) that is associated with the selected VP input.
- Press {**ADD PATCH**} to confirm any change that you make on menu. As you dial through patch choices, the status at the bottom of the menu shows if the current choice is already in use.
- Press {**DELETE PATCH**} to delete all “Output Patch Table” registers for the selected router output. The “Delete Patch” procedure is a good starting point if you are uncertain about specific output patch settings.
- When a router’s physical output connections to the VPs have been performed in a logical order, press {**PATCH NEXT**} to facilitate quick data entry.

To use this feature, perform the following steps:

- a. Dial in the first output number from which you want to start.
- b. Define the VP/SP ID and the VP/SP input to which you want to connect this output.
- c. Press **{ADD PATCH}**. From this point, pressing **{PATCH NEXT}** will automatically perform the following actions:
  - Increment to the next Output Number.
  - Increment the VP/SP Input Layer or the VP/SP ID, if the last VP/SP Input Layer has been defined.
  - Add the patch.

▲ For example, if you start out with the following:

- ~ Router Output: 12
- ~ VP ID: 1
- ~ VP Layer: 3A

Pressing **{PATCH NEXT}** will automatically add the following data:

- ~ Router Output: 13
- ~ VP ID:1
- ~ VP Layer:3B

Pressing **{PATCH NEXT}** again will automatically add the following patch data:

- ~ Router Output: 14
- ~ VP ID:2
- ~ VP Layer:1A

In Chapter 6, refer to the "[Router Setup](#)" section on page 270 for important information about the system's default Output Patch Table.

## 5. Menu Orientation

### Miscellaneous Menu

## Miscellaneous Menu

The following topics are discussed in this section:

- [Miscellaneous Menu Tree](#)
- [Miscellaneous Menu Description](#)
- [Miscellaneous Sub Menus](#)

## Miscellaneous Menu Tree

The figure below illustrates the **Miscellaneous Menu Tree**:

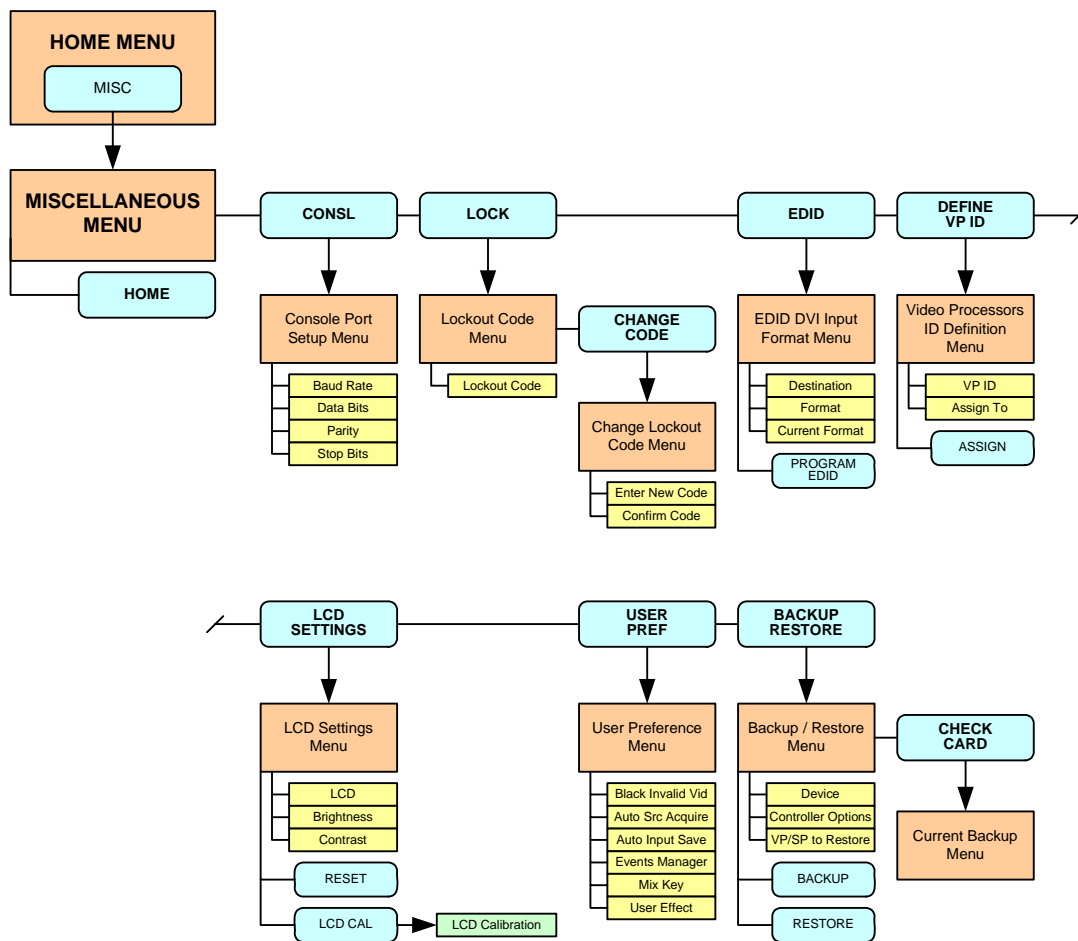


Figure 5-41. Miscellaneous Menu Tree

All functions and sub menus are discussed in the following sections.

## Miscellaneous Menu Description

The **Miscellaneous Menu** enables you to access Encore functions that do not fall into other distinct menu categories.

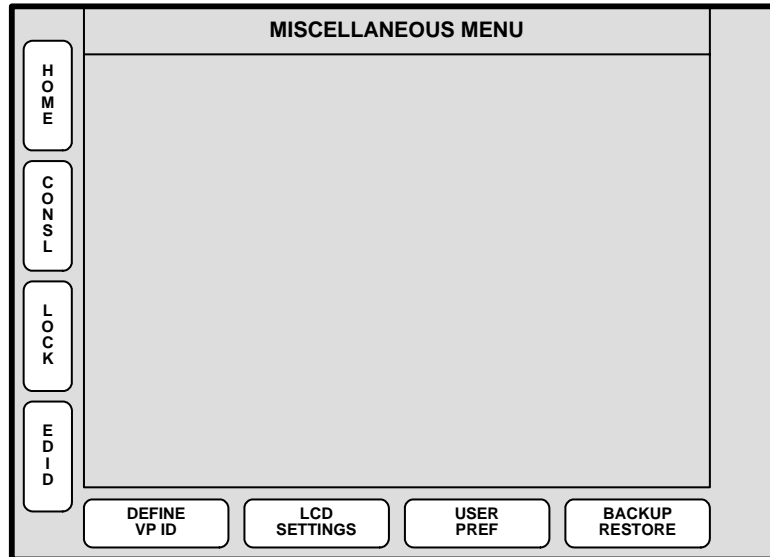


Figure 5-42. Miscellaneous Menu

To access the menu:

- Press **MISC** on the **Home Menu**, or press **Misc** in the **Keypad Section**.

The following “miscellaneous” functions are provided:

- Press {**CONSL**} to access the **Console Port Setup Menu**. Refer to the “[Console Port Setup Menu](#)” section on page 198 for details.
- Press {**LOCK**} to access the **Lockout Code Menu**. Refer to the “[Lockout Code Menu](#)” section on page 199 for details.
- Press {**EDID**} to access the **EDID DVI Input Format Menu**. Refer to the “[EDID DVI Input Format Menu](#)” section on page 200 for details.
- Press {**DEFINE VP ID**} to access the **Video Processors ID Definition Menu**. Refer to the “[Video Processors ID Definition Menu](#)” section on page 202.
- Press {**LCD SETTINGS**} to access the **LCD Settings Menu**. Refer to the “[LCD Settings Menu](#)” section on page 203 for details.
- Press {**USER PREF**} to access the **User Preference Menu**. Refer to the “[User Preference Menu](#)” section on page 204 for details.
- Press {**BACKUP RESTORE**} to access the **Backup/Restore Menu**. Refer to the “[Backup/Restore Menu](#)” section on page 206 for details.

## 5. Menu Orientation

### Miscellaneous Menu

## Miscellaneous Sub Menus

The following sub menus can be accessed from the **Miscellaneous Menu**:

- [Console Port Setup Menu](#)
- [Lockout Code Menu](#)
- [EDID DVI Input Format Menu](#)
- [Video Processors ID Definition Menu](#)
- [LCD Settings Menu](#)
- [User Preference Menu](#)
- [Backup/Restore Menu](#)

## Console Port Setup Menu

From the **Miscellaneous Menu**, press {CONSL} to display the **Console Port Setup Menu**:

CONSOLE PORT SETUP	
<b>Baud Rate</b>	<b>115200</b>
Data Bits	8
Parity	NONE
Stop Bits	1

Navigation: BACK (left), NAV (right), ADJ (bottom right)

**Figure 5-43.** Console Port Setup Menu (sample)

This menu enables you to verify (or change) Encore's serial port communication settings for the **Ext Comm** port. The following functions are provided:

- **Baud Rate** — sets the port's baud rate. Range: **2400** to **115200**.
- **Data Bits** — sets the port's data bits. Range: **5** to **8**.
- **Parity** — sets the port's parity: **Even**, **Odd** or **None**.
- **Stop Bits** — sets the port's stop bits: **1**, **1.5** or **2**.

### Lockout Code Menu

From the **Miscellaneous Menu**, press **{LOCK}** to display the **Lockout Code Menu**:

LOCKOUT CODE	
Lockout Code	Default

HOME

BACK

ADJ

CHANGE CODE

Figure 5-44. Lockout Code Menu (sample)

The **Lockout Code Menu** enables you to define a programmable lockout code, so that the console can be locked out from unauthorized users. The following functions are provided:

- The **Lockout Code** field defines which code is currently enabled.
  - ~ Select **Default** to enable the system's default lockout code: **1111**
  - ~ Select **Custom** to enable a custom lockout code, as entered on the **Change Lockout Code Menu**.
- Press **{CHANGE CODE}** to display the **Change Lockout Code Menu**.

CHANGE LOCKOUT CODE

Enter new code:      \_ \_ \_ \_  
                                 ^

Confirm new code:      \_ \_ \_ \_

Enter and confirm new code  
using preset keys 1 - 8.

CANCEL

Figure 5-45. Change Lockout Code Menu (sample)

## 5. Menu Orientation

### Miscellaneous Menu

To enter a new code (for both Controllers), use the first eight numbered buttons on the **Preset Bus**, and then confirm the new code.

In Chapter 7, refer to the “[Enable/Disable Controller Lockout](#)” section on page 352 for instructions on using the Controller Panel Lockout mode.

### EDID DVI Input Format Menu

From the **Miscellaneous Menu**, press {EDID} to display the **EDID DVI Input Format Menu**:

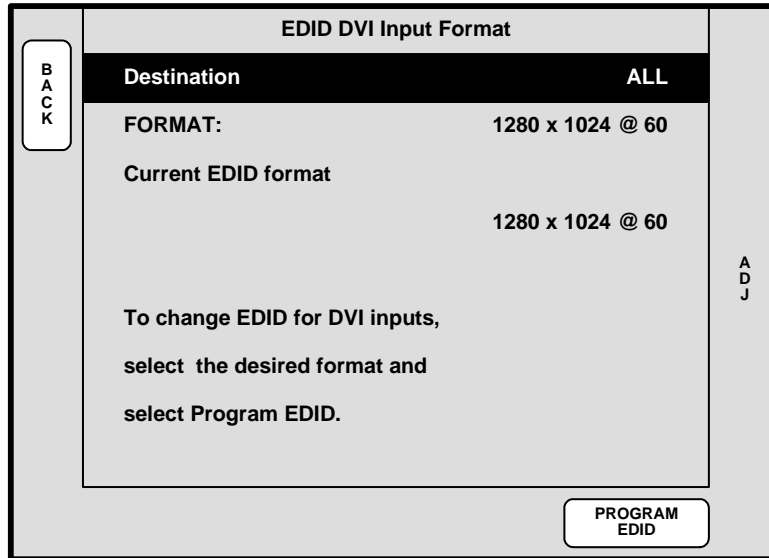


Figure 5-46. EDID DVI Input Format Menu (sample)

The **EDID DVI Input Format Menu** enables you to update the system’s preferred EDID resolution for the DVI inputs — for the selected destination bus.

#### Note

This menu is designed for advanced users only. Do not program EDID unless it is necessary.

Extended Display Identification Data (EDID) is a VESA standard data format that contains information about a display device and its resolution, both preferred and allowed. The system’s EDID file is stored in non-volatile memory. This file is read by an external computer’s DVI graphic card when the computer’s DVI output is connected to Encore via the DVI-I connector during boot-up. The Encore Video Processor must be powered on first for the EDID information to be read.

The following functions are provided:

- **Destination** — sets the destination on which you want to program EDID.
- **Format** — selects the preferred DVI video format with which you want to program the Encore Presentation System’s EDID non-volatile memory
- **Current** — displays the current EDID video format that resides in memory.
- Press {**PROGRAM EDID**} to program EDID with the new selected format. A warning message will be shown.



## 5. Menu Orientation

### Miscellaneous Menu

Please note the following important points regarding EDID:

- For the external computer to correctly see the EDID data, first turn on Encore power. Then connect the DVI cable from the computer's video card to one of Encore's mixer layers. Then, boot the computer.
- Once EDID programming is complete, you will be prompted to power down the external computer, power it back on again, and then ensure that the computer's format is set to match.
- The system's EDID PROM is *not* reset to any default during a factory reset. To change the EDID, you must use the **EDID DVI Input Format Menu**.

## 5. Menu Orientation

### Miscellaneous Menu

#### Video Processors ID Definition Menu

From the **Miscellaneous Menu**, press {**DEFINE VP ID**} to display the **Video Processors ID Definition Menu**:

The screenshot shows a menu interface with a title bar 'Video Processors ID Definition'. Below the title bar, there are two main fields: 'VP ID' with the value '3' and 'Assign To' with the value '[ 19 ]'. On the left side, there is a vertical button labeled 'BACK'. On the right side, there are vertical labels 'NAV' and 'ADJ'. At the bottom center, there is a button labeled 'ASSIGN'.

**Figure 5-47.** Video Processors ID Definition Menu (sample)

The **Video Processors ID Definition Menu** enables you to redefine Video Processor IDs using numbers 17 - 32. Please note:

- Only Processors that are *not* currently defined as destinations can be re-defined.
- The procedure adds 16 to the “physical” ID setting of the Processor, thus physical ID 1 becomes “extended” ID 17, etc.
- Physical digit 0 equates to logical ID 16.

ID mapping is fixed as follows:

**Table 5-1.** Video Processor ID Mapping

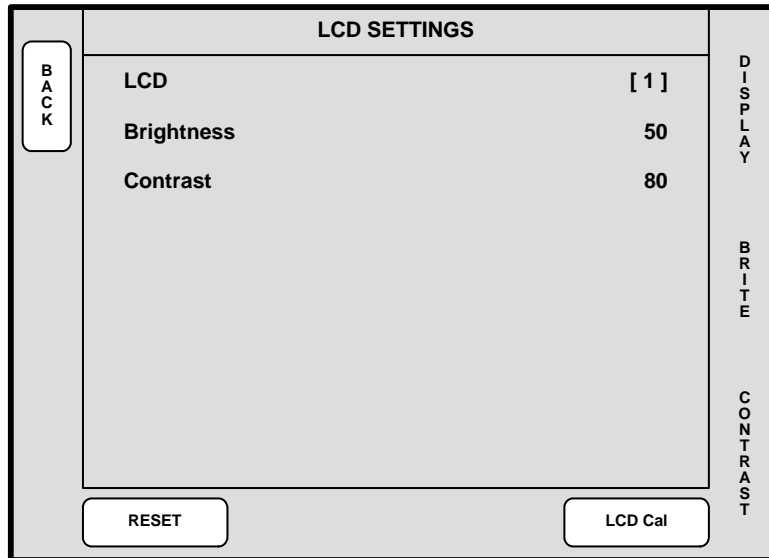
Physical ID	Extended ID
1	17
2	18
↓	↓
15	31
0	32

Please note:

- If all video processors are currently assigned to destinations, all fields read N/A, and the message “**All processors are assigned to destinations**” appears.
- Once IDs have been redefined, additional Processors can be added to the system. They will be recognized properly as IDs from the 1 - 16 range.

### LCD Settings Menu

From the **Miscellaneous Menu**, press {**LCD SETTINGS**} to show the **LCD Settings Menu**:



**Figure 5-48.** LCD Settings Menu (sample)

The **LCD Settings Menu** enables you to adjust the contrast and brightness settings for the LCD touch screen(s). The following functions are provided:

- Rotate the **DISPLAY** knob (Controller LC only) to select the touch screen display that you want to adjust.
- Rotate the **BRITE** knob to adjust brightness.
- Rotate the **CONTRAST** knob to adjust contrast.
- Press {**RESET**} to return settings to the factory default values.
- Press {**LCD CAL**} to calibrate the touch screen display to your finger, or to a stylus. Once pressed, you will be prompted to touch the center of a target three times. At the conclusion of the procedure, the display is calibrated and the system returns to the **Home Menu**.

## 5. Menu Orientation

### Miscellaneous Menu

#### User Preference Menu

From the **Miscellaneous Menu**, press {**USER PREF**} to display the **User Preference Menu**:

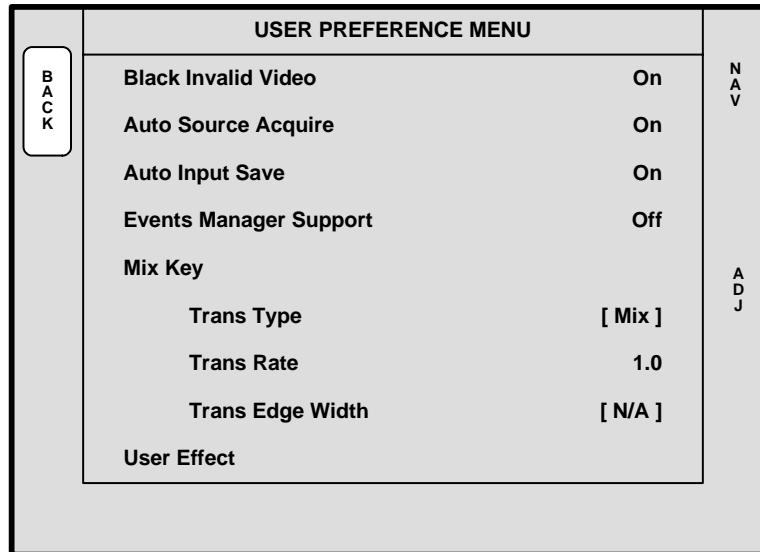


Figure 5-49. User Preference Menu (sample)

The **User Preference Menu** enables you to set a variety of user parameters. The following functions are provided:

- **Black Invalid Video** — selects the method by which the scaler’s “loading” procedure is shown on Preview, when you change inputs:
  - ~ **ON** — shows black when scalars are loaded. In addition, black is shown when a background channel (**BG**) becomes invalid, and the DSK will be turned off when source video becomes invalid.
  - ~ **OFF** — shows the full scaler loading procedure, which can temporarily include non-sync and non-stable video.
- **Auto Source Acquire** — selects whether or not the Controller automatically acquires an input, as soon as the source is selected on the bus — provided it does not currently have a saved input configuration file.
- **Auto Input Save** — selects whether or not the Controller automatically saves an input configuration file, as soon as the source has been successfully acquired. The **Auto Source Acquire** function must be enabled.
- **Events Manager Support** — This function assists with Preset recall performance, when large numbers of Presets are being used. In this condition, set the field to **OFF** (the default setting). If **Events Manager** support is required, enable the field before connecting the Controller to the **Events Manager** software.
- **Mix Key** — applies to the **Mix** button on both controllers. On the menu, the **Trans Rate** field below this heading allows you to select a custom transition rate with the **Mix** button. When **Mix** is pressed on the controller, the “custom” transition rate is applied, and the transition type (if currently different) is changed to a mix. Note that the **Trans Type** and **Trans Edge Width** fields are grayed out, because you can only perform a mix with the **Mix** button.
- **User Effect** — applies to the **User Effect** button on the small controller. On the menu, the three fields below this heading allow you to program a custom

## 5. Menu Orientation

### Miscellaneous Menu

transition. When **User Effect** is pressed on the controller, the “custom” transition properties are applied to the current transition.

- ~ **Trans Type** — enables you to select any available transition type, including a mix and all available wipes.
- ~ **Trans Rate** — enables you to select a custom transition rate.
- ~ **Trans Edge Width** — This field is only active if **Trans Type** is set to one of the wipes. Enables you to select an edge width, from **0** to **255**.
- **User Trans 1, 2, 3** — applies to the three **User Trans** buttons on the large controller. On the menu, one heading is provided for *each* physical **User Trans** button (**1**, **2** and **3**), and each as three fields that allow you to program a custom transition. When a **User Trans** button is pressed on the large controller, the “custom” properties are applied to the current transition. For each heading:
  - ~ **Trans Type** — enables you to select any available transition type, including a mix and all available wipes.
  - ~ **Trans Rate** — enables you to select a custom transition rate.
  - ~ **Trans Edge Width** — This field is only active if **Trans Type** is set to one of the wipes. Enables you to select an edge width, from **0** to **255**.

Please note:

- At any time, you can access the **Effects Menu** to modify the current transition settings. If you make a change on the **Effects Menu** and it does not match the custom settings on the **User Preference Menu**, the selected button (e.g., **Mix**, **User Trans 2**) turns off, and the new settings from the **Effects Menu** are applied to the current Encore transition.
- In Chapter 7, refer to the “[Setting User Preferences](#)” section on page 308 for additional instructions.

## 5. Menu Orientation

### Miscellaneous Menu

#### Backup/Restore Menu

From the **Miscellaneous Menu**, press {**BACKUP RESTORE**} to display the **Backup/Restore Menu**:

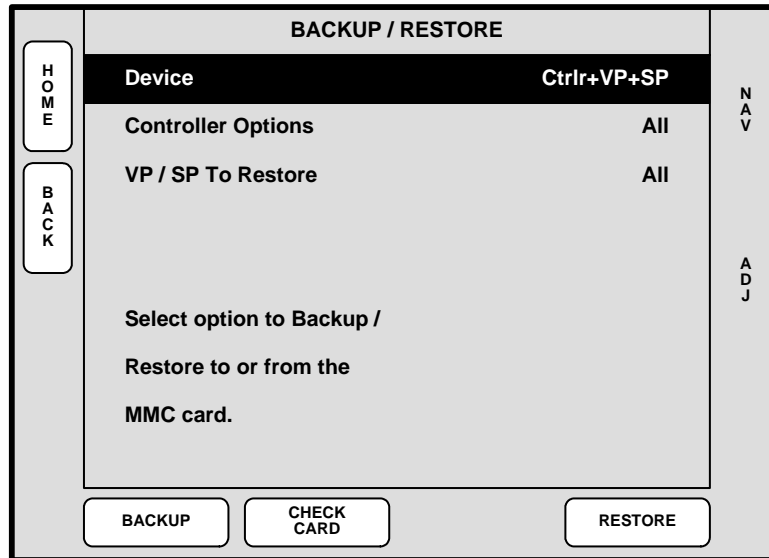


Figure 5-50. Backup/Restore Menu (sample)

The **Backup/Restore Menu** enables you to back up and restore system configurations, using the console's **Flash Memory Card** capability. You can also use this capability to transfer configurations between Controllers.

#### Note

You can only store one system configuration on a Flash Memory Card.

The following functions are provided:

- **Device** — Selects the device(s) that you want to backup or restore. Choose between the **Ctrlr**, **VP+SP** or **Ctrlr+VP+SP**.
- **Controller Options** — Selects which portion of the selected devices you want to backup or restore. Choose between **All**, **System** or **Presets**.
- **VP/SP to Restore** — Selects the device(s) that you wish to restore. Choose between **All** devices, or the ID of a specific device (e.g., **1**, **2**, **3**).
- Press {**BACKUP**} to perform a backup operation to the Flash Memory Card using the selected device(s) and options.
- Press {**CHECK CARD**} to check for the presence of a Flash Memory Card:
  - ~ If no card is present, the message "**Flash card not detected**" is shown.
  - ~ If a memory card is present, the **Current Backup Menu** appears. Refer to the "**Current Backup Menu**" section on page 207 for details.
- Press {**RESTORE**} to restore a system configuration from the Flash Memory Card to the selected device(s).

In Chapter 7, refer to the "**Using Backup and Restore**" section on page 353 for instructions.

### Current Backup Menu

From the **Backup/Restore Menu**, press {CHECK CARD} to display the **Current Backup Menu**. This menu only appears if a Flash Memory Card is present.

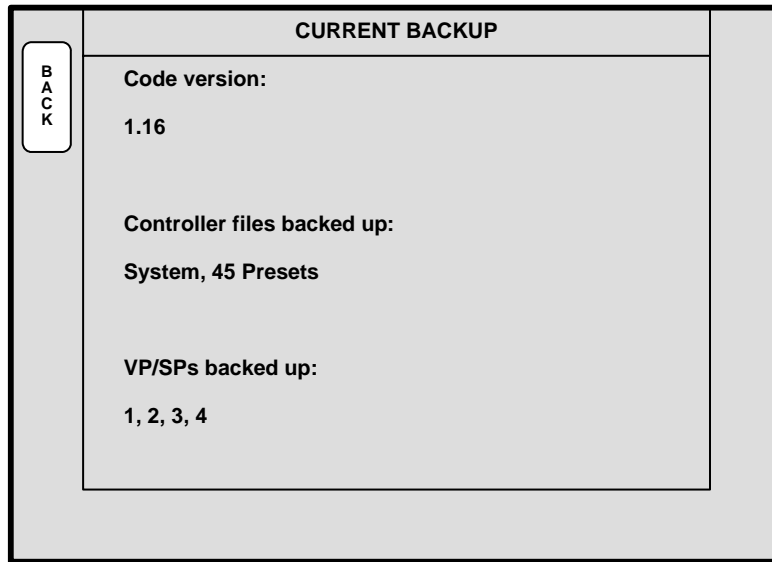


Figure 5-51. Current Backup Menu (sample)

The following functions are provided:

- **Code version** — lists the current version of Controller code.
- **Controller files backed up** — lists the types of files present on the Flash Memory Card (e.g., System, Presets, ScreenPRO-II).
- **VP/SPs backed up** — lists the IDs of the processors that are backed up.

## 5. Menu Orientation

### Preset Recall Options Menu

---

## Preset Recall Options Menu

The **Preset Recall Options Menu** enables you to select which part of a preset register you wish to recall.

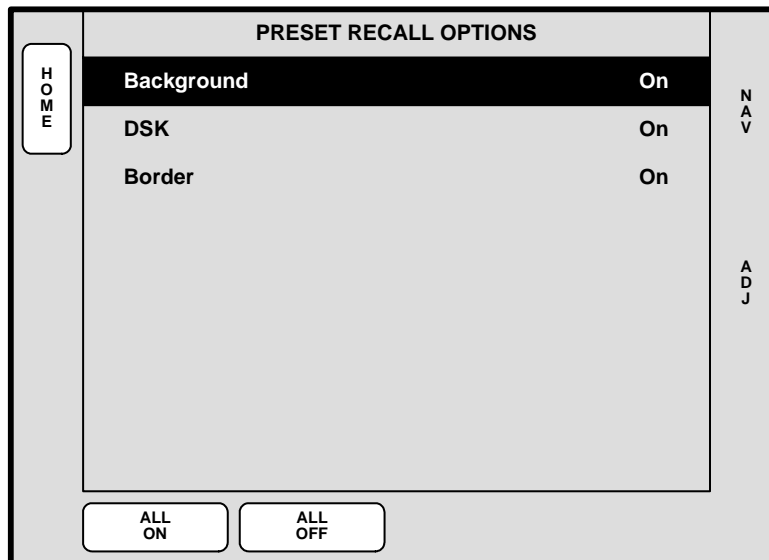


Figure 5-52. Preset Recall Options Menu

To access the menu:

- Press **PRESETS** on the **Home Menu**, or press **Presets** in the **Keypad Section**.

Each Preset is divided into three components (**Background**, **DSK**, and **Border**), which you can individually enable or disable for recall using the **Preset Recall Options Menu**.

#### Important

The recall configuration (as set on the menu) is global, and it affects all recalls from that point forward, until changed.

Any component can be enabled or disabled. When a component is **OFF**, Preset recalls will not attempt to change that portion of the “look.” This essentially enables you to hold an on-line look — without overwriting it by the recalled Preset. For example:

- ▲ A series of Presets use Background A (**BG A**), configured as a live DVI unscaled input. If you decide that BG A needs to be a frame grab for that series of Presets, simply reconfigure BG A in the normal manner, and then in the **Preset Recall Options Menu**, turn **Background** to **OFF**. Now, when any of the Presets are recalled, the new frame grab background will hold, and it will not be overwritten by the DVI input.

The following functions are provided:

- **Background** — enable or disable the Preset’s background component.
- **DSK** — enable or disable the Preset’s DSK component.
- **Border** — enable or disable the Preset’s border component.



## Effects Menu

The figure below illustrates a sample **Effects Menu**:

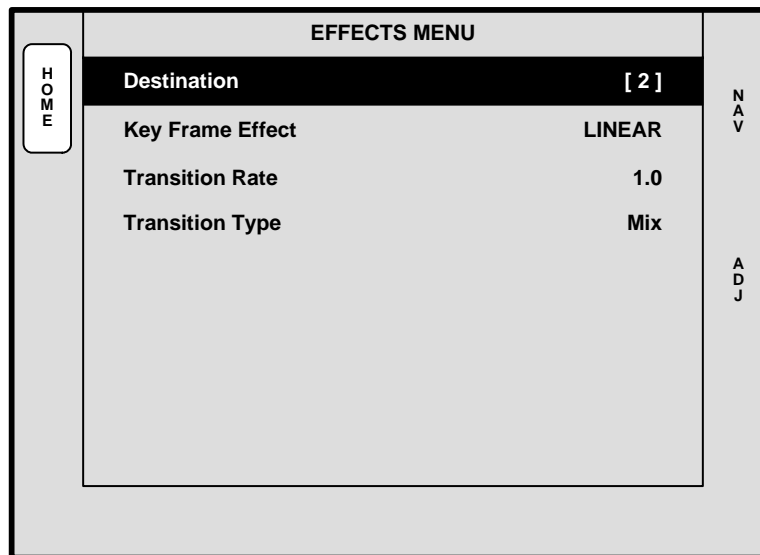


Figure 5-53. Effects Menu (sample)

To access the menu:

- Press **EFFECTS** on the **Home Menu**, or press **Effects** in the **Keypad Section**.

The **Effects Menu** allows you to modify and manage effects on a destination by destination basis, including the ability to define keyframes, paths and effect properties. The following functions are provided:

- **Destination** — indicates the currently selected destination (as chosen on the **Destination Bus**).
- **Key Frame Effect** — selects the type of point-to-point motion for a “move.” Choose between **LINEAR**, **LINEAR ACCL**, **ARCH CW**, **ARCH CCW**, **BMRNG CW**, and **BMRNG CCW**.
- **Transition Rate** — sets the auto-transition rate that is used when the **Auto Trans** button is pressed. The transition value is in 0.1 second increments.
- **Transition Type** — sets the transition type. Choose between **Mix**, **Wipe Right**, **Wipe Left**, **Wipe Down**, **Wipe Up**, **Curtain Open**, **Curtain Close**, **Box In** and **Box Out**.

### Note

Widescreen destinations only support two wipe patterns:  
**Wipe Up** and **Wipe Down**.

- **Transition Edge Width** — When a **Wipe** is selected, this field sets the transition's edge type. The range (in pixels) is from **0** to **256**.

In Chapter 7, refer to the [“Working with Transitions”](#) section on page 343 for details.

## 5. Menu Orientation

### Copy Setup Menu

---

## Copy Setup Menu

The figure below illustrates the **Copy Setup Menu**:

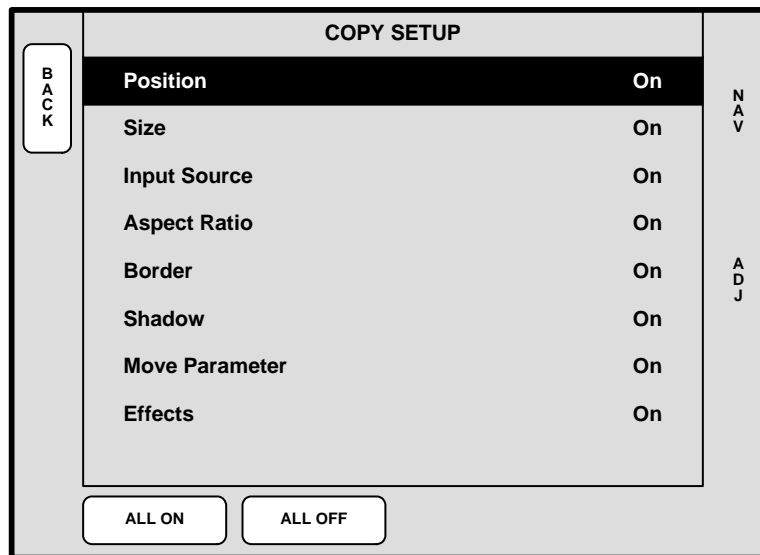


Figure 5-54. Copy Setup Menu (sample)

To access the menu:

- Press **COPY** in the **Layer Function Section**.

Encore's "**Copy**" function allows you to copy the parameters of a PIP or KEY from one layer to another. The **Copy Setup Menu** selects the precise subset of the effect's attributes that you wish to copy — such as border color, PIP size, aspect ratio, etc.

- ▲ To keep a PIP at its current position and size, but copy an effect's border attribute from another layer, turn **Position** and **Size** off, and turn **Border** on. Then perform the copy function itself.

The following functions are provided:

- **Position** — enables or disables the effect's "position" attribute.
- **Size** — enables or disables the effect's "size" attribute.
- **Input Source** — enables or disables the effect's "input source."
- **Aspect Ratio** — enables or disables the effect's "aspect ratio" attribute.
- **Border** — enables or disables the effect's "border" attribute.
- **Shadow** — enables or disables the effect's "shadow" attribute.
- **Move Parameter** — enables or disables the effect's "move" setup.
- **Effects** — enables or disables the effect's "special effects" attributes.
- Press **{ALL ON}** to enable all attributes.
- Press **{ALL OFF}** to disable all attributes.

In Chapter 7, refer to the "[Using Copy](#)" section on page 331 for instructions.

## User Key Copy Setup Menu

On the **Controller LC** only, the figure below illustrates a sample **User Key Copy Setup Menu**. The function is not available on the **Controller SC**.

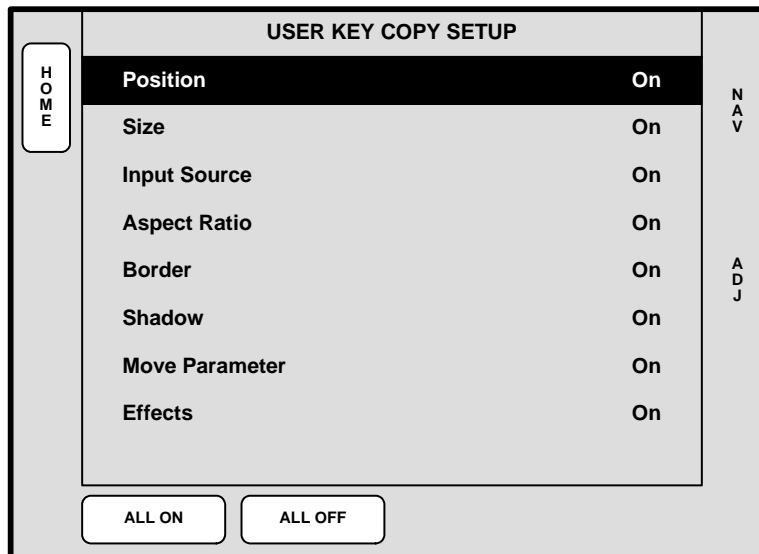


Figure 5-55. User Key Copy Setup Menu (sample)

To access the menu (Controller LC only):

- Press **USER KEYS** on the **Home Menu**, or press **User Copy** in the **Layer Function Section**.

The Controller LC has 100 available user keys (10 pages of 10 user keys). Similar to the **Copy Setup Menu**, the **User Key Copy Setup Menu** sets the precise subset of an effect's attributes that you wish to store on a user key — such as border color, PIP size, etc.

The following functions are provided:

- **Position** — enables or disables the effect's "position" attribute.
- **Size** — enables or disables the effect's "size" attribute.
- **Input Source** — enables or disables the effect's "input source."
- **Aspect Ratio** — enables or disables the effect's "aspect ratio" attribute.
- **Border** — enables or disables the effect's "border" attribute.
- **Shadow** — enables or disables the effect's "shadow" attribute.
- **Move Parameter** — enables or disables the effect's "move" setup.
- **Effects** — enables or disables the effect's "special effects" attributes.
- Press **{ALL ON}** to enable all attributes.
- Press **{ALL OFF}** to disable all attributes.

In Chapter 7, refer to the "[Working with User Keys](#)" section on page 350 for instructions.

## 5. Menu Orientation

### Status Menu

---

## Status Menu

The **Status Menu** provides basic system status information:

ENCORE SYSTEM STATUS	VER x.xx
VIDEO PROCESSOR: 4	
SCREENPRO II: 1	
PREPRO II: 1	
IMAGEPRO: 2	
ROUTERS: 2	
ENCORE VPx: 2	

Figure 5-56. Status Menu (sample)

To access the **Status Menu**:

- Press **STATUS** in the **Keypad Section**, or press **{STATS}** from various menus (such as the **Key Menu**).

The following status information is provided:

- **VER x.xx** — displays the Controller's current software version.
- **Video Processors** — lists the number of Video Processors detected.
- **ScreenPRO-II** — lists the number of ScreenPRO-II units detected.
- **ScreenPRO-II** — lists the number of PresentationPRO-II units detected.
- **ImagePRO** — lists the number of ImagePRO units detected.
- **Routers** — lists the number of Routers detected.
- **Encore VPx** — lists the number of VPx processors detected.

#### Note

If certain error conditions exist, the **Status Menu** displays additional messages (such as "**Checksum Mismatch**" and "**Please Upgrade**").

# PIP Adjustment Menu

The following topics are discussed in this section:

- [PIP Adjustment Menu Tree](#)
- [PIP Adjustment Menu Description](#)
- [PIP Adjustment Menu Functions](#)
- [PIP Adjustment Sub Menus](#)

## PIP Adjustment Menu Tree

The figure below illustrates the **PIP Adjustment Menu Tree**:

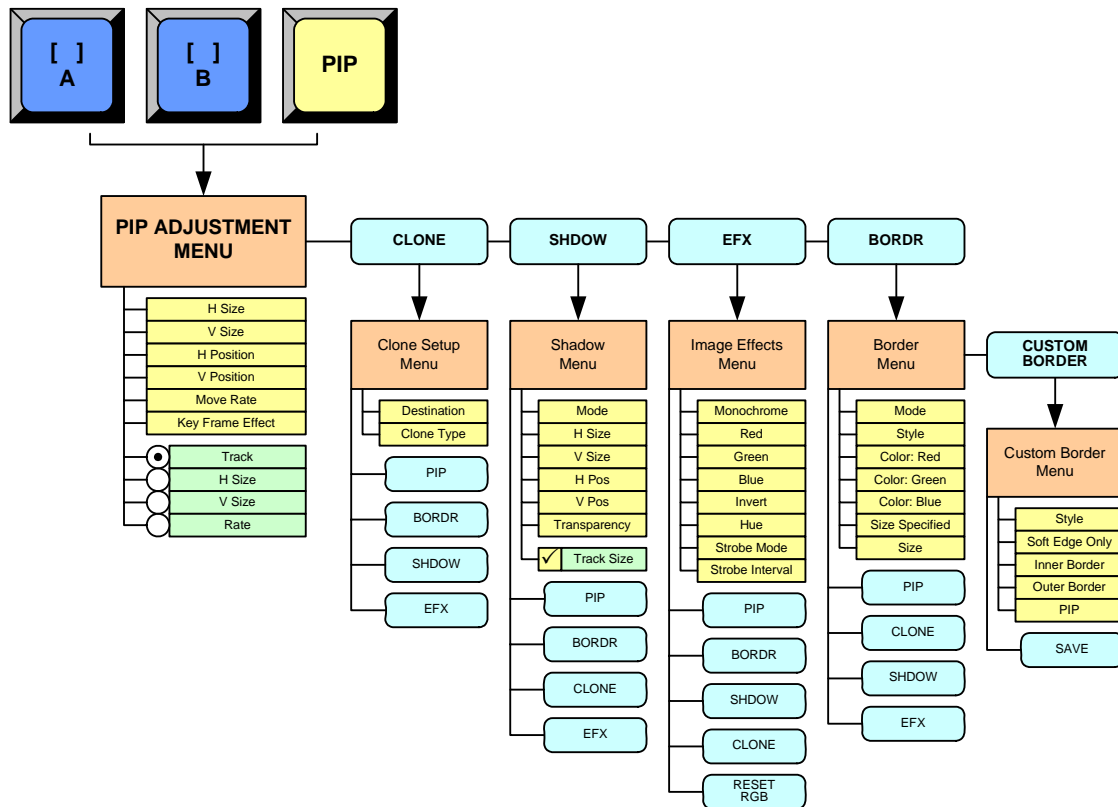


Figure 5-57. PIP Adjustment Menu Tree

All functions and sub menus are discussed in the following sections.

## 5. Menu Orientation

### PIP Adjustment Menu

## PIP Adjustment Menu Description

The figure below illustrates a sample **PIP Adjustment Menu**:

PIP ADJUSTMENT		
CLONE	H Size < 37.3% > 674	SIZE
	V Size < 58.9% > 452	
BOARD	H Position -34	H POS
	V Position 70	
SHOW	Move Rate 1.4	V POS
	Key Frame Effect [ LINEAR ]	
EFF	OPERATION:	V POS
	JOY Z TO SIZE, X Y TO POSITION	
<input checked="" type="radio"/> TRACK <input type="radio"/> H SIZE <input type="radio"/> V SIZE <input type="radio"/> RATE		

Figure 5-58. PIP Adjustment Menu (sample)

The **PIP Adjustment Menu** provides tools that enable you to adjust the “active” PIP. To access the menu:

- Select a blue “layer” button in the **Layer Control Section**.
- Press the **PIP** button in the **Layer Function Section**.

On the Controller LC, the menu immediately appears in the right hand Touch Screen Menu. On the Controller SC (with its single Touch Screen), the current “system” menu is replaced by the **PIP Adjustment Menu**.

## PIP Adjustment Menu Functions

The following **PIP Adjustment Menu** functions are provided:

- **H Size** — adjusts the PIP’s horizontal size. The “%” value is the PIP’s size as a percentage of the screen’s horizontal resolution. The numeric value is the PIP’s width in pixels. To adjust, use the Joystick’s Z-Axis knob or the **SIZE** rotary knob. See the [“PIP Joystick Functions”](#) section on page 215 for details.
- **V Size** — adjusts the PIP’s vertical size. The “%” value is the PIP’s size as a percentage of the screen’s vertical resolution. The numeric value is the PIP’s height in pixels. To adjust, use the Joystick’s Z-Axis knob or the **SIZE** rotary knob. See the [“PIP Joystick Functions”](#) section on page 215 for more details.
- **H Position** — indicates the PIP’s position, relative to the horizontal center of the screen (**00**), as measured from the exact center of the PIP. Thus, the value **-34** is 34 pixels to the left of center. To adjust, move the Joystick left and right.
- **V Position** — indicates the PIP’s position, relative to the vertical center of the screen (**00**), as measured from the exact center of the PIP. Thus, the value **70** is 70 pixels above center. To adjust **V Position**, move the Joystick up and down.

## 5. Menu Orientation

### PIP Adjustment Menu

- **Move Rate** — adjusts the rate (in 0.1 second increments) for programmed PIP “moves” from keyframe to keyframe. To adjust, select the **RATE** radio button and twist the Joystick Z-Axis knob.
- **Key Frame Effect** — indicates the “motion type” that is used to move the PIP from point to point.
  - ~ If no move is programmed, the display reads **[N/A]**.
  - ~ If a move is programmed, the motion type is shown (e.g., **[Linear]**). The motion type is selected on the **Effects Menu**.
- Press {**CLONE**} to display the **Clone Setup Menu** (if the **Clone** button is enabled). Refer to the “[Clone Setup Menu](#)” section on page 216 for details.
- Press {**BORDR**} to display the **Border Menu**. Refer to the “[Border Menu](#)” section on page 218 for details.
- Press {**SHDOW**} to display the **Shadow Menu**. Refer to the “[Shadow Menu](#)” section on page 219 for details.
- Press {**EFX**} to display the **Image Effects Menu**. Refer to the “[Image Effects Menu](#)” section on page 220 for details.
- Press **Source** in the **Joystick Section** to display the **Input Source Adjustment Menu**. Refer to the “[Source Adjustment Menus](#)” section on page 232.

### PIP Joystick Functions

At the bottom of the **PIP Adjustment Menu**, four radio buttons enable the Joystick to be assigned to various PIP adjustment functions.

- Press {**TRACK**} to lock **H Size** and **V Size** together. Regardless of the PIP’s current aspect ratio, its size will adjust proportionally when the Joystick’s Z-Axis knob or the **SIZE** rotary knob is used to change size.
- Press {**H SIZE**} to adjust only the horizontal size, leaving the vertical size alone. In this way, you can stretch the PIP horizontally.
- Press {**V SIZE**} to adjust only the vertical size, leaving the horizontal size as is. In this way, you can stretch the PIP vertically.
- Press {**RATE**} to adjust the move rate of the PIP, from keyframe to keyframe.

Please note the following additional related functions:

- To return the PIP to its default size and aspect ratio, press the **Reset** button in the **Joystick Section**.
- To adjust the PIP with fine resolution, press the **Fine Adjust** button in the **Joystick Section**.

### PIP Adjustment Sub Menus

The following sub menus can be accessed from the **PIP Adjustment Menu**:

- [Clone Setup Menu](#)
- [Border Menu](#)
- [Shadow Menu](#)
- [Image Effects Menu](#)

Complete descriptions are provided in the following sections.

## 5. Menu Orientation

### PIP Adjustment Menu

#### Clone Setup Menu

From the **PIP Adjustment Menu**, press **{CLONE}** to display the **Clone Setup Menu**, a sample of which is shown below.

#### Note

If the cloned layer is a key (and accessed from a **Key** menu), softkeys will be different: **{PIP}** is replaced by **{KEY}**, and **{BORDR}** and **{SHDOW}** will not be shown.

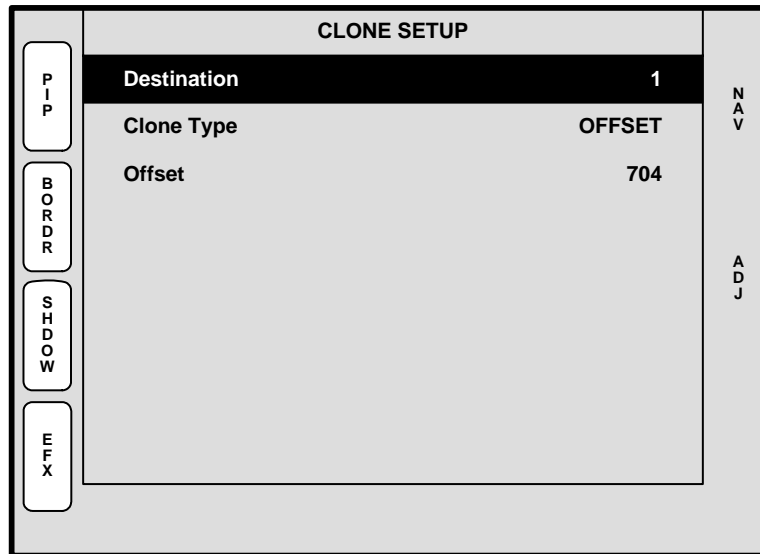


Figure 5-59. Clone Setup Menu (sample)

The **Clone Setup Menu** enables you to set parameters for a cloned layer.

#### Note

You can access the **Clone Menu** from the **Shadow Menu**, the **Border Menu** and the **Image Effects Menu** by pressing **{CLONE}** — provided that the **Clone** button is enabled.

Please note:

- The **{CLONE}** softkey only appears when a PIP (or Key) is cloned and the **Clone** button is lit.
- The mode can only be enabled when a widescreen destination is selected.
- The mode cannot be enabled if the PIP or Key straddles any part of the center of the overall widescreen. An error message “**Resource Conflict - Cannot Apply Clone**” will appear.
- Both PIPs and Keys can be cloned.
- You can set up and perform **Moves** with clones.

The following functions are provided:

- **Destination** — displays the currently selected destination.
- **Clone Type** — sets the type of clone “motion.”



## 5. Menu Orientation

### PIP Adjustment Menu

- ~ **Offset** — both cloned images move together with a fixed pixel offset. For example, if you adjust **H Position**, both images move left and right. If you adjust **V Position**, both images move up and down.

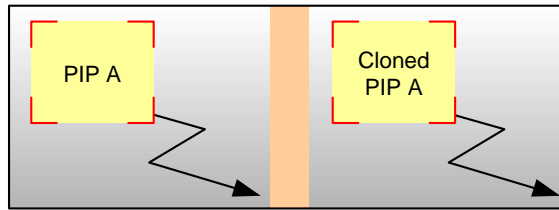


Figure 5-60. Clone Offset Mode — Sample Widescreen

- ~ **Mirror** — both cloned images move together as if a mirror is positioned in the middle of the widescreen overlap region. For example, if you adjust **H Position**, both images move towards (and away from) the center of the widescreen.

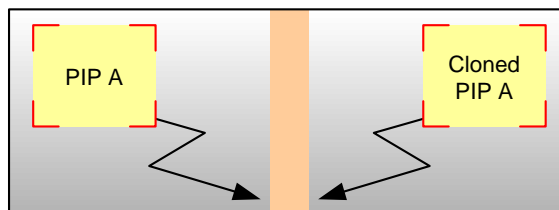


Figure 5-61. Clone Mirror Mode — Sample Widescreen

- **Offset** — if “**Offset**” is selected on the **Clone Type** line, this field enables you to set the offset (in pixels). If “**Mirror**” is selected, the field is hidden.

#### Important

The **Clone Setup Menu** also appears when the **Clone** button is enabled (in the **Layer Functions Section**), provided that a widescreen destination is selected. However, if you press **Clone** and the message “**Resource Conflict - Cannot Apply Clone**” appears, the PIP (or Key) is most likely positioned within the center of the widescreen.

- ▲ In a 2 screen blend, the PIP or Key cannot be positioned such that it sits between screens 1 and 2.
- ▲ In a 3 screen blend, the PIP or Key cannot be anywhere within the screen 2 space.

In Chapter 7, refer to the “[Using Clone](#)” section on page 330 for operating instructions.

## 5. Menu Orientation

### PIP Adjustment Menu

#### Border Menu

From the **PIP Adjustment Menu**, press {**BORDR**} to display the **Border Menu**.

BORDER	
Mode	On
Style	5
Color: Red	609
Green	600
Blue	531
Size Specified In	% of PIP
Size < % of PIP >	10.2

Figure 5-62. Border Menu (sample)

The **Border Menu** enables you to add a border to a PIP, and adjust its parameters.

#### Note

You can access the **Border Menu** from the **Shadow Menu**, the **Image Effects Menu** and the **Clone Setup Menu**.

The following functions are provided:

- **Mode** — enables or disables the PIP's border.
- **Style** — select one of ten border styles, including single color and dual color with various combinations of soft edge.
- **Color** — adjusts the border's **Red**, **Green** and **Blue** attributes as desired.
- **Size Specified In** — select the method by which you want to specify the border size, either as a percentage of the PIP size or in pixels.
- **Size** — adjust's the border size, using the method selected on the "**Size Specified In**" line. Note that if "**% of PIP**" is selected and you switch to "**Pixels**," the system auto converts one display method to the other.
- Press {**PIP**} to return to the **PIP Adjustment Menu**. Refer to the "[PIP Adjustment Menu Functions](#)" section on page 214 for details.
- Press {**CLONE**} to display the **Clone Setup Menu** (if **Clone** is enabled). Refer to the "[Clone Setup Menu](#)" section on page 216 for details.
- Press {**SHDOW**} to display the **Shadow Menu**. Refer to the "[Shadow Menu](#)" section on page 219 for details.
- Press {**EFX**} to display the **Image Effects Menu**. Refer to the "[Image Effects Menu](#)" section on page 220 for details.
- Press {**CUSTOM BORDER**} to display the **Custom Border Menu**. Refer to the "[Custom Border Menu](#)" section on page 222 for details.

## Shadow Menu

From the **PIP Adjustment Menu**, press {**SHDOW**} to display the **Shadow Menu**.

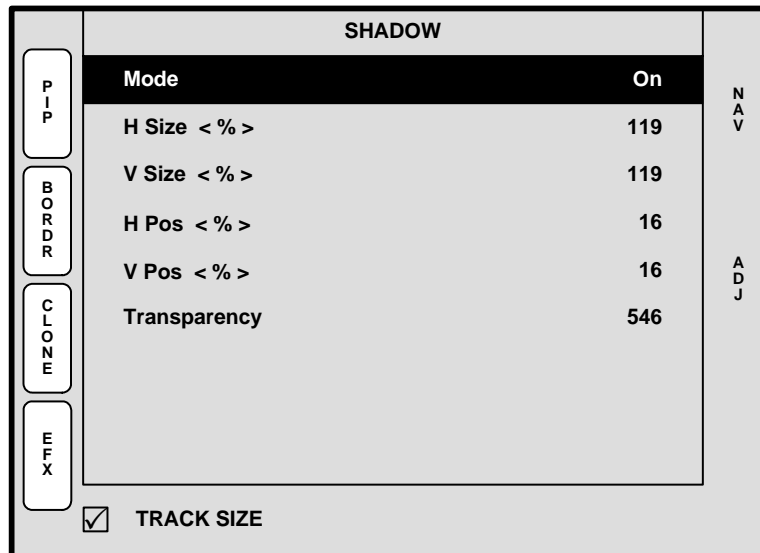


Figure 5-63. Shadow Menu (sample)

The **Shadow Menu** enables you place a shadow behind a PIP.

### Note

You can access the **Shadow Menu** from the **Border Menu**, the **Clone Setup Menu** and the **Image Effects Menu** by pressing {**SHDOW**}.

The following functions are provided:

- **Mode** — enables or disables the PIP's shadow.
- **H Size < % >** — adjusts the shadow's horizontal size as a percentage of the PIP's size. If {**TRACK SIZE**} is checked, **H** and **V** size adjust proportionally.
- **V Size < % >** — adjusts the shadow's vertical size as a percentage of the PIP's size. If {**TRACK SIZE**} is checked, **H** and **V** size adjust proportionally.
- **H Pos < % >** — adjusts the shadow's horizontal position.
- **V Pos < % >** — adjusts the shadow's vertical position.
- **Transparency** — adjusts transparency, from **0** (transparent) to **1024** (opaque).
- Check {**TRACK SIZE**} to adjust the shadow's **H Size** and **V Size** proportionally.
- Press {**PIP**} to return to the **PIP Adjustment Menu**. Refer to the "[PIP Adjustment Menu Functions](#)" section on page 214 for details.
- Press {**BORDR**} to display the **Border Menu**. Refer to the "[Border Menu](#)" section on page 218 for details.
- Press {**CLONE**} to display the **Clone Setup Menu** (if **Clone** is enabled). Refer to the "[Clone Setup Menu](#)" section on page 216 for details.
- Press {**EFX**} to display the **Image Effects Menu**. Refer to the "[Image Effects Menu](#)" section on page 220 for details.

## 5. Menu Orientation

### PIP Adjustment Menu

#### Image Effects Menu

From the **PIP Adjustment Menu** (or the **Key Menu**), press **{EFX}** to display the **Image Effects Menu**.

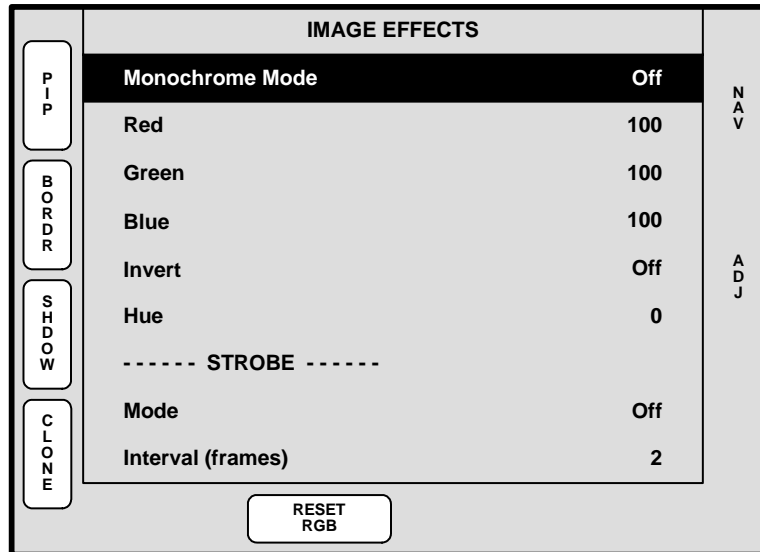


Figure 5-64. Image Effects Menu (sample)

The **Image Effects Menu** enables you to creatively manipulate the selected PIP or Key.

#### Note

When adjusting PIPs, you can access the **Image Effects Menu** from the **Border Menu**, the **Clone Setup Menu** or the **Shadow Menu** by pressing **{EFX}**.

When adjusting Keys, you can also access the **Image Effects Menu** from the **Key Adjustment Menu** or the **Matte Menu** by pressing **{EFX}**.

- **Monochrome Mode** — turns chroma on or off. When the mode is enabled, the image is completely monochrome.
- **Red** — adjusts the image's red saturation.  
~ **Adjustment range:** 0 to 100
- **Green** — adjusts the image's green saturation.  
~ **Adjustment range:** 0 to 100
- **Blue** — adjusts the image's blue saturation.  
~ **Adjustment range:** 0 to 100

#### Note

The **Red**, **Green** and **Blue** adjustments function whether or not **Monochrome Mode** is enabled.

#### Tip

For a sepia tone effect, turn **Monochrome Mode** on, and set **Red** to 100, **Green** to 65 and **Blue** to 10.

## 5. Menu Orientation

### PIP Adjustment Menu

- **Invert** — enables you to invert all image colors.
- **Hue** — adjusts the image's hue, by rotating color vectors throughout the 360 degree color spectrum.
- **Mode** — In the “**Strobe**” section, enables or disables the strobe mode which when enabled, acts as a programmable freeze.
- **Interval (frames)** — In the “**Strobe**” section, sets the freeze interval.
- Press {**RESET RGB**} to reset all image colors to their default values.
- Press {**PIP**} to return to the **PIP Adjustment Menu**. Refer to the “[PIP Adjustment Menu Functions](#)” section on page 214 for details.
- Press {**BORDR**} to display the **Border Menu**. Refer to the “[Border Menu](#)” section on page 218 for details.
- Press {**SHDOW**} to display the **Shadow Menu**. Refer to the “[Shadow Menu](#)” section on page 219 for details.
- Press {**CLONE**} to display the **Clone Setup Menu** (if **Clone** is enabled). Refer to the “[Clone Setup Menu](#)” section on page 216 for details.

#### Note

To remove any image effects from the PIP or Key, press the **RESET** button in the **Layer Functions Section**. No other parameters will be affected.

## 5. Menu Orientation

### PIP Adjustment Menu

#### Custom Border Menu

From the **Border Menu**, press {CUSTOM BORDER} to display the **Custom Border Menu**.

CUSTOM BORDER MENU	
<b>Style</b>	<b>21</b>
<b>Adjust Pip Soft Edge Only</b>	<b>Off</b>
<b>Inner Border: Width ( % )</b>	<b>9</b>
<b>Soft Edge ( % )</b>	<b>0</b>
<b>Color Tone ( % )</b>	<b>100</b>
<b>Soft Edge Curve</b>	<b>1</b>
<b>Soft Edge Gamma</b>	<b>1.0</b>
<b>Outer Border: Width ( % )</b>	<b>0</b>
<b>Soft Edge ( % )</b>	<b>0</b>

BACK

NAV

ADJ

SAVE

Figure 5-65. Custom Border Menu (sample)

The **Custom Border Menu** enables you to create and save custom borders. To use the feature, start with a pre-configured border style on the **Border Menu** (styles 1 through 20), then using the **Custom Border Menu**, create a new custom border look. Finally, save the new border for use on the **Border Menu**. The following functions are available:

- **Style** — selects a number (from 21 - 40) under which the new custom border will be saved for later use on the **Border Menu**. The label (**EMPTY**) indicates that the register does not contain a border definition, and is available for programming.
- **Adjust Pip Soft Edge Only** — enables or disables limited custom adjustment:
  - ~ When set to **ON**, only the PIP's soft edge can be customized via three parameters:
    - Soft Edge (%)
    - Soft Edge Curve
    - Soft Edge Gamma
  - ~ If a border style other than 1 was selected on the **Border Menu**, this field displays **OFF**. Three groups of custom border adjustments are available as detailed below.
- **Inner Border** — adjusts the border that is adjacent to the live PIP data. The following parameters can be adjusted individually:
  - ~ Width (%), Soft Edge (%), Color Tone (%)
  - ~ Soft Edge Curve, Soft Edge Gamma
- **Outer Border** — adjusts the border that is adjacent to the inner border. The following parameters can be adjusted individually:
  - ~ Width (%), Soft Edge (%), Color Tone (%)
  - ~ Soft Edge Curve, Soft Edge Gamma

## 5. Menu Orientation

### PIP Adjustment Menu

- **PIP Soft Edge** — adjusts the soft edge that is applied between the live PIP data and the inner border. The following parameters can be adjusted individually:
  - ~ Soft Edge (%)
  - ~ Soft Edge Curve
  - ~ Soft Edge Gamma
- **Save** — saves the custom border with the selected “Style” number, and returns the system to the **Border Menu**. In the Border Menu’s **Style** field, the newly customized border is selected, and the “**Custom**” label is displayed.

Please note the following important points regarding custom borders:

- When adjusting the **Inner Border Width**, **Outer Border Width** or **PIP Soft Edge**, these three values must add up to 100%. When adjusting one of these three values, the controller automatically recalculates the adjacent border width to ensure that these three parameters add up to 100%.
  - ▲ If **PIP Soft Edge** is increased, **Inner Border Width** will be decreased accordingly.
  - ▲ If **Inner Border Width** is increased, **Outer Border Width** will be decreased accordingly.
- If you attempt to exit the **Custom Border Menu** prior to pressing **Save**, you will be asked to save or cancel the modified border. If you cancel, the border will be restored to the previous look — prior to any adjustments.
- After a custom border has been saved, it is available for use by any single screen or widescreen destination — regardless of which destination was used to create the new border.
- Any custom borders that you create are fully backed up by the **Backup and Restore** procedure — using the MMC card or the Barco Backup and Restore Utility.
- In the event that a VP or VPx needs to be replaced after custom borders have been created, upon connection to the Controller, the Controller automatically downloads all custom border files to the new VP or VPx.

## 5. Menu Orientation

### Key Menu

## Key Menu

The following topics are discussed in this section:

- [Key Menu Tree](#)
- [Key Menu Description](#)
- [Key Menu Functions](#)
- [Key Sub Menus](#)

## Key Menu Tree

The figure below illustrates the **Key Menu** tree:

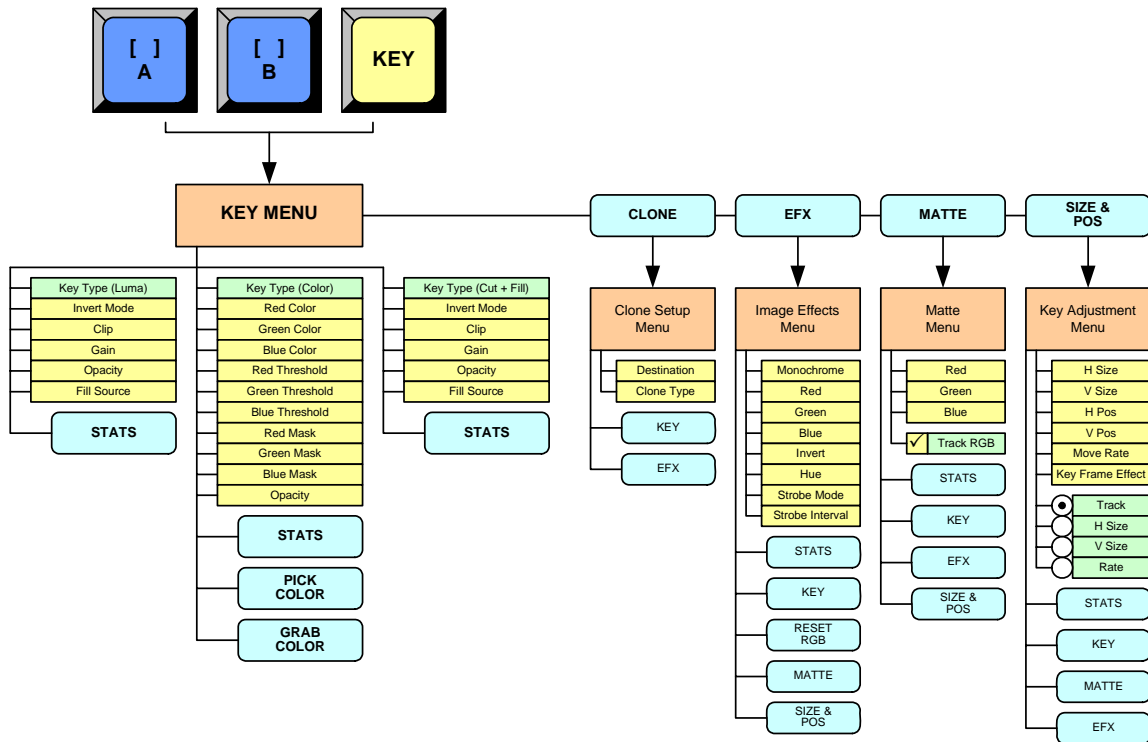


Figure 5-66. Key Menu Tree

All functions and sub menus are discussed in the following sections.



## Key Menu Description

The figure below illustrates a sample **Key Menu**, when **Luma** key is selected:

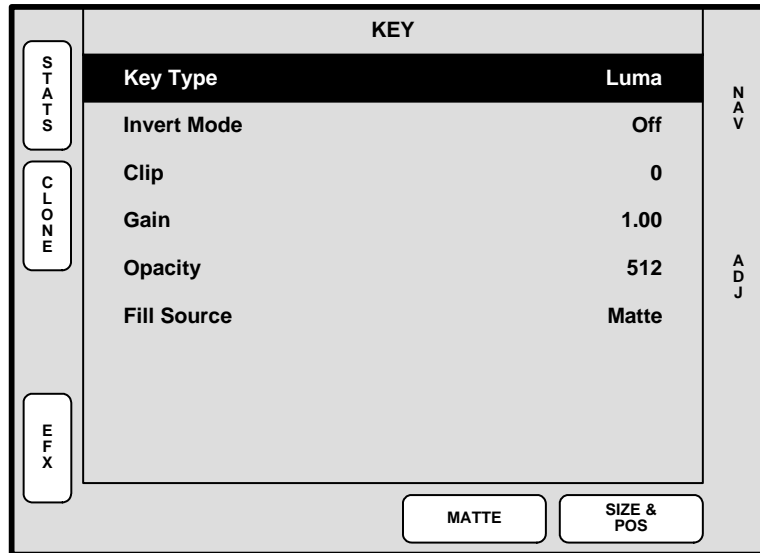


Figure 5-67. Key Menu (sample)

The **Key Menu** provides the tools to adjust the “active” key. To access the menu:

- Select a blue button in the **Layer Control Section**.
- Press the **KEY** button in the **Layer Function Section**.

On the Controller LC, the menu immediately appears in the right hand Touch Screen. On the Controller SC (with its single Touch Screen), the current “system” menu is replaced by the **Key Menu**.

## Key Menu Functions

The available **Key Menu** functions change, depending upon the type of key selected.

- **Key Type** — displays the type of key:
  - ~ Choose between **Luma** or **Color** when the **Layer A** key is selected.
  - ~ Choose between **Luma**, **Color**, or **Cut + Fill** when the **Layer B** key is selected (in **Split Mode** only).

Refer to the following sections for details.

- [Luma Key Functions](#)
- [Color Key Functions](#)
- [Cut + Fill Key Functions](#)

## 5. Menu Orientation

### Key Menu

#### Luma Key Functions

A **Luma** (luminance) key is one in which the hole-cutting information is derived from the luminance (brightness) level of the key source.

#### Note

**Luma** keys can be selected on both the Layer A and Layer B keyers, in both **Split** and **Mix** modes.

The following **Key Menu** functions are provided when **Luma** key is selected:

- **Invert Mode** — enables you to invert the key signal.
- **Clip** — adjusts the threshold of the video that “cuts” into the background image. A hole will be cut into the background anywhere that foreground luminance is greater than the clip level. The hole is then filled with the **Fill Source**.
  - ~ **Adjustment range:** 0 to 1023
- **Gain** — adjusts the sensitivity of the keyer, enabling you to change the sharpness of the keyed image. Gain only affects the key hole, as set by the clip.
  - ~ **Adjustment range:** 0 to 1023.99
- **Opacity** — enables you to adjust the opacity of the keyed image, from fully opaque to fully transparent.
  - ~ **Adjustment range:** 0 to 1024
- **Fill Source** — determines the video that fills the key hole:
  - ~ **Self** — fills the hole with the key source video itself, for example, the video from a character generator or logo.
  - ~ **Matte** — fills the hole with a matte color, which can be adjusted with the **Matte Menu**. See the “[Matte Menu](#)” section on page 228 for details.
- Press {**STATS**} to display the **Status Menu**. Refer to the “[Status Menu](#)” section on page 212 for details.
- Press {**CLONE**} to display the **Clone Setup Menu** (if **Clone** is enabled). Refer to the “[Clone Setup Menu](#)” section on page 216 for details
- Press {**EFX**} to display the **Image Effects Menu**. Refer to the “[Image Effects Menu](#)” section on page 220 for details.
- Press {**MATTE**} to display the **Matte Menu**. Refer to the “[Matte Menu](#)” section on page 228 for details.
- Press {**SIZE & POS**} to display the **Key Adjustment Menu**. Refer to the “[Key Adjustment Menu](#)” section on page 229 for details.

#### Color Key Functions

A **Color** key is one in which the hole-cutting information is derived from a specific RGB value — including luminance.

#### Note

**Color** keys can be selected on both the Layer A and Layer B keyers, in both **Split** and **Mix** modes.

The following **Key Menu** functions are provided when **Color** key is selected:

- **Red Color** — adjusts the red component of the selected key color, from 0 to 1024.
- **Green Color** — adjusts the green component of the key color, from 0 to 1024.

- **Blue Color** — adjusts the blue component of the key color, from 0 to 1024.
- **Red Threshold** — adjusts the key's clip along the Cyan vector (as demonstrated using a CIE color chip chart).
- **Green Threshold** — adjusts the key's clip along the Magenta vector.
- **Blue Threshold** — adjusts the key's clip along the Yellow vector
- **Red Mask** — adjusts the background mask to/from black along the Cyan vector.
- **Green Mask** — adjusts background mask to/from black along the Magenta vector.
- **Blue Mask** — adjusts background mask to/from black along the Yellow vector.
- **Opacity** — adjusts the opacity of the keyed image, from fully opaque to fully transparent.
  - ~ **Adjustment range:** 0 to 1024
- Press {**STATS**} to display the **Status Menu**. Refer to the "[Status Menu](#)" section on page 212 for details.
- Press {**CLONE**} to display the **Clone Setup Menu** (if **Clone** is enabled). Refer to the "[Clone Setup Menu](#)" section on page 216 for details
- Press {**EFX**} to display the **Image Effects Menu**. Refer to the "[Image Effects Menu](#)" section on page 220 for details.
- Press {**PICK COLOR**} to choose the keying color visually. Once pressed, the {**GRAB COLOR**} label appears, and a crosshair appears on Preview. Use the Joystick to move the crosshair around the Preview monitor as desired.
- Press {**GRAB COLOR**} to select the color directly under the crosshair. These values are immediately mapped into the **Red**, **Green** and **Blue** color fields on the menu, and can be adjusted with the knobs in the normal manner.
- Press {**SIZE & POS**} to display the **Key Adjustment Menu**. Refer to the "[Key Adjustment Menu](#)" section on page 229 for details.

### Cut + Fill Key Functions

A **Cut + Fill** key is one in which the hole-cutting information is provided by a Luma Key on a mixer's B layer, and the fill information is provided by the same mixer's A layer.

#### Note

**Cut + Fill** keys can only be selected on a mixer's Layer B keyer, in the **Split** mode only.

The following **Key Menu** functions are provided when **Cut + Fill** key is selected:

- **Invert Mode** — enables you to invert the "Cut" key signal.
- **Clip** — adjusts the threshold of the video that "cuts" into the background. The hole is filled with the **Fill Source** from Layer A.
  - ~ **Adjustment range:** 0 to 1023
- **Gain** — adjusts the sensitivity of the keyer, enabling you to change the sharpness of the image. Gain only affects the key hole.
  - ~ **Adjustment range:** 0 to 1023.99
- **Opacity** — enables you to adjust the opacity of the keyed image, from fully opaque to fully transparent.
  - ~ **Adjustment range:** 0 to 1024

## 5. Menu Orientation

### Key Menu

- **Fill Source** — permanently set to the current mixer's Layer A (e.g., [1A]).
- Press {STATS} to display the **Status Menu**. Refer to the "[Status Menu](#)" section on page 212 for details.
- Press {CLONE} to display the **Clone Setup Menu** (if Clone is enabled). Refer to the "[Clone Setup Menu](#)" section on page 216 for details
- Press {EFX} to display the **Image Effects Menu**. Refer to the "[Image Effects Menu](#)" section on page 220 for details.
- Press {SIZE & POS} to display the **Key Adjustment Menu**. Refer to the "[Key Adjustment Menu](#)" section on page 229 for details.

In Chapter 7, refer to the "[Working with Keys in Split Mode](#)" section on page 324 for instructions.

## Key Sub Menus

The following sub menus can be accessed from the **Key Adjustment Menu**:

- [Matte Menu](#)
- [Key Adjustment Menu](#)

### Matte Menu

From the **Key Menu**, press {MATTE} to display the **Matte Menu**.

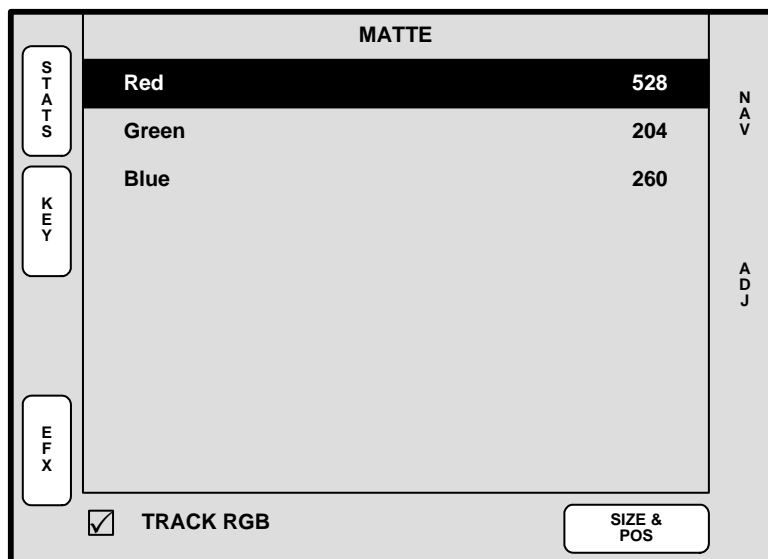


Figure 5-68. Matte Menu (sample)

#### Note

The menu is also accessed from the **DSK Adjustment Menu**. All functions are identical, but the menu is named the **DSK Matte Adjustment Menu** at the top.

The **Matte Menu** adjusts the fill color of a matte key. The following functions are provided:

- **Red** — adjusts the red component of the matte fill as required, from 0 to 1024.
- **Green** — adjusts the green component of the matte fill, from 0 to 1024.

- **Blue** — adjusts the blue component of the matte fill, from 0 to 1024.
- Press {**STATS**} to display the **Status Menu**. Refer to the “[Status Menu](#)” section on page 212 for details.
- Press {**KEY**} to display the **Key Menu**. Refer to the “[Key Menu Description](#)” section on page 225 for details.
- Press {**EFX**} to display the **Image Effects Menu**. Refer to the “[Image Effects Menu](#)” section on page 220 for details.
- Check {**TRACK RGB**} to lock **RGB** values together, and adjust them all simultaneously. Uncheck to unlock the values, and adjust colors individually.
- Press {**SIZE & POS**} to display the **Key Adjustment Menu**. Refer to the “[Key Adjustment Menu](#)” section on page 229 for details.

### Key Adjustment Menu

From the **Key Menu**, press {**SIZE & POS**} to display the **Key Adjustment Menu**.

KEY ADJUSTMENT		
STATS	H Size < 33.5% >	606
	V Size < 58.3% >	448
KEY	H Position	-160
	V Position	64
MATTE	Move Rate	2.0
	Key Frame Effect	[ N/A ]
EFX	OPERATION:	
	JOY Z TO SIZE, X Y TO POSITION	
<input checked="" type="radio"/> TRACK <input type="radio"/> H SIZE <input type="radio"/> V SIZE <input type="radio"/> RATE		SIZE  POS  POS

Figure 5-69. Key Adjustment Menu (sample)

The **Key Adjustment Menu** is virtually identical to the **PIP Adjustment Menu** — except that it pertains to Keys rather than PIPs. The following functions are provided:

- **H Size** — adjusts the Key’s horizontal size. The “%” value indicates the key’s size as a percentage of the screen’s horizontal resolution. The numeric value is the Key’s width in pixels. To adjust, use the Joystick’s Z-Axis knob or the **SIZE** knob. See the “[Key Joystick Functions](#)” section on page 230 for details.
- **V Size** — adjusts the PIP’s vertical size. The “%” value indicates the PIP’s size as a percentage of the screen’s vertical resolution. The numeric value is the PIP’s height in pixels. To adjust, use the Joystick’s Z-Axis knob or the **SIZE** knob. See the “[Key Joystick Functions](#)” section on page 230 for details.
- **H Position** — indicates the Key’s position, relative to the horizontal center of the screen (00), as measured from the exact center of the Key. Thus, the value **-160** is 160 pixels to the left of center. To adjust, move the Joystick left and right.

## 5. Menu Orientation

### Key Menu

- **V Position** — indicates the Key's position, relative to the vertical center of the screen (**00**), as measured from the exact center of the Key. Thus, the value **64** is 64 pixels above center. To adjust, move the Joystick up and down.
- **Move Rate** — adjusts the rate (in 0.1 second increments) for programmed Key movement, from keyframe to keyframe. To adjust, select the **RATE** radio button and twist the Joystick Z-Axis knob.
- **Key Frame Effect** — indicates the “motion type” that is used to move the Key from point to point.
  - ~ If no move is programmed, the display reads **[N/A]**.
  - ~ If a move is programmed, the motion type is shown (e.g., **[Linear]**). The motion type is selected on the **Effects Menu**.
- Press **{STATS}** to display the **Status Menu**. Refer to the “[Status Menu](#)” section on page 212 for details.
- Press **{KEY}** to display the **Key Menu**. Refer to the “[Key Menu Description](#)” section on page 225 for details.
- Press **{MATTE}** to display the **Matte Menu**. Refer to the “[Matte Menu](#)” section on page 228 for details.
- Press **{EFX}** to display the **Image Effects Menu**. Refer to the “[Image Effects Menu](#)” section on page 220 for details.

#### **Key Joystick Functions**

At the bottom of the **Key Adjustment Menu**, four radio buttons enable the Joystick to be assigned to various Key adjustment functions.

- Press **{TRACK}** to lock **H Size** and **V Size** together. Regardless of the Key's current aspect ratio, its size adjusts proportionally when the Joystick's Z-Axis knob or the **SIZE** rotary knob is used to change size.
- Press **{H SIZE}** to adjust only the horizontal size, leaving the vertical size alone. In this way, you can stretch the Key horizontally.
- Press **{V SIZE}** to adjust only the vertical size, leaving the horizontal size as is. In this way, you can stretch the Key vertically.
- Press **{RATE}** to adjust the move rate of the Key, from keyframe to keyframe.

Please note the following additional related functions:

- To return the Key to its default size and aspect ratio, press the **RESET** button in the **Joystick Section**.
- To adjust the Key with fine resolution, press the **FINE ADJUST** button in the **Joystick Section**.

## Crop Menu

With a **PIP** or a **Key** selected, press **Crop** to display the **Crop Menu**.

S T A T S	CROP ADJUSTMENT	ALL-SIDES	S I Z E
	H Size < 53.3% >		
V Size < 50.0% >		512	
---- Aspect Ratio ----			
	Mode		4:3
	Ratio		1.333
OPERATION:			
JOY Z TO CROP SIZE			
<input checked="" type="radio"/> TRACK <input type="radio"/> H SIZE <input type="radio"/> V SIZE			
			M O D E
			R A T I O

Figure 5-70. Crop Menu (sample)

The **Crop Menu** enables you crop the sides of a PIP or a Key without affecting the size of the source image. The following functions are provided:

- **H Size** — indicates the PIP or Key's horizontal size. The "%" value indicates size as a percentage of the screen's horizontal resolution. The numeric value is the width in pixels. To crop, use the Joystick's **Z-Axis** knob or the **SIZE** knob.
- **V Size** — indicates the PIP or Key's vertical size. The "%" value indicates size as a percentage of the screen's vertical resolution. The numeric value is the height in pixels. To crop, use the Joystick's **Z-Axis** knob or the **SIZE** knob.
- **Aspect Ratio Mode** — rotate the **MODE** knob to select one of several standard aspect ratios: **16:9**, **5:4**, **4:3**, **3:2** and **1:1**.
- **Ratio** — Rotate the **RATIO** knob to select a custom aspect ratio.
- Press {**TRACK**} to proportionally crop **H** and **V** edges.
- Press {**H SIZE**} to crop only the left and right edges.
- Press {**V SIZE**} to crop only the top and bottom edges.

Please note the following important points:

- To remove crop effects from the layer, press the **RESET** button in the **Joystick Section**. No other parameters will be affected.
- If you enter the **Crop Menu** for a layer that is already cropped, if you crop the layer further, **RESET** returns the image to its state when the menu was enabled.
- To completely **RESET** a layer to a non-cropped state, exit the **Crop Menu** and re-select the source in the **Source Selection Bus**.
- While in the **Crop Menu**, selecting different sources into the layer causes a relative crop to be applied to the new source within the layer.

## 5. Menu Orientation

### Source Adjustment Menus

---

## Source Adjustment Menus

Two similar **Source Adjustment Menus** are available:

- If a **PIP** is selected:
  - a. Press **SOURCE** (in the **Joystick Section**) to display the **Input Source Adjustment Menu**.
- If a **Key** is selected:
  - a. Access the **Key Adjustment** menu (by pressing {**SIZE & POS**} on the **Key Menu**)
  - b. Press **SOURCE** (in the **Joystick Section**) to display the **Key Source Adjustment Menu**.

Please note:

- On the Controller LC, the selected Source Adjustment Menu immediately appears in the right hand Touch Screen Menu.
- On the Controller SC (with its single Touch Screen), the current “system” menu is replaced by the selected Source Adjustment Menu.

Both menus are virtually identical in their functionality, with the exception of the available branches. All functions and sub menus are discussed in the following sections.

- [Source Adjustment Menu Trees](#)
- [Source Adjustment Menu Description](#)
- [Source Adjustment Menu Functions](#)



## Source Adjustment Menu Trees

The figure below illustrates the two **Source Adjustment Menu Trees**.

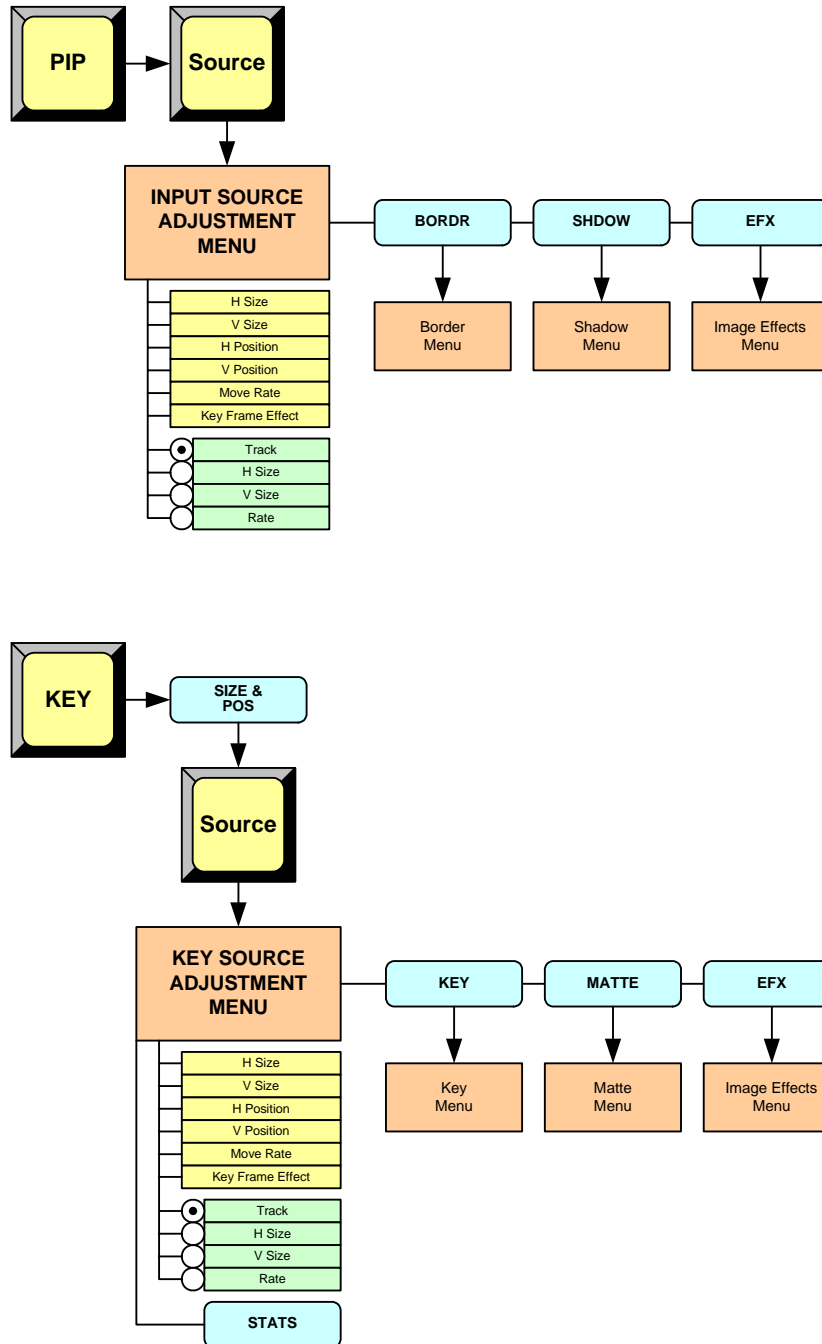


Figure 5-71. Source Adjustment Menu Trees

All functions and sub menus are discussed in the following sections.

## 5. Menu Orientation

### Source Adjustment Menus

## Source Adjustment Menu Description

The figure below illustrates a sample **Input Source Adjustment Menu**:

INPUT SOURCE ADJUSTMENT		
B O R D R	H Size < 100.0% >	1024
	V Size < 100.0% >	768
	H Position	0
	V Position	0
S H D O W	Move Rate	2.0
	Key Frame Effect	[ N/A ]
E F F X	OPERATION: JOY Z TO SIZE, X Y TO POSITION	
	<input checked="" type="radio"/> TRACK <input type="radio"/> H SIZE <input type="radio"/> V SIZE <input type="radio"/> RATE	
		S I Z E
		H P O S
		V P O S

Figure 5-72. Input Source Adjustment Menu (sample)

The figure below illustrates a sample **Key Source Adjustment Menu**:

KEY SOURCE ADJUSTMENT		
S T A T S	H Size < 100.0% >	1024
	V Size < 100.0% >	768
K E Y	H Position	0
	V Position	0
M A T T E	Move Rate	2.0
	Key Frame Effect	[ N/A ]
E F F X	OPERATION: JOY Z TO SIZE, X Y TO POSITION	
	<input checked="" type="radio"/> TRACK <input type="radio"/> H SIZE <input type="radio"/> V SIZE <input type="radio"/> RATE	
		S I Z E
		H P O S
		V P O S

Figure 5-73. Key Source Adjustment Menu (sample)

As shown above, the **Input Source Adjustment Menu** is virtually identical to the **Key Source Adjustment Menu** — and also virtually identical to the **PIP** and **Key Adjustment** menus. The exception is that the two **Source** adjustment menus pertain to the source “inside” the PIP or Key — rather than the boundaries of the PIP or Key itself.

In this way, for example, a PIP can remain in its *exact* location on screen, but you can scale or re-position the *image inside* the PIP.

### Source Adjustment Menu Functions

The following **Source Adjustment Menu** functions are provided:

- **H Size** — adjusts the source's horizontal size. The “%” value indicates size as a percentage of the *original* PIP or Key's horizontal resolution. The numeric value is the source's width in pixels. To adjust, use the Joystick's Z-Axis knob or the **SIZE** knob. See the “[Source Joystick Functions](#)” section on page 236 for details.
- **V Size** — adjusts the source's vertical size. The “%” value indicates size as a percentage of the original PIP or Key's vertical resolution. The numeric value is the source's height in pixels. To adjust, use the Joystick's Z-Axis knob or the **SIZE** knob. See the “[Source Joystick Functions](#)” section on page 236 for details.
- **H Position** — indicates the source's horizontal position, relative to its default horizontal position (**00**) with no offset. Thus, the value **50** is 50 pixels to the right of its default position. To adjust, move the Joystick left and right along the X-Axis.
- **V Position** — indicates the source's vertical position, relative to its default vertical position (**00**) with no offset. Thus, the value **-10** is 10 pixels below its default position. To adjust, move the Joystick up and down along the Y-Axis.
- **Move Rate** — adjusts the rate (in 0.1 second increments) for programmed Key or PIP movement, from keyframe to keyframe. To adjust, select the **RATE** radio button and twist the Joystick Z-Axis knob.
- **Key Frame Effect** — indicates the “motion type” that is used to move the PIP or Key from point to point.
  - ~ If no move is programmed, the display reads **[N/A]**.
  - ~ If a move is programmed, the motion type is shown (e.g., **[Linear]**). The motion type is selected on the **Effects Menu**.

For **Input Source Adjustments**:

- Press {**BORDR**} to display the **Border Menu**. Refer to the “[Border Menu](#)” section on page 218 for details.
- Press {**SHDOW**} to display the **Shadow Menu**. Refer to the “[Shadow Menu](#)” section on page 219 for details.
- Press {**EFX**} to display the **Image Effects Menu**. Refer to the “[Image Effects Menu](#)” section on page 220 for details.

For **Key Source Adjustments**:

- Press {**STATS**} to display the **Status Menu**. Refer to the “[Status Menu](#)” section on page 212 for details.
- Press {**KEY**} to display the **Key Menu**. Refer to the “[Key Menu Description](#)” section on page 225 for details.
- Press {**MATTE**} to display the **Matte Menu**. Refer to the “[Matte Menu](#)” section on page 228 for details.
- Press {**EFX**} to display the **Image Effects Menu**. Refer to the “[Image Effects Menu](#)” section on page 220 for details.

## 5. Menu Orientation

### Source Adjustment Menus

#### Source Joystick Functions

At the bottom of the **Input Source Adjustment Menu** and the **Key Source Adjustment Menu**, four radio buttons assign the Joystick to various source adjustment functions.

- Press **{TRACK}** to lock **H Size** and **V Size** together. Regardless of the source's current aspect ratio, its size adjusts proportionally when the Joystick's Z-Axis knob or the **SIZE** rotary knob is used to change size.
- Press **{H SIZE}** to adjust only the horizontal size, leaving the vertical size alone. In this way, you can stretch the source horizontally.
- Press **{V SIZE}** to adjust only the vertical size, leaving the horizontal size as is. In this way, you can stretch the source vertically.
- Press **{RATE}** to adjust the move rate of the PIP or Key, from keyframe to keyframe.

Please note the following additional related functions:

- To return the source to its default size and aspect ratio, press the **RESET** button in the **Joystick Section**.
- To adjust the source with fine resolution, press the **FINE ADJUST** button in the **Joystick Section**.

---

# Background Input Setup Menu

The **BG** (Background) **Input Setup Menu** enables you to select and define background sources **A** and **B**. For each background, you can choose between a solid matte color, a DVI input, an analog input, or a captured frame grab as the background source. The menus change depending on the selected background “type.”

To access the menu:

- Press **BG A** or **BG B** in the Controller’s **Layer Control Section**.
  - ~ If the selected background is already on Program, the **BG Input Setup Menu** appears, but parameters cannot be adjusted. The layer *can* be cleared in the normal manner, however, in which case the *last used matte color* appears in Preview.
  - ~ If the selected background is not on Program, the menu appears with full adjustment capabilities.

The following topics are discussed in this section:

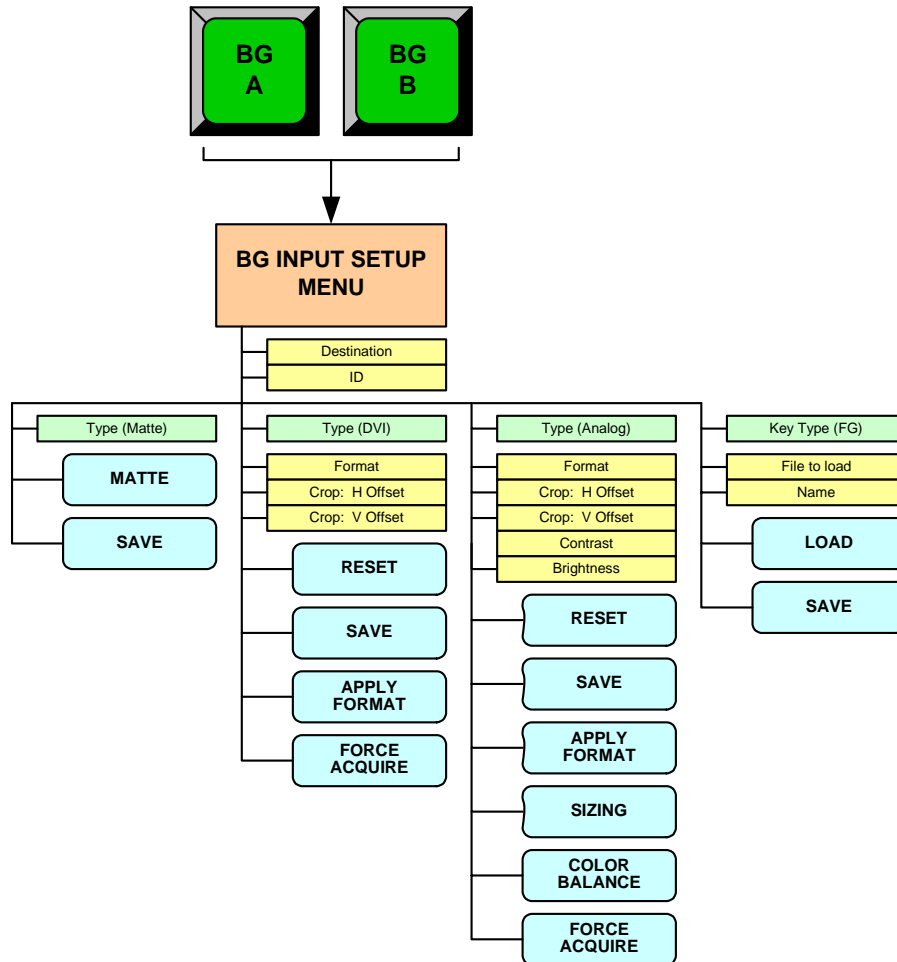
- [Background Input Setup Menu Tree](#)
- [Shared Background Menu Functions](#)
- [Background Menu Functions — Matte Type](#)
- [Background \(and DSK\) Menu Functions — DVI Type](#)
- [Background \(and DSK\) Menu Functions — Analog Type](#)
- [Background \(and DSK\) Menu Functions — FG Type](#)

## 5. Menu Orientation

### Background Input Setup Menu

## Background Input Setup Menu Tree

The figure below illustrates the **Background Input Setup Menu Tree**.



**Figure 5-74.** Background Input Setup Menu Tree

All functions and sub menus are discussed in the following sections.

## Shared Background Menu Functions

The figure below illustrates a sample **BG Input Setup Menu**, showing shared functions:

<b>BG INPUT SETUP</b>		<b>BG_A</b>	N A V
<b>Destination</b>		[ 1 ]	
<b>ID</b>	ALL		
<b>Type</b>	DVI		

**Figure 5-75.** BG Input Setup Menu (sample)

The following functions are shared — regardless of the selected background type:

- **Top Line** — indicates the selected background button: **BG\_A** or **BG\_B**.
- **Destination** — displays the currently selected destination.

**Note**

Different backgrounds can be assigned to different destinations.

- **ID** — displays the ID(s) of the selected destination's associated VP or VPx. Note that with wide screen destinations, the background for each VP or VPx can be individually adjusted.
- **Type** — selects the desired background type:
  - ~ **MATTE** — a solid color can be used as the background. Refer to the [“Background Menu Functions — Matte Type”](#) section on page 240 for menu details.
  - ~ **DVI** — a digital graphic from a computer (or other DVI source) can be used as the background. Refer to the [“Background \(and DSK\) Menu Functions — DVI Type”](#) section on page 242 for menu details.
  - ~ **Analog** — an analog graphic from a computer (or other analog source) can be used as the background. Refer to the [“Background \(and DSK\) Menu Functions — Analog Type”](#) section on page 243.
  - ~ **FG\_1, FG\_2 or FG\_3** — a frame grab can be used as the background. Refer to the [“Background \(and DSK\) Menu Functions — FG Type”](#) section on page 244 for menu details.

## 5. Menu Orientation

### Background Input Setup Menu

## Background Menu Functions – Matte Type

The figure below illustrates a sample **BG Input Setup Menu** when “**Matte**” is selected as the background type.

BG INPUT SETUP		BG_A
Destination	[ 1 ]	N A V  A D J
ID	[ ALL ]	
Type	Matte	
M A T T E		
S A V E		

**Figure 5-76.** BG Input Setup Menu — Matte Type (sample)

The following functions are provided for a **Matte** background:

- Press {**MATTE**} to display the **BG Matte Menu**. Refer to the “[BG Matte Menu](#)” section on page 241 for details.
- Press {**SAVE**} to save the selected background input configuration.

In Chapter 7, refer to the “[Background Transitions](#)” section on page 320 for instructions on how to use a background matte in place of a graphic background.



## 5. Menu Orientation

### Background Input Setup Menu

#### BG Matte Menu

From the **BG Input Setup Menu**, press {MATTE} to access the **BG Matte Menu**.

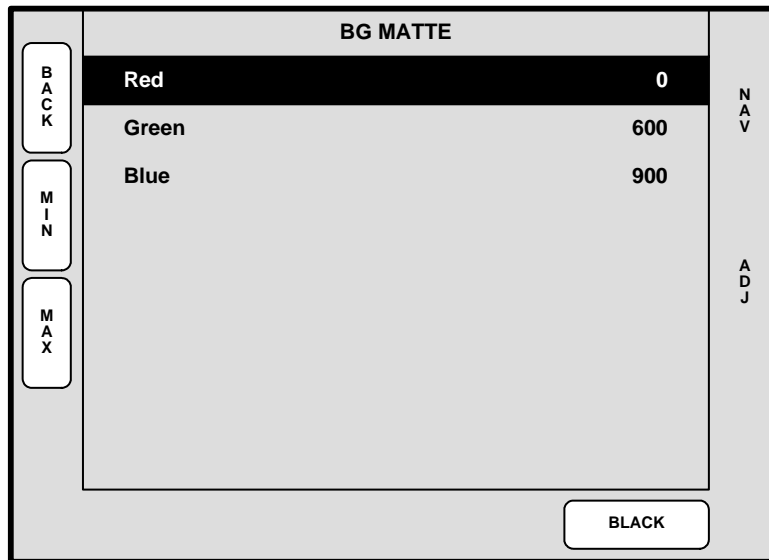


Figure 5-77. BG Matte Menu (sample)

The **Background Matte Menu** enables you to create a solid background matte color to use behind your PIPs and Keys. The system supports two separate matte colors — one for **BG\_A** and one for **BG\_B**.

- **Red** — adjusts the red component of the background matte color, from 0 to 1023.
- **Green** — adjusts the green component of the background matte, from 0 to 1023.
- **Blue** — adjusts the blue component of the background matte, from 0 to 1023.
- Press {**MIN**} to change the highlighted color to **0**.
- Press {**MAX**} to change the highlighted color to **1023**.
- Press {**BLACK**} to change all three colors to **0**.

In Chapter 7, refer to the "[Background Transitions](#)" section on page 320 for instructions on how to use a background matte in place of a graphic background.

## 5. Menu Orientation

### Background Input Setup Menu

## Background (and DSK) Menu Functions – DVI Type

The figure below illustrates a sample **BG Input Setup Menu** when “DVI” is selected as the background type.

### Note

The functions described below also apply to the **DSK Input Setup Menu**, when “DVI” is selected as the DSK type.

BG INPUT SETUP		BG_A
Destination	[ 1 ]	NAV
ID	ALL	
Type	DVI	
Format	1024 x 768 @ 59.94	ADJ
Crop: H Offset	[ 0 ]	
V Offset	[ 0 ]	

RESET

SAVE

APPLY FORMAT

FORCE ACQUIRE

Figure 5-78. BG (and DSK) Input Setup Menu — DVI Type (sample)

The following functions are provided for a **DVI** background or DSK source:

- **Format** — this line performs two functions:
  - ~ Displays the resolution that is automatically determined by the **FORCE ACQUIRE** function.
  - ~ Manually sets the resolution of the incoming source. Once the format is selected, press {**APPLY FORMAT**} to “accept” and activate the format.
- For the two **Crop** settings:
  - ~ If the source’s input resolution matches the output resolution, or if output resolution is *larger* than input resolution, **Crop** settings are bracketed.
  - ~ If input data is smaller than output resolution, the area around the active data is set to black, and input data is centered in the screen.
  - ~ If the source’s input resolution is larger than the output resolution, the **H Offset** and **V Offset** values can be used to choose which portion of the background you want to display.
  - ~ Press {**RESET**} to reset the **H** and **V** offsets to **0**.
- Press {**SAVE**} to save the selected background input configuration.
- Press {**APPLY FORMAT**} to “activate” the selected format.
- Press {**FORCE ACQUIRE**} to automatically detect the input signal resolution and update the display **Format** field accordingly.

## Background (and DSK) Menu Functions – Analog Type

The figure below illustrates a sample **BG Input Setup Menu** when “**Analog**” is selected as the background type.

### Note

The functions described below also apply to the **DSK Input Setup Menu**, when “**Analog**” is selected as the DSK type.

BG INPUT SETUP		BG_A	
Destination		[ 1 ]	NAV
ID		ALL	
Type		Analog	
Format		1024 x 768 @ 59.94	ADJ
Crop: H Offset		[ 0 ]	
V Offset		[ 0 ]	
Contrast ( % )		100.0	
Brightness ( % )		100.0	

RESET

SAVE

APPLY  
FORMAT

SIZING

COLOR  
BALANCE

FORCE  
ACQUIRE

Figure 5-79. BG (and DSK) Input Setup Menu — Analog Type (sample)

### Note

When you select **Analog** as the background type, the following message appears: **Warning! Using analog background in edge-buttred mode could possibly cause seams, and is not recommended!**

The following functions are provided for an **Analog** background or DSK source:

- **Format** — this line performs two functions:
  - ~ Displays the resolution that is automatically determined by the **FORCE ACQUIRE** function.
  - ~ Manually sets the resolution of the incoming source. Once the format is selected, press **{APPLY FORMAT}** to “accept” and activate the format.
- For the two **Crop** settings:
  - ~ If the source’s input resolution matches output resolution, or if output resolution is *larger* than input resolution, **Crop** settings will be bracketed.
  - ~ If input data is smaller than output resolution, the area around the active data is set to black, and input data is centered in the screen.
  - ~ If the input resolution is larger than the output resolution, the **H Offset** and **V Offset** values can be used to choose which portion of the background you want to display.
  - ~ Press **{RESET}** to reset the **H** and **V** offsets to **0**.

## 5. Menu Orientation

### Background Input Setup Menu

- **Contrast** — sets the input's contrast.
  - ~ **Adjustment range:** 75% to 125%
- **Brightness** — sets the input's brightness.
  - ~ **Adjustment range:** 75% to 125%
- Press {**SAVE**} to save the selected background input configuration.
- Press {**APPLY FORMAT**} to “activate” the selected format.
- Press {**SIZING**} to display the **Sizing Menu**. Refer to the “[Sizing Menu](#)” section on page 155 for details.
- Press {**COLOR BALANCE**} to display the **Color Balance Menu**. Refer to the “[Color Balance Menu](#)” section on page 157 for details.
- Press {**FORCE ACQUIRE**} to automatically detect the input signal resolution and update the display **Format** field accordingly.

## Background (and DSK) Menu Functions — FG Type

The figure below illustrates a sample **BG Input Setup Menu** when a captured frame grab (**FG\_1**, **FG\_2** or **FG\_3**) is selected as the background type.

### Note

The functions described below also apply to the **DSK Input Setup Menu**, when **FG\_1**, **FG\_2** or **FG\_3** is selected as the DSK type.

L O A D	<b>BG INPUT SETUP</b>		<b>BG_A</b>	N A V
	Destination		[ 1 ]	
	ID		ALL	
	<b>Type</b>		<b>FG_1</b>	
	File to load		10	
	Name [		Waterfall_1 ]	
S A V E			A D J	

**Figure 5-80.** BG (or DSK) Input Setup Menu — Frame Grab Type (sample)

When **FG\_1**, **FG\_2** or **FG\_3** is selected as the background (or DSK) type, a captured frame can be used as the background or DSK. This source type cannot be selected until one or more frames have been captured. Refer to the “[Frame Grab Menu](#)” section on page 245 for details.

# Frame Grab Menu

The following topics are discussed in this section:

- [Frame Grab Menu Tree](#)
- [Frame Grab Overview](#)
- [Frame Grab Menu Description](#)
- [Frame Grab Sub Menus](#)

## Frame Grab Menu Tree

The figure below illustrates the **Frame Grab Menu Tree**:

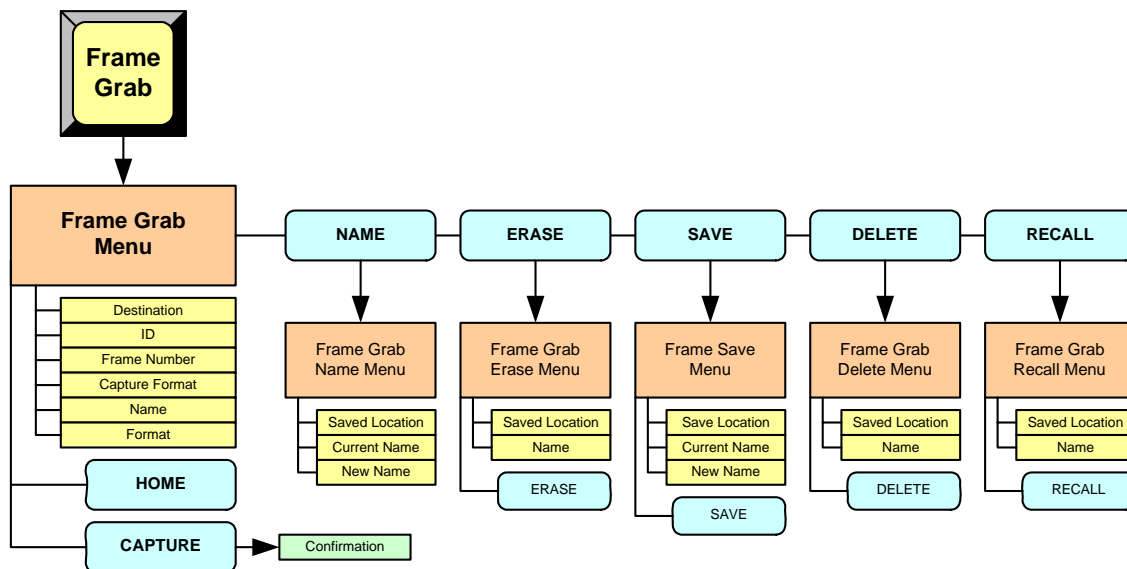


Figure 5-81. Frame Grab Menu Tree

All functions and menus are discussed in the following sections.

## 5. Menu Orientation

### Frame Grab Menu

## Frame Grab Overview

The Encore system provides complete flexibility with regard to frame grabs:

- **Temporary Frame Stores** — The Encore VP and VPx have three temporary (temp) frame stores (**FG\_1**, **FG\_2** and **FG\_3**) which function as the three sources from which “on-air” frames originate.
- **Capture Sources** — All frame grabs are *full screen* captures. A frame can be captured from **BG A**, **BG B**, the **DSK**, or any of the scaled inputs (layers).
- **Permanent Frame Stores** — As standard, the VP and VPx have 100 permanent (non-volatile) frame stores available.

In Chapter 7 refer to the “[Working with Frame Grabs](#)” section on page 355 for complete instructions on “frame grab” operations.

## Frame Grab Menu Description

The figure below illustrates a sample **Frame Grab Menu**:

FRAME GRAB	
Destination	1
ID	ALL
Frame Number	FG_1
Capture Format	[ 1280 x 1024 ]
Name [	Company Logo ]
Format	[ 1280 x 1024 ]

HOME NAME ERASE NAV ADJ CAPTURE SAVE DELETE RECALL

Figure 5-82. Frame Grab Menu (sample)

To access the **Frame Grab Menu**:

- On **Preview**, select the layer or the background source from which you want to capture a “full screen” frame.
- Press **{FRAME GRAB}** in the **Layer Functions Section**.

The **Frame Grab Menu** enables you to manage all aspects of frame grab operations. The following functions are provided:

- **Destination** — displays the currently selected destination.
- **ID** — displays the ID(s) of the selected destination’s associated Video Processor.
- **Frame Number** — selects “temp” frame stores:
  - ~ For single screen and standard wide screen systems, selects one of three “temp” frame stores (**FG\_1**, **FG\_2** or **FG\_3**). Once selected, you

## 5. Menu Orientation

### Frame Grab Menu

can capture into the selected frame store, save it to permanent memory, or download a frame grab from permanent storage for use on-air.

- ~ For “stack” systems, selects one of six “temp” frame stores:
  - For the “bottom” stack Processor, selects **BG\_FG\_1**, **BG\_FG\_2** or **BG\_FG\_3**).
  - For the “top” stack Processor, selects **DSK\_FG\_1**, **DSK\_FG\_2** or **DSK\_FG\_3**).
- **Capture Format** — displays the output resolution. Encore always captures a full screen image at the output resolution — regardless of the input resolution.
- **Name** — displays the name of the file in “temp” memory:
  - ~ **EMPTY** — the frame store is completely empty, after a factory reset has been performed.
  - ~ **UNSAVED\_FG\_[n]** — the captured frame is unsaved.
  - ~ **SAVED\_FG\_[n]** — the frame is saved in permanent memory, but it has not been assigned a custom name.
  - ~ **[NAME]** — the frame is saved in permanent memory with a custom name, up to 23 characters in length. Spaces are allowed.
- **Format** — displays the resolution of the frame in permanent memory.
- Press **{NAME}** to display the **Frame Grab Name Menu**. Refer to the “[Frame Grab Name Menu](#)” section on page 248 for details.
- Press **{ERASE}** to display the **Frame Erase Menu**. Refer to the “[Frame Erase Menu](#)” section on page 249 for details.
- Press **{CAPTURE}** to capture a frame into the selected “temporary” frame store. Once pressed, the screen indicates that the frame is being captured.
- Press **{SAVE}** to display the **Frame Save Menu**. Refer to the “[Frame Save Menu](#)” section on page 250 for details.
- Press **{DELETE}** to display the **Frame Delete Menu**. Refer to the “[Frame Delete Menu](#)” section on page 251 for details.
- Press **{RECALL}** to display the **Frame Recall Menu**. Refer to the “[Frame Recall Menu](#)” section on page 252 for details.

In Chapter 7, see the “[Working with Frame Grabs](#)” section on page 355 for details.

## Frame Grab Sub Menus

The following sub menus can be accessed from the **Frame Grab Menu**:

- [Frame Grab Name Menu](#)
- [Frame Erase Menu](#)
- [Frame Save Menu](#)
- [Frame Delete Menu](#)
- [Frame Recall Menu](#)

## 5. Menu Orientation

### Frame Grab Menu

#### Frame Grab Name Menu

The **Frame Grab Name Menu** enables you to name a frame that has been saved to permanent memory. A customer-supplied PS/2 keyboard is required (which connects to the **KEYBOARD** port on the rear of the Controller).

Select a frame (in permanent memory) on the **Frame Grab Menu**, then press **{NAME}** to display the **Frame Grab Name Menu**:

FRAME GRAB NAME	
B A C K	Saved Location 2
	Current Name: [ SAVED_FG_2 ]
	New Name: [ Company Pres ]
Enter a new name for this saved frame grab using a PS2 keyboard and hit enter to save it.	
A D J	

Figure 5-83. Frame Grab Name Menu (sample)

The following functions are provided:

- **Saved Location** — indicates the saved memory location whose frame you can name. Rotate the **ADJ** knob to select a location, and note that 100 saved locations are available.
- **Current Name** — indicates the current name of the frame at the selected “saved location.”
- **New Name** — indicates the new frame name, as entered on the PS/2 keyboard.

To name the frame, select the desired frame, enter the new name on the keyboard, and press **ENTER** on the PS/2 keyboard itself. Repeat as required to name additional frames.

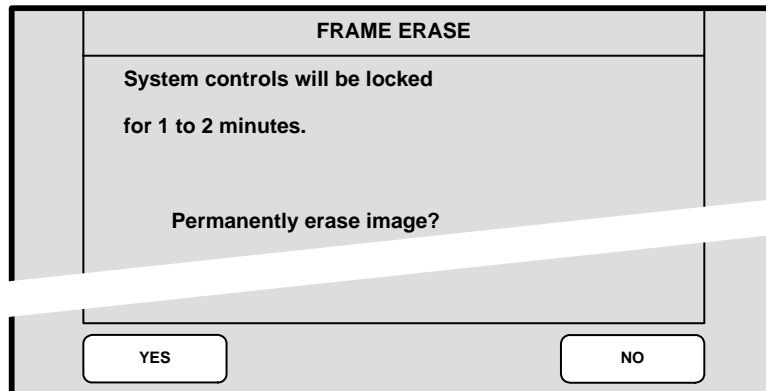


### Frame Erase Menu

The **Frame Erase Menu** enables you to *permanently* erase a selected frame. This “destructive” process (which locks the console) takes from 20 to 30 seconds.

Select a frame (in permanent memory) on the **Frame Grab Menu**, then press **{ERASE}**:

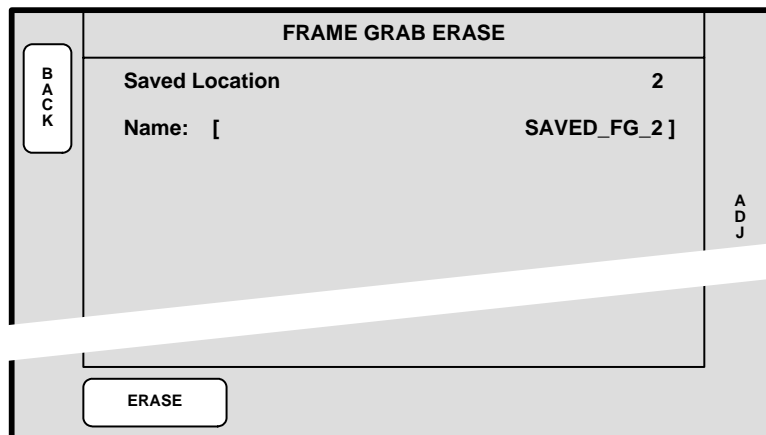
- With standard systems, the **Frame Erase Menu** appears:



**Figure 5-84.** Standard Frame Erase Menu (sample)

- ~ Press **{YES}** to erase the selected frame.
- ~ Press **{NO}** to cancel and return to the **Frame Grab Menu**.

- With “ES” systems, the **Extended Frame Erase Menu** appears:



**Figure 5-85.** Extended Frame Erase Menu (sample)

- ~ **Saved Location** — indicates the memory location whose frame you can erase. Rotate the **ADJ** knob to select a location.
- ~ **Name** — indicates the name of the frame at the selected location.
- ~ Press **{ERASE}** to erase the selected frame.

#### Caution

Use caution when erasing frames, as there is no “undo” function or “confirmation” menu.

## 5. Menu Orientation

### Frame Grab Menu

#### Frame Save Menu

The **Frame Save Menu** enables you to save a selected frame grab into permanent memory in a selected register. This process (which locks the console) takes from 1 to 2 minutes (standard systems), or from 20 to 30 seconds (“ES” systems).

Select a frame (in permanent memory) on the **Frame Grab Menu**, then press **{SAVE}**.

- With standard systems, the **Frame Save Menu** appears:

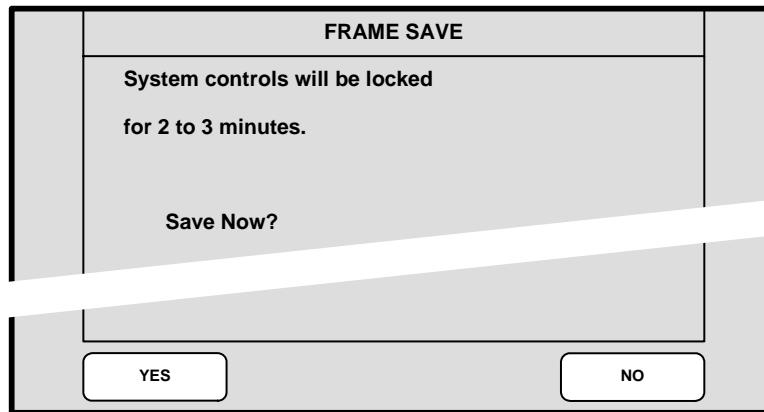


Figure 5-86. Standard Frame Save Menu (sample)

- ~ Press **{YES}** to save the selected frame in permanent memory.
- ~ Press **{NO}** to cancel and return to the **Frame Grab Menu**.

- With “ES” systems, the **Extended Frame Save Menu** appears:

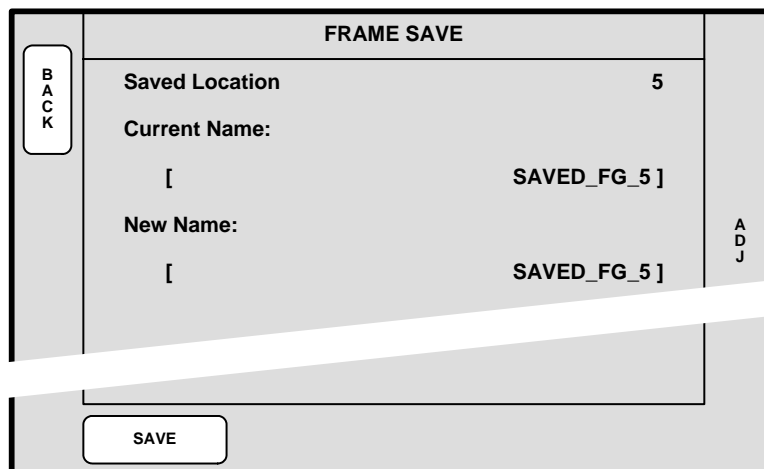


Figure 5-87. Extended Frame Save Menu (sample)

- ~ **Saved Location** — indicates the memory location whose frame you can save. Rotate the **ADJ** knob to select a location.
- ~ **Current Name** — indicates the current frame name.
- ~ **New Name** — indicates the current frame name. **If desired, type a new name with the PS/2 keyboard, to name and save simultaneously.**
- ~ Press **{SAVE}** to save the selected frame.

## Frame Delete Menu

The **Frame Delete Menu** enables you to *mark* a selected permanent frame as deleted — but the **ERASE** function is *still required* for permanent deletion. You can consider this as a “quick” delete function.

Select a frame (in permanent memory) on the **Frame Grab Menu**, then press **{DELETE}**.

- With standard systems, the **Frame Delete Menu** appears:

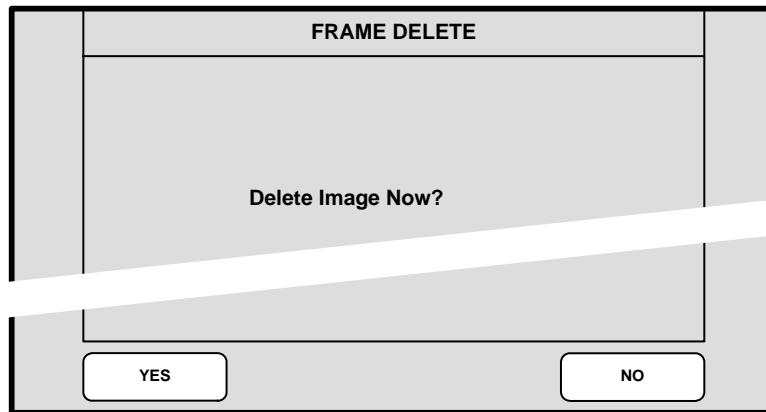


Figure 5-88. Frame Delete Menu (sample)

- ~ Press **{YES}** to delete the selected frame.
- ~ Press **{NO}** to cancel and return to the **Frame Grab Menu**.

- With “ES” systems, the **Extended Frame Delete Menu** appears:

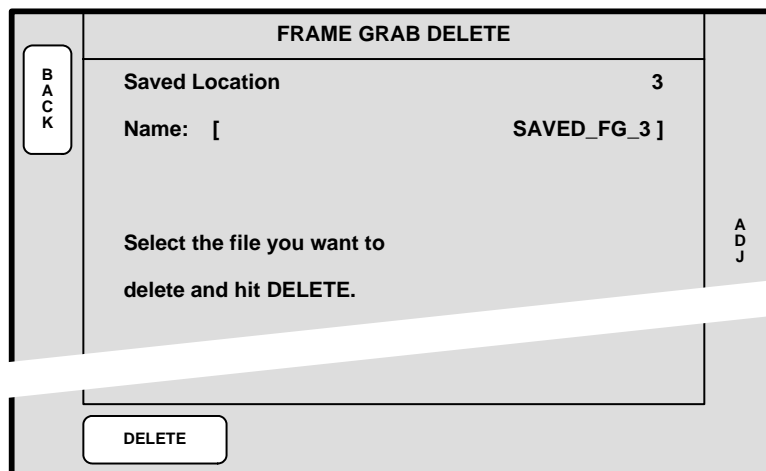


Figure 5-89. Extended Frame Delete Menu (sample)

- ~ **Saved Location** — indicates the memory location whose frame you can delete. Rotate the **ADJ** knob to select a location.
- ~ **Name** — indicates the current frame name.
- ~ Press **{DELETE}** to delete the selected frame.

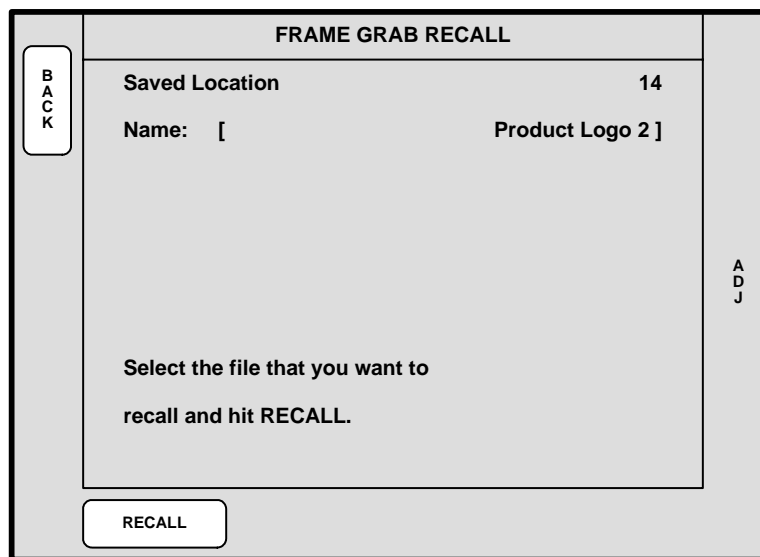
## 5. Menu Orientation

### Frame Grab Menu

#### Frame Recall Menu

The **Frame Recall Menu** enables you to recall a selected frame from permanent storage back into temporary memory.

- With standard systems:
  - ~ Select the temporary frame store into which you want to recall the associated “permanent” frame — 1 into 1, 2 into 2, etc.
  - ~ Press **{RECALL}** to recall the selected frame. The “**Recalling**” popup window appears during the procedure.
- With “ES” systems:
  - ~ Select the temporary frame store into which you want to recall a selected “permanent” frame.
  - ~ Press **{RECALL}** to display the **Frame Grab Recall Menu**:



**Figure 5-90.** Frame Grab Recall Menu (sample)

- ~ **Saved Location** — indicates the memory location whose frame you can recall. Rotate the **ADJ** knob to select a location.
- ~ **Name** — indicates the current frame name.
- ~ Press **{RECALL}** to recall the selected frame.

# DSK Menus

The following topics are discussed in this section:

- [DSK Menu Tree](#)
- [DSK Adjustment Menu](#)
- [DSK Input Setup Menu](#)

## DSK Menu Tree

The figure below illustrates the **DSK Menu Tree**.

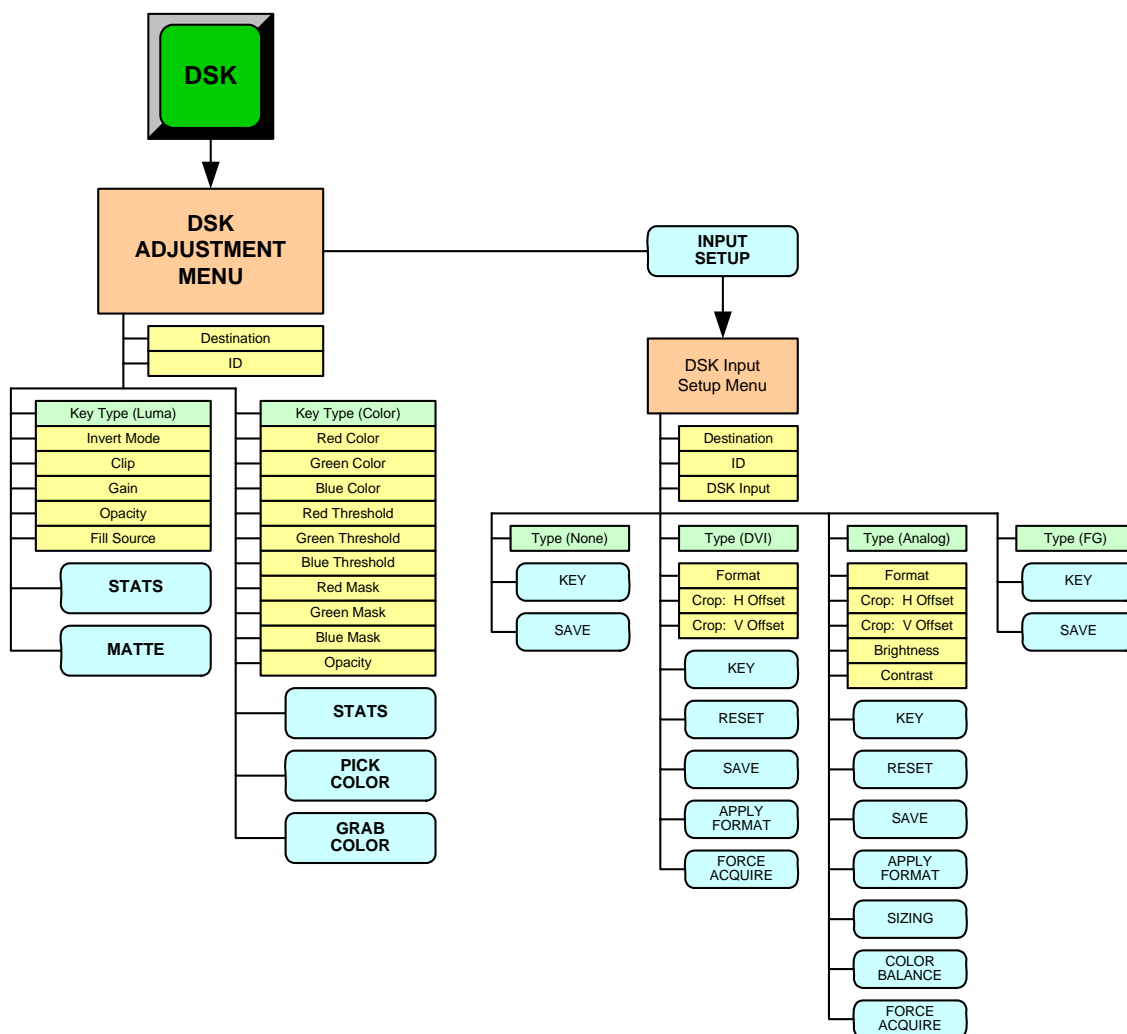


Figure 5-91. DSK Menu Tree

All functions and sub menus are discussed in the following sections.

## 5. Menu Orientation

### DSK Menus

## DSK Adjustment Menu

The **DSK Adjustment Menu** provides the tools necessary to adjust the **DSK** (Downstream Key). To access the menu:

- Press **DSK** in the **Layer Control Section**.

The available **DSK Adjustment Menu** functions *change*, depending upon the selected “**Key Type**.”

- When **Luma** is selected, you can perform a luminance DSK. Refer to the “[DSK Luma Key Functions](#)” section on page 254 for details.
- When **Color** is selected, you can perform a color DSK. Refer to the “[DSK Color Key Functions](#)” section on page 255 for details.

### DSK Luma Key Functions

A **Luma** (luminance) key is one in which the hole-cutting information is derived from the luminance (brightness) level of the key source. The figure below illustrates the **DSK Adjustment Menu** when **Luma** key is selected:

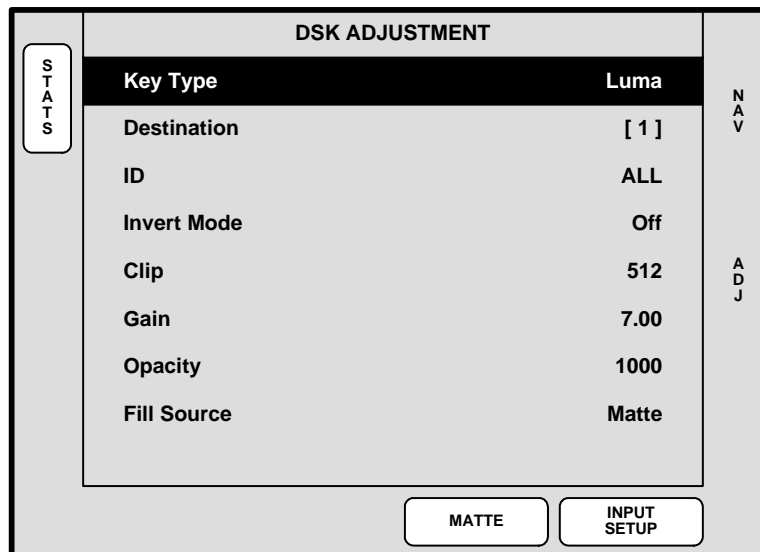


Figure 5-92. DSK Adjustment Menu — Luma (sample)

The following **DSK Adjustment Menu** functions are provided when **Luma** is selected as the DSK type:

- **Key Type** — displays the currently selected DSK type.
- **Destination** — displays the currently selected destination (if a single destination is selected) or enables you to select a destination (if multiple destinations are enabled).
- **ID** — displays the ID of the selected destination’s associated Video Processor.
- **Invert Mode** — inverts the DSK signal.
- **Clip** — adjusts the threshold of the video that “cuts” into the background image. A hole will be cut into the background anywhere that foreground luminance is greater than the clip level. The hole is then filled with the **Fill Source**.

~ **Adjustment range:** 0 to 1023

- **Gain** — adjusts the sensitivity of the keyer, enabling you to change the sharpness of the keyed image. Gain only affects the key hole, as set by the clip.
  - ~ **Adjustment range:** 0 to 1023.99
- **Opacity** — adjusts the opacity of the keyed image, from fully opaque to fully transparent.
  - ~ **Adjustment range:** 0 to 1024
- **Fill Source** — determines the video that fills the DSK hole:
  - ~ **Self** — fills the hole with the DSK source video itself, such as the video from a character generator.
  - ~ **Matte** — fills the hole with a matte color, which can be adjusted with the **DSK Matte Adjustment Menu**. Refer to the [“Matte Menu”](#) section on page 228 for details.
- Press {**STATS**} to display the **Status Menu**. Refer to the [“Status Menu”](#) section on page 212 for details.
- Press {**INPUT SETUP**} to display the **DSK Input Setup Menu**. Refer to the [“DSK Input Setup Menu”](#) section on page 257 for details.

### DSK Color Key Functions

A **Color** key is one in which the hole-cutting information is derived from a specific RGB value — including luminance. The figure below illustrates the **DSK Adjustment Menu** when **Color** key is selected:

DSK ADJUSTMENT		
Key Type	Color	
Destination	[ 1 ]	NAV
ID	ALL	
Red Color	1000	ADJ
Green Color	200	
Blue Color	200	
Red Threshold	100	
Green Threshold	100	
Blue Threshold	100	

STATS

PICK COLOR

INPUT SETUP

**Figure 5-93.** DSK Adjustment Menu — Color (sample)

The following **DSK Adjustment Menu** functions are provided when **Color** is selected as the DSK type:

- **Destination** — displays the currently selected destination.
- **ID** — displays the ID of the selected destination’s associated Encore.
- **Red Color** — adjusts the red component of the DSK color, from 0 to 1024.
- **Green Color** — adjusts the green component of the DSK color, from 0 to 1024.

## 5. Menu Orientation

### DSK Menus

- **Blue Color** — adjusts the blue component of the DSK color, from 0 to 1024.
- **Red Threshold** — adjusts the DSK's clip along the Cyan vector (as demonstrated using a CIE color chip chart).
- **Green Threshold** — adjusts the DSK's clip along the Magenta vector.
- **Blue Threshold** — adjusts the DSK's clip along the Yellow vector
- **Red Mask** — adjusts the background mask to/from black along the Cyan vector.
- **Green Mask** — adjusts background mask to/from black along the Magenta vector.
- **Blue Mask** — adjusts background mask to/from black along the Yellow vector.
- **Opacity** — adjusts the opacity of the keyed image, from fully opaque to fully transparent. Adjustment range is 0 to 1024.
- Press {**STATS**} to display the **Status Menu**. Refer to the "[Status Menu](#)" section on page 212 for details.
- Press {**PICK COLOR**} to choose the keying color visually. Once pressed, the {**GRAB COLOR**} label appears, and a crosshair appears on Preview. Use the Joystick to move the crosshair around the Preview monitor as desired.
- Press {**GRAB COLOR**} to select the color directly under the crosshair. These values are immediately mapped into the **Red**, **Green** and **Blue** color fields on the menu, and can be adjusted with the knobs in the normal manner.
- Press {**INPUT SETUP**} to display the **DSK Input Setup Menu**. Refer to the "[DSK Input Setup Menu](#)" section on page 257 for details.



## DSK Input Setup Menu

The figure below illustrates a sample **DSK Input Setup Menu**:

DSK INPUT SETUP		
Destination	[ 1 ]	NAV
ID	ALL	
DSK Input	1B	
Type	DVI	ADJ
Format	1280 x 1024 @60	
Crop: H Offset	0	
V Offset	0	
<div style="display: flex; justify-content: space-between;"> <div style="border: 1px solid black; padding: 2px;">KEY</div> <div style="border: 1px solid black; padding: 2px;">RESET</div> <div style="border: 1px solid black; padding: 2px;">SAVE</div> </div>		
APPLY FORMAT		FORCE ACQUIRE

**Figure 5-94.** DSK Input Setup Menu (sample)

The **DSK Input Setup Menu** enables you to set up the DSK input. The menu *changes* depending on the selected input “type.”

The following three menu functions are shared — regardless of the selected DSK type:

- **Destination** — displays the currently selected destination.
- **ID** — displays the ID(s) of the selected destination’s associated Video Processor.
- **DSK Input** — enables you to select the input connector from which the DSK source is pulled.

The following function changes the menu parameters:

- **Type** — selects the desired DSK type:
  - ~ **None** — the DSK circuitry for a selected Processor (as chosen with the **ID** field), is off.

### Tip

This selection is recommended when a DSK is only needed on the last screen in a widescreen configuration (such as a bug), and when only a single head graphics card is required.

- ~ **DVI** — a digital graphic from a computer or other DVI source is the DSK Source. Refer to the [“Background \(and DSK\) Menu Functions — DVI Type”](#) section on page 242.

### Note

When “**DVI**” is selected, the available functions are virtually identical to those on the **BG Input Setup Menu** — when “**DVI**” is selected as the background type.

## 5. Menu Orientation

### DSK Menus

- ~ **Analog** — an analog graphic from a computer or other analog source is the DSK source. Refer to the “[Background \(and DSK\) Menu Functions — Analog Type](#)” section on page 243.

**Note**

When “**Analog**” is selected, the available functions are virtually identical to those on the **BG Input Setup Menu** — when “**Analog**” is selected as the type.

- ~ **FG\_1, FG\_2, FG\_3** — a temporary frame store is the DSK source. Refer to the “[Background \(and DSK\) Menu Functions — FG Type](#)” section on page 244 for menu details.

**Note**

When **FG\_1, FG\_2** or **FG\_3** is selected, the available functions are virtually identical to those on the **BG Input Setup Menu** — when **FG\_1, FG\_2** or **FG\_3** is selected as the background type.

Once you have reviewed all of the sections in this chapter, please continue with Chapter 6, “[System Setup](#)” on page 259.

# 6. System Setup

---

## In This Chapter

This chapter provides comprehensive instructions for setting up the Encore system. The following topics are discussed:

- [Setup Prerequisites](#)
- [System Setup Sequence](#)
- [ID Setup and Remote Enable](#)
- [Peripheral Power Up and Status Check](#)
- [Return to Factory Default](#)
- [Touch Screen Calibration](#)
- [Programming EDID](#)
- [Restore from Flash Memory Card](#)
- [Router Setup](#)
- [D/A Setup](#)
- [Input Patching](#)
- [Destination Setup](#)
- [AUX Destination Setup](#)
- [Output Format Setup](#)
- [Sync Setup](#)
- [Genlock Setup](#)
- [Projector Setup](#)
- [Background Setup](#)
- [Input Setup](#)
- [DSK Setup](#)
- [Saving the Setup](#)
- [Back up System](#)

**Note**

Once you have reviewed all of the sections in this chapter, please continue with Chapter 7, "[Operations](#)" on page 301.

## 6. System Setup

### Setup Prerequisites

---

## Setup Prerequisites

Before starting to set up your Encore system, please review the following prerequisites:

- Ensure that you are familiar with all Encore system hardware. Refer to Chapter 2, "[Hardware Orientation](#)" on page 43 for details.
- Ensure that hardware is properly installed, and that all sources, routers and peripherals are properly connected. Refer to Chapter 3, "[Hardware Installation](#)" on page 61 for details.
- Ensure that you are familiar with all parts of the Controller — including the functions of all buttons within the various sections. Refer to Chapter 4, "[Controller Orientation](#)" on page 107 for details.
- Ensure that you are familiar with all Encore menus and sub-menus. Refer to Chapter 5, "[Menu Orientation](#)" on page 145 for details.
- Ensure that your connection charts are complete, and readily available for reference throughout this chapter. In Chapter 3, refer to the "[Connection Charts](#)" section on page 89 for details.

Please note:

- In this chapter, when a procedure tells you to "**scroll to**" a certain line, use the rotary knob labelled **NAV** to move the highlight.
- When a procedure tells you to "**adjust**" or "**select**" a certain parameter, use the **ADJ** rotary knob.

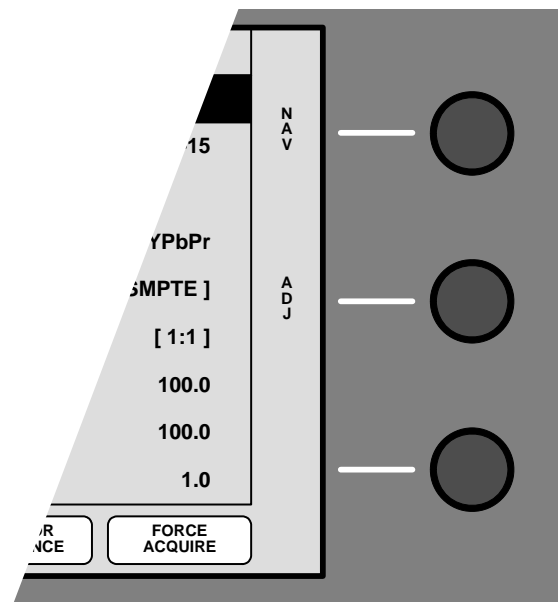


Figure 6-1. Menu Navigation

---

## System Setup Sequence

This section provides a top level view of the entire Encore setup procedure, plus links to each individual sequence.

### Important

For the optimum Encore setup, it is recommended that you follow all procedures in the order outlined below.

- Preliminary steps:
  1. [“ID Setup and Remote Enable,”](#) page 262.
  2. [“Peripheral Power Up and Status Check,”](#) page 264.
  3. [“Return to Factory Default,”](#) page 266.
- Next, set up all menus under the **MISC** heading:
  4. [“Touch Screen Calibration,”](#) page 267.
  5. [“Programming EDID,”](#) page 268.
  6. [“Restore from Flash Memory Card,”](#) page 269.
- Next, set up all menus under the **System** heading:
  7. [“Router Setup,”](#) page 270. Router setup
  8. [“D/A Setup,”](#) page 274. D/A setup
  9. [“Input Patching,”](#) page 275. Input Patching
  10. [“Destination Setup,”](#) page 277. Destination Setup
  11. [“AUX Destination Setup,”](#) page 281. Aux Destination Setup
- Next, set up all menus under the **Output** heading:
  12. [“Output Format Setup,”](#) page 285.
  13. [“Sync Setup,”](#) page 286.
  14. [“Genlock Setup,”](#) page 287.
  15. [“Projector Setup,”](#) page 288.
- Set up all background inputs, all primary sources and the DSK:
  16. [“Background Setup,”](#) page 291.
  17. [“Input Setup,”](#) page 293.
  18. [“DSK Setup,”](#) page 296.
- To complete your setup:
  19. [“Saving the Setup,”](#) page 299.
  20. [“Back up System,”](#) page 300.

All of the above procedures are covered in the following sections.

## 6. System Setup

### ID Setup and Remote Enable

---

# ID Setup and Remote Enable



Encore system setup: **Step 1.**

In this procedure, you will set up individual Encore Video Processor IDs. If ScreenPRO-II, PresentationPRO-II and/or ImagePRO units are used as destinations, you will also set their IDs and enable remote control. Each unit in your system must have a unique ID.

■ Use the following steps to set up IDs and remote control:

1. Power up your Encore Controller, and allow it to fully boot up. This is the system's DHCP server.
2. To set Encore Video Processor IDs:
  - a. Using the **Unit ID Selector** on the rear of each Processor, set the desired **ID**. Logical IDs **1 - 16** are available.
  - b. If you elect to use "extended" IDs 17 - 32, use the **Video Processors ID Definition Menu** to redefine the IDs. In Chapter 5, refer to the "[Video Processors ID Definition Menu](#)" section on page 202 for details.

#### Important

If you are setting up a "stack" configuration, the ID of the bottom stack Video Processor must always be lower than the ID of the top stack Processor.

- c. Repeat step **3** for all other Video Processors in your system.
3. Power up all Encore Video Processors, ScreenPRO-II units, PresentationPRO-II units and ImagePRO units in your system. This sequence enables the Encore Controller to "serve" IP addresses to the Processors and other peripherals.
4. To set ScreenPRO-II and PresentationPRO-II IDs and enable remote control:
  - a. Ensure that the ScreenPRO-II and PresentationPRO-II units are connected to the same Ethernet Switch as the Video Processor(s).
  - b. Press **{REMOTE CONTROL}** on the **Home Menu** to access the **Remote Control Menu**.
  - c. Scroll to the **Unit ID** line, and select a unique ID. The ID range is **1 to 32**.
  - d. Scroll to the **Remote Control/DHCP** line, and enable remote control.

#### Note

When remote control is on, the **{HOME}** buttons disappears, the ScreenPRO-II (or PresentationPRO-II) front panel is disabled, and the unit's IP address is dynamically assigned. All control now originates from Encore's console.

- e. Press **{SAVE}** to save the system state in non-volatile memory — so that it will return to it should power need to be cycled.
      - f. Repeat step **4** for all other ScreenPRO-II and PresentationPRO-II units in your system.
5. To set ImagePRO IDs and enable remote control:
  - a. Ensure that the ImagePRO units are connected to the same Ethernet Switch as the Video Processor(s).

## 6. System Setup

### ID Setup and Remote Enable

- b. Ensure that the ImagePRO is running software version 2.30 or greater.
  - To verify, press **SETUP > TECH SUPPORT** to display the **Tech Support Menu**. The version is listed on line 2.
  - Press **ESC** repeatedly to return to the top level.
- c. Set the ImagePRO's output resolution.
  - Press **SETUP > OUTPUT** to display the **Output Menu**.
  - On the output resolution line, press **SEL** to select the desired resolution, then press **SEL** to accept.
  - Scroll to the **SAVE CONFIG** line and press **SEL** to save the output configuration.
  - Press **ESC** repeatedly to return to the top level.
- d. Press **SETUP > SYSTEM > ETHERNET** to display the **Ethernet Menu**.
- e. On the **MODE** line, enable the function. Once enabled, a message appears that the unit is searching for a DHCP server.
- f. Scroll to the **DHCP** line, and verify that DHCP is enabled. If not, enable this function.
- g. On the **IP** line, confirm that an IP address has been received from the Encore Controller.
- h. Scroll to the **REMOTE CONTROL** line and press **SEL** to display the **Barco Remote Control Menu**.
- i. Scroll to the **ID** line and set a unique ID for the unit.
- j. Scroll to the **CONNECT** line and enable this function. Once enabled, a message appears that the unit is attempting to connect, followed by a message that a connection has been established.

#### Note

When remote control is on, the unit's input switching buttons are disabled, but you can still navigate through the menus. All switching control now originates from Encore's console.

- k. Scroll to the **SAVE CONFIG** line and press **SEL** to save the remote control configuration.
- l. Press **ESC** repeatedly to return to the top level.
- m. Repeat step 5 for all other ImagePRO units in your system.

## 6. System Setup

### Peripheral Power Up and Status Check

---

# Peripheral Power Up and Status Check

2

Encore system setup: **Step 2.**

■ Use the following steps to power up your routers and check system status:

1. Power up all routers in your system, and allows them to fully boot up. These are your devices with static IP addresses.

#### Note

If Barco **MatrixPRO** series routers are connected and powered on first, before the Controller, they will be automatically "discovered" by the Controller.

2. Power up all additional peripherals, such as monitors and projectors.
3. Check the **Encore System Status Menu**, and ensure that all devices have been recognized. By default, this menu should appear at power up. If it is not shown, press **STATUS** in the **System Keypad**.
4. **Check code compatibility** — when the Encore Controller connects to the Video Processor(s), ScreenPRO-II units and PresentationPRO-II units, it automatically checks the compatibility of the code versions.
  - ~ If the Controller's code version matches that of the Video Processor(s), ScreenPRO-II units and PresentationPRO-II units, the **System Status Menu** is shown — and you do not need to download code.
  - ~ If the message "**Checksum Mismatch**" appears on the **System Status Menu**, it is *highly recommended* that you download code. However, if the Controller buttons are *not* flashing, then the code is compatible and therefore usable. Please continue with the "[Downloading Code](#)" procedure on page 265.
  - ~ If the Controller's code version is *incompatible* with the code version of a Video Processor, a ScreenPRO-II or a PresentationPRO-II (or a combination of units), all buttons will flash on the Controller console. The **System Status Menu** is shown with the message "**Please Upgrade.**" Please continue with the "[Downloading Code](#)" procedure on page 265.



## Downloading Code

When an incompatibility exists between software code versions, all buttons will flash on the Controller console. In this situation, the **System Status Menu** automatically appears with the message **"Please Upgrade."**

- Use the following steps to download code from the Controller to the target device(s), including Video Processors, ScreenPRO-II units and PresentationPRO-II units:
  1. On the Encore Controller console, press **SYSTEM > {SW VER}** to display the **Software Version Menu**. Any incompatibilities will be listed.

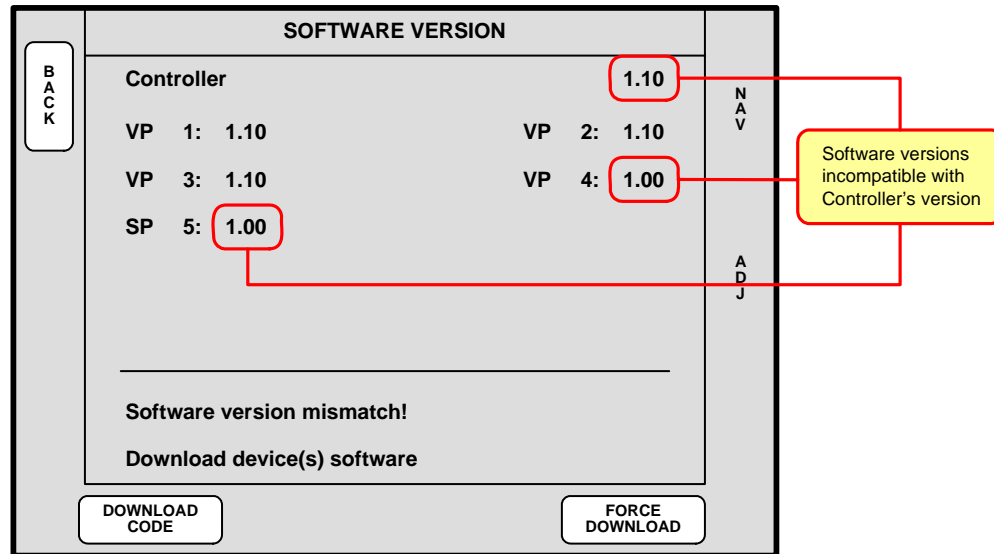


Figure 6-2. Software Version Menu (sample)

2. Press **{DOWNLOAD CODE}** to begin the download process, which takes several minutes to complete.

During the procedure, several "progress" messages are shown. When the entire procedure is complete, the **Download Code Results Menu** displays a summary of the download. Please note:

- ~ Results may appear on multiple pages.
- ~ If required, press **{PG DN}** and **{PG UP}** to move between pages.
- ~ Press **{DETAILS}** to view additional information for a specific download.

3. After the upgrade process is complete, perform a complete factory reset on the Controller and any Processors and/or ScreenPRO-IIs that the Controller detects. Refer to the ["Return to Factory Default"](#) section on page 266 for instructions.

At the conclusion of the procedure, each Video Processor, ScreenPRO-II, and PresentationPRO-II is running the same version of code as the Encore Controller.

## 6. System Setup

Return to Factory Default

---

# Return to Factory Default

3

Encore system setup: **Step 3.**

Prior to performing any setup procedures, it is recommended that you perform a factory reset — in order to reset all router tables and source mappings. The procedure guarantees that any previous setups (e.g., those that may have been programmed by other users), do not remain in system memory.

▲ **Prerequisite** — Ensure that you are familiar with the **Reset Menu**. In Chapter 5, refer to the “[System Reset Menu](#)” section on page 175.

■ Use the following steps to return the system to factory default values:

1. In the **System Keypad**, press **SYSTEM** to display the **System Menu**.
2. Press {**RESET**} to display the **Reset Menu**.
3. On the **Device** line, select **CTRLR + VP + SP**.
4. On the **Reset Option** line, select **All VPs and SPs**.
5. On the **Reset Type** line, select **FACTORY**.
6. Press {**RESET**}. When the **Reset Confirmation** screen appears, press {**YES**} to delete all user configurations and reset the system to factory default values.

---

# Touch Screen Calibration

## 4

Encore system setup: **Step 4.**

The calibration procedure is an excellent starting point prior to setup.

▲ **Prerequisite** — Ensure that you are familiar with the **LCD Settings Menu**. In Chapter 5, refer to the “[LCD Settings Menu](#)” section on page 203.

■ Use the following steps to calibrate your Touch Screen display(s):

1. In the **System Keypad**, press **MISC** to display the **Miscellaneous Menu**.
2. Press **{LCD SETTINGS}** to display the **LCD Settings Menu**.
3. Press **{LCD CAL}** to display the **Touch Screen Calibration Menu**.
4. **(Controller LC only)** On the top **LCD** line, select the LCD touchscreen that you want to calibrate.
5. Follow the directions on the menu to complete the calibration procedure.
6. **(Controller LC only)** Repeat steps 1 through 5 for the other LCD touchscreen.
7. For both Controllers, use the controls on the **LCD Settings Menu** to adjust brightness and contrast as desired.

## 6. System Setup

### Programming EDID

# 5

Encore system setup: **Step 5**

The EDID (Extended Display Identification Data) programming procedure is a prerequisite for background and DSK setup. The procedure guarantees proper communications at the preferred resolution between Encore's DVI inputs and your system's PCs.

▲ **Prerequisite** — Ensure that you are familiar with the **EDID DVI Input Format Menu**. In Chapter 5, refer to the "[EDID DVI Input Format Menu](#)" section on page 200.

■ Use the following steps to program Encore's EDID:

1. Ensure that Encore's output format matches your projector's native resolution. In Chapter 5, refer to the "[Output Menu Functions](#)" section on page 160 for details.
2. Ensure that the computer(s) that you wish to use as background and DSK source(s) are capable of supporting the selected output resolution.
3. Ensure that all DVI inputs to each Video Processor are disconnected.
4. In the **System Keypad**, press **MISC** to access the **Miscellaneous Menu**.
5. Press **{EDID}** to display the **EDID DVI Input Format Menu**.
6. On the **Destination** line, select the individual destination whose EDID you wish to program, or select **ALL** if all destinations will be using the same resolution.
7. Note the **Current EDID format** line, which displays the EDID format that resides in memory. If this format is *already* set to the desired resolution, no programming is required. You can exit this procedure, and continue with the next setup step.
8. If a new resolution is required, scroll to the **Format** line and use the **ADJ** knob to select the preferred EDID format.
9. Press **{PROGRAM EDID}** to display a warning message. Press **{CONTINUE}** to continue with the procedure.
10. Once EDID programming is complete, reconnect each external computer and power it back on.
11. On each PC's desktop, right-click to display the **Display Properties Window**.
12. Select the **Settings Tab**, and verify that the PC's resolution matches that which you just programmed into EDID. If not, set the resolution as required.
13. Repeat steps **6** through **12** for each additional Encore destination.

---

# Restore from Flash Memory Card

## 6

Encore system setup: **Step 6** (optional)

In this procedure, you will restore your system configuration from flash memory — provided that you previously backed up your system to the flash memory card.

▲ **Prerequisite** — Ensure that you are familiar with the **Backup/Restore Menu**. In Chapter 5, refer to the [“Backup/Restore Menu”](#) section on page 206 for details.

■ Use the following steps to restore your system from the flash memory card:

1. Ensure that your flash memory card is properly inserted in the Controller's **MEMORY CARD** slot.
2. In the **System Keypad**, press **MISC** to access the **Miscellaneous Menu**.
3. Press **{BACKUP RESTORE}** to display the **Backup/Restore Menu**.
4. Press **{CHECK CARD}** to display the **Current Backup Menu**.
  - ~ Check the **“Controller files backed up”** section to confirm the types of files present on the Flash Memory Card (e.g., System, Presets, ScreenPRO-II).
  - ~ Check the **“VP/SPs backed up”** section to confirm the IDs of the processors that are backed up.
  - ~ Press **{BACK}** to return to the **Backup/Restore Menu**.
5. On the **Device** line, select **Ctrl+VP+SP** to perform a complete “restore.”
6. On the **Controller Options** line, select **All**.
7. On the **VP/SP to Restore** line, select **All**.
8. Press **{RESTORE}** to restore the selected system configuration.

At the conclusion of this procedure, your system is completely set up — exactly the way that you left it when you performed a complete system “backup.” No further setup operations are required.

Please continue with system operations. Refer to the [“Operations”](#) chapter on page 301 for details.

## 6. System Setup

### Router Setup

---

# Router Setup

## 7

Encore system setup: **Step 7**

- ▲ **Prerequisites** — Ensure that you are familiar with the following menus:
  - ~ **Router Specification Menu.** In Chapter 5, refer to the “[Router Specification Menu](#)” section on page 190.
  - ~ **Comm Setup Menu.** In Chapter 5, refer to the “[Comm Setup Menus](#)” section on page 191.
  - ~ **Output Patch Menu.** In Chapter 5, refer to the “[Output Patch Menu](#)” section on page 194.

■ Use the following steps to set up your system’s routers:

1. Ensure that your router(s) are properly connected to the Encore system. In Chapter 3, refer to the “[Installation](#)” section on page 64 for details.
2. For Ethernet controlled routers, ensure that your router’s protocol is supported. The list of supported manufacturers currently includes the Folsom MatrixPro series, and routers from Sierra, Extron, Leitch, Isis, DVILink and DPI.
3. For Ethernet controlled routers, ensure that you know each router’s IP address. If required, preset the IP addresses at the routers themselves. Refer to each router’s **User’s Guide** for instructions.

Note that **MatrixPRO** routers default to the following IP addresses:

- ~ MatrixPRO Analog Router: **192.168.0.241**
- ~ MatrixPRO SDI Router: **192.168.0.242**
- ~ MatrixPRO DVI Router: **192.168.0.243**

4. In the **System Keypad**, press **SYSTEM** to display the **System Menu**.
5. Press **{ROUTER SETUP}** to display the **Router Specification Menu**.
6. On the **Number** line, select the number that you wish to assign to this router.

### Note

This is an arbitrary number used for associating the router with a configuration file. Encore provides an available “pool” of 8 devices from which you can assign routers and D/As.

7. On the **Manufacturer** line, select the router manufacturer.
8. On the **Router Type** line, select the type of router being used.
9. On the **Number of Inputs** line, select the router’s input count.
10. On the **Number of Outputs** line, select the routers’ output count.
11. On the **Communication Type** line, select the type of communication that you are using to connect to the router: **RS-232**, **Ethernet** or **Lantronix**.
12. Press **{ADD NEW}** to save the router’s specification.
13. Press **{COMM SETUP}** to display the appropriate communications setup menu for the selected device.
14. For Ethernet controlled routers, verify that the **IP Address** field matches the router’s IP address. If not, use the **ADJ** knob in conjunction with the **{NEXT IP QUAD}** button to change the address as required.

## 15. Test communications:

- ~ For serial and Ethernet controlled routers, press **{TEST COMM}**.
- ~ For Lantronix devices, press **{DISCOVER LTRX}**. Note that **{TEST COMM}** can be used for Routers connected to Lantronix devices once the Lantronix device has been discovered and properly set up.

**Note**

If the message “**Communication Failed**” appears, take the necessary actions to rectify the communications error and repeat this step.

16. Press **{BACK}** to return to the **Router Specification Menu**.17. Press **{OUTPUT PATCH}** to display the **Output Patch Menu** for the selected router. On the top line, confirm the router name.**Standard (non-stack) configurations** — please note:

- ~ On a **3 M/E** Video Processor, the first six router outputs have been automatically patched to inputs **1A** through **3B** respectively.
- ~ On a **2 M/E** Video Processor, the first four router outputs have been automatically patched to inputs **1A** through **2B** respectively.
- ~ On a **1 M/E** Video Processor, the first two router outputs have been automatically patched to inputs **1A** and **1B**.

The table below illustrates the default router output patch for standard (non-stack) configurations:

**Table 6-1.** Default output patch table — standard configurations

Router Output	VP Input	Mixer Layer
1	1A	3A
2	1B	3B
3	2A	2A
4	2B	2B
5	3A	1A
6	3B	1B
7	Undefined	Undefined
8	Undefined	Undefined

If you have a **Folsom MatrixPro Router** and you connect the router outputs per the table above, *no setup is necessary* on the **Output Patch Menu** — unless you specifically want to patch the outputs in a different way. This “default” configuration is ideal for most single-screen applications with one Processor, or wide screen applications with multiple Processors.

## 6. System Setup

### Router Setup

**Stack configurations** — please note:

- ~ When using a router with a single or wide screen “stack” configuration, router outputs are required to go to all physical inputs for both the bottom and top Processors, provided that all inputs are required to go to any available layers.

The table below illustrates the default router output patch for a “stack” configuration, where VP 2 is the “Top” Processor, and VP 1 is the “Bottom” Processor:

**Table 6-1.** Default output patch table

Router Output	VP ID	VP Input	Mixer Layer
1	2	1A	6A
2	2	1B	6B
3	2	2A	5A
4	2	2B	5B
5	2	3A	4A
6	2	3B	4B
7	1	1A	3A
8	1	1B	3B
9	1	2A	2A
10	1	2B	2B
11	1	3A	1A
12	1	3B	1B

18. To patch router outputs, use the following steps:
  - a. On the **Router Output** line, select the output that you want to patch.
  - b. If you are uncertain about the current patch, or if you want to remove the current (existing) patch and start clean, press **{DELETE PATCH}**.
  - c. On the **Device ID** line, select the Encore Processor or ScreenPRO-II ID to which you want to patch the selected router output.
  - d. On the **VP Input** line, select the specific Encore Processor or ScreenPRO-II input to which you want to patch the selected output.
  - e. Press **{ADD PATCH}** to confirm your changes. The new “mapping” appears on the menu.
  - f. Repeat step 18 for all remaining router outputs that you wish to patch.
19. To designate a router output as an “Aux” output:
  - a. On the **Router Output** line, select the specific output that you want to designate as an Aux output.
  - b. If you are uncertain about the current patch, or if you want to remove the current (existing) patch and start clean, press **{DELETE PATCH}**.
  - c. On the **Device ID** line, select **None**.
  - d. Press **{ADD PATCH}** to confirm the change.



## 6. System Setup

### Router Setup

- e. Repeat step 19 to designate additional Aux outputs.
- 20. Press **{BACK}** to return to the **Router Specification Menu**.
- 21. Repeat from step 6 for the next router that you wish to assign.
- 22. When you have configured all of your system's routers, on the **Router Specification Menu**, scroll to the **Number** line, and scan through the remaining router numbers. Other than the ones which you just assigned, if there are *any* router numbers that do not say **<EMPTY>** on the **Number** line, press **{DELETE ROUTER}** to remove the specification from the system.
- 23. In the **System Keypad**, press **SAVE** to save the current configuration.

#### Note

When you press the **SAVE** button, router specifications will be saved only if changes have not previously been written to Flash memory.

## 6. System Setup

### D/A Setup



Encore system setup: **Step 8**

- ▲ **Prerequisites** — Ensure that you are familiar with the following menus:
  - ~ **Router Specification Menu.** In Chapter 5, refer to the “[Router Specification Menu](#)” section on page 190.
  - ~ **Output Patch Menu.** In Chapter 5, refer to the “[Output Patch Menu](#)” section on page 194.

- Use the following steps to set up a D/A (Distribution Amplifier):
  1. Ensure that the outputs from the analog, SDI or DVI D/A that you wish to set up are properly (physically) connected to the desired Video Processor or ScreenPRO-II inputs. There are no communications connections required from Encore to the D/A.
  2. In the **System Keypad**, press **SYSTEM** to display the **System Menu**.
  3. Press **{ROUTER SETUP}** to display the **Router Specification Menu**.
  4. On the **Number** line, select the number that you wish to assign to the D/A.

#### Note

This is an arbitrary number used for associating the D/A with a configuration file. Encore provides an available “pool” of 8 devices from which you can assign routers and D/As.

5. Press **{DELETE ROUTER}** to clear any existing specification from memory.
6. On the **Router Type** line, select the type of D/A that you wish to set up (e.g., D/A SDI, D/A ANALOG). The **Number of Inputs** line defaults to **[1]**.
7. On the **Number of Outputs** line, set the number of D/A outputs available.
8. Press **{ADD NEW}** to save the D/A's specification.
9. Press **{OUTPUT PATCH}** to display the **Output Patch Menu** for the selected D/A.
10. On the **Router Output** line, select the D/A output that you want to patch.
11. On the **Device ID** line, select the Video Processor or ScreenPRO-II **ID** to which you want to patch the selected D/A output.
12. On the **VP Input** line (or the **SP Input** line), select the specific Video Processor or ScreenPRO-II input to which you want to patch the selected D/A output.
13. Press **{ADD PATCH}** to confirm your changes.
14. Repeat steps **10** through **13** for all remaining D/A outputs that you wish to patch.
15. Press **{BACK}** to return to the **Router Specification Menu**.
16. Repeat steps **4** through **15** for the next D/A that you wish to assign.
17. In the **System Keypad**, press **SAVE** to save the current configuration.

## Input Patching

### 9

Encore system setup: **Step 9**

- ▲ **Prerequisites** — Ensure that you are familiar with the **Input Source Patch Menu**. In Chapter 5, refer to the [“Input Source Patch Menu”](#) section on page 188.

This procedure enables you to associate (patch) specific router inputs to specific source buttons on the Controller, and also assign tally connections. This procedure is also used for assigning “direct” connections (from PCs or video sources) to source buttons.

- On the Controller SC, up to 24 inputs can be assigned.
- On the Controller LC, up to 64 inputs can be assigned.

#### Important

You may *not* need to change the input patches if you elect to use those in the default **Input Patch Table**.

Encore creates a unique **“Input Patch Table”** for each default router. After a factory reset, the Input Patch Table defaults to the following settings:

**Table 6-2.** Default input patch table after factory reset

Router Number	Router Name	Router Type	Router Sources:	Map to Encore Sources:	Encore Tally
<b>Controller LC</b>					
1	MatrixPRO1	Analog	1 - 16	1 - 16	1 - 8 defined only
2	MatrixPRO2	SDI	17 - 32	17 - 32	Undefined
3	MatrixPRO3	DVI	33 - 48	33 - 48	Undefined
<b>Controller SC</b>					
1	MatrixPRO1	Analog	1 - 16	1 - 16	1 - 8 defined only
2	MatrixPRO2	SDI	17 - 24	17 - 24	Undefined
3	MatrixPRO3	DVI	Undefined	N/A	Undefined

You may elect to use the default patches as shown above, or you can create custom patches as required for specific input configurations.

#### Tip

The same router input can be patched to one (or more) source numbers. For example, if you want to use a DVD player in both 16:9 and 4:3 formats, patch the DVD to inputs **10** and **42** (the shifted source **10**). Using the input setup procedure, set up each input for the desired aspect ratio.

## 6. System Setup

### Input Patching

- Use the following steps to patch inputs to specific source buttons:
  1. In the **System Keypad**, press **SYSTEM** to display the **System Menu**.
  2. Press **{INPUT PATCH}** to display the **Input Source Patch Menu**.
  3. On the **Source Number** line, select the source button on the Controller that you want to patch.
  4. (Optional) If required, press **{DELETE PATCH}** to clear all registers for a selected source button. This enables you to start again with an “undefined” patch.
  5. On the **Connection Type** line, select the router, ScreenPRO-II or the physical connector that you want the selected button to communicate with. Four options are available:
    - ~ Select a router by name (e.g., **MatrixPRO1**).
    - ~ Select a **DIRECT** SDI, Analog or DVI connection.
    - ~ Select an individual ScreenPRO-II **ID** (e.g., **SP 9**).
    - ~ Select **ALL SP**. This selection assumes connections from D/As to similar inputs on all ScreenPRO-IIs in your system.
  6. If you selected a router:
    - a. On the **Router Input** line, select the physical router input that you wish to associate with the source button.
    - b. Continue with step **10**.
  7. If you selected a **DIRECT** connection:
    - a. On the **ID** line, choose the ID of the Video Processor or ScreenPRO-II that you want to address.
    - b. Select the input to which the source is physically connected:
      - If you chose the ID of a **Video Processor**, on the **VP Input** line, select the specific M/E input connector on the Processor
      - If you chose the ID of a **ScreenPRO-II**, on the **SP Input** line, select the specific input connector on the ScreenPRO-II.
    - c. Continue with step **10**.
  8. If you selected an individual ScreenPRO-II **ID**:
    - a. On the **SP Input** line, select the specific input connector on the ScreenPRO-II.
    - b. Continue with step **10**.
  9. If you selected **ALL SP**:
    - a. On the **ScreenPRO-II Input** line, select the “common” input connector on all ScreenPRO-IIs to which the sources are physically connected.
    - b. Continue with step **10**.
  10. On the **Tally Number** line, select the tally that you want to associate with the source button. (If tallies are not connected, in Appendix A, refer to the [“Tally Connector”](#) section on page 374 for pinout details.)
  11. Press **{ADD PATCH}** to confirm your changes.
  12. Repeat the procedure from step **3** to patch additional Controller buttons.
  13. Press **{BACK}** to return to the **System Menu**.
  14. In the **System Keypad**, press **SAVE** to save the new configuration in memory.

## Destination Setup

### 10

Encore system setup: **Step 10**

In this procedure, you will set up the Encore system's single and wide screen destinations. Once assigned, the associated button(s) on the **Destination Bus** will be active.

- ▲ **Prerequisites** — Ensure that you are familiar with the **Destination Setup Menu**. In Chapter 5, refer to the "[Destination Setup Menu](#)" section on page 182 for details.

#### Note

On the Controller SC, up to 6 destinations can be assigned.  
On the Controller LC, up to 32 destinations can be assigned.

The following topics are discussed:

- [Standard and Stack Destination Setup](#)
- [Vertical Blend Setup](#)
- [ScreenPRO-II Destination Setup](#)
- [ScreenPRO-II with EOC](#)

## Standard and Stack Destination Setup

- Use the following steps to set up a standard or stack destination:
  1. In the **System Keypad**, press **SYSTEM** to access the **System Menu**.
  2. Press **{DEST SETUP}** to display the **Destination Setup Menu**.
  3. On the **Destination** line, select the destination that you want to define.
  4. (Optional) If desired, press **{REMOVE ALL}** to remove all previously assigned VP and VPx units from the selected destination.
  5. Scroll to the **Type** line, and select one of four "standard" and "stack" destinations:
    - ~ Single Screen VP, Wide Screen VP
    - ~ Single Screen VP Stack, Wide Screen VP Stack
  6. Scroll to the **VP to Add** line, and select the ID of the Processor that you want to assign to the selected destination.
  7. Press **{ADD}** to add the highlighted Processor. Once added, the **ID** appears in the bottom portion of the menu. Please note:
    - ~ For a **Single Screen** configuration, add only one VP.
    - ~ For a **Wide Screen**, add as many VP and VPx units as required.
    - ~ For a single or wide screen **Stack**, VPs are added in pairs.
  8. If required, scroll to the **VP to Remove** line, select the ID of a Processor that you want to remove from the destination, and press **{REMOVE}**.
  9. Repeat from step 3 to define additional "standard" and "stack" destinations.

## 6. System Setup

### Destination Setup

This completes the procedure for defining “standard” and “stack” destinations. The selected buttons on the **Destination Bus** are now active.

#### Note

Encore can create destinations with Processors that *do not* have the same number of M/Es — in which case, the system operates at the lowest common denominator of M/Es.

## Vertical Blend Setup

To configure an Encore system for vertical array blending, please note the following important points:

- All cabling to the VP and VPx units is the same as a standard widescreen setup.
  - When setting the ID of your VP and VPx units, the lowest ID maps to the top screen in a vertical configuration. Subsequent IDs map down towards the last screen on the bottom.
  - In an “array” configuration, the lowest ID is the top/left screen. Subsequent IDs map to the right and then down — starting with the left-most screen, and moving over to the right.
- Use the following steps to access vertical or array blending:
1. On the **Destination Setup Menu**, add your widescreen VP and VPx units to the list as normal.
  2. In the **Dimensions** field, configure the VP and VPx units as desired.
    - ▲ Suppose VP IDs **1, 2, 3** and **4** were added to the list. The **Dimensions** field enables you to select between the following arrays:
      - ~ **4W x 1H** (4 screens wide by 1 screen high). This is a standard horizontal widescreen configuration.
      - ~ **2W x 2H** (2 screens wide by 2 screens high). This is a 2x2 screen array.
      - ~ **1W x 4H** (1 screen wide by 4 screens high). This is a vertical widescreen configuration.
  3. Once the **Destination Menu** has been configured, navigate to the **Wide Screen Settings Menu** (under the **Output Menu**) to set up widescreen parameters.
  4. Adjust **H Overlap** and/or **V Overlap** as required. When making these adjustments, turn on the **Alignment Test Pattern** on the **Test Pattern Menu (Output > Test Pattern)**.
    - ~ For a horizontal widescreen, select **Hor** to display a test pattern of horizontal lines.
    - ~ For a vertical widescreen configuration, select **Ver** to display a test pattern of vertical lines.
    - ~ For an array, select **Both** to display a test pattern of both horizontal and vertical lines.
  5. Perform edge feathering adjustments in the **Feather Setup Menu (Output > Widescreen > Feather Setup)**. Note that in the **Test Pattern Menu**, a new pattern called **Gray Bars** has been added to assist with vertical blending configurations.

## ScreenPRO-II Destination Setup

In this procedure, you will set up ScreenPRO-II systems as single screen destinations. Once assigned, the associated button(s) on the **Destination Bus** will be active.

- ▲ **Prerequisites** — Ensure that you are familiar with the ways in which a ScreenPRO-II system can be physically configured as a destination. In Appendix D, refer to the “[ScreenPRO-II Configurations](#)” section on page 393 for details.
- Use the following steps to set up a ScreenPRO-II destination:
  1. In the **System Keypad**, press **SYSTEM** to access the **System Menu**.
  2. Press {**DEST SETUP**} to display the **Destination Setup Menu**.
  3. On the **Destination** line, select the destination that you want to define.
  4. (Optional) If desired, press {**REMOVE ALL**} to remove all previously assigned Video Processors (VPs) from the selected destination.
  5. Scroll to the **Type** line and select **Single Screen SP**.
  6. Scroll to the **SP to Add** line and select the ScreenPRO-II **ID** that you wish to add.
  7. Press {**ADD**} to add the highlighted ScreenPRO-II. Once added, the **ID** appears in the bottom portion of the menu.
  8. If required, scroll to the **SP to Remove** line, select the ID of the ScreenPRO-II that you want to remove from the destination, and press {**REMOVE**}.
  9. Scroll to the **Routing Mode** line and select **Internal** or **External** — depending on the way that you want to configure your source routing. Please note:
    - ~ When **External** routers are used, connect two outputs from an Analog router to **any two HD-15 inputs** on the ScreenPRO-II. An SDI router can also be connected to BNC inputs **1** and **2**. During setup, these specific patches will be defined using the **Output Patch Menu**.
    - ~ When **Internal** routing is used, connect Analog sources to inputs **1 - 8** on the HD-15 connectors, and SDI sources to BNC inputs **1** and **2**. During setup, these patches will be defined using the **Input Patch Menu**.
  10. Repeat from step **3** for each additional ScreenPRO-II destination that you want to set up.

This completes the procedure for defining ScreenPRO-II destinations. The selected buttons on the **Destination Bus** are now active. Please note:

- When a ScreenPRO II destination uses “external” routing, the **OUTPUT PATCH** table for the external router allows you to choose which analog input on the ScreenPRO II is being used by the router output. These procedures are covered in the **Router Setup** section.
- When a ScreenPRO II destination uses internal routing, you can patch individual inputs, or you can define selected source buttons to use the same input for all ScreenPRO IIs. This method is ideal if you are using D/As to connect sources to similar inputs on each ScreenPRO-II. These procedures are covered in the **Input Patching** section.

## 6. System Setup

### Destination Setup

## ScreenPRO-II with EOC

The **Enhanced Output Card (EOC)** is an optional (factory installed) card that provides additional output formats, and expands the still store capabilities of ScreenPRO-II. As an input, the EOC takes either the **Preview** or **Program** output of ScreenPRO-II (user selectable), and provides the following outputs:

- SD/HD SDI
- Analog YPbPr
- RGBHV

The EOC supports the following resolutions:

- NTSC (480i)
- PAL (576i)
- 800 x 600
- 1024 x 768
- 1280 x 1024
- 1400 x 1050
- 1600 x 1200
- 1280 x 720p @ 50, 59.94, 60
- 1920 x 1080i @ 50, 59.94, 60
- 1920 x 1080p @ 25, 29.97, 30

When the EOC card is installed in an SP-II and the unit is configured as a destination, a button labeled **{E OUT}** appears on the **Output Menu**. The **Enhanced Output Menu** (and its associated sub-menus) enables you to control the following parameters:

- EOC Output source (Preview or Program)
- Colorspace
- Underscan
- Sync Settings
- Test Patterns
- Gamma
- Sharpness
- Flicker Filter

Please note the following additional points regarding the EOC option:

- The EOC provides increased frame store capabilities, from three storable frames to 100 storable frames.
- Depending on resolution, frames can be saved and recalled within 6 to 10 seconds.
- When the SP-II destination is selected and you access the **Frame Grab Menu**, frames are captured into one of three temporary storage locations. Once the frame has been captured, press **{SAVE}**. If extended memory is available, you can select a storage file number from 1 - 100. Without this option, the storage file number is limited to 1 - 3.



---

## AUX Destination Setup

11

Encore system setup: **Step 11**

In this procedure, you will set up the system's Aux (Auxiliary) destinations.

- ▲ **Prerequisites** — Ensure that you are familiar with the following menus:
  - ~ **Destination Setup Menu.** In Chapter 5, refer to the "[Destination Setup Menu](#)" section on page 182.
  - ~ **Aux Destination Setup Menu.** In Chapter 5, refer to the "[Aux Setup Menu](#)" section on page 184.

The following topics are discussed:

- [Aux Destination Overview](#)
- [Aux Destination Setup](#)
- [ImagePRO or PrePRO-II Aux Destination Setup](#)
- [Aux Destination Setup Notes](#)

### Aux Destination Overview

Encore provides three types of Aux destinations: **Aux**, **ImagePRO Aux** and **PrePRO-II Aux**. Each type of destination can be switched from the Controller by selecting it on the **Destination Bus**, and then selecting the desired source on the **Source Selection Bus**.

- An **Aux** destination is the output of a router, which is typically connected directly to a monitor — rather than to a Video Processor. This type of destination is single format (e.g., an analog monitor can only accept signals from an analog router).
- An **ImagePRO Aux** destination is an external ImagePRO unit, a multi-format processor with three inputs (one analog, one SDI and one DVI) and the ability to scale these inputs to one common output format. Typically, the ImagePRO output is connected to another display device such as a monitor or projector.
- A **PrePRO-II Aux** destination is an external PresentationPRO-II unit, a multi-format processor with nine inputs (eight analog and one SDI), and the ability to scale these inputs to one common output format. Similar to the ImagePRO, the PrePRO-II output is connected to another display device such as a monitor.

## 6. System Setup

### AUX Destination Setup

This section provides instructions for setting up an **Aux** destination.

- Use the following steps to set up an Aux destination:
  1. Ensure that you have properly configured one (or more) router outputs as “Aux” outputs. If not, refer to the [“Router Setup”](#) section on page 270 for instructions. Step 19 deals specifically with Aux output setup.
  2. In the **System Keypad**, press **SYSTEM** to access the **System Menu**.
  3. Press {**DEST SETUP**} to display the **Destination Setup Menu**.
  4. On the **Destination** line, select the Aux destination that you want to define.

#### Note

On the Controller SC, up to 6 destinations can be assigned.  
On the Controller LC, up to 32 destinations can be assigned.

5. Scroll to the **Type** line and select **Aux**.
6. Press {**AUX SETUP**} to display the **Aux Setup Menu**.
7. On the **Source Mapping** line, two choices are available:
  - ~ Select **Input Patch** if you want to map Aux sources according to how inputs are patched to buttons on the **Source Selection Bus**. Note that this is the typical choice.
  - ~ Select **Direct Map** if you want the **Source Selection** bus to be a 1:1 mapping of your router inputs — for *this* Aux destination only.
8. On the **Router Name** line, select the router on which you configured the Aux output(s).
9. On the **Router Output** line, select the specific router output that you wish to designate as the Aux destination. Note that only outputs configured as “Aux” will appear in the list.
10. Press {**BACK**} to return to the **Destination Setup Menu**.
11. Repeat from step 4 to configure additional Aux outputs.
12. Press {**BACK**} to return to the **System Menu**.
13. In the **System Keypad**, press **SAVE** to save the system configuration in memory.

This completes the procedure for defining Aux destinations. The selected button(s) on the **Destination Bus** are now active.

## ImagePRO or PrePRO-II Aux Destination Setup

This section provides instructions for setting up **ImagePRO Aux** and **PrePRO-II Aux** destinations. Once assigned, the associated button(s) on the Controller's **Destination Bus** will be active.

▲ **Prerequisites** — Ensure that you are familiar with the ways in which ImagePRO and PresentationPRO-II systems can be physically configured as Aux destinations. In Appendix D:

- ~ Refer to the "[PresentationPRO-II Aux Configuration](#)" section on page 398 for PresentationPRO-II details.
- ~ Refer to the "[ImagePRO Aux Configuration](#)" section on page 399 for ImagePRO details.

■ Use the following steps to set up an ImagePRO or PrePRO-II Aux destination:

1. Ensure that your ImagePRO and/or PresentationPRO-II systems are properly connected to the system **Switch** via Ethernet. If not, in Chapter 3, refer to the "[Installation](#)" section on page 64 for instructions.
2. Ensure that you have properly configured one (or more) router outputs as "Aux" outputs. If not, refer to the "[Router Setup](#)" section on page 270 for instructions. Step 19 deals specifically with Aux output setup.
3. In the **System Keypad**, press **SYSTEM** to access the **System Menu**.
4. Press {**DEST SETUP**} to display the **Destination Setup Menu**.
5. On the **Destination** line, select the Aux destination that you want to define.

**Note**

On the Controller SC, up to 6 destinations can be assigned.  
On the Controller LC, up to 32 destinations can be assigned.

6. Scroll to the **Type** line and select **ImagePRO Aux** or **PrePRO-II Aux**.
7. Press {**AUX SETUP**} to display the **Aux Setup Menu**.
8. On the **Source Mapping** line, two choices are available:
  - ~ Select **Input Patch** if you want to map Aux sources according to how inputs are patched to buttons on the **Source Selection Bus**. Note that this is the typical choice.
  - ~ Select **Direct Map** if you want the **Source Selection** bus to be a 1:1 mapping of your router inputs — for *this* Aux destination only.
9. On the **ID** line, select the ID of the **ImagePRO** or **PrePRO-II** to which you want to route Aux sources.
10. In the **Analog** section:
  - a. On the **Analog Router Name** line, select the router from which analog sources will be routed to the ImagePRO (or PrePRO-II).
  - b. On the **Analog Router Output** line, select the specific router output that you designated as an **Aux** output.
  - c. On the **ImagePRO Input** (or **PrePRO-II Input**) line, select the ImagePRO or PrePRO-II input to which the analog router output is connected.

## 6. System Setup

### AUX Destination Setup

11. In the **SDI** section:
  - a. On the **SDI Router Name** line, select the router from which SDI sources will be routed to the ImagePRO (or PrePRO-II).
  - b. On the **SDI Router Output** line, select the specific router output that you designated as an **Aux** output.
  - c. On the **ImagePRO Input** (or **PrePRO-II Input**) line, select the ImagePRO or PrePRO-II input to which the SDI router output is connected.
12. In the **DVI** section (applies to **ImagePRO** Aux destinations only):
  - a. On the **DVI Router Name** line, select the router from which DVI sources will be routed to the ImagePRO.
  - b. On the **DVI Router Output** line, select the specific router output that you designated as an **Aux** output.
  - c. On the **ImagePRO Input** line, select the ImagePRO input to which the DVI router output is connected.
13. Press **{BACK}** to return to the **Destination Setup Menu**.
14. Repeat from step 5 to configure another **ImagePRO** or **PrePRO-II** Aux destination.
15. Press **{BACK}** to return to the **System Menu**.
16. In the **System Keypad**, press **SAVE** to save the new system configuration.

This completes the procedure for defining **ImagePRO** or **PrePRO-II** Aux destinations. The selected button(s) on the **Destination Bus** are now active.

## Aux Destination Setup Notes

Please note the following important points regarding Aux Destination Setup:

- ImagePRO and PrePRO-II output setups must be performed locally on the units themselves.
- Only one router of each type (Analog, DVI and SDI) can be connected to an ImagePRO unit.
- In order to ensure that the ImagePRO and PresentationPRO-II units properly process each input, an **Input Configuration File** must be created for each input. This function is accomplished with the Controller's automatic "**Copy Down**" feature, which is initiated by setting up your Processor and ScreenPRO-II inputs. As you progress through the entire setup sequence, ensure that you complete the "[Input Setup](#)" procedure on page 293 to guarantee a "Copy Down."

### Note

In general, a "**Copy Down**" takes place automatically to all destinations that are currently defined to be connected to a given router.

---

## Output Format Setup

### 12

Encore system setup: **Step 12**

- ▲ **Prerequisites** — Ensure that you are familiar with the **Output Menu**. In Chapter 5, refer to the "[Output Menu Functions](#)" section on page 160.

In this procedure, you will configure the output format for each Video Processor and ScreenPRO-II that is used in your system.

#### Important

Be sure to select your projector's native resolution and a frame rate that is consistent with your inputs — for example, if you are using 59.94 NTSC video inputs, run the output at the same rate in order to be synchronous.

To guarantee absolute "sync" of **Input** vs. **Output**, ensure that you genlock the Video Processors. Refer to the "[Genlock Setup](#)" section on page 287 for details.

- Use the following steps to set up the Encore output format:
  1. On the **Destination Bus**, select the destination that you want to configure.
  2. In the **System Keypad**, press **OUTPUT** to display the **Output Menu**. At least one destination must be active in order to access the menu.
  3. On the **Format** line, select the resolution and frame rate at which you want to drive the destination's projector(s). To minimize synchronization problems, select a frame rate that is consistent with your input sources.
  4. Press {**APPLY FORMAT**} to accept the selection.
  5. Repeat from step 2 to set additional destination output formats.
  6. In the **System Keypad**, press **SAVE** to save the new configuration in memory.

#### Note

Automatic "Saves" occur as necessary, for example, when you change output resolutions.

## 6. System Setup

### Sync Setup

# 13

Encore system setup: **Step 13**

- ▲ **Prerequisites** — Ensure that you are familiar with the **Settings Menu**. In Chapter 5, refer to the “[Settings Menu](#)” section on page 165.

In this procedure, you will set up sync parameters for the monitors and projectors connected to the system — for the destination selected on the **Output Menu**.

#### Note

It is recommended that you leave the sync parameters at their default (factory reset) values. However, should you need to adjust individual settings for a particular monitor and projector configuration, use the following procedure.

- Use the following steps to set up sync parameters:
  1. In the **System Keypad**, press **OUTPUT** to display the **Output Menu**.
  2. On the **Destination Bus**, select the destination that you want to configure.
  3. Press **{SETTINGS}** to display the **Settings Menu**.
  4. On the **Output Monitor** line, select the device(s) that are affected by the sync settings — **All**, **Preview**, **Program 1** or **Program 2**.
  5. On the **Sync Out** line, set the desired sync value — **+H+V**, **-H-V**, **+H-V**, **-H+V** or **CSync**.
  6. On the **SOG** line, select a specific “sync on green” signal — **Off**, **Standard** or **Tri-Level** (for certain HD devices).
  7. On the **Gamma** line, set the output gamma for the selected destination.

#### Important

It is recommended that you leave **Gamma** at the unity setting (**1.0**). Change the value only if you need to compensate for a gamma problem in your projector or monitor.

8. On the **Raster Box Size** line, set the size of the raster box that appears around PIPs and Keys. The range is **0** to **8** pixels. Note that the **0** setting effectively turns the raster box off.

#### Note

As required, you can change the **Raster Box** value during operations without affecting sync settings.

9. Press **{BACK}** to return to the **Output Menu**.
10. Repeat from step 2 to set sync parameters for additional destinations.
11. In the **System Keypad**, press **SAVE** to save the new configuration in memory.

---

## Genlock Setup

### 14

Encore system setup: **Step 14**

- ▲ **Prerequisites** — Ensure that you are familiar with the **Genlock Menu**. In Chapter 5, refer to the “[Genlock Menu](#)” section on page 164.

In this procedure, you will set up Genlock for each destination.

■ Use the following steps to set up Genlock:

1. In the **System Keypad**, press **OUTPUT** to display the **Output Menu**.
2. On the **Destination Bus**, select the destination that you want to configure.
3. Press {**GLCK**} to display the **Genlock Menu**.
4. For all types of destinations, set the genlock source on the **Source** line. Choose between **Black Burst**, **CSync** or **None**.

**Note**

When you select the Source, the **Type** line automatically displays the type of genlock provided.

5. For ScreenPRO-II destinations only, verify the setting of the ScreenPRO-II's Termination Switch on the **Termination** line. The menu prompts you how to change this *physical* switch on the ScreenPRO-II itself, if required.
6. Press {**BACK**} to return to the **Output Menu**.
7. Repeat from step 2 to set additional destination genlock types.
8. In the **System Keypad**, press {**SAVE**} to save the new configuration in memory.

## 6. System Setup

### Projector Setup

# Projector Setup

15

Encore system setup: **Step 15**

- ▲ **Prerequisites** — Ensure that you are familiar with the following:
  - ~ **Test Pattern Menu.** In Chapter 5, refer to the “[Test Pattern Menu](#)” section on page 166.
  - ~ **Wide Screen Menu.** In Chapter 5, refer to the “[Wide Screen Settings Menu](#)” section on page 167.
  - ~ **Configurator Application.** You can use the **Configurator** application to assist with wide screen setup. The software is available via download from the Barco website, or contact **Barco Technical Support**. In Appendix B, refer to the “[Contact Information](#)” section on page 384.

In this section, you will set up your projectors for both single screen and widescreen destinations. The following procedures are provided:

- [Single Screen Projector Setup](#)
- [Wide Screen Projector Setup](#)

## Single Screen Projector Setup

- Use the following steps to set up a projector for a single screen destination.

### Note

This procedure also applies to a single screen “stack” destination.

1. In the **System Keypad**, press **OUTPUT** to display the **Output Menu**.
2. On the **Destination Bus**, select the destination whose projector you want to configure.
3. Press {**TEST PATTERN**} to display the **Test Pattern Menu**.
4. On the **Output Monitor** line, select the output(s) on which you want a test pattern to appear — **All**, **Preview**, **Program 1** or **Program 2**.
5. On the **Mode** line, select **On**.
6. On the **Type** line, select the **Burst** test pattern.
7. On the **Raster Box** line, select **On**.
8. At the projector itself, perform the following adjustments to ensure that the output data from the selected device is properly displayed:
  - ~ Adjust the image for the minimum amount of noise.
  - ~ Adjust the pixel clock for proper image position, such that the entire Raster Box is visible.
9. On the **Type** line, select one of the many **Gray Scale** test patterns, as desired.
10. At the projector itself, adjust color balance, brightness and contrast.

### Important

Refer to your projector’s technical manual for information on all projector setup and adjustment procedures.



11. Once the projector is properly set, turn the **Raster Box** and the **Mode** off.
12. Press {**BACK**} to return to the **Output Menu**.
13. Repeat from step 2 for additional single screen destination projector setups.
14. When all projectors for single screen destinations have been set up, press **SAVE** in the **System Keypad** to save the new configuration in memory.

### Wide Screen Projector Setup

- Use the following steps to set up projectors for a wide screen application. This procedure affects *all* projectors assigned to the selected destination.

#### Note

This procedure also applies to a wide screen “stack” destinations.

1. If you elected to use the **Configurator** application to assist with your widescreen setup parameters, ensure that you have completed the following steps:
  - a. On the Configurator’s **Show Layout Tab**, click the radio buttons for the Encore Presentation System and your desired show layout.
  - b. On the Configurator’s **Screen Details Tab**, click the large “**W**” to display the **Wide Screen Parameters Window**.
  - c. In the **Wide Screen Parameters Window**, enter your screen’s **H** and **V** dimensions and the number of projectors.
  - d. Click **Calculate** to determine the required overlap.
  - e. Make a note of these values. You will transfer them to the Controller’s **Wide Screen Settings Menu** in the following steps.
2. In the **System Keypad**, press **OUTPUT** to display the **Output Menu**.
3. On the **Destination Bus**, select the wide screen destination whose projectors you want to configure.
4. Press {**TEST PATTERN**} to display the **Test Pattern Menu**.
5. On the **Output Monitor** line, select the output(s) on which you want a test pattern to appear — **All**, **Preview**, **Program 1** or **Program 2**.
6. On the **Mode** line, select **On**.
7. On the **Type** line, select the **Burst** test pattern.
8. On the **Raster Box** line, select **On**.
9. Press {**BACK**} to return to the **Output Menu**.
10. Press {**WIDE SCREEN**} to display the **Wide Screen Settings Menu**. Note that the **Total Projectors** line shows the total number of Video Processors as defined on the **Destination Setup Menu**.
11. Scroll to the **Total H Res** line and enter the total number of horizontal pixels in the overall wide screen display.
12. Scroll to the **Background Format** line and select the method by which your background graphics were originally produced: **Edge-buttet** or **Overlapped**.

## 6. System Setup

### Projector Setup

13. Scroll to the **Marker Mode** line and enable (or disable) the system's wide screen markers. If enabled, you can see the boundaries of active data on **Preview**.

#### Note

As required, you can change the **Marker Mode** during operations without affecting other wide screen settings.

14. Scroll to the **Overlap Width** line and enter the desired overlap between projectors. The value is in pixels.
15. Scroll to the **Data Doubling** line and disable data doubling.
16. Scroll to the **Justification** line and set the desired wide screen justification, either **Center** or **Left**.
17. In the **Feathering** section, scroll to the **Mode** line and disable edge feathering.
18. Scroll to the **Gamma** line and set the gamma for the feathered regions. The default value is **2.2**.
19. At each projector, perform the following adjustments to ensure that the output data is properly displayed:
  - ~ Adjust the images for a minimum amount of noise.
  - ~ Adjust the pixel clocks for proper image position, such that the entire Raster Box is visible.
20. Press **{BACK}** to return to the **Output Menu**.
21. Press **{TEST PATTERN}** to display the **Test Pattern Menu**.
22. On the **Type** line, select one of the many **Gray Scale** test patterns, as desired.
23. At each projector, adjust brightness, contrast and color balance.

#### Important

Refer to your projector's technical manual for information on all projector setup and adjustment procedures.

24. Once each projector is properly set, scroll to the **Alignment Test Pattern** line and enable the function. This special test pattern allows you to perform projector lens shift and registration adjustments.
  - a. At each projector, perform lens shift and registration adjustments.
  - b. If required, adjust the horizontal and vertical "totals" to match those entered on the **Wide Screen Settings Menu**.

#### Note

Refer to your projector's technical manual for information on all lens shift and registration procedures.

- c. When adjustments are complete, turn off the **Alignment Test Pattern**.
25. Re-enable edge feathering and data doubling (if required for your configuration).
  26. Press **{BACK}** to return to the **Output Menu**.
  27. Repeat from step **3** for additional wide screen destination projector setups.
  28. When all projectors for wide screen destinations have been set up, press **SAVE** in the **System Keypad** to save the new configuration in memory.

## Background Setup

### 16

Encore system setup: **Step 16**

- ▲ **Prerequisites** — Ensure that you are familiar with the following menus:
  - ~ **Background Input Setup Menu.** In Chapter 5, refer to the [“Background Input Setup Menu”](#) section on page 237.
  - ~ **BG Matte Menu.** In Chapter 5, refer to the [“BG Matte Menu”](#) section on page 241.

In this procedure, you will set up the Controller’s two “background” sources (for the **BG A** and **BG B** buttons). An Encore background can be configured as a DVI input, an analog input, a matte color or a frame grab.

Please note the following important points:

- For ScreenPRO-II destinations, remember that **BG B** and the **DSK** are mutually exclusive. This occurs because the **BG/DSK Input B** is *shared* between the **DSK** and **BG B** on all individual ScreenPRO-II units.
  - For single or wide screen Encore systems using single M/E Video Processors, there are only two DVI input connectors available (**1A** and **1B**). In this configuration, you can not set up both backgrounds and the DSK — you can only configure two of the three (e.g., both backgrounds, or one background plus DSK).
  - For stack configurations, remember that the background sources connect to the “bottom” stack Processor, while DSK sources connect to the “top” stack.
- Use the following steps to set up your background sources:
1. On the **Destination Bus**, select the destination whose background sources you want to configure.
  2. On the Controller, press **BG A** to display the **Background Input Setup Menu**.
  3. To configure a matte background:
    - a. Scroll to the **Type** line and select **Matte**.
    - b. Press {**MATTE**} to display the **BG Matte Menu**.
    - c. Adjust the matte color as desired.
    - d. Press {**BACK**} to return to the **Background Input Setup Menu**.
    - e. Press {**SAVE**}.
  4. To configure a DVI background:
    - a. Ensure that your DVI source (e.g., a PC) is properly connected to the Video Processor or ScreenPRO-II chassis, and that the PC is turned on.
    - b. Ensure that EDID is properly set. If not, refer to the [“Programming EDID”](#) section on page 268 for details.
    - c. Scroll to the **Type** line and select **DVI**.
    - d. Set the DVI source’s format:
      - Press {**FORCE ACQUIRE**}, or ...
      - To manually set the source’s resolution, select the desired format on the **Format** line, then press {**APPLY FORMAT**}.
    - e. (Optional) Adjust **H Offset** and **V Offset** as required.

## 6. System Setup

### Background Setup

- f. Press **{SAVE}**.
5. To configure a frame grab background:
  - a. Ensure that you have captured frame(s) into temporary memory, or saved frame(s) into permanent memory. In Chapter 7, refer to the [“Working with Frame Grabs”](#) section on page 355 for instructions.
  - b. Scroll to the **Type** line and select one of the three temporary frame stores: **FG\_1**, **FG\_2** or **FG\_3**.
  - c. To load a frame from “extended” memory into the selected frame store:
    - Scroll to the **File to load** line.
    - Use the **ADJ** knob to select a file.
    - Press **{LOAD}**.
  - d. Press **{SAVE}**.
6. To configure an Analog background:
  - a. Ensure that your analog source is properly connected to the Video Processor chassis. In Appendix A, refer to the [“DVI-I Connector Pinouts”](#) section on page 370 for pinout details.

#### Note

Analog backgrounds cannot be configured on ScreenPRO-II destinations.

- b. Scroll to the **Type** line and select **Analog**.
  - c. Set the analog source's format:
    - Press **{FORCE ACQUIRE}**, or ...
    - To manually set the source's resolution, select the desired format on the **Format** line, then press **{APPLY FORMAT}**.
  - d. (Optional) Adjust **H Offset** and **V Offset** as required.
  - e. (Optional) Adjust **Contrast**, **Brightness**, **Sizing** and **Color Balance** as required.
  - f. Press **{SAVE}**.

#### Important

Using analog background in edge-buttet mode could possibly cause seams, and is not recommended!

7. Repeat from step 2 for **BG B**.
8. Repeat from step 1 for the next destination's background sources.
9. When all background sources have been configured for all destinations, press **SAVE** in the **System Keypad** to save the new configuration in memory.

## Input Setup

17

Encore system setup: **Step 17**

- ▲ **Prerequisites** — Ensure that you are familiar with the **Input Menu**. In Chapter 5, refer to the “[Input Menu](#)” section on page 148.

This procedure provides steps for setting up the system’s inputs, for single screen, wide screen and “stack” destinations. The following topics are provided:

- [Input Setup — Quick Start](#)
- [Input Setup — Comprehensive Method](#)
- [Input Setup Notes](#)

### Input Setup — Quick Start

- Use the following “quick start” method to set up inputs.
  1. On the **Destination Bus**, select the destination whose inputs you want to set up.
  2. On the Controller, select a layer button in the **Layer Control Section**.
  3. In the **Layer Functions Section**, press **Source Preview**. This action isolates the source within the PIP, displays a gray background, turns off borders and shadows, and displays the **Input Menu**.

#### Note

The **Source Preview** function is not available with “stack” configurations. In this situation, use the **PIP Adjustment Menu** to turn off borders and shadows, and then press **INPUT** in the **System Keypad**.

4. On the **Source Selection Bus**, select the source that you want to set up.
5. Press {**FORCE ACQUIRE**} to perform the optimum image setup.
6. Press {**SAVE**} to save the new input configuration in memory.
7. Repeat from step 4 for the next source.
8. (For non-stack configurations only) When all sources have been set up for the selected destination, press **Source Preview** to restore the previous setup.
9. Repeat from step 1 for the next destination — *only if required*. Refer to the “[Input Setup Notes](#)” section on page 296 for details.

### Input Setup — Comprehensive Method

- Use the following “comprehensive” method to set up inputs.
  1. On the **Destination Bus**, select the destination whose inputs you want to set up.
  2. On the Controller, select a layer button in the **Layer Control Section**.
  3. In the **Layer Functions Section**, press **Source Preview**.

## 6. System Setup

### Input Setup

This action isolates the source within the PIP, displays a gray background, turns off borders and shadows, and displays the **Input Menu**.

#### Note

**Source Preview** is not available with “stack” configurations. In this situation, first turn off borders and shadows, then press **INPUT** in the **System Keypad**.

4. On the **Source Selection Bus**, select the source that you want to set up.
5. Press **{FORCE ACQUIRE}** to perform the optimum image setup.
6. Perform additional setups on the **Input Menu** — *if required*:
  - a. (Optional) Scroll to the **Input Connector** line and select the physical connector to which the input is connected, either **HD-15**, **DVI** or **BNC**. If you perform this step, press **{FORCE ACQUIRE}**.
  - b. If you need to manually set the resolution, scroll to the **Format** line and select the desired format. Press **{APPLY FORMAT}** to accept.
  - c. Scroll to the **Input Type** line and set the type of input. Remember that the choices *change* depending on the selected **Format**, and in some cases, this function is not available.
  - d. Scroll to the **Color Space** line, and set the input's color space, either **SMPTE** or **RGB**. In some cases, this function is not available.
  - e. Scroll to the **Sampling Mode** line and set the sampling mode.
  - f. Scroll to the **Contrast** line and set the input's contrast.
  - g. Scroll to the **Brightness** line and set the input's brightness.
  - h. Scroll to the **Gamma** line and set the input gamma.
  - i. Scroll to the **Input Sync Type** line and set the source's sync type.
  - j. Scroll to the **Pulldown Compensation** line and enable (or disable) the mode. Remember that this function only applies to standard video (component, s-video, composite) inputs.
  - k. Scroll to the **Sync Slice <mv>** line and adjust as required.
  - l. Scroll to the **Sharpness** line and set the input's sharpness.
  - m. Press **{SAVE}** to save the input configuration.
7. Perform additional setups on the **Aspect Ratio Menu** — *if required*:
  - a. Press **{AR}** to display the **Aspect Ration Menu**.
  - b. Adjust the **Mode** and **Ratio** as required.
  - c. Press **{SAVE}** to save the input configuration.
  - d. Press **{BACK}** to return to the **Input Menu**.
8. Perform additional setups on the **Sizing Menu** — *if required*:
  - a. Press **{SIZING}** to display the **Sizing Menu**.
  - b. If **1:1 Sampling** was selected:
    - Scroll to the **Clock Phase** line and adjust for the cleanest, brightest and sharpest image.
    - Scroll to the **H Total** line and set the total pixel count per line.
    - Scroll to the **H Active** line and set the width of the active area.

## 6. System Setup

### Input Setup

- Scroll to the **H Position** line and set the start of the active area's horizontal offset from H sync.
  - Scroll to the **V Active** line and set the number of vertical lines in the image.
  - Scroll to the **V Position** line and set the start of the active area's vertical offset from V sync.
  - Press **{SAVE}** to save the input configuration.
  - Press **{BACK}** to return to the **Input Menu**.
- c. If **Oversample** was selected:
- Scroll to the **Right Edge** line and adjust as required.
  - Scroll to the **Left Edge** line and adjust as required.
  - Scroll to the **Top Edge** line and adjust as required.
  - Scroll to the **Bottom Edge** line and adjust as required.
  - Press **{SAVE}** to save the input configuration.
  - Press **{BACK}** to return to the **Input Menu**.
9. Perform additional setups on the **Color Balance Menu** — *if required*:
- a. Press **{COLOR BALANCE}** to display the **Color Balance Menu**.
- b. If an **RGB** source was selected:
- Scroll to the **Red Contrast** line and adjust as required.
  - Scroll to the **Red Brightness** line and adjust as required.
  - Scroll to the **Green Contrast** line and adjust as required.
  - Scroll to the **Green Brightness** line and adjust as required.
  - Scroll to the **Blue Contrast** line and adjust as required.
  - Scroll to the **Blue Brightness** line and adjust as required.
  - Press **{SAVE}** to save the input configuration.
  - Press **{BACK}** to return to the **Input Menu**.
- c. If a **Composite, S-Video** or **YP<sub>b</sub>P<sub>r</sub>** source was selected:
- Scroll to the **Saturation** line and adjust as required.
  - Scroll to the **Hue** line and adjust as required.
  - Press **{SAVE}** to save the input configuration.
  - Press **{BACK}** to return to the **Input Menu**.

#### Important

If you have not already performed incremental “saves,” ensure that you press **{SAVE}** before you exit the **Input Menu** — otherwise *all* of your setups will be lost. If you do not save the input, the next time the source is selected, the input's default settings will be displayed.

In addition, the **{SAVE}** function performs the Controller's automatic “**Copy Down**” feature, which ensures that ImagePRO and PrePRO-II units properly process each input.

10. Repeat from step 4 for the next source that you want to set up.
11. (For non-stack configurations only) When all sources have been set up for the selected destination, press **Source Preview** to restore the previous setup.
12. Repeat from step 1 for the next destination — *only if required*. Refer to the “[Input Setup Notes](#)” section on page 296 for details.

## 6. System Setup

### DSK Setup

## Input Setup Notes

You **do not** have to repeat the input setup procedure for other destinations if either of the following criteria are met:

- Your other destinations use sources that are patched to the same router.
- Your other destinations are configured using the “**ALL SP**” function on the **Input Source Patch Menu**.

In this case, all other system destinations will automatically receive input configuration files via the system’s “copy down” functionality.

You **do** have to repeat the input setup procedure if either of the following criteria are met:

- Your other destinations use a different router.
- Your other destinations use unique input patching.

---

## DSK Setup

18

Encore system setup: **Step 18**

- ▲ **Prerequisites** — Ensure that you are familiar with the following menus:
  - ~ **DSK Adjustment Menu**. In Chapter 5, refer to the “[DSK Adjustment Menu](#)” section on page 254.
  - ~ **DSK Input Setup Menu**. In Chapter 5, refer to the “[DSK Input Setup Menu](#)” section on page 257.

In this procedure, you will set up the Controller’s **DSK** source. An Encore DSK can be configured as a DVI input, an analog input, a frame grab or “none.”

Please note the following important points:

- For ScreenPRO-II destinations, remember that **BG B** and the **DSK** are mutually exclusive. This occurs because the **BG/DSK Input B** is *shared* between the **DSK** and **BG B** on all individual ScreenPRO-II units.
  - For single or wide screen Encore systems using single M/E Video Processors, there are only two DVI input connectors available (**1A** and **1B**). In this configuration, you can not set up both backgrounds and the DSK — you can only configure two of the three (e.g., both backgrounds, or one background plus DSK).
  - For stack configurations, remember that the background sources connect to the “bottom” stack Processor, while DSK sources connect to the “top” stack.
- Use the following steps to set up your DSK source:
1. On the Controller, press **DSK** to display the **DSK Adjustment Menu**.
  2. Press **{INPUT SETUP}** to display the **DSK Input Setup Menu**.
  3. On the **Destination** line, select the destination on which you want to set up the downstream key.
    - ~ If multiple destinations are active, select the desired destination.
    - ~ If a single destination is active, selections cannot be made.
  4. On the **ID** line, select the IDs of the Processor(s) for which you want set up the downstream key.
    - ~ For single screen destinations, ID selections cannot be made.



- ~ For wide screen destinations only:
- Select **All** to set up all the DSK on Processors.
  - Select the **ID** of an individual processor.

#### Note

Typically, in a wide screen destination, the DSK is placed on only *one* of the multiple screens (e.g., the far right screen). For this setup, use the IDs of the individual Processors and set up their “**types**” accordingly — DVI or Analog for the DSK screen, and “none” for the remaining screens.

5. To configure the DSK with no input:
  - a. Scroll to the **Type** line and select **None**.
  - b. Press **{SAVE}**.
6. To configure a DVI input as the DSK:
  - a. Ensure that your DVI source (e.g., a PC) is properly connected to the Video Processor or ScreenPRO-II chassis, and that the PC is turned on.
  - b. Ensure that EDID is properly set. If not, refer to the “[Programming EDID](#)” section on page 268 for details.
  - c. Scroll to the **DSK Input** line and select the input connector from which the DSK source is pulled.
  - d. Scroll to the **Type** line and select **DVI**.
  - e. Set the DVI source’s format:
    - Press **{FORCE ACQUIRE}**, or ...
    - To manually set the source’s resolution, select the desired format on the **Format** line, then press **{APPLY FORMAT}**.
  - f. (Optional) Adjust **H Offset** and **V Offset** as required.
  - g. (Optional) Use the **Crop** function to trim a DVI or analog input that is being used as a DSK.
  - h. Press **{SAVE}**.
7. To configure a frame grab as the DSK:
  - a. Ensure that you have captured frame(s) into temporary memory, or saved frame(s) into permanent memory. In Chapter 7, refer to the “[Working with Frame Grabs](#)” section on page 355 for instructions.
  - b. Scroll to the **Type** line and select one of the three temporary frame stores: **FG\_1**, **FG\_2** or **FG\_3**.
  - c. To load a frame from “extended” memory into the selected frame store:
    - Scroll to the **File to load** line.
    - Use the **ADJ** knob to select a file.
    - Press **{LOAD}**.
  - d. Press **{SAVE}**.

## 6. System Setup

### DSK Setup

8. To configure an Analog source as the DSK:
  - a. Ensure that your analog source is properly connected to the Video Processor chassis. In Appendix A, refer to the "[DVI-I Connector Pinouts](#)" section on page 370 for pinout details.

**Note**

Analog DSKs cannot be configured on ScreenPRO-II destinations.

- b. Scroll to the **DSK Input** line and select the input connector from which the DSK source is pulled.
  - c. Scroll to the **Type** line and select **Analog**.
  - d. Set the analog source's format:
    - Press **{FORCE ACQUIRE}**, or ...
    - To manually set the source's resolution, select the desired format on the **Format** line, then press **{APPLY FORMAT}**.
  - e. (Optional) Adjust **H Offset**, **V Offset**, **Contrast**, **Brightness**, **Sizing** and **Color Balance** as required.
  - f. Press **{SAVE}**.
9. Press **{KEY}** to return to the **DSK Adjustment Menu**.
10. On the **Key Type** line, select the type of key desired (**Luma** or **Color**).
11. Adjust key parameters as required:
  - ~ For a **Luma Key**, adjust **Invert Mode**, **Clip**, **Gain**, **Opacity** and **Fill Source** for the optimum visual key.
  - ~ For a color key, pick the desired color, then adjust **Red**, **Green** and **Blue Color**, **Threshold**, **Mask** and **Opacity**.
12. When your DSK is fully adjusted, press **SAVE** in the **System Keypad**.

---

## Saving the Setup

19

Encore system setup: **Step 19**

When all system setup procedures have been complete, press **SAVE** in the **System Keypad**. This action saves the state of the Controller in non-volatile memory.

Once pressed, the Touch Screen menu reads "**Saving System Configuration.**" If you cycle power, the Controller will return to its state at the time of the "save."

**Note**

Automatic "Saves" occur as necessary, for example, when you change output resolutions.

## 6. System Setup

### Back up System

20

Encore system setup: **Step 20**

- ▲ **Prerequisites** — Ensure that you are familiar with the **Backup/Restore Menu**. In Chapter 5, refer to the "[Backup/Restore Menu](#)" section on page 206 for details.

In this procedure, you will back up your system configuration to a **Flash Memory Card**, or as an alternate method, by using the **Barco Backup and Restore** utility.

#### Note

You can only store one system configuration on a Flash Memory Card.

#### Note

The **Barco Backup and Restore** utility can be found in the Encore Presentation System software bundle — available via download from the Barco website or FTP site. Operational procedures are not discussed below.

- Use the following steps to back up your system to Flash Memory:

1. Ensure that you have a (customer supplied) **Flash Memory Card** available.

#### Important

Only **MMC** or **MMCPlus** cards greater than 512MB can be used. **SD** cards *cannot* be used.

2. Insert the **Flash Memory Card** into the Controller's rear panel **Memory Card** slot.
3. In the **System Keypad**, press **MISC** to display the **Miscellaneous Menu**.
4. Press **{BACKUP RESTORE}** to display the **Backup/Restore Menu**.
5. On the **Device** line, select **Ctrlr+VP+SP** to perform a complete "backup."
6. On the **Controller Options** line, select **All**.
7. Press **{CHECK CARD}** to display the **Current Backup Menu**.
  - ~ Check the "**Controller files backed up**" section to confirm the types of files present on the Flash Memory Card, if any. If files are present, determine if you want to overwrite, or insert a new (blank) card.
  - ~ Press **{BACK}** to return to the **Backup/Restore Menu**.
8. Press **{BACKUP}** to perform a backup operation to the Flash Memory Card using the selected device(s) and options.

At the conclusion of this procedure, your system is completely backed up.

# 7. Operations

---

## In This Chapter

This chapter includes operational instructions for all Encore modes and functions. The following topics are discussed:

- [Prerequisites](#)
- [Operational Configuration](#)
- [Using the Alphanumeric Keypad](#)
- [Using the PS/2 Keyboard](#)
- [Working with Groups](#)
- [Working with Destinations](#)
- [Working with Layers](#)
- [Working with Layer Functions](#)
- [Using Move](#)
- [Working with Live Modes](#)
- [Working with Transitions](#)
- [Working with Presets](#)
- [Layer and Aux Control](#)
- [Working with User Keys](#)
- [Working with Tallies](#)
- [Enable/Disable Controller Lockout](#)
- [Using Backup and Restore](#)
- [Working with Frame Grabs](#)
- [Working with the DSK](#)

**Note**

With only minor differences, operations are identical between the two Controllers (SC and LC). Differences will be noted in the various sections that follow.

## 7. Operations

### Prerequisites

---

## Prerequisites

Prior to reviewing this chapter, please ensure the following:

- All system destinations are properly configured. In Chapter 6, refer to the "[Destination Setup](#)" section on page 277 for details.
- All system inputs (sources) are properly configured. In Chapter 6, refer to the "[Input Setup](#)" section on page 293 for details.
- All system backgrounds are properly configured. In Chapter 6, refer to the "[Background Setup](#)" section on page 291 for details.
- The DSK is properly configured. In Chapter 6, refer to the "[DSK Setup](#)" section on page 296 for details.
- Ensure that you are familiar with the Controller. In Chapter 4, refer to the "[Controller Orientation](#)" section on page 107 for details.
- Ensure that you are familiar with all menus. In Chapter 5, refer to the following sections for details:
  - ~ Refer to the "[PIP Adjustment Menu](#)" section on page 213 for details on all PIP adjustment menu items.
  - ~ Refer to the "[Key Menu](#)" section on page 224 for details on all Key adjustment menu items.
  - ~ Refer to the "[Source Adjustment Menus](#)" section on page 232 for details on all input source adjustment parameters.

#### Tip

As you review each function, it is recommended that you practice each feature on the Encore itself — using a fully configured system consisting of Program and Preview monitors, projector(s), and all the required destinations, sources and backgrounds.

#### Note

In this chapter, when a sequence of menu selections is required to complete a given procedure, the ">" symbol is used to divide each successive menu pick.

- ▲ To access the **Genlock Menu**, press **OUTPUT > {GLCK}**.

---

## Operational Configuration

The following topics are discussed in this section:

- [Monitor Layout](#)
- [Touch Screen Calibration](#)
- [Wide Screen Markers](#)
- [Lookahead Preview](#)
- [Understanding Raster Boxes](#)
- [A Word About LOS](#)
- [Setting User Preferences](#)
- [Understanding Input File Mapping](#)

### Monitor Layout

Use the following diagrams as recommended layouts for Program and Preview monitors:

- **Single Screen Application** — For optimum viewing and utility, place your Preview monitor on the left, and your Program monitor on the right.

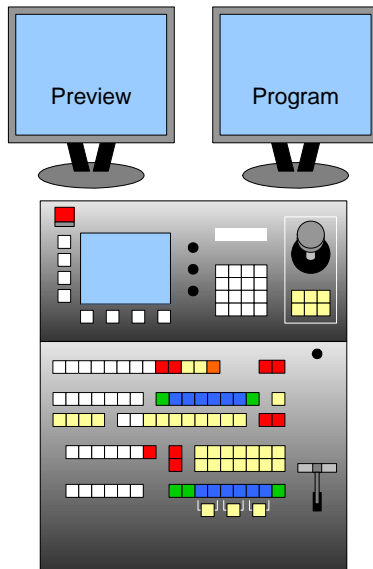


Figure 7-1. Single Screen Application Layout

## 7. Operations

### Operational Configuration

- **Wide Screen Application** — For optimum viewing in all wide screen applications, place all Preview monitors on the left, and all Program monitors on the right.

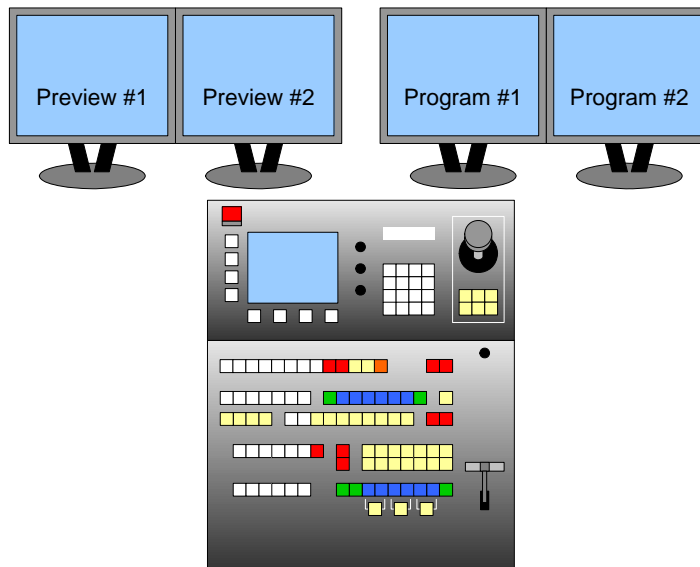


Figure 7-2. Wide Screen Application Layout

- **Vertical Blends and Arrays** — For optimum viewing in all vertical blend or "array" applications, it is recommended that you configure a wide screen preview display that uses a VP or VPx to combine images. This setup enables you to simulate the blend or array on screen, without physically stacking monitors.

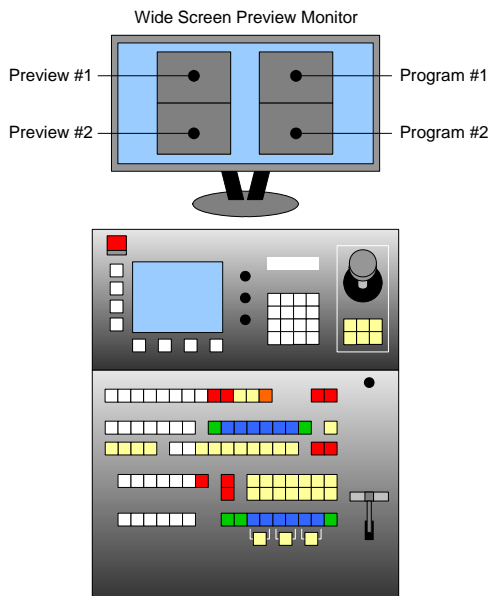


Figure 7-3. Vertical Blend or "Array" Application Layout

In Chapter 3, refer to the "[Wide Screen Configuration Plus Wide Screen Preview](#)" section on page 76 for setup details.



## Touch Screen Calibration

As an excellent prerequisite to all operating procedures, it is recommended that you calibrate the Touch Screen.

- Use the following steps to calibrate your Touch Screen display:
  1. In the **System Keypad**, press **MISC** to display the **Miscellaneous Menu**.
  2. Press **{LCD SETTINGS}** to display the **LCD Settings Menu**.
  3. Press **{LCD CAL}** to display the **Touch Screen Calibration Menu**.
  4. (**Controller LC only**) On the top **LCD** line, select the touchscreen to calibrate.
  5. Follow the directions on the menu to complete the calibration procedure.
  6. (**Controller LC only**) Repeat steps 1 through 5 for the other LCD touchscreen.
  7. For both Controllers, use the controls on the **LCD Settings Menu** to adjust brightness and contrast as desired.

When the procedure is complete, the Controller remembers this calibration setting until it is performed again.

## Wide Screen Markers

If you are using a wide screen configuration, ensure that your **Wide Screen Markers** are enabled. In Chapter 6, refer to the "[Wide Screen Projector Setup](#)" section on page 289 for details.

In wide screen applications, Wide Screen Markers are thin vertical **green lines** at the edges of the screens that are used to denote the *actual* projected image area.

### Note

Markers apply to horizontal blends (e.g., **3W x 1H**), and to horizontal + vertical arrays (e.g., **2W x 2H**), but do not apply to vertical blends (e.g., **1W x 3H**).

Using edge feathering and data doubling, Encore provides perfect and seamless wide screen images. Because of the required overlap, a *portion* of the original image is unused, and does not get projected. The location of the unused portion depends on your selected justification — left or center.

With each type of justification, the Wide Screen Markers accurately denote the unused portion, thus enabling you to properly compose your screens.

- **Left Justified Markers**

The figure below illustrates the Wide Screen Marker in a left justified configuration. Images to the left of the green vertical line are projected. Images to the right are not.

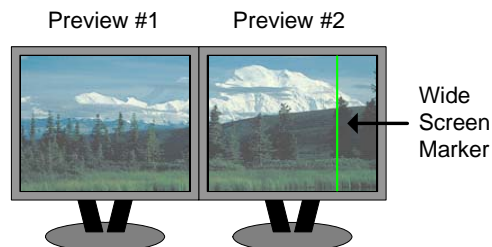


Figure 7-4. Wide Screen Marker, Left Justification

## 7. Operations

### Operational Configuration

- **Center Justified Markers**

The figure below illustrates the two Wide Screen Markers in a center justified configuration. Images between the two vertical green lines are projected. Images outside of the lines are not.

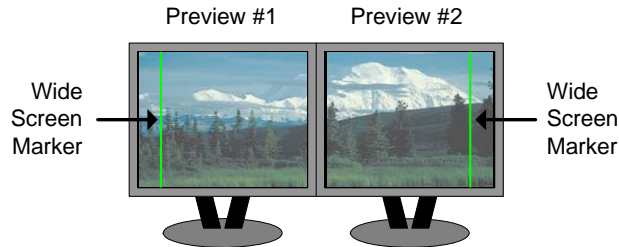


Figure 7-5. Wide Screen Marker, Center Justification

## Lookahead Preview

Encore uses a “full lookahead” preview system that ensures the accuracy of all your transitions. The “look” or appearance that you create on Preview represents the *exact* appearance of Program, after you cut or “auto transition” the images to program.

- ▲ The illustration below represents a simple Preview-to-Program transition. **SPLIT** mode is on, enabling you to have two PIPs on screen simultaneously:

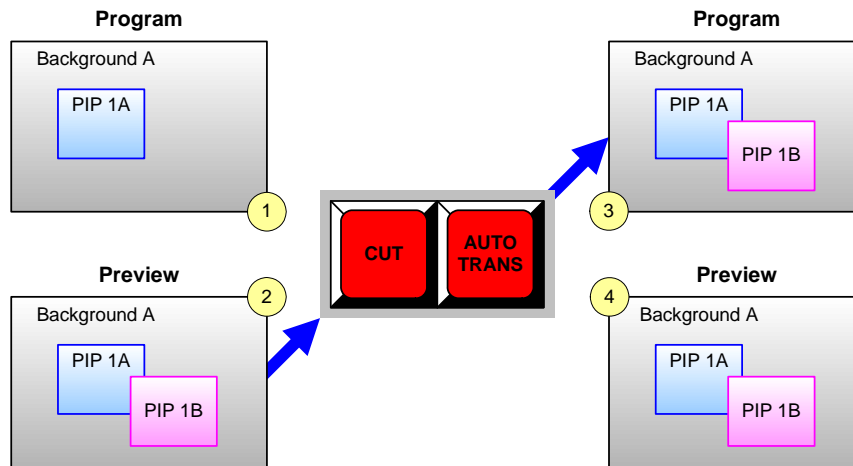


Figure 7-6. Program-to-Preview Transition with Lookahead

- In frame 1, Program consists of a background and a single PIP.
- In frame 2, a second PIP is selected and positioned on Preview.
- When **CUT** or **AUTO TRANS** is pressed, the PIP transitions to Program. Frame 3 represents the Program screen — identical to the Preview “look” in frame 2.
- Frame 4 represents Preview *after* the transition. Preview will continue to match Program until you modify the preview image, in preparation for the next transition.

With these facts in mind, ensure that you always create the desired “next” look in Preview. In this manner, there won’t be any operational surprises:

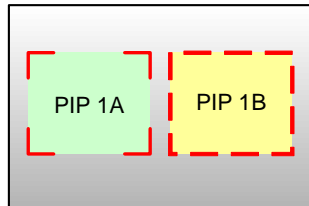
- By using lookahead, you’ll always know visually what PIPs and keys you want to transition **TO** Program.

- Conversely, you'll always know what PIPs and keys to you wish to clear — to visually remove elements **FROM** Program.

## Understanding Raster Boxes

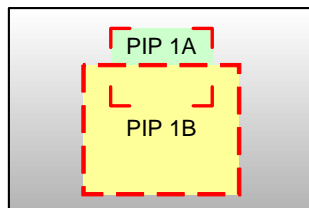
When **Raster Boxes** are enabled on Preview, each PIP or Key is surrounded by a border that helps you identify the PIP or Key's original mixer and layer. Please note:

- The PIP or Key with a "corner" style raster box is **Layer A**.
- The PIP or Key with a "dashed" raster box is **Layer B**.



**Figure 7-7.** Raster Box styles

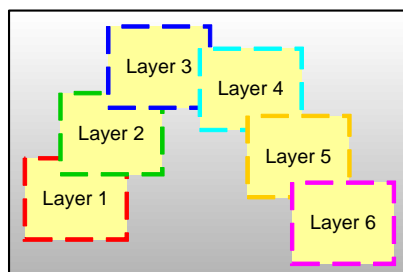
- The "blinking" raster box is always the one enabled for modification, and its corresponding layer button will blink.
- The borders of raster boxes that are *underneath* other layers (such as another PIP) are still visible on Preview.



**Figure 7-8.** Raster Box visibility

Raster box color assignments are as follows:

- |                                  |                                    |
|----------------------------------|------------------------------------|
| • Layers 1A and 1B: <b>Red</b>   | • Layers 4A and 4B: <b>Cyan</b>    |
| • Layers 2A and 2B: <b>Green</b> | • Layers 5A and 5B: <b>Gold</b>    |
| • Layers 3A and 3B: <b>Blue</b>  | • Layers 6A and 6B: <b>Magenta</b> |



**Figure 7-9.** Raster Box color assignments

## 7. Operations

### Operational Configuration

- Remember that Raster Box size can be adjusted:
  1. In the **System Keypad**, press **OUTPUT** to display the **Output Menu**.
  2. On the **Destination Bus**, select the destination that you want to configure.
  3. Press {**SETTINGS**} to display the **Settings Menu**.
  4. On the **Raster Box Size** line, set the size of the raster box that appears around PIPs and Keys. The adjustment range (in pixels) is from **0** (off) to **8**.

## A Word About LOS

On rare occasion, you can experience **LOS** (loss of signal) — typically due to a poor video, graphics or computer connection. In these cases, Encore obeys a precise set of rules:

- **Scaler LOS** — If there is a LOS for a video signal inside a scaler (PIP or KEY), the video switches to black, but the scaler remains in its current size and position.
- **Background LOS** — If there is a LOS for a background DVI input, the video switches to the background's selected matte color.
- **DSK LOS** — If there is a LOS for the DSK, the system switches the DSK **Off** (specifically, selecting "**none**" as the type).

In each case, when the video signal recovers, Encore re-enables the signal as before.

- ▲ In a widescreen setup, a multi-head graphics card is attached to the unscaled **BG A** channel. Once this live background source has been set up, if the signal becomes invalid (e.g., if a cable is removed or the computer is turned off), the **BG A** background switches to the currently defined **matte** color.

Refer to the "[Setting User Preferences](#)" section below for related information about the **Black Invalid Video** selection.

## Setting User Preferences

- Prior to operations, be sure to set user preferences as desired:
  1. In the **System Keypad**, press **MISC** to display the **Miscellaneous Menu**.
  2. Press {**USER PREF**} to display the **User Preference Menu**.
  3. On the **Black Invalid Video** line, select the method by which the scaler "loading" procedure is shown on Preview, when you change inputs:
    - ~ **ON** — black is shown when scalers are loaded.
    - ~ **OFF** — the full scaler loading procedure is shown.
  4. On the **Auto Source Acquire** line, select whether or not the Controller automatically acquires an input, as soon as the source is selected on the bus.
  5. On the **Auto Input Save** line, select whether or not the Controller automatically saves an input configuration file as soon as the source has been acquired.

### Note

The **Auto Source Acquire** field must be enabled for the **Auto Input Save** field to work.

6. On the **Events Manager Support** line, enable the option before connecting the Controller to the **Events Manager** software application, only if **Events Manager** support is required.

7. On both Controllers, under the **Mix Key** heading, select a custom transition rate for the **Mix** button (if desired).
8. On the small Controller only, under the **User Effect** heading, select a custom transition type, rate and edge for the **User Effect** button (if desired).
9. On the large Controller only, under the three **User Trans** headings, select a custom transition type, rate and edge width for the **User Trans 1, 2, and 3** buttons.

## Understanding Input File Mapping

This section provides information on how Encore stores the characteristics of each input in a unique file, and how those files are used during Controller operations.

During the input setup procedure, after adjusting each input parameter, pressing **{SAVE}** on the **Input Configuration Menu** saves those characteristics in a file. The filenames (and associated destinations) can be viewed on the **Input Configuration Menu**.

The configuration file (e.g., **IFILE\_003**) stores all input definitions for that source alone, along with the associated destination.

From that point forward, each time you press that source button and assign it to a PIP or Key, the stored file is recalled and the image appears on Preview (typically after a brief delay). The delay occurs as each input is instantly re-scaled per the file's instructions, and the M/E's scaler is instantly re-programmed with the file's data.

With regards to router connections, an input file is independent of the physical connector. Even though only certain sources can be connected to specific connectors (e.g., HD/SDI on the BNC connector), once a connector is selected (on the **Input Menu**) and an input file is created for the source, that file can be recalled on *any* of the same type of connectors in the system, provided that a router is properly connected and assigned. This in no way forces all of the other connectors to only accept that particular kind of source signal.

## 7. Operations

Using the Alphanumeric Keypad

---

### Using the Alphanumeric Keypad

On the **Controller LC** only, the **Alphanumeric Keypad** enables you to enter and change numeric fields (on the Touch Screen) without having to use a rotary knob.

**Note**

When entering data for PIP size and position, numbers up to eight digits in length can be entered.

**Note**

The **Preset**, **Seq** and **Time Code** buttons are not currently implemented on the **Alphanumeric Keypad**.

The alphanumeric keypad is supported on the following menus, with the following caveats:

- The following four menus have no restrictions as to keypad usage. They keypad can be used for any highlighted field.
  - ~ **Key Menu**
  - ~ **Border Menu**
  - ~ **Shadow Menu**
  - ~ **Effects Menu**
- The **Status Menu** must be selected in the second **Touch Screen Display** in order for the keypad to function in the following three menus:
  - ~ **Input Menu**
  - ~ **Sizing Menu(s)**
  - ~ **Color Balance Menu**
- Because the following four menus do not have "highlights," you must first turn the desired **Rotary Knob** (e.g., **H POS** or **V POS**) by at least 1 count to "activate" the desired field. Thereafter, the keypad functions in the normal manner:
  - ~ **PIP Adjustment Menu**
  - ~ **Input Source Adjustment Menu**
  - ~ **Key Adjustment Menu**
  - ~ **Key Source Adjustment Menu**

**Note**

With the four menus listed above, if you do not activate a knob first, numeric entry defaults to **V Size**, and **H Size** is automatically calculated.

- Use the following steps to enter a value numerically:
  1. Highlight (or select) the field in which you want to enter a number.
  2. Enter the desired value on the keypad. Please note:
    - ~ Pressing the first digit clears the field and enters the selected number.
    - ~ Subsequent entries shift left.
  3. Press **ENTER** in the keypad to "accept" the value.

4. For numeric fields with decimal points, the decimal point is fixed:
  - ▲ To enter **120.3**, press **1, 2, 0, 3, ENTER**.
5. During the entry process, press **CLEAR** at any time to delete the last number entered. Press **CLEAR** repeatedly to delete all entered numbers and restore the original value.
6. For fields that accept negative numbers, press **CLEAR** first before entering the first number. Once the first number is entered, the negative sign appears.

---

## Using the PS/2 Keyboard

Standard PS/2 style keyboards can be connected and used with **both Controllers** for numeric entry and “naming” of certain functions (such as frame grabs).

The keyboard can be connected to the Controller before (or after) the Controller is powered on. Once the keyboard is plugged in, it is immediately available for use. Either the number row or keyboard's keypad can be used for numeric entry.

Please note:

- Numeric entry is valid for all menus listed in the previous ["Using the Alphanumeric Keypad"](#) section on page 310.
- To enter negative values, use the "-" (minus) key, in either the number row or the keypad.
- To clear a value, use the "**Backspace**" key.
- To enter a value, use the use the "**ENTER**" key, in either the number row or the keypad.

Names can be entered in the following menus:

- **Frame Grab Name Menu**
- **Frame Save Menu**

## 7. Operations

### Working with Groups

---

## Working with Groups



A **Group** is a single button that represents a certain number of destinations, as programmed by the user. For example, the **Group 1** button can represent destination **1** or destinations **1, 2** and **3**.

- On the Controller SC, 4 group buttons are available.
- On the Controller LC, 8 group buttons are available.

Groups are activated by pressing (lighting) the desired **Group** button. With groups activated, your setups and “looks” will be routed to the selected destinations only. Any combination of **Group** buttons can be enabled, but all group selections (whether individual or multiple) are mutually exclusive.

The following topics are discussed in this section:

- [Learning a Group](#)
- [Adding or Removing Destinations from a Group](#)
- [Activating a Group](#)
- [Clearing a Group](#)
- [Unlearning a Group](#)
- [Group Notes](#)

### Learning a Group

- Use the following steps to learn (program) a group button:

#### Note

By default, only **Group 1** is assigned to Destination **1**. All other groups must be defined by the user.

#### 1. Controller LC:

- a. On the **Destination Bus**, activate the desired destination(s).
- b. Press and hold **Learn**.
- c. Press the desired **Group** button.

#### Note

This method can also be used to add (or remove) destinations to/from the group — simply by re-learning the button with a new array of destinations.

#### 2. Controller SC:

- a. Press and hold the desired **Group** button.
- b. On the **Destination Bus**, press the desired destination button(s).
- c. Release the **Group** button.

#### Note

This method also works on the Controller LC.



### Adding or Removing Destinations from a Group

- Use the following steps to add (or remove) a destination to/from an existing group:
  1. Controller LC and SC:
    - a. Press and hold the **Group** button to which you want to add or remove a destination.
    - b. On the **Destination Bus**, select the destination(s) that you want to add or remove. In this mode, each destination is a toggle. Those that remain on comprise the new group.
    - c. Release the **Group** button.

#### Note

On the Controller LC, you can also simply re-learn a **Group** button with a new array of destinations.

### Activating a Group

- Use the following steps to activate one (or more) groups:
  1. Controller LC and SC:
    - a. Press a numbered **Group** button *by itself* to enable the assigned destination(s) and toggle all other groups (and destinations) off.
    - b. Press two or more **Group** buttons simultaneously to enable multiple groups of destinations, and toggle all other active groups off.
  2. To activate all groups:
    - a. **Controller LC** — In the **Group Control Section**, press **All**.
    - b. **Controller SC** — Simultaneously press all assigned **Group** buttons.

### Clearing a Group

- Use the following steps to clear a group. This function clear's the group's destinations only — it does not re-program the group:
  1. Controller LC:
    - a. Press **Clear +** a selected **Group** button to clear that *one group only*.
    - b. Press **Clear + All** to clear *all* active groups.
  2. Controller SC:
    - a. **Method 1** — Press the group(s) that you wish to *remain* enabled (which will, in turn, clear the other un-selected groups).
    - b. **Method 2** — Press and hold the **Clear** button (on the **Destination Bus**), then press the button(s) for the destination(s) that you wish to clear.

## 7. Operations

### Working with Groups

## Unlearning a Group

- Use the following steps to unlearn (completely clear) a group button — so that it no longer lights:
  1. Controller LC:
    - a. Clear all destinations on the **Destination Bus (Clear + All)**.
    - b. Press and hold **Learn**.
    - c. Press the desired **Group** button. Here, you are essentially programming the button with “no destinations.”
  2. Controller SC:
    - a. Press and hold the **Group** button that you want to unlearn.
    - b. On the **Destination Bus**, toggle all destination(s) off.
    - c. Release the **Group** button.

## Group Notes

Please note the following points regarding groups:

- If you enable a group that *fully contains* all the destinations from another group, both group buttons will light.
  - ▲ **Group 1** contains destinations **1** and **2**, **Group 2** contains destinations **3** and **4**, and **Group 3** contains destinations **1**, **2**, and **4**. When you press the **Group 3** button by itself, it lights, and the **Group 1** button also lights — because both destinations in **Group 1** are fully included in **Group 3**.

## Working with Destinations

Destinations can be configured as single screens (projectors), multiple screens (in wide screen applications), single or wide screen "stack" configurations, ScreenPRO-II systems, auxiliary router outputs, ImagePRO systems and PresentationPRO-II systems.

During system setup, multiple destinations can be configured:

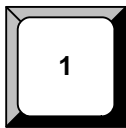
- On the Controller SC, 6 destinations are available.
- On the Controller LC, 32 destinations are available.

In Chapter 6, refer to the "[Destination Setup](#)" section on page 277 and the "[Projector Setup](#)" section on page 288 for complete destination setup instructions.

The following topics are discussed in this section:

- [Activating and Deactivating Destinations](#)
- [Clearing Destinations](#)
- [Routing Sources to Aux Destinations](#)

### Activating and Deactivating Destinations



■ Use the following steps to activate and deactivate destinations:

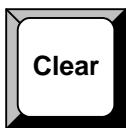
1. **Activate** — press the desired button on the **Destination Bus** to route signals to that destination (e.g., single or multiple projectors, Aux, ScreenPRO-II, etc.). The button lights when activated. Any combination of destination buttons can be enabled sequentially — the buttons are *not* mutually exclusive.
2. **Deactivate** — press **Clear +** the desired button on the **Destination Bus** to remove the selected destination from the output routing. Any combination of destination buttons can be cleared sequentially.

#### Note

"Groups" can also be used to activate and deactivate single or multiple destinations with one-button ease. Refer to the "[Working with Groups](#)" section on page 312 for details.

3. **Isolate One** — If multiple destinations are active, press and hold *one* destination button to momentarily isolate that destination for modification. Release to return to the "group" selection.

### Clearing Destinations



■ Use the following steps to clear destinations:

1. To clear a single destination, press **Clear +** the desired button on the **Destination Bus** to remove it from the output routing.
2. (Controller LC only) To clear all destinations, press **Clear + All**.

## 7. Operations

Working with Destinations

### Routing Sources to Aux Destinations

When using **Aux** destinations, remember that you are routing individual router **inputs** to router outputs, which in turn are connect to other devices. You are not routing the output of the Video Processors.

- With **Aux** destinations (monitors), source selections on the Controller connect a router input to a selected router output. This output in turn is connected to a monitor. This is a single-format route.
- With **ImagePRO Aux** destinations, source selections on the Controller connect a router input to a selected router output. This output in turn is connected to one of three ImagePRO inputs. This is a multi-format route.
- With **PresentationPRO-II Aux** destinations, source selections on the Controller connect a router input to a selected router output. This output in turn is connected to one of eight PresentationPRO-II inputs. This is a multi-format route.

#### Note

The quality of the selected transition depends on the target Aux device. For example, with an ImagePRO Aux, you may get a glitch or a smooth transition, depending on the selected input patching. With a PresentationPRO-II Aux, you will always get a smooth transition.

Several different Aux routing methods are available:

- [Pending and Completing an Aux Route](#)
- [Live Switch Aux Routing](#)
- [Program/Preview Aux Routing](#)
- [Viewing Aux Routes](#)

### Pending and Completing an Aux Route

■ Use the following steps to pend and complete an Aux destination:

1. On the **Destination Bus**, enable the desired **Aux** destination(s).
2. On the **Source Selection Bus**, select the source that you want to route to the Aux destination(s).

#### Note

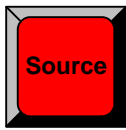
At this point, the Aux route is pending. You are free change sources, or to pend other routes to different destinations (e.g., PIP and Key), but the pending Aux route will not be completed until the next transition is performed.

3. Perform the desired transition in the normal manner (e.g., **CUT**, **AUTO TRANS**). Once performed, the Aux route is completed.

#### Note

If you want to clear the pending Aux route prior to performing it, simply clear the lit Aux destination(s).

### Live Switch Aux Routing



- Use the following steps to switch Aux destinations live.
  1. On the **Destination Bus**, enable the desired **Aux** destination(s).
  2. Press **Shift + Source** (in the **Live Switch Section**). The **Source** button lights to indicate the live mode is enabled, and the **Source Selection Bus** is now a "live" Aux switcher.
  3. On the **Source Selection Bus**, select the desired source. Encore immediately routes that source to the selected Aux destination(s).

#### Note

In this mode, Program LEDs are disabled.

4. To clear the mode, press **Shift + Source**. The light turns off, and the **Source Selection Bus** is returned to its normal functionality.

### Program/Preview Aux Routing



- Use the following steps to switch Aux destinations using the Program/Preview method.
  1. On the **Destination Bus**, enable the desired **Aux** destination(s).
  2. Press **Shift + Program/Preview** (in the **Live Switch Section**). The **Program/Preview** button lights to indicate the mode is enabled.
    - ~ On the **Source Selection Bus**, the bottom row is now the Preview bus, while the top row is now the Program Bus.
    - ~ The top **Program** bus is now mapped with the same inputs as the bottom **Preview** bus, but note that on both Controllers, only *half* of your inputs are available:
      - On the **Controller SC**, inputs 1 - 6 and shifted inputs 7 - 12 are available (but they are mapped to the Preview row). Inputs 13 - 24 are not available.
      - On the **Controller LC**, inputs 1 - 16 and shifted inputs 17 - 32 are available (but they are mapped to the Preview row). Inputs 33 - 64 are not available.
  3. On the Preview Bus, select (pend) the desired source.
  4. Perform the desired transition (e.g., **CUT**, **AUTO TRANS**). The Program Bus switches to the new source, and the Preview Bus clears.
  5. To clear the mode, press **Shift + Program/Preview**. The light turns off, and the **Source Selection Bus** is returned to its normal functionality.

Please note the following points regarding the Program/Preview mode:

- You can not see the selected Preview source prior to transition, because Aux destinations are "single scaler" devices.
- Program LEDs are disabled on the **Source Selection Bus** only — not in the **Layer Control Section**.
- You can also "live switch" directly on the Program Bus.

## 7. Operations

### Working with Destinations

#### Viewing Aux Routes

Aux routes can be viewed individually, without affecting other routes currently in effect.

- Use the following steps to view an Aux route:
  1. On the **Destination Bus**, press and hold the desired Aux destination button.
    - ~ All other lit destination buttons temporarily turn off.
    - ~ On the **Source Selection Bus**, you can now view the input currently routed to the Aux destination (via the red LED), and any pending source selections (via the blinking source button).
  2. Release the Aux destination button to return the **Destination Bus** and the **Source Selection Bus** to their previous state.

---

# Working with Layers

The following topics are discussed in this section:

- [Switching Sources](#)
- [Background Transitions](#)
- [Understanding Split and Mix Modes](#)
- [Working with PIPs in Split Mode](#)
- [Working with PIPs in Mix Mode](#)
- [Modifying PIPs](#)
- [Working with Keys in Split Mode](#)
- [Working with Keys in Mix Mode](#)
- [Using Cut & Fill](#)
- [Modifying Keys](#)
- [Clearing Layers from Program](#)
- [Modifying Layers On Program](#)

## Switching Sources

The following sources are available:

- On the Controller SC, 24 sources are available.
- On the Controller LC, 64 sources are available.
- Use the following steps to switch sources into a PIP or a Key:
  1. Select a destination that is *not* an Aux destination.
  2. Select a layer button (in the **Layer Control Section**). Ensure that it is blinking.
  3. Select **PIP** or **Key** as desired.
  4. Press the desired button on the **Source Selection Bus** to assign that source to the PIP or Key.
    - ~ On the **Controller SC**, sources 1 - 12 are accessed directly. Press and light the **Shift** button to access sources 13 - 24.
    - ~ On the **Controller LC**, sources 1 - 32 are accessed directly. Press and light the **Shift** button to access sources 33 - 64.

The source button blinks to indicate that it is selected and active for modification.

Please note the following points regarding sources:

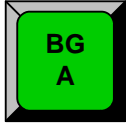
- The **Shift** button on the **Source Selection Bus** is a toggle. It stays lit until pressed again.
- When the **Red LED** above a source button is lit, the source is on Program.
- When a source button is lit solid, the source is on Preview — but it is not active for manipulation. Only blinking source buttons are active for modification.
- Multiple sources can appear on Program and Preview simultaneously, but only one button can be blinking and active for modification on Preview.

## 7. Operations

### Working with Layers

- If a router is used for input connection, a source can be assigned to multiple layers simultaneously.
- If you select a layer in the **Layer Control Section** that is lit (but not blinking), it will blink — and the corresponding “assigned” source on the **Source Selection Bus** will blink. This method also allows you to quickly verify layer/source selections.

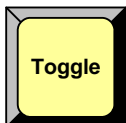
## Background Transitions



- Use the following steps to perform a background transition:
  1. Ensure that your backgrounds are properly set up. In Chapter 6, refer to the [“Background Setup”](#) section on page 291 for details.
  2. On the **Destination Bus**, enable the desired destination(s).
  3. Press the desired background button (**BG A**, **BG B**) in the **Layer Control Section**. The button blinks to indicate it is selected and active for modification. Please note:
    - ~ If the background is already on Program, the **Background Menu** appears, but parameters can not be modified.
    - ~ If the background is not on Program, the **Background Menu** appears — and it is active for modification.
  4. On the **Type** line, select the desired background type: Matte, DVI, Analog or a frame grab.
  5. Perform the desired transition (**AUTO TRANS** or **CUT**) in the normal manner. The **Red LED** above the background now indicates that it is on Program.
  6. To clear a background from Program (as indicated by the **Red LED**):
    - a. Select it in the **Layer Control Section**.
    - b. Press **Clear Layer**.
    - c. Perform the desired transition.

### Note

When you clear a background, it clears to the last selected background matte color. Note that two separate matte colors can be defined, one for **BG A** and one for **BG B**.



- Use the following steps to automatically toggle backgrounds:
  1. Press the desired background button. The button blinks to indicate it is selected.
  2. Press and light the **Toggle** button in the **Transition Functions Section**.
  3. Perform the desired transition. The "Preview" background transitions to Program, while the "Program" background is automatically selected on Preview.

### Note

As long as **Toggle** remains on, backgrounds will toggle between **A** and **B** on every transition. You can change the background "type" on Preview in the normal manner.

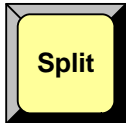


## Understanding Split and Mix Modes

Encore provides two different modes with which you can transition PIPs and Keys:

- [Split Mode](#)
- [Mix Mode](#)

### Split Mode



With the **Split** button lit, a mixer's two layers operate independently. You can manipulate and transition the following combinations of effects on a single mixer:

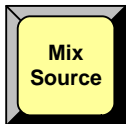
- One or two PIPs
- One or two Keys
- One PIP and one Key

### Mix Mode

With the **Split** button off, a mixer's two layers are ganged together, and two sub-modes determine the mixer's function:

#### Note

**Mix Source** and **Swap** modes are mutually exclusive.

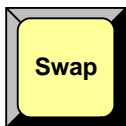


- With **Mix Source** enabled, both mixer layers are perfectly co-located after every transition. Layers **A** and **B** are exactly the same *vertical* size — in exactly the same position — with exactly the same border and shadow.

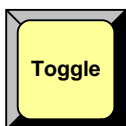
This mode is ideal for transitioning images inside a static PIP. Even though *two* identical PIPs are used, they visually appear as one, provided that they are both the same aspect ratio.

#### Note

In this mode, two PIPs will be the same vertical size, but may differ in horizontal size, for example, if one layer is 4:3 and the other layer is 16:9.



- With **Swap** enabled, both mixer layers can be located independently, with different positions, sizes, borders and shadows. Layers **A** and **B** can be positioned and sized as desired — but *only one* can be on screen at a time.



- The **Toggle** mode can be used with both **Mix Source** and **Swap** modes, without restriction. When enabled, sources toggle back and forth with each transition.
  - ~ With **Toggle** on, perform a transition and select a different source in Preview. Once the first source transitions off Program, it “flip-flops” to Preview. Subsequent transitions alternate between sources. Another new source can also be selected in Preview, and as long as **Toggle** is on, the last two selected sources will alternate.

## 7. Operations

### Working with Layers

- ~ With **Toggle** off, the source selected in Preview stays in Preview, once the transition is complete. Here, sources must be changed manually.

#### Note

If the PIP in Preview has a different source than the PIP in Program, the moment **Toggle** is turned off, the PIP in Preview automatically changes its source to match Program.

Please note the following important points regarding **Mix Mode**:

- When neither layer is on Program, if you select one layer, the other is automatically de-selected. Only one layer can be active at a time.
- Four transition combinations are possible:
  - ~ **Mix Source** with or without **Toggle**.
  - ~ **Swap** with or without **Toggle**.

## Working with PIPs in Split Mode

In **Split Mode**, a mixer's two layers operate *independently*.

- Use the following steps to work with PIPs in **Split Mode**.
  1. On the **Destination Bus**, select the desired destination(s).
  2. In the **Layer Control Section**, press the desired layer button:
    - ~ The layer button blinks, and in the **Source Selection Bus**, the source assigned to the layer blinks.
    - ~ On Preview, the raster box for the selected layer blinks (even if it is hidden under another layer).
  3. Turn the **Split** button **ON**.
  4. In the **Layer Function Section**, press **PIP** to display the **PIP Adjustment Menu**.
  5. On the **Source Selections Bus**, select the desired source. The button blinks to indicate that it is active, and the source appears within the PIP on Preview.
  6. Adjust the PIP's size, position, border, shadow and effects as desired. Refer to the "[Modifying PIPs](#)" section on page 323 for details.
  7. Press **Source** to display the **Input Source Adjustment Menu**. Adjust the source's size and position within the PIP if required.
  8. Prior to the transition, set up additional PIPs and Keys as desired.
  9. Transition the setup to Program.
  10. Repeat the procedure from step 1 for the next transition.

Please note:

- If a mixer is in "Split Mode" and a Layer is active for modification, pressing **Mix Source** or **Swap** places the mixer in **Mix Mode**, and automatically turns the **Split** button off. Please note:
  - ~ The layer selected on Preview remains selected, and if a layer is currently on Program, it remains on air.
  - ~ If both layers are active on Program, Mix Mode cannot be enabled.
- If a mixer is in **Mix Mode**, pressing **Split** automatically cancels the current mode and turns off either the **Mix Source** or **Swap** button.

## Working with PIPs in Mix Mode

In **Mix Mode**, a mixer's layers are ganged together. Both layers can be perfectly co-located on screen (**Mix Source** mode), or both can operate independently (**Swap** mode), but only one layer can be on Program at a time.

- Use the following steps to work with PIPs in **Mix Mode**.
  1. On the **Destination Bus**, select the desired destination(s).
  2. In the **Layer Control Section**, press the desired layer button:
    - ~ The layer button blinks to indicate that it is active for modification.
    - ~ In the **Source Selection Bus**, the source assigned to the layer blinks.
    - ~ On Preview, the raster box for the selected layer blinks (even if it is hidden under another layer).
  3. In the **Layer Function Section**, press **PIP** to display the **PIP Adjustment Menu**.
  4. In the **Transition Functions Section**, select the desired **Mix Mode**:
    - ~ To co-locate the mixer's layers, press **Mix Source**.
    - ~ To locate the mixer's layers independently, press **Swap**.
    - ~ To toggle sources, enable **Toggle**.
  5. On the **Source Selections Bus**, select the desired source. The button blinks to indicate that it is active for modification. At this point the source appears within the PIP on Preview.
  6. Adjust the PIP's size, position, border, shadow and effects as desired. Refer to the "[Modifying PIPs](#)" section on page 323 for details.
  7. Press **Source** to display the **Input Source Adjustment Menu**. Adjust the source's size and position within the PIP if required.
  8. Prior to the transition, set up additional PIPs and keys as desired.
  9. Transition the setup to Program. Refer to the "[Working with Transitions](#)" section on page 343 for details.
  10. Repeat the procedure from step 1 for the next transition.

Please note:

- When the Controller is placed in **Mix Mode**, **Toggle** is automatically enabled.

## Modifying PIPs

- Use the following steps to modify a PIP:
  1. Select the PIP that you wish to modify in the **Layer Control Section**.
  2. If the **PIP Adjustment Menu** is not visible, press **PIP**.
  3. **Size and Position** — Use the **Size** and **Position** controls in the **PIP Adjustment Menu** to manipulate the PIP on Preview. In Chapter 5, refer to the "[PIP Adjustment Menu](#)" section on page 213 for details.
  4. **Source Size** — Press **Source** (in the **Joystick Section**) to display the **Input Source Adjustment Menu**. Use the **Size** and **Position** controls to manipulate the source image within the PIP. In Chapter 5, refer to the "[Source Adjustment Menu Description](#)" section on page 234 for details.

## 7. Operations

### Working with Layers

5. **Crop** — Press **Crop** (in the **Joystick Section**) to display the **Crop Adjustment Menu**. Select the type of crop, the aspect ratio, and the image's H and V size. In Chapter 5, refer to the "[Crop Menu](#)" section on page 231 for details.
6. **Border** — From the **PIP**, **Shadow** or **Effects** menus, press **{BORDR}** to display the **Border Menu**. Select the border's style, color and size, or select a custom border. In Chapter 5, refer to the "[Border Menu](#)" section on page 218 for details.
7. **Shadow** — From the **PIP**, **Border** or **Effects** menus, press **{SHDOW}** to display the **Shadow Menu**. Choose the shadow's size, position and transparency. In Chapter 5, refer to the "[Shadow Menu](#)" section on page 219 for details.
8. **Special Effects** — From the **PIP**, **Shadow** or **Border** menus, press **{EFX}** to display the **Image Effects Menu**. Select the desired effect. In Chapter 5, refer to the "[Image Effects Menu](#)" section on page 220 for details.
9. **Global Functions** — Remember that the following global functions are available:
  - ~ Press **Reset** (in the **Joystick Section**) to reset the *current effect* (e.g., PIP, Key, crop, etc.) to a nominal default value.
  - ~ Press **Full Screen** to bring the PIP to full screen, using the source's height as the defining factor. If **Borders** are on, they factor into the height calculation, so that they will be completely visible on screen.
  - ~ Press **Freeze** to freeze the PIP. Press again to unfreeze.
10. **Transition** — Transition the new look to program with a **CUT** or **AUTO TRANS**. Refer to the "[Working with Transitions](#)" section on page 343 for details.

## Working with Keys in Split Mode

In **Split Mode**, a mixer's two layers operate *independently*.

- Use the following steps to work with Keys in **Split Mode**.
  1. On the **Destination Bus**, select the desired destination(s).
  2. In the **Layer Control Section**, press the desired layer button:
    - ~ The layer button blinks to indicate that it is active for modification.
    - ~ In the **Source Selection Bus**, the source assigned to the layer blinks.
    - ~ On Preview, the raster box for the selected layer blinks (even if it is hidden under another layer).
  3. Turn the **Split** button **ON**.
  4. In the **Layer Function Section**, press **Key** to display the **Key Menu**.
  5. On the **Source Selection Bus**, select the desired (new) key source. The button blinks to indicate that it is selected, and the source appears on Preview.
  6. Adjust the Key. Refer to the "[Modifying Keys](#)" section on page 326 for details.
  7. Prior to the transition, set up additional PIPs and keys as desired.
  8. Transition the setup to Program. Refer to the "[Working with Transitions](#)" section on page 343 for details.
  9. Repeat the procedure from step 1 for the next transition.

## Working with Keys in Mix Mode

In **Mix Mode**, a mixer's layers are ganged together. Both Keys can be perfectly co-located on screen (**Mix Source** mode), or both can operate independently (**Swap** mode), but only one layer can be on Program at a time.

- Use the following steps to work with Keys in **Mix Mode**.
  1. On the **Destination Bus**, select the desired destination(s).
  2. In the **Layer Control Section**, press the desired layer button:
    - ~ The layer button blinks to indicate that it is active for modification.
    - ~ In the **Source Selection Bus**, the source assigned to the layer blinks.
    - ~ On Preview, the raster box for the selected layer blinks (even if it is hidden under another layer).
  3. In the **Layer Function Section**, press **Key** to display the **Key Menu**.
  4. In the **Transition Functions Section**, select the desired **Mix Mode**:
    - ~ To co-locate the mixer's layers, press **Mix Source**.
    - ~ To locate the mixer's layers independently, press **Swap**.
    - ~ To toggle sources, enable **Toggle**.
  5. On the **Source Selection Bus**, select the desired (new) key source. The button blinks to indicate that it is selected, and the source appears on Preview.
  6. Adjust the Key as required. Refer to the "[Modifying Keys](#)" section on page 326 for details.
  7. Transition the setup to Program. Refer to the "[Working with Transitions](#)" section on page 343 for details.
  8. Repeat the procedure from step 1 for the next transition.

## Using Cut & Fill

In any mixer, a **Cut + Fill** key is one in which the hole-cutting information is provided by a Key on **Layer B**, while the fill information is provided by an effect on **Layer A** (either a PIP or a Key). In this mode, the two layers can be manipulated independently or joined together using the "**Join**" mode.

### Note

**Cut + Fill** keys can only be selected on Layer B when the **Split Mode** is enabled.

- Use the following steps to create a **Cut & Fill** Key:
  1. On the **Destination Bus**, select the desired destination(s).
  2. Identify the mixer in which you want to create the **Cut & Fill** Key. All subsequent steps apply to that mixer.
  3. In the **Layer Control Section**, turn the **Split** button **ON** in the mixer.
  4. Press the **Layer A** button, and select the "fill" type — either PIP or Key. Typically, the fill is a PIP. This video will appear "inside" the key hole.
  5. On the **Source Selection Bus**, select the "fill" video source.
  6. Press the **Layer B** button and select **Key** to display the **Key Menu**.
  7. On the **Source Selection Bus**, select the "cut" video source.

## 7. Operations

### Working with Layers

- Place your "cut" source on top of your "fill" source.
- On the **Key Type** line, select **Cut + Fill**.

#### Note

At this point, Layer A's image will disappear, however, the Layer's raster box remains visible. Depending on current Key parameters (e.g., Clip, Gain), some part of the "fill" may be visible in the shape of the "cut" source.

- On the **Key Menu**, use the **Clip**, **Gain**, **Opacity** and **Invert** controls to set the appearance of the key "hole" as desired.
- Alternate between selecting **Layer A** and **Layer B**, and use each layer's **Size** and **Position** controls to position the fill within the key as desired.
- At this point, many creative options are available with **Cut + Fill** keys. You can:
  - ~ Use the **"Join"** mode to link the layers together, such that they move as one. Refer to the ["Using Join Mode"](#) section on page 335 for details.
  - ~ Program a **"Move"** with the combined **Cut + Fill** effect. Refer to the ["Using Move"](#) section on page 336 for details.
  - ~ Program a **"Move"** with only the key signal — such that the moving key travels over a static fill.
- Transition the new setup to Program. Refer to the ["Working with Transitions"](#) section on page 343 for details.

## Modifying Keys

- Use the following steps to modify a Key:

- Select the Key that you wish to modify in the **Layer Control Section**.
- If the **Key Menu** is not visible, press **KEY** in the **Layer Functions Section**.
- Key Type** — Use the **Key Menu** to select the desired key type — **Luma**, **Color**, or **Cut + Fill**. In Chapter 5, refer to the ["Key Menu Functions"](#) section on page 225 for menu details.

#### Note

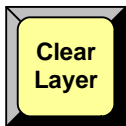
Remember that **Cut + Fill** keys can only be selected on **Layer B** when **Split** is enabled.

- Clip, Gain, Mode, Opacity** — Use the **Key Menu** to adjust the Key's clip, gain, invert mode and opacity on Preview. In Chapter 5, refer to the ["Key Menu Functions"](#) section on page 225 for menu details.
- Fill Source** — Use the **Key Menu** to select a self or matte fill key. If **Matte** is selected, press **{MATTE}** to display the **Matte Menu**, with which you can adjust color. In Chapter 5, refer to the ["Matte Menu"](#) section on page 228 for details.
- Size and Position** — From the **Key Menu**, press **{SIZE & POS}** to display the **Key Adjustment Menu**. Use the controls to manipulate the Key on Preview. In Chapter 5, refer to the ["Key Adjustment Menu"](#) section on page 229 for details.
- Crop** — Press **Crop** (in the **Joystick Section**) to display the **Crop Adjustment Menu**. Select the type of crop, the aspect ratio, and the image's H and V size. In Chapter 5, refer to the ["Crop Menu"](#) section on page 231 for details.

8. **Source Size** — Press **Source** (in the **Joystick Section**) to display the **Key Source Adjustment Menu**. Adjust the source image's size and position within the Key. In Chapter 5, refer to the "[Source Adjustment Menu Description](#)" section on page 234 for menu details.
9. **Special Effects** — From the **Key**, **Key Adjustment**, **Key Source Adjustment** or **Matte Menu**, press {**EFX**} to display the **Image Effects Menu**. Select the desired effect, including monochrome, chroma and hue, invert and strobe. In Chapter 5, refer to the "[Image Effects Menu](#)" section on page 220 for details.
10. **Global Functions** — Remember that the following global functions are available:
  - ~ Press **Reset** to reset the *current effect* (e.g., PIP, Key, crop, etc.) to a nominal default value.
  - ~ Press **Full Screen** to bring the Key to full screen, using the source's height as the defining factor.
  - ~ Press **Freeze** to freeze the Key (on Program and Preview). Press again to unfreeze.
11. **Transition** — Transition the new look to program with a **CUT** or **AUTO TRANS**. Refer to the "[Working with Transitions](#)" section on page 343 for details.

## Clearing Layers from Program

The clear layer procedure enables you to remove layers from Program — including backgrounds, layers and the DSK. When clearing layers, always remember to take advantage of the system's **Lookahead Preview** function. Refer to the "[Lookahead Preview](#)" section on page 306 for additional details.



- Use the following steps to clear a layer from Program:
  1. Check (and compare) the Program and Preview monitors, and note the layer(s) that you wish to clear. In the **Layer Control Section**, **Red LEDs** above the buttons indicate the layers that are on Program.
  2. If the button for the layer that you wish to clear is not lit, press to light it.
  3. In the **Layer Control Section**, press **Clear Layer**. This action turns off the selected layer button and visually clears the layer from Preview. This step is valid for all buttons in the **Layer Control Section**.
  4. Prior to transition, if you want to clear additional layers, repeat steps 2 and 3.
  5. Transition the new setup to Program. The selected layer(s) will transition off of Program.
- Use the following steps to clear all layers from Program:
  1. In the **Layer Function** section, press **All + Clear Layer** (or **Clear Layer + All**).
  2. Perform an auto transition or a cut. All layers will transition off of Program.

## 7. Operations

### Working with Layers

## Modifying Layers On Program

Encore enables you to modify layers directly on Program, without first setting up a "look" on Preview. The mode is typically used for creating a "look" on Program (especially in conjunction with a large screen projector), when the Preview monitor may be too small to realize the desired result.

- Use the following steps to modify layers directly on Program:
  1. In the **System Keypad**, press **SYSTEM** to display the **System Menu**.
  2. Scroll to the **Modify Layers On Program** line and turn the mode **ON**. You can now change PIPs and Keys directly on Program.

Please note:

- When you switch sources directly on Program, you may notice a glitch in the image as the scalars recall the source's file.
- If you use camera inputs in this mode, it is recommended that you use an external **Genlock** signal. Refer to the "[Understanding Input File Mapping](#)" section on page 309 for details on source files.



---

## Working with Layer Functions

On each Controller, the **Layer Functions Section** and the **Transition Function Section** provide numerous creative modes to enhance your presentation.

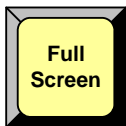
The following topics are discussed in this section:

- [Changing the Layer Mode](#)
- [Using Full Screen](#)
- [Using Clone](#)
- [Using Swap Z-order](#)
- [Using Copy](#)
- [Using Shift Layers](#)
- [Using Freeze](#)
- [Using Black Preview](#)
- [Using Ext Trigger](#)
- [Using Source Preview](#)
- [Using Reset](#)
- [Using Join Mode](#)

### Changing the Layer Mode

- Use the following steps to change the layer mode:
  1. Ensure that the PIP or Key that you wish to change is selected in the **Layer Control Section**, and active for modification.
  2. In the **Layer Functions Section**, press **PIP** to change a Key to a PIP.
  3. Press **Key** to change a Pip to a Key.

### Using Full Screen

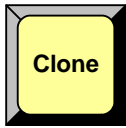


- Use the following steps to take the active PIP or Key to full screen:
  1. Ensure that the PIP or Key is selected in the **Layer Control Section**, and active for modification.
  2. In the **Layer Function Section**, press **Full Screen**. The source's height will be used as the parameter that define's the full screen size.
    - ~ If borders are **ON**, they will be taken into account and remain visible.
    - ~ Shadows will not be taken into account for the full screen size.

## 7. Operations

### Working with Layer Functions

## Using Clone



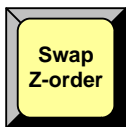
The **Clone** mode is designed for widescreen configurations only. It enables you to make an exact copy of a layer onto the opposite screen. All Key or PIP parameters are cloned — including the shadow, effects, border and size. Once cloned, you can select between a “mirror” or an “offset” clone.

- Use the following steps to clone a layer:
  1. Ensure that a PIP or Key is selected in the **Layer Control Section**, and active for modification in Preview.
  2. Ensure that the PIP or Key is positioned fully within the boundaries of an outside destination’s screen. If the PIP or Key straddles the center of the widescreen, the Clone mode cannot be enabled.
    - ▲ In a 2 screen blend, the PIP or Key cannot be positioned such that it sits between screens 1 and 2.
    - ▲ In a 3 screen blend, the PIP or Key cannot be positioned anywhere within the Screen 2 space.
  3. Press **Clone** to display the **Clone Setup Menu**.
  4. Select the desired clone type — **Mirror** or **Offset**.
  5. If **Offset** is selected, adjust the offset (in pixels) as desired.
  6. If desired, clone additional layers by repeating the procedure from step 1.
  7. Press **CUT** or **AUTO TRANS** to transition the new effect to Program.

#### Note

You can set up and perform a **Move** in conjunction with a cloned image.

## Using Swap Z-order

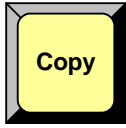


- In **Split** mode only, use the following steps to swap the Z-order (priority) of two layers within the same mixer. The function works with two Keys, two PIPs, or one of each.
  1. In the selected mixer, ensure that **Split** mode is enabled.
  2. Ensure that you have two layers visible on Preview, with one layer visually overlapping the other.
  3. In the **Layer Functions Section**, press **Swap Z-Order**. The visual priority (on Preview) of the two layers changes. Note that the layers remain at their current locations — only the priority changes.
  4. Transition the new "look" to program with a **CUT** or **AUTO TRANS**.

#### Note

The **Swap Z-Order** function only works on the layers within a selected mixer. You cannot use the function to swap the priority of different mixers.

## Using Copy



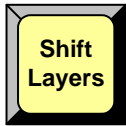
The **Copy** function enables you to copy the properties of the active PIP or Key to another PIP or Key — on the same (or different) mixer.

- Use the following steps to PIP or Key parameters to other layers:
  1. In the **Layer Control Section**, select the PIP or Key that you want to "copy from" (the blinking layer).
  2. In the **Layer Functions Section**, press **Copy** to display the **Copy Setup Menu**.
  3. Using the menu, enable or disable the specific parameters that you wish to copy (e.g., **Position**, **Size**, **Border**, etc.). You can also enable or disable all parameters using the **{ALL ON}** and **{ALL OFF}** buttons.
  4. Press and hold **Copy**.
  5. Press the button for the layer that you want to "copy to."

**Note**

The "copy to" layer must be enabled on Preview.

## Using Shift Layers



In stack configurations on the Controller SC only, the **Shift Layers** button enables you to access all layers in the **Layer Control Section**. The button only functions when the destination is a stack.

- **Shift Layers Off** — Access layers **1A** to **3B** plus backgrounds **A** and **B**.
- **Shift Layers On** — Access layers **4A** to **6B** plus the **DSK**.

The table below illustrates the button's functionality in each mode.

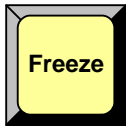
Table 7-1. Shift Layers button functionality

	Shift Layers Off	Shift Layers On
Press button:	to access layer:	to access layer:
BG A	BG A	
BG B	BG B	
1A	1A	4A
1B	1B	4B
2A	2A	5A
2B	2B	5B
3A	3A	6A
3B	3B	6B
DSK		DSK

## 7. Operations

### Working with Layer Functions

## Using Freeze



- Use the following steps to freeze a layer's motion. Both PIPs and Keys can be frozen.

1. In the **Layer Control Section**, select the layer on Preview that you wish to freeze.
2. In the **Layer Function Section**, press **Freeze**. The button lights to indicate that "freeze" is enabled.

### Note

The lit **Freeze** button indicates an association between the selected layer and the "freeze." If you select a different layer that does not have an associated freeze, the button turns off. If you return to the "associated" layer, the button lights again.

3. Transition the frozen layer to/from Program in the normal way.
4. To restore motion to the source, select the frozen layer and press **Freeze**.

Please note:

- If a mixer is in **Mix** mode, you can only freeze and un-freeze while a layer is selected on Preview.
- If a mixer is in **Split** mode, you can freeze and un-freeze while a layer is selected on either Preview or Program.
- When **Freeze** is enabled for a layer, PIP and Key adjustments are not allowed.

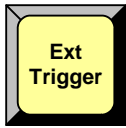
## Using Black Preview



The **Black Preview** function enables you to transition all layers, backgrounds and the DSK to black, across all configured screens and all enabled destinations. The button is a toggle — press to enable black on Preview, press again to restore the previous look.

- Use the following steps to use the **Black Preview** function:
  1. Regardless of the setup currently in Preview, in the **Transition Function Section** press **Black Preview** to place source "black" on Preview. All PIPs, keys and backgrounds are maintained under the black screen. Please note:
    - ~ The **Black Preview** button blinks when enabled.
    - ~ All raster boxes remain visible on Preview.
  2. Perform a transition in the normal way to fade Program to black.
  3. To fade up from black, turn off the **Black Preview** button. All PIPs, keys and backgrounds are restored on Preview.
  4. Perform a transition in the normal way to fade up from black.

## Using Ext Trigger



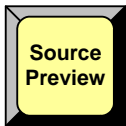
The **Ext Trigger** function is only used with the **Barco Events Manager** or **Barco Stage Manager** applications. With these two products, when the timeline reaches a programmed "pause" cue, the timeline pauses. This in turn causes Encore's **Ext Trigger** button to flash. Pressing **Ext Trigger** restarts the timeline.

- Use the following steps to use the **Ext Trigger** function:
  1. Ensure that Encore is properly connected to (and recognized by) the **Barco Events Manager** or **Barco Stage Manager** application. An Ethernet connection is required. Refer to the application's **User's Guide** for interfacing instructions.
  2. On the **Barco Events Manager** or **Barco Stage Manager** application, program a "pause" cue in the normal manner. When the timeline reaches the "pause" cue, the timeline pauses. This action causes the **Ext Trigger** button to flash.
  3. To restart the application's timeline, press **Ext Trigger**.

### Note

If you are not using **Barco Events Manager** or **Barco Stage Manager**, the **Ext Trigger** button has no function.

## Using Source Preview



The **Source Preview** function enables you to quickly isolate a selected layer for sizing and adjustment purposes — in Preview only.

- Use the following steps to use the **Source Preview** function:
  1. In the **Layer Control Section**, select the layer that you want to isolate.
  2. In the **Layer Functions Section**, press **Source Preview**. The following actions occur:
    - ~ For the selected layer, the border and shadow is turned off.
    - ~ The PIP (or Key) is placed in the center of the screen and sized to 90% of the output resolution.
    - ~ If the system is in wide screen mode, the layer is centered in screen 1 and sized to 90% of that screen.
    - ~ All other layers are hidden.
    - ~ The background switches to a neutral gray.
    - ~ The **Input Menu** for the selected source appears.

After **Source Preview** has been pressed for the first time, the next press sizes the PIP to **1:1**, with respect to the source's input resolution. If the 1:1 size is larger than the output resolution of the Preview screen, the PIP is positioned such that the top/left corner is showing.

Subsequent presses of the **Source Preview** button will reveal the other corners. The next button press returns the PIP to 90% size of the output resolution.

### Note

If the 1:1 PIP size is less than the output resolution of the Preview screen, the PIP will be centered in the Preview screen at 1:1.

## 7. Operations

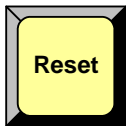
### Working with Layer Functions

3. Using the **Input Menu**, adjust the source in the normal manner.
4. To restore Preview to its previous setup, double-punch **Source Preview**.

Please note the following important points regarding Source Preview:

- While the **Source Preview** mode is enabled, you can only perform input adjustments and source selections. All other layer, destination and output functions are disabled.
- The **Source Preview** mode cannot be enabled with "stack" destinations.

## Using Reset



The **Reset** function is context sensitive. It is used to reset the *current effect* to a nominal default value on Preview.

- Use the following steps to reset a specific PIP or Key parameter:
  1. In the **Layer Control Section**, activate the layer that you wish to reset. The layer button blinks to indicate that it is active.
  2. Ensure that the layer is on Preview. Typically, you cannot reset functions on Program.

### Note

In some situations (such as size and position), a parameter on Program *can* be reset — provided that **Modify Layers on Program** is enabled.

3. Ensure that **Freeze** is off. Frozen PIPs or Keys cannot be reset.
4. If required, access the "menu" whose specific function you want to reset (e.g., borders, shadows, special effects, size, etc.).
5. In the **Joystick Section**, press **Reset** to reset the current effect.

## Using Join Mode

Within a selected mixer, the "**Join**" mode enables you to lock layers **A** and **B** together, such that they move as one and maintain a precise relationship. You can also program "moves" when the two layers are joined. The mode is particularly effective when using **Cut + Fill** keys, or for simultaneously moving a PIP with an associated lower-third key.

The following rules apply:

- Only the layers within a mixer can be joined (e.g., **1A** and **1B**).
  - Layers on two separate mixers cannot be joined (e.g., **1A** and **3B**).
  - In the selected mixer, **Split** mode must be enabled.
  - Any type of PIP and all types of Keys can be joined. You can join two PIPs, two Keys, or one PIP and one Key.
  - When the two layers are joined, the **Size** and **Position** controls on either layer enable you to move both layers as one. The relationship of the two layers (at the time of the joining) is maintained proportionally.
  - When the two layers are joined, the effects (e.g., border, shadow, clip) on each layer are locked — and cannot be changed until the "join" is cancelled. In addition, source selection and input adjustments are disabled.
  - You can only enable and disable the mode when the "join" is on Preview.
- Use the following steps to join both layers within a mixer:
1. In the **Layer Control Section**, ensure that **Split** is enabled in the selected mixer.
  2. On Preview, create a PIP or Key on **Layer A** in the normal manner.
  3. Create a PIP or Key on **Layer B** in the normal manner.
  4. Press and hold the **Split** button, then press either of the two layer buttons. This action enables the "join" mode, and causes *both* layer buttons to blink.
  5. Modify the joined layers as required:
    - ~ Use either layer's **Size** and **Position** controls.
    - ~ Program a "move."

Note that the two layers move and size as one.

6. Transition the new setup to program with a **CUT** or **AUTO TRANS**.
7. To exit the mode, transition the effect off Program and back to Preview.
8. Press and hold the **Split** button, then press either of the two layer buttons.

### Note

When **Presets** are learned, the state of a joined mixer is saved in the Preset.

## 7. Operations

### Using Move

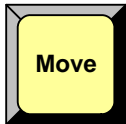
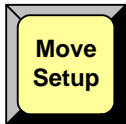
---

## Using Move

The following topics are discussed in this section:

- [Programming Moves](#)
- [Pending and Triggering Moves](#)
- [Move Notes](#)

### Programming Moves



The Encore Presentation System enables you to move a PIP or a Key (or both) smoothly from one screen location to another at a predefined rate, while the layer(s) are on-air. All moves are two-keyframe effects, with a starting location and an ending location.

There are two ways to program a move — on **Preview** or on **Program**.

- [Program a Move on Preview](#)
- [Program a Move on Program](#)

#### Program a Move on Preview

This mode enables you to program a move with the selected layer on Preview only — before it has transitioned to Program.

■ Use the following steps to program a move on Preview:

1. In the **Layer Control Section**, select the layer that you want to move. The button blinks to indicate that it is active for modification.
2. In the **Layer Functions Section**, select **Key** or **PIP** as desired.
3. Size and position the PIP or Key in its “starting” location on Preview. Adjust all border, shadow and source parameters in the normal way.
4. In the **Layer Functions Section**, press **Move Setup**. The button blinks to indicate that you are now actively defining the properties of the move.
5. Move the PIP or Key to its “ending” size and location (on or off screen).
6. Adjust the **Move Rate** parameter to define the rate at which the PIP or Key moves. The rate can be adjusted in 0.1 second increments.
7. Press **Move Setup** again to complete the programming. The button remains lit, and the PIP or Key returns to its starting location on Preview.

#### Note

The lit **Move Setup** button indicates an association between the selected layer and a programmed “move.” If you select a different layer that does not have an associated move, the button turns off. If you return to the “associated” layer, the button lights again.

8. To set up an additional move on another layer, repeat the procedure from step 1.

To pend and trigger the move, refer to the "[Pending and Triggering Moves](#)" section on page 337.



### Program a Move on Program

This mode enables you to program a move with the selected layer on both Program and Preview — after the layer has transitioned to Program.

- Use the following steps to program a move on Program:
  1. In the **Layer Control Section**, select the layer (on Program) that you want to move. Note that its current position is the move's "starting" location.
  2. In the **Layer Functions Section**, press **Move Setup**. The button blinks to indicate that you are now actively defining the properties of the move.
  3. Size and position the PIP or Key to its "ending" location. Note that on Preview, *only the raster box moves*.
  4. Press **Move Setup** again to complete the programming. The button remains lit, and the raster box returns to its starting location on Preview.
  5. To set up an additional move on another layer, repeat the procedure from step 1.

To pend and trigger the move, refer to the "[Pending and Triggering Moves](#)" section.

### Pending and Triggering Moves

For each layer on which you have programmed an associated move, you can "pend" and "trigger" the move in one of two ways — on **Preview** or on **Program**.

- [Pend on Preview](#)
- [Pend on Program](#)

#### Pend on Preview

This method enables you to move the PIP or Key *automatically* on the next transition.

- Use the following steps to pend a move on Preview:
  1. With the move properly programmed, ensure that the layer containing a move is selected and blinking.
  2. To pend the move, press **Move** in the **Layer Functions Section**. The button lights to indicate the pending move. On Preview, the raster box blinks at the "destination" location — *not* the PIP or Key's current location.

#### Note

If you need to cancel the move (un-pend), simply press **Move** to turn the button off.

3. Perform a **CUT** or **AUTO TRANS**. The transition takes the Preview image to air, and the move begins immediately. Remember that the **T-Bar** cannot be used to execute moves.
4. To move the layer back to keyframe 1, press **Move**. The button lights and on Preview, the raster box blinks at the "starting" location.
5. Perform a **CUT** or **AUTO TRANS**. In this "ping-pong" manner, you can continue to transit back and forth between keyframes 1 and 2.

## 7. Operations

### Using Move

#### Pend on Program

This method enables you to trigger the move *manually*, with a layer *already* on Program.

■ Use the following steps to pend a move on Program:

1. With the move properly programmed, ensure that the layer containing a move is selected and blinking.
2. Perform a **CUT** or **AUTO TRANS**.
3. To pend the move, press **Move** in the **Layer Functions Section**. The button lights to indicate the pending move. On Preview, the raster box blinks at the "destination" location — *not* the PIP or Key's current location.

#### Note

If you need to cancel the move (un-pend), simply press **Move** to turn the button off.

4. Perform a **CUT** or **AUTO TRANS**. The move begins when the button is pressed. Remember that the **T-Bar** cannot be used to execute moves.
5. To move the layer back to keyframe 1, press **Move**. The button lights and on Preview, the raster box blinks at the "starting" location.
6. Perform a **CUT** or **AUTO TRANS**. In this "ping-pong" manner, you can continue to transit back and forth between keyframes 1 and 2.

#### Move Notes

Please note the following important points regarding the **Move** mode:

- **Move parameters** — for a given PIP, the following effects are valid "move" parameters, each of which will transition smoothly from point to point:
  - ~ PIP or Key size and position
  - ~ PIP or Key source size and position
  - ~ PIP Shadow size and position
  - ~ PIP or Key Crop values
- **Keyframe effects** — In addition to the "LINEAR" motion type, additional predefined keyframe effects are available on the **Effects Menu**:
  - ~ **LINEAR ACCL** — Same as **LINEAR**, but with acceleration and deceleration.
  - ~ **ARCH CW** — A smooth arch path moving in a clockwise direction.
  - ~ **ARCH CCW** — A smooth arch path moving counter-clockwise.
  - ~ **BMRNG CW** — A smooth boomerang motion, clockwise.
  - ~ **BMRNG CCW** — A smooth boomerang motion, counter-clockwise.
- **Clearing moves** — To clear a move (and remove the association between a layer and a move), double-punch the **Move Setup** button quickly.
- **Raster size** — If you define a PIP to transition to **0 x 0** size, the raster box changes to a **4 x 4** pixel size. This enables you to know its location on the next transition. The raster box change also occurs after you pend the move.
- **Freeze** — You cannot set up a move or pend a move when a layer is frozen.

## 7. Operations

### Using Move

- **On screen, off screen** — When programming moves, Encore lets you move a PIP or Key from an off-screen location to an on-screen location, and vice-versa.
- **Editing moves** — Once a move property has been defined, it can be edited:
  - a. Select the layer that contains the move and press **Move Setup**. The layer snaps to its defined "ending" location.
  - b. Select a new "ending" location in the normal way.
  - c. Change the keyframe effect or the move rate in the normal way.
  - d. Press **Move Setup** to complete the edit.

Remember that **Move** behaves differently, depending on the selected mode:

- In **Split** mode, two PIPs or Keys in a mixer can be programmed and triggered independently (or simultaneously). You can pend individual layers or both layers — and then transition as desired.
- In **Mix Source** mode, both PIPs or keys are perfectly co-located on screen. The programmed move applies to both layers. After a move is programmed, the **Move Setup** button lights when either layer **A** or **B** is pressed.
  - ~ If **Toggle** is **On**, each time you transition, the source inside the PIP or Key changes automatically.
  - ~ If **Toggle** is **Off**, you must change sources manually (if desired) before each transition.
  - ~ "Ping-pong" transitions can be performed.
- In **Swap** mode, both layers can operate independently but only one PIP or key can be on screen at a time, and the system alternates between each layer on each transition.
  - ~ Each layer can have its own programmed move.
  - ~ The "toggle" mode applies in the normal manner.
  - ~ "Ping-pong" transitions cannot be performed.

#### Note

To store "moves" such that they are repeatable, use **Presets**. Refer to the "[Working with Presets](#)" section on page 345 for details.

## 7. Operations

Working with Live Modes

---

# Working with Live Modes

The following topics are discussed in this section:

- [Using Live Switch Program/Preview Mode](#)
- [Using Live Switch Source Mode](#)
- [Live Mode Source Timing](#)

## Using Live Switch Program/Preview Mode



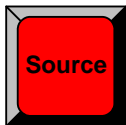
The **Live Switch Program/Preview Mode** turns both rows of the **Source Selection Bus** into two buses, both of which can be used to route sources into PIPs and Keys:

- The top row is the **Program** bus. When you select sources here, you perform live "cuts" directly on Program.
  - The bottom is the **Preview** bus. When you select sources here, you can "cut" or "transition" them to Program.
- Use the following steps to utilize the **Live Switch Program/Preview Mode**:
1. On the **Destination Bus**, enable the desired destination(s).
  2. On **Preview**, select the *one layer* that you want to remain enabled when you enter the live mode. All other **Preview** layers will be cleared.
  3. Press **Shift + Program/Preview**. The **Program/Preview** button lights to indicate that the mode is enabled.
    - ~ When you first enter the mode, all layers on **Preview** (except the selected one) are cleared. All layers on **Program** remain as is.
    - ~ The top **Program** bus is now mapped with the same inputs as the bottom **Preview** bus, but only *half* of your inputs are available:
      - On the **Controller SC**, inputs 1 - 6 and shifted inputs 7 - 12 are available (but they are mapped to the Preview row). Inputs 13 - 24 are not available.
      - On the **Controller LC**, inputs 1 - 16 and shifted inputs 17 - 32 are available (but they are mapped to the Preview row). Inputs 33 - 64 are not available.
  4. With the mode enabled, there are several ways you can switch and transition:
    - ~ Select a layer and a function (PIP or Key). On **Preview**, select (pend) the desired source, then perform the desired transition. The source transitions to **Program**.
    - ~ Select a layer and a function (PIP or Key) that is *not* already on **Program**. Its "last selected" source appears on **Preview**. Select a source directly on **Program** to immediately cut that layer to **Program**.
    - ~ Select a layer already on **Program**. Select a source on **Preview** or **Program** to immediately cut that source into the layer.
    - ~ Use the **Clear Layer** function in the normal way to transition layers off of the **Program** bus.
  5. To clear the entire mode, press **Shift + Program/Preview**. The button turns off, and the entire **Source Selection Bus** is returned to its normal functionality.

Please note the following points regarding the **Live Switch Program/Preview Mode**:

- When switching directly on **Program**, the Controller uses a predefined set of rules. Refer to the "[Live Mode Source Timing](#)" section page 342 for details.
- Program LEDs are disabled on the **Source Selection Bus** only — but not in the **Layer Control Section**. The only exception is that a blinking Red LED on Program still indicates that the associated mixer is set to **Mix Mode**.
- If a layer is on Preview only, the PIP or Key can be sized and positioned.
- The **Split** and **Mix** modes operate in the normal manner.
- You can program a "move" with a source already on Program. When you press **Move Setup**, you can move the raster box on Preview and choose the "destination" location and size.
- When using the mode in conjunction with **Presets**, the following rules apply:
  - ~ When learning Presets, they will still be learned from Preview.
  - ~ When recalling Presets, they will still be recalled to Preview.
  - ~ A Preset remembers if the **Live Switch Program/Preview Mode** was active at the time it was learned. Upon Preset recall, the mode is enabled automatically.
- The **Live Switch Program/Preview Mode** is automatically disabled when you change destinations.

### Using Live Switch Source Mode



The **Live Switch Source Mode** turns both rows of the **Source Selection Bus** into a live "Program" bus. For a selected layer, when a source button is pressed, the layer switches to the new source. This is a "cuts only" mode — without any transitions.

- Use the following steps to utilize the **Live Switch Source Mode**:
  1. On the **Destination Bus**, enable the desired destination(s).
  2. On **Preview**, select the *one layer* that you want to remain enabled when you enter the live mode. All other **Preview** layers will be cleared.
  3. Press **Shift + Source**. The **Source** button lights to indicate the mode is enabled.
    - ~ When you first enter the mode, all layers on **Preview** (except the selected one) are cleared. All layers on **Program** remain as is.
    - ~ Both rows of the **Source Selection Bus** are now a live **Program Bus**, and all of your inputs are available.
  4. With the mode enabled, there are several ways you can switch:
    - ~ Select a layer and a function (PIP or Key) that is *not* already on **Program**. Its "last selected" source appears on **Preview**. Size and position the layer in the normal way. Select a source to immediately cut that layer to **Program**.
    - ~ Select a layer already on **Program**. Select a source to immediately cut that source into the Program layer.
    - ~ Use the **Clear Layer** function to transition layers off of the **Program** bus.

#### Note

When you press Clear Layer, the **Live Switch Source Mode** is automatically cancelled.

## 7. Operations

### Working with Live Modes

5. To clear the entire mode, press **Shift + Source**. The button turns off, and the entire **Source Selection Bus** is returned to its normal functionality.

Please note the following points regarding the **Live Switch Source Mode**:

- When switching directly on **Program**, the Controller uses a predefined set of rules. Refer to the "[Live Mode Source Timing](#)" section page 342 for details.
- When you enable the mode, the following rules apply:
  - ~ If **Split** mode was enabled, it remains enabled. If a layer is on Program and you select a new source, the layer automatically cuts to the new source without any transition.
  - ~ If **Mix** mode was enabled, the system forces **Mix Source** and **Toggle** on. When you select a new source, it is routed to Preview, and once it is stable, the layer automatically cuts to Program.
- Program LEDs are disabled on the **Source Selection Bus** only — but not in the **Layer Control Section**. The only exception is that a blinking Red LED on Program still indicates that the associated mixer is set to **Mix Mode**.
- If a layer is on Preview only, the PIP or Key can be sized and positioned.
- You can program a "move" with a source already on Program. When you press **Move Setup**, you can move the raster box on Preview and choose the "destination" location and size.
- When using the mode in conjunction with **Presets**, the following rules apply:
  - ~ When learning Presets, they will still be learned from Preview.
  - ~ When recalling Presets, they will still be recalled to Preview.
  - ~ A Preset remembers if the **Live Switch Source Mode** was active at the time it was learned. Upon recall, the mode is enabled automatically.
- The **Live Switch Source Mode** is automatically disabled when you change destinations.

## Live Mode Source Timing

When using "live" functions (as outlined above) directly on **Program**, it is not necessary to have genlocked sources.

- If the timings between selected sources do not match, the layer briefly goes to **Black** when the switch occurs, in order to provide a clean transition between dissimilar timings.
- If the sources have the same timing and are genlocked, the layer performs a clean "cut," and does not go to **Black** during the switch.

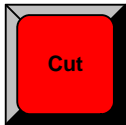
---

## Working with Transitions

This section provides instructions for performing a variety of transitions. The following topics are discussed:

- [Cut](#)
- [Mix](#)
- [Wipe](#)
- [Manual Transitions](#)

### Cut



Cuts can be performed on both single screen and widescreen destinations.

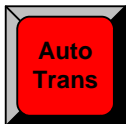
■ Use the following steps to perform a **Cut**:

1. Set up the desired “look” in Preview.
2. In the **Transition Section**, press **CUT** to instantly cut the setup to Program.

Cuts can also be performed directly on Program in the following three modes:

- **Modify Layers on Program** is enabled. Refer to the "[Modifying Layers On Program](#)" section on page 328 for details.
- **Live Switch Program/Preview Mode** is enabled. Refer to the "[Using Live Switch Program/Preview Mode](#)" section on page 340 for details.
- **Live Switch Source Mode** is enabled. Refer to the "[Using Live Switch Program/Preview Mode](#)" section on page 340 for details.

### Mix



A Mix (or Dissolve) can be performed on both single screen and widescreen destinations.

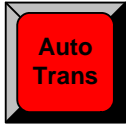
■ Use the following steps to perform a **Mix**:

1. Set up the desired “look” in Preview.
2. Preset the mode and transition rate:
  - a. In the **System Keypad**, press **EFFECTS** to display the **Effects Menu**.
  - b. Adjust the **Transition Rate** field, in 0.1 second increments.
  - c. In the **Transition Type** field, select **Mix**.
3. In the **Transition Section**, press **AUTO TRANS** to dissolve the setup to Program.

## 7. Operations

### Working with Transitions

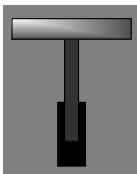
## Wipe



All types of wipes can be performed on single screen destinations. On widescreen destinations, you can only perform a **Wipe Up** or a **Wipe Down**.

- Use the following steps to perform a **Wipe**:
  1. Set up the desired “look” in Preview.
  2. Preset the desired transition rate, wipe effect and wipe edge:
    - a. In the **System Keypad**, press **EFFECTS** to display the **Effects Menu**.
    - b. Adjust the **Transition Rate** field, in 0.1 second increments.
    - c. In the **Transition Type** field, select the desired **Wipe** pattern.
    - d. In the **Transition Edge Width** field, select the desired wipe edge.
  3. In the **Transition Section**, press **AUTO TRANS** to wipe the setup to Program.

## Manual Transitions



Cuts and wipes can be performed manually with the **T-Bar**.

- Use the following steps to perform a manual transition:
  1. Set up the desired “look” in Preview.
  2. Using the **Effects Menu**, select a **Wipe** or **Mix** in the normal way.
  3. In the **Transition Section**, move the **T-Bar** to manually dissolve (or wipe) the images from Preview to Program.



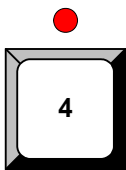
## Working with Presets

This section provides detailed instructions for working with Presets. On the Controller, the **Preset Section** enables you to store and recall entire setups. Each Preset button represents one “look” of the entire Controller, including the current state of all mixers, layers, sources, backgrounds and the DSK.

The following topics are discussed:

- [A Word About Resources](#)
- [Storing Presets](#)
- [Recalling Presets](#)
- [Deleting Presets](#)
- [Using Next and Previous](#)
- [Presets and Moves](#)
- [Preset Notes](#)

### A Word About Resources



Resources, as they apply to Presets, are the layers that comprise the current “look.”

- The contents of a Preset are locked to the mixers from which they were originally stored. For example, if you store a Preset that only has Layers **1A** and **1B** enabled on Preview, that Preset can only be recalled into **Mixer 1**.
- When you store a Preset, you are not only recording the Controller’s entire look, but you are also recording the priorities of the individual layers (PIPs and Keys) as selected in the **Layer Control Section**.
- When you recall a Preset, you are recalling the entire setup, and all previously stored priorities — PIPs, Keys, Colors, Sources, Moves, etc.

Several “resource” examples are provided below:

▲ **Example 1:** Split — No conflict.

- a. Enable **Split** mode.
- b. Store a Preset that contains **Source 1** on **Layer 1A**, and **Layer 1B** clear.
- c. Take **Source 2** to Program on **Layer 1A**.
- d. Recall the Preset.

You *can* recall the Preset to Preview, because the system temporarily borrows scaler **1B** to avoid a resource conflict.

▲ **Example 2:** Split — Conflict.

- a. Enable **Split** mode.
- b. Store a Preset that contains **Source 1** on **Layer 1A**, and **Layer 1B** clear.
- c. Take **Source 2** to Program on **Layer 1A**, and **Source 3** to Program on **Layer 1B**.
- d. Recall the Preset.

You *cannot* recall the Preset to Preview, because both scalars are in use. A “resource conflict” message is shown.

## 7. Operations

### Working with Presets

#### ▲ Example 3: Mix — No conflict.

- a. Enable **Mix** mode.
- b. Store a Preset that contains **Source 1** on **Layer 1A**.
- c. Take **Source 2** to Program on **Layer 1A**.
- d. Recall the Preset.

You *can* recall the Preset to Preview, because there is always a layer available in **Mix Mode**. The system will pick the available layer based on resources (e.g., if you stored the Preset in **Layer 1A**, the system may recall it to **Layer 1B** — if **Layer 1A** is already in use).

#### ▲ Example 4: Store a Split, Recall a Mix — No conflict.

- a. Enable **Split** mode.
- b. Store a Preset that contains **Source 1** on **Layer 1A**, and **Source 2** on **Layer 1B**.
- c. Enable **Mix** mode.
- d. Store a second Preset that contains **Source 1** on **Layer 1A**.
- e. Recall the first (Split) Preset, and take it to Program.
- f. Recall the second (Mix) Preset. The system recalls the Preset to Preview, but the **Split** button *blinks* to indicate that the mode will change to **Mix** when you transition.
- g. At this point, you can perform the transition, or press the **Split** button to keep the mixer in **Split** mode.

With these facts in mind, you may wish to store (and organize) your Presets according to the use of resources:

- For example, you could store Presets on **Page 1** that only use one PIP, and presets on **Page 2** that use two PIPs.
- As an alternate method, you may want to plan your presentations such that Presets are always recalled to an “empty” Program setup (with only a background visible). This method avoids all resource issues entirely.

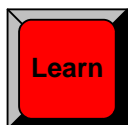
## Storing Presets

Please note the following important points:

- The **Controller SC** includes buttons for 64 Presets (8 pages of 8 presets each).
- The **Controller LC** has buttons for 900 Presets (30 pages of 30 presets each).

■ Use the following steps to store a preset:

1. Set up the desired “look” on Preview. Remember that one preset equals a single “look” of the Controller, including the current state of all mixers, layers, sources, backgrounds and the DSK.
2. Select the “page” on which you want to store the preset. In the **Preset Section**, hold down **Page**, then press the desired **Preset** button. The **Red LED** above the button lights to indicate the current page.
3. To store the preset, press **Learn +** the desired **Preset** button. The Touch Screen displays a confirmation message, and the overall look of the Controller is now saved into that register.



## Recalling Presets

- Use the following steps to recall a preset:
  1. Check the available resources on Program. If the resources (layers) that you wish to recall are already in use on Program, they must first be cleared before the "recall" is permitted. Refer to the "[A Word About Resources](#)" section on page 345 for additional information.
  2. Using the **Preset Recall Options Menu**, set up your Preset "recall" options. To access the menu, press **PRESETS** on the **Home Menu**, or press **Presets** in the **Keypad Section**. For each recall operation, you can elect to include or exclude the background, DSK and/or PIP borders. In Chapter 5, refer to the "[Preset Recall Options Menu](#)" section on page 208 for more information.

### Important

The recall configuration (as set on the **Preset Recall Options Menu**) is global, and it affects all recalls from that point forward, until changed.

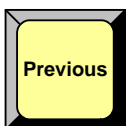
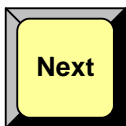
3. Select the "page" from which you want to recall the preset. In the **Preset Section**, hold down **Page**, then press the desired **Preset** button. The **Red LED** above the button lights to indicate the current page.
4. To recall a Preset, simply press the desired **Preset** button to recall the stored "look" to Preview.

## Deleting Presets



- Use the following steps to delete a preset:
  1. Select the "page" from which you want to delete a preset. In the **Preset Section**, hold down **Page**, then press the desired Preset button.
  2. In the **Preset Section**, hold down **Delete**, then press the desired Preset button to delete that register from memory.

## Using Next and Previous



- Use the following steps to utilize the **Next** function:
  1. Check the available resources on Program. If the resources that you wish to recall are in use on Program, they must first be cleared. Refer to the "[A Word About Resources](#)" section on page 345 for additional information.
  2. In the **Preset Section**, press **Next** to recall the next valid Preset in sequential order, or press **Previous** to recall the previous Preset. Please note:
    - ~ If a Preset is undefined, it will be skipped when **Next** or **Previous** is pressed.
    - ~ Both the **Next** and **Previous** functions include the ability to "wrap" to the next or previous page.

## 7. Operations

### Working with Presets

## Presets and Moves

Encore's Preset mode provides a unique "**automatic pend move**" feature:

- If you store several Presets, for example, with the same PIP in different sizes and positions on screen, the system automatically pends a **Move** when you recall each Preset. You do *not* have to store the PIP with a **Move Setup** enabled.

In this way, when you cut each Preset to Program, the PIP moves from point to point. The end point of the last move becomes the starting point for the next move — regardless of the sequence in which the Presets are recalled.

- The following rules apply:
  - ~ The layer stored in each Preset must be the same, the source must be the same, and PIP parameters (in general) must be the same. If any of these parameters are different, the system will not pend the move.
  - ~ In this mode, all key frame effects are **LINEAR**. If you want to use other key frame effects such as **LINEAR ACCL** or **ARCH CW**, you must purposely store the PIP with a **Move Setup**.
- For a given PIP, the following effects are valid "move" parameters, each of which will transition smoothly from point to point. You can change any of these parameters, and the system will pend a move:
  - ~ PIP or Key size and position
  - ~ PIP or Key source size and position
  - ~ PIP Shadow size and position
  - ~ PIP or Key Crop values

If you change any other parameters, such as shadow opacity, border color, border style, image effects, etc., the system will not pend the move.

- If you recall a Preset with a defined **Move** to an empty layer, both the starting and ending points of the recalled **Move** will be used.

## Preset Notes

Please note the following important points regarding Presets:

- **Destinations** — Active destinations (standard and Aux) are stored in Presets. If a Destination which was saved in a Preset goes off-line, the Preset recalls "looks" on those Destinations that are still available.
- **Modification Status** — The "active for modification" status of a layer is stored (and recalled) in a Preset.
- **Aux Sources** — Aux source selections are saved and recalled in Presets.
- **Barco Events Manager** — All "resource" rules apply when Presets are used in conjunction with the **Barco Events Manager** application.
- **MMC Cards** — Presets starting with page 15, Preset 1 (and above) can be saved provided an **MMC** or **MMCPlus** card (512MB or larger) is installed in the Multi-media card slot in the back of the Controller. If you attempt to save into these Preset locations without an MMC card, an error message will be shown.

Note that these Presets (page 15, Preset 1 and above) are saved in a separate location on the MMC card, and will not interfere with any backup and restore operations. When a **Backup** is performed, the "**Formatting Card**" step does *not* delete any existing Presets that were stored on the card prior to the backup.

---

## Layer and Aux Control

**Note**

The **Layer** and **Aux Control** features are currently not implemented.



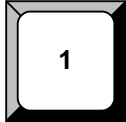
**AUX** — Information to be provided.

## 7. Operations

### Working with User Keys

---

## Working with User Keys



Encore's **User Key** feature enables you to select all (or a portion) of the current layer's attributes (such as border color, size, effects, etc.), and store them on a **User Key**. Those attributes can then be applied to any active layer on Preview. Please note:

- On the Controller LC only, 100 user keys are available — 10 pages of 10 keys each. The feature is not available on the Controller SC.

The following topics are discussed:

- [Storing User Keys](#)
- [Applying User Keys](#)
- [User Key Notes](#)

### Storing User Keys

- Use the following steps to store a User Key with a layer's attributes:
  1. Select the layer whose PIP parameters you want to store.
  2. Press **USER KEYS** on the **Home Menu** (or press **User Copy** in the **Layer Function Section**) to display the **User Key Copy Setup Menu**.
  3. Using the menu, enable or disable the specific parameters that you wish to store (e.g., **Position**, **Size**, **Input Source**, etc.). You can also enable or disable all parameters using the **{ALL ON}** and **{ALL OFF}** buttons.
  4. In the **User Key Section**, press and hold the **Page** button, then press the desired **User Key** (1 to 10) to switch to that page.
  5. To store the PIP's attributes in a specific user key, press and hold **User Copy**, then press the desired **User Key**.
  6. Repeat from step 1 to store additional **User Keys**.

### Applying User Keys

- Use the following steps to apply the contents of a User Key to a selected layer:
  1. Select the layer onto which you want to apply the contents of a User Key.
  2. In the **User Key Section**, select the desired **Page**, then press the desired **User Key** to apply its parameters.

### User Key Notes

Please note the following important points regarding User Keys:

- **User Keys** work for both PIPs and Keys.
- If the selected layer is a Key, when a **User Key** is learned, it remembers the state of the Key (e.g., clip, gain, etc.) even though those options are not listed in the menu. If you apply this specific **User Key** to a PIP, it changes to a Key.

---

# Working with Tallies

The "Tally" function can be enabled or disabled as required.

- Use the following steps to enable or disable tallies:
  1. Ensure that your tallies are properly set up. In Chapter 6, refer to the "[Output Format Setup](#)" section on page 285 for instructions.
  2. In the **System Keypad**, press **SYSTEM** to display the **System Menu**.
  3. On the **Tally Mode** line:
    - ~ Select **On** to enable all assigned tally relay closures.
    - ~ Select **Off** to disable all assigned tally relay closures.

Please note:

- Remember that tallies are mapped to inputs. When **Tally Mode** is **On**, if a "mapped" tally goes to Program, one of the associated eight tally circuits turns on.
- When the "mapped" input is removed from Program, the associated tally turns off.
- Tally functionality can be tested. On the **System Menu**, press **{DIAG} > {TALLY}** to initiate the test.
- In Appendix A, refer to the "[Tally Connector](#)" section on page 374 for pinout details.

## 7. Operations

### Enable/Disable Controller Lockout

---

## Enable/Disable Controller Lockout

This section provides instructions for locking and unlocking the Controller.

▲ **Prerequisite:**

- ~ Ensure that you are familiar with the **Lockout Code Menu** and its associated submenu. In Chapter 5, refer to the "[Lockout Code Menu](#)" section on page 199.

■ Use the following steps to enable Controller panel lockout:

1. On the **Lockout Code Menu**, select the type of lockout code you wish to use: **Default** or **Custom**.
2. If **Custom** is selected, use the **Change Lockout Code Menu** to enter the desired code. Be sure to make a note of the selected code.
3. To enable Controller lockout, press and hold the **CANCEL** button in the **System Keypad**, then press the **ALL** button in the **Layer Functions Section**. The message "**KEYBOARD LOCKED**" appears on the menu.

■ Use the following steps to disable Controller panel lockout:

1. Press and hold the **CANCEL** button in the **System Keypad**, then press the **ALL** button in the **Layer Functions Section**. The **Enter Lockout Code** menu appears.
2. Use the first eight numbered buttons on the **Preset Bus** to enter the code.
  - ~ If the correct code has been entered, the message "**Unlocking Controller**" appears on the display, and the Controller is ready for use.
  - ~ If the incorrect code has been entered, the Controller remains locked.

**Important**

If you have selected a **Custom** lockout code, but you have forgotten the code, a **Master Code** is always available. Refer to the Encore system's most current "**What's New**" document for details. This document is bundled with every software download. Note that the **Master Code** changes with each software version.



---

## Using Backup and Restore

The Encore system enables you to backup and restore all (or a portion) of the complete system configuration setup using a customer supplied flash memory card. The following topics are discussed:

- [System Backup](#)
- [System Restore](#)

### System Backup

This procedure enables you to back up all (or a portion) of the entire Encore system configuration. Please note the following important points:

- You can only store one system configuration on a Flash Memory Card.
  - Customer supplied Flash Memory Cards must be equal to or greater than 512MB.
- Use the following steps to back up your system:
1. Ensure that you have a (customer supplied) **Flash Memory Card** available.
  2. Insert the **Flash Memory Card** into the Controller's rear panel **Memory Card** slot.
  3. Press **MISC** on the **Home Menu**, or press **MISC** in the **System Keypad**.
  4. Press **{BACKUP RESTORE}** to display the **Backup/Restore Menu**.
  5. On the **Device** line, select the combination of devices you want to back up:
    - ~ **Ctrlr** — backs up the Controller only.
    - ~ **VP+SP** — backs up the Video Processors and ScreenPRO-IIs only.
    - ~ **Ctrlr+VP+SP** — backs up the Controller, the Video Processors and any ScreenPRO-IIs.
  6. On the **Controller Options** line, select which portion of the selected devices you want to back up. Choose between **All**, **System** or **Presets**.
  7. Press **{CHECK CARD}** to display the **Current Backup Menu**.
    - ~ Check the "**Controller files backed up**" section to confirm the types of files present on the Flash Memory Card, if any. (e.g., System, Presets, ScreenPRO-II). If files are present, determine if you want to overwrite, or insert a new (blank) card.
    - ~ Press **{BACK}** to return to the **Backup/Restore Menu**.
  8. Press **{BACKUP}** to backup your system to the Flash Memory Card using the selected device(s) and options.

## 7. Operations

### Using Backup and Restore

## System Restore

Please note the following important points regarding the "restore" function:

- When restoring, you must have the same version of software installed in the Controller as was used to perform the backup.
- Conversion between versions can only be done with the **Barco Backup and Restore** utility.

#### Note

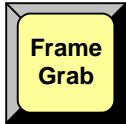
The **Barco Backup and Restore** utility can be found in the Encore Presentation System software bundle — available via download from the Barco website.

- Use the following steps to restore your system from the flash memory card:
  1. Ensure that your flash memory card is properly inserted in the Controller's **MEMORY CARD** slot.
  2. Press **MISC** on the **Home Menu**, or press **MISC** in the **System Keypad**.
  3. Press {**BACKUP RESTORE**} to display the **Backup/Restore Menu**.
  4. Press {**CHECK CARD**} to display the **Current Backup Menu**.
    - ~ Check the "**Controller files backed up**" section to confirm the types of files present on the Flash Memory Card (e.g., System, Presets, ScreenPRO-II).
    - ~ Check the "**VP/SPs backed up**" section to confirm the IDs of the processors that are backed up.
    - ~ Press {**BACK**} to return to the **Backup/Restore Menu**.
  5. On the **Device** line, select the combination of devices you want to restore:
    - ~ **Ctrlr** — restores up the Controller only.
    - ~ **VP+SP** — restores the Video Processors and ScreenPRO-IIs only.
    - ~ **Ctrlr+VP+SP** — restores the Controller, the Video Processors and any ScreenPRO-IIs.
  6. On the **Controller Options** line, select which portion of the selected devices you want to restore. Choose between **All**, **System** or **Presets**.
  7. On the **VP/SP to Restore** line, select the device(s) that you wish to restore. Choose between **All** devices, or the ID of a specific device (e.g., **1**, **2**, **3**).
  8. Press {**RESTORE**} to restore the selected system configuration.

At the conclusion of this procedure, your system is completely restored — exactly the way that you left it when you performed a complete system "backup."

---

## Working with Frame Grabs



The following topics are discussed in this section:

- [Frame Capture Overview](#)
- [Capturing Frames from a Background or DSK Input](#)
- [Capturing Frames from a Layer](#)
- [Saving Frames in Permanent Memory](#)
- [Naming a Saved Frame](#)
- [Erasing and Deleting Frames](#)

Please note the following important prerequisites to all frame grab procedures:

- Ensure that you are familiar with the **Background Input Setup Menu**. In Chapter 5, refer to the "[Background Input Setup Menu](#)" section on page 237.
- Ensure that you are familiar with the **Frame Grab Menu**. In Chapter 5, refer to the "[Frame Grab Menu](#)" section on page 245 for details.

### Frame Capture Overview

The Encore system enables you to capture frames into the VP's three internal frame stores. The "sources" of the frames are the background inputs on each VP (and VPx), or any active layer. Please note:

- For single screen and ScreenPRO-II destinations, you are working with the individual destination's three frame stores (**FG\_1**, **FG\_2** and **FG\_3**) as normal.
- For widescreen destinations, even though you are using the frame stores of *multiple* Processors, you are "operationally" working with only three frame stores (**FG\_1**, **FG\_2** and **FG\_3**) — each of which captures its "slice" of the complete widescreen image.
- For "stack" systems, remember you have six "temp" frame stores available, and your menus will change accordingly:
  - ~ Three frame stores are available for the "bottom" stack Processor:
    - **BG\_FG\_1**, **BG\_FG\_2** and **BG\_FG\_3**.
  - ~ Three frame stores are available for the "top" stack Processor:
    - **DSK\_FG\_1**, **DSK\_FG\_2** and **DSK\_FG\_3**.

Please note the following important points regarding "stack" configurations:

- ~ In a stacked configuration, you can not capture frames on the **bottom ME board** of the **top VP**. This is necessary because the background channels of this ME board are in use, to facilitate the transfer of data from the bottom VP to the top VP — and thus, the channels can't be used to simultaneously capture frames.

## 7. Operations

### Working with Frame Grabs

The following table illustrates the valid layers from which to capture DSK frames, depending on the number of M/Es in your system.

**Table 7-2.** Where to capture frames on stacked configuration systems

Number of M/Es on Bottom VP	Frame Store Type	Valid Capture Layers
3	DSK_FG_#	DSK, 5A, 5B, 6A, 6B
2	DSK_FG_#	DSK, 4A, 4B, 5A, 5B
1	DSK_FG_#	DSK, 3A, 3B, 4A, 4B

Encore provides complete flexibility with regard to frame grabs:

- **Temporary Frame Stores** — The Encore Video Processor has three temporary (temp) frame stores (**FG\_1**, **FG\_2** and **FG\_3**) which function as the three sources from which “on-air” frames originate. During operations, you can:
  - ~ Capture (grab) frames to any “temp” frame store.
  - ~ Assign any temp frame store to **BG A**, **BG B** or the **DSK**.
  - ~ Download a frame from “permanent” storage into any temp frame store for use on-air.
  - ~ Overwrite any temp frame store with a new capture.

**Note**

All frames in “temp” storage are lost when the system is powered down.

- **Capture Sources** — All frame grabs are *full screen* captures. A frame can be captured from **BG A**, **BG B**, the **DSK**, or any of the scaled inputs (layers).

The following important rules apply:

- ~ If **BG A**, **BG B**, or the **DSK** is on **Program**, a frame cannot be captured. If you attempt a capture, you will get an error message.
- ~ If **BG A**, **BG B**, or the **DSK** is selected on **Preview** (and *none* of those three layers are on **Program**), a frame *can* be captured.
- ~ If you select a **layer** on **Preview** or **Program**, a frame *can* be captured — provided that **BG A**, **BG B**, or the **DSK** is not on **Program**.
- ~ In order to capture a frame from **BG A**, **BG B**, or the **DSK**, the background input “type” must be set to Analog or DVI. If it is not, you will get an error message.

**Note**

Because all grabs are full screen captures, when you capture a layer, you will capture the selected PIP with no borders, and with black as the background.

Once captured, a frame can be assigned as the input “type” for **BG A**, **BG B**, or the **DSK** — basically any “green” button in the **Layer Control Section**.

- **Permanent Frame Stores** — As standard, the Encore Video Processor has three permanent (non-volatile) frame stores available. Please note:
  - ~ Frames in permanent storage are not lost when the system is powered down. At bootup, all frames from the three "permanent" frame stores are read into temp memory for use on-air.
  - ~ In a standard Encore system, at any one time you could have a maximum of three frames in temporary memory, and three *different* frames in permanent memory.
  - ~ Permanent frames can be overwritten, deleted (flagged for deletion only), or erased (permanently deleted).
  - ~ Any frame in permanent memory can be named using a customer-supplied PS/2 keyboard.
- **Extended Frame Grab Option** — If the "ES" option is installed, you can store and recall 100 frames in non-volatile memory. Benefits include:
  - ~ Faster saves to permanent storage (20 - 30 seconds vs. 2 - 3 minutes)
  - ~ Direct recalls from permanent storage into temporary memory via Preset Recalls. Under this condition, you will experience a complete "draw to screen" time of approximately 4 - 6 seconds.

### Capturing Frames from a Background or DSK Input

- Use the following steps to capture a frame from a background input:
  1. Ensure that the background (or DSK) input from which you want to capture is properly set up as an Analog or DVI input. In Chapter 6, refer to the "[Background Setup](#)" and "[DSK Setup](#)" sections for instructions.
  2. Ensure that **BG A**, **BG B** or the **DSK** are not on Program. If they are, you will get a pop-up prompt. Transition these layers off Program in the normal manner.
  3. In the **Layer Control Section**, select the background (or DSK) from which you want to capture. The button blinks, the source appears on Preview, and the selected setup menu appears.
  4. In the **Layer Functions Section**, press **FRAME GRAB** to display the **Frame Grab Menu**.
  5. On the **Destination** line, select the destination for which you want to capture.
    - ~ If multiple destinations are active, select the desired destination.
    - ~ If a single destination is active, selections cannot be made.
  6. On the **ID** line, select the IDs of the Processor(s) for which you want to capture.
    - ~ For single screen destinations, ID selections cannot be made.
    - ~ For wide screen destinations only, select **All** to capture across all Processors, or select the **ID** of an individual processor.

#### Note

In the case of an individual **ID** selection, the frame will be grabbed only for that Processor — leaving the other "wide screen" portions of that frame store available.

7. On the **Frame Number** line, select the temporary frame store into which the frame will be captured (**FG\_1**, **FG\_2** or **FG\_3**). Remember that for "stack" systems:

## 7. Operations

### Working with Frame Grabs

- ~ Background frames are captured into the "bottom" stack Processor: **BG\_FG\_1**, **BG\_FG\_2** or **BG\_FG\_3**.
  - ~ DSK frames are captured into the "top" stack Processor: **DSK\_FG\_1**, **DSK\_FG\_2** and **DSK\_FG\_3**.
8. Press **{CAPTURE}**. Once pressed, the screen will indicate that the frame is being captured. A pop-up message confirms the procedure. In the **Name** field, the captured frame is listed as **UNSAVED**.
  9. Repeat the procedure to capture additional frames from a background (or DSK) input. Remember that you can always overwrite the selected frame store.

Please note:

- The captured frame(s) can now be assigned as the input "type" for **BG A**, **BG B** or the **DSK**. In Chapter 6, refer to the following sections for instructions:
  - ~ "[Background Setup](#)," page 291.
  - ~ "[DSK Setup](#)," page 296.
- Captured frames reside in temporary memory. If the system is powered down or reset, the frames will be lost. To save frames in permanent memory, refer to the "[Saving Frames in Permanent Memory](#)" section on page 359.
- Only "saved" frames can be named.

## Capturing Frames from a Layer

- Use the following steps to capture a frame from a layer.
  1. Ensure that **BG A**, **BG B** or the **DSK** are not on Program. If they are, you will get a pop-up prompt. Transition these layers off Program in the normal manner.
  2. In the **Layer Control Section**, select the layer (on either Program or Preview) from which you want to capture a frame. The button blinks indicating that it is "selected."
  3. Select **PIP** or **Key** in the normal manner. The selected **PIP** or **Key Adjustment Menu** appears.
  4. Adjust the PIP or Key's size and position. Remember that:
    - ~ The system will capture the "selected" layer in its *current size and position*, with no borders, and with black as the background.
    - ~ If you have two layers on Preview, only the active (selected) layer will be captured, regardless of image priority.
  5. In the **Layer Functions Section**, press **FRAME GRAB** to display the **Frame Grab Menu**.
  6. On the **Destination** line, select the destination for which you want to capture.
    - ~ If multiple destinations are active, select the desired destination.
    - ~ If a single destination is active, selections cannot be made.
  7. On the **ID** line, select the IDs of the Processor(s) for which you want to capture.
    - ~ For single screen destinations, ID selections cannot be made.

- ~ For wide screen destinations only, select **All** to capture across all Processors, or select the **ID** of an individual processor.

#### Note

In the case of an individual **ID** selection, the frame will be grabbed only for that Processor — leaving the other "wide screen" portions of that frame store available.

8. On the **Frame Number** line, select the temporary frame store into which the frame will be captured (**FG\_1**, **FG\_2** or **FG\_3**). Remember that for "stack" systems:
  - ~ Background frames are captured into the "bottom" stack Processor: **BG\_FG\_1**, **BG\_FG\_2** or **BG\_FG\_3**.
  - ~ DSK frames are captured into the "top" stack Processor: **DSK\_FG\_1**, **DSK\_FG\_2** and **DSK\_FG\_3**.
9. Press **{CAPTURE}**. Once pressed, the screen will indicate that the frame is being captured. A pop-up message confirms the procedure. In the **Name** field, the captured frame is listed as **UNSAVED**.
10. Repeat the procedure to capture additional frames from a layer. Remember that you can always overwrite the frame store.

Please note:

- The captured frame(s) can now be assigned as the input "type" for **BG A**, **BG B** or the **DSK**. In Chapter 6, refer to the following sections for instructions:
  - ~ "[Background Setup](#)," page 291.
  - ~ "[DSK Setup](#)," page 296.
- Captured frames reside in temporary memory. If the system is powered down or reset, the frames will be lost. To save frames in permanent memory, refer to the "[Saving Frames in Permanent Memory](#)" section on page 359.
- Only "saved" frames can be named.

## Saving Frames in Permanent Memory

- Use the following steps to save a captured frame into permanent memory.
  1. Capture a frame as outlined in the previous two sections.
    - ~ "[Capturing Frames from a Background or DSK Input](#)" on page 357.
    - ~ "[Capturing Frames from a Layer](#)" on page 358.
  2. On the **Frame Grab Menu**, use the **Frame Number** line to select the frame that you wish to save.

#### Warning

Do not execute the next step during live production. All controls will be locked during the "save" process. Always try to save your frames during pre-production.

3. Press **{SAVE}** to save the captured frame into a storage register. Remember that three registers are available in standard systems, and 100 registers are available in "ES" systems.
  - ~ In standard systems, the **Frame Save Menu** appears.

## 7. Operations

### Working with Frame Grabs

- Press **YES** to save the frame. All front panel controls will be locked for up to three minutes.
  - Press **NO** to cancel the procedure.
- ~ In "ES" systems, the **Extended Frame Save Menu** appears.
- In the **Saved Location** field, select a memory location (**1 - 100**).
  - (Optional) In the **New Name** field, type a new name. Ensure that a PS/2 keyboard is properly connected to the Controller's **Keyboard** port.
  - Press **{SAVE}** to save the selected frame. All front panel controls will be locked for up to three minutes.

#### Note

Remember that you can always overwrite a frame in permanent memory.

4. Repeat the procedure to save additional frames.

## Naming a Saved Frame

- Use the following steps to name (or rename) a saved frame.
1. Ensure that the frame you wish to name has either been captured, or saved in permanent memory.

#### Note

If the frame has only been captured, you can use the "Save" procedure to both save and name the frame simultaneously. Refer to the "[Saving Frames in Permanent Memory](#)" section on page 359 for details.

#### Note

If you are using a ScreenPRO-II destination, ensure that the **Tally** option is physically installed.

2. Ensure that a (customer supplied) PS/2 keyboard is connected to the Controller's **Keyboard** connector.
3. On the **Frame Grab Menu**, press **{NAME}** to display the **Frame Grab Name Menu**.
4. On the **Saved Location** line, select the frame that you wish to name.
5. Using the keyboard, enter the desired name. As you type, characters will appear in the menu's **New Name** field.
6. Press **Enter** (on the PS/2 keyboard) to save the new name. Once saved, the system "attaches" the name to the frame in permanent memory.
7. Repeat the procedure to name additional frames.



## Erasing and Deleting Frames

Please remember the following rules regarding erasing and deleting frames:

- The "**delete**" procedure enables you to *mark* a selected frame as deleted — but the **ERASE** function is *still required* for permanent deletion. You can consider this as a "quick" delete function.
  - The "**erase**" procedure is a "destructive" process that enables you to *permanently* erase a selected frame. This process takes from 1 to 2 minutes, and locks the console during the procedure.
- **(Standard Systems — Delete)** Use the following steps to delete a saved frame.
1. On the **Frame Grab Menu**, select the frame store that you wish to delete.
  2. Press **{DELETE}** to display the **Frame Delete Menu**.
  3. Press **{YES}** to delete the selected frame.
  4. Repeat the procedure to delete additional frames.
- **("ES" Systems — Delete)** Use the following steps to delete a saved frame.
1. On the **Frame Grab Menu**, press **{DELETE}** to display the **Frame Delete Menu**.
  2. On the **Saved Location** line, select the frame that you wish to delete.

### Note

The **ADJ** knob only scrolls through saved frames.

3. Press **{DELETE}** to delete the selected frame.
  4. Repeat the procedure to delete additional frames.
- **(Standard Systems — Erase)** Use the following steps to erase a saved frame.
1. On the **Frame Grab Menu**, select the frame store that you wish to erase.
  2. Press **{ERASE}** to display the **Frame Erase Menu**.
  3. Press **{YES}** to erase the selected frame. All front panel controls will be locked for 1 to 2 minutes.
  4. Repeat the procedure to erase additional frames.
- **("ES" Systems — Delete)** Use the following steps to erase a saved frame.
1. On the **Frame Grab Menu**, press **{ERASE}** to display the **Frame Erase Menu**.
  2. On the **Saved Location** line, select the frame that you wish to erase.

### Note

The **ADJ** knob only scrolls through all frames, giving you access to all 100 registers.

3. Press **{ERASE}** to erase the selected frame.
4. Repeat the procedure to erase additional frames.

## 7. Operations

### Working with the DSK

---

## Working with the DSK



- Use the following steps to perform a downstream key:
  1. Ensure that the **DSK** is properly set up, and the key "**type**" is selected on the **DSK Input Setup Menu**. In Chapter 6, refer to the "[DSK Setup](#)" section on page 296 for instructions.
  2. Please remember the following important DSK rules:
    - ~ For ScreenPRO-II destinations, remember that **BG B** and the **DSK** are mutually exclusive.
    - ~ For single or wide screen Encore systems using single M/E Video Processors, there are only two DVI input connectors available (**1A** and **1B**). In this configuration, you cannot use both backgrounds and the DSK — you can only use two of the three.
    - ~ For stack configurations, remember that DSK sources connect to the "top" stack Processor.
  3. In the **Layer Control Section**, press **DSK** to display the **DSK Adjustment Menu**.
  4. On the **Destination** line, select the destination on which you want to perform the downstream key.
    - ~ If multiple destinations are active, select the desired destination.
    - ~ If a single destination is active, selections cannot be made.
  5. On the **ID** line, select the IDs of the Processor(s) on which you want to perform the downstream key.
    - ~ For single screen destinations, ID selections cannot be made.
    - ~ For wide screen destinations only, select **All** to set up all Processors, or select the **ID** of an individual processor.
  6. On the **Key Type** line, select **Luma** or **Color** as required.
  7. Adjust DSK parameters, including key type, invert, clip, gain, opacity and fill source. Refer to the "[Modifying Keys](#)" section on page 326 for details.

#### Note

Not all parameters listed in the "[Modifying Keys](#)" section apply to a DSK.

8. Perform a **CUT** or **AUTO TRANS**.
9. Clear the **DSK** from Program in the normal manner — by clearing its layer from Preview and then transitioning.

# A. Specifications

---

## In This Appendix

This appendix provides detailed technical specifications for the Encore Presentation System. The following topics are discussed:

- [Input Specifications](#)
- [Output Specifications](#)
- [Physical and Electrical Specifications](#)
- [Communications Specifications](#)
- [Pinouts](#)
- [Input and Output Resolutions](#)

## A. Specifications

### Input Specifications

The table below lists Encore Video Processor input specifications.

**Table A-1.** Encore Video Processor Input Specifications

Input	Parameter	Specification
Mixer/Effects Channels (2 per M/E board)	Analog Inputs	RGBHV / RGBS / RGsB computer video, YPbPr video (SD or HD), S-video, or Composite video on 15-pin HD connector
	SD and HDSDI Input	Per SMPTE 259M-C (NTSC / PAL resolution) SMPTE 292M (HDTV) on BNC connector
	DVI Input	Per DDWG 1.0 on DVI-I connector
	Input Resolutions	<ul style="list-style-type: none"> <li>• NTSC/PAL</li> <li>• Computer Resolutions VGA (640 x 480) through UXGA (1600 x 1200)</li> <li>• HDTV Resolutions up to 1920 x 1080 (720p, 1080i, 1080p)</li> <li>• 2048 x 1080p (Digital Cinema format)</li> <li>• Plasma Display Resolutions</li> </ul>
Native Resolution Background Channels (2 per M/E board)	Analog Inputs	RGBHV computer video on DVI-I connector
	DVI Input	Per DDWG 1.0 on DVI-I connector
	Input Resolutions	<ul style="list-style-type: none"> <li>• Computer Resolutions: SVGA (800 x 600) through UXGA (1600 x 1200)</li> <li>• HDTV Resolutions (720p, 1080p)</li> <li>• 2048 x 1080p (Digital Cinema format)</li> <li>• Plasma Display Resolutions</li> </ul>
Downstream Key Input (1 per Encore Video Processor)	Analog Inputs	RGBHV computer video on DVI-I connector
	DVI Input	Per DDWG 1.0 on DVI-I connector
	Input Resolutions	<ul style="list-style-type: none"> <li>• Computer Resolutions: SVGA (800 x 600) through UXGA (1600 x 1200)</li> <li>• HDTV Resolutions (720p, 1080p)</li> <li>• 2048 x 1080p (Digital Cinema format)</li> <li>• Plasma Display Resolutions</li> </ul>
Frame Lock Input		NTSC/PAL black burst reference on BNC Connector

## A. Specifications

### Input Specifications

The table below lists Encore VPx input specifications.

**Table A-2.** Encore VPx Input Specifications

Input	Parameter	Specification
Via "Source Link" Input	Analog Video	RGBHV / RGBS / RGsB computer video, YPbPr video (SD or HD), S-video, or Composite video
	SD and HDSDI Video	Per SMPTE 259M-C (NTSC / PAL resolution) SMPTE 292M (HDTV)
	DVI	Per DDWG 1.0
	Input Resolutions	<ul style="list-style-type: none"> <li>• NTSC/PAL</li> <li>• Computer Resolutions VGA (640 x 480) through UXGA (1600 x 1200)</li> <li>• HDTV Resolutions up to 1920 x 1080 (720p, 1080i, 1080p)</li> <li>• 2048 x 1080p (Digital Cinema format)</li> <li>• Plasma Display Resolutions</li> </ul>
Native Resolution Background Channels (2 per M/E board)	Analog Inputs	RGBHV computer video on DVI-I connector
	DVI Input	Per DDWG 1.0 on DVI-I connector
	Input Resolutions	<ul style="list-style-type: none"> <li>• Computer Resolutions: SVGA (800 x 600) through UXGA (1600 x 1200)</li> <li>• HDTV Resolutions (720p, 1080p)</li> <li>• 2048 x 1080p (Digital Cinema format)</li> <li>• Plasma Display Resolutions</li> </ul>
Downstream Key Input (1 per Encore Video Processor)	Analog Inputs	RGBHV computer video on DVI-I connector
	DVI Input	Per DDWG 1.0 on DVI-I connector
	Input Resolutions	<ul style="list-style-type: none"> <li>• Computer Resolutions: SVGA (800 x 600) through UXGA (1600 x 1200)</li> <li>• HDTV Resolutions (720p, 1080p)</li> <li>• 2048 x 1080p (Digital Cinema format)</li> <li>• Plasma Display Resolutions</li> </ul>

## A. Specifications

### Output Specifications

# Output Specifications

The table below lists Encore Presentation System output specifications.

**Table A-3.** Encore Video Processor Output Specifications, VP and VPx

Output	Parameter	Specification
Preview Output	Analog Outputs	RGBHV / RGSB / RGSB, YPbPr video (SD or HD), on 15-pin HD connectors
	DVI Output	Per DDWG 1.0 on DVI-I connector
Program Output 1	Analog Outputs	RGBHV / RGSB / RGSB, YPbPr video (SD or HD), on 15-pin HD connectors
	DVI Output	Per DDWG 1.0 on DVI-I connector
	HDSDI Output	Per SMPTE 259M-C (NTSC / PAL resolution) SMPTE 292M (HDTV) on BNC connector (Program Out)
Program Output 2	Function	This output can be programmed to serve as a second buffered program output or a monitoring program output
	Analog Outputs	RGBHV / RGSB / RGSB, YPbPr video (SD or HD), on 15-pin HD connectors
	DVI Output	Per DDWG 1.0 on DVI-I connector
	HDSDI Output	Per SMPTE 259M-C (NTSC / PAL resolution) SMPTE 292M (HDTV) on BNC connector (Program Out)
Output Resolutions		<ul style="list-style-type: none"> <li>• Computer Resolutions VGA (640 x 480) through UXGA (1600 x 1200)</li> <li>• HDTV Resolutions up to 1920 x 1080 (720p, 1080i, 1080p)</li> <li>• 2048 x 1080 (Digital Cinema format)</li> <li>• Plasma Display Resolutions</li> </ul>
Delay	50Hz	30ms max.
	60Hz	25ms max.

# Physical and Electrical Specifications

The table below lists Encore Presentation System physical and electrical specifications.

**Table A-4.** Encore Physical and Electrical Specifications

Parameter	Detail	Specification
Power	VP and VPx	120-240 VAC - 50/60 Hz., Auto-selecting 1.0A maximum
	Controllers	120-240 VAC - 50/60 Hz., Auto-selecting 1.7A maximum
Mechanical	VP and VPx	3 RU Rackmount Chassis
		H: 5.25 inches (13.34 cm)
		W: 17.00 inches (43.18 cm)
	Controller SC	D: 15.00 inches (38.10 cm)
		H: 10.60 inches (26.92 cm)
		W: 17.00 inches (43.18 cm)
	Controller LC	D: 22.14 inches (56.24 cm)
		H: 10.60 inches (26.92 cm)
		W: 44.54 inches (113.13 cm)
Weight	VP and VPx	D: 22.14 inches (56.24 cm)
		1 M/E: 27.8 lbs (12.61 kg)
		2 M/E: 30.5 lbs (13.83 kg)
	3 M/E: 33.2 lbs (15.05 kg)	
	Controller SC	28.9 lbs (13.11 kg)
Controller LC	55.8 lbs (25.31 kg)	
Temperature		0-40 degrees C
Humidity		0-95% non-condensing

## A. Specifications

### Communications Specifications

---

# Communications Specifications

The table below lists Encore Presentation System communications specifications.

**Table A-5.** Encore Communications Specifications

Parameter	Detail	Specification
RS-232	Video Processor	DB-9 Female, DCE, 115k Baud
	Controller (Console)	DB-9 Female, DCE, 115k Baud
	Controller (EXT COMM)	DB-9 Female, DCE, 115k Baud
Ethernet	Video Processor	RJ-45, 10/100 Mbps Autosense
	Controllers	RJ-45, 10/100 Mbps Autosense
Tally	Controllers	DB-25 Male, Dry-Contact Relay Closures
Keyboard Port	Controllers	PS/2 Connector
MultiMedia Card	Controllers	System specification version 3.31 compliant.



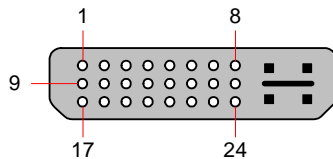
## Pinouts

The following topics are discussed in this section:

- [DVI Connector Pinouts](#)
- [DVI-I Connector Pinouts](#)
- [Analog 15-pin D Connector](#)
- [Ethernet Connector](#)
- [Serial Connector](#)
- [Tally Connector](#)

### DVI Connector Pinouts

The figure below illustrates the DVI connector:



**Figure A-1.** DVI Connector

The table below lists DVI Connector pinouts. Please note:

- T.M.D.S = Transition Minimized Differential Signal
- DDC = Display Data Channel

**Table A-6.** DVI Connector Pinouts

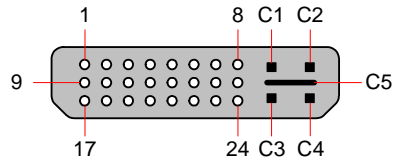
Pin	Signal	Pin	Signal
1	T.M.D.S. Data 2-	13	T.M.D.S. Data 3+
2	T.M.D.S. Data 2+	14	+5V Power
3	T.M.D.S. Data 2/4 Shield	15	ground (for +5V)
4	T.M.D.S. Data 4-	16	Hot Plug Detect
5	T.M.D.S. Data 4+	17	T.M.D.S. Data 0-
6	DDC Clock	18	T.M.D.S. Data 0+
7	DDC Data	19	T.M.D.S. Data 0/5 Shield
8	Analog Vertical Sync	20	T.M.D.S. Data 5-
9	T.M.D.S. Data 1-	21	T.M.D.S. Data 5+
10	T.M.D.S. Data 1+	22	T.M.D.S. Clock Shield
11	T.M.D.S. Data 1/3 Shield	23	T.M.D.S. Clock +
12	T.M.D.S. Data 3-	24	T.M.D.S. Clock -

## A. Specifications

### Pinouts

#### DVI-I Connector Pinouts

The figure below illustrates the DVI-I connector:



**Figure A-2.** DVI-I Connector

The table below lists DVI-I Connector pinouts. Please note:

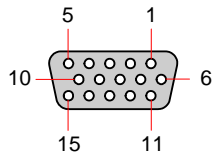
- T.M.D.S = Transition Minimized Differential Signal
- DDC = Display Data Channel

**Table A-7.** DVI-I Connector Pinouts

Pin	Signal	Pin	Signal
1	T.M.D.S. Data 2-	13	T.M.D.S. Data 3+
2	T.M.D.S. Data 2+	14	+5V Power
3	T.M.D.S. Data 2/4 Shield	15	ground (for +5V)
4	T.M.D.S. Data 4-	16	Hot Plug Detect
5	T.M.D.S. Data 4+	17	T.M.D.S. Data 0-
6	DDC Clock	18	T.M.D.S. Data 0+
7	DDC Data	19	T.M.D.S. Data 0/5 Shield
8	Analog Vertical Sync	20	T.M.D.S. Data 5-
9	T.M.D.S. Data 1-	21	T.M.D.S. Data 5+
10	T.M.D.S. Data 1+	22	T.M.D.S. Clock Shield
11	T.M.D.S. Data 1/3 Shield	23	T.M.D.S. Clock +
12	T.M.D.S. Data 3-	24	T.M.D.S. Clock -
MicroCross Pins			
C1	Analog Red Video	C4	Analog Horizontal Sync
C2	Analog Green Video	C5	Analog Common Ground Return
C3	Analog Blue Video		

## Analog 15-pin D Connector

The figure below illustrates the analog 15-pin D connector:



**Figure A-3.** Analog 15-pin D Connector

The table below lists Analog 15-pin D connector pinouts.

**Table A-8.** Analog 15-pin D Connector Pinouts

Pin	Signal	Pin	Signal
1	Red	9	
2	Green	10	GND
3	Blue	11	
4		12	
5		13	H Sync or C Sync
6	Red return	14	V Sync
7	Green return	15	
8	Blue return		

Note that each M/E's Analog Input connectors (**A** and **B**) accept a variety of analog formats including VGA, low-resolution composite video, S-video and YUV component video.

- For RGB with H and V sync, use the VGA connector directly.
- Using a (customer supplied) VGA to 5xBNC breakout cable, multiple input combinations are possible. Cells with check marks denote the connections required for the indicated format.

**Table A-9.** Analog Input Combinations using Breakout Cable

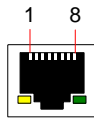
Breakout Cable Wire Color	Composite Video	S-Video (Y/C)	YUV (Y <sub>P</sub> P <sub>r</sub> )	RGB Sync on Green	RGB Comp Sync	RGB Separate H V
R		✓ (Chrom)	✓ (P <sub>r</sub> )	✓	✓	✓
G	✓	✓ (Lum)	✓ (Lum)	✓	✓	✓
B			✓ (P <sub>b</sub> )	✓	✓	✓
H Sync					✓	✓
V Sync						✓

## A. Specifications

### Pinouts

## Ethernet Connector

The figure below illustrates the Ethernet connector:



**Figure A-4.** Ethernet Connector

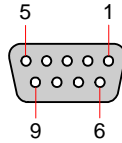
The table below lists Ethernet connector pinouts.

**Table A-10.** Ethernet Connector Pinouts

Pin	Signal	Wire Color
1	TX Data +	White / Orange
2	TX Data -	Orange
3	RX Data +	White / Green
4		Blue
5		White / Blue
6	RX Data -	Green
7		White / Brown
8		Brown

## Serial Connector

The figure below illustrates the Video Processor's **Serial** connector, and the **Ext Comm** and **Console** connectors on both Controller models. All connectors are identical.



**Figure A-5.** Serial Connector

The table below lists **Serial**, **Ext Comm** and **Console** connector pinouts.

**Table A-11.** Serial Connector Pinouts

Pin	RS-232 Signal	Description
1	CD	Carrier Detect
2	TXD	Transmitted Data
3	RXD	Received Data
4	DSR	Data Set Ready
5	GND	Signal Ground
6	DTR	Data Terminal Ready
7	CTS	Clear To Send
8	RTS	Request To Send
9	RI	Unused

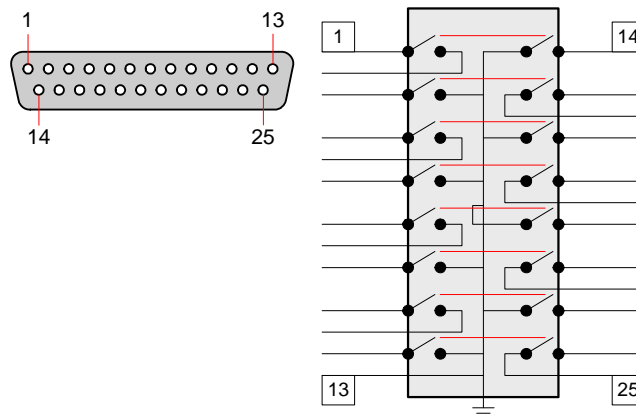
## A. Specifications

### Pinouts

## Tally Connector

Each Encore Controller provides one 25-pin D connector for issuing tally “relay closure” commands to external devices. Eight tally circuits are provided. Please note:

- Tally outputs provide dry-contact relay closures between signal pairs or contact closures to ground, whenever the corresponding input source is selected for display on a Program output.
- Tally outputs may be used to signal when input devices (cameras) are “live.”
- Each contact has a rating of 1 Amp at 30 VDC, and 0.5 Amps at 125 VDC.
- A mating connector is required — see the diagrams below.



**Figure A-6.** Tally Connector and Circuit

The table below lists Tally Connector pinouts:

**Table A-12.** Tally Connector Pinouts

Pin	Signal	Pin	Signal
1	Tally 1 contact closure	14	Tally 1 grounding closure
2	Tally 1 contact closure	15	Tally 2 contact closure
3	Tally 2 grounding closure	16	Tally 2 contact closure
4	Tally 3 contact closure	17	Tally 3 grounding closure
5	Tally 3 contact closure	18	Tally 4 contact closure
6	Tally 4 grounding closure	19	Tally 4 contact closure
7	Tally 5 contact closure	20	Tally 5 grounding closure
8	Tally 5 contact closure	21	Tally 6 contact closure
9	Tally 6 grounding closure	22	Tally 6 contact closure
10	Tally 7 contact closure	23	Tally 7 grounding closure
11	Tally 7 contact closure	24	Tally 8 contact closure
12	Tally 8 grounding closure	25	Tally 8 contact closure
13	Signal ground		

---

## Input and Output Resolutions

The tables on the following pages provide comprehensive lists of available input and output resolutions. Please note:

- In Chapter 5, refer to the “[Input Menu Description](#)” section on page 149 for details on assigning input resolutions.
- In Chapter 5, refer to the “[Output Menu Description](#)” section on page 159 for details on assigning output resolutions.

**Note**

Please contact Barco **Technical Support** if you would like to request the addition of a new resolution.

The following topics are provided:

- [Input Resolutions](#)
- [Output Resolutions](#)

### Input Resolutions

Input resolutions are listed below. Each entry lists **Format @Fv (Hz)**.

**Table A-13.** Input Resolutions

640x480 @59.94
640x480 @60
640x480 @72
640x480 @75
640x480 @85
720x480p
720x575p
800x600 @50
800x600 @56
800x600 @59.94
800x600 @60
800x600 @72
800x600 @75
800x600 @85
875p
920x1200 @50
920x1200 @59.94

## A. Specifications

### Input and Output Resolutions

**Table A-13.** Input Resolutions (Continued)

920x1200 @60
1024x768 @47.95
1024x768 @48
1024x768 @50
1024x768 @59.94
1024x768 @60
1024x768 @70
1024x768 @71.93
1024x768 @72
1024x768 @75
1024x768 @85
1152x864 @75
1280x1024 @47.95
1280x1024 @48
1280x1024 @50
1280x1024 @59.94
1280x1024 @60
1280x1024 @71.93
1280x1024 @72
1280x1024 @75
1280x1024 @85
1280x720 @60
1280x720 @60
1280x720 II @60
1280x720 II @60
1280x720p @48
1280x720p @50
1280x720p @59.94
1280x720p @60
1280x768 @47.95
1280x768 @48
1280x768 @50
1280x768 @59.94
1280x768 @75



## A. Specifications

### Input and Output Resolutions

**Table A-13.** Input Resolutions (Continued)

1280x800 @60
1280x800 @60
1280x800 II @60
1280x800 II @60
1280x960 @50
1280x960 @59.94
1280x960 @60
1280x960 @85
1360x768 @60
1360x768 @60
1364x1024 @47.95
1364x1024 @48
1364x1024 @50
1364x1024 @59.94
1364x1024 @75
1364x768 @47.95
1364x768 @48
1364x768 @50
1364x768 @59.94
1364x768 @75
1366x768 @50
1366x768 @59.94
1400x1050 @48
1400x1050 @50
1400x1050 @59.94
1400x1050 @60
1400x1050 @75
1440x900 @60
1440x900 @60
1440x900 @75
1440x900 @75
1440x900 @85
1440x900 @85
1536x768 @50

## A. Specifications

### Input and Output Resolutions

**Table A-13.** Input Resolutions (Continued)

1536x768 @59.94
1600x1200 @47.95
1600x1200 @48
1600x1200 @50
1600x1200 @59.94
1600x1200 @60
1680x1050 @60
1680x1050 @60
1680x1050 @60
1920x1080i @50
1920x1080i @59.94
1920x1080i @60
1920x1080p @23.98
1920x1080p @24
1920x1080p @25
1920x1080p @29.97
1920x1080p @30
1920x1080p @48
1920x1080p @50
1920x1080p @59.94
1920x1080p @60
1920x1080p II @50
1920x1080pSF @29.97
1920x1080pSF @29.97
1920x1080pSF @30
1920x1080pSF @30
1920x1080sF@23.98
1920x1080sF@24
1920x1200 @50
1920x1200 @59.94
1920x1200 @60
1920x1200p @60
2048x1080p @48
2048x1080p @50

**Table A-13.** Input Resolutions (Continued)

2048x1080p @59.94
2048x1080p @60
2048x1080p II @50
2048x1200 @59.94
2048x1200 @59.94
2048x512p @59.94
Apple 1200p @60
NTSC (480i)
PAL (576i)

## Output Resolutions

Output resolutions are listed below. Each entry lists **Format @Fv (Hz)**.

**Table A-14.** Output Resolutions

640x480 @59.94
640x480 @60
640x480 @72
640x480 @75
720x480p
720x575p
800x600 @50
800x600 @59.94
800x600 @60
800x600 @72
800x600 @75
1024x768 @47.95
1024x768 @48
1024x768 @50
1024x768 @59.94
1024x768 @60
1024x768 @71.93
1024x768 @72
1024x768 @75
1280x1024 @47.95

## A. Specifications

### Input and Output Resolutions

**Table A-14.** Output Resolutions (Continued)

1280x1024 @48
1280x1024 @50
1280x1024 @59.94
1280x1024 @60
1280x1024 @71.93
1280x1024 @72
1280x1024 @75
1280x720 @60
1280x720 II @60
1280x720p @48
1280x720p @50
1280x720p @59.94
1280x720p @60
1280x768 @47.95
1280x768 @48
1280x768 @50
1280x768 @59.94
1280x768 @75
1280x800 @60
1280x800 II @60
1280x960 @50
1280x960 @59.94
1280x960 @60
1360x768 @60
1364x1024 @50
1364x1024 @59.94
1364x1024 @75
1364x768 @47.95
1364x768 @48
1364x768 @50
1364x768 @59.94
1364x768 @75
1366x768 @50
1366x768 @59.94

## A. Specifications

### Input and Output Resolutions

**Table A-14.** Output Resolutions (Continued)

1400x1050 @48
1400x1050 @50
1400x1050 @59.94
1400x1050 @60
1400x1050 @75
1440x900 @60
1440x900 @75
1440x900 @85
1536x768 @50
1536x768 @59.94
1600x1200 @47.95
1600x1200 @48
1600x1200 @50
1600x1200 @59.94
1600x1200 @60
1680x1050 @60
1680x1050 @60
1920x1080i @50
1920x1080i @59.94
1920x1080i @60
1920x1080p @23.98
1920x1080p @24
1920x1080p @29.97
1920x1080p @30
1920x1080p @48
1920x1080p @50
1920x1080p @59.94
1920x1080p @60
1920x1080p II @50
1920x1080pSF @29.97
1920x1080pSF @30
1920x1080sF@23.98
1920x1080sF@24
1920x1200 @50

## A. Specifications

### Input and Output Resolutions

**Table A-14.** Output Resolutions (Continued)

1920x1200 @59.94
1920x1200 @60
2048x1080p @48
2048x1080p @50
2048x1080p @59.94
2048x1080p @60
2048x1080p II @50
2048x1200 @59.94
2048x512p @59.94
NTSC (480i)
PAL (576i)

## B. Contact Information

---

### In This Appendix

The following topics are discussed in this Appendix:

- [Warranty](#)
  - [Return Material Authorization \(RMA\)](#)
  - [Contact Information](#)
- 

### Warranty

All video products are designed and tested to the highest quality standards and are backed by a full 3-year parts and labor warranty. Warranties are effective upon delivery date to customer and are non-transferable. Barco warranties are only valid to the original purchaser/owner. Warranty related repairs include parts and labor, but do not include faults resulting from user negligence, special modifications, lightning strikes, abuse (drop/crush), and/or other unusual damages.

The customer shall pay shipping charges when unit is returned for repair. Barco will cover shipping charges for return shipments to customers.

---

### Return Material Authorization (RMA)

In the unlikely event that a product is required to return for repair, please call the following number and ask for a Sales Engineer to receive a Return Merchandise Authorization number (RMA).

- (888) 414-7226

RMA Conditions are listed below:

- a. Prior to returning any item, you must receive a Return Merchandise Authorization (RMA) number.
- b. All RMA numbers must appear on their return-shipping label.
- c. RMA numbers are valid for ten (10) days from issue date.
- d. All shipping and insurance charges on all RMAs must be prepaid by the customer

## B. Contact Information

Contact Information

---

### Contact Information

#### **Barco, Inc.**

11101 Trade Center Drive  
Rancho Cordova, California 95670  
USA

- Phone: (916) 859-2500
- Fax: (916) 859-2515
- Website: [www.barco.com](http://www.barco.com)

#### **Sales Contact**

- Direct: (916) 859-2505
- Toll Free: (888) 414-7226
- E-mail: [folsomsales@barco.com](mailto:folsomsales@barco.com)

#### **Barco N.V.**

Noordlaan 5  
8520 Kurne  
BELGIUM

- Phone: +32 56.36.82.11
- Fax: +32 56.35.16.51
- Website: [www.barco.com](http://www.barco.com)

#### **Technical Support**

- Tech Line: (866) 374-7878 — 24 hours per day, 7 days per week
- E-mail: [folsomsupport@barco.com](mailto:folsomsupport@barco.com)



## C. Upgrading Software

---

### In This Appendix

The following topics are discussed in this Appendix:

- [Software Upgrade Overview](#)
- [Hardware Requirements](#)
- [Software Requirements](#)
- [Downloading Software](#)
- [Serial Upgrade Method](#)
- [Ethernet Upgrade Method](#)

## C. Upgrading Software

### Software Upgrade Overview

---

## Software Upgrade Overview

Firmware files for the Encore Presentation System are loaded into the hardware at power-up. These files are stored in the unit's onboard flash memory, which can be upgraded using a serial or Ethernet connection to a PC (or laptop).

The desired connection is made through the **Console** or **Ethernet** port on the Controller's rear panel, in conjunction with the "Flash Loader" utility supplied with each upgrade. The Flash Loader enables you to update the Flash memory with the latest software revision. The utility should be run from a PC's hard drive (recommended).

---

## Hardware Requirements

The following hardware items are required to upgrade the Encore Presentation System:

- IBM compatible computer with an available COM port or Ethernet port.

If you elect to connect serially, a serial cable conforming to EIA RS-232 specifications (e.g., standard modem cable) is required. The cable should have a DB-9 male connector on one end (for connection to the Controller's **Console** port), and the appropriate connector on the other end for connection to your PC (typically, a DB-9).

---

## Software Requirements

The following list outlines software requirements for upgrading the Encore system:

- Ensure that your PC (or laptop) uses the Windows® 2000 or XP operating systems.
- Software files:
  - ~ Flash File Loader. (This software enables the PC to send commands to the Encore Presentation System.)
  - ~ Encore Presentation System software
  - ~ What's New File

**Note**

All software files listed above (and more) are contained in the file that you will download.

Software files can be downloaded from either the Folsom FTP site or the Barco website, as described in the following ["Downloading Software"](#) section on page 387.

---

## Downloading Software

Two different methods can be used to download Encore system software and the Flash File Loader utility:

- [Via FTP Site](#)
- [Via Web Site](#)

### Via FTP Site

Barco Folsom's FTP site address is: <ftp.folsom.com>

■ To download from the FTP site:

1. Create a target folder on your PC (e.g., Encore).
2. If you are using an FTP client, logon to our site as follows:
  - ~ **User name:** anonymous
  - ~ **Password:** your email address

▲ **Example:** johndoe@somecompany.com

If you are using a web browser to access our FTP site, point the browser to:

**ftp://ftp.folsom.com**

3. Once logged on, navigate to the following directory:  
**ftp://ftp.folsom.com/Image Processing/Encore/**
4. Transfer the following file to the target folder on your PC:  
**EncoreSystem\_SPIII Controller\_Rev###.EXE**
5. With the download complete, navigate to the target folder and double-click the **EXE** to launch the installation shield.
6. Follow the prompts to install the upgrade package. At the conclusion of the procedure, a new path will be created under **Start > Programs > Barco Folsom**.
7. As required, please continue with the "[Serial Upgrade Method](#)" section on page 388, or the "[Ethernet Upgrade Method](#)" section on page 390.

### Via Web Site

Barco's web site address is: [www.barco.com](http://www.barco.com)

■ To download from the web site:

1. Create a target folder on your PC (e.g., Encore).
2. On the web, navigate to:  
**http://www.barco.com**
3. Navigate to the "Events" home page:  
**http://www.barco.com/events**
4. Log in to the **Barco Partnerzone**.
5. Navigate to the "**Software Updates**" link, and download the latest version of **Encore** software.

## C. Upgrading Software

### Serial Upgrade Method

6. When the **File Download Dialog** appears, click **Save** to save the file to your computer.
7. When the **Save As Dialog** appears, navigate to the target folder and click **Save**.
8. With the download complete, navigate to the target folder and double-click the **EXE** to launch the installation shield.
9. Follow the prompts to install the upgrade package. At the conclusion of the procedure, a new path will be created under **Start > Programs > Barco Folsom**.
10. As required, please continue with the "[Serial Upgrade Method](#)" section on page 388, or the "[Ethernet Upgrade Method](#)" section on page 390.

---

## Serial Upgrade Method

- Use the following steps to upgrade Encore software using a serial PC connection:
  1. Connect the **Console** port on the back of the Encore Controller to the **COM 1** port on your PC.
  2. Power-up the Encore Presentation System.
  3. On the PC, click **Start > Programs > Barco Folsom > Encore System\_SPII Controller Software #.##**.
  4. In the next pop-up menu in sequence, click the **Flash Loader** line to launch the Flash Loader utility.

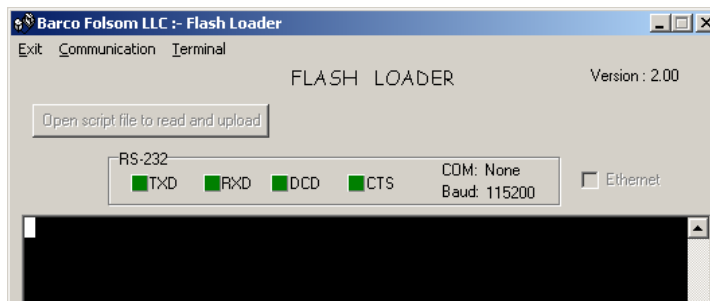


Figure C-1. Flash Loader Utility

### Note

If you have not used the **COM 1** port on your PC, an error message will be shown at the bottom of the Flash Loader.

5. Click **Communication > RS232 Config > Baud**, and select 115200.
6. Click **Communication > RS232 Config > COM Port**, and select the COM port on your PC to which the Controller is connected. If no other programs are using the port, the "**Established communications**" message appears at the bottom of the Flash Loader.

7. To verify communications between the PC and the Controller:
  - a. In the Flash Loader, click in the black terminal window area.
  - b. Note the condition of the status lights:
    - **DCD** and **CTS** should be red.
    - **TXD** and **RXD** should be green. They will flash if **Enter** is pressed.
  - c. Press **Enter** a few times to display the system prompt “#” on screen.
  - d. If the prompt does not appear, continue with step 8 (troubleshooting).
  - e. If the prompt appears, continue with step 9 (uploading files).
8. To troubleshoot the serial connection:
  - a. If the **DCD** and **CTS** status lights are green, re-check the communication settings in the loader, and verify that the COM port and Baud Rate settings are correct.
  - b. To verify Controller communication settings:
    - In the **System Keypad** press **MISC** to display the **Miscellaneous Menu**.
    - Press **{CONSL}** to display the **Console Port Setup Menu**.
  - c. Verify the following settings:
    - Baud rate = 115200
    - Data Bits = 8
    - Parity = None
    - Stop Bits = 1
  - d. Repeat steps 6 and 7 above, then re-check the status lights.
  - e. With communication status OK, continue with step 9.
9. To upload files to the Controller, click "**Open script file to read and upload.**"
10. In the dialog, select "**Complete\_Load.sld**" and click **Open**. The Encore menu should immediately display the "**System in LOADER MODE**" message.
11. It takes several minutes to load the flash memory. When complete, the Flash Loader utility displays the "**Upload Complete**" message. Click **OK** to continue.
12. Cycle power on the Controller, and exit the Flash Loader utility.
13. On the Controller, perform a factory reset. In Chapter 6, refer to the "[Return to Factory Default](#)" section on page 266 for instructions.
14. At this point, the **System Status Menu** will display the "**Please Upgrade**" message, because an incompatibility exists between code versions in the Controller and the Video Processors.

To download code from the Controller to all target devices (including Video Processors, ScreenPRO-II units and PresentationPRO-II), follow the instructions in the "[Downloading Code](#)" section on page 265.
15. On the Controller, verify that the new software has been loaded correctly:
  - ~ In the **System Keypad**, press **SYSTEM** to display the **System Menu**.
  - ~ Press **{SW VER}** to display the **Software Version Menu**.

This completes the software upgrade procedure via serial communications.

## C. Upgrading Software

### Ethernet Upgrade Method

## Ethernet Upgrade Method

- Use the following steps to upgrade Encore software using an Ethernet connection to your PC:

#### Note

The Controller's default IP address is **192.168.0.1**. The Video Processor's default IP address is **192.168.0.10**.

1. Ensure that your PC (or laptop) uses the Windows® 2000 or XP operating systems.
2. Connect the Controller's Ethernet port to a Switch.
3. Connect the Ethernet Switch to your PC. Remember that a totally "local" network is recommended, without IP connections to the outside world.
4. Power-up the Encore Presentation System.
5. On the PC, click **Start > Programs > Barco Folsom > Encore System\_SPII Controller Software #.##**.
6. In the next pop-up menu in sequence, click the **Flash Loader** line to launch the Flash Loader utility.

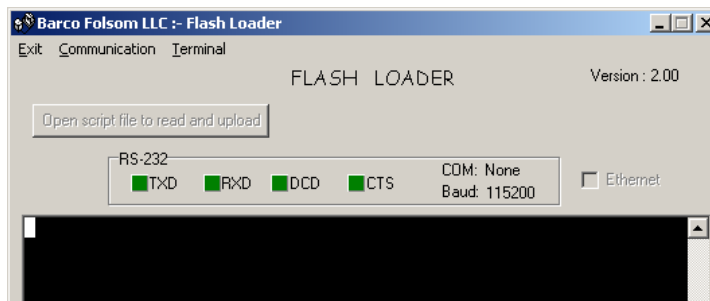


Figure C-2. Flash Loader Utility

7. Click **Communication > Ethernet > Connect** to display the **Ethernet Connection Dialog**.

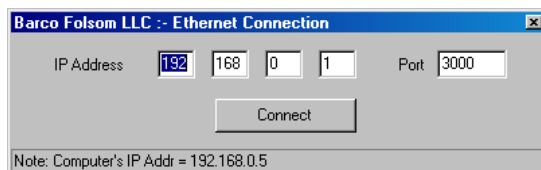


Figure C-3. Ethernet Connection Dialog (sample)

~ If the **Ethernet** menu pick is grayed out, set the COM port to **None**.

8. In the dialog, enter Controller's IP address (**192.168.0.1**), and enter the default port number: **3000**.
9. Click the **Connect** button. If the connection is successfully, the message "**Connect via Ethernet successful**" appears in the Flash Loader's **Status Bar**. If

you cannot connect, refer to the "[Troubleshooting Ethernet Communication](#)" section on page 391.

10. To upload files to the Controller, click "**Open script file to read and upload.**"
11. In the dialog, select "**Complete\_Load.sld**" and click **Open**. The Encore menu should immediately display the "**System in LOADER MODE**" message.
12. It takes several minutes to load the flash memory. When complete, the Flash Loader utility displays the "**Upload Complete**" message. Click **OK** to continue.
13. Cycle power on the Controller, and exit the Flash Loader utility.
14. On the Controller, perform a factory reset. In Chapter 6, refer to the "[Return to Factory Default](#)" section on page 266 for instructions.
15. At this point, the **System Status Menu** will display the "**Please Upgrade**" message, because an incompatibility exists between code versions in the Controller and the Video Processors.

To download code from the Controller to all target devices (including Video Processors, ScreenPRO-II units and PresentationPRO-II), follow the instructions in the "[Downloading Code](#)" section on page 265.

16. On the Controller, verify that the new software has been loaded correctly:
  - ~ In the **System Keypad**, press **SYSTEM** to display the **System Menu**.
  - ~ Press **{SW VER}** to display the **Software Version Menu**.

## Troubleshooting Ethernet Communication

- Use the following steps to determine the IP address of the Controller, and establish proper communications:

### Note

The Controller's default IP address is **192.168.0.1**. The Video Processor's default IP address is **192.168.0.10**.

1. Turn on the Controller. In the **System Keypad**:
  - a. Press **SYSTEM** to display the **System Menu**.
  - b. Press **{NETWORK SETUP}** to display the **Network Setup Menu**.
2. Make a note of the IP address.
3. Attempt to ping the Controller as follows:
  - a. Connect the Controller's Ethernet port to a Switch.
  - b. Connect the Ethernet Switch to your PC. A totally "local" network is recommended, without IP connections to the outside world.
  - c. Turn on the PC or laptop.
  - d. Open a command prompt window on the PC. Click **Start > Programs > Accessories > Command Prompt**.

## C. Upgrading Software

### Ethernet Upgrade Method

- e. On the command prompt line, type:

```
ping 192.168.0.1
```

... followed by **Enter**.

**Note**

Use the unit's actual IP address, as determined in step 2 above.

- f. If the computer is able to successfully communicate with the Controller, you will see a series of “**replies**” from the target IP address. Repeat the upgrade procedure as outlined in the “[Ethernet Upgrade Method](#)” section on page 390.
- g. If you see a “**Request timed out**” message, the PC is unable to locate and communicate with the Controller. If this is the case:
- Check your network connections and settings as described above, or ...
  - Contact your network administrator, or ...
  - Contact **Technical Support**. In Appendix B, refer to the “[Contact Information](#)” section on page 384 for details.



## D. Working With Destinations

---

### In This Appendix

The following topics are discussed in this Appendix:

- [ScreenPRO-II Configurations](#)
- [PresentationPRO-II Aux Configuration](#)
- [ImagePRO Aux Configuration](#)

---

### ScreenPRO-II Configurations

For your reference, this section provides illustrations of various ScreenPRO-II routing and communications configurations:

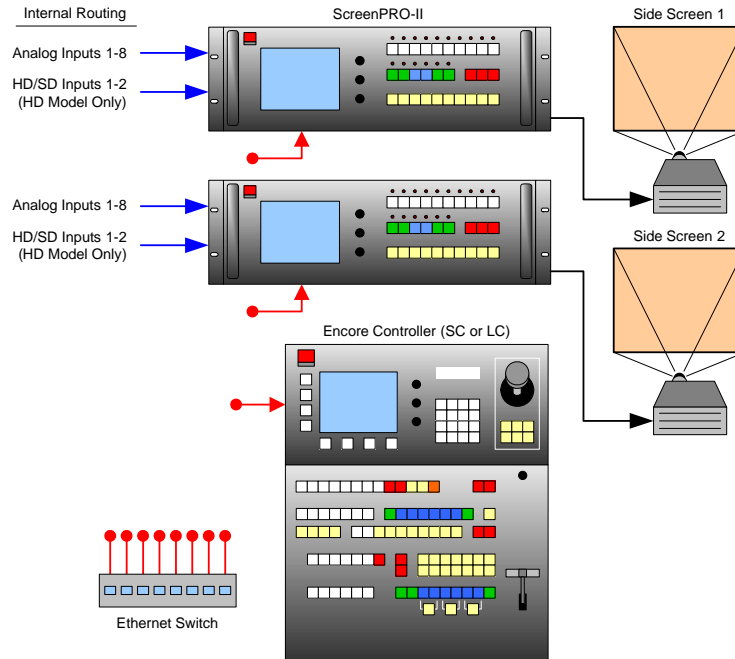
- [Internal Router Configuration](#)
- [External Serial Router Configuration](#)
- [External Ethernet Router Configuration](#)
- [External Serial and Ethernet Router Configuration](#)

## D. Working With Destinations

### ScreenPRO-II Configurations

## Internal Router Configuration

The diagram below illustrates an Encore configuration that uses two ScreenPRO-II units with internal source routing. Each ScreenPRO-II is set up as a unique destination.



**Figure D-1.** ScreenPRO-II units using internal source routing

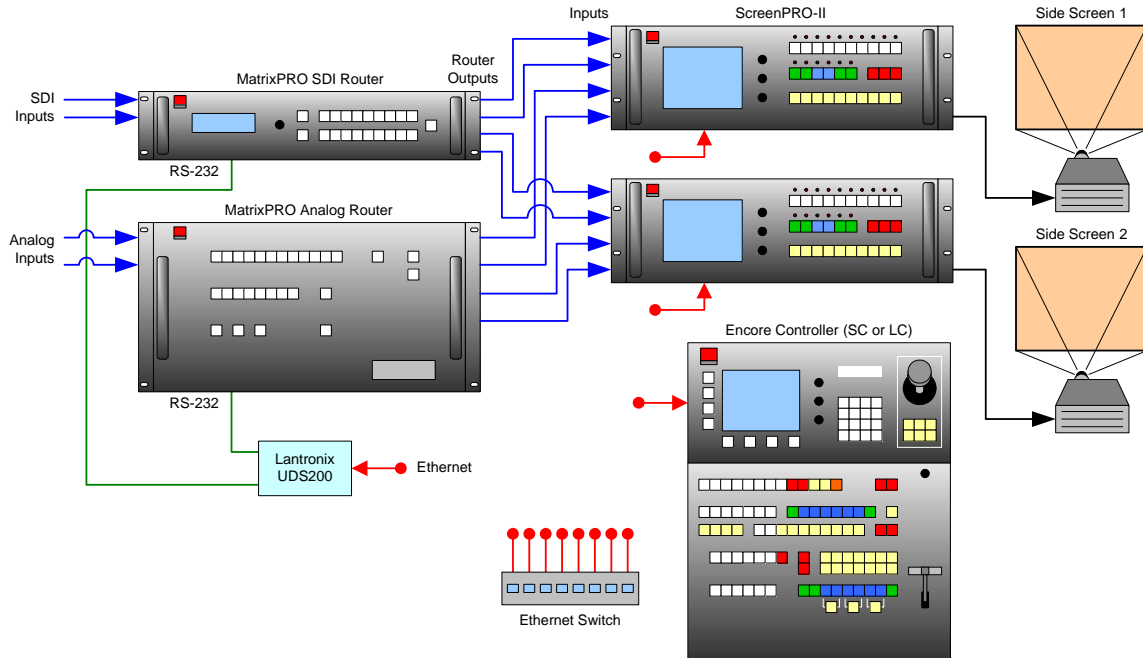
For an “internal routing” ScreenPRO-II configuration, please note the following points regarding destination setup and source connections:

- On the **Destination Setup Menu**:
  - ~ Select **Single Screen SP** as the “**Type**.”
  - ~ Set the “**Routing Mode**” to **Internal**.
  - ~ In Chapter 6, refer to the “[ScreenPRO-II Destination Setup](#)” section on page 279 for instructions.
- Connect analog and digital sources directly to each ScreenPRO-II.
- ScreenPRO-II inputs are mapped using the **Input Patch Menu**:
  - ~ If you are using D/As to connect sources to similar inputs on each ScreenPRO-II, select **ALL SP** as the “**Connection Type**.”
  - ~ If you are connecting to different inputs, separate input patches are required for each.
  - ~ In Chapter 6, refer to the “[Output Format Setup](#)” section on page 285 for instructions.

## External Serial Router Configuration

The diagram below shows a configuration that uses two ScreenPRO-II units with external source routing. Each ScreenPRO-II is set up as a unique destination.

In this configuration, two external serial (RS-232) routers are used — one for analog connections and one for SDI source connections to each ScreenPRO-II. Because *two* serial connections are required, a Lantronix UDS200 is used.



**Figure D-2.** ScreenPRO-II units using external serial controlled routers

For an “external routing” configuration with serial controlled routers, please note the following points regarding destination setup and source connections:

- On the **Destination Setup Menu**:
  - ~ Select **Single Screen SP** as the “Type.”
  - ~ Set the “Routing Mode” to **External**.
  - ~ In Chapter 6, refer to the “[ScreenPRO-II Destination Setup](#)” section on page 279 for instructions.
- Connect analog and digital sources to each router in the normal manner.
- For each router, connect two outputs to each ScreenPRO-II.
- On the **Router Specification Menu**, select the correct router and manufacturer, and set the “Communication Type” to **LANTRONIX**. In Chapter 6, refer to the “[Router Setup](#)” section on page 270 for instructions.
- Router outputs are mapped using the **Output Patch Menu**. This menu defines which router output connects to which ScreenPRO-II input. In Chapter 6, refer to the “[Router Setup](#)” section on page 270 for instructions.
- Router inputs are mapped using the **Input Patch Menu**. In Chapter 6, refer to the “[Output Format Setup](#)” section on page 285 for instructions.

## D. Working With Destinations

### ScreenPRO-II Configurations

## External Ethernet Router Configuration

The diagram below shows a configuration that uses two ScreenPRO-II units with external source routing. Each ScreenPRO-II is set up as a unique destination. Two external Ethernet routers are used — one for analog connections and one for SDI source connections to each ScreenPRO-II.

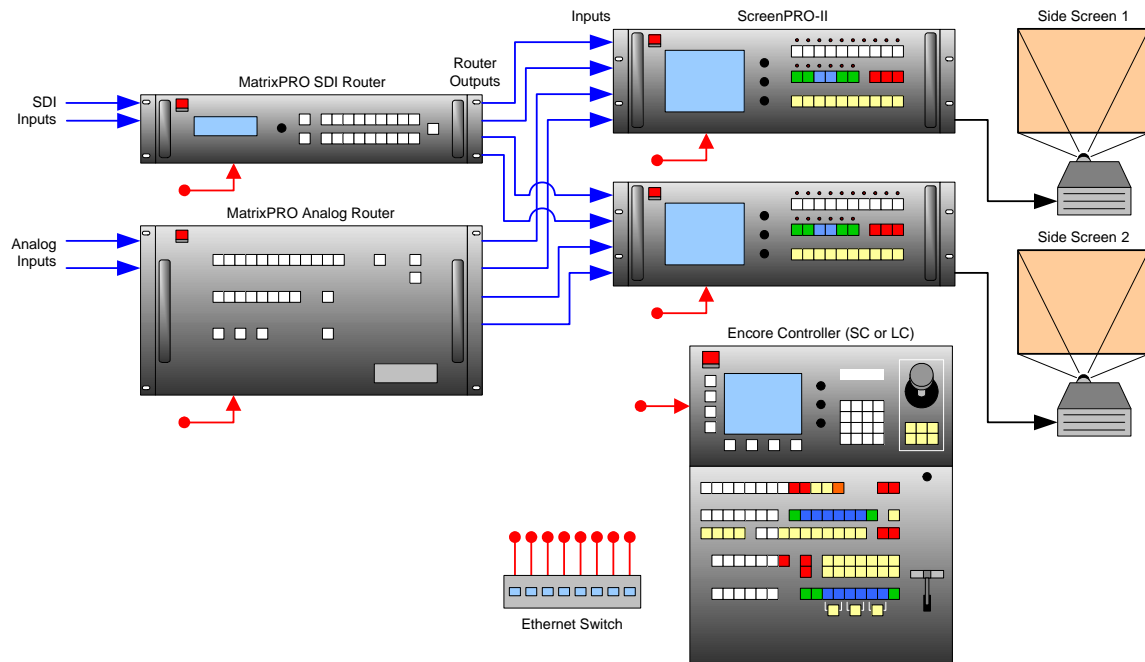


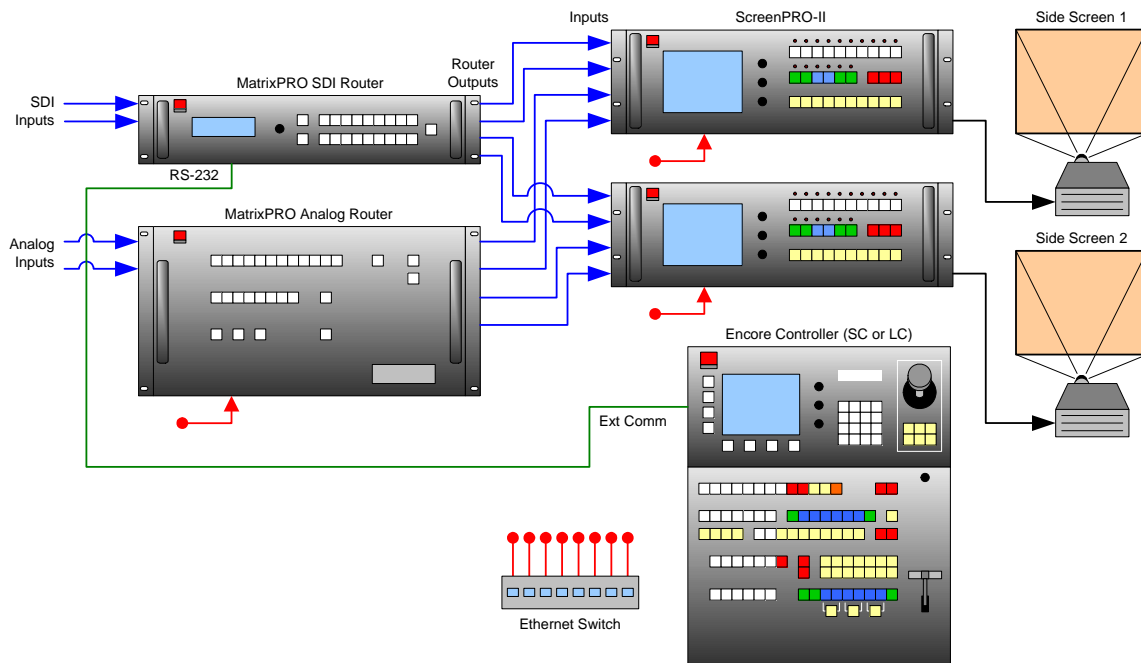
Figure D-3. ScreenPRO-II units using external Ethernet controlled routers

For an “external routing” configuration with Ethernet controlled routers, please note the following points regarding destination setup and source connections:

- On the **Destination Setup Menu**:
  - ~ Select **Single Screen SP** as the “Type.”
  - ~ Set the “Routing Mode” to **External**.
  - ~ In Chapter 6, refer to the “[ScreenPRO-II Destination Setup](#)” section on page 279 for instructions.
- Connect analog and digital sources to each router in the normal manner.
- For each router, connect two outputs to each ScreenPRO-II.
- On the **Router Specification Menu**, select the correct router and manufacturer, and set the “Communication Type” to **ETHERNET**. In Chapter 6, refer to the “[Router Setup](#)” section on page 270 for instructions.
- Router outputs are mapped using the **Output Patch Menu**. This menu defines which router output connects to which ScreenPRO-II input. In Chapter 6, refer to the “[Router Setup](#)” section on page 270 for instructions.
- Router inputs are mapped using the **Input Patch Menu**. In Chapter 6, refer to the “[Output Format Setup](#)” section on page 285 for instructions.

## External Serial and Ethernet Router Configuration

The diagram below shows a configuration that uses two ScreenPRO-II units with external source routing. Each ScreenPRO-II is set up as a unique destination. One external Ethernet router is used, and one external serial router is used.



**Figure D-4.** ScreenPRO-II units using external serial and Ethernet routers

For an “external routing” configuration with Ethernet controlled routers, please note the following points regarding destination setup and source connections:

- On the **Destination Setup Menu**:
  - ~ Select **Single Screen SP** as the “Type.”
  - ~ Set the “Routing Mode” to **External**.
  - ~ In Chapter 6, refer to the “[ScreenPRO-II Destination Setup](#)” section on page 279 for instructions.
- Connect analog and digital sources to each router in the normal manner.
- For each router, connect two outputs to each ScreenPRO-II.
- On the **Router Specification Menu**, select the correct router and manufacturer. In Chapter 6, refer to the “[Router Setup](#)” section on page 270 for instructions.
  - ~ For the serial router, set the “Communication Type” to **RS-232**.
  - ~ For the Ethernet router, set the “Communication Type” to **ETHERNET**.
- Router outputs are mapped using the **Output Patch Menu**. This menu defines which router output connects to which ScreenPRO-II input. In Chapter 6, refer to the “[Router Setup](#)” section on page 270 for instructions.
- Router inputs are mapped using the **Input Patch Menu**. In Chapter 6, refer to the “[Output Format Setup](#)” section on page 285 for instructions.

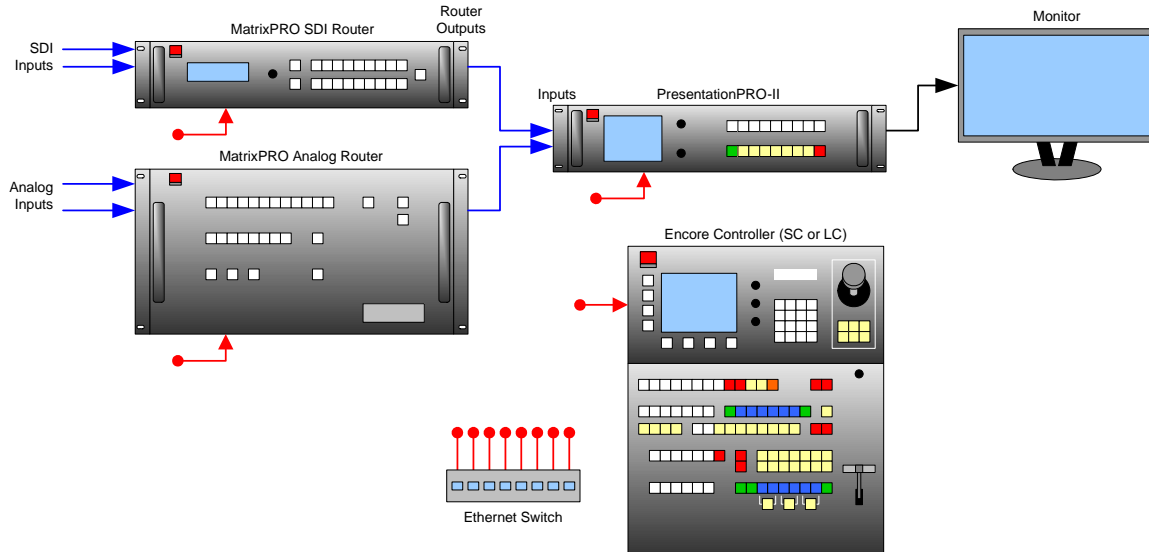
## D. Working With Destinations

### PresentationPRO-II Aux Configuration

## PresentationPRO-II Aux Configuration

PresentationPRO-II units can be connected to the Encore Controller via Ethernet for use as Aux destinations. In this manner, AUX outputs from up to two routers are connected to the PresentationPRO-II — so that any available source used in the Encore system can be displayed on a given monitor.

The diagram below shows a PresentationPRO-II Aux configuration that uses one analog router and one SDI router.



**Figure D-5.** PresentationPRO-II Aux connections

- Use the following steps to properly prepare a PresentationPRO-II system for setup as an Aux destination:
  1. Ensure that you are running software Version 1.12 (or above) on the PresentationPRO-II. If not, download software in the normal manner from the FTP site ([ftp.folsom.com](ftp:folsom.com)) or the web site ([www.barco.com](http://www.barco.com)).
  2. On each router (1 x Analog, 1 x SDI), ensure that an unused router output is physically connected to a PresentationPRO-II input. Make a note of these connection patches, as they will need to be entered during the setup procedure.
  3. Before you connect the PresentationPRO-II to the Encore Controller, set up the PresentationPRO-II's output resolution at the unit itself. Ensure that you match the resolution of the monitor connected to the system.
  4. On PresentationPRO-II's **Effects Menu**, set up the transition parameters that the unit will use when **AUTO TRANS** is pushed on the Encore Controller.
  5. (Optional) If a **BG** (background) or **DSK** (Downstream Key) needs to be on Program at all times, set up this input on the PresentationPRO-II, and transition it to Program — prior to placing the PresentationPRO-II into remote control mode.
  6. Complete the setup procedure by setting up the Aux destination(s) on the Encore Controller. In Chapter 6, refer to the "[AUX Destination Setup](#)" section on page 281 for instructions.

## ImagePRO Aux Configuration

ImagePRO units can be connected to the Encore Controller via Ethernet for use as Aux destinations. In this manner, AUX outputs from up to three routers are connected to the ImagePRO — so that any available source used in the Encore system can be displayed on a given monitor.

The diagram below shows a ImagePRO Aux configuration that uses one analog router, one DVI router and one SDI router.

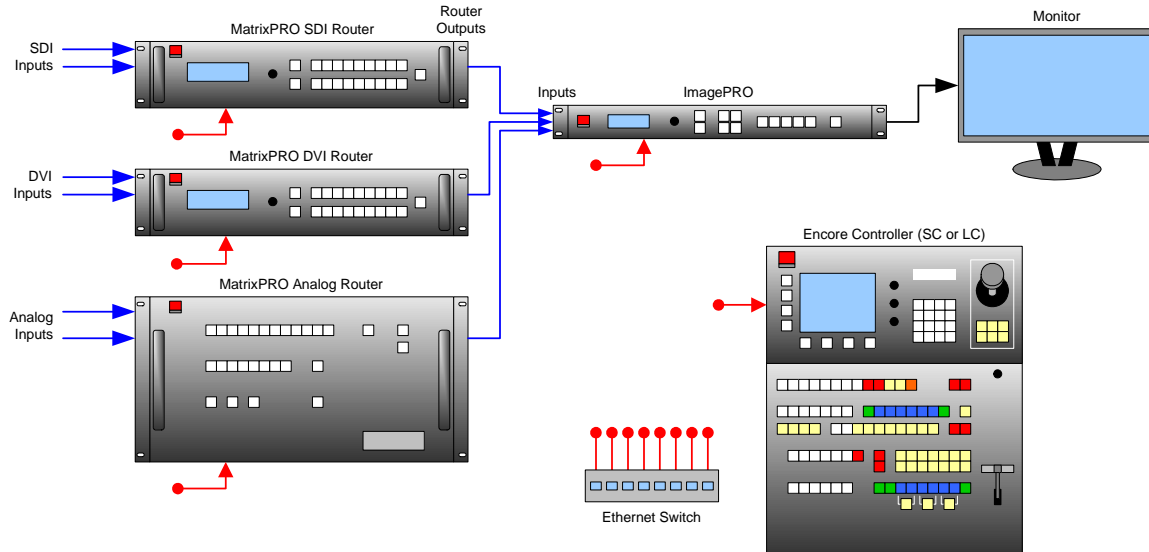


Figure D-6. ImagePRO Aux connections

- Use the following steps to properly prepare an ImagePRO system for setup as an Aux destination:
  1. Ensure that you are running software Version 2.30 (or above) on the ImagePRO. If not, download software in the normal manner from the FTP site ([ftp.folsom.com](ftp:folsom.com)) or the web site ([www.barco.com](http://www.barco.com)).
  2. On each router (1 x Analog, 1 x SDI, 1 x DVI), ensure that an unused router output is physically connected to an ImagePRO input. Make a note of these connection patches, as they will need to be entered during the setup procedure.
  3. Before you connect the ImagePRO to the Encore Controller, set up the ImagePRO's output resolution at the unit itself. Ensure that you match the resolution of the monitor connected to the system.
  4. On ImagePRO's **Effects Menu**, set up the transition parameters that the unit will use when **AUTO TRANS** is pushed on the Encore Controller.
  5. Complete the setup procedure by setting up the Aux destination(s) on the Encore Controller. In Chapter 6, refer to the "[AUX Destination Setup](#)" section on page 281 for instructions.

## D. Working With Destinations

ImagePRO Aux Configuration



## E. Application Notes

---

### In This Appendix

The following application notes are provided in this Appendix:

- [Encore Controller to Router Connections](#)
- [Router Interface Notes](#)

## E. Application Notes

### Encore Controller to Router Connections

---

## Encore Controller to Router Connections

This application note provides information on how to use RS-232 communications to connect the Encore Controller (both the SC and LC models) to various routers and peripheral equipment. All RS-232 connections to the Controller are made through the controller's DB-9 EXT COMM port.

**Important**

All Barco/ Folsom Routers can be connected to the Encore Controller via Ethernet. This is the preferred connection method.

The following topics are provided in this application note:

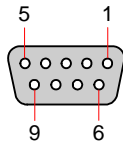
- [EXT COMM Pinouts](#)
- [Cable Connection — Straight Through](#)
- [Cable Connection — Null Modem](#)
- [Lantronix Ethernet to Serial Cable Connection](#)
- [Router Connection Table](#)

## EXT COMM Pinouts

The table below illustrates the pinouts on Encore's **EXT COMM** serial connector.

**Note**

Data "direction" information is provided from the point of view of the Encore controller.



**Figure E-1.** Ext Comm Connector

**Table E-1.** Ext Comm Connector Pinouts

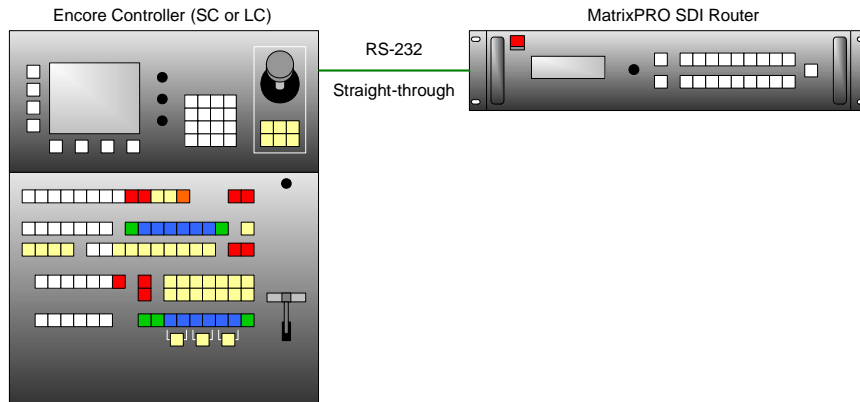
Pin	Signal	Description	Note
1	CD	Carrier Detect	
2	TXD	Transmitted Data	Sends data. Connects to router's receiving pin.
3	RXD	Received Data	Receives data. Connects to router's transmitting pin
4	DSR	Data Set Ready	
5	GND	Signal Ground	Connects to Ground Pin on Router
6	DTR	Data Terminal Ready	
7	CTS	Clear To Send	
8	RTS	Request To Send	
9	RI	Unused	

## E. Application Notes

### Encore Controller to Router Connections

## Cable Connection – Straight Through

The table below illustrates the required pin connections for typical Encore-to-Router configurations. A straight-through RS-232 cable is used between Encore and the router.



**Figure E-2.** Straight through configuration

**Table E-2.** Straight-through pin connection

Encore Pin		Router Pin
2	↔	2
3	↔	3
5	↔	5

## Cable Connection – Null Modem

The table below illustrates the required pin connections for alternate Encore-to-Router configurations (such as to Extron routers). A null modem RS-232 cable is used.

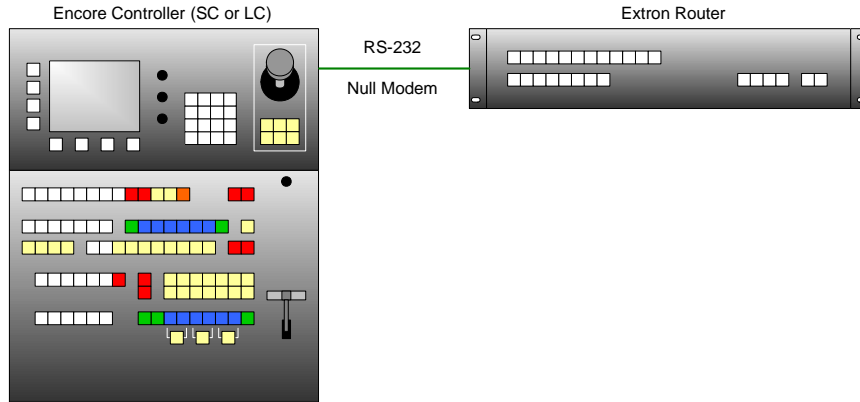


Figure E-3. Null modem configuration

Table E-3. Null modem pin connection

Encore Pin		Router Pin
2	↔	3
3	↔	2
5	↔	5

## E. Application Notes

### Encore Controller to Router Connections

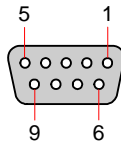
## Lantronix Ethernet to Serial Cable Connection

Because Encore Controllers only have one RS-232 serial port (EXT COMM), an external device (such as the Lantronix UDS200 or UDS2100) is required for multiple RS-232 connections. The Lantronix UDS200 or UDS2100 connects to Encore via Ethernet, and provides two RS-232 ports.

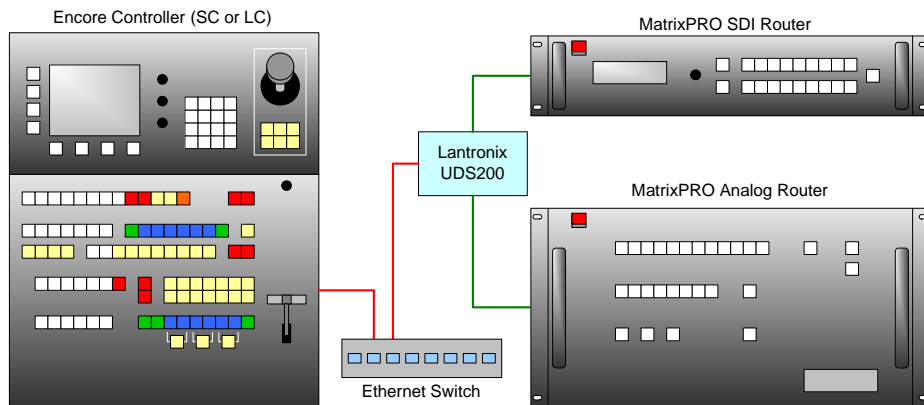
The table below illustrates the pinouts on the UDS200's serial connector.

### Note

Data "direction" information is provided from the point of view of the UDS200 or UDS2100.



**Figure E-4.** Ext Comm Connector



**Figure E-5.** Lantronix Configuration

**Table E-4.** Lantronix Connector Pinouts

Pin	Signal	Description	Note
1	CD	Carrier Detect	
2	RXD	Received Data	Receives data. Connects to router's transmitting pin
3	TXD	Transmitted Data	Sends data. Connects to router's receiving pin.
4	DTR	Data Terminal Ready	
5	GND	Signal Ground	Connects to Ground Pin on Router
6	DSR	Data Set Ready	
7	RTS	Request To Send	
8	CTS	Clear To Send	
9	RI	Unused	

**Note**

RS-232 cable requirements vary. Use the table in the following section for specific cable requirements for various routers.

### Router Connection Table

The table below illustrates numerous notes and cable requirements, when connecting Encore to various routers.

**Table E-5.** Router Connection Table

Router	Use straight through cable	Use null modem cable	Note
<b>Sierra</b>			Use Host Connector
			Ensure DIP switches on Control Processor are set correctly
Older models			TX out of Sierra on Pin 2
			RX in to Sierra on Pin 6
			GND on Pin 1
New models		✓	... when connecting to Encore Controller
	✓		... when connecting to Lantronix
<b>Leitch</b>	✓		... when connecting to Encore Controller
		✓	... when connecting to Lantronix
<b>Extron</b>		✓	... when connecting to Encore Controller
	✓		... when connecting to Lantronix
			Direct Ethernet connections are supported
<b>DPI or DVILINK</b>	✓		... when connecting to Encore Controller
		✓	... when connecting to Lantronix
<b>Folsom</b>	✓		Use straight DB-25 to DB-9 cable to Encore Controller
	✓	✓	Use straight DB-25 to DB-9 cable plus null modem adapter to Lantronix
			... or, use direct Ethernet to router

## E. Application Notes

### Encore Controller to Router Connections

**Table E-5.** Router Connection Table (Continued)

Router	Use straight through cable	Use null modem cable	Note
ISIS		✓	... when connecting to Encore Controller
	✓		... when connecting to Lantronix
			If required, try reversing null modem cable vs. straight through cable, if the connection does not function properly.
NVision			Direct Ethernet only
Grass Valley			Native Protocol - Direct Ethernet only
Lightware DVI		✓	... when connected directly to Encore Controller.
	✓		... when connected to Lantronix.
			Select Extron for Manufacturer in the Router Setup menu.
			See router manual for setup instructions on how to change its protocol to use Extron.



---

## Router Interface Notes

For selected third party routers, additional interface information is provided below. The following topics are discussed in this section:

- [Extron Router Support](#)
- [DVILink and DPI Router Support](#)
- [Sierra Video Systems Router Support](#)
- [Leitch Router Support](#)
- [FSR Router Support](#)
- [AutoPatch Router Support](#)

### Extron Router Support

Encore supports Extron routers enabled with Ethernet.

- In the **Router Specification Menu**, set the Communication Type to **ETHERNET**.
- In the **Ethernet Setup Menu**, dial in the router's IP address, and keep the port number set to **23**.
- Press **{TEST COMM}** to establish communications.

Due to the Extron protocol, the router's matrix size will not be read by the Controller, but will instead default to 32 x 23. When you return from the **Ethernet Setup Menu** to the **Router Specification Menu**, dial in the proper number of inputs and outputs to gain full access to the router.

#### Note

Ensure that you set the router's IP address to work within the recommended range for non-Barco routers: **192.168.0.191 - 192.168.0.240**. This range does not conflict with the Controller, VPs or other network routers and devices.

### DVILink and DPI Router Support

Encore supports the DVILink and DPI 18x18 routers enabled with serial control. Connect to the **EXT COMM** port on the back of the Controller. In Appendix A, refer to the "[Serial Connector](#)" section on page 373 for pinouts.

### Sierra Video Systems Router Support

Encore supports Sierra Video Systems routers enabled with serial control. Connect the router to the **EXT COMM** port on the back of the Controller. In Appendix A, refer to the "[Serial Connector](#)" section on page 373 for pinouts.

### Leitch Router Support

Ethernet connection to Leitch routers is supported. When the Encore Controller connects to a Leitch Router via Ethernet, a Telnet session is established between the Controller and the Router. As part of establishing this connection, the router requires a **User Name** and

## E. Application Notes

### Router Interface Notes

**Password** to be entered. The Controller does this automatically when attempting to connect to the router by using the default factory account.

To ensure that a connection is successful, verify that the Leitch Router has the following User Name and Password account:

- **User Name:** leitch
- **Password:** leitchadmin

Refer to the router "**Installation, Configuration, and Operation Manual**" for more information on how to create user accounts. The manual will also describe how to properly change the IP address of the router. This will be necessary in order to set the router to a compatible static IP address.

## FSR Router Support

In the **Router Setup Menu**, **FSR** has been added to the list of manufacturers that can be selected. The **Pathfinder** series of routers can be connected to Encore via serial or Ethernet.

- When using a serial connection, the cable type must be a NULL modem.
- When connecting via Ethernet, ensure that the router's IP address is in the **192.168.0.xxx** range, in order to be compatible with the Encore network.

## AutoPatch Router Support

In the **Router Setup Menu**, **AUTOPATCH** has been added to the list of manufacturers that can be selected. Connection to these routers can be made with a direct straight through serial cable to the Encore Controller's **EXT COMM** port. Ethernet connection is only supported via the **Lantronix** device. Please note:

- When using AutoPatch routers with Encore, only **Level 0** of the router will be used. In addition, only one connection type can be used with the system (Analog, SDI or DVI).
- The controller can not be configured to access mixed configurations that the AutoPatch router series is capable of providing.

# Index

## Softkeys

{ADD NEW}	191	{H SIZE}	215, 230, 231, 236
{ADD PATCH}	189, 194	{HOME}	146
{ADD}	183	{INPUT PATCH}	174, 188
{ALL OFF}	210, 211	{INPUT SETUP}	255, 256
{ALL ON}	210, 211	{KEY DETECT}	177, 181
{APPLY FORMAT}	150, 152, 160, 161, 242	{KEY}	235
{AR}	151	{LCD CAL}	203
{ASPECT RATIO}	154	{LCD SETTINGS}	197, 203
{AUX SETUP}	183, 184	{LINKS}	39, 177, 178
{BACK}	146	{LOCK}	197, 199
{BACKUP RESTORE}	197, 206	{MATTE}	226, 228, 235
{BACKUP}	206	{MAX}	241
{BG MATTE}	241	{MIN}	241
{BLACK}	241	{NAME}	247
{BORDR}	215, 218, 219	{NETWORK SETUP}	173, 187
{CAPTURE}	247	{NEXT IP QUAD}	192
{CFG}	151, 153	{OUTPUT PATCH}	191, 194
{CHANGE CODE}	199	{PATCH NEXT}	194, 195
{CHECK CARD}	206, 207	{PICK COLOR}	227, 256
{CLONE}	215, 216, 218, 219	{PIP}	218, 219
{COLOR BALANCE}	152, 157	{PROGRAM EDID}	200
{COMM SETUP}	190, 191, 192, 193	{RATE}	215, 230, 236
{CONSL}	197, 198	{RECALL}	247, 252
{CUSTOM BORDER}	222	{RECENTER JOYSTICK}	180
{DEFINE VP ID}	197, 202	{REMOVE ALL}	184
{DELETE PATCH}	189, 194	{REMOVE}	184
{DELETE ROUTER}	191	{RESET ALL}	157
{DELETE}	154, 247, 251	{RESET RGB}	221
{DEST SETUP}	173, 182	{RESET TO DEFAULTS}	180
{DIAG}	173, 177	{RESET}	173, 175
{DISCOVER LTRX}	193	{RESTORE}	206
{DOWNLOAD CODE}	176, 265	{ROTARY ENCODER}	177, 179
{E OUT}	160, 161, 280	{ROUTER SETUP}	174, 190
{EDID}	197, 200	{SAVE}	151, 154, 156, 161, 247
{EFX}	215, 218, 219, 220, 235	{SET TBAR BOTTOM}	180
{ERASE}	247, 249	{SET TBAR TOP}	180
{FEATHER SETUP}	169, 170, 171	{SETTINGS}	160, 161, 162, 163, 165
{FORCE ACQUIRE}	152, 156	{SHDOW}	215, 218, 219
{FORCE DOWNLOAD}	176	{SIZE & POS}	226, 227, 229
{FRAME GRAB}	246	{SIZING}	152, 155
{GLCK}	160, 164	{START LED TEST}	177
{GRAB COLOR}	227, 256	{STATS}	226, 230, 255
		{SW VER}	173, 176
		{TALLY}	177
		{TBAR & JOYSTICK}	177, 180

## Index

{TEST COMM} ..... 192  
{TEST LINKS} ..... 178  
{TEST PATTERN} ..... 160, 161, 166, 169  
{TRACK SIZE} ..... 219  
{TRACK} ..... 215, 230, 236  
{USER PREF} ..... 197, 204  
{V SIZE} ..... 215, 230, 231, 236  
{WIDE SCREEN} ..... 160, 166, 167

## Numerics

1-1 Sampling ..... 155  
1-1 Sizing Menu ..... 155  
900 Presets ..... 37

## A

### AC

connector, controller ..... 59  
connector, processor ..... 47, 50

Acrobat usage ..... 19  
navigating and searching ..... 19

### Activate

destinations ..... 315  
group ..... 313

Adapter information ..... 63

Adding destination to group ..... 313

Address, company ..... 3, 384

Adjust pip soft edge only ..... 222

Advanced video processing ..... 22

Air intake ports ..... 44

Alignment Test Pattern ..... 166, 169

V Array ..... 170

All button ..... 125, 133, 137, 141

Alphanumeric keypad ..... 40, 146

controller LC ..... 109

description ..... 119

using ..... 310

### Analog

15-pin D connector pinouts ..... 371

background ..... 40, 239, 243

DSK ..... 258

input combinations, table ..... 371

input flexibility ..... 57

router name ..... 185

router output ..... 185

routing mode ..... 183

### Application

configurator ..... 167

notes ..... 401

single screen stack installation ..... 80

single screen, installation ..... 65

triple screen, installation ..... 68

wide screen plus preview, installation ..... 76

wide screen stack ..... 84

wide screen, installation ..... 72

Apply user keys ..... 350

### Aspect ratio

menu description ..... 154

mode ..... 154, 231

Athena scaler ..... 23, 25

### Auto

input save ..... 204, 308

pend move ..... 348

source acquire ..... 204, 308

trans button ..... 135

AutoPatch router support ..... 410

Aux ..... 183

button ..... 141

live switch routing ..... 317

pend route ..... 316

program/preview routing ..... 317

route viewing ..... 318

setup menu description ..... 184

Aux destination ..... 27, 281

route sources to ..... 316

setup ..... 281, 282

setup notes ..... 284

setup overview ..... 281

## B

Background ..... 20

analog ..... 40, 239

button ..... 129

channels ..... 23

DVI ..... 239

format, wide screen settings ..... 168

format, wide screen settings (V Array) ..... 170

frame grab ..... 239

input setup menu ..... 237

input setup menu description ..... 239

input setup menu tree ..... 238

LOS (loss of signal) ..... 308

matte ..... 239

menu functions, analog ..... 243

menu functions, DVI ..... 242

menu functions, frame grab ..... 244

menu functions, matte ..... 240

preset recall ..... 208

priority ..... 26

setup sources ..... 291

transitions ..... 320

type ..... 239

### Backup

and restore utility ..... 33, 300, 354

and restore, menu description ..... 206

and restore, using ..... 353

system, flash memory ..... 353

## Index

- Barco
  - backup and restore utility ..... 33
  - contact information ..... 383
  - Events Manager ..... 22, 143
  - Folsom Warranty ..... 383
  - sales contact information ..... 384
  - stage manager ..... 143
  - technical support information ..... 3, 384
- Baud Rate ..... 192
- BG
  - A ..... 237
  - B ..... 237
  - button ..... 129, 140
  - matte menu ..... 241
- Black
  - invalid video ..... 204
  - preview button ..... 143
  - preview, using ..... 332
- Blank connection charts ..... 92
- Blue
  - color ..... 256
  - mask ..... 256
  - matte ..... 229, 241
  - threshold ..... 256
- Border
  - button ..... 131
  - inner ..... 222
  - menu description ..... 218
  - mode ..... 218
  - outer ..... 222
  - preset recall ..... 208
  - style ..... 218
  - style, custom ..... 222
- Bottom Right ..... 121
- Brackets ..... 146
- Brightness ..... 151
  - analog background ..... 244
- BRITE ..... 203
- Burst ..... 166
- Bus
  - destination, controller LC ..... 109
  - destination, controller SC ..... 112
  - source selection, controller LC ..... 109
  - source selection, controller SC ..... 112
- Button color, use of ..... 113
- C**
- Cable information ..... 63
- Calibration
  - LCD ..... 39
  - touch screen ..... 305
- Cancel ..... 118
- Capture
  - format, frame grab ..... 247
  - frame ..... 244
  - frame from layer ..... 358
  - frame grab from background input ..... 357
  - sources ..... 246, 356
- Card slot, multimedia, controller ..... 59
- Center justified ..... 306
  - configuration ..... 104
- Change
  - history ..... 6
  - layer mode ..... 329
  - lockout code menu ..... 199
- Chapter structure ..... 18
- Charts
  - blank connection ..... 92
  - connection ..... 89
  - sample connection ..... 91
- Chassis handles ..... 44
- Checksum Mismatch ..... 212
- Clear
  - button ..... 125, 137
  - destination ..... 315
  - group ..... 313
  - layer button ..... 133
  - layers from program ..... 327
- Clip ..... 226, 227
  - DSK ..... 254
- Clock Phase ..... 155
- Clone ..... 39
  - button ..... 132
  - menu parameters ..... 216
  - mirror ..... 217
  - notes ..... 216
  - offset ..... 217
  - setup menu description ..... 216
  - type ..... 216, 217
  - using ..... 330
- Code
  - download ..... 265
  - version ..... 207
- Color
  - balance menu description ..... 157
  - border ..... 218
  - DSK ..... 254
  - key functions ..... 226
  - keying ..... 39
  - matte ..... 40
  - picker ..... 39
  - space ..... 150, 160
  - space, enhanced output ..... 161
  - use of ..... 113
- Comm setup menus ..... 191
- Communication
  - specifications ..... 368
  - type, router ..... 191
- Company address ..... 3, 384
- Composite sources ..... 157
- Configuration
  - center justified ..... 104

# Index

DVI-I connectors	56	program link out	46
HD/SDI inputs	56	program link out (VPx)	49
left justified	102	program out HD/SDI	46
multiple processors	56	program out HD/SDI (VPx)	49
operation	303	serial	47
routers	56	serial (VPx)	50
save system	299	serial pinouts	373
single processor	56	source link in	53
Configurator	167	source link in (VPx)	55
Encore	33	source link out	52
Connecting program and source links	102	source link out (VPx)	55
Connection		tally pinouts	374
cable, null modem	405	unit ID	47
cable, straight through	404	unit ID (VPx)	50
charts	89	Console lighting	
charts, blank	92	section, controller LC	109
charts, sample	91	section, controller SC	112
ext comm pinouts, router	403	section, description	122
router, Lantronix	406	Console port	
type	188	controller	59
Connector		setup menu description	198
AC, controller	59	Contact information	383
AC, processor	47, 50	CONTRAST	203
analog 15-pin D pinouts	371	Contrast	151
analog input A	52	analog background	244
analog input B	53	Controller	
controller ext comm	59	AC connector	59
controller keyboard port	58	console port	59
controller tally	59	Ethernet port	59
DVI input A	52	ext comm connector	59
DVI input A (VPx)	54	keyboard port connector	58
DVI input B	53	lockout	41
DVI input B (VPx)	55	multimedia card slot	59
DVI pinouts	369	options	206
DVI-I pinouts	370	orientation	107
Ethernet	47	rear panels	58
Ethernet (VPx)	50	sections	114
Ethernet pinouts	372	tally connector	59
genlock	47	to router connections	402
HD/SDI input A	52	USB B port	58
HD/SDI input B	53	use of color	113
M/E	47, 52	Controller LC	22, 34
M/E (VPx)	50, 54	alphanumeric keypad	109
preview out analog	46	console lighting section	109
preview out analog (VPx)	48	destination bus	109
preview out DVI	46	front panel	108
preview out DVI (VPx)	48	group control section	110
program 1 out analog	46	joystick section	109
program 1 out analog (VPx)	49	layer control section	109
program 1 out DVI	46	layer function section	109
program 1 out DVI (VPx)	49	layer/aux control section	110
program 2 out analog	46	live switch section	109
program 2 out analog (VPx)	49	machine control section	109
program 2 out DVI	46	preset section	109
program 2 out DVI (VPx)	49	program preset section	110
program link in	46	source selection bus	109
program link in (VPx)	49	system keypad	108

## Index

touch screen section	108
transition function section	110
transition section	110
user key section	110, 144
Controller SC	22, 34
console lighting section	112
destination bus	112
front panel	111
group control section	112
joystick section	111
layer control section	112
layer functions section	112
layer/aux control section	112
live switch section	112
preset section	112
program preset section	112
source selection bus	112
system keypad	111
touch screen section	111
transition functions section	112
transition section	112
Conventions	20
menus chapter	146
Copy	
button	132
down	186, 284, 295
function	39, 210
PIP or KEY parameters	210
setup menu description	210
using	331
Copyright	2
Crop	
background	242, 243
button	121
menu	231
Ctrlr IP	187
Current	
backup menu	207
name	248
Custom	
border menu	222
borders	36
lockout code	199
Cut	
button	135
transition	343
Cut + Fill	
how to use	325
key functions	227
keys	40
using	325

## D

D/A setup	274
Data	
bits	192
doubling	169
Deactivating destinations	315
Default	
IP address	390, 391
lockout code	199
output patch table, stack destinations	272
output patch table, standard destinations	271
Definitions	20
Delay	23, 366
Delete	
applies to	153
button	124
frame from memory	251
frame grab menu	251
Deleting frames	361
Description	
alphanumeric keypad	119
console lighting section	122
destination bus	125
group control section	137
joystick section	120
layer control section	128
layer function section	131
layer/aux control section	140
live switch section	134
machine control section	122
preset section	123
program preset section	139
source selection bus	126
system keypad	117
touch screen section	115
transition function section	142
transition section	135
user key section	144
Destination	20, 150, 160
activating and deactivating	315
aux	27
aux setup notes	284
based effects menu	41
bus, controller LC	109
bus, controller SC	112
bus, description	125
button	125
clear	315
dimensions	183
flexibility	38
ImagePRO aux	27, 399
menu description	182
overview	27
PresentationPRO-II aux	27, 398
route sources to aux	316

## Index

- ScreenPRO-II ..... 27
  - ScreenPRO-II configurations ..... 393
  - ScreenPRO-II, external router 395, 396, 397
  - ScreenPRO-II, internal router ..... 394
  - setup ..... 182, 277
  - setup Aux ..... 281, 282
  - setup menu ..... 173
  - setup overview, Aux ..... 281
  - setup PrePRO-II ..... 283
  - setup ScreenPRO-II ..... 279
  - setup ScreenPRO-II with EOC ..... 280
  - setup standard ..... 277
  - setup, ImagePRO ..... 283
  - single screen ..... 27
  - type ..... 182
  - wide screen ..... 27
  - working with ..... 315, 393
  - Destinations
    - activate and deactivate ..... 315
    - clear ..... 315
    - isolate one ..... 125, 315
    - pend aux route ..... 316
    - route aux ..... 316
    - using ..... 315
    - view aux route ..... 318
  - Device ..... 175
  - DHCP
    - client ..... 47, 50
    - enable/disable ..... 262
    - network ..... 187
    - server ..... 47, 50
  - Diagnostics
    - setup menu ..... 173
    - setup menu description ..... 177
  - Dialog, Ethernet connection ..... 390
  - Dimensions, destination ..... 183
  - Direct Map
    - input patch ..... 184
  - DISPLAY ..... 203
  - Documentation
    - conventions ..... 20
    - symbols ..... 20
    - terms ..... 20
  - Download
    - code, setup ..... 265
    - software ..... 387
    - software, via FTP site ..... 387
    - software, via web site ..... 387
  - Downstream key (DSK) ..... 39
  - DPI router support ..... 409
  - DSK ..... 23, 39
    - adjustment menu ..... 254
    - adjustment menu description, color ..... 255
    - adjustment menu description, luma ..... 254
    - analog ..... 258
    - button ..... 130, 140
    - clip ..... 254
    - color ..... 254
    - DVI ..... 257
    - fill source ..... 255
    - frame grab ..... 258
    - gain ..... 255
    - input setup menu description ..... 257
    - invert mode ..... 254
    - LOS ..... 308
    - luma ..... 254
    - luma key functions ..... 254
    - menu ..... 253
    - menu tree ..... 253
    - none ..... 257
    - opacity ..... 255, 256
    - preset recall ..... 208
    - priority ..... 26
    - setup ..... 296
    - type ..... 257
    - working with ..... 362
  - Dual mixer effects ..... 30
  - DVI
    - background ..... 239, 242
    - connector pinouts ..... 369
    - DSK ..... 257
    - program outputs ..... 57
    - router name ..... 185
    - router output ..... 186
  - DVI-I
    - connector pinouts ..... 370
    - connectors ..... 56
  - DVILink router support ..... 409
- ## E
- ECU (Encore Control Unit) ..... 37
  - Edge
    - butted ..... 168
    - feathering ..... 101
  - Edge blending technology ..... 98
    - content creation ..... 98
    - high definition image ..... 98
    - multi-head graphics boards ..... 99
    - video processing ..... 100
  - EDID
    - DVI Input menu description ..... 200
    - format ..... 200
    - notes ..... 201
    - programming ..... 40
    - setup ..... 268
  - Effect combinations ..... 28
  - EFFECTS ..... 147
  - Effects ..... 118
    - dual mixer ..... 30
    - menu ..... 41, 118
    - menu description ..... 209
    - single mixer ..... 28



# Index

triple mixer	31
Electrical specifications	367
EMPTY	247
Encore	
configurator	33
control unit	37
controller LC	22, 34
controller SC	22, 34
controller to router connections	402
event management	32
features	23
GC	37
integration with routers	32
operations	301
output flexibility	25
product differentiation	34
scaling and keying	25
single screen installation	65
single screen stack installation	81
specifications	363
triple screen installation	69
video processor	24
wide screen installation	73
wide screen preview installation	77, 78, 79
wide screen stack installation	85
Enhanced	
events manager support	37
ScreenPRO-II routing	36
source preview	37
Enhanced output	
color space	161
format	161
menu	280
menu, SP-II	161
settings menu	162
source	161
test pattern menu	163
EOC	
destination setup	280
frame stores	280
menu	161
option, SP-II	160
underscan	162
Equipment marking terms	5
Erase	
frame grab menu	249
frames	361
ES option	357
frame grab	252
Ethernet	
connection dialog	390
connector	47
connector (VPx)	50
connector pinouts	372
port, controller	59
setup menu	191
Event management	32
Events Manager	
software	22
support	204, 308
Ext	
comm connector, controller	59
trigger button	143
trigger, using	333
Extended	
display identification data	200
frame grab option	357
External trigger	39
Extron router support	409
<b>F</b>	
Factory default, return to	266
FCC statement	2
Feather Setup Menu	171
Feathering, edge	101
Features	23
Athena scaler	23
background channels	23
DSK	23
frame grab	23
keying	23
PIP effects	23
video delay	23
video processing	23
FG_1, FG_2, FG_3	239, 244
DSK	258
File	
mapping, understanding	309
name	153
number	153
Fill	
source	226, 228
source, DSK	255
Filter, flicker	165
EOC	162
Fine Adjust	121, 215
Firmware files	386
Flash	
loader	388, 390
memory backup, setup procedure	300
memory card	206
memory, restore from	269
Flicker	
filter	165
filter, EOC	162
reduction, interlaced formats	41
Force acquire	150, 152
Format	150, 160
background	242, 243
EDID	200
enhanced output	161

## Index

- outputs ..... 41
- setup output ..... 285
- Frame grab ..... 23, 38
  - background ..... 239, 244
  - button ..... 132
  - capture ..... 244
  - capture format ..... 247
  - capture from background input ..... 357
  - capture from layer ..... 358
  - capture overview ..... 355
  - delete menu ..... 251
  - erase and delete ..... 361
  - erase menu ..... 249
  - menu ..... 245
  - menu description, functions ..... 246
  - menu tree ..... 245
  - name a saved ..... 360
  - name menu ..... 248
  - overview ..... 246
  - recall menu ..... 252
  - save frame ..... 250
  - save in permanent memory ..... 359
  - save menu ..... 250
  - sub menu description ..... 247
  - working with ..... 355
- Frame store, EOC ..... 280
- Freeze
  - button ..... 133
  - using ..... 332
- Front panel
  - controller LC ..... 108
  - controller SC ..... 111
  - video processor ..... 44
  - VPx ..... 45
- FSR router support ..... 410
- FTP site ..... 387
- Full screen
  - button ..... 131
  - using ..... 329
- G**
- Gain ..... 226, 227
  - DSK ..... 255
- Gamma ..... 151, 165
  - EOC ..... 162
  - horizontal (feather setup) ..... 171
  - vertical (feather setup) ..... 171
- GC, Encore ..... 37
- General operations ..... 19
- Genlock
  - connector ..... 47
  - menu description ..... 164
  - setup ..... 287
  - source and type ..... 164
- Global rules ..... 146
- Go / - button ..... 136
- Go / + button ..... 136
- Grab frame ..... 38
- Green
  - color ..... 255
  - mask ..... 256
  - matte ..... 228, 241
  - threshold ..... 256
- Group
  - activate ..... 313
  - adding destination to ..... 313
  - button ..... 137
  - buttons ..... 40
  - clear ..... 313
  - control section, controller LC ..... 110
  - control section, controller SC ..... 112
  - control section, description ..... 137
  - learning ..... 312
  - notes ..... 314
  - remove destination from ..... 313
  - unlearn ..... 314
- Guarantee and compensation ..... 2
- H**
- H Active ..... 156
- H Overlap, width ..... 170
- H Pos ..... 219
- H Position ..... 156, 214
  - input source adjustment ..... 235
  - key ..... 229
- H Size ..... 214, 231
  - input source adjustment ..... 235
  - key ..... 229
  - shadow ..... 219
- H Total ..... 155
- Hardware
  - installation ..... 61
  - requirements, upgrading software ..... 386
  - video processor ..... 43
- HD/SDI
  - inputs ..... 56
  - outputs ..... 57
- High definition image ..... 98
- History, change ..... 6
- Home menu ..... 147
- Horizontal
  - gamma (feather setup) ..... 171
  - mode (feather setup) ..... 171
- How to
  - activate a group ..... 313
  - activate and deactivate destinations ..... 315
  - add destination to group ..... 313
  - adjust raster box size ..... 308
  - apply user keys ..... 350

## Index

- back up system to flash memory . . .300, 353
- calibrate touch screen . . . . .267, 305
- capture frame from a layer . . . . .358
- capture frame from background input . . .357
- change layer mode . . . . .329
- clear a group . . . . .313
- clear all layers . . . . .327
- clear destinations . . . . .315
- clear layers . . . . .327
- connect program and source links .102, 104
- delete a saved frame . . . . .361
- delete presets . . . . .347
- disable controller lockout . . . . .352
- download code from controller . . . . .265
- download software from FTP site . . . . .387
- download software from website . . . . .387
- enable controller lockout . . . . .352
- enable or disable tallies . . . . .351
- enter values numerically . . . . .310
- erase a saved frame . . . . .361
- install single screen Encore . . . . .65
- install single screen stack . . . . .81
- install triple screen Encore . . . . .69
- install wide screen Encore . . . . .73
- install wide screen preview . . . . .77, 78, 79
- install wide screen stack . . . . .85
- learn a group . . . . .312
- learn a group button . . . . .312
- live switch aux destination . . . . .317
- modify keys . . . . .326
- modify layers on program . . . . .328
- modify PIPs . . . . .323
- name a saved frame grab . . . . .360
- patch inputs . . . . .276
- pend aux route . . . . .316
- pend move on preview . . . . .337
- pend move on program . . . . .338
- perform a cut . . . . .343
- perform a mix . . . . .343
- perform a wipe . . . . .344
- perform background transitions . . . . .320
- perform DSK . . . . .362
- perform manual transition . . . . .344
- power up peripherals, check status . . .264
- prepare ImagePRO aux destination . . .399
- prepare PrePRO-II aux destination . . .398
- program EDID . . . . .268
- program move on preview . . . . .336
- program move on program . . . . .337
- program/preview switch aux destination .317
- recall presets . . . . .347
- remove destination from group . . . . .313
- restore from flash memory . . . . .269
- restore system from flash memory . . . .354
- return to factory default . . . . .266
- route aux destinations . . . . .316
- save frame in permanent memory . . . .359
- save setup . . . . .299
- set up Aux destinations . . . . .282
- set up background sources . . . . .291
- set up D/A . . . . .274
- set up DSK . . . . .296
- set up genlock . . . . .287
- set up ID and remote enable . . . . .262
- set up ImagePRO Aux destination . . . .283
- set up inputs, comprehensive . . . . .293
- set up inputs, quick start . . . . .293
- set up output format . . . . .285
- set up PrePRO-II Aux destination . . . .283
- set up single screen projectors . . . . .288
- set up sync . . . . .286
- set up wide screen projectors . . . . .289
- set user preferences . . . . .308
- setup routers . . . . .270
- setup ScreenPRO-II destinations . . . . .279
- setup stack destinations . . . . .277
- setup standard destinations . . . . .277
- setup vertical blend destinations . . . .278
- store presets . . . . .346
- store user keys . . . . .350
- switch sources . . . . .319
- toggle backgrounds . . . . .320
- troubleshoot Ethernet connection . . . .391
- unlearn a group . . . . .314
- upgrade software via Ethernet . . . . .390
- upgrade software via serial . . . . .388
- use alphanumeric keypad . . . . .310
- use black preview . . . . .332
- use clone . . . . .330
- use copy . . . . .331
- use cut + fill . . . . .325
- use destinations . . . . .315
- use ext trigger . . . . .333
- use freeze . . . . .332
- use full screen . . . . .329
- use join mode . . . . .335
- use Keys in mix mode . . . . .325
- use Keys in split mode . . . . .324
- use layer and aux control . . . . .349
- use live switch program/preview . . . .340
- use live switch source mode . . . . .341
- use move . . . . .336, 337
- use next and previous . . . . .347
- use PIPs in mix mode . . . . .323
- use PIPs in split mode . . . . .322
- use reset . . . . .334
- use source preview . . . . .333
- use swap z-order . . . . .330
- use this guide . . . . .19
- view aux route . . . . .318
- work with layers . . . . .319

## Index

- Hue .....221
- Hyperlinks .....19
  
- I**
  
- ID
  - all .....146
  - color balance menu .....157
  - mapping, video processors .....202
  - remote enable setup .....262
  - sizing menu .....155
  - unit connector .....47
  - unit connector (VPx) .....50
- Image
  - effects menu description .....220
  - overlap .....100
- ImagePRO
  - aux .....183, 185, 316, 399
  - aux destination .....27, 281
  - destination setup .....283
  - input .....185, 186
- Information, cables and adapters .....63
- Inner border .....222
- INPUT .....147
- Input .....117
  - auto acquire .....36
  - configuration menu description .....153
  - connection type .....188
  - connector .....150
  - file mapping, understanding .....309
  - flexibility, analog .....57
  - menu .....117, 148
  - menu description .....149
  - menu functions .....150
  - menu tree .....148
  - notes, M/E .....56
  - patch .....185
  - patch table .....275
  - patch, mapping .....184
  - patching, setup .....275
  - resolution specifications .....375
  - setup .....293
  - source adjustment menu description .....234
  - source adjustment menu functions .....235
  - source joystick functions .....236
  - source patch menu .....174
  - source patch menu description .....188
  - specifications .....364
  - sub menus .....153
  - sync type .....151
  - type .....150
  - VP .....194
- Inspection .....62
- Installation
  - connecting program and source links .....102
  - hardware .....61
  - procedures .....64
  - safety precautions .....62
  - single screen application .....65
  - single screen Encore .....65
  - single screen stack .....80, 81
  - site preparation .....62
  - triple screen application .....68
  - triple screen Encore .....69
  - unpacking and inspection .....62
  - wide screen application .....72
  - wide screen Encore .....73
  - wide screen plus preview .....76
  - wide screen preview .....77, 78, 79
  - wide screen stack .....84, 85
- Integration with routers .....32
- Interface notes, routers .....409
- Interlaced format flicker reduction .....41
- Interval (frames), strobe .....221
- Invalid video .....38
- Invert .....221
  - mode .....226, 227
  - mode, DSK .....254
- IP
  - address .....191
  - address, default .....390, 391
  - port number .....191
- Isolate one destination .....125, 315
  
- J**
  
- Join mode .....40, 130
  - using .....335
- Joystick
  - and T-Bar Calibration .....37
  - input source functions .....236
  - key functions .....230
  - PIP functions .....215
  - recenter .....180
  - reset .....180
  - section, controller LC .....109
  - section, controller SC .....111
  - section, description .....120
  - state .....180
- Justification .....169
  
- K**
  
- Key .....20
  - adjustment menu description .....229
  - button .....131
  - cut and fill .....40
  - detect menu description .....181
  - frame effect .....215, 230, 235
  - functions, color .....226

## Index

- functions, cut + fill ..... 227
- functions, luma ..... 226
- joystick functions ..... 230
- menu ..... 224
- menu description ..... 225
- menu functions ..... 225
- menu tree ..... 224
- modify ..... 326
- priority ..... 26
- source adjustment menu description ..... 234
- sub menu description ..... 228
- type ..... 225
- using with mix mode ..... 325
- using with split mode ..... 324
- Key frame
  - effect ..... 209
  - effects for moves ..... 39
  - motion type ..... 39
- Keyboard
  - port, controller ..... 58
  - PS/2 ..... 40
- Keying ..... 23
  - color ..... 39
- Keypad
  - alphanumeric, controller LC ..... 109
  - system ..... 147
  - system, controller LC ..... 108
  - system, controller SC ..... 111
- L**
- Lantronix ..... 38, 193
  - connection to router ..... 406
  - model UDS200, UDS2100 ..... 66
  - setup menu ..... 193
- Layer ..... 20
  - and aux control, using ..... 349
  - aux control section, controller LC ..... 110
  - aux control section, controller SC ..... 112
  - aux control section, description ..... 140
  - button ..... 140
  - buttons ..... 129
  - change mode ..... 329
  - control section, controller LC ..... 109
  - control section, controller SC ..... 112
  - control section, description ..... 128
  - function section, controller LC ..... 109
  - function section, description ..... 131
  - functions section, controller SC ..... 112
  - functions, working with ..... 329
  - how to change mode ..... 329
  - how to clear ..... 327
  - how to clear all ..... 327
  - join mode ..... 40
  - overview ..... 26
  - shift button ..... 132
  - working with ..... 319
- Layout
  - monitor ..... 303
  - monitors, single screen application ..... 303
  - monitors, wide screen application ..... 304
- LCD
  - calibration ..... 39
  - settings, menu description ..... 203
- Learn
  - button ..... 123, 138
  - group ..... 312
- LED
  - red ..... 123, 127
  - status ..... 44
- Left justified ..... 305
  - configuration ..... 102
- Leitch router support ..... 409
- Link diagnostics ..... 39
- Live Switch
  - aux routing ..... 317
  - mode timing ..... 342
  - modes ..... 38
  - program/preview mode ..... 38, 134
  - program/preview notes ..... 341
  - program/preview, using ..... 340
  - section, controller LC ..... 109
  - section, controller SC ..... 112
  - section, description ..... 134
  - source mode ..... 38, 134
  - source mode, notes ..... 342
  - source, using ..... 341
- Lockout
  - code menu description ..... 199
  - code, custom ..... 199
  - code, default ..... 199
  - code, master ..... 352
  - controller ..... 41
- Lookahead preview ..... 129, 306
- LOS ..... 38
  - background ..... 308
  - DSK ..... 308
  - loss of signal ..... 308
  - scaler ..... 308
- Loss of signal ..... 308
- Luma
  - DSK ..... 254
  - key functions ..... 226
  - key functions, DSK ..... 254
- M**
- M/E ..... 20
  - analog input A connector ..... 52
  - analog input B connector ..... 53
  - connectors ..... 47, 52
  - connectors (VPx) ..... 50, 54

## Index

- DVI input A connector ..... 52
- DVI input A connector (VPx) ..... 54
- DVI input B connector ..... 53
- DVI input B connector (VPx) ..... 55
- HD/SDI input A connector ..... 52
- HD/SDI input B connector ..... 53
- input notes ..... 56
- priority ..... 50
- source link in connector ..... 53
- source link in connector (VPx) ..... 55
- source link out connector ..... 52
- source link out connector (VPx) ..... 55
- MAC Addr ..... 193
- Machine control ..... 118
  - section, controller LC ..... 109
  - section, description ..... 122
- Manual transition ..... 344
- Manufacturer, router ..... 190
- Marker Mode ..... 169
- Markers
  - center justified ..... 306
  - left justified ..... 305
  - wide screen ..... 305
- Master lockout code ..... 352
- Matte
  - background ..... 239, 240
  - color ..... 40
  - menu description ..... 228
- Menu ..... 21
  - 1-1 sizing ..... 155
  - background input setup ..... 237
  - BG matte ..... 241
  - comm setup ..... 191
  - conventions ..... 146
  - crop ..... 231
  - download code results ..... 265
  - DSK ..... 253
  - DSK adjustment ..... 254
  - effects ..... 118
  - effects, destination based ..... 41
  - enhanced output ..... 280
  - EOC ..... 161
  - feather setup ..... 171
  - frame delete ..... 251
  - frame erase ..... 249
  - frame grab ..... 245
  - frame recall ..... 252
  - frame save ..... 250
  - functions, key ..... 225
  - input ..... 117, 148
  - key ..... 224
  - machine control ..... 118
  - miscellaneous ..... 117, 196
  - name frame grab ..... 248
  - orientation ..... 145
  - output ..... 117, 158
  - PIP adjustment ..... 213
  - preset recall options ..... 118, 147
  - presets ..... 118
  - sequences ..... 118
  - source adjustment ..... 232
  - status ..... 118
  - system ..... 117, 172
  - user keys ..... 118
  - widescreen link diagnostics ..... 178
- Menu description ..... 154
  - aspect ratio ..... 154
  - aux setup ..... 184
  - background input setup ..... 239
  - backup/restore ..... 206
  - border ..... 218
  - clone setup ..... 216
  - color balance ..... 157
  - console port setup ..... 198
  - copy setup ..... 210
  - current backup ..... 207
  - custom border ..... 222
  - destination ..... 182
  - diagnostics setup ..... 177
  - DSK adjustment, color ..... 255
  - DSK adjustment, luma ..... 254
  - DSK input setup ..... 257
  - EDID DVI input ..... 200
  - effects ..... 209
  - enhanced output settings ..... 162
  - enhanced output test pattern ..... 163
  - enhanced output, SP-II ..... 161
  - Ethernet setup ..... 191
  - frame grab ..... 246
  - genlock ..... 164
  - home ..... 147
  - image effects ..... 220
  - input ..... 149
  - input configuration ..... 153
  - input source adjustment ..... 234
  - input source patch ..... 188
  - key ..... 225
  - key adjustment ..... 229
  - key detect ..... 181
  - key source adjustment ..... 234
  - Lantronix setup ..... 193
  - LCD settings ..... 203
  - lockout code ..... 199
  - matte ..... 228
  - miscellaneous ..... 197
  - network setup ..... 187
  - output ..... 159
  - output patch ..... 194
  - oversample sizing ..... 156
  - PIP adjustment ..... 214
  - preset recall options ..... 208
  - reset ..... 175
  - rotary encoder ..... 179
  - router setup ..... 190

## Index

- RS-232 setup ..... 192
  - settings ..... 165
  - shadow ..... 219
  - sizing menu ..... 155
  - software version ..... 176
  - status ..... 212
  - system ..... 173
  - TBar and Joystick ..... 180
  - test pattern ..... 166
  - user key copy setup ..... 211
  - user keys ..... 211
  - user preference ..... 204
  - video processors ID definition ..... 202
  - wide screen ..... 167
  - widescreen link diagnostics ..... 178
  - Menu functions
    - analog background ..... 243
    - DVI background ..... 242
    - frame grab ..... 246
    - frame grab background ..... 244
    - input ..... 150
    - input source adjustment ..... 235
    - matte background ..... 240
    - PIP adjustment ..... 214
  - Menu tree
    - background input setup ..... 238
    - DSK ..... 253
    - frame grab ..... 245
    - input ..... 148
    - key ..... 224
    - miscellaneous ..... 196
    - output ..... 158
    - PIP adjustment ..... 213
    - source adjustment ..... 233
    - system ..... 172
  - Mirror, clone ..... 217
  - Misc ..... 117, 147
  - Miscellaneous
    - menu ..... 117, 196
    - menu description ..... 197
    - menu tree ..... 196
    - sub menus ..... 198
  - Mix
    - button ..... 36, 142
    - effects ..... 20
    - mode ..... 130, 321
    - mode, understanding ..... 321
    - mode, working with Keys ..... 325
    - source ..... 321
    - source button ..... 142
    - transition ..... 343
  - Mixer ..... 20, 21
    - layer ..... 189, 194
  - Mode
    - aspect ratio ..... 154
    - border ..... 218
    - mix ..... 321
    - monochrome ..... 220
    - shadow ..... 219
    - split ..... 321
  - Modify
    - keys ..... 326
    - layers on program ..... 173
  - Monitor
    - layout ..... 303
    - layout, single screen application ..... 303
    - layout, wide screen application ..... 304
  - Monochrome mode ..... 220
  - Motion
    - threshold ..... 151
    - type ..... 39
  - Move
    - and presets ..... 348
    - button ..... 143
    - keyframe motion ..... 39
    - notes ..... 338
    - pend on preview ..... 337
    - pend on program ..... 338
    - pending and triggering ..... 337
    - program move on preview ..... 336
    - program move on program ..... 337
    - programming ..... 336
    - rate ..... 215, 235
    - rate, key ..... 230
    - setup button ..... 132
    - using ..... 336
  - Multi-head graphics boards ..... 99
  - Multimedia card slot, controller ..... 59
  - Multiple processor configuration ..... 56
- ## N
- Name
    - frame grab menu ..... 248
    - router ..... 190
    - saved frame grab ..... 360
  - Network
    - DHCP ..... 187
    - port ..... 187
    - setup menu ..... 173
    - setup menu description ..... 187
  - New
    - feature review ..... 35
    - name ..... 248, 250
    - routers supported ..... 36
  - Next button ..... 124
  - None ..... 257
  - Notes
    - application ..... 401
    - move ..... 338
    - presets ..... 348

## Index

- Notice ..... 2
- Number
  - of inputs ..... 191
  - of outputs ..... 191
  - router ..... 190
- Numeric PIP Entry ..... 37
  
- O**
  
- Offset, clone ..... 217
- Opacity ..... 226, 227
  - DSK ..... 255, 256
- Operations ..... 301
  - a word about resources ..... 345
  - activate and deactivate destinations .. 315
  - background transitions ..... 320
  - backup and restore ..... 353
  - change layer mode ..... 329
  - clear layers ..... 327
  - clearing destinations ..... 315
  - configuration ..... 303
  - controller lockout ..... 352
  - deleting presets ..... 347
  - destinations ..... 315
  - erase and delete frames ..... 361
  - general ..... 19
  - join mode ..... 335
  - Keys in mix mode ..... 325
  - Keys in split mode ..... 324
  - layer functions ..... 329
  - learning a group ..... 312
  - modify key ..... 326
  - modify layers on program ..... 328
  - modify PIPs ..... 323
  - pend aux route ..... 316
  - pend move on preview ..... 337
  - pend move on program ..... 338
  - PIPs in mix mode ..... 323
  - PIPs in split mode ..... 322
  - prerequisites ..... 302
  - recalling presets ..... 347
  - route aux destinations ..... 316
  - storing presets ..... 346
  - switching sources ..... 319
  - understanding split and mix modes .. 321
  - using black preview ..... 332
  - using clone ..... 330
  - using copy ..... 331
  - using cut + fill ..... 325
  - using ext trigger ..... 333
  - using freeze ..... 332
  - using full screen ..... 329
  - using layer and aux control ..... 349
  - using live modes ..... 340
  - using move ..... 336
  - using next and previous ..... 347
  - using reset ..... 334
  - using shift layers ..... 331
  - using source preview ..... 333
  - using swap z-order ..... 330
  - view aux route ..... 318
  - working with DSK ..... 362
  - working with frame grabs ..... 355
  - working with layers ..... 319
  - working with presets ..... 345
  - working with tallies ..... 351
  - working with transitions ..... 343
  - working with user keys ..... 350
- Operator ..... 21
  - safety summary ..... 4
- Orientation
  - controller ..... 107
  - menus ..... 145
- Outer border ..... 222
- Output ..... 117, 147
  - DVI program ..... 57
  - flexibility ..... 25
  - format setup ..... 285
  - formats ..... 41
  - HD/SDI ..... 57
  - menu ..... 117, 158
  - menu description ..... 159
  - menu functions ..... 160
  - menu tree ..... 158
  - monitor ..... 165, 166
  - notes, program ..... 57
  - patch menu description ..... 194
  - patch table, stack destinations ..... 272
  - patch table, standard destinations .... 271
  - program 1 ..... 57
  - resolution specifications ..... 375, 379
  - router ..... 194
  - specifications ..... 366
  - sub menus ..... 160
- Overlap
  - images ..... 100
  - width ..... 169
- Overlapped ..... 168, 170
- Oversample ..... 155
  - sizing menu description ..... 156
- Overview
  - destinations ..... 27
  - edge blending technology ..... 98
  - frame grab ..... 246
  - frame grab capture ..... 355
  - software upgrade ..... 386
  - system ..... 22



# Index

## P

- Page button .....124, 144
- Parity .....192
- Patch
  - inputs .....275, 276
  - next .....36
  - table, output, stack destinations .....272
  - table, output, standard destinations ....271
- PDF
  - file usage .....19
  - file usage, navigating and searching ....19
  - hyperlinks .....19
- Pend
  - aux route .....316
  - move .....337
  - move, auto .....348
- Permanent Frame Stores .....246, 357
- Physical specifications .....367
- Picking colors .....39
- Picture-in-Picture .....21
- Pinouts .....369
  - analog 15-pin D connector .....371
  - DVI connector .....369
  - DVI-I connector .....370
  - Ethernet connector .....372
  - serial connector .....373
  - tally connector .....374
- PIP .....21
  - adjust soft edge only .....222
  - adjustment menu .....213
  - adjustment menu description .....214
  - adjustment menu functions .....214
  - adjustment menu tree .....213
  - adjustment sub menus .....215
  - button .....131
  - how to modify .....323
  - joystick functions .....215
  - priority .....26
  - soft edge .....223
  - using with mix mode .....323
  - using with split mode .....322
  - working with mix mode .....323
  - working with split mode .....322
- Please Upgrade .....212
- Port .....187
  - controller console .....59
  - controller Ethernet .....59
  - controller USB B .....58
- Power
  - connector, controller .....59
  - connector, processor .....47, 50
  - setup .....264
- PrePRO-II
  - aux .....183, 185
  - aux destination .....281
  - destination setup .....283
  - ID .....185
  - input .....185
- Prerequisites, operations .....302
- PresentationPRO-II
  - aux .....316
  - aux configuration .....398
  - aux destination .....27
- Preset .....21
  - auto pend move feature .....348
  - notes .....348
  - recall background .....208
  - recall border .....208
  - recall DSK .....208
  - recall options .....36
  - recall options menu .....118, 147, 347
  - recall options menu description .....208
  - recalling .....347
  - section, controller LC .....109
  - section, controller SC .....112
  - section, description .....123
  - working with .....345
- Presets .....118
  - and moves .....348
  - deleting .....347
  - menu .....118
  - to Program button .....139
  - using next and previous .....347
- Preview
  - lookahead .....129, 306
  - OSD button .....133
  - out analog connector .....46
  - out analog connector (VPx) .....48
  - out DVI connector .....46
  - out DVI connector (VPx) .....48
  - program move on .....336
  - source .....40
  - wide screen configuration .....38, 77
- Previous button .....36, 124
- Priority
  - background .....26
  - DSK .....26
  - key .....26
  - M/E .....50
  - PIP .....26
- Processor .....24
  - AC connector .....47, 50
  - air intake ports .....44
  - analog input A connector .....52
  - analog input B connector .....53
  - chassis handles .....44
  - DVI input A connector .....52
  - DVI input B connector .....53
  - Ethernet connector .....47
  - front panel .....44
  - genlock connector .....47
  - hardware .....43

## Index

- HD/SDI input A connector .....52
  - HD/SDI input B connector .....53
  - M/E connectors .....47, 52
  - preview out analog connector .....46
  - preview out DVI connector .....46
  - program 1 out analog connector .....46
  - program 1 out DVI connector .....46
  - program 2 out analog connector .....46
  - program 2 out DVI connector .....46
  - program link in connector .....46
  - program link out connector .....46
  - program out HD/SDI connector .....46
  - rear panel .....45
  - re-define IDs .....39
  - serial connector .....47
  - source link in connector .....53
  - source link out connector .....52
  - status LED .....44
  - unit ID connector .....47
  - Processors .....44
  - Product differentiation .....34
  - Program
    - 1 out analog connector .....46
    - 1 out analog connector (VPx) .....49
    - 1 out DVI connector .....46
    - 1 out DVI connector (VPx) .....49
    - 1 outputs .....57
    - 2 out analog connector .....46
    - 2 out analog connector (VPx) .....49
    - 2 out DVI connector .....46
    - 2 out DVI connector (VPx) .....49
    - clear layers from .....327
    - link connection .....98, 102
    - link in connector .....46
    - link in connector (VPx) .....49
    - link out connector .....46
    - link out connector (VPx) .....49
    - modify layers on .....328
    - out HD/SDI connector .....46
    - out HD/SDI connector (VPx) .....49
    - output notes .....57
    - preset button .....139
    - program move on .....337
  - Program Preset
    - section, controller LC .....110
    - section, controller SC .....112
    - section, description .....139
  - Program/Preview
    - aux routing .....317
    - button .....134
    - notes .....317
  - Programmable
    - controller lockout .....41
    - raster box size .....41
  - Programming
    - EDID .....40
    - moves .....336
  - Projector
    - setup .....101, 288
    - setup, single screen .....288
    - setup, wide screen .....289
  - PS/2 keyboard .....40, 146, 311
  - Pulldown Compensation .....151
- ## R
- Rack-mount installation .....62
  - Raster Box .....166
    - EOC .....163
    - size .....41, 165
    - understanding .....307
  - Ratio .....154
  - Rear panel .....48
    - controllers .....58
    - video processor .....45
  - Recall
    - frame grab menu .....252
    - presets .....347
  - Recenter Joystick .....180
  - Red
    - color .....255
    - LED .....123, 127
    - mask .....256
    - matte .....228, 241
    - threshold .....256
  - Red, Green, Blue
    - color .....226
    - mask .....227
    - threshold .....227
  - Re-define video processor IDs .....39, 47, 50
  - Remote control/DHCP, enable, disable .....262
  - Remove destination from group .....313
  - Reset .....215
    - button .....121
    - joystick .....180
    - menu .....173
    - menu description .....175
    - option .....175
    - rotary encoders .....177
    - type .....175
    - using .....334
  - Resolution specifications
    - input .....375
    - input and output .....375
    - output .....379
  - Resources, a word about .....345
  - Restore
    - and backup utility .....300, 354
    - system, from flash memory .....354

## Index

- Return material authorization .....383
- RGB sources .....157
- RMA .....383
- Rotary
  - encoder menu description .....179
  - knobs .....115
- Router
  - cable connections, Lantronix .....406
  - cable connections, null modem .....405
  - cable connections, straight through .....404
  - communication type .....191
  - configuration .....56
  - connection table .....407
  - connections to controller .....402
  - connections, ext comm pinouts .....403
  - input .....189
  - integration .....32
  - interface notes .....409
  - manufacturer .....190
  - name .....190
  - name, aux setup .....184
  - number .....190
  - output .....185, 194
  - setup .....270
  - setup menu description .....190
  - specification menu .....174
  - support, AutoPatch .....410
  - support, DPI .....409
  - support, DVILink .....409
  - support, Extron .....409
  - support, FSR .....410
  - support, Leitch .....409
  - support, Sierra Video Systems .....409
  - type .....190
- Routing mode
  - analog .....183
  - SDI .....183
- RS-232 setup menu .....192
- Rules, global .....146
  
- S**
- Safety
  - precautions .....62
  - summary .....4
- Sales contact information .....384
- Sample connection charts .....91
- Sampling Mode .....150
- Save .....118
  - captured frame .....250
  - frame grab menu .....250
  - frame in permanent memory .....359
  - input, auto .....204, 308
  - setup .....299
  - system configuration .....299
- Saved Location .....248
- SAVED\_FG .....247
- Scaler .....21
  - LOS .....308
- Scaling and keying .....25
- Screen .....21
- ScreenPRO-II
  - configurations .....393
  - destination .....27
  - EOC option .....160
  - external Ethernet router configuration .....396
  - external serial and Ethernet .....397
  - external serial router configuration .....395
  - internal router configuration .....394
  - setup destination .....279
  - setup with EOC .....280
- ScreenPRO-II EOC Support .....36
- SDI Router
  - name .....185
  - output .....185
- SDI routing mode .....183
- Section
  - console lighting, controller LC .....109
  - console lighting, controller SC .....112
  - group control, controller LC .....110
  - group control, controller SC .....112
  - joystick, controller LC .....109
  - joystick, controller SC .....111
  - layer control, controller LC .....109
  - layer control, controller SC .....112
  - layer function, controller LC .....109
  - layer functions, controller SC .....112
  - layer/aux control, controller LC .....110
  - layer/aux control, controller SC .....112
  - live switch, controller LC .....109
  - live switch, controller SC .....112
  - machine control, controller LC .....109
  - preset, controller LC .....109
  - preset, controller SC .....112
  - program preset, controller LC .....110
  - program preset, controller SC .....112
  - touch screen, controller LC .....108
  - touch screen, controller SC .....111
  - transition function, controller LC .....110
  - transition functions, controller SC .....112
  - transition, controller LC .....110
  - transition, controller SC .....112
  - user key, controller LC .....110, 144
- Sections, controller .....114
- Seqs .....118
- Sequence, system setup .....261
- Sequences menu .....118
- Serial
  - connection via Lantronix .....66
  - connector .....47
  - connector (VPx) .....50
  - connector pinouts .....373

## Index

- software upgrade method ..... 388
- Set user preferences ..... 308
- Settings menu description ..... 165
- Setup
  - Aux destination ..... 281, 282
  - Aux destination, overview ..... 281
  - background sources ..... 291
  - backup system ..... 300
  - D/A ..... 274
  - destinations ..... 277
  - downloading code ..... 265
  - DSK ..... 296
  - genlock ..... 287
  - ID and remote enable ..... 262
  - ImagePRO destination ..... 283
  - input patching ..... 275, 276
  - inputs ..... 293
  - move ..... 132
  - output format ..... 285
  - peripheral power, status check ..... 264
  - PrePRO-II destination ..... 283
  - prerequisites ..... 260
  - programming EDID ..... 268
  - projector ..... 101
  - projectors ..... 288
  - restore from flash memory ..... 269
  - return to factory default ..... 266
  - router ..... 270
  - save ..... 299
  - save system configuration ..... 299
  - ScreenPRO-II destinations ..... 279
  - ScreenPRO-II with EOC ..... 280
  - sequence ..... 261
  - single screen projectors ..... 288
  - stack destinations ..... 277
  - standard destinations ..... 277
  - sync ..... 286
  - system ..... 259
  - touchscreen calibration ..... 267
  - vertical blend destinations ..... 278
  - wide screen projectors ..... 289
- Shadow menu description ..... 219
- Sharpness ..... 151
- Shift
  - button ..... 127
  - layers button ..... 132
- Shuffle button ..... 143
- Sierra Video Systems router support ..... 409
- Single
  - mixer effects ..... 28
  - processor configuration ..... 56
  - screen application, installation ..... 65
  - screen destination ..... 27
  - screen stack, installation ..... 80
- Site preparation ..... 62
- Size
  - raster box ..... 165
  - specified in ..... 218
- Sizing menu description ..... 155
- Soft edge, PIP ..... 223
- Softkeys ..... 115
- Software
  - downloading ..... 387
  - events manager ..... 22
  - requirements, upgrading ..... 386
  - upgrade overview ..... 386
  - upgrade via Ethernet ..... 390
  - upgrading ..... 385
  - version ..... 18
  - version 1.19 ..... 38
  - version 1.22 ..... 36
  - version 1.24 ..... 35
  - version menu ..... 173
  - version menu description ..... 176
  - version mismatch ..... 176
- SOG / Y ..... 165
  - EOC ..... 162
- Source
  - acquire, auto ..... 204, 308
  - adjustment menu tree ..... 233
  - adjustment menus ..... 232
  - button ..... 121, 127, 134
  - enhanced output ..... 161
  - link connection ..... 98, 102
  - map, input patch ..... 184
  - mapping ..... 184, 185
  - number ..... 188
  - preview ..... 40
  - preview button ..... 132, 333
  - preview, using ..... 333
  - RGB ..... 157
  - selection bus, controller LC ..... 109
  - selection bus, controller SC ..... 112
  - selection bus, description ..... 126
  - setup background ..... 291
  - switch ..... 319
  - switching ..... 319
- SP
  - input ..... 189
  - input is mapped to ..... 189
  - to add ..... 183
  - to remove ..... 183
- Specifications ..... 363
  - communications ..... 368
  - electrical ..... 367
  - input ..... 364
  - input and output resolutions ..... 375
  - input resolutions ..... 375
  - input, video processor (VP) ..... 364
  - input, video processor (VPx) ..... 365
  - output ..... 366
  - output resolutions ..... 379
  - physical ..... 367
  - pinouts ..... 369

## Index

- Split
  - button ..... 130
  - mode ..... 130, 321
  - mode, understanding ..... 321
- Stack
  - configuration ..... 80
  - destination setup ..... 277
  - installation, single screen ..... 81
  - installation, wide screen ..... 84, 85
- Stacked Configuration Frame Grab ..... 37
- Standard destination setup ..... 277
- Status ..... 118
  - check ..... 264
  - information ..... 212
  - LED, processor ..... 44
  - menu ..... 118
  - menu description ..... 212
- Still frame capture ..... 38
- Stop Bits ..... 192
- Store user keys ..... 350
- Strobe ..... 221
- Style ..... 222
- Sub menus
  - frame grab ..... 247
  - input ..... 153
  - key ..... 228
  - output ..... 160
  - PIP adjustment ..... 215
- Support, technical information ..... 3, 384
- S-Video sources ..... 157
- Swap ..... 321
  - button ..... 143
  - Z-order button ..... 132
  - Z-order, using ..... 330
- Switch sources ..... 319
- Symbols ..... 20
- Sync
  - out, analog ..... 165
  - out, DVI ..... 165
  - out, EOC ..... 162
  - setup ..... 286
  - slice ..... 151
  - type ..... 151
- System ..... 21, 117, 147
  - back up configuration ..... 300
  - backup to flash memory ..... 353
  - delay ..... 366
  - keypad ..... 147
  - keypad, controller LC ..... 108
  - keypad, controller SC ..... 111
  - keypad, description ..... 117
  - menu ..... 117, 172
  - menu description ..... 173
  - menu tree ..... 172
  - overview ..... 22
  - reset menu ..... 173
  - restore from flash memory ..... 354
  - setup ..... 259
  - setup prerequisites ..... 260
  - setup sequence ..... 261
  - sub menus ..... 174
- T
- Table
  - analog input cable combinations ..... 57, 371
  - cables and adapters ..... 63
  - input patch ..... 275
  - router connections ..... 407
- Tally
  - connector pinouts ..... 374
  - connector, controller ..... 59
  - mapping ..... 38
  - mode ..... 173
  - number ..... 189
  - working with ..... 351
- TBar ..... 135
  - & Joystick menu description ..... 180
  - state ..... 180
- Technical support information ..... 3, 384
- Temporary Frame Stores ..... 246, 356
- Terms ..... 20
  - equipment marking ..... 5
- Test
  - LED Module ..... 177
  - pattern menu description ..... 166
- Test pattern
  - alignment ..... 166, 169
  - alignment (V Array) ..... 170
  - mode ..... 166
  - mode, EOC ..... 163
  - type ..... 166
  - type, EOC ..... 163
- Threshold, motion ..... 151
- Timing, live modes ..... 342
- Toggle ..... 321
  - button ..... 143
- Top Left ..... 121
- Total
  - H Res ..... 168
  - H Res (V Array) ..... 170
  - projectors ..... 168
  - projectors (V Array) ..... 169
  - V Res ..... 168
  - V Res (V Array) ..... 170
- Touch screen ..... 116
  - calibration ..... 267, 305
  - setup ..... 267
- Touch screen section
  - controller LC ..... 108
  - controller SC ..... 111
  - description ..... 115

## Index

- Trademarks ..... 3
- Transition
  - backgrounds ..... 320
  - cut ..... 343
  - edge width ..... 209
  - functions section, controller LC ..... 110
  - functions section, controller SC ..... 112
  - functions section, description ..... 142
  - manual ..... 344
  - mix ..... 343
  - perform background ..... 320
  - rate ..... 209
  - section, controller LC ..... 110
  - section, controller SC ..... 112
  - section, description ..... 135
  - type ..... 209
  - wipe ..... 344
  - working with ..... 343
- Transparency, shadow ..... 219
- Trigger, external ..... 39
- Triggering a move ..... 337
- Triple
  - mixer effects ..... 31
  - screen application, installation ..... 68
- Troubleshoot Ethernet connection ..... 391
- Type
  - background ..... 239
  - clone ..... 216, 217
  - destination ..... 182
  - DSK ..... 257
  
- U**
- UDS100, UDS200, UDS2100, Lantronix .66, 193
- Underscan, EOC ..... 162
- Understanding
  - file mapping ..... 309
  - raster boxes ..... 307
  - split and mix modes ..... 321
- Unit ID connector ..... 47, 50
- Unlearn group ..... 314
- Unpacking ..... 62
- UNSAVED\_FG ..... 247
- Upgrade
  - software ..... 385
  - software via Ethernet ..... 390
  - software via serial ..... 388
- USB B port, controller ..... 58
- Use of color ..... 113
- User
  - copy button ..... 132
  - effect button ..... 36, 142
  - key section, controller LC ..... 110, 144
  - keys menu ..... 118
  - keys, menu description ..... 211
  - preference, menu description ..... 204
  - preferences, set ..... 308
  - trans buttons ..... 36, 142
- User Key ..... 40, 118, 147
  - applying ..... 350
  - button ..... 144
  - copy setup menu description ..... 211
  - functions ..... 211
  - notes ..... 350
  - storing ..... 350
  - working with ..... 350
- User preference
  - auto input save ..... 204, 308
  - auto source acquire ..... 204, 308
  - black invalid video ..... 204
  - events manager support ..... 204, 308
- Using
  - alphanumeric keypad ..... 310
  - clone ..... 330
  - controller lockout ..... 352
  - copy ..... 331
  - cut + fill ..... 325
  - live switch program/preview ..... 340
  - live switch source ..... 341
  - PS/2 keyboard ..... 311
  - shift layers ..... 331
- Utility, backup and restore ..... 300, 354
  
- V**
- V Active ..... 156
- V Overlap, width ..... 170
- V Pos ..... 219
- V Position ..... 156, 214
  - input source adjustment ..... 235
  - key ..... 230
- V Size ..... 214, 231
  - input source adjustment ..... 235
  - key ..... 229
  - shadow ..... 219
- V Total ..... 156
- VER x.xx ..... 212
- Version
  - 1.19 software ..... 38
  - 1.22 software ..... 36
  - 1.24 software ..... 35
- Vertical
  - blend, destination setup ..... 278
  - blending ..... 36
  - gamma (feather setup) ..... 171
  - mode (feather setup) ..... 171
- Video
  - advanced processing ..... 22
  - delay ..... 23
  - invalid ..... 38
  - processing ..... 23, 100
  - processing, edge feathering ..... 101

## Index

- processing, image overlap ..... 100
  - processing, projector setup ..... 101
  - processor ..... 24
  - processor (VP) input specifications ..... 364
  - processor (VPx) input specifications ..... 365
  - processor hardware ..... 43
  - processor ID, redefine ..... 47, 50
  - processor, front panel ..... 44
  - processor, rear panel ..... 45
  - processor, re-define IDs ..... 39
  - processors ..... 44
  - processors ID definition menu ..... 202
  - View aux routes ..... 318
  - VP ..... 21, 24
    - input ..... 189, 194
    - input is mapped to ..... 189
    - input specifications ..... 364
    - to add ..... 183
    - to remove ..... 183
  - VP/SP
    - backed up ..... 207
    - to Restore ..... 206
  - VPx ..... 21, 37, 48
    - DVI input A connector ..... 54
    - DVI input B connector ..... 55
    - Ethernet connector ..... 50
    - front panel ..... 45
    - input specifications ..... 365
    - M/E connectors ..... 50, 54
    - preview out analog connector ..... 48
    - preview out DVI connector ..... 48
    - program 1 out analog connector ..... 49
    - program 1 out DVI connector ..... 49
    - program 2 out analog connector ..... 49
    - program 2 out DVI connector ..... 49
    - program link in connector ..... 49
    - program link out connector ..... 49
    - program out HD/SDI connector ..... 49
    - rear panel ..... 48
    - serial connector ..... 50
    - source link in connector ..... 55
    - source link out connector ..... 55
    - unit ID connector ..... 50
    - wide screen preview ..... 76
- W**
- Warranty ..... 383
  - Web site ..... 387
  - Wide screen
    - application plus preview, installation ..... 76
    - application, installation ..... 72
    - definition flexibility ..... 38
    - destination ..... 27
    - link diagnostics ..... 39
    - link diagnostics menu ..... 178
    - link diagnostics menu description ..... 178
    - markers ..... 305
    - menu description ..... 167
    - menu shortcuts ..... 37
    - preview configuration ..... 38, 77
    - settings menu (H Array) ..... 168
    - settings menu (V Array) ..... 169
    - stack, installation ..... 84
  - Wipe transition ..... 344
  - Working with
    - destinations ..... 315, 393
    - Keys in mix mode ..... 325
    - Keys, split mode ..... 324
    - layer functions ..... 329
    - PIPs ..... 322
    - PIPs, mix mode ..... 323
- X**
- X-Axis Control ..... 120
- Y**
- Y-Axis Control ..... 120
  - YPbPr sources ..... 157
- Z**
- Z-Axis Control ..... 120

# Index



## Free Manuals Download Website

<http://myh66.com>

<http://usermanuals.us>

<http://www.somanuals.com>

<http://www.4manuals.cc>

<http://www.manual-lib.com>

<http://www.404manual.com>

<http://www.luxmanual.com>

<http://aubethermostatmanual.com>

Golf course search by state

<http://golfingnear.com>

Email search by domain

<http://emailbydomain.com>

Auto manuals search

<http://auto.somanuals.com>

TV manuals search

<http://tv.somanuals.com>