

Barco iCon

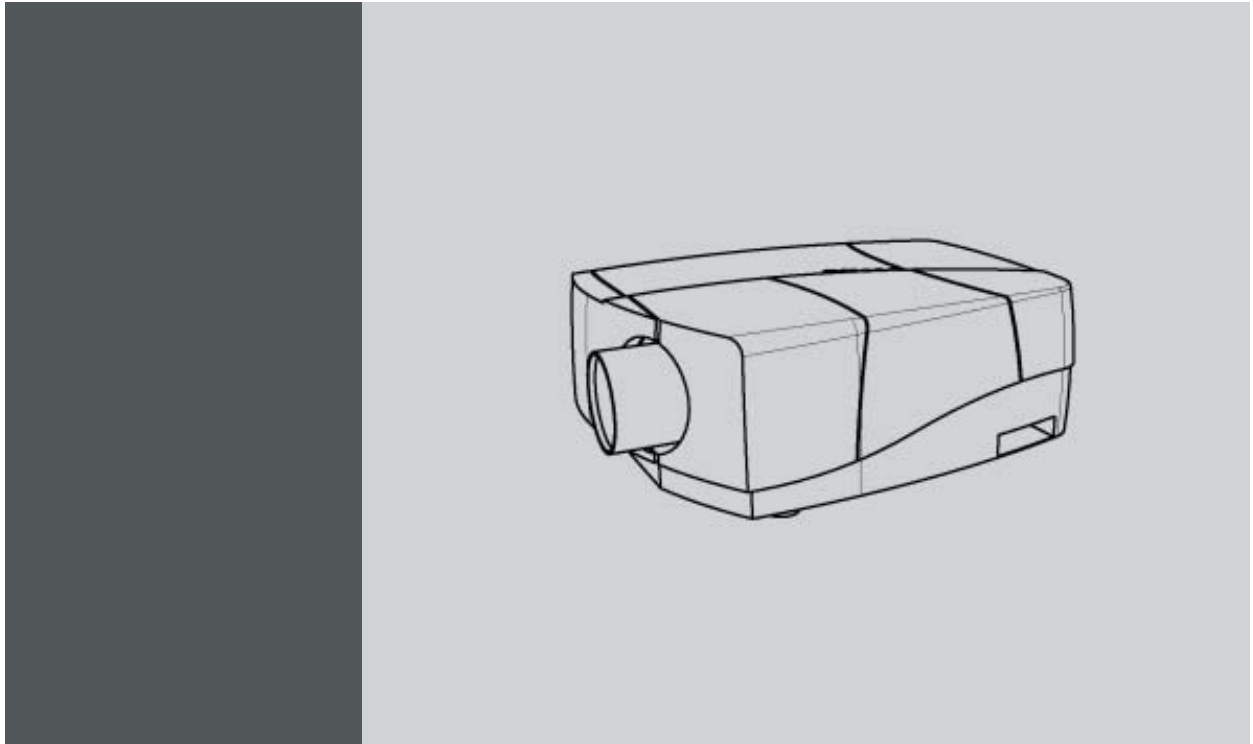

Owner's Manual
H600

R9011114

R5976821/06
15/03/2007



Product revision

Software version: V1.30

Barco nv Presentations
Noordlaan 5, 8520 Kuurne
Phone: +32 56.36.82.11
Fax: +32 56.35.86.51
E-mail: presentations.bid@barco.com
Visit us at the web: www.barco.com

Printed in Belgium

Changes

Barco provides this manual 'as is' without warranty of any kind, either expressed or implied, including but not limited to the implied warranties or merchantability and fitness for a particular purpose. Barco may make improvements and/or changes to the product(s) and/or the program(s) described in this publication at any time without notice.

This publication could contain technical inaccuracies or typographical errors. Changes are periodically made to the information in this publication; these changes are incorporated in new editions of this publication.

Federal Communications Commission (FCC Statement)

This equipment has been tested and found to comply with the limits for a class A digital device, pursuant to Part 15 of the FCC rules. These limits are designed to provide reasonable protection against harmful interference when the equipment is operated in a commercial environment. This equipment generates, uses, and can radiate radio frequency energy and, if not installed and used in accordance with the instruction manual, may cause harmful interference to radio communications. Operation of this equipment in a residential area may cause harmful interference, in which case the user will be responsible for correcting any interference.

EN55022/CISPR22 Class A ITE (Information Technology Equipment)

Class A ITE is a category of all other ITE which satisfies the class A ITE limits but not the class B ITE limits. Such equipment should not be restricted in its sale but the following warning shall be included in the instructions for use:

Warning : This is a class A product. In a domestic environment this product may cause radio interference in which case the user may be required to take adequate measures.

Trademarks

Brand and product names mentioned in this manual may be trademarks, registered trademarks or copyrights of their respective holders. All brand and product names mentioned in this manual serve as comments or examples and are not to be understood as advertising for the products or their manufactures.

End User License agreement (EULA)

You have acquired a device that includes software licensed by Barco from Microsoft Licensing Inc. or its affiliates ("MS"). Those installed software products of MS origin, as well as associated media, printed materials, and "online" or electronic documentation ("SOFTWARE") are protected by international intellectual property laws and treaties. The SOFTWARE is licensed, not sold. All rights reserved.

IF YOU DO NOT AGREE TO THIS END USER LICENSE AGREEMENT ("EULA"), DO NOT USE THE DEVICE OR COPY THE SOFTWARE. INSTEAD, PROMPTLY CONTACT BARCO FOR INSTRUCTIONS ON RETURN OF THE UNUSED DEVICE(S) FOR A REFUND. ANY USE OF THE SOFTWARE, INCLUDING BUT NOT LIMITED TO USE ON THE DEVICE, WILL CONSTITUTE YOUR AGREEMENT TO THIS EULA (OR RATIFICATION OF ANY PREVIOUS CONSENT).

This EULA grants you the following license:

- You may use the SOFTWARE only on the DEVICE
- **NOT FAULT TOLERANT:** THE SOFTWARE IS NOT FAULT TOLERANT. BARCO HAS INDEPENDENTLY DETERMINED HOW TO USE THE SOFTWARE IN THE DEVICE, AND MS HAS RELIED UPON BARCO TO CONDUCT SUFFICIENT TESTING TO DETERMINE THAT THE SOFTWARE IS SUITABLE FOR SUCH USE
- **NO WARRANTIES FOR THE SOFTWARE:** THE SOFTWARE is provided "AS IS" and with all faults. THE ENTIRE RISK AS TO SATISFACTORY QUALITY, PERFORMANCE, ACCURACY, AND EFFORT (INCLUDING LACK OF NEGLIGENCE) IS WITH YOU. ALSO, THERE IS NO WARRANTY AGAINST INTERFERENCE WITH YOUR ENJOYMENT OF THE SOFTWARE OR AGAINST INFRINGEMENT. IF YOU HAVE RECEIVED ANY WARRANTIES REGARDING THE DEVICE OR THE SOFTWARE, THOSE WARRANTIES DO NOT ORIGINATE FROM, AND ARE NOT BINDING ON, MS.
- **No Liability for Certain Damages:** EXCEPT AS PROHIBITED BY LAW, MS AND BARCO SHALL HAVE NO LIABILITY FOR ANY INDIRECT, SPECIAL, CONSEQUENTIAL OR INCIDENTAL DAMAGES ARISING FROM OR IN CONNECTION WITH THE USE OR PERFORMANCE OF THE SOFTWARE. THIS LIMITATION SHALL APPLY EVEN IF ANY REMEDY FAILS OF ITS ESSENTIAL PURPOSE. IN NO EVENT MS AND BARCO SHALL BE LIABLE FOR ANY AMOUNT IN EXCESS OF U.S. TWO HUNDRED FIFTY DOLLARS (U.S.\$250.00).
- **Limitations on Reverse Engineering, Decompilation, and Disassembly:** You may not reverse engineer, decompile, or disassemble the SOFTWARE, except and only to the extent that such activity is expressly permitted by applicable law notwithstanding this limitation.
- **SOFTWARE TRANSFER ALLOWED BUT WITH RESTRICTIONS:** You may permanently transfer rights under this EULA only as part of a permanent sale or transfer of the Device, and only if the recipient agrees to this EULA. If the SOFTWARE is an upgrade, any transfer must also include all prior versions of the SOFTWARE.
- **EXPORT RESTRICTIONS:** You acknowledge that SOFTWARE is of US-origin. You agree to comply with all applicable international and national laws that apply to the SOFTWARE, including the U.S. Export Administration Regulations, as well as end-user, end-use and country destination restrictions issued by U.S. and other governments. For additional information on exporting the SOFTWARE, see <http://www.microsoft.com/exporting/>.

- **Installation and Use:** The SOFTWARE may not be used by more than two (2) processors at any one time on the DEVICE. You may permit a maximum of ten (10) computers or other electronic devices (each a "Client") to connect to the DEVICE to utilize the services of the SOFTWARE solely for file and print services, internet information services, and remote access (including connection sharing and telephony services). The ten (10) connection maximum includes any indirect connections made through "multiplexing" or other software or hardware which pools or aggregates connections. Except as otherwise permitted in the NetMeeting/Remote Assistance/Remote Desktop Features terms below, you may not use a Client to use, access, display or run the SOFTWARE, the SOFTWARE's user interface or other executable software residing on the DEVICE.
- If you use the DEVICE to access or utilize the services or functionality of Microsoft Windows Server products (such as Microsoft Windows NT Server 4.0 (all editions) or Microsoft Windows 2000 Server (all editions)), or use the DEVICE to permit workstation or computing devices to access or utilize the services or functionality of Microsoft Windows Server products, you may be required to obtain a Client Access License for the Device and/or each such workstation or computing device. Please refer to the end user license agreement for your Microsoft Windows Server product for additional information.
- **Restricted Uses:** The SOFTWARE is not designed or intended for use or resale in hazardous environments requiring fail-safe performance, such as in the operation of nuclear facilities, aircraft navigation or communication systems, air traffic control, or other devices or systems in which a malfunction of the SOFTWARE would result in foreseeable risk of injury or death to the operator of the device or system, or to others.
- **Restricted Functionality:** You are licensed to use the SOFTWARE to provide only the limited functionality (specific tasks or processes) for which the DEVICE has been designed and marketed by BARCO. This license specifically prohibits any other use of the software programs or functions, or inclusion of additional software programs or functions, on the DEVICE.
- **Security Updates:** Content providers are using the digital rights management technology ("Microsoft DRM") contained in this SOFTWARE to protect the integrity of their content ("Secure Content") so that their intellectual property, including copyright, in such content is not misappropriated. Owners of such Secure Content ("Secure Content Owners") may, from time to time, request MS, Microsoft Corporation or their subsidiaries to provide security related updates to the Microsoft DRM components of the SOFTWARE ("Security Updates") that may affect your ability to copy, display and/or play Secure Content through Microsoft software or third party applications that utilize Microsoft DRM. You therefore agree that, if you elect to download a license from the Internet which enables your use of Secure Content, MS, Microsoft Corporation or their subsidiaries may, in conjunction with such license, also download onto your DEVICE such Security Updates that a Secure Content Owner has requested that MS, Microsoft Corporation or their subsidiaries distribute. MS, Microsoft Corporation or their subsidiaries will not retrieve any personally identifiable information, or any other information, from your DEVICE by downloading such Security Updates
- **NetMeeting/Remote Assistance/Remote Desktop Features:** The SOFTWARE may contain NetMeeting, Remote Assistance, and Remote Desktop technologies that enable the SOFTWARE or other applications installed on the Device to be used remotely between two or more computing devices, even if the SOFTWARE or application is installed on only one Device. You may use NetMeeting, Remote Assistance, and Remote Desktop with all Microsoft products; provided however, use of these technologies with certain Microsoft products may require an additional license. For both Microsoft products and non-Microsoft products, you should consult the license agreement accompanying the applicable product or contact the applicable licensor to determine whether use of NetMeeting, Remote Assistance, or Remote Desktop is permitted without an additional license
- **Consent to Use of Data:** You agree that MS, Microsoft Corporation and their affiliates may collect and use technical information gathered in any manner as part of product support services related to the SOFTWARE. MS, Microsoft Corporation and their affiliates may use this information solely to improve their products or to provide customized services or technologies to you. MS, Microsoft Corporation and their affiliates may disclose this information to others, but not in a form that personally identifies you
- **Internet Gaming/Update Features:** If the SOFTWARE provides, and you choose to utilize, the Internet gaming or update features within the SOFTWARE, it is necessary to use certain computer system, hardware, and software information to implement the features. By using these features, you explicitly authorize MS, Microsoft Corporation and/or their designated agent to use this information solely to improve their products or to provide customized services or technologies to you. MS or Microsoft Corporation may disclose this information to others, but not in a form that personally identifies you.
- **Internet-Based Services Components:** The SOFTWARE may contain components that enable and facilitate the use of certain Internet-based services. You acknowledge and agree that MS, Microsoft Corporation or their affiliates may automatically check the version of the SOFTWARE and/or its components that you are utilizing and may provide upgrades or supplements to the SOFTWARE that may be automatically downloaded to your Device.
- **Links to Third Party Sites:** The SOFTWARE may provide you with the ability to link to third party sites through the use of the SOFTWARE. The third party sites are not under the control of MS, Microsoft Corporation or their affiliates. Neither MS nor Microsoft Corporation nor their affiliates are responsible for (i) the contents of any third party sites, any links contained in third party sites, or any changes or updates to third party sites, or (ii) webcasting or any other form of transmission received from any third party sites. If the SOFTWARE provides links to third party sites, those links are provided to you only as a convenience, and the inclusion of any link does not imply an endorsement of the third party site by MS, Microsoft Corporation or their affiliates.

- **Additional Software/Services:** The SOFTWARE may permit BARCO, MS, Microsoft Corporation or their affiliates to provide or make available to you SOFTWARE updates, supplements, add-on components, or Internet-based services components of the SOFTWARE after the date you obtain your initial copy of the SOFTWARE ("Supplemental Components"). If BARCO provides or makes available to you Supplemental Components and no other EULA terms are provided along with the Supplemental Components, then the terms of this EULA shall apply. If MS, Microsoft Corporation or their affiliates make available Supplemental Components, and no other EULA terms are provided, then the terms of this EULA shall apply, except that the MS, Microsoft Corporation or affiliate entity providing the Supplemental Component(s) shall be the licensor of the Supplemental Component(s). BARCO, MS, Microsoft Corporation and their affiliates reserve the right to discontinue any Internet-based services provided to you or made available to you through the use of the SOFTWARE. This EULA does not grant you any rights to use the Windows Media Format Software Development Kit ("WMFSDK") components contained in the SOFTWARE to develop a software application that uses Windows Media technology. If you wish to use the WMFSDK to develop such an application, visit <http://msdn.microsoft.com/workshop/imedia/windowsmedia/sdk/wmsdk.asp>, accept a separate license for the WMFSDK, download the appropriate WMFSDK, and install it on your system.
- **PATENT INFRINGEMENTS:** Barco disclaims any warranty that its Products do not infringe any patent, copyright or trademark; but agrees to indemnify you regarding such claims if you promptly notify BARCO in writing and if Barco shall have sole control of the defense of the action and its settlement or compromise. If the use of a Product is enjoined, or a settlement prevents continued use of the Product, Barco shall have the option to procure for you the right to continue use, or replace or modify the Product to remove the infringement. Barco shall have no liability or duty to indemnify you if the infringement or claim is based on use of the Product in combination with other products or software not furnished by Barco, where such claim would not have arisen if such Product were used independently. You will hold Barco harmless against any expense or loss resulting from any infringement caused by compliance with your designs, specifications, or instructions. The foregoing paragraph states Barco's entire liability with regard to infringement of patents, copyrights, or trademarks. This warranty on IP infringement only is valid within US, Canada, EC, Austria, Norway and Japan.

Copyright ©

All rights reserved. No part of this document may be copied, reproduced or translated. It shall not otherwise be recorded, transmitted or stored in a retrieval system without the prior written consent of Barco.

Patent information

This Barco product is protected by the following Barco patents :

- EP1434433
- US6848792
- EP1569464
- US2005185143
- EP1566677
- US6966657
- EP1569463
- US6984042

Patent pending :

- EP1646232

TABLE OF CONTENTS

1. Introduction	5
1.1 About this manual	5
1.2 Network centric visualisation	6
2. Packaging	7
2.1 Unpacking	7
3. Installation guidelines	11
3.1 Safety warnings	11
3.2 Installation guidelines	11
3.3 Network implementation	12
4. Installation	13
4.1 Battery installation in the RCU	15
4.2 Lens installation	15
4.2.1 Removing/installing the cable basket	16
4.2.2 Lens range	16
4.2.3 Lens formulas	17
4.3 Projector Configuration	17
4.3.1 The different configurations	17
4.4 Positioning the projector	18
4.5 Connections	21
4.5.1 Power connection	21
4.5.2 Connections	22
4.5.3 Signal connections	24
4.5.3.1 The input/output section	24
4.5.3.2 Input boards specifications	25
4.5.3.3 Connecting a Composite video signal	26
4.5.3.4 Connecting an S-Video signal	26
4.5.3.5 Connecting an RGB signal	27
4.5.3.6 Connecting a Component Video signal	28
4.5.3.7 Connecting a DVI signal	29
4.5.3.8 Connecting a computer signal	29
4.6 Controls overview	30
5. Setup	33
5.1 Powering up the projector	33
5.2 Starting up the projector	34
5.3 Setting up the RCU address	35
5.4 Setting up the projector address (only if necessary)	36
5.5 Setting up the orientation	37
5.6 Adjusting the lens	37
5.7 Setup the baudrate for serial communication	39
5.8 Setting the server ON/OFF state	40
5.9 Preferences	41
5.9.1 Language setting	41
5.9.2 Pre-programming RCU quick acces keys	42
5.9.3 Automatic startup	43
5.9.4 Background	44
5.10 Installing the software	44
5.11 Configuring the client software	45
5.12 Configuring the Server software	48
5.13 DropZone settings	53
5.14 Start up	54
6. Getting started	57
6.1 Starting up the projector	57
6.2 Logon to the network	57
6.3 Creating your new desktop	57
6.3.1 Adding a new window to your desktop	57
6.3.2 Desktop examples	59
6.3.3 Manipulating your source windows	60
6.3.3.1 The window menu	60
6.3.3.2 Window setup	61
6.3.3.3 Image controls	64
6.3.3.4 Image file controls	64
6.4 Save your new desktop	66
6.5 File dropping/launching	67
6.6 Open remotely a file on the projector	68
7. Desktop Management	71
7.1 The Projector menu	71
7.1.1 Desktop setting using the Projector menu	71

7.1.2	Opening the Projector menu.....	71
7.2	Opening the Projector controls menu.....	72
7.3	Desktop Integration Configuration	74
8.	Advanced	77
8.1	Using the Dialog boxes.....	77
8.2	Source selection	78
8.2.1	Source selection	78
8.2.2	Composite video	78
8.2.3	S-Video.....	79
8.2.4	RGB-YUV	79
8.2.5	PC	80
8.2.6	DVI	81
8.3	General	81
8.3.1	Pause.....	81
8.3.2	Freeze.....	82
8.3.3	Identification.....	82
8.4	Image	83
8.4.1	Image settings	84
8.4.1.1	Setting the Contrast	84
8.4.1.2	Setting the Brightness.....	84
8.4.1.3	Color	85
8.4.1.4	Tint (NTSC video signals only).....	85
8.4.1.5	Sharpness	85
8.4.1.6	Gamma	86
8.4.1.7	Phase (RGB signals only).....	86
8.4.1.8	Noise Reduction (only for video signals)	87
8.4.2	Aspect ratio	88
8.4.3	Color temperature.....	91
8.4.4	Film mode detection (video only)	92
8.4.5	Input balance.....	93
8.4.6	Automatic gain control (AGC)	96
8.4.7	Manual gain control	97
8.5	Lamp management.....	97
8.5.1	Runtimes	97
8.5.2	Lamp mode	98
8.5.3	History.....	100
8.5.4	Reset lamp Runtime	100
8.5.5	Clear lamp error.....	101
8.5.6	Lamp runtime warning	102
8.6	Image files	103
8.6.1	Introduction to Image files	103
8.6.2	Load file	104
8.6.3	Forced file load.....	105
8.6.4	Auto Image	106
8.6.5	Edit file	107
8.6.6	Save as (create a custom file).....	109
8.6.7	Rename file	109
8.6.8	Copy.....	110
8.6.9	Delete	111
8.7	Display setup	112
8.7.1	Full screen synchronous representation	112
8.7.2	Textbox	113
8.7.3	Menu bar position	113
8.7.4	Status bar position	114
8.7.5	Sliderbox position	114
9.	Network centric operations.....	117
9.1	Introduction	117
9.1.1	Network architecture.....	117
9.1.2	Network functionality.....	118
9.1.3	iCon server specifications	119
9.2	Control	119
9.2.1	Description	119
9.2.2	How to use the control manager?.....	121
9.2.3	General.....	121
9.2.4	The source selection screen.....	121
9.2.5	The PiP screen	122
9.2.6	Image settings	126
9.2.7	Advanced control	128
9.2.7.1	Lens adjustments.....	128
9.2.7.2	Options	129
9.3	Configuration	130
9.3.1	E-mail messaging.....	130
9.3.2	E-mail configuration.....	131
9.3.3	Projector Firmware Upgrade	132

9.4 Remote desktop sharing (virtual meeting)	133
9.5 The Web client	136
A. Troubleshoot	139
A.1 Using the OSD	139
B. General guidelines on Network Configuration	141
B.1 General Network	141
B.2 The Internet and Web services	141
C. Exchange.....	143
C.1 Exchange Installation.....	143
C.1.1 Installation procedure	143
C.1.2 Troubleshooting	144
C.2 Exchange Integration.....	145
C.2.1 Command	145
C.2.2 Example	147
C.2.3 Microsoft Outlook Integration	147
C.2.4 Folder form	149
C.2.5 Limitations and known "problems".....	150
D. SNMP services	151
D.1 SNMP installation.....	151
D.2 SNMP integration.....	152
E. Maintenance	155
E.1 Cleaning the lens	155
F. Image files	157
F.1 Image files	157
Index.....	161
List of images.....	165

1. INTRODUCTION

1.1 About this manual

How to use this Manual ?

This manual contains 5 main parts :

1. **Installation** : The mechanical setup of the projector, removing from the shipping box , getting the projector ready to be started. "Installation ", page 13
2. **Setup**: Adjusting the projection parameters in order to get the best image reproduction. "Setup", page 33
3. **Getting started** : Start the projector, create your desktop. "Getting started", page 57
4. **Desktop management** : Adapting the desktop to the presenter's needs. "Desktop Management", page 71
5. **Advanced operation** : Using the remote control and the projector's OSD for advanced setup. "Advanced", page 77

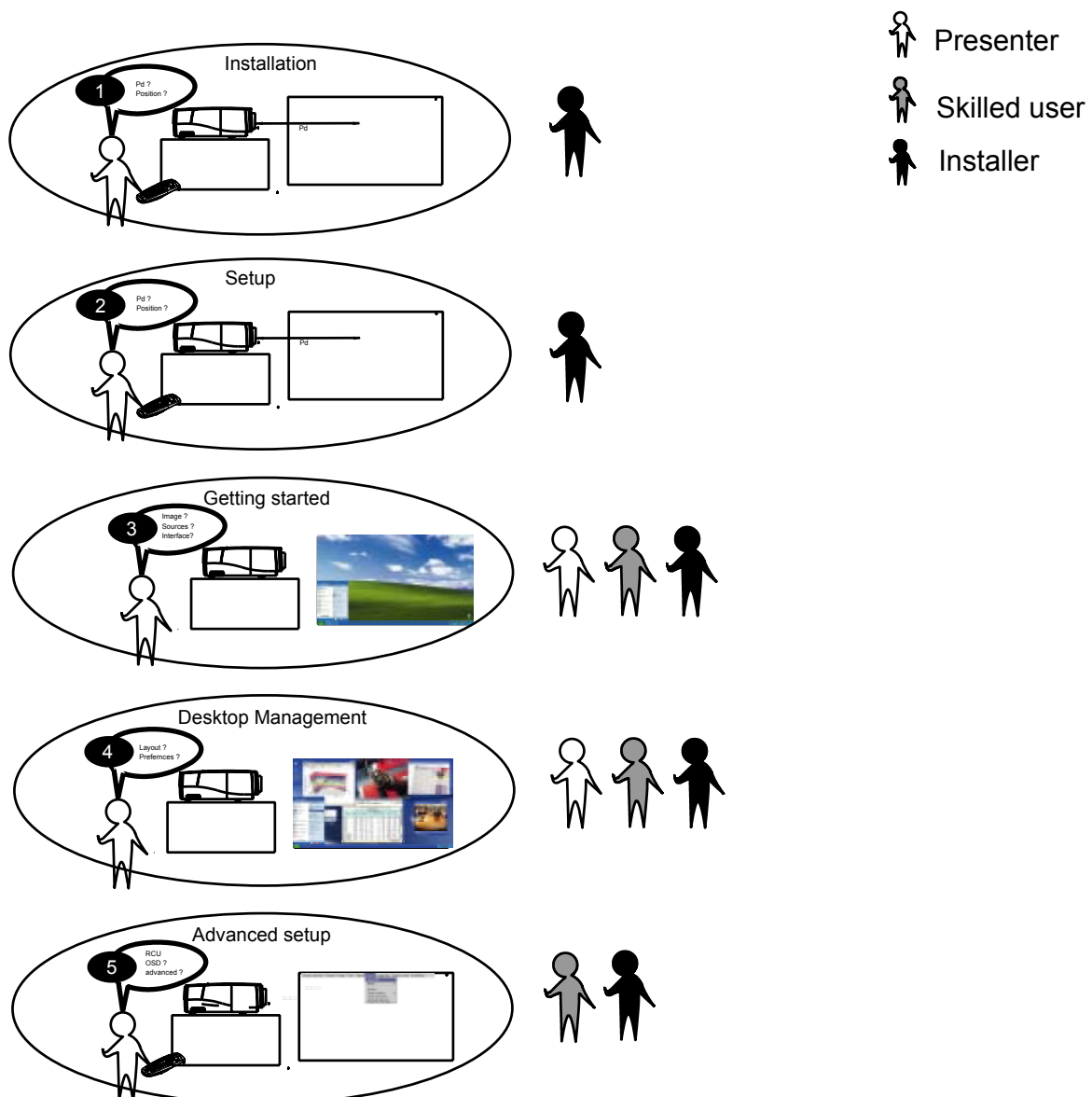

Image 1-1

1.2 Network centric visualisation

Architecture : Parts and Tools

- Barco Client software : runs on a client PC and allows control/diagnostics of the projector
- Barco DropZone : presentation tool, running on a client PC and allowing file manipulations (launch,...) and sharing with the projector
- Barco Server software : runs on the projector (iCon server) and allows communication with the clients.
- Desktop integration : software running on the projector (iCon server) and allowing display content mangament on a Windows XP™ desktop.

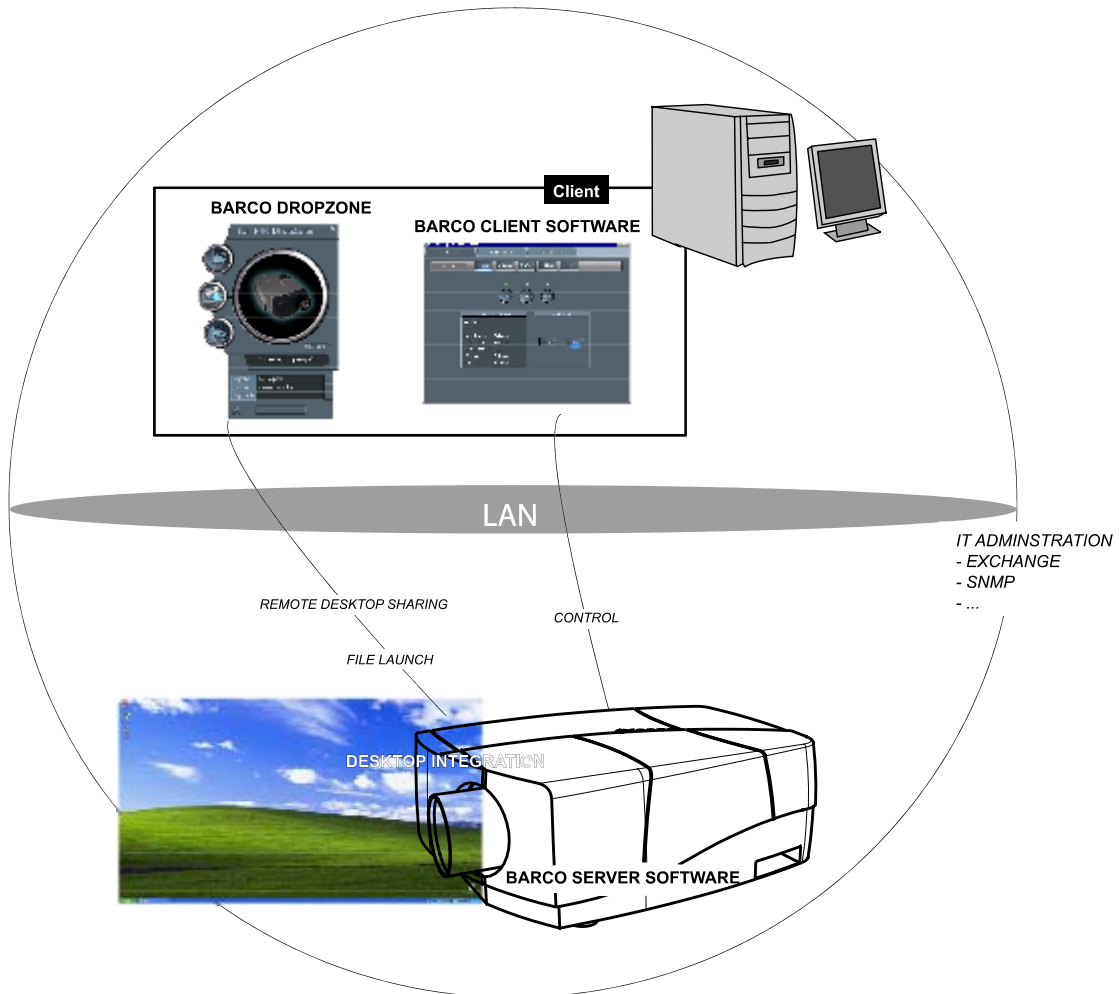

Image 1-2
Network centric architecture

2. PACKAGING

Overview

- Unpacking

2.1 Unpacking



CEE7

European power plug to connect the power cord to the wall outlet.



ANSI 73.11

American power plug to connect the power cord to the wall outlet.

Content

- 1 projector (weight \pm 35 kg or 77 lbs)
- 1 remote control unit RCU + 2 batteries.
- 2 power cables with outlet plug type CEE7 and ANSI 73.11.
- 1 owners manual
- 1 safety manual

Form

The projector is packed in a carton box. To provide protection during transportation, the projector is surrounded with foam. The package is secured with banding and fastening clips.

2. Packaging

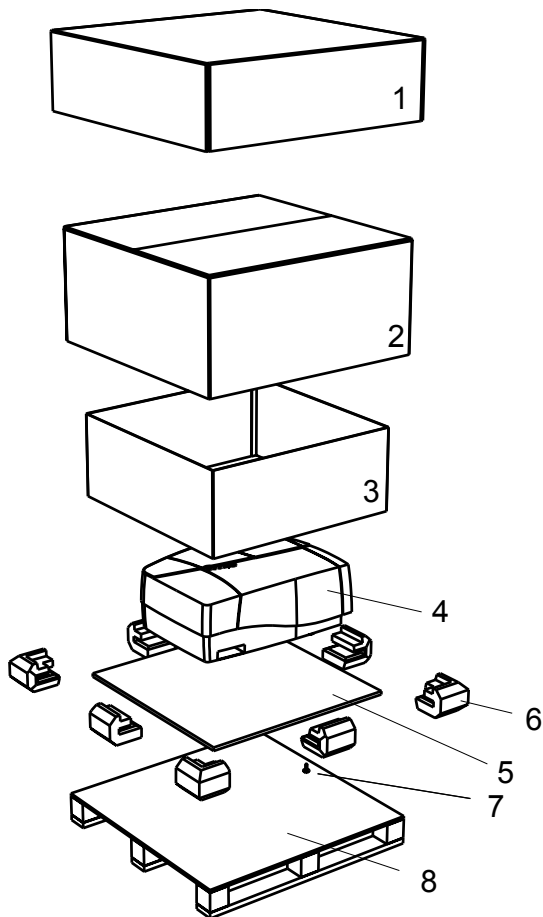

Image 2-1
Projector packaging

- 1 cardboard cover
- 2 strengthening cardboard
- 3 cardboard
- 4 projector
- 5 wooden board
- 6 foam parts
- 7 screws
- 8 pallet

Lens packaging

The Lens is supplied as an individual item.

The lens is packed in a carton box.



Save the original shipping carton and packing material, they will be necessary if you ever have to transport the lens.



CAUTION: Never transport the projector with the lens mounted on it !
Always remove the lens before transporting the projector.

How to unpack the projector

1. Release the cord straps.

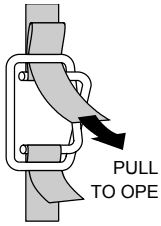

Image 2-2

2. Remove the assembly from the pallet
3. Remove the cardboard cover
4. Remove the large cardboard
5. Remove the 8 foam parts
6. Loosen and remove the 3 screws spacers fixing the projector to the wooden board
7. Remove the projector from the board



Save the original shipping carton and packing material, they will be necessary if you ever have to ship your projector. For maximum protection, repack your projector as it was originally packed at the factory.

3. INSTALLATION GUIDELINES

Overview

- Safety warnings
- Installation guidelines
- Network implementation

3.1 Safety warnings



WARNING: Before installing the projector, read first the safety instructions in the safety manual (R5975258) delivered with the projector.

Insure that the projector is installed in an easy to evacuate room in case of a lamp explosion.

Mercury Vapor Warnings

Keep the following warnings in mind when using the projector. The lamp used in the projector contains mercury. In case of a lamp rupture, explosion there will be a mercury vapor emission. In order to minimize the potential risk of inhaling mercury vapors:

- Ensure the projector is installed only in ventilated rooms.
- Replace the lamp module before the end of its operational life.
- Promptly ventilate the room after a lamp rupture, explosion has occurred, evacuate the room (particularly in case of a pregnant woman).
- Seek medical attention if unusual health conditions occur after a lamp rupture, explosion, such as headache, fatigue, shortness of breath, chest-tightening coughing or nausea.

3.2 Installation guidelines

Ambient temperature check

Careful consideration of things such as image size, ambient light level, projector placement and type of screen to use are critical to the optimum use of the projection system.

Max. ambient temperature : 40 °C or 104 °F

Min. ambient temperature : 0 °C or 32 °F

The projector will not operate if ambient air temperature falls outside this range (0°C- 40°C or 32°F-104°F).

Humidity Conditions

Storage: 0 to 98 % RH Non-condensing

Operation: 0 to 95 % RH Non-condensing

Environment

Do not install the projection system in a site near heat sources such as radiators or air ducts, or in a place subject to direct sunlight, excessive dust or humidity. Be aware that room heat rises to the ceiling; check that temperature near the installation site is not excessive.

Environment condition check

A projector must always be mounted in a manner which ensures the free flow of clean air into the projectors ventilation inlets as well as free flow at the ventilation outlets. The installation must also allow easy access to the consumable parts (dustfilters, lamps, ...) For installations in environments where the projector is subject to airborne contaminants such as that produced by smoke machines or similar (these deposit a thin layer of greasy residue upon the projectors internal optics and imaging electronic surfaces, degrading performance), then it is highly advisable and desirable to have this contamination removed prior to it reaching the projectors clean air supply. Devices or structures to extract or shield contaminated air well away from the projector are a prerequisite, if this is not a feasible solution then measures to relocate the projector to a clean air environment should be considered. Make sure that the projector never runs with dirty dustfilters as this will dramatically reduce the lifetime of the consumables. It is advised to clean the dustfilters on a regular basis and to replace them at any lamp change. Barco reserves itself the right to refuse warranty replacement of consumables if they have been used in a projector with dirty airfilters. Only use the manufactures recommended cleaning kit which has been specifically designed for cleaning optical parts, never use industrial strength cleaners on a projectors optics as these will degrade optical coatings and damage sensitive optoelectronics .

Failure to take suitable precautions to protect the projector from the effects of persistent and prolonged air contaminants will culminate in extensive and irreversible ingrained optical damage. At this stage cleaning of the internal optical units will be non-effective

3. Installation guidelines

and impracticable. Damage of this nature is under no circumstances covered under the manufactures warranty and may deem the warranty null and void. In such a case the client shall be held solely responsible for all costs incurred during any repair. It is the clients responsibility to ensure at all times that the projector is protected from the harmful effects of hostile airborne particles in the environment of the projector. The manufacture reserves the right to refuse warranty repair if a projector has been subject to wantful neglect, abandon or improper use.

What about ambient light ?

The ambient light level of any room is made up of direct or indirect sunlight and the light fixtures in the room. The amount of ambient light will determine how bright the image will appear. So, avoid direct light on the screen. Windows that face the screen should be covered by opaque drapery while the set is being viewed. It is desirable to install the projection system in a room whose walls and floor are of non-reflecting material. The use of recessed ceiling lights and a method of dimming those lights to an acceptable level is also important. Too much ambient light will 'wash out' of the projected image. This appears as less contrast between the darkest and lightest parts of the image. With bigger screens, the 'wash out' becomes more important. As a general rule, darken the room to the point where there is just sufficient light to read or write comfortably. Spot lighting is desirable for illuminating small areas so that interference with the screen is minimal.

Which screen type ?

There are two major categories of screens used for projection equipment. Those used for front projected images and those for rear projection applications. Screens are rated by how much light they reflect (or transmit in the case of rear projection systems) given a determined amount of light projected toward them. The 'GAIN' of a screen is the term used. Front and rear screens are both rated in terms of gain. The gain of screens range from a white matte screen with a gain of 1 (x1) to a brushed aluminized screen with a gain of 10 (x10) or more. The choice between higher and lower gain screens is largely a matter of personal preference and another consideration called the Viewing angle. In considering the type of screen to choose, determine where the viewers will be located and go for the highest gain screen possible. A high gain screen will provide a brighter picture but reduce the viewing angle. For more information about screens, contact your local screen supplier.

Image size

The projector is designed for projecting an image size with a screenwidth from 1.00m (3.3ft) to 10.00m (32.8ft) with an aspect ratio of 16 to 9.

Image retention

Image retention can affect LCD projectors, in extreme cases, permanent "burn" can occur if still/repetitive images are left on the screen for long periods of time. Such damage to the panels is NOT covered by warranty.

Please ensure that the following precautions are taken to avoid this phenomenon :

1. Use a screensaver (that moves)
2. Periodically change/alter any background images on the desktop
3. Turn off the projector when not in use.

3.3 Network implementation

Network installation

The installation of the server in a Local Area Network must be done in the same way as the installation of a standard PC in that particular network meaning that the same rules and accepted practice should be respected.

The assistance of qualified IT personnel is advised.



CAUTION: Important !

A Virus protection program should be installed and kept up to date to prevent virus infections.



CAUTION: The maintenance of the Server must be done in the same way as a PC meaning that the same rules and accepted practice should be respected.

Backups should be taken on a regular basis.

In the same way virus updates should be done regularly.

Barco will not be held responsible for destroyed information in case of a hard disk breakdown or virus infection and has no obligation to pay for or reimburse for the cost of recovering data.

4. INSTALLATION

Overview

- Battery installation in the RCU
- Lens installation
- Projector Configuration
- Positioning the projector
- Connections
- Controls overview

Projector dimensions

Dimensions are given in mm and inch (1 inch = 25.4 mm)

4. Installation

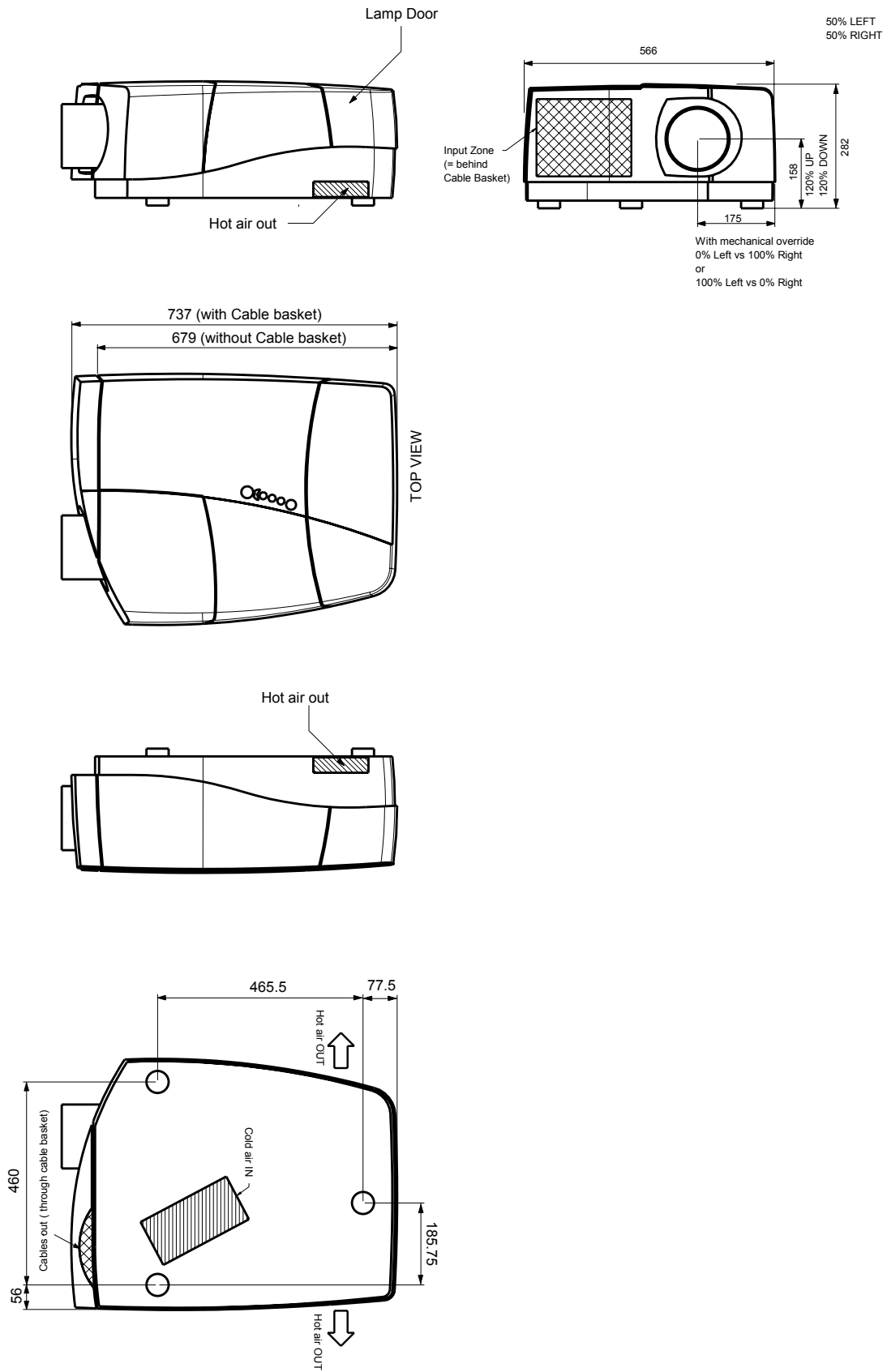

Image 4-1

4.1 Battery installation in the RCU

How to install the battery

Two batteries are packed together with the RCU. Before using your RCU, install first these batteries.

1. Remove the battery cover on the backside by pushing the handle a little towards the bottom of the RCU.
2. Lift up the top side of the cover at the same time.
3. Insert the batteries as indicated in the RCU.
4. Put the battery cover on its place.

How to replace the batteries in the RCU

To replace the batteries :

1. Remove the battery cover on the backside by pushing the handle a little towards the bottom of the RCU.
2. Lift up the top side of the cover at the same time.
3. Push on the + side of the battery towards the - side
4. Lift up the battery at the same time.
5. Repeat for the second battery.
6. Insert the batteries as indicated in the RCU (battery type AA or LR6 or equivalent).
7. Put the battery cover on its place.

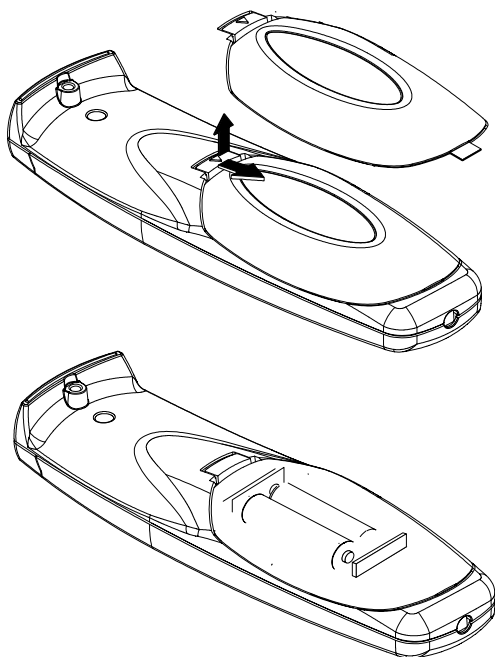

Image 4-2

4.2 Lens installation



The installation of the lens itself is only for authorized Barco technicians. Refer to the lens installation manual.

Overview

- Removing/installing the cable basket
- Lens range
- Lens formulas

4. Installation

4.2.1 Removing/installing the cable basket

Necessary tools

No tools.

How to remove the cable basket ?

1. Press on the top of the cable basket so as to unlock the top part from the projector.

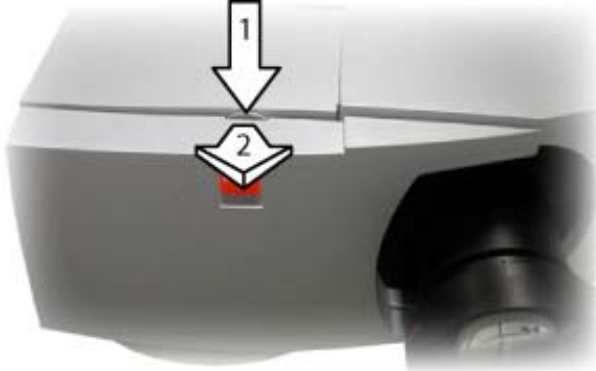

Image 4-3

2. Pull the cable basket so as to free it from the bottom locks.

How to install the cable basket

1. Place the 2 feet of the cable basket into the 2 bottom locks of the projector.



Image 4-4

2. Bring the basket towards the projector and press on it so as to lock it at the top.

4.2.2 Lens range

Overview table

Lens	Partnumber
QFD (1.27:1)	R9840400
QFD (2.5:1)	R9840290
QHD (1.4–2.1:1)	R9849800
QFD (2.1–3.0:1)	R9840390
QGD (3.5–4.5:1)	R9840060
QFD (4.5–6.0:1)	R9840100
Qfd (7:1)	R9840410



See the Maintenance appendix for more information about lens cleaning.

4.2.3 Lens formulas

Formulas

	Metric Formulas (meter)	Inch formulas (inch)
QFD (1.27:1)	$PD_{\min} = 1.287 \times SW$	$PD_{\min} = 1.287 \times SW$
QFD (2.5:1)	$PD_{\min} = 0.0264 + 2.461 \times SW + 0.00074/SW$	$PD_{\min} = 1.039 + 2.461 \times SW + 1.142/SW$
QHD(1.4-2.0:1)	$PD_{\min} = -0,245 + 1.526 \times SW + 0,129/SW$ $PD_{\max} = -0,016 + 2,185 \times SW$	$PD_{\min} = -9.645 + 1.526 \times SW + 199.950/SW$ $PD_{\max} = -0.630 + 2.185 \times SW$
QFD (2.1-3.0:1)	$PD_{\min} = 0.0232 + 2.112 \times SW - 0.0764/SW$ $PD_{\max} = -0.066 + 2.954 \times SW + 0.00068/SW$	$PD_{\min} = 0.913 + 2.112 \times SW - 118.420/SW$ $PD_{\max} = -2.622 + 2.954 \times SW + 1.052/SW$
QGD (0.86:1)	$PD = -0.030 + 0.866 \times SW - 0.00109/SW$	$PD = -1.181 + 0.866 \times SW - 1.689/SW$
QFD (3.4-4.5:1)	$PD_{\min} = -0.134 + 3.444 \times SW + 0.261/SW$ $PD_{\max} = 0.144 + 4.480 \times SW - 0.0231/SW$	$PD_{\min} = 5.275 + 3.444 \times SW + 404.550/SW$ $PD_{\max} = 5.669 + 4.480 \times SW - 35.805/SW$
QFD (4.5-6.0:1)	$PD_{\min} = 0.0116 + 4.311 \times SW - 0.0943/SW$ $PD_{\max} = 0.115 + 5.942 \times SW - 0.163/SW$	$PD_{\min} = 0.4567 + 4.311 \times SW - 146.165/SW$ $PD_{\max} = 4.527 + 5.942 \times SW - 252.650/SW$
QFD (7:1)	$PD = -2.191 + 7.501 \times SW + 1.502/SW$	$PD = -86.260 + 7.501 \times SW + 2328.105/SW$



Lens program to calculate the projector distance is available on the BARCO web site : http://www.barco.com/projection_systems/customer_services/lens_program.asp

4.3 Projector Configuration

Overview

- The different configurations

4.3.1 The different configurations

The different configurations

Depending on the installation the projector can be mounted in different ways, the 4 different configurations are:

- Rear/Ceiling
- Rear/Table
- Front/Ceiling
- Front/Table

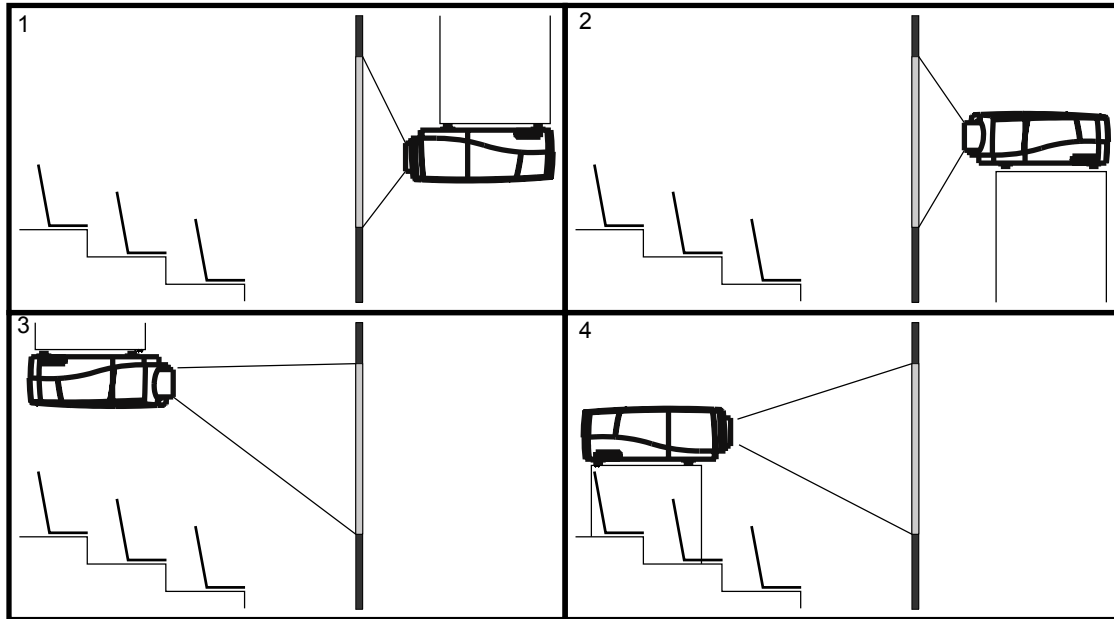

Image 4-5



The configuration should also be communicated to the projector. This is done in the *Installation* menu through the *Projector Configuration* parameter. (See Setup section)

4.4 Positioning the projector



On-Axis projection

Projection where the projector is positioned so as to have the centre of the lens coinciding with the centre of the screen.

Positioning the projector

The position of the projector with reference to the screen may also be different depending on the installation. Basically the projector can be positioned in an On-Axis or Off-Axis configuration. Several parameters can be calculated determining the position in any installation.

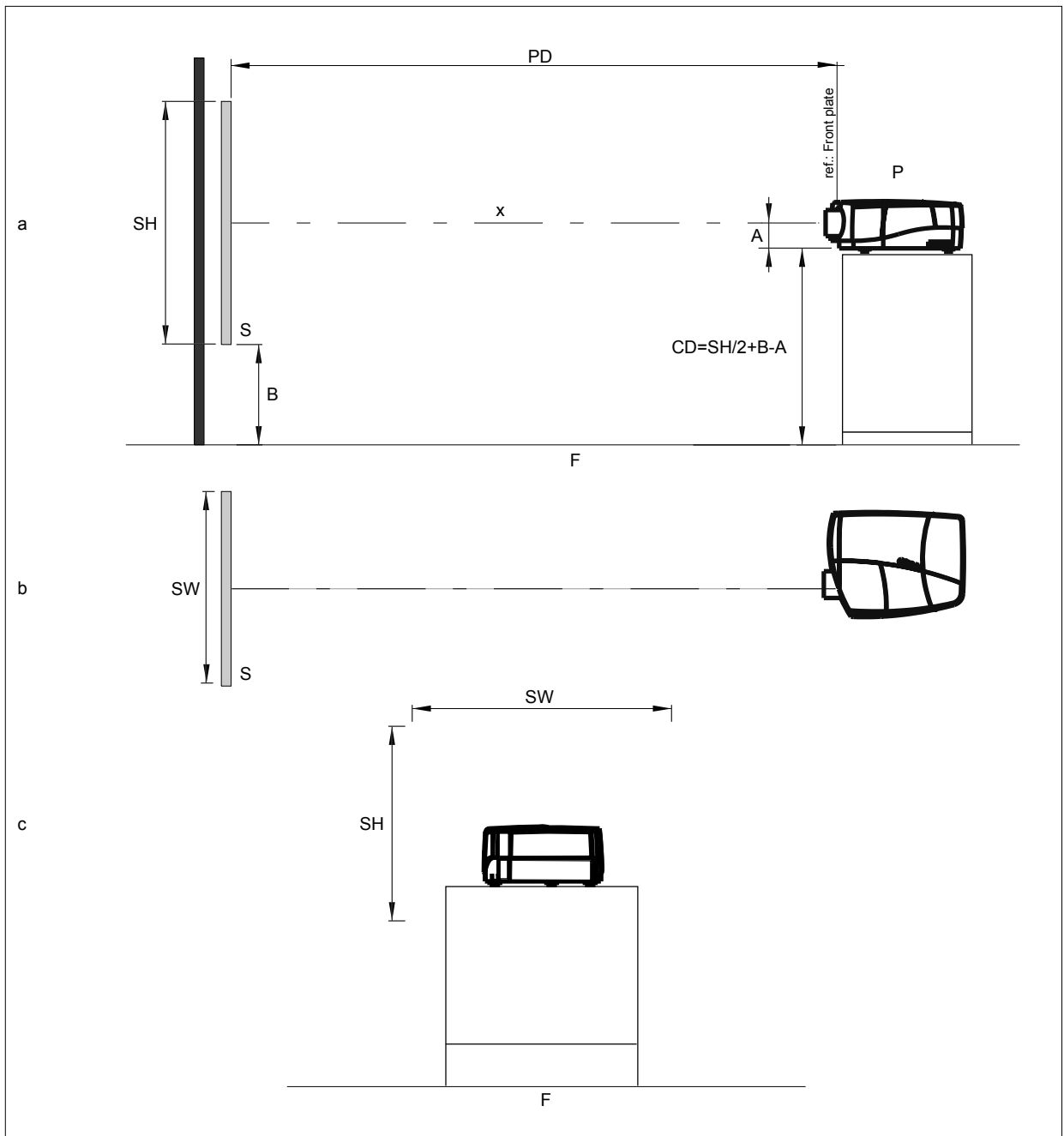

Image 4-6
On-Axis projector installation

- a Side view
- b Top view
- c Back view
- x Optical axis projection lens
- p Projector
- s Screen
- F Floor

4. Installation

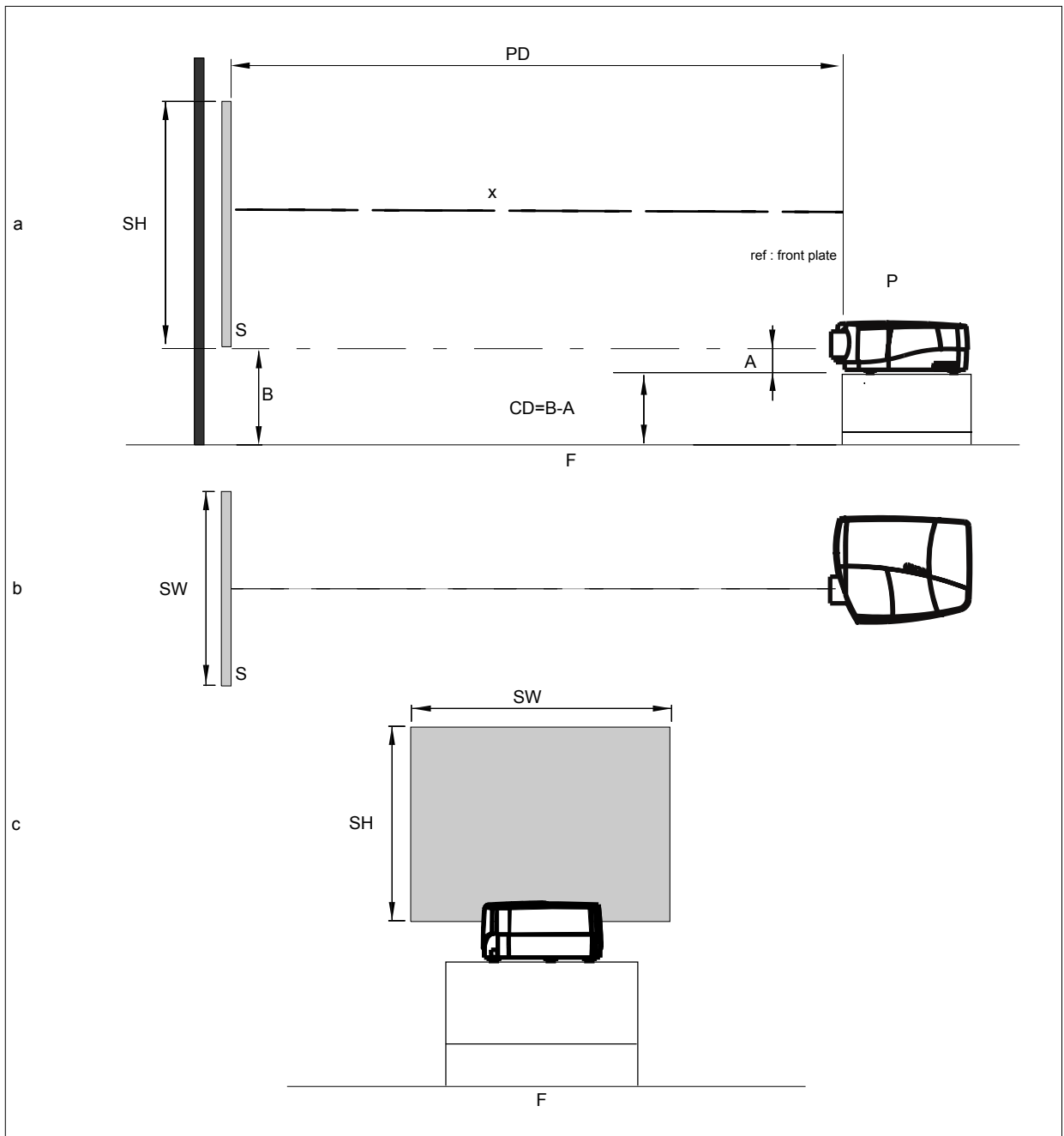

Image 4-7
Off-Axis projector installation

- a Side view
- b Top view
- c Back view
- x Optical axis projection lens
- p Projector
- s Screen
- F Floor



A 100% Off-Axis position means that the position of the centre of the lens is shifted by half the screen height.



Never use a short throw lens in an Off-Axis installation. Shifting the lens will not guarantee optimal image quality.



CAUTION: The harddisk in the Icon is formatted in a horizontal position but can operate in all axes (6 directions). The projector should, however, not be tilted more than +/- 5 degrees from these positions, otherwise error rates will increase.



CAUTION: Never place the projector on either side !

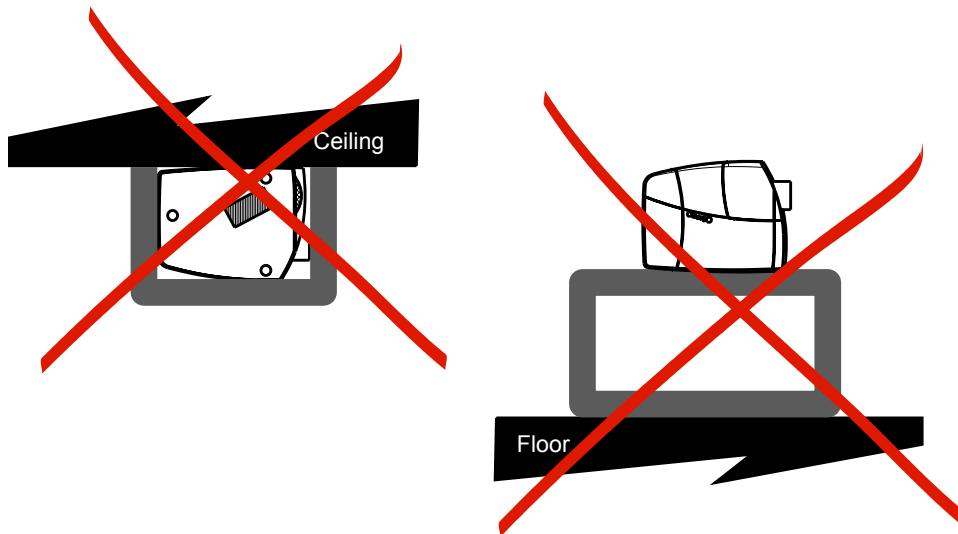

Image 4-8

4.5 Connections

Overview

- Power connection
- Connections
- Signal connections

4.5.1 Power connection

Power connection

1. Use the supplied power cord to connect the projector to the power outlet.
2. Plug the female power connector into the male connector at the front of the projector, secure the connection with the locking spring.

4. Installation

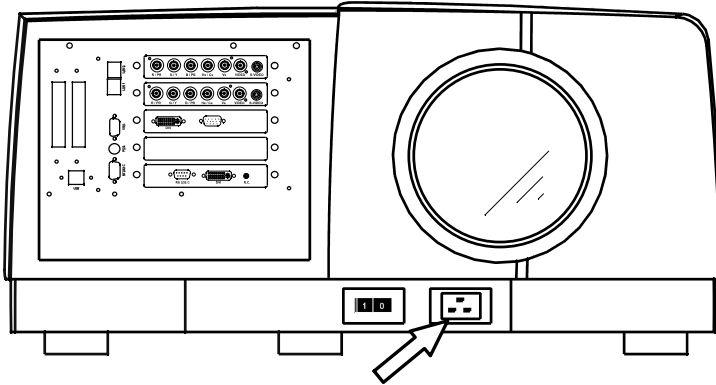

Image 4-9



CAUTION: To prevent damage to the projector always insure that the locking spring is well engaged !

4.5.2 Connections

Server section layout

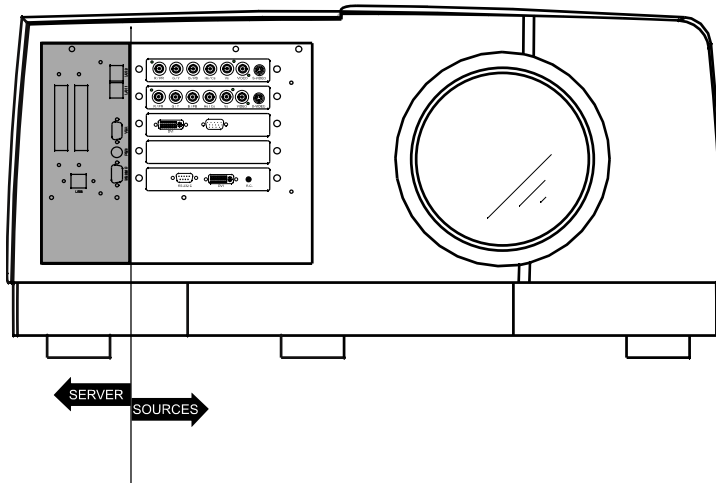

Image 4-10
Server section

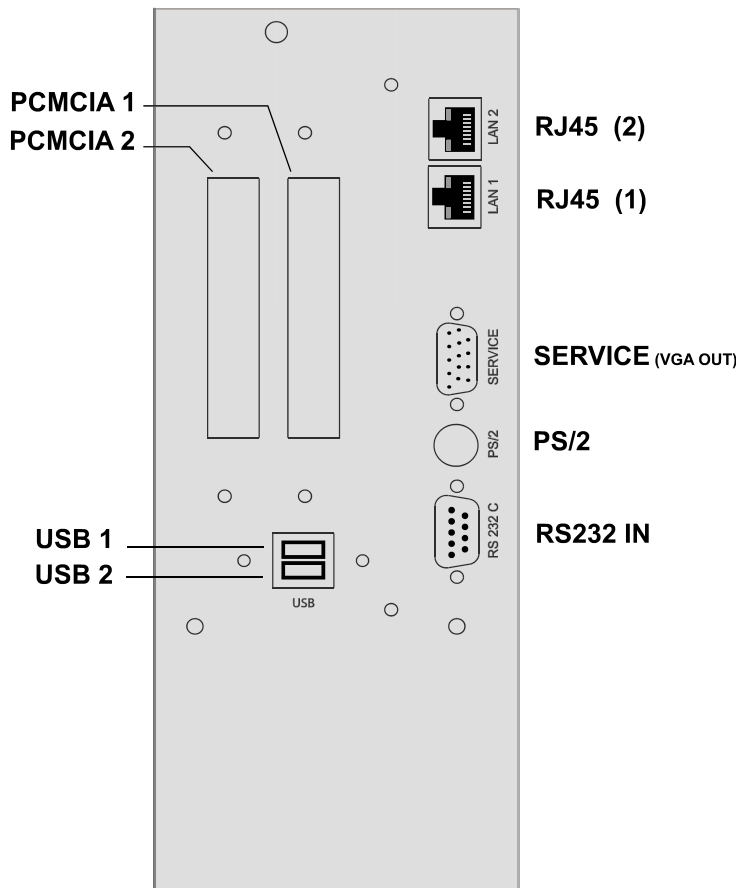

Image 4-11
Server connections

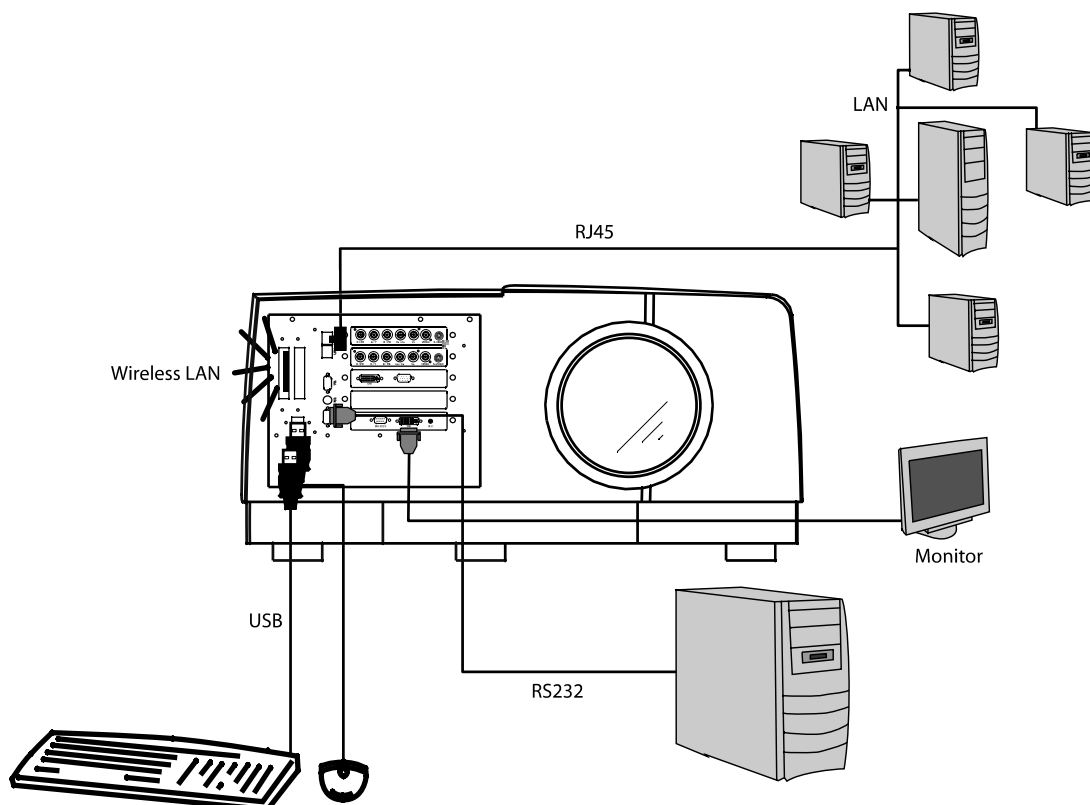

Image 4-12
Typical server connection

4. Installation

How to connect the iCon server ?

1. Use one of the 2 RJ45 connectors to connect the server to the installed network.
2. Use the USB ports to connect peripherals such as a mouse or a keyboard, ...
3. Use the PCMCIA slot to connect a Wireless LAN card or other optional inputs like Bluetooth, Modem cards,...

Note: *recommended card type:*

-The card should be a type II card.

-The card should be Windows™ XP compatible



When using the PS2 port to connect a keyboard always use the delivered PS2 splitter cable. Connecting the keyboard directly to the projector will not work.



The Service output is only intended for service purposes (boot sequence).



Point to point configuration

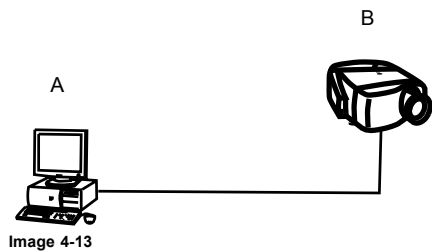

Image 4-13

In case of a temporary configuration (demo purposes) one can use the point to point configuration, the connection being done via RJ45 connections using a crossed UTP cable.



The connection of the server section of the projector should be done in the same way as for a standard PC. If necessary, contact your local IT administrator.

4.5.3 Signal connections

4.5.3.1 The input/output section

Input layers

The input/output section is located at the front of the projector and has a modular architecture i.e. it is composed of 4 slots which can be equipped with different input modules and one slot which can be used as an output :

The different available inputs :

- RGBHV & Video analog input module
- DVI & Computer (D15) input module
- HD-SDI module

The different available outputs :

- DVI output & RS232 module

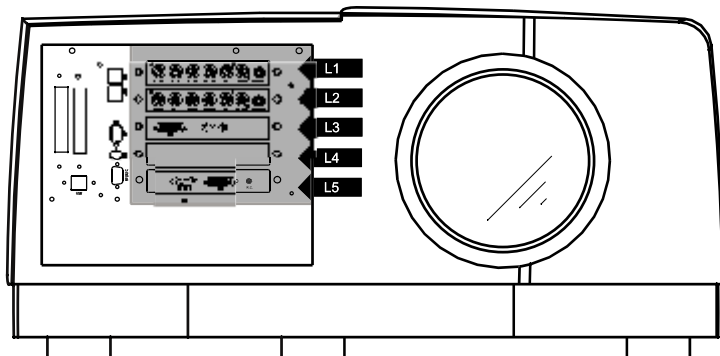

Image 4-14
Input section of the iCon : default configuration

The iCon is by default equipped as follows:

- Slot 1 : RGB input board
- Slot 2 : RGB input board
- Slot 3 : DVI input board
- Slot 4 : empty
- Slot 5 : DVI output board

4.5.3.2 Input boards specifications

RGB & Video analog input board

This board includes :

- RGBHV 5 BNC input :
RGBHV ampl = $0.7V \pm 3dB$
 75Ω terminated
- Composite video input :
 $1.0 V_{pp} \pm 3dB$
 75Ω terminated
No loop through
- S-Video input

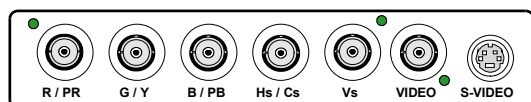

Image 4-15
RGB analog input board

DVI & Computer input board

This board includes :

- DVI single link digital input
even though the connector is of the DVI-I type, the analog part is not supported.
- Computer input
TTL sync : $U_{min} = 2.0V$
RGB ampl = $0.7V \pm 3dB$

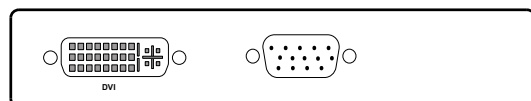

Image 4-16
DVI digital input board

DVI output board

This board includes :

4. Installation

- DVI-D single link digital output at projector resolution (1920x1080)
- RS232 IN serial communication port
- Remote control input for wired communication

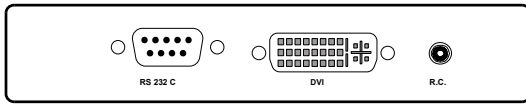

Image 4-17
DVI output board

4.5.3.3 Connecting a Composite video signal

Composite video connection

A Composite video signal is often available on a yellow cinch connector of a Camera, VCR or DVD player, in this case you will need an adapter cable cinch/BNC to connect to Video input of the RGB board.

How to connect a composite video signal

1. Connect the BNC connector to the projector's BNC video input

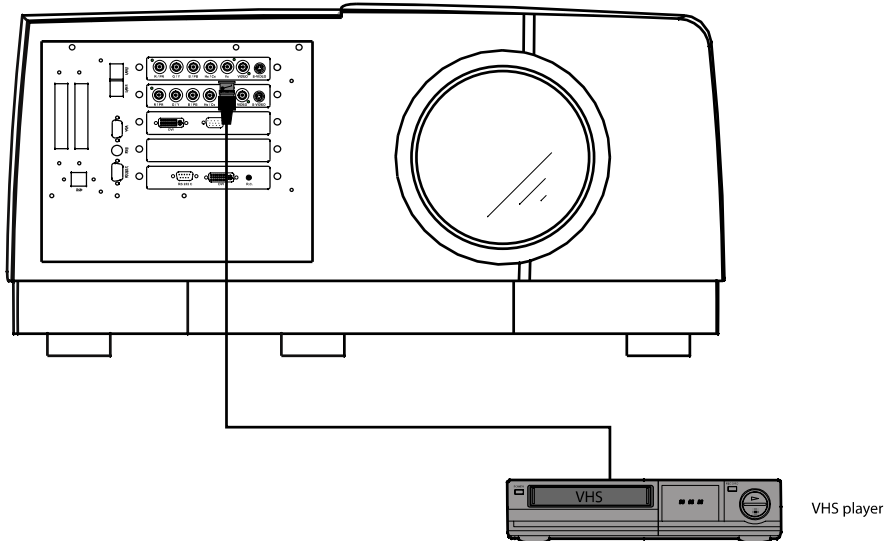

Image 4-18

4.5.3.4 Connecting an S-Video signal

S-Video connection

An S-Video signal is available on the Mini-Din connector of a camera, VCR or DVD player.

How to connect an S-Video connection

1. Connect the mini din connector to the projector's S-Video input

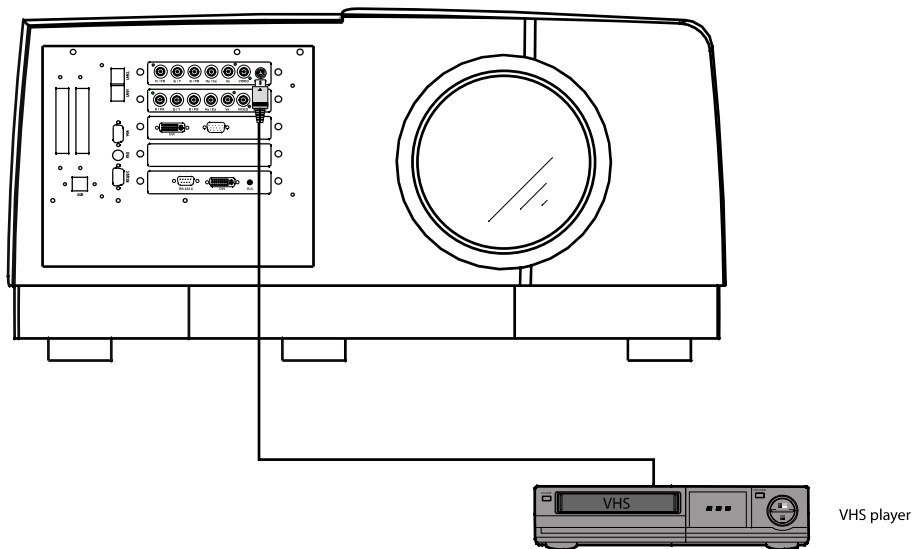

Image 4-19

4.5.3.5 Connecting an RGB signal

RGB data connection

The RGB input consists of 5 BNC

- 3 for the color signals R,G,B
- 2 for the sync signals H (horizontal sync), V (vertical sync)

RGBS : If the source disposes of a composite sync output i.e. one wire includes the horizontal **and** the vertical sync than the V BNC must not be connected, resulting in 4 BNC being connected (V is free).

RG_sB : If the source disposes of a sync on Green output i.e. the Green color signal includes the horizontal **and** the vertical sync than the H and V BNC's must not be connected, resulting in 3 BNC being connected (H and V are free).

	BNC Connector				
	R	G	B	H	V
RGBHV	R	G	B	H	V
RG _s B	R	G _s	B	-	-
RGBS	R	G	B	S	-

Table 4-3
How to use the BNC's in case of different RGB signals



The RGB 5 BNC input can also be used to connect a component video source : see *Connecting a Component video source*.

How to connect an RGB signal

1. Connect the 5 or 4 BNC cables to the projector's RGB input

4. Installation

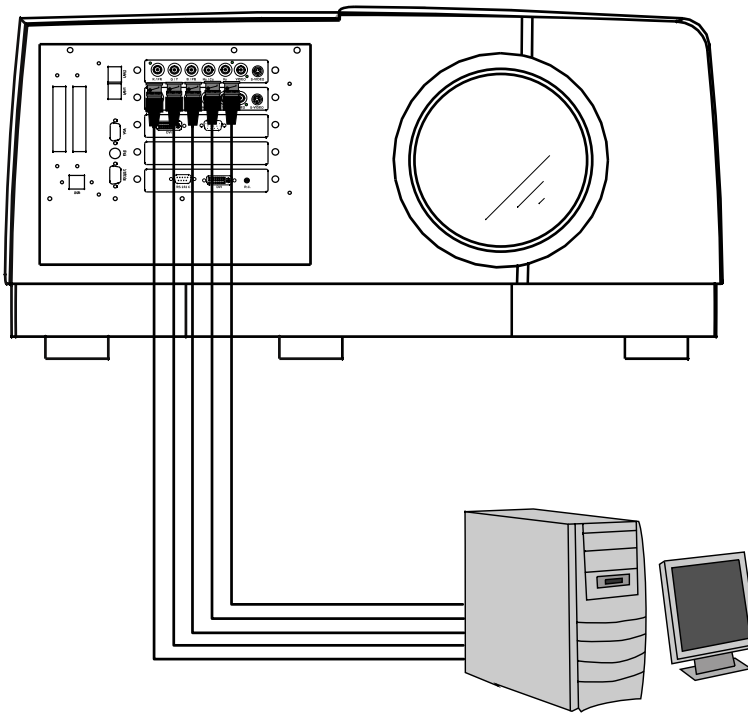

Image 4-20
RGB source connection

4.5.3.6 Connecting a Component Video signal



Component Video

In Component Video the term component describes a number (3) of elements that are needed to make up the video picture, these components are R-Y/Y-B-Y. A composite video signal on the other hand contains all the information needed for the color picture in a single channel of information

How to connect a Component video signal

1. Connect the 3 BNC connectors to the projector's RGB input

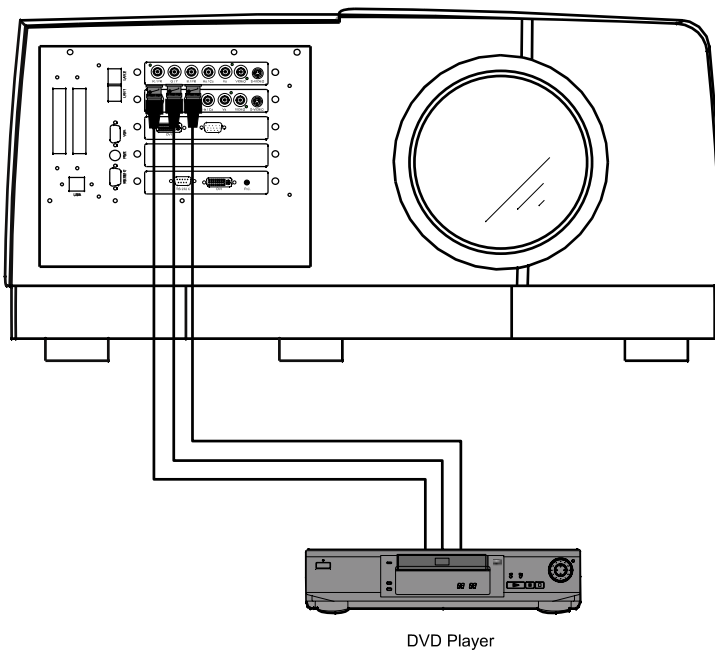

Image 4-21

DVD Player



In case of a “progressive scan” component video source, the notation used is PR/Y/PB

4.5.3.7 Connecting a DVI signal



DVI

Digital Visual Interface is a display interface developed in response to the proliferation of digital flat panel displays.

The digital video connectivity standard that was developed by DDWG (Digital Display Work Group). This connection standard offers two different connectors: one with 24 pins that handles digital video signals only, and one with 29 pins that handles both digital and analog video. This standard uses TMDS (Transition Minimized Differential Signal) from Silicon Image and DDC (Display Data Channel) from VESA (Video Electronics Standards Association).

DVI can be single or dual link.

Input specifications

Single link DVI

Differential input voltage: 200 mV - 800mV

How to connect a DVI signal ?

1. Connect the DVI cable to the DVI input

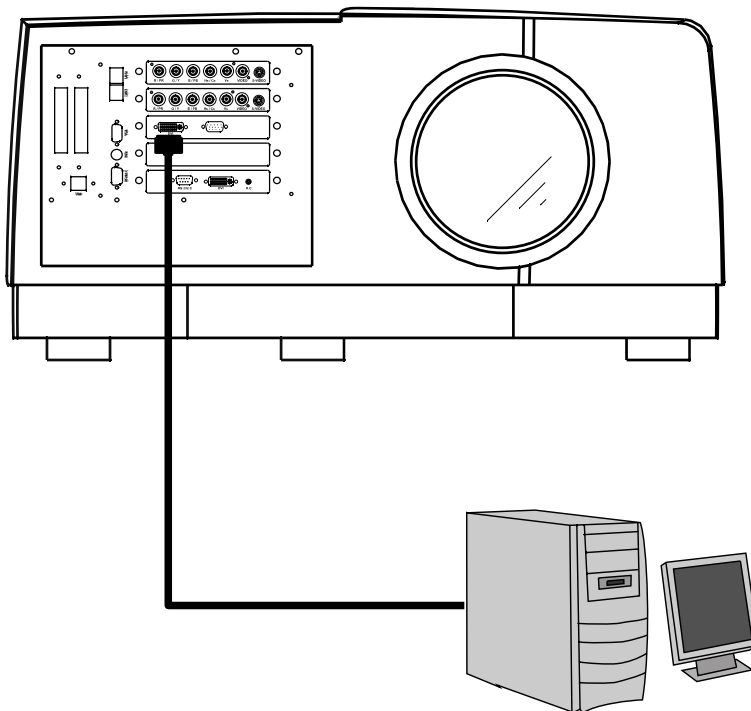

Image 4-22

4.5.3.8 Connecting a computer signal

How to connect a computer signal

1. Connect the D15 connector to the projector's Computer input

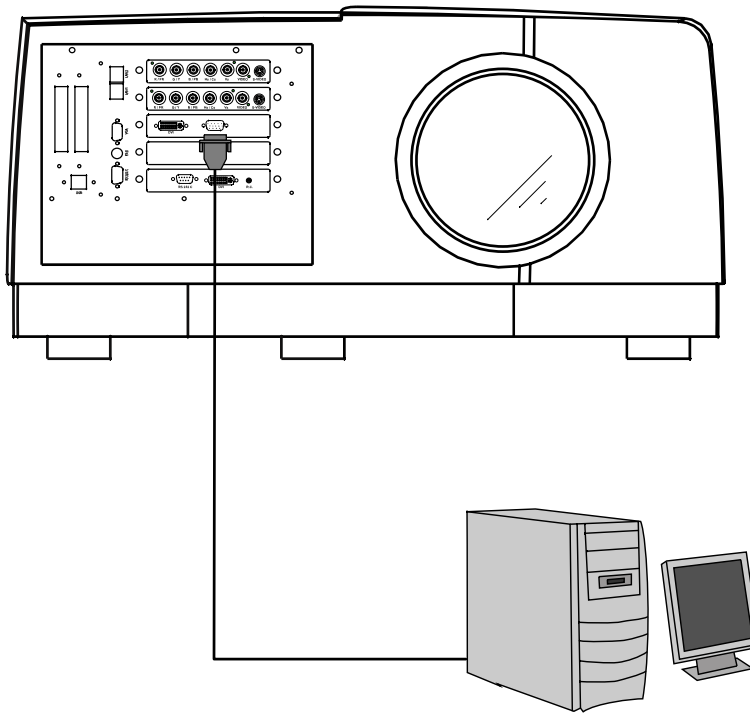

Image 4-23

4.6 Controls overview

RCU

The following table gives an overview of the different functionalities of the keys.

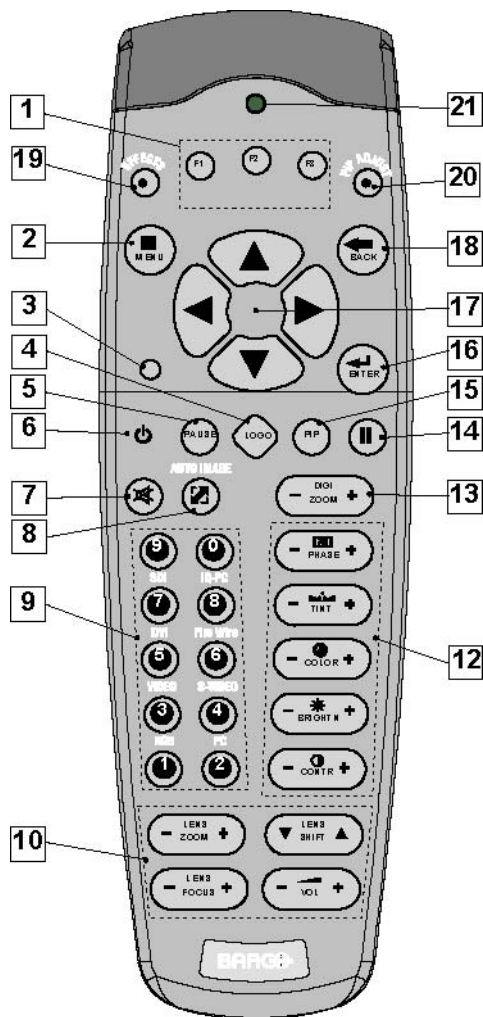

Image 4-24

1	Function keys	user programmable keys with functions for direct access.
2	MENU	Menu key, to enter or exit the Tool bar menu.
3	Address key	(recessed key), to enter the address of the projector (between 0 and 9). Press the recessed address key with a pencil, followed by pressing one digit button between 0 and 9.
4	LOGO key	not implemented
5	PAUSE	to stop projection for a short time, press 'PAUSE'. The image disappears but full power is retained for immediate restarting.
6	STBY	standby button, to start projector when the power switch is switched on and to switch off the projector without switching off the power switch. Attention : Switching to Standby. When the projector is running and you want to go to standby, press the standby key for 2 seconds.
7	MUTE	to interrupt the sound reproduction (audio = optional).
8	AUTOIMAGE	Auto image, to center the image on the active LCD surface.
9	Digit buttons	direct input selection.
9b	SOURCE button	the Source Selection menu is opened
10	Lens control	use these buttons to obtain the desired ZOOM, SHIFT, FOCUS.
11	VOL	use this button to obtain the desired sound level (audio = optional)
12	Picture controls	use these buttons to obtain the desired picture analog level.

4. Installation

13	DIGI ZOOM	not implemented
14	FREEZ	press to freeze the projected image.
15	PIP	not implemented
16	ENTER	to confirm an adjustment or selection in the MENU. On the local keypad the ENTER button additionally accesses the PIP window resize function
17	Cursor keys	Cursor Keys on RCU or on the local keypad : to make menu selections or to access the toolbar.
18	BACK	to leave the selected menu or item (go upwards to previous menu).
19	EFFECTS	not yet implemented
20	PIP ADJUST	allows to select a PiP window and change its configuration on screen
21	RC operating indication	lights up when a button on the remote control is pressed. (This is a visual indicator to check the operation of the remote control)
22	IR receiver	IR receiver

Table 4-4



ordernumber RCU: R763794K

5. SETUP

Overview

- Powering up the projector
- Starting up the projector
- Setting up the RCU address
- Setting up the projector address (only if necessary)
- Setting up the orientation
- Adjusting the lens
- Setup the baudrate for serial communication
- Setting the server ON/OFF state
- Preferences
- Installing the software
- Configuring the client software
- Configuring the Server software
- DropZone settings
- Start up

Important note !

Never change the display settings (graphical card settings) of the single board computer ! Doing this will not guarantee proper functioning of the projector. Always leave them in the default (factory) setting.

5.1 Powering up the projector

How to power up the projector

1. Switch the power switch to "1"

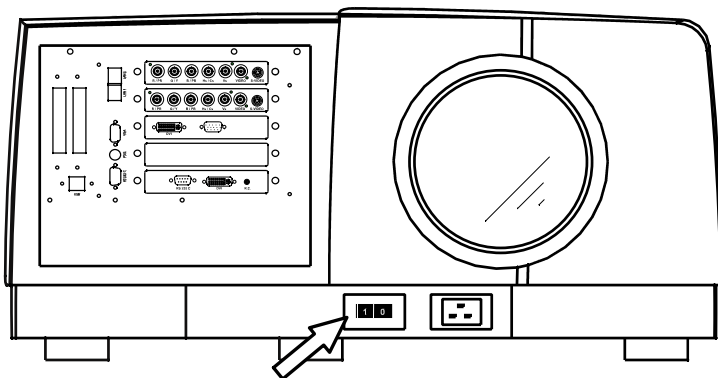
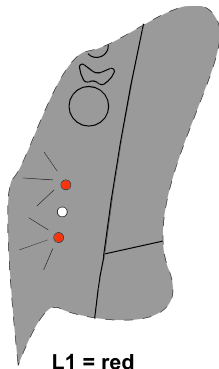

Image 5-1

5. Setup

L3 and L1 light up red. After the initialization period L1 goes off.



L1 = red
L3 = red
Image 5-2

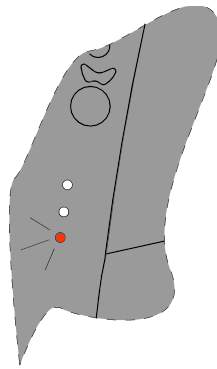

Image 5-3
Standby state : L3 is red

5.2 Starting up the projector



Starting up will only be possible after the initialization period i.e. when Led1 is off.

How to start up the projector ?

1. Press the **Standby** button on the RCU or on the local keypad.

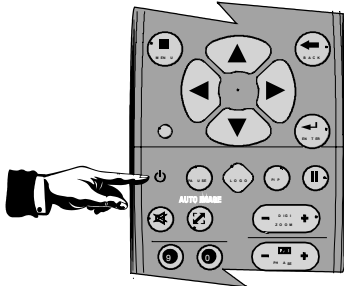

Image 5-4

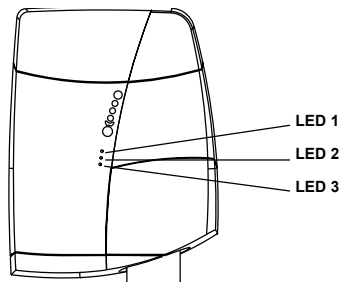

Image 5-5

During startup Led3 becomes orange. When the projector becomes operational Led3 goes off and will only blink when receiving IR commands from the remote control.

The iCon server source is displayed i.e. the Windows™desktop is displayed.



Led2 blinking means that the projector is in standby while the Server is active



If the address setting is wrong the projector will not respond to the RCU, see the next step to set the address.



For more information on Server startup and shutdown see the **Setup** menu.

5.3 Setting up the RCU address

What has to be done ?

To allow the communication between the RCU and the projector the RCU has to be programmed with the same address as the projector.

This address must be in the range 0–9.

To know the address of the projector, one can visualize it in projection mode (on screen) as well as in standby mode (shown with the LED's on top cover of the projector).



For more info on addresses see the appendix



At this stage the image projected may happen to be upside down or mirrored, this can be set in the *Installation* menu under *Projector orientation* (see further setting up the projector's orientation).

Displaying the Projector Address in Standby mode

1. Press the **Address** key (recessed key on the RCU) with a pencil.

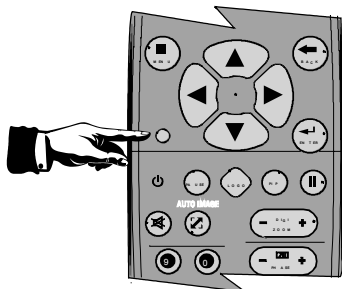

Image 5-6

All the LED's (3) on the top cover of the projector go out.

Then LED1 starts blinking green the number of hundreds. After that LED2 starts blinking the number of tens. Finally LED3 starts blinking green the number of units. If this is done, the original status of the LED's is restored.

Displaying the Projector Address in projection mode)

1. Press the **Address** key (recessed key on the RCU) with a pencil.

The projector's address will be displayed on the screen in a Textbox

Programming the RCU

1. Push the address key If the address is not entered within 5 seconds, the RCU returns to its default address (zero address) and controls then all projectors in the room.
2. Enter the same address with the digit buttons **within 5 seconds** after pushing the address key.

The projector can now be controlled with the RCU.



For example : if the projector address is 3, then press "3" on the RCU to set the RCU's address to match the projector's address.



Common address/Projector address : Beside the projector address, the projector disposes also of a Common address which can be set to "0" or "1" (by default "0").

In other words, an RCU set to address "0" will always control a projector regardless of its projector address (since it uses the common address).

5.4 Setting up the projector address (only if necessary)

What can be done ?

The projector is shipped with projector address set to "0"

In some cases the projector address must be changed, for example if an unique RCU is used to control 2 or more projectors (independently).

In the OSD menu *Projector Address*, the following addresses can be programmed :

- Projector address: address defined by the user, may be from 0 to 255
0-9 is used for RCU communication, 0-255 being used for RS232 serial communication.
- Common address : address may be 0 or 1



For more info on addresses see the appendix

How to change the projector's address ?

1. Press **MENU** to activate the Tool bar
2. Press → to select the *Installation*
3. Press ↓ to Pull down the *Installation* menu
4. Use ↑ or ↓ to select *Projector address*



Image 5-7

5. Press **ENTER**

A dialog box appears on the screen

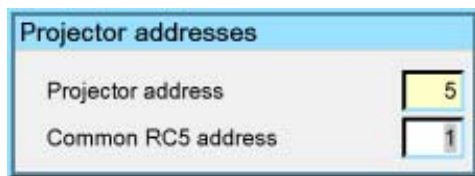

Image 5-8

6. Enter the new projector address with the digit keys on the RCU, the local keypad or the cursor keys.

How to change the common address ?

1. Proceed in the same way as for the projector address

5.5 Setting up the orientation

What must be done ?

Depending on the mechanical orientation of the projector, the projector's internal settings have to be adapted.

The projector is shipped (default) with a table/front orientation.

How to set the orientation ?

1. Press **MENU** to activate the Tool bar
2. Press **→** to select the *Installation* item
3. Press **↓** to Pull down the *Installation* menu
4. Use **↑** or **↓** to select *Orientation*
5. Press **→** to pull down the menu
6. Use **↓** or **↑** to select the desired orientation

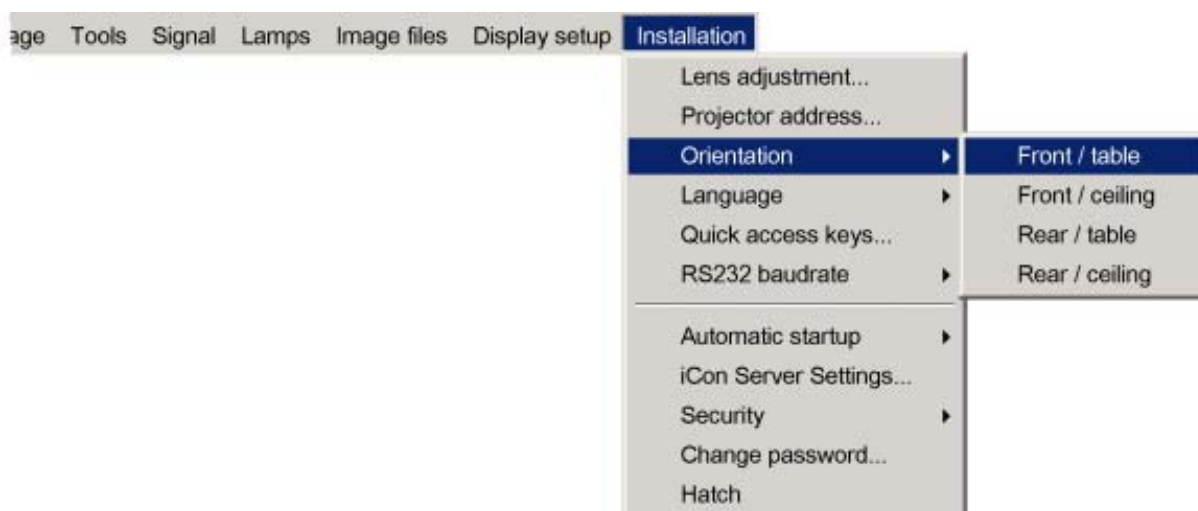

Image 5-9

7. Press **ENTER**

The projection is adapted and a bullet shows the active configuration.

5.6 Adjusting the lens

What must be done ?

Depending on the projection distance and the lens used, the image may not be at the desired size, position and/or may be out of focus.

The projector will always allow you to shift your image Vertically as well as horizontally to position it on the screen. In addition, motorized lenses will also allow you to Zoom and focus the image.

All these lens parameters can be adjusted using the RCU, the local keypad or in the Installation menu of the projector's OSD.

- Zoom (only for motorized lenses)
- Focus (only for motorized lenses)
- horizontal/vertical Shift



The lens can also be adjusted via the dedicated keys on the remote.

How to Zoom/focus or shift via the RCU (or keypad)

1. Press **LENS ZOOM** or **LENS FOCUS** or **LENS SHIFT** on the RCU

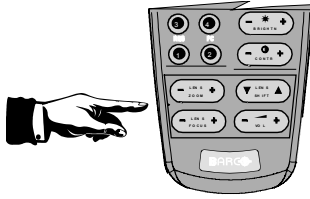

Image 5-10

2. Use the arrow keys to adjust

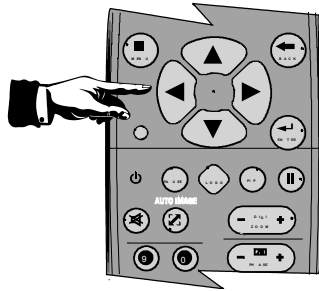

Image 5-11

How to Zoom/focus or shift in the OSD ?

1. Press **MENU** to activate the Tool bar
2. Press → to select the *Installation*
3. Press ↓ to Pull down the *Installation* menu
4. Use ↑ or ↓ to select *Lens adjustments...*

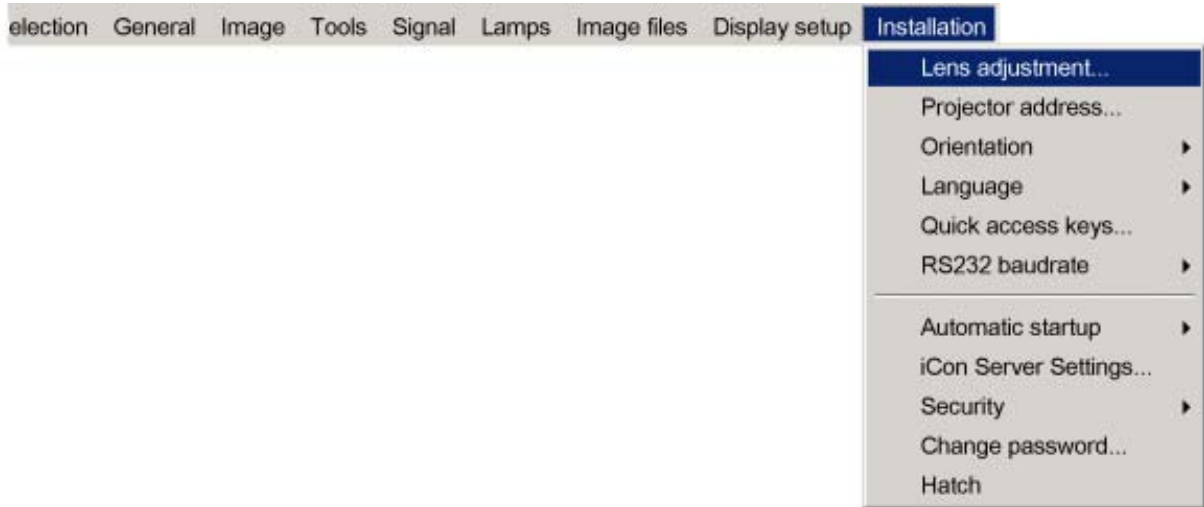

Image 5-12

5. Press **ENTER**

A textbox appears on the screen, follow the instructions.

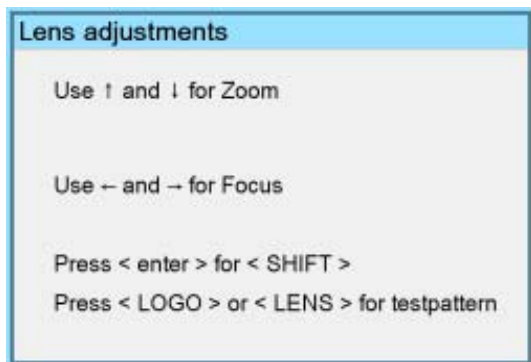

Image 5-13

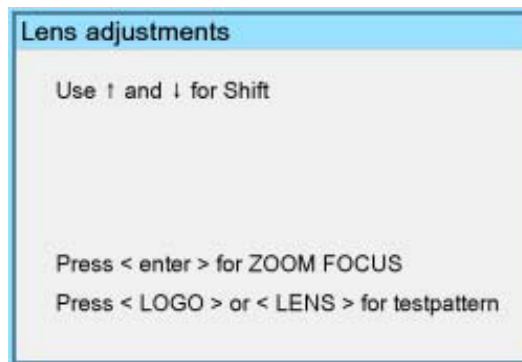

Image 5-14



The use of a sheet of paper held in front of the screen can be useful to determine the focus plane (position for best focus)



Vertical shift range : -120% to 120%
Horizontal shift range : -100% to +100%

5.7 Setup the baudrate for serial communication

What can be done ?

The RS232 IN port of the projector allows you to communicate with any other equipment disposing of an RS232 port (generally a PC used to upgrade the projector's firmware) using the RS232 protocol. The baudrate must be set to the same value on both the projector and the other equipment.

How to change the baudrate?

1. Press **MENU** to activate the Tool bar
2. Press → to select the *Installation* item
3. Press ↓ to Pull down the *Installation* menu
4. Use ↑ or ↓ to select *RS232 baudrate*



Image 5-15

5. Press → to pull down the menu

5. Setup

6. Use ↓ or ↑ to select the desired baudrate
7. Press **ENTER**



Always select the highest rate (115200) unless otherwise specified.

5.8 Setting the server ON/OFF state

Starting up

The Server (desktop) will always be displayed at projector startup, it can however still be shut down and re-started via the *General* menu.

During the standby state of the projector the Server can be chosen to be active or inactive, this is done by defining the state of the Server during a "Projector standby state".



It is recommended to leave the server ON even when the projector is in standby to allow the use of the full network capabilities.

Manual start up: How to start up/shut down/reset the Server ?

1. Press **MENU** to activate the Tool bar
2. Press → to select *General*
3. Press ↓ to Pull down the General menu
4. Use ↑ or ↓ to select *iCon Server*
5. Press → to open the menu
6. Use ↑ or ↓ to select *ON/OFF/Reset*

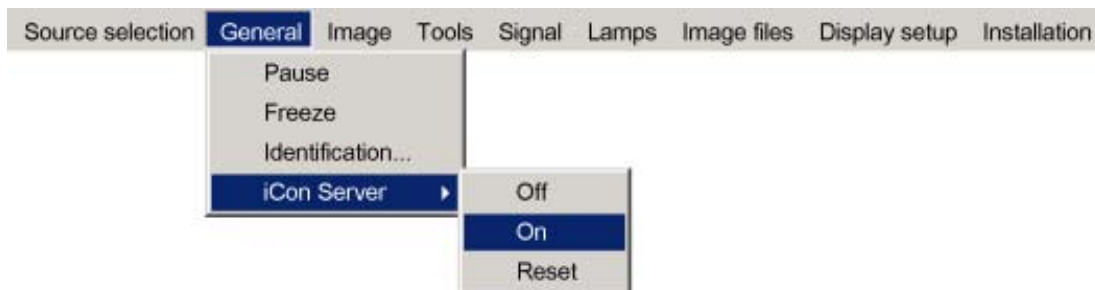

Image 5-16

7. Press **ENTER**



When resetting the Server the menu items in the Server menu are greyed out during a short period.

Projector standby state: How to set the projector standby state ?

1. Press **MENU** to activate the Tool bar
2. Press → to select *Installation*
3. Press ↓ to Pull down the menu
4. Use ↑ or ↓ to select *iCon Server settings*



Image 5-17

5. Press **ENTER**

6. A dialog box is displayed

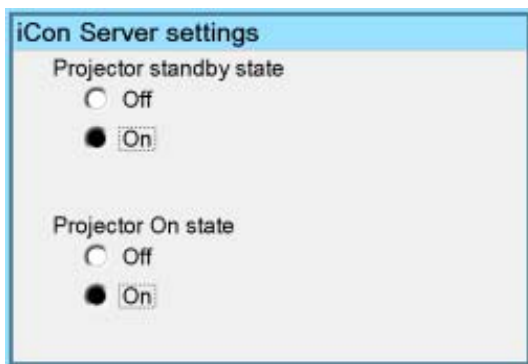

Image 5-18

7. Select *ON* or *OFF* for the "Projector standby state" setting

5.9 Preferences

Overview

- Language setting
- Pre-programming RCU quick access keys
- Automatic startup
- Background

5.9.1 Language setting

List of languages

The list of selectable languages depends on the software version of the projector.

How to change the Language ?

1. Press **MENU** to activate the Tool bar
2. Press → to select the *Installation* item
3. Press ↓ to Pull down the *Installation* menu
4. Use ↑ or ↓ to select *Language*
5. Press → to pull down the menu
6. Use ↓ or ↑ to select the desired language

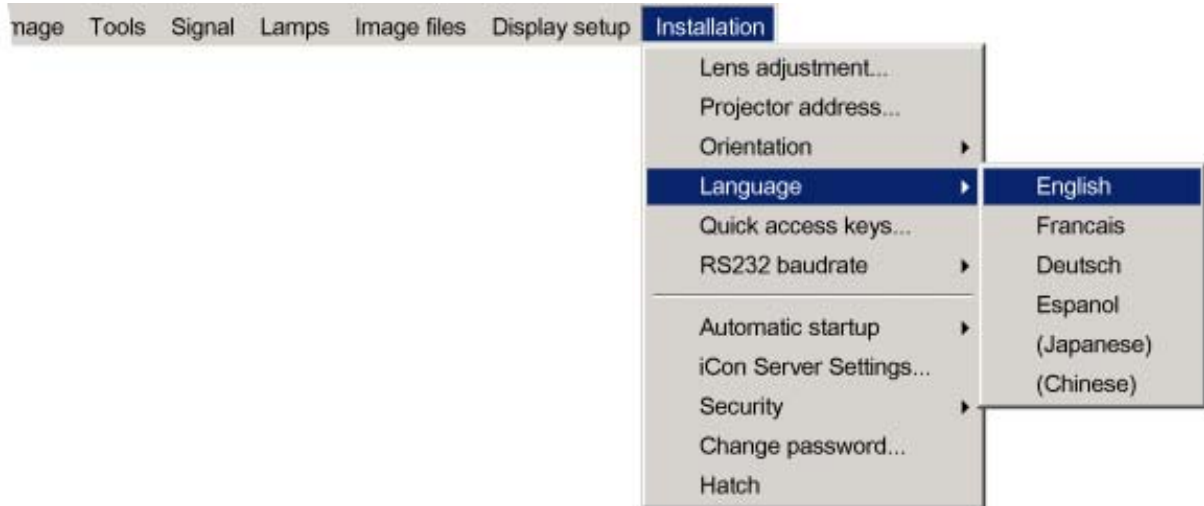

Image 5-19

7. Press **ENTER**

The language is adapted and a bullet shows the active selection.

5.9.2 Pre-programming RCU quick acces keys

What can be done ?

The 3 function keys on top of the RCU can be associated with a particular item in one of the menus.

Each function which is not password protected or does not have a key on the RCU can be associated to a function key.

How to get an overview of the quick access keys ?

1. Press **MENU** to activate the Tool bar
2. Press → to select the *Installation*
3. Press ↓ to Pull down the *Installation* menu
4. Use ↑ or ↓ to select *Quick access keys*

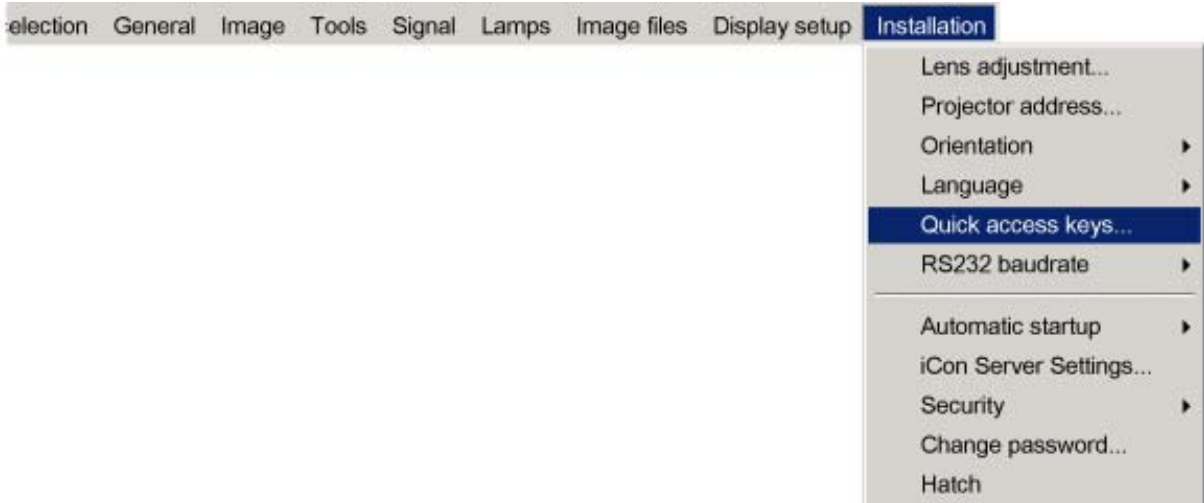

Image 5-20

5. Press **ENTER**

A textbox appears on the screen.

How to program the quick access keys ?

1. Scroll through the menus to the desired menu item
2. Push the desired function key for 3 seconds

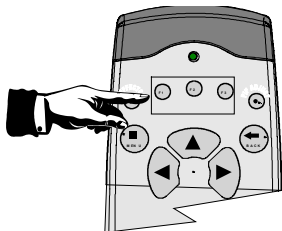

Image 5-21

The menu item is stored in the quick access key



Factory pre-programmed functions

-F1 :

-F2 :

-F3 :

5.9.3 Automatic startup

What can be done ?

The automatic startup allows to bypass the standby state i.e. start up without going in standby state after switching on the projector.

This means that the automatic startup allows immediate restart of the projector after a power failure (breakdown), i.e. without passing through the standby state, by recovering the previous settings (previous source,...).

This function can be disabled if undesired or inadequate for safety reasons, etc.



CAUTION: If the Automatic startup function is enabled one must be aware of the fact that it involves safety precautions

Make sure that the projector (or the operators!) will not be affected by altered environmental conditions when restarting at power resume.



Unless it is required, it is advised to leave this setting OFF.

In case of a power breakdown, this may introduce unwanted conditions at power resume : projector starting up with high lamp temperature conditions, bad PC status, ...

How to enable/disable the Automatic startup?

1. Press **MENU** to activate the Tool bar
2. Press → to select the *Installation* item
3. Press ↓ to Pull down the *Installation* menu
4. Use ↑ or ↓ to select *Automatic startup*
5. Press → to pull down the menu
6. Use ↓ or ↑ to enable/disable the automatic startup

5. Setup

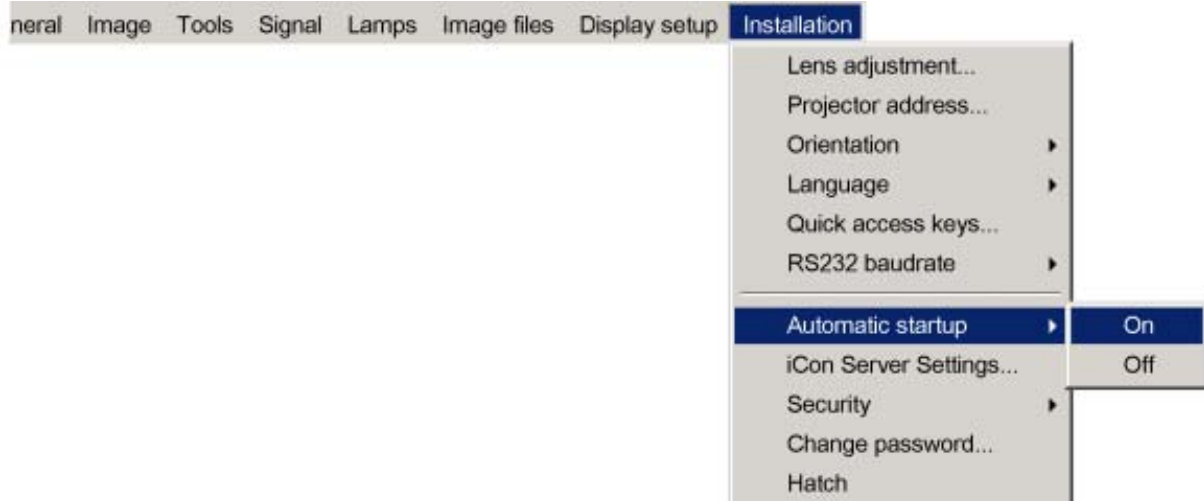

Image 5-22

7. Press **ENTER**

5.9.4 Background

Background setting

The background of the projected image can be chosen to be :

- iCon server: the desktop is always displayed in the background : video content is displayed on top of the desktop image (desktop integration).
- Black : a black image is displayed in the background

How to setup the background ?

1. Press **MENU** to activate the Tool bar
2. Press **→** to select the *Signal* item
3. Press **↓** to Pull down the menu
4. Use **↑** or **↓** to select *Background startup*
5. Press **→** to pull down the menu
6. Use **↓** or **↑** to select *Black* or *iCon Server*



Image 5-23

7. Press **ENTER**

5.10 Installing the software



An Administrator password has been installed for security reasons (worm and virus protection):

Password : Barco (case sensitive !)

Necessary parts

- installation CD (delivered)
- PC

How to install the client software ?

1. Install the client software from the CD (Setup file)

How to install the server software ?

1. The server software is by default installed on the projector.
if necessary, reinstall it from the CD.



The CD containing the server software and the client tools are delivered with the projector. They can always be downloaded from the secured PartnerZone Web site : <https://secure.barco.com/presentation/>

5.11 Configuring the client software



The same universal client interface is used for different network centric projectors (iQ, iD, iCon). The layout of the interface (position of the controls,...) is adapted after detection of the projector type. Some screenshots may not fully coincide with the reality.

How to start up the client software ?

1. Start up the previously installed client program

The interface shows 3 tabs (upper tab control) : Control, Diagnosis and Configuration

The active sub interface is the control sub screen

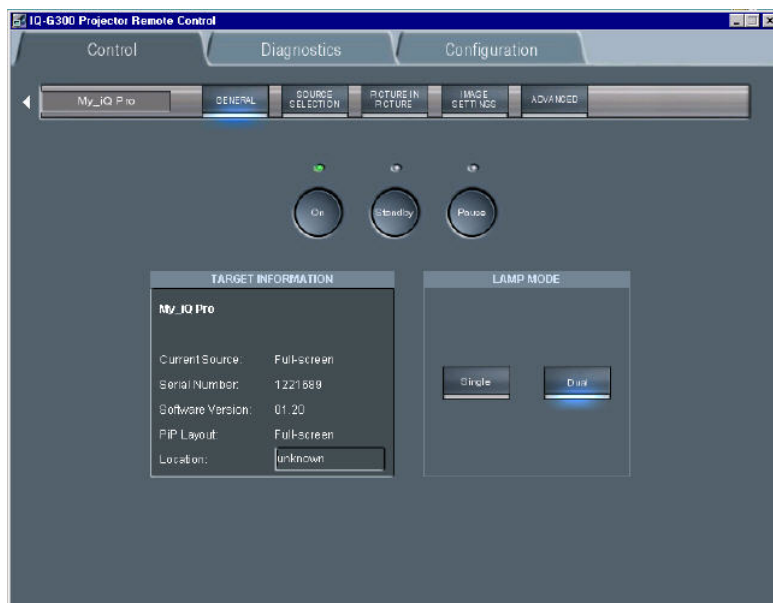

Image 5-24
Control interface

2. Click on the upper menubar to select the desired sub interface



IP

Internet Protocol. The network layer of TCP/IP. Required for communication with the internet.

How to add a projector to the projector list

1. Click on the white arrow

5. Setup



Image 5-25

A menu is dropped down

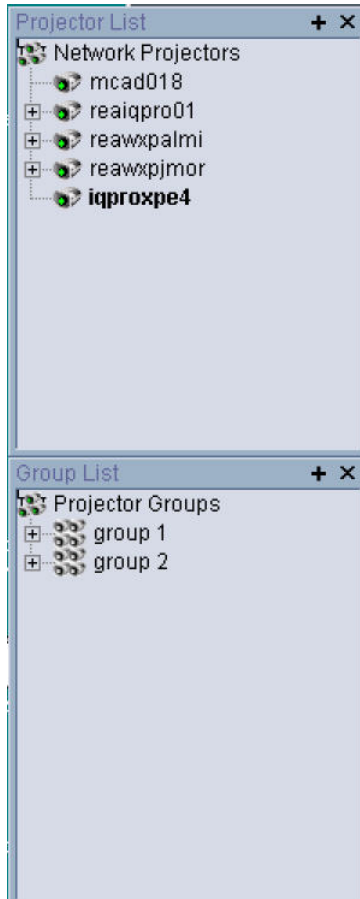

Image 5-26

projector list: contains a projector and a projector group sub list

- click on the + sign of the projector list

A dialog box is displayed

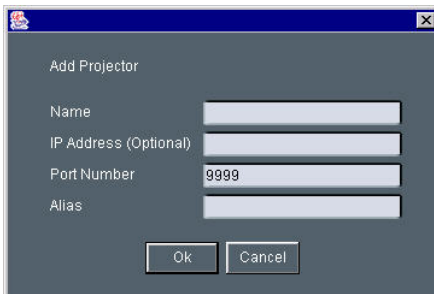

Image 5-27

- Fill in the Name, the IP address (optional) and the Port number of TCP/IP connection

Note: default port number = 9999

- Fill in the alias

Tip: "Alias" is a custom name whereas "Name" is the name by which the projector is identified on the (corporate) network

- Click OK to confirm or Cancel

The projector is now added to the list of projectors



Depending on the installed network (use of DHCP server or not), the IP address may be needed to be entered or not.



For a point to point installation the projector's IP address must be entered manually.
Check the operating system on the for the IP address, or contact your IT administrator.

How to add a projector group to the projector group list ?

1. Click on the white arrow
A menu is displayed, image 5-26
2. Click on the + sign of the projector group list
A dialog box is displayed



Image 5-28

3. Fill in the group name
4. Click OK to confirm or Cancel
The group is now added to the list of groups

How to add projectors to a group ?

1. Click on the projector to be added in the projector list
2. Drag the projector down to the projector group.
The projector is added to the group.



Adding a projector to a group can also be done by using the "Copy + Paste" method on the right mouse button menu.

How to connect to a projector or group of projectors ?

1. Double click on the projector or group of projectors

5. Setup

A green dot appears, indicating that the projector is present on the network and working properly



Image 5-29
connected and active projector

A connected and active projector

The name of the projector or group is now displayed in the upper part of the screen and indicates that the communication has been set



Image 5-30

A connected and active projector



When connected to a group of projectors, some controls may be disabled.

In general, controls will only be selected if this is the status of all projectors in the group.

Sliders will be set to a particular value only if this is the same on all projectors in the group, otherwise they will be positioned centrally with a dash in the value box. When the slider is moved the box will show the new value and this value will be sent to all projectors in the group.

Labels such as Current Source in the general page will only be shown if the string value is the same on all projectors, otherwise a dash will be shown

The Target information block

The target information block displays the main characteristics of the connected projector or group of projectors.

This gives also an indication whether the communication setting has been successful or not.



Image 5-31

5.12 Configuring the Server software

Internal network connection

The internal connection (firmware connection) between the projector controller and the single board computer uses fixed IP addresses.

The IP address of the SBC can be found in control panel

- SBC: IP address = 192.168.42.51, subnet mask = 255.255.255.248



Projector Controller's IP address = 192.168.42.50

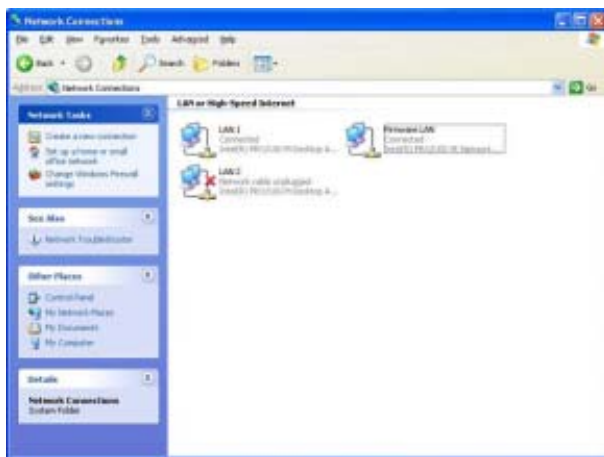

Image 5-32

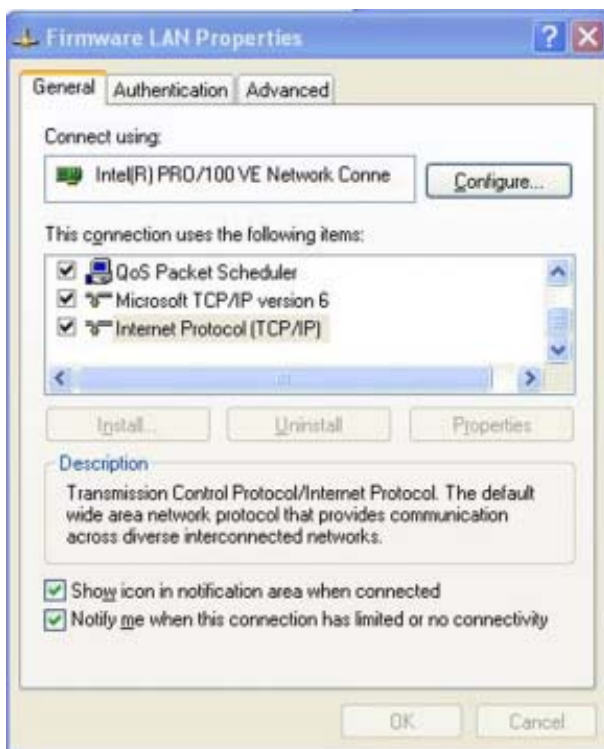

Image 5-33

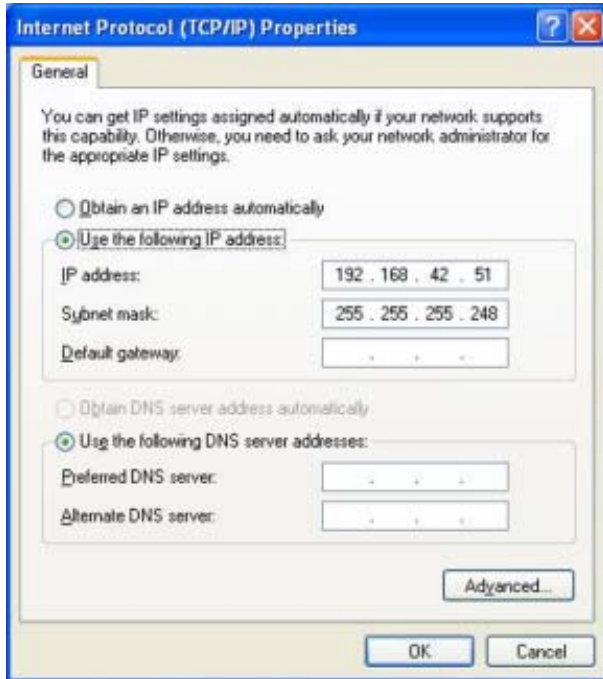

Image 5-34



CAUTION: Leave these IP addresses unchanged !

The server menu

The server menu can be opened by right clicking from the server tray icon



Image 5-35

Start Meetings control

The meeting control is started and positioned on the desktop, through out the meeting it will allow to :

- Accept requests interactively : a request for a desktop sharing from a client PC must be accepted on the iCon server, a dialog box is displayed on the iCon asking to accept or decline the desktop sharing request
- Deny all requests : all request are denied
- Accept all requests automatically : desktop sharing is always accepted at the iCon (server) without prompting for confirmation
- Notify end of meeting at : allows to set a reminder at expected end time of the meeting



Image 5-36

How to configure the Server settings ?

1. Go to the server icon in the lower task bar of the desktop and click the right mouse button.
A menu is displayed
2. Select *Settings*
A dialog box is displayed allowing to select different tabs
 - Networking
 - Dropzone, see Dropzone chapter
 - Exchange

Networking settings

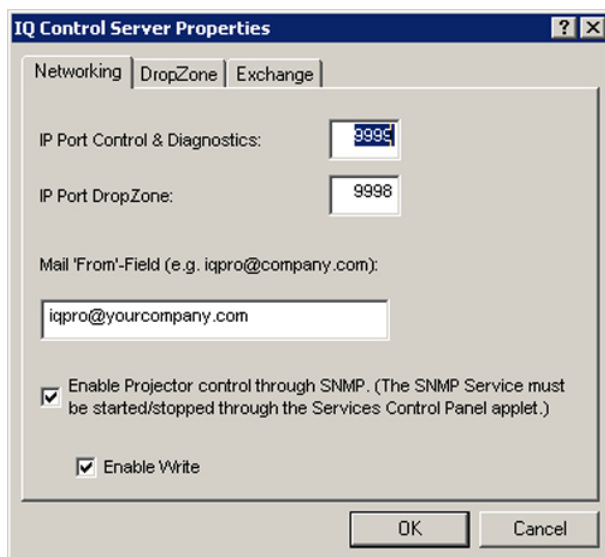

Image 5-37

- Port settings: it is advised to leave these settings in their default value.
- Mail to field : see mail configuration in the client software
- SNMP enable: allows to enable the SNMP control of the projector.
The *Enable write* option allows to enable the client to overwrite projector settings via SNMP.
Unchecking this option means that projector settings will only be read.

Exchange settings

This tab allows to fill in the exchange parameters to allow scheduling of projector tasks.

These parameters should be configured by your local IT administrator



Image 5-38

Miscellaneous settings

This tab allows following settings :

- Enable password protection : when using a password, one must enter it when starting up the client interface
- Automatically open sole document ... : when using a USB stick, the document is automatically opened (only when one document present).



When using a password, the control via the previous V1.1 client version will not be possible therefore disable password protection. Note that using a previous client version in combination with V1.2 server is indicated with following text box :



Image 5-39
client-server soft incompatibility

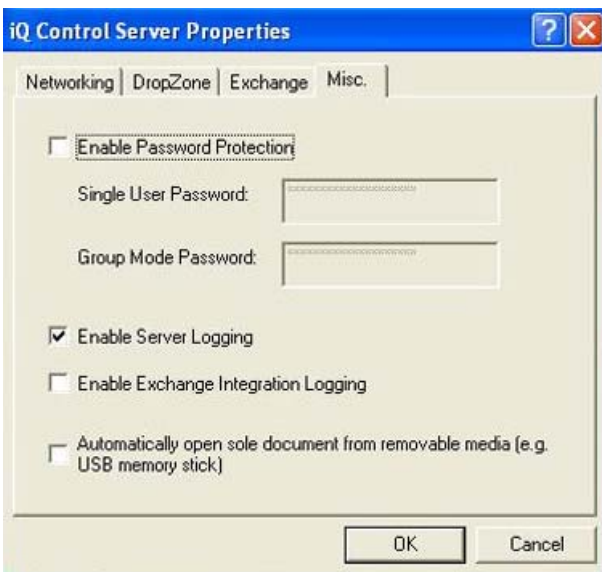

Image 5-40



To check the server version open the about menu from the tray



Image 5-41

5.13 DropZone settings

What can be done ?

The Server settings on the Projector allow to configure the DropZone in several ways:

- Disallow new meeting participants: New meeting participants will not be able to request desktop sharing or desktop control.
- Disallow Launch file: Launching a file with the DropZone will be impossible when activating this setting, hereby preventing undesired content to be projected during a meeting.
- Enable/disable desktop sharing at startup or logon.

How to setup the DropZone ?

1. Go to the server icon in the lower task bar of the server desktop and Click the right mouse button.

A menu is displayed

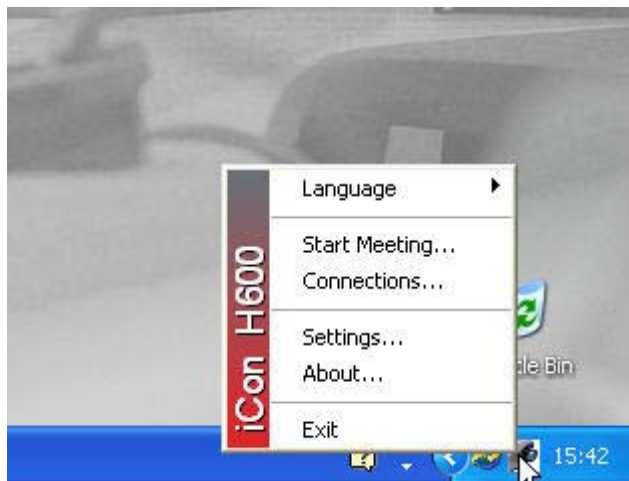

Image 5-42

2. Select *Settings*
3. Select the *DropZone* tab

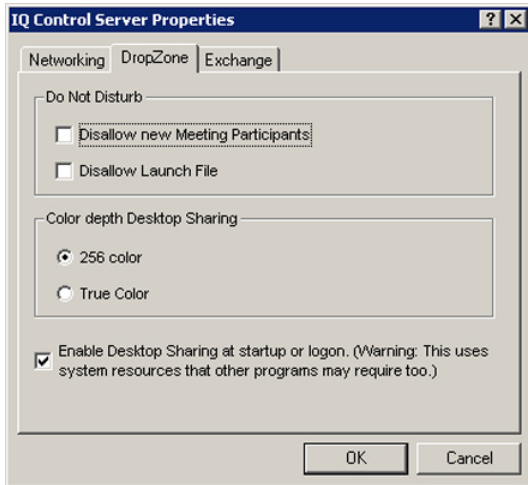

Image 5-43

4. Check the desired settings



Choosing *True color* as color depth setting will slow down the communication.



It is advised to leave the other Server properties as they are. If necessary Contact your IT administrator.

5.14 Start up

Start up

To start using the DropZone one must define the server (projector/display) to connect to. Several situations are possible.

1. The projector/display to connect to has not yet been declared in the DropZone interface, in that case the projector/display has to be added to the DropZone list using the **Add** function.
2. The projector/display to connect to has already been declared in the DropZone, one must then just selected it from the list. In case the projector/display name is not known, there is a possibility to select the projector by its location (only if the location has been specified).

How to open the installation menu ?

1. Click on the arrow to pull down the installation menu.

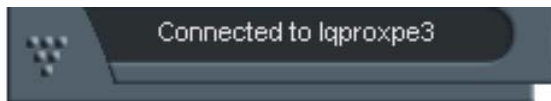

Image 5-44

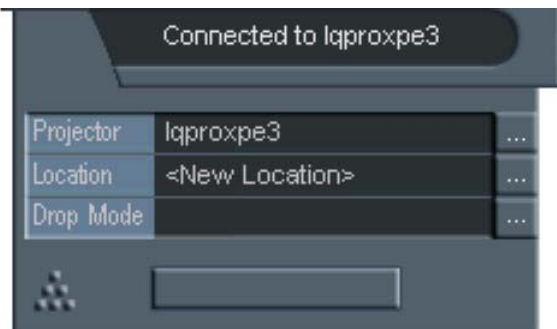

Image 5-45
installation menu

How to add a projector to the list ?

1. Click on the three suspension points to open the projector selection dialog box.

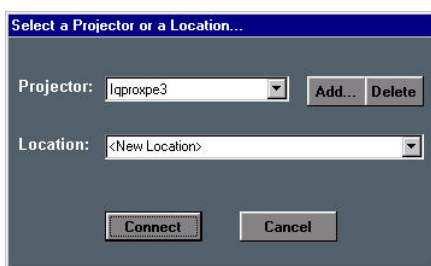

Image 5-46

2. Click on the **Add** button.

A dialogbox is displayed.

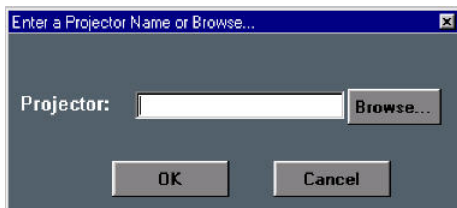

Image 5-47

3. Enter the projector name or browse the network.
4. Click on **OK**.
5. Enter the Location (optional).
6. Click on **Connect**.

Following message is displayed : "Connected to <projectorname>..."

How to select an existing projector by its name ?

1. Click on the three suspension points to open the projector selection dialog box, image 5-46
2. Open the listbox and select the projector.

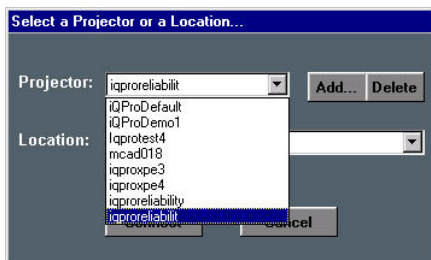

Image 5-48

the location will also be filled (if it has been entered previously).

3. Click on **Connect**.

Following message is displayed : “Connected to <projectorname>...”

How to select an existing projector by its location ?

Can be useful when the projector name is not known.

1. Click on the three suspension points to open the projector selection dialog box, image 5-46
2. Open the listbox and select the location.

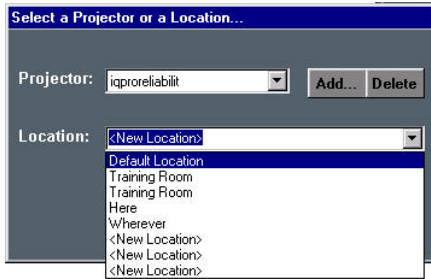

Image 5-49

The projector name is filled in.

3. Click on **Connect**.

Following message is displayed : “Connected to <projectorname>...”



This is only possible if the location has been filled, the default value for location being “<New Location>”



If the projector is not found following message will be displayed : “Host not found”

If the projector is found but unable to respond (projector disconnected from the network, server software not running, ...) following message will be displayed : “ Host found , but server inactive”

6. GETTING STARTED

Overview

- Starting up the projector
- Logon to the network
- Creating your new desktop
- Save your new desktop
- File dropping/launching
- Open remotely a file on the projector

6.1 Starting up the projector

How to start up the projector

1. Press the **Standby** button on the RCU or on the local keypad.
The iCon server source is displayed i.e. the Windows™ desktop.

6.2 Logon to the network

How to logon to the network

1. The Windows logon dialog box is displayed
Note: *the logon dialog box is only displayed in case the automatic login is not activated.*

6.3 Creating your new desktop

The Start menu

The iCon allows you to create a new desktop by placing the desired sources on top of it and this by simply using the Windows Start menu.



Image 6-1
The Startup menu in Windows

6.3.1 Adding a new window to your desktop

The desktop's source selection menu

The sources can be selected via the source selection menu in **Start \ My sources**

6. Getting started

The available inputs slots are shown in this menu whereas the status of the sources are given by the bullet colors:

- Yellow : no signal available
- Orange : signal available
- Green : signal available and selected (displayed)

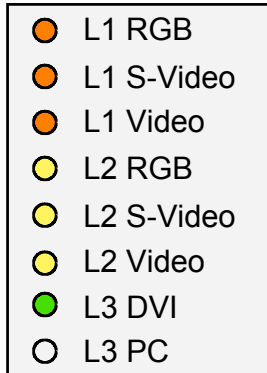

Image 6-2
Desktop source selection menu representing also the standard input configuration (L1,L2,L3 input layers installed)

How to add a window to your desktop

1. Click on the *Start* button

The start menu is opened

2. Click on *My Sources* to open the menu



Image 6-3

3. Select the source you want to add to the desktop.



Source selection from the desktop will load a standard file and use AutoImage. For permanent sources it is advised to create a custom file via the OSD menu, see *Save as...* in the Image file menu (Advanced chapter).



If you want to personalize i.e. rename the source(s) see “Renaming the sources” in the Desktop management chapter.

6.3.2 Desktop examples



Instead of using the standard windows desktop background one can use a corporate logo as background. In the following pictures a Barco logo has been used. To change the background go to *control panel/display*.



Image 6-4

Native representation of 1 data and 1 video source

A data source with XGA resolution (1024x768) can be shown aside a video source.



Image 6-5

2 data and 1 video source

One re-sized video source and 2 re-sized data sources. Note that the aspect ratio is preserved.



Image 6-6

6.3.3 Manipulating your source windows

6.3.3.1 The window menu

Overview of the window menu

The window menu allows several manipulation on the window and its image :

- Zoom : size the window at you convenience
- Native Resolution (100%) : guarantees optimum image quality by forcing the native resolution (size or amount of pixels) of the source.
- Full Screen: Fill the screen with the active window
- Freeze
- Show Window Decoration : allows to display or hide the window surrounding the source
- Variable Aspect Ratio: allow the aspect ratio of the source to be changed when sizing
- Save Current Layout : save your window layout
- Rename This Source: customize you desktop by renaming the windows
- Remove the window: set the load of your desktop by removing undesired windows
- Image Controls: customize the window image
- Image File Controls: see desktop management
- Auto Image: recalculate your image to guarantee the best reproduction



Image 6-7

Opening the window menu

1. Position the mouse cursor in the area of the active window and click the right mouse button

6.3.3.2 Window setup

Position the active window

1. Position the active window by using the mouse i.e. by simply clicking in the window decoration area and sliding the window to the desired position

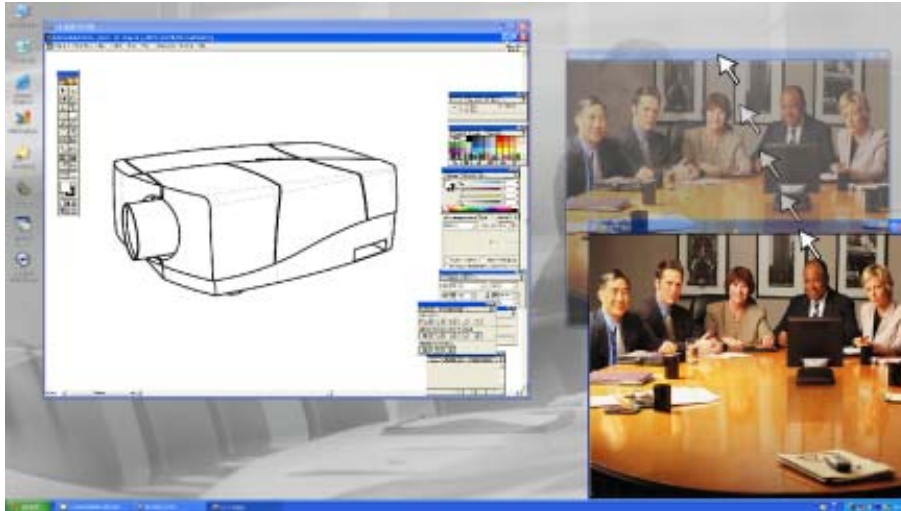

Image 6-8
positioning a video window

Zoom the window

1. Click on the *Zoom* function in the window menu.
The menu is opened.
2. Choose a Zoom factor to determine the size of the window.



The **100% Zoom** corresponds with the native resolution representation of the source, this will guarantee the best image quality.



Free Window sizing is also possible by using the mouse (sliding and release).

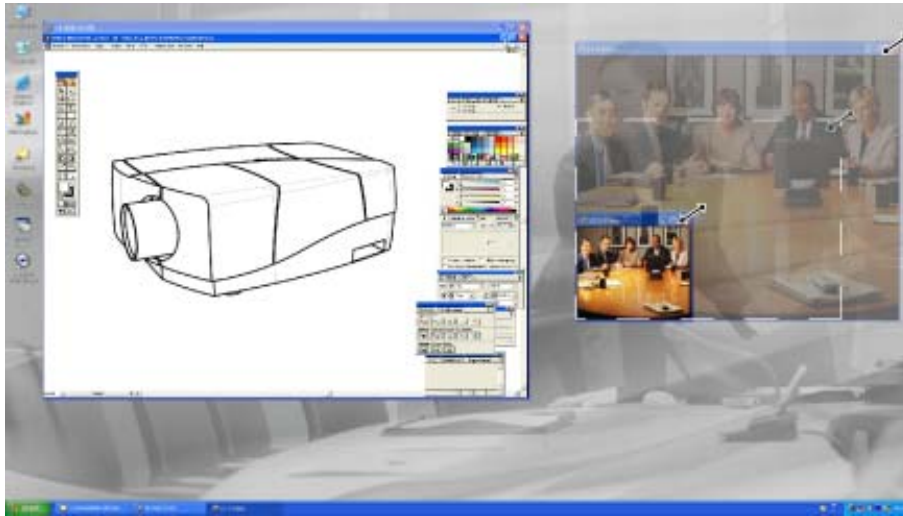

Image 6-9
free sizing a video window

Forcing the native resolution (100%)

1. Click on the *Native resolution* function in the window menu to force the window size to the native resolution of the source, this will guarantee the best image quality.

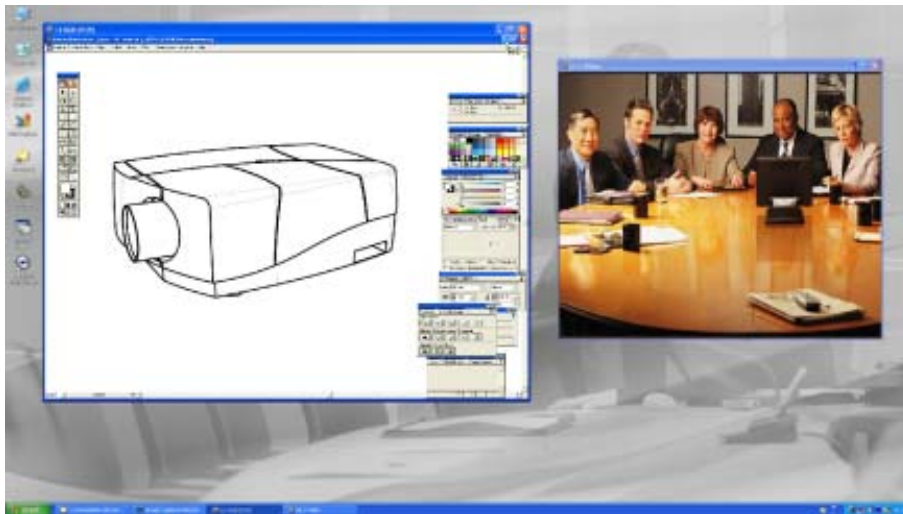

Image 6-10
Data (RGB) and Video (S-Video) displayed at native resolution

Forcing a full screen representation

1. Click on the *Full screen* function in the window menu you can fill the whole screen with the active window (source).



Image 6-11
Video source in Full screen representation



Use the Full screen representation to display a HDTV source.



The aspect ratio of the source is not preserved !

When the aspect ratio of the active window image is not the same as the projector (in this case 1920/1080 or 1.77: 1). The image and its objects will end to be distorted (stretched or shrunk).

Variable aspect ratio

1. Variable aspect ratio will allow you to change the aspect ratio of the source when re-sizing the window. This function must be deactivated if you don't want the image to be distorted (stretched out).

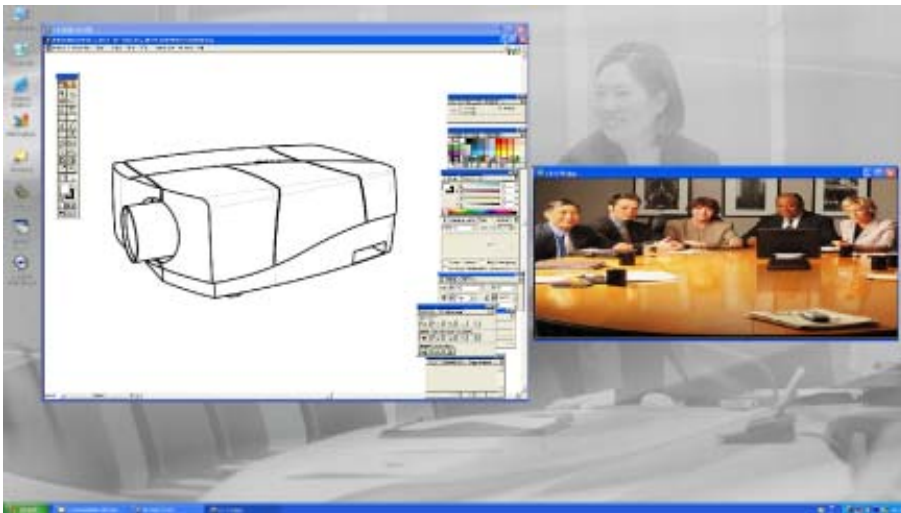

Image 6-12
Re-sizing of a video window with unlocked aspect ratio

Renaming the source (window)

1. Use the *Rename This Source* function in the window menu to rename the active source.

6. Getting started

A dialog box is displayed.



Image 6-13
Source rename dialog box

2. Fill in the new source name.
3. Set the source to be visible in the desktop's *Start/My Sources* menu by checking the checkbox *visible*.

6.3.3.3 Image controls



The image settings on window level affect only the selected window. A general setting can be done in the control panel or via the *All Programs\Projector menu*

Using the Image controls

1. Select *Image controls* in the window menu.

A dialog box is displayed

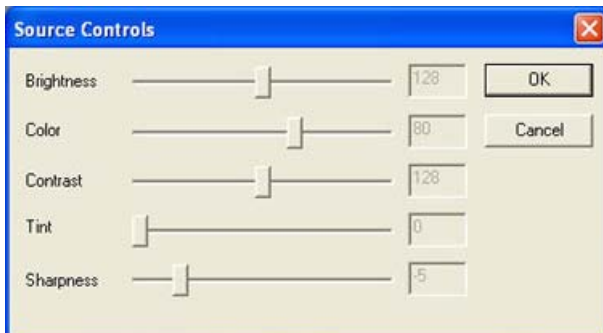

Image 6-14
Image controls dialog box

2. Adjust the desired image setting (Contrast, Brightness, ...) using the scroll bars

6.3.3.4 Image file controls

Image file controls

1. Select *Image file controls* in the window menu.

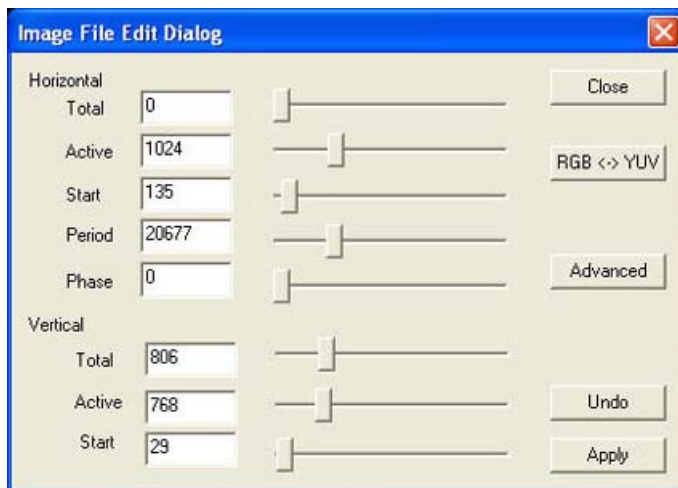

Image 6-15
Image file controls

- Adapt the desired parameter by positioning the cursor on the scroll bar and using the arrows on the keyboard to increase or decrease the value.



Image 6-16
image file controls: cursor on scroll bar

When to adjust the horizontal start pixels parameter ?

Adjust the horizontal start pixels when the window is not filled horizontally (left/right black bars)

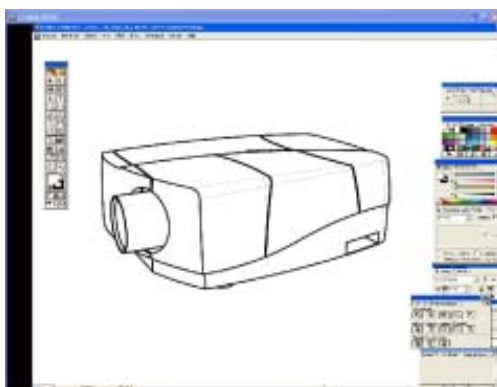

Image 6-17
Start pixels: wrong setting

Color space setting (RGB > YUV)

Change the color space setting whenever the colors are totally wrong

2 different color spaces can be selected

6. Getting started

- RGB
- YUV



In the OSD one can choose between 5 different color spaces.

6.4 Save your new desktop

Preserving your desktop settings

A desktop can always be saved and you can recall it at any time. Different parameters determining the positions and “looks” of your window are saved.

How to save your layout

1. Open the window menu with the right mouse button.
2. Click on *Save current layout*.

A dialog box is displayed

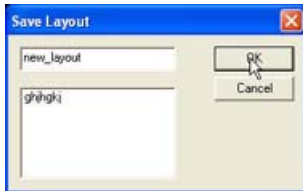

Image 6-18

3. Enter the name in the upper field and confirm with *OK*

The layout is saved and the *My Layouts* menu is updated with the new layout.

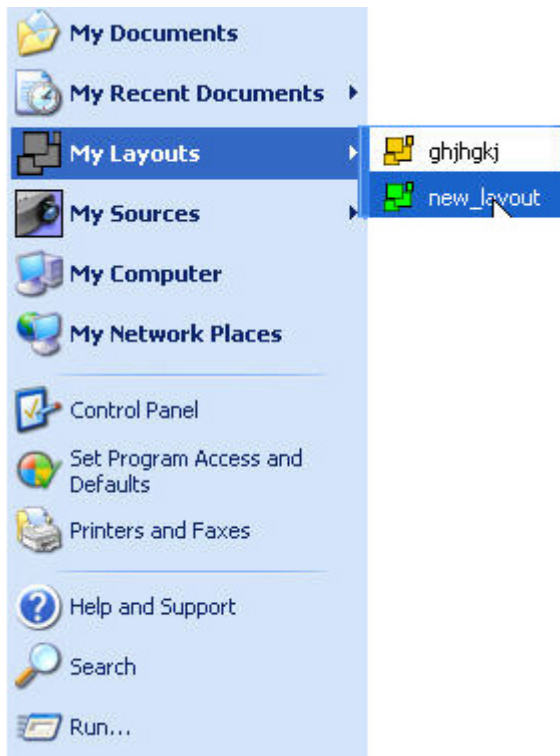

Image 6-19

6.5 File dropping/launching



Only the Microsoft viewers (PPT, Word, Excel,...) are installed on the projector.

File dropping

Dropping a file means sending it to the projector using the DropZone interface.

The projector can then react in different ways depending on the drop mode selected :

- launch file
- launch file and share
- store file on the projector

File launching

Launch files: a file stored on the projector (server) or on the network can be accessed from a local PC (via the network) or from the projector itself. Launching a file means "sending and starting up" a file (using the required software).

A PowerPoint file can be launched on your PC and projected in another place (by default only the PPT viewer is installed on the projector).



for iQ only : The file will only be projected if the "iQ PC" is selected in the source selection.

How to set the drop mode ?

1. Open the DropZone interface.
2. Click on the arrow to pull down the installation menu.
3. Click on the three suspension points access the drop mode dialog box, image 5-45

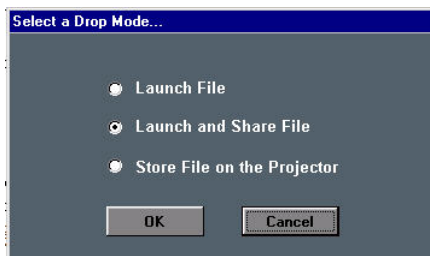

Image 6-20

4. Click on one of the three modes.

How to drop a file using the drag method ?

1. Drag the file into the drop window.



Image 6-21

6. Getting started

The window opens and shows now the projector.



Image 6-22

2. release the mouse button.
The projector will then process the file according to the setting of the drop mode.

How to drop a file using the Open dialog box ?



1. Click on the upper button.
A browser is displayed. Choose a file to send to the projector.
The projector will then process the file according to the setting of the drop mode.

What to do with the launched files once disconnected ?

The previously dropped files are placed in a local directly on the server, one may choose to delete them or not.

1. Click on the arrow to pull down the installation menu.
2. Click on the *Options* button.

A dialog box is displayed.

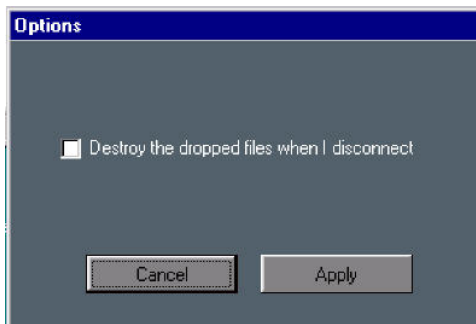

Image 6-23

3. Check the box to destroy the launched files once disconnected.

6.6 Open remotely a file on the projector

How to open a file on the projector ?



1. Click on the lower button of the DropZone interface
A browser is displayed. Select the file to be projected.



for iQ only: The file will only be projected if the "iQ PC" is selected in the source selection.

7. DESKTOP MANAGEMENT

Overview

- The Projector menu
- Opening the Projector controls menu
- Desktop Integration Configuration

7.1 The Projector menu

Overview

- Desktop setting using the Projector menu
- Opening the Projector menu

7.1.1 Desktop setting using the Projector menu

The projector menu

The projector menu can be found under the *Start/All programs*

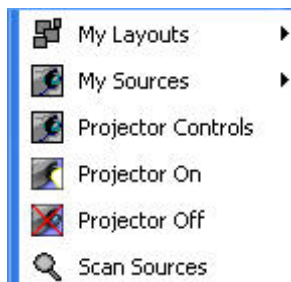

Image 7-1

- My layouts: gives an overview of the existing layouts, this is the same menu as the *My Layouts* menu in the Start menu
- My Sources: gives an overview of the sources (active and inactive), this is the same menu as the *My Sources* menu in the Start menu
- Projector Controls: this menu allows several settings image settings, preferences, ...
Note that this menu can also be started via the control panel.
- Projector On
- Projector Off: allows to switch the projector off
- Scan Sources: scans the sources in order to update the current source selection menu.



We will further only discuss the Projector controls menu, the other menus being explained in the Getting started section.

7.1.2 Opening the Projector menu

How to open the projector menu ?

1. Click to open the *Start* menu
2. Click to open the *All Programs* menu
3. Select the *Projector* menu

7. Desktop Management

The Projector menu is opened



Image 7-2

7.2 Opening the Projector controls menu

How to open the projector controls menu ?

1. Click on the *projector controls* in the Projector menu



Image 7-3

The menu is displayed

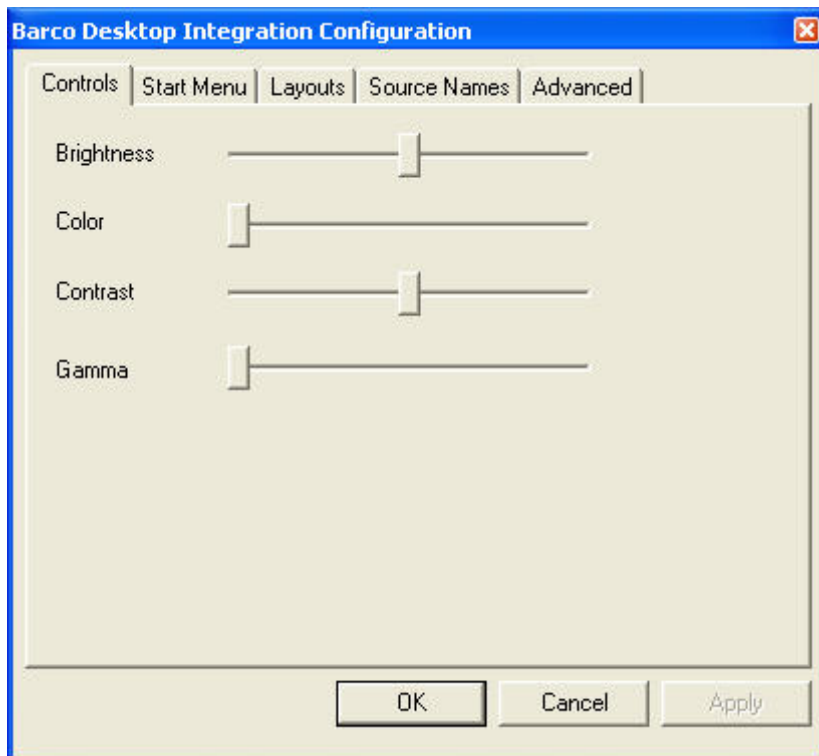

Image 7-4
The projector control menu

How to open the projector controls menu from the Windows™ control panel ?

1. Click on Control panel in the Start menu
2. Click on iQPro Desktop

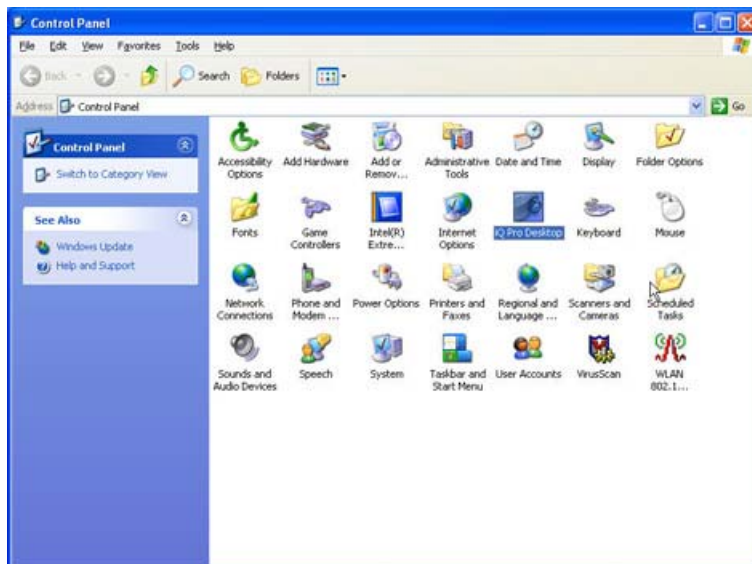

Image 7-5

7. Desktop Management

The projector controls menu is displayed

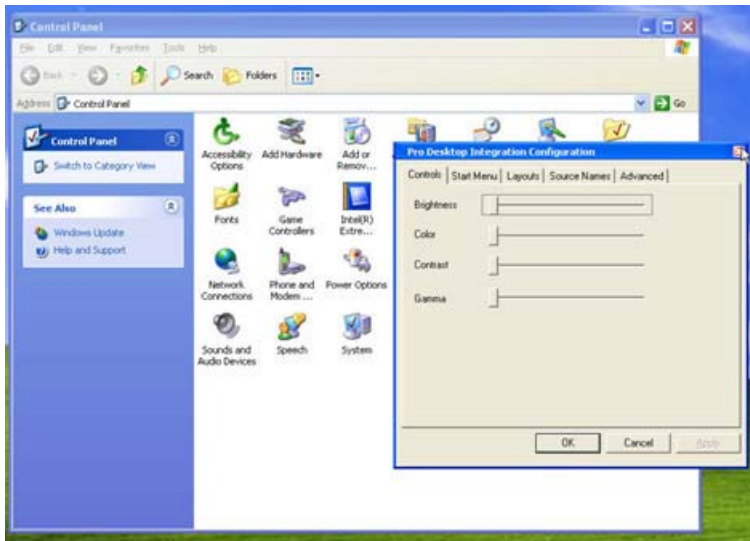

Image 7-6

7.3 Desktop Integration Configuration

Managing the sources through the projector controls menu

The Source names menu in the projector controls gives an overview of all the sources, their aliases as well as whether they are all visible or not in the *Start/My sources* menu. These attributes can be changed.



Renaming a source is changing (creating) the alias, the "input" name remains unchanged.

Renaming a source(s) using the projector controls menu

1. Click on the *Source names* tab of the projector controls menu

The source names menu is displayed

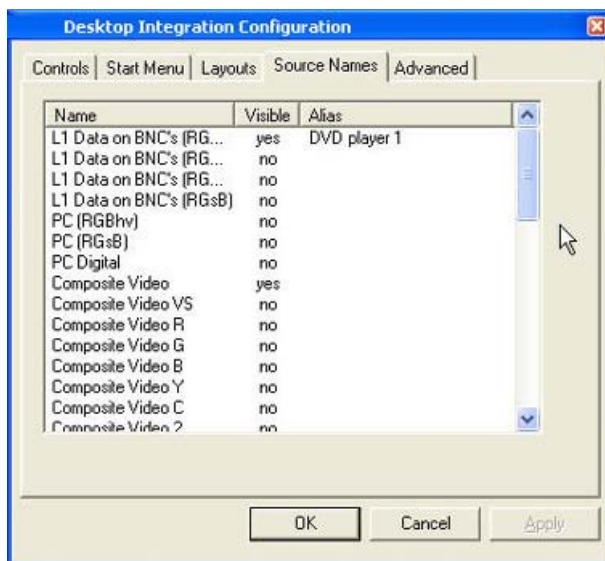

Image 7-7

2. Double click on the desired source

A dialog box is displayed

Start menu configuration

1. Click on the *Start menu* tab of the projector controls menu

The menu is displayed

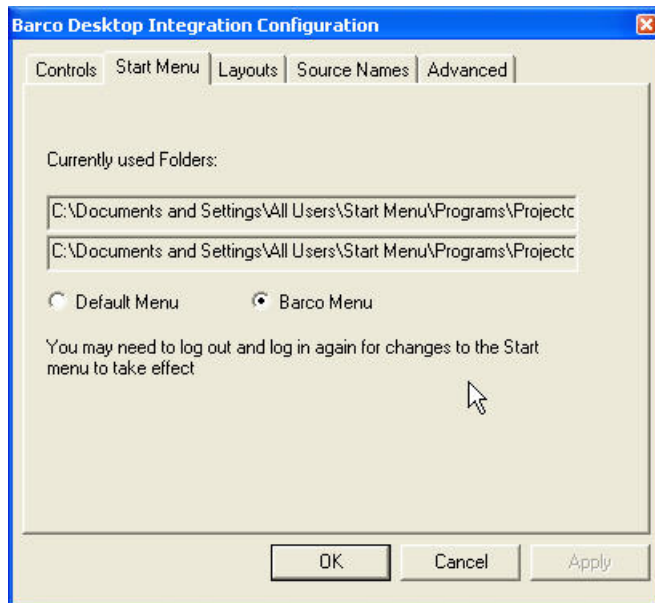

Image 7-8

2. Choose between the standard Windows™ start menu (**My Pictures/My Music**) or the Barco start menu (**My Sources/My Layouts**)
3. It may be necessary to restart the server for the changes to take effect

Advanced settings

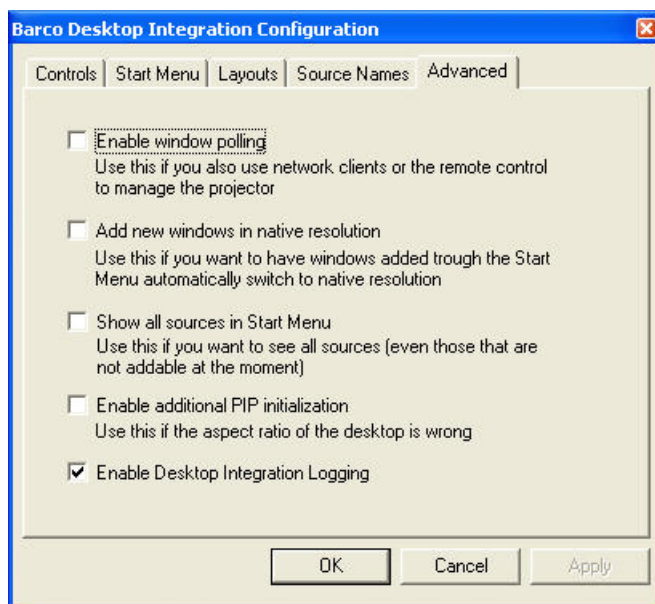

Image 7-9

- **Enable window polling** : This allows to synchronize the window environment with the actual projector PiP interface. Note that this is not recommended when working exclusively in the desktop environment. Always enable window polling when working in multiple environments, for example when using the RS232 communication.
- **Add new windows in native resolution** : This setting allows to choose whether the source is added in native resolution or not.
- **Show all sources in Start menu**: Choose if all sources or only addable (present) sources are shown in the *My sources* menu.



When the window polling is not enabled and when controlling the projector with RS232 the desktop will not correspond to the actual configuration i.e. a selected source will not be displayed (will be placed behind the desktop and will thus be invisible)

8. ADVANCED

Overview

- Using the Dialog boxes
- Source selection
- General
- Image
- Lamp management
- Image files
- Display setup

8.1 Using the Dialog boxes

How to use the dialog boxes ?

Some parameters are modified by means of a dialog box, where selections can be made and/or values can be entered.

The values can be entered in several ways:

Entering numeric values using the numeric keys on the remote control

1. Press **ENTER** to activate the input field.

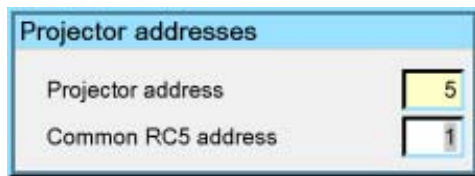

Image 8-1

2. Key in the desired value.

Entering numeric values using the arrow keys on the remote control

1. Press **ENTER** to activate the input field.
2. Press ← or → to select the digit to be changed.

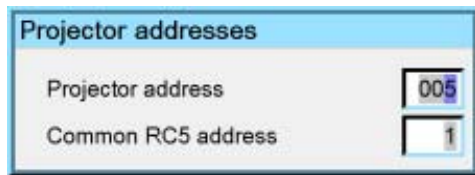

Image 8-2

3. Press ↓ or ↑ to increase or decrease the value.

Entering numeric values using the arrow keys on the local keypad

1. Press **ENTER** to activate the input field.
2. Press ← or → to select the digit to be changed.
3. Press ↓ or ↑ to increase or decrease the value.



To confirm the changes always press ENTER.

Use ↓ or ↑ to browse between the different fields.



In some cases an alphanumeric value (file name, ...) has to be entered. Use ↑ or ↓ to scroll through the character values once the input field is activated.

Following characters can be browsed in this particular order:

Decimal scroll list: 0123456789

Signed decimal scroll list: 0123456789-

ASCII scroll list: ABCDEFGHIJKLMNOPQRSTUVWXYZ0123456789+*/&@#.;:abcdefghijklmnopqrstuvwxy

8.2 Source selection

Overview

- Source selection
- Composite video
- S-Video
- RGB-YUV
- PC
- DVI

8.2.1 Source selection

Selecting a source

The Source selection menu allows to select one of the different inputs. Another method to select an input source is via the remote control using the numeric keys or by using the local keypad.

Selecting a source from the Icon's menubar (OSD) will always display that source in a **full screen** mode.

The source names in the menubar are adapted automatically depending on the type signals connected to the projector (the signals are scanned). For example :

- L1 RGB
- L2 DVI
- ...

In this case, an RGB signal is connected to the first layer (L1), a DVI signal is connected to the second layer (L2) ,...



When selecting a source with a different resolution (and/or aspect ratio) than the projector's resolution (and/or aspect ratio), the source can be shown in its native resolution or can be re-scaled to the projector's resolution, the latter case brings of course some lost of quality.

For more info on resolution match see the Show native resolution function in the *Image* menu.



The resolution of the projector is 1920x1080 with an aspect ratio of 16:9

8.2.2 Composite video

When

Select composite video when you are in presence of a PAL or NTSC video signal.

A composite video signal is often available on a yellow cinch connector of a Camera, VCR or DVD player.

How to select the composite video input ?

1. Press **MENU** to activate the Toolbar
2. Press ↓ to Pull down the Source Selection menu

The menu will contain one item *Lx Video*, x being the layer on which the composite video is connected (for example L2 Video if the signal is connected to layer 2)

3. Use ↑ or ↓ to select *Lx Video*



Image 8-3

4. Press **ENTER** to confirm your choice

A bullet indicates the selected composite video source which now appears on the screen.

Adjustments on a Composite video signal

The projectors allows different adjustments on a composite video signal. Depending on the type of signal (NTSC /PAL) the terminology may differ :

- Contrast
- Brightness
- Color : adjusts the level of color saturation in a PAL signal
- Tint : adjusts the level of color saturation in an NTSC signal
- AGC: Automatic Gain Control

8.2.3 S-Video

When

Select the S-Video input when in presence of a video signal also called S-VHS signal.

An S-Video signal is available on the Mini-Din connector of a camera, VCR or DVD player.

Adjustments on a S-Video signal

The projectors allows different adjustment on a video signal. Depending on the type of signal (NTSC /PAL) the terms differ :

- Color : adjusts the level of color saturation in a PAL signal
- Tint : adjusts the level of color saturation in an NTSC signal

How to select the S-Video input ?

1. Press **MENU** to activate the Toolbar
2. Press **↓** to Pull down the Source Selection menu

The menu will contain one item *Lx S-Video*, x being the layer on which the composite video is connected (for example L3 S-Video if the signal is connected to layer 3)

3. Use **↑** or **↓** to select *Lx S-Video*

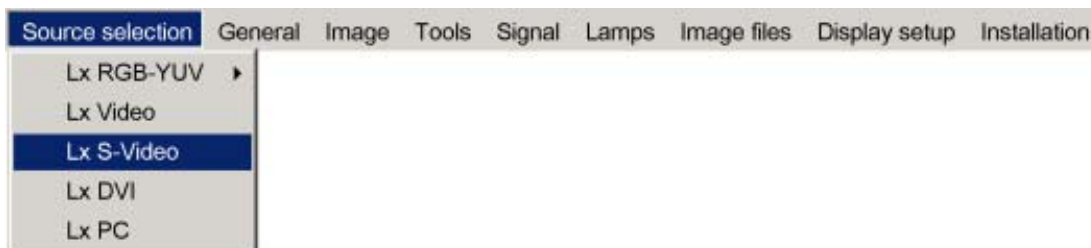

Image 8-4

4. Press **ENTER** to confirm your choice

A bullet indicates the selected composite video source which now appears on the screen.

8.2.4 RGB-YUV

When

Select RGB-YUV when in presence of a data signal of the type RGB+ sync connected to the RGB input (5 BNC's) or a component signal of the type (R-Y)/Y/(B-Y).

These signals are often available on a VGA D15 connector of a PC or another image generator.



An RGB data signal can have its sync signal added in different ways, refer to the Installation section for more information on the RGB+sync signals accepted by the RGB input.

How to select the RGB input ?

1. Press **MENU** to activate the Toolbar
2. Press **↓** to Pull down the Source Selection menu

The menu will contain one menu *Lx RGB-YUV*, **x** being the layer on which the RGB signal is connected (for example L1 RGB-YUV if the signal is connected to layer 1)

3. Use **↑** or **↓** to select *Lx RGB-YUV*
4. Use **→** to open the menu
5. Use **↑** or **↓** to select *RGB* or *YUV*



Image 8-5

6. Press **ENTER** to confirm your choice

A bullet indicates the selected source which now appears on the screen.

Adjustments on an RGB signal

The projector allows different adjustments on an RGB signal :

- Contrast
- Brightness
- Phase
- Input balance
- AutoImage : or manual edit of the image file settings

8.2.5 PC

When

Select PC when you are in presence of a data signal of the RGB + sync form connected to the D15 input connector of the projector.



An RGB data signal can have its sync signal added in different ways, refer to the Installation section for more information on the RGB+sync signals accepted by the PC input.

How to select the PC input ?

1. Press **MENU** to activate the Toolbar
2. Press **↓** to Pull down the Source Selection menu

The menu will contain one item *Lx PC*, **x** being the layer on which the PC signal is connected (for example L4 PC if the signal is connected to layer 4)

3. Use **↑** or **↓** to select *Lx PC*



Image 8-6

4. Press **ENTER** to confirm your choice

A bullet indicates the selected composite video source which now appears on the screen.

8.2.6 DVI

When

Select DVI when in presence of digital data signal connected to the DVI input of the projector. These signals are often available on a PC or other image generator.

How to select the DVI input ?

1. Press **MENU** to activate the Tool bar
2. Press **↓** to Pull down the Source Selection menu

The menu will contain one item *Lx DVI, x* being the layer on which the RGB signal is connected (for example L4 DVI if the signal is connected to layer 4)

3. Use **↑** or **↓** to select *Lx DVI*



Image 8-7

4. Press **ENTER** to confirm your choice

A bullet indicates the selected composite video source which now appears on the screen.

Adjustments on a DVI signal

The digital nature of this signal eliminates the need of a large number of adjustments

8.3 General

8.3.1 Pause

Pause

The Pause function allows to stop the image display, the projector remaining with full power for immediate restart. The image display is interrupted and the projected background is black.

How to pause the image display?

1. Press **MENU** to activate the Tool bar
2. Press **→** to select *General*
3. Press **↓** to Pull down the General menu
4. Use **↑** or **↓** to select *Pause*

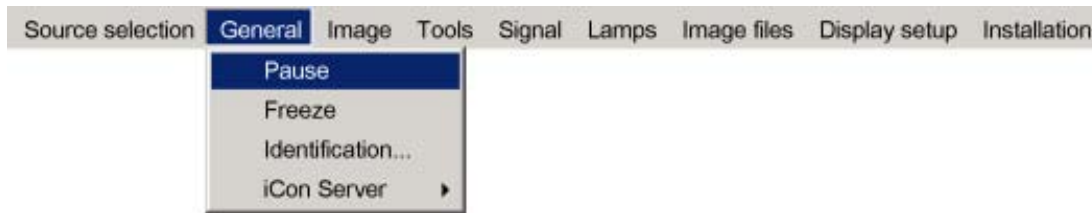

Image 8-8

5. Press **ENTER**



The projection can also be interrupted using the **PAUSE** key on the RCU. To restart the image projection press **PAUSE**

8.3.2 Freeze

Freezing the image

With the Freeze function, the image can be frozen. To restart the image, reuse the Freeze function or press the **FREEZE** button on the remote.

How to freeze the image ?

1. Press **MENU** to activate the Tool bar
2. Press → to select *General*
3. Press ↓ to Pull down the General menu
4. Use ↑ or ↓ to select *Freeze*

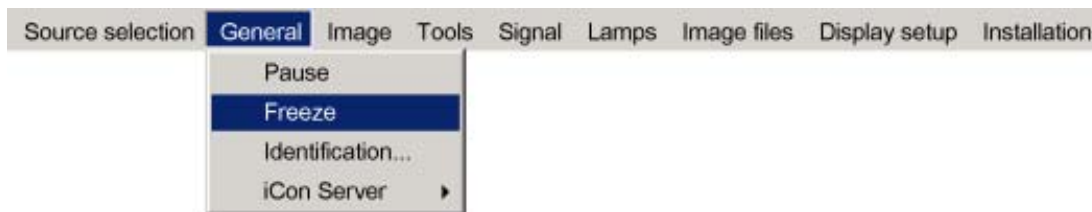

Image 8-9

5. Press **ENTER** to activate the Freeze function



The image can also be frozen using the **FREEZE** key on the RCU

8.3.3 Identification

The projector's identification screen

The identification screen displays the projector's main characteristics

How to display the identification screen ?

1. Press **MENU** to activate the Tool bar
2. Press → to select *General*
3. Press ↓ to Pull down the General menu
4. Use ↑ or ↓ to select *Identification*

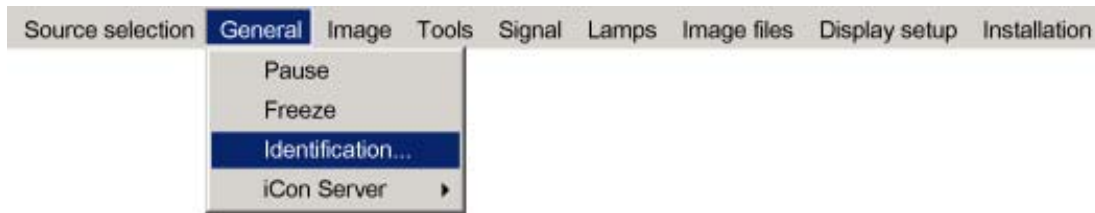

Image 8-10

5. Press **ENTER**

On the screen appears a text box.

In this case the projector is an iCon H600

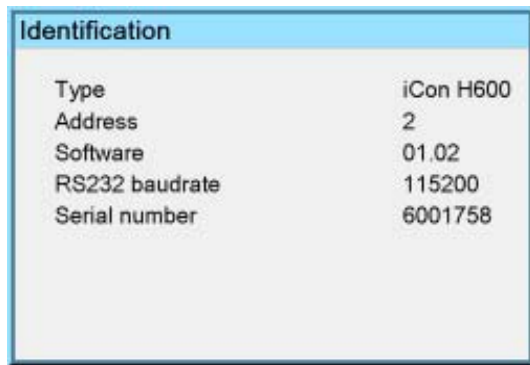

Image 8-11

6. Press **MENU** or **BACK** to exit or to go back to the previous menu

8.4 Image

Overview

- Image settings
- Aspect ratio
- Color temperature
- Filmmode detection (video only)
- Input balance
- Automatic gain control (AGC)
- Manual gain control

What can be done ?

Correct image settings are important for a good image reproduction. The image settings are made through a dialog box with a scroll bar. Minimal, maximal and actual values are indicated. These settings can also be done directly via the RCU's dedicated buttons, except for the sharpness.

All the image settings like can be done in the *Image/Settings* menu.

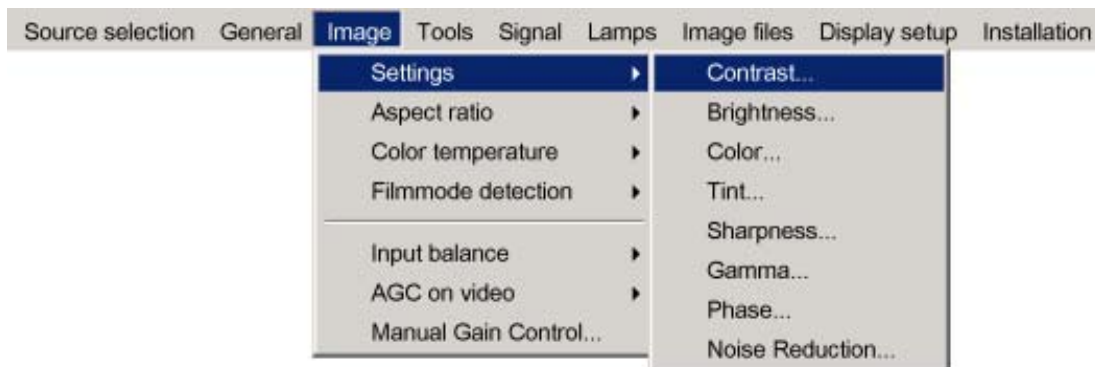

Image 8-12

8.4.1 Image settings

8.4.1.1 Setting the Contrast

Contrast adjustments

Adjust the contrast to “brighten” the white parts of the image.



It is recommended to adjust the brightness before adjusting the contrast.

How to change the Contrast

1. Press **MENU** to activate the Tool bar
2. Press **→** to select the *Image* item
3. Press **↓** to Pull down the *Image* menu
4. Use **↑** or **↓** to select *settings*
5. Press **→** to pull down the menu
6. Use **↑** or **↓** to select *Contrast*
7. Press **ENTER**

On the screen appears now a slider box

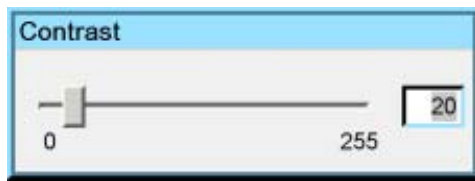

Image 8-13

8. Use **←** or **→**, the numeric keys on the remote, or the keypad to change the contrast

8.4.1.2 Setting the Brightness

Brightness adjustment

Adjusting the brightness will affect the dark areas of the image. Increase the brightness to “lighten” up the parts that are too dark.

How to change the Brightness

1. Press **MENU** to activate the Tool bar
2. Press **→** to select the *Image* item
3. Press **↓** to Pull down the *Image* menu
4. Use **↑** or **↓** to select *settings*
5. Press **→** to pull down the menu
6. Use **↑** or **↓** to select *Brightness*
7. Press **ENTER**

On the screen appears now a slider box



Image 8-14

8. Use **←** or **→**, the numeric keys on the remote, or the keypad to change the brightness

8.4.1.3 Color

Color adjustment

Adjust the Color to obtain more or less saturated colors.

How to change the Color

1. Press **MENU** to activate the Tool bar
2. Press → to select the *Image* item
3. Press ↓ to Pull down the *Image* menu
4. Use ↑ or ↓ to select *settings*
5. Press → to pull down the menu
6. Use ↑ or ↓ to select *Color*
7. Press **ENTER**

On the screen appears now a slider box

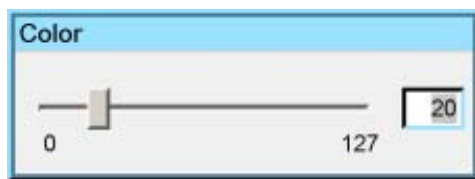

Image 8-15

8. Use ← or → , the numeric keys on the remote, or the keypad to change the color

8.4.1.4 Tint (NTSC video signals only)

Tint adjustment

Tint adjustment is only applicable for NTSC video signals. The tint adjustment allows the reddish and greenish tones to be corrected.

How to change the Tint

1. Press **MENU** to activate the Tool bar
2. Press → to select the *Image* item
3. Press ↓ to Pull down the *Image* menu
4. Use ↑ or ↓ to select *settings*
5. Press → to pull down the menu
6. Use ↑ or ↓ to select *Tint*
7. Press **ENTER**

On the screen appears now a slider box



Image 8-16

8. Use ← or → , the numeric keys on the remote, or the keypad to change the Tint

8.4.1.5 Sharpness

How to adjust the Sharpness

1. Press **MENU** to activate the Tool bar
2. Press → to select the *Image* item
3. Press ↓ to Pull down the *Image* menu
4. Use ↑ or ↓ to select *settings*

5. Press → to pull down the menu
6. Use ↑ or ↓ to select *Sharpness*
7. Press **ENTER**

On the screen appears now a slider box



Image 8-17

8. Use ← or → , the numeric keys on the remote, or the keypad to change the Sharpness

8.4.1.6 Gamma

Gamma adjustment

The gamma parameter determines the way your encoded (luminance) signal is transformed into brightness at the output of the projector. A correct gamma setting will allow the use of a maximum of gradations (brightness levels) in the projected image.

How to adjust the Gamma

1. Press **MENU** to activate the Tool bar
2. Press → to select the *Image* item
3. Press ↓ to Pull down the *Image* menu
4. Use ↑ or ↓ to select *settings*
5. Press → to pull down the menu
6. Use ↑ or ↓ to select *Gamma*
7. Press **ENTER**

On the screen appears now a slider box



Image 8-18

8. Use ← or → , the numeric keys on the remote, or the keypad to change the Gamma

8.4.1.7 Phase (RGB signals only)

Phase adjustment

A bad phase adjustment will result in bad transitions and sometimes noise. (for example text will not be clear).

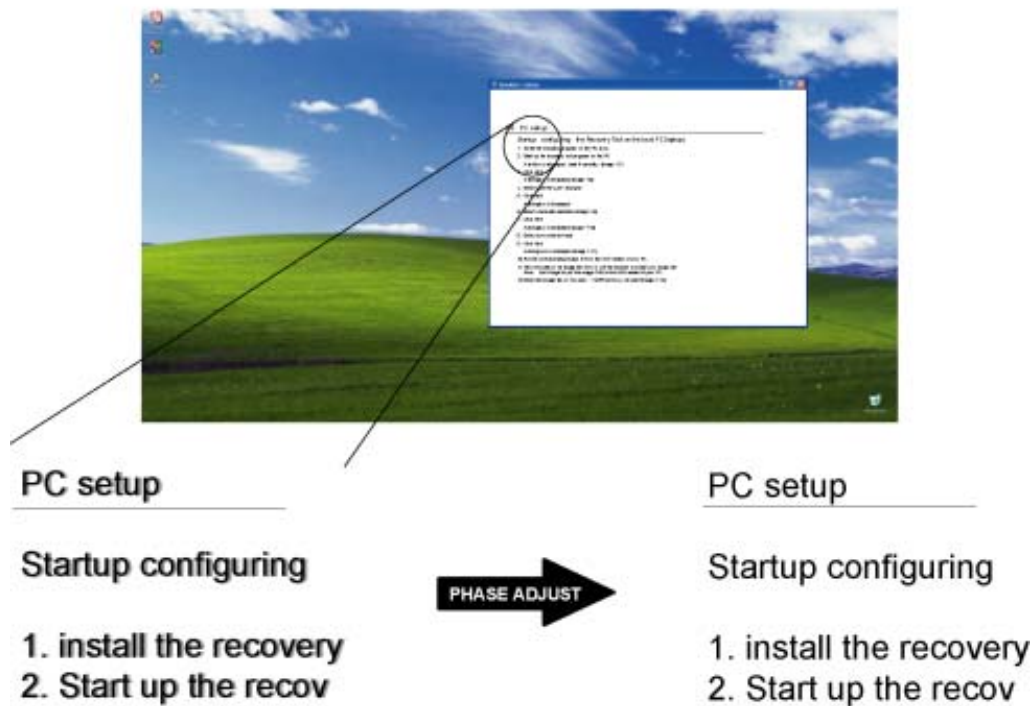

Image 8-19

How to adjust the Phase

1. Press **MENU** to activate the Tool bar
2. Press **→** to select the *Image* item
3. Press **↓** to Pull down the *Image* menu
4. Use **↑** or **↓** to select *settings*
5. Press **→** to pull down the menu
6. Use **↑** or **↓** to select *Phase*
7. Press **ENTER**

On the screen appears now a slider box

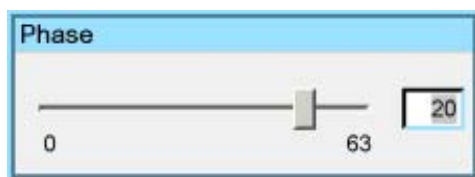

Image 8-20

8. Use **←** or **→**, the numeric keys on the remote, or the keypad to change the Phase

8.4.1.8 Noise Reduction (only for video signals)

How to remove noise in the image

1. Press **MENU** to activate the Tool bar
2. Press **→** to select the *Image* item
3. Press **↓** to Pull down the *Image* menu
4. Use **↑** or **↓** to select *settings*
5. Press **→** to pull down the menu
6. Use **↑** or **↓** to select *Noise Reduction*
7. Press **ENTER**

On the screen appears now a slider box

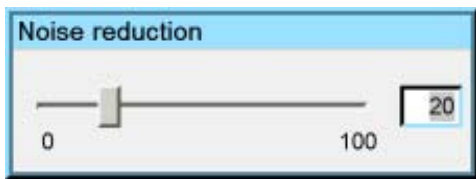

Image 8-21

8. Use ← or →, the numeric keys on the remote, or the keypad to change the Noise Reduction

8.4.2 Aspect ratio

Aspect ratios

The standard aspect ratio used in broadcast television is the 4:3 ratio. However, most of the DVD sources use nowadays the widescreen 16:9 or even the Cinemascope™ 2.35:1 aspect ratio.

Some DVD sources may even use the anamorphic 16:9 or anamorphic 2.35:1 to take advantage of the higher vertical resolution offered by the 4:3 ratio. The "anamorphic" term means that the original wide screen image is squeezed in order to fit the 4:3 aspect ratio.

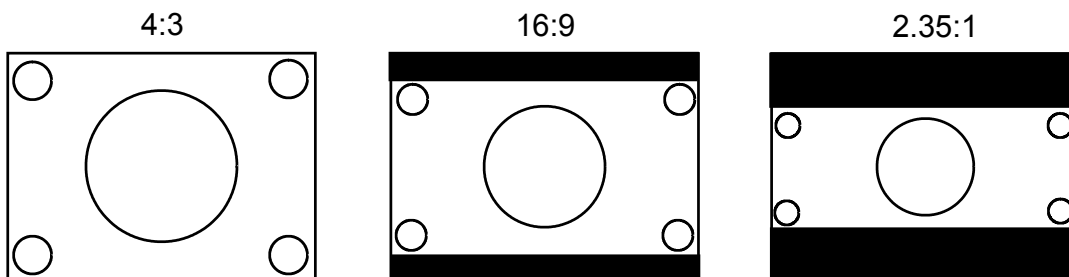

Image 8-22

Common non- anamorphic aspect ratios in DVD sources

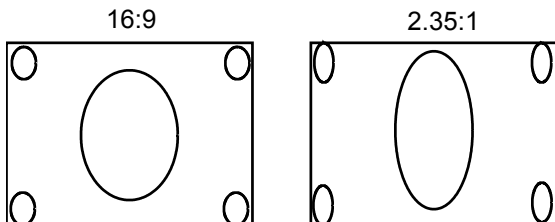

Image 8-23

Anamorphic aspect ratios in DVD sources

What can be done ?

The aspect ratio setting forces the projector to project an image using a defined aspect ratio :

- 4:3
- 16:9
- 5:4
- Auto



The settings do not refer to the aspect ratio of the source !

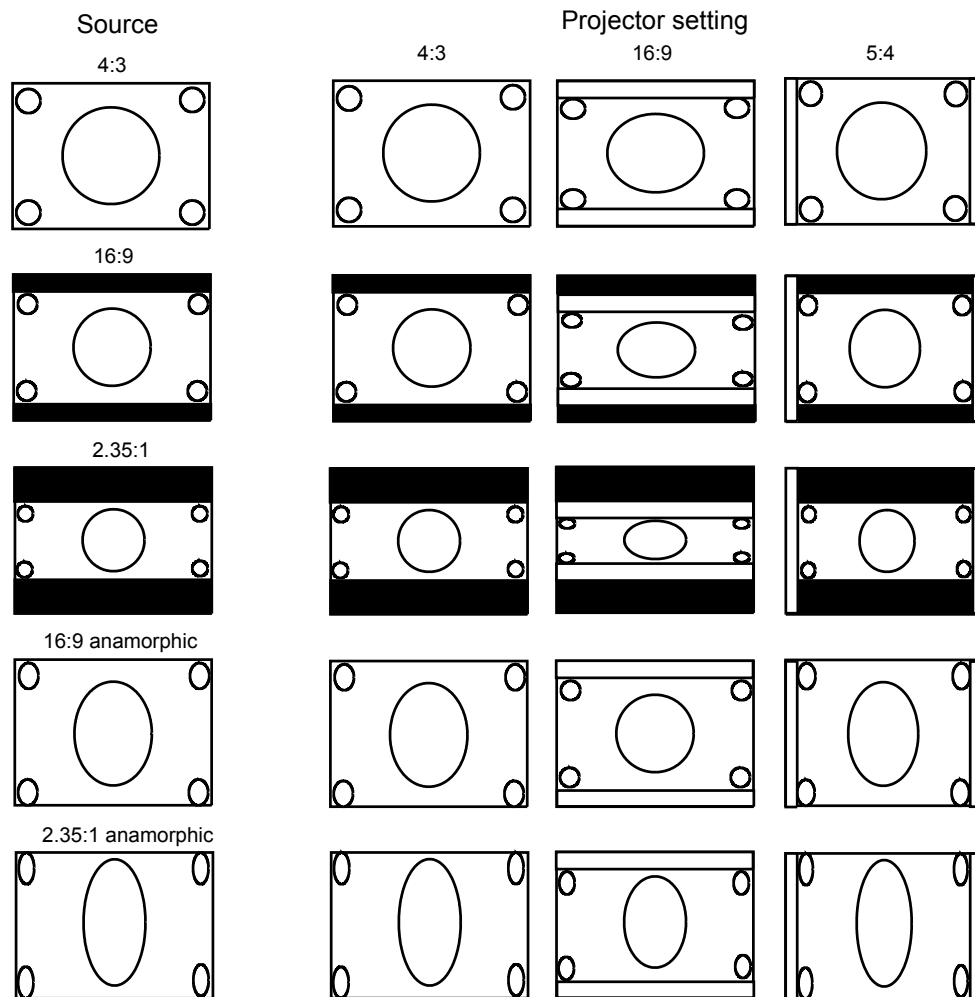

Image 8-24
Possible aspect ratio settings and their effect on different sources

We can conclude that the thumb rule for DVD projection is to always leave the projector in 4:3 format except when dealing with anamorphic sources where the 16:9 setting allows the best reproduction.

The Auto function calculates an aspect ratio based on the information stored in the image files.



Selecting Auto in case of a Video source may shrink the image horizontally



The aspect ratio setting affects only the active source window, the desktop being locked on the native aspect ratio.

How to change the Aspect ratio ?

1. Press **MENU** to activate the Toolbar
2. Press **→** to select *Image*
3. Press **↓** to Pull down the *Image* menu

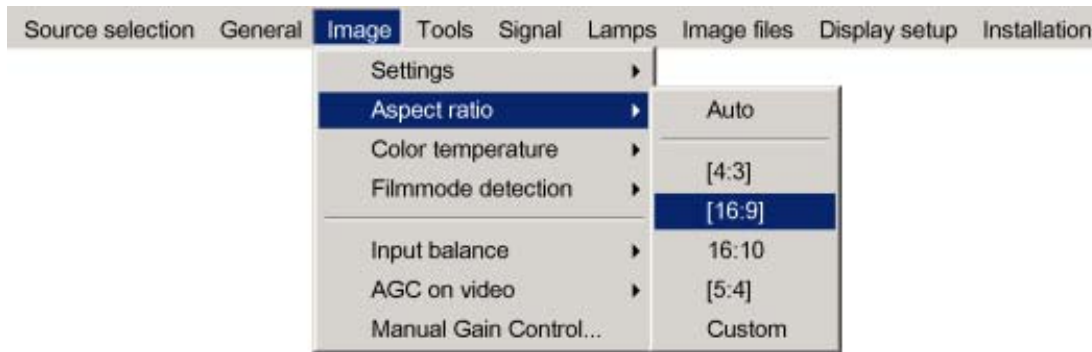

Image 8-25

4. Use ↑ or ↓ to select *Aspect ratio*
5. Use → open the *Aspect ratio* menu
6. Use ↑ or ↓ to select the desired ratio
7. Press **ENTER** to confirm



The aspect ratio settings are greyed out in case the *Show native resolution* or the *Full screen representation* setting is enabled.

How to set a custom Aspect ratio ?

1. Press **MENU** to activate the Toolbar
2. Press → to select *Image*
3. Press ↓ to Pull down the *Image* menu

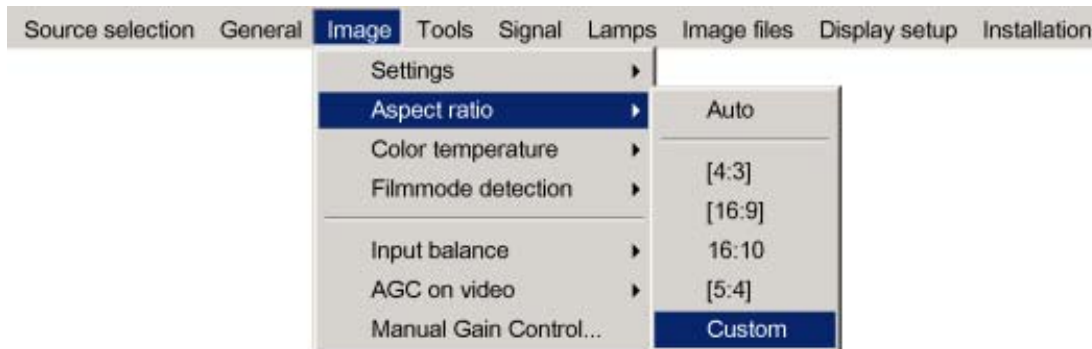

Image 8-26

4. Use ↑ or ↓ to select *Aspect ratio*
5. Use → open the *Aspect ratio* menu
6. Use ↑ or ↓ to select *Custom*
7. Press **ENTER** to confirm

A dialog box is displayed



Image 8-27

8. Enter the values for width and height of the image
The image aspect ratio is updated.

8.4.3 Color temperature

What can be done ?

The color temperature can be selected according to the type of source:

There are 4 different preset color temperatures:

- Projector white
- computer : 9300 K
- Video : 6500 K
- Film : 5400 K
- Broadcast : 3200 K

These calibrated presets can be selected and will provide optimum color tracking, the projector allows however the setting of a personal color temperature, this is done in *custom*.

How to select a preset color temperature ?

1. Press **MENU** to activate the Tool bar
2. Press → to select the *Image* item
3. Press ↓ to Pull down the *Image* menu
4. Use ↑ or ↓ to select *Color temperature*
5. Press → to pull down the menu
6. Use ↓ or ↑ to select the desired preset color temperature
7. Press **ENTER**

The color temperature of the image is adapted and a bullet shows the active setting.

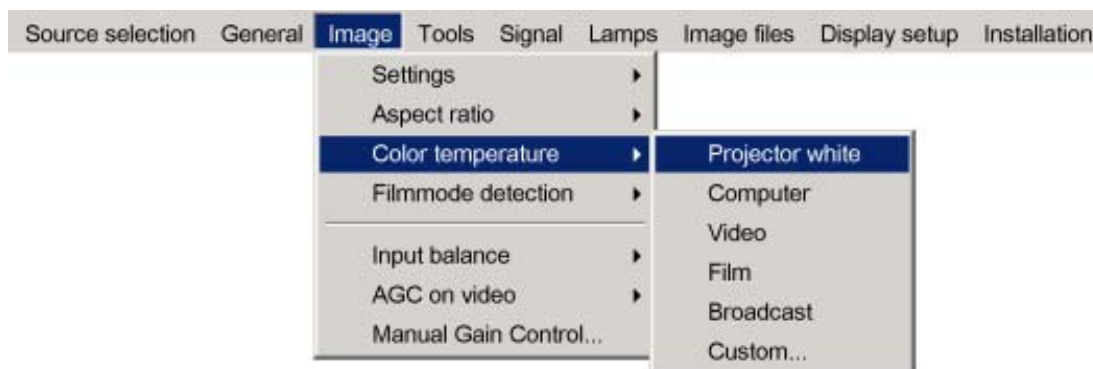

Image 8-28

How to set a custom color temperature ?

1. Press **MENU** to activate the Tool bar
2. Press → to select the *Image* item
3. Press ↓ to Pull down the *Image* menu
4. Use ↑ or ↓ to select *Color temperature*
5. Press → to pull down the menu
6. Use ↓ or ↑ to select *custom*
7. Press **ENTER**

8. Advanced

A slider box for the red custom setting is displayed as well as a wizard text box in the lower part of the screen.

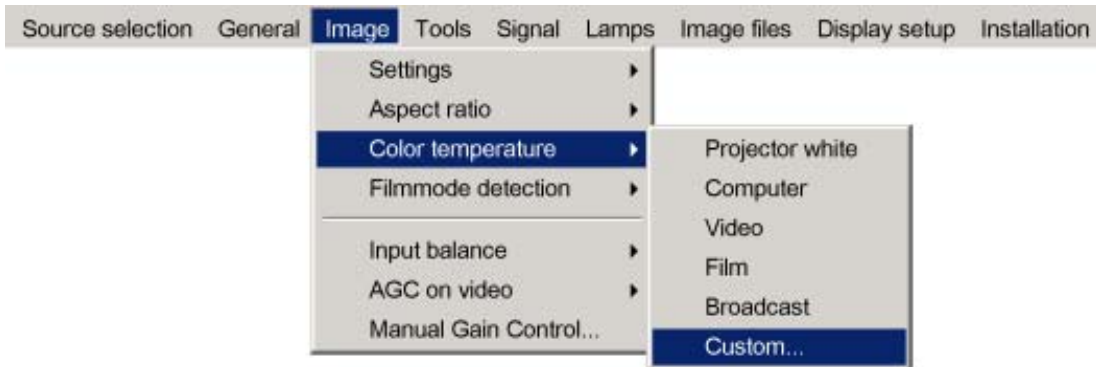

Image 8-29

Follow the instructions on the wizard text box.



Image 8-30



Image 8-31

8.4.4 Film mode detection (video only)

What can be done ?

Some sources like common DVD material are derived from cinema 24 Hz sources (2/2 or 3/2 pull down method).

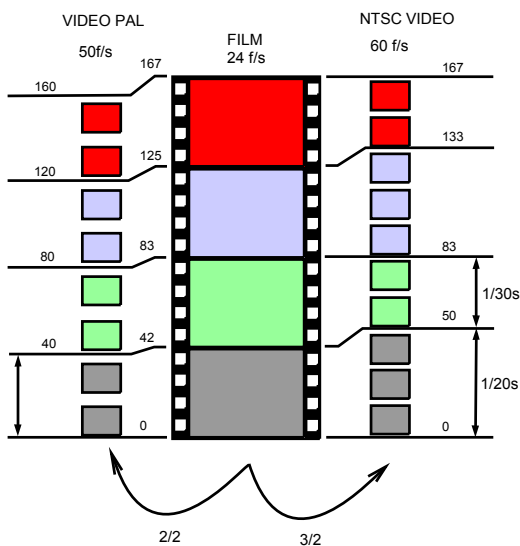

Image 8-32
film to video conversion: 2/2 and 2/3 pull down method

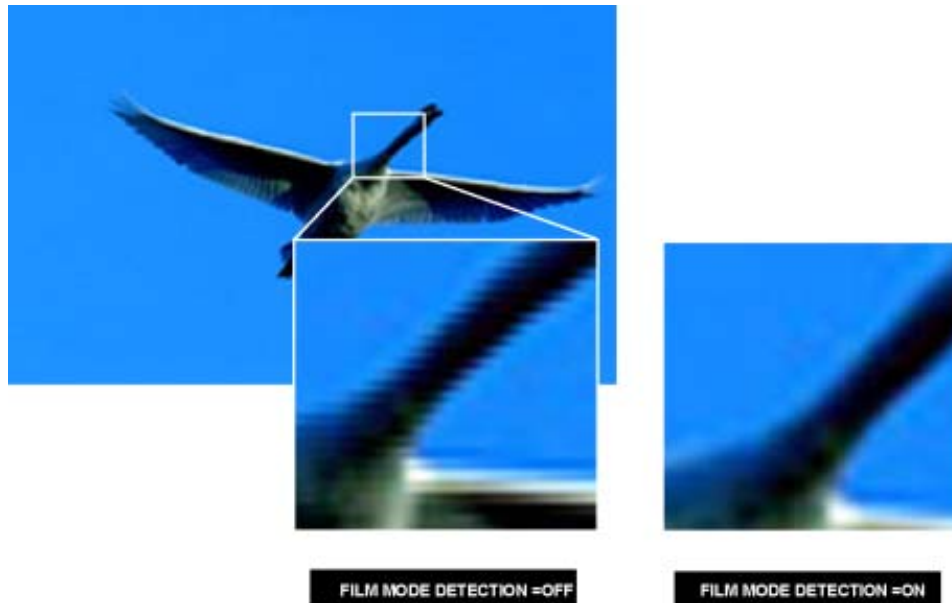

Image 8-33

The filmmode detection insures that these converted signals are shown without artefacts, especially motion artefacts due to bad de-interlacing.



This function may cause undesired effects on standard sources, therefore it can be disabled (OFF) at any time

Enabling/disabling the filmmode detection

1. Press **MENU** to activate the Tool bar
2. Press **→** to select the *Image* item
3. Press **↓** to Pull down the *Image* menu
4. Use **↑** or **↓** to select *Filmmode detection*
5. Press **→** to pull down the menu
6. Use **↓** or **↑** to enable or disable the Filmmode detection

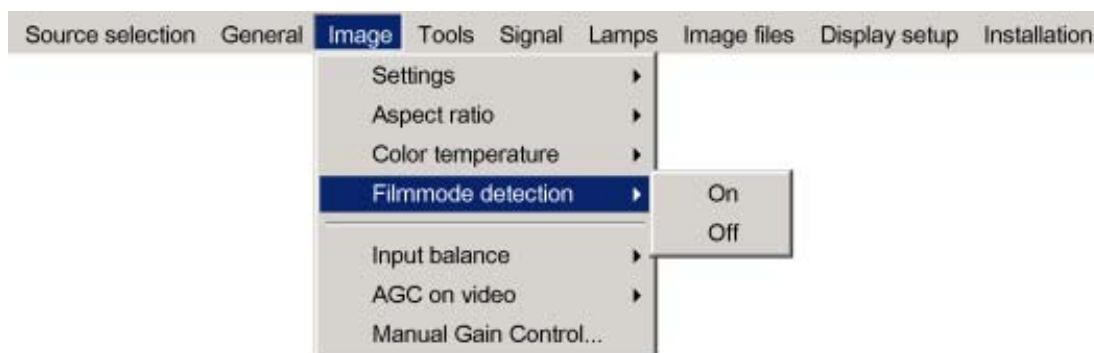

Image 8-34

7. Press **ENTER**

A white bullet shows the active setting

8.4.5 Input balance

Introduction: Unbalanced color signals

When transporting signals, there is always a risk of deterioration of the information contained in the signals.

The alterations of the three color signals will happen independently i.e. the colors will end to be unbalanced,



Image 8-35

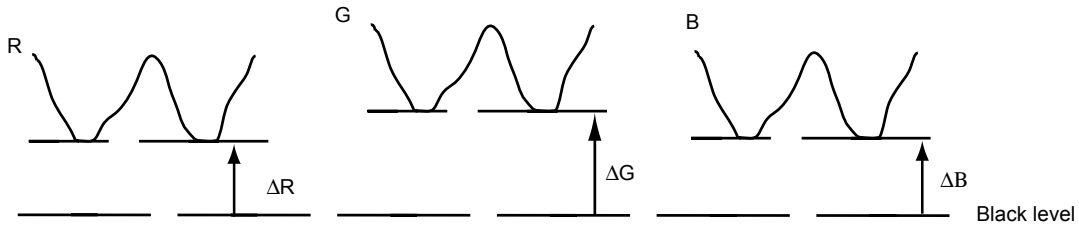

Image 8-36

The objective of input balancing

The objective in input balancing is to “set” the same black level and the same white level for the three colors of a particular input source.



Black level setting : brightness

White level setting : contrast

The same absolute black and white level for the three colors allows the same reference for Brightness and contrast control of the picture !

These two references also set the range in which the ADC will work for that particular source (this explains also why each input balance setting is linked to a particular source and thus saved in the image file).

How can it be done ?

To balance the three color signals of a particular source there are conditions; in fact we must know the black and the white level of the source i.e. :

1. the source in question must be able to generate a white signal, ideally a 100% white (background) full screen pattern
2. the source in question must be able to generate a black signal, ideally a 100 % black (background) full screen pattern

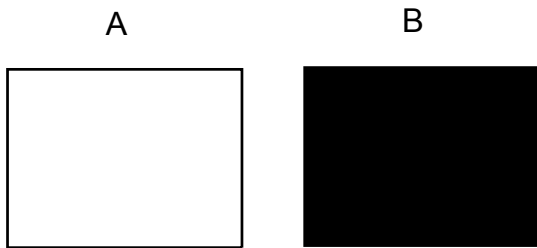

Image 8-37

White balance : In the projector, we will set the contrast for each color until we get a 100% light output picture when projecting a 100% white image (image A)

Black balance : In the projector, we will set the brightness for each color until we get a 0% light output picture when projecting a 100% black image (image B).



The changeover from min to max is indicated by the apparition of bright spots also called “digital noise”



An alternative to a full screen White/black pattern is the standard gray scale pattern, the white bar will be used for white balance and the black bar for black balance.

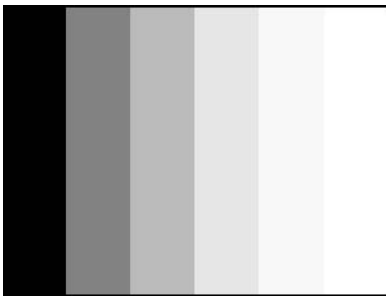

Image 8-38



It is not necessary to adjust the black balance. Its value is automatically set to an optimal value (512).

Performing White input balance

1. Select a black pattern (or gray scale as alternative)
2. Press **MENU** to activate the Tool bar
3. Press → to select the *Image* item
4. Press ↓ to Pull down the *Image* menu
5. Use ↑ or ↓ to select *Input balance*
6. Press → to pull down the menu
7. Use ↓ or ↑ to select *White balance*

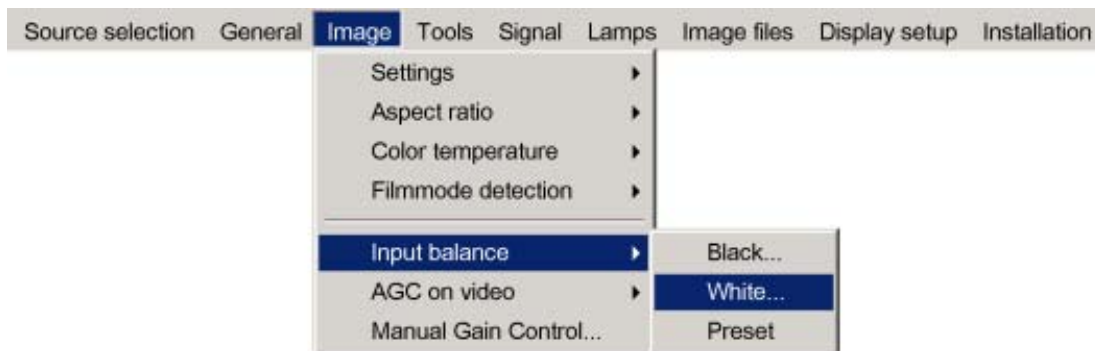

Image 8-39

8. Adjust the red white level (gain) on a minimal value

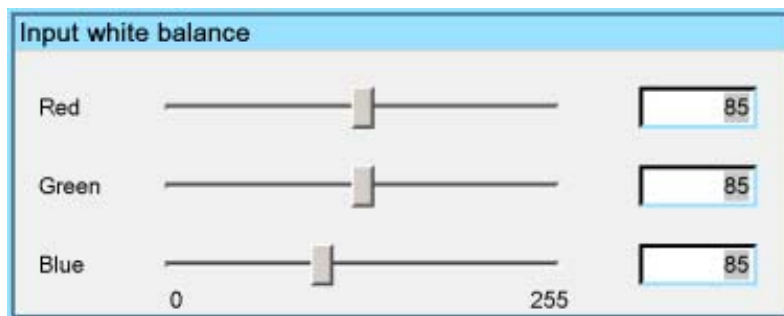

Image 8-40

9. Adjust the blue white level (gain) on a minimal value

Note: *this minimal value is not necessary, provided that the 2 other colors are not influencing too much the color to be adjusted, in fact the aim is to minimize the effect of the two other colors since there is a risk of reaching too soon the transition (bright spots) due to the contribution of these two other colors signals.*

8. Advanced

10. Adjust the Green white level (gain) until bright spots appear on the white part of the image
 11. Adjust the Blue white level (gain) until bright spots appear on the white part of the image
 12. Adjust the Red white level (gain) until bright spots appear on the white part of the image
- The projected image should now be noisy neutral grey.



if one uses a gray scale pattern, the bright spots should appear in the white bar.



Selecting *Preset* restores the factory input balance setting



The input balance settings are stored in the image file, each source has its own input balance.

8.4.6 Automatic gain control (AGC)



AGC is only for Video signals

Enabling/disabling the AGC

1. Press **MENU** to activate the Toolbar
2. Press → to select the *Image* item
3. Press ↓ to Pull down the *Image* menu
4. Use ↑ or ↓ to select *AGC on Video*
5. Press → to pull down the menu
6. Use ↓ or ↑ to enable or disable the AGC
7. Press **ENTER**

A white bullet shows the active setting

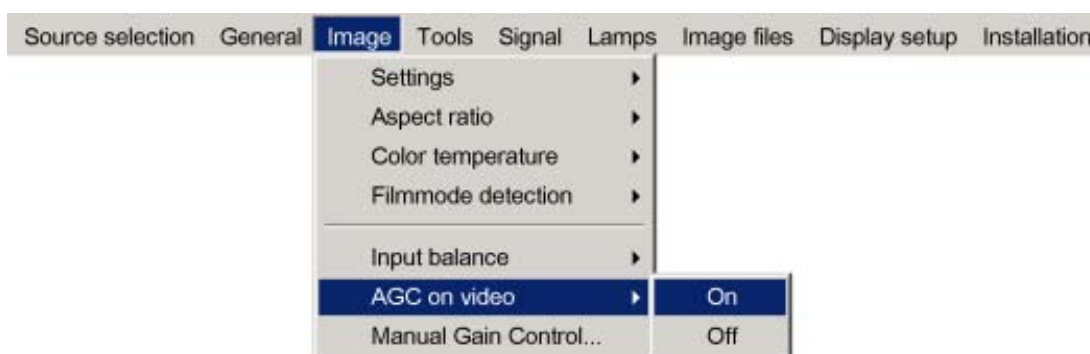

Image 8-41



The AGC can be disturbing in case of Macrovision encoded signals, therefore the AGC can be disabled (OFF) at any time

8.4.7 Manual gain control

What can be done ?

Beside the AGC there is the possibility to manually set the gain of the incoming video signal. When the AGC is enabled (ON), the manual setting does not affect the gain, AGC must therefore be disabled. The manual gain control must be done on an external pattern with white areas (grey scale bar pattern)

How to set the Manual Gain Control ?

1. Press **MENU** to activate the Toolbar
2. Press → to select the *Image* item
3. Press ↓ to Pull down the *Image* menu
4. Use ↑ or ↓ to select *Manual Gain Control*

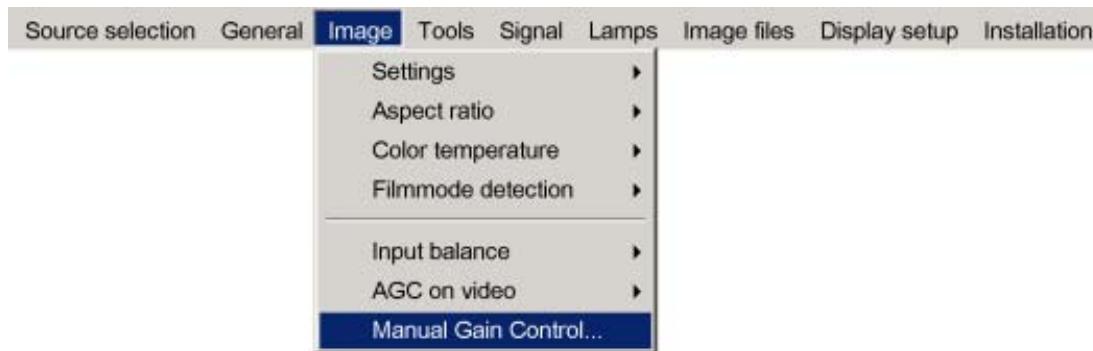

Image 8-42

5. Press **ENTER**

A scroll bar is displayed

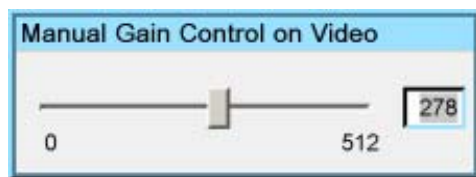

Image 8-43

6. Use ← or →, the numeric keys on the remote, or the keypad to change the gain so as to obtain homogeneous white parts in the image.

8.5 Lamp management

Overview

- Runtimes
- Lamp mode
- History
- Reset lamp Runtime
- Clear lamp error
- Lamp runtime warning

Dual lamp system

The projector uses a dual lamp system and disposes therefore of some interesting features which facilitates lamp management and increases flexibility towards maintenance.

8.5.1 Runtimes

How to display the runtimes ?

1. Press **MENU** to activate the Toolbar
2. Press → to select the *Lamp* item

8. Advanced

3. Press ↓ to Pull down the *Lamp* menu
4. Use ↑ or ↓ to select *Runtimes*



Image 8-44

5. Press **ENTER**
A textbox is displayed

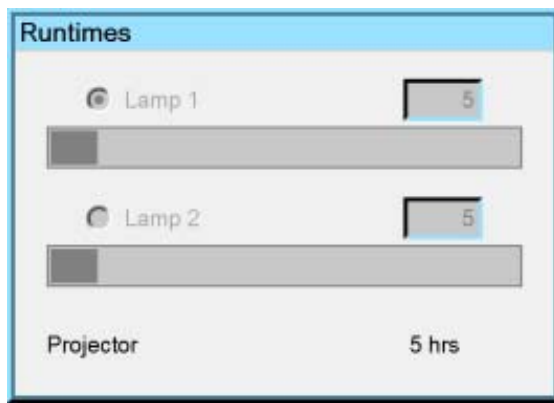

Image 8-45

8.5.2 Lamp mode

Single mode

The projector will always switch to the lamp with the shortest runtime when the difference between the runtimes of lamp 1 and lamp 2 reaches **100 hours**, switching from one lamp to another happens only at switching on of the projector and not during operation.

When the lamp fails or reaches its maximum runtime the projector switches automatically to the other lamp without interrupting the projection



In case of a lamp failure a lamp error is logged and showed on the screen.

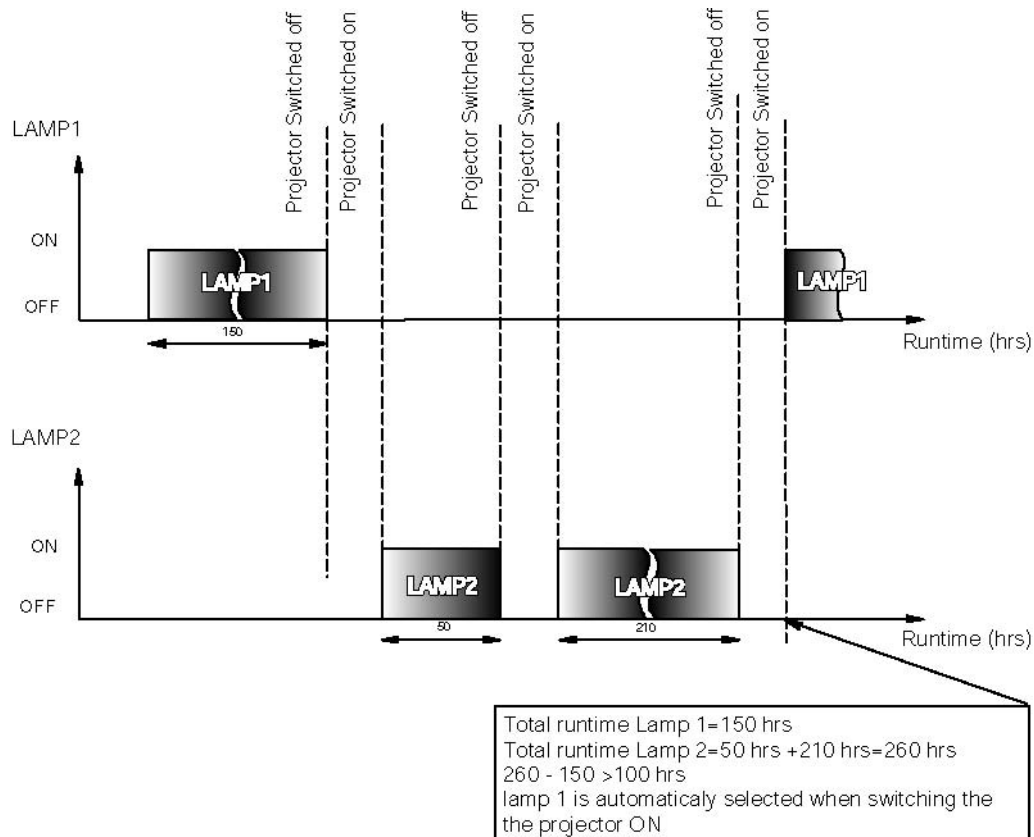

Image 8-46
 Single mode operation: switching principle

Dual mode

Both lamps are working at the same time.

When one lamp fails, the projector continues the projection using the remaining lamp. Again the lamp error is logged and shown on the screen.

How to select the lamp mode ?

1. Press **MENU** to activate the Tool bar
2. Press **→** to select the *Lamp* item
3. Press **↓** to Pull down the *Lamp* menu
4. Use **↑** or **↓** to select *Mode*
5. Press **→** to pull down the menu
6. Use **↑** or **↓** to select the desired mode



Image 8-47

7. Press **ENTER**

A bullet shows the active mode.



When switching from the dual mode to the single mode the lamp with the longest runtime is switched off.
If the runtimes are equal (if the projector has always been operated in dual mode) then lamp 1 is switched out.



When switching to single mode, returning to the dual mode will not be possible in the first 60 seconds, *Dual* in the menu is greyed out and the LED is flickering, showing that hot restrike (restart) of the lamp is impossible during that time laps (60 sec).

8.5.3 History

How to view the history ?

1. Press **MENU** to activate the Tool bar
2. Press → to select the *Lamp* item
3. Press ↓ to Pull down the *Lamp* menu
4. Use ↑ or ↓ to select *History*



Image 8-48

5. Press **ENTER**
A textbox is displayed

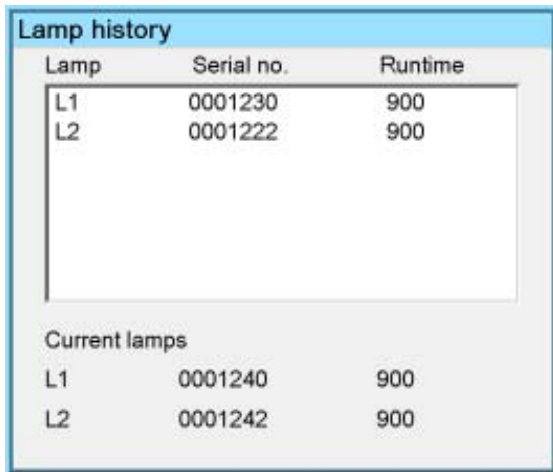

Image 8-49

8.5.4 Reset lamp Runtime

When to reset the lamp runtime ?

Reset the lamp runtime whenever you replace a lamp



WARNING: Lamp runtime reset as well as the lamp replacement can only be done by a Barco authorized technician.

How to reset the lamp runtime ?

1. Press **MENU** to activate the Toolbar
2. Press **→** to select the *Lamp* item
3. Press **↓** to Pull down the *Lamp* menu
4. Use **↑** or **↓** to select *Reset runtime*
5. Press **→** to pull down the menu
6. Use **↑** or **↓** to select the lamp to be reset



Image 8-50

7. Press **ENTER**

A dialogbox is displayed



Image 8-51

8. Use **←** or **→**, the numeric keys on the remote, or the keypad to enter the serial number of the new lamp (serial number 0000000 will not be accepted).

8.5.5 Clear lamp error

Lamp error

When a failure of one of the lamps has occurred, a lamp logo is displayed in the left corner of the screen. This logo will thus always inform the user on a previous lamp error.



Image 8-52

Once the error has been solved or/and the lamp has been replaced one can remove (clear) the lamp error.

If the error has been cleared without solving the lamp problem the logo will be shown at next lamp startup (projector startup for example)



A lamp failing to startup will be noticed by a low light output of the projector since the projector goes in single lamp mode.



In case of a lamp error contact the local Barco authorized technician

How to clear the lamp error ?

1. Press **MENU** to activate the Tool bar
2. Press **→** to select the *Lamp* item
3. Press **↓** to Pull down the *Lamp* menu
4. Use **↑** or **↓** to select *Clear lamp error*



Image 8-53

5. Press **ENTER**

The lamp error logo is removed from the screen

8.5.6 Lamp runtime warning

What can be done ?

When the lamp has reached a predetermined runtime , a warning message will be displayed on the screen. The lamp runtime warning can be set in a range from 30 to 200 hours. The runtime warning is displayed by default at 30 hours before end of lamp lifetime.

How to set the lamp runtime warning?

1. Press **MENU** to activate the Tool bar
2. Press **→** to select the *Lamp* item
3. Press **↓** to Pull down the *Lamp* menu
4. Use **↑** or **↓** to select *Runtime warning*



Image 8-54

5. Press **ENTER**

A dialog box is displayed

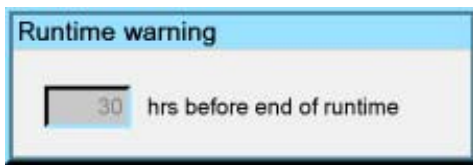

Image 8-55

6. Use ← or →, the numeric keys on the remote, or the keypad to change the runtime warning setting.



WARNING: Lamp runtime reset as well as the lamp replacement can only be done by a Barco authorized technician.

8.6 Image files

Overview

- Introduction to Image files
- Load file
- Forced file load
- Auto Image
- Edit file
- Save as (create a custom file)
- Rename file
- Copy
- Delete

8.6.1 Introduction to Image files

Image files

An image file contains the main characteristics of a source (number of active lines,...). The projector's memory contains a list of files corresponding to the most common sources : standard files.

When a new source corresponds to one of these files, a custom file is created. The file is not automatically saved as a custom file. The Save as... function allows to create and save a custom file.

The active file can always be edited in order to fit exactly the source specifications.



Autolmage creates automatically the best suited image file (custom file) for a new source. Autolmage is used when :

- a new source is detected: Autolmage creates a new custom file which can always be edited if necessary.
- the Autolmage is launched via the button on the RCU, the projector's OSD or from the desktop's OSD

File notation

The notation of the image file happens as follows :

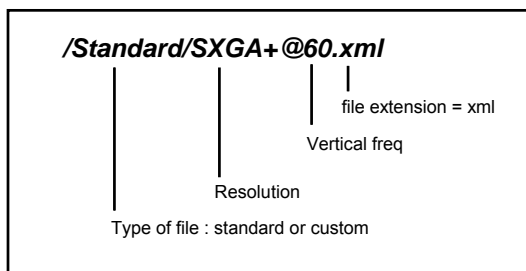

Image 8-56

8.6.2 Load file

When to load a file ?

In some cases the user wants a particular file to be used for the display of a particular source. In this case the user should load the desired file from the image files menu. The load file option will allow the user to choose between several files corresponding more or less to the active source specifications.



In normal operation the file selection (load) will be done automatically by AutoImage.

How to load a file ?

1. Press **MENU** to activate the Tool bar
2. Press → to select the *Image files* item
3. Press ↓ to Pull down the *Image files* menu
4. Use ↑ or ↓ to select *Load*



Image 8-57

5. Press **ENTER**
A dialog box is displayed



Image 8-58

6. Use ↑ or ↓ to select the desired file
Tip: For more information (specifications) on the image files see the Appendix section
7. Press **ENTER**
The file is loaded and the image is adapted.



The list of files which may be loaded will be of the data type if the active window is a data window, or they will be of the video type if the active window is a video window.

What to do if the image is not perfect ?

If the displayed image is not correct after AutoImage or after selecting the best fitting file, go to the Edit menu, select the active file and change the settings.

8.6.3 Forced file load

Forced file load

In some cases the user wants only one particular file to be loaded for a particular input (source) i.e. to prevent the (automatic) load of an inadequate file.

One can link a file to every possible input of each layer.

If a file is already selected (forced) to that particular input it will be indicated in the menu.

How to force a file to be loaded ?

1. Press **MENU** to activate the Tool bar
2. Press **→** to select the *Image files* item
3. Press **↓** to Pull down the *Image files* menu
4. Use **↑** or **↓** to select *Forced file load*
5. Press **→** to open the menu
6. Use **↑** or **↓** to select the desired layer (for example Layer 1)
7. Use **↑** or **↓** to select the desired input (for example Data on BNC)

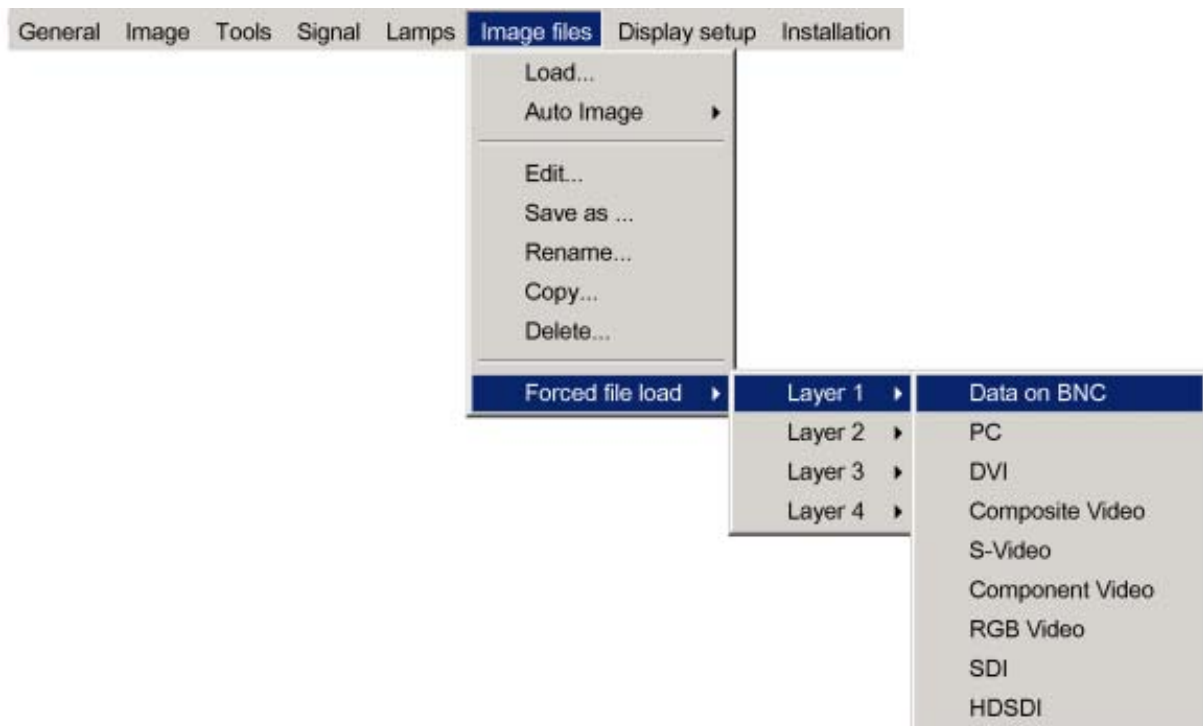

Image 8-59

Note: Inputs that are not hardware compatible with this layer are greyed out.

Note: if a file is already forced for that input it will be shown on the right.

8. Press **ENTER**
The *Load* dialog box is displayed
9. Use **↑** or **↓** to select the desired file (for example */Standard/SXGA+@60.xml*)
10. Press **ENTER**
The file is selected and will be loaded in the future.



To delete the forced file, go to the desired input and press **ENTER**.

8.6.4 Auto Image

What can be done ?

AutoImage creates the best suited image file for the connected source.

It calculates/measures several source parameters :

- Total pixels per line
- Start pixel
- Phase
- Contrast/Brightness levels



Auto Image works only for data images.

The measure of the total number of pixels per line can be done through 2 methods

- Limited scan: a windowing system is used to allow fast tracking. The operation takes about 20 seconds (depending on file)
- Full scan: tracking is done over the full range. The operation takes about 1.5 minutes (depending on file)

How to launch Auto Image?

1. Press **MENU** to activate the Tool bar
2. Press → to select the *Image files* item
3. Press ↓ to Pull down the *Image files* menu
4. Use ↑ or ↓ to select *Auto Image*
5. Press → to open the menu
6. Use ↑ or ↓ to select the desired file scan method

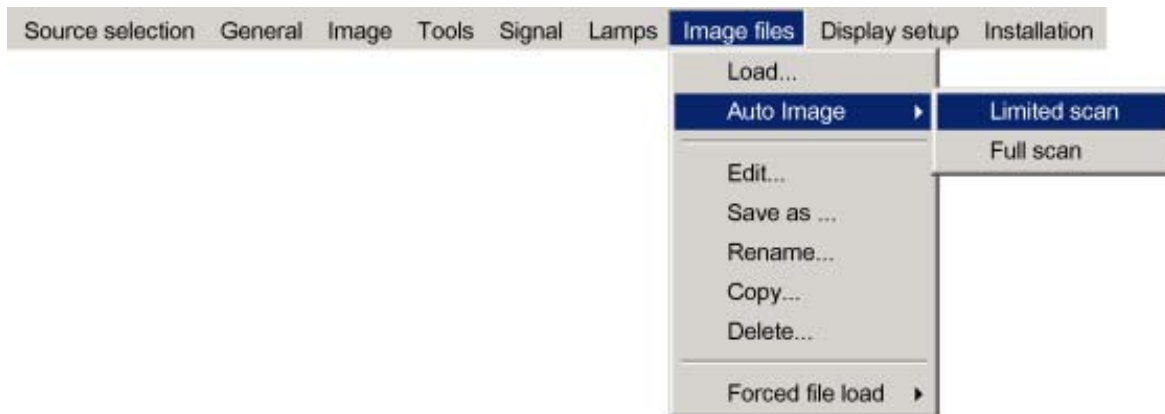

Image 8-60

7. Press **ENTER**



AutoImage acts on the active window. The image in the window may move and change in aspect during the AutoImage process.



Auto Image can also be launched via the RCU with the dedicated AutoImage key.

8.6.5 Edit file

What can be done with the Edit file menu ?

The Edit file menu makes it possible to change the settings of the file according to the real settings of the connected source. Consult the source specifications before entering the data.



only the active file can be edited

How to edit a file ?

1. Press **MENU** to activate the Tool bar
2. Press **→** to select the *Image files* item
3. Press **↓** to Pull down the *Image files* menu
4. Use **↑** or **↓** to select *Edit*



Image 8-61

5. Press **ENTER**
A dialog box containing the active file is displayed

The 'Edit file' dialog box for 'SVGA@75.xml' contains the following fields:

Horizontal:	
Total:	1056 pixels
Active:	800 pixels
Start:	151 pixels
Period:	21333 pixels
Vertical:	
Total:	625 lines
Active:	600 lines
Start:	19 lines

An 'Advanced' button is located at the bottom of the dialog.

Image 8-62

6. Use **←** or **→**, the numeric keys on the remote, or the keypad to edit and change the values, confirm with **ENTER**
Note: *greyed out fields can not be updated (total pixels)*

Which items can be adjusted ?

The following items can be adjusted :

- Active horizontal pixels
- Horizontal start in pixels
- Horizontal period in ns
- Active vertical lines
- Vertical start in lines

Advanced video settings

The **advanced** button enables the advanced settings for a video source.

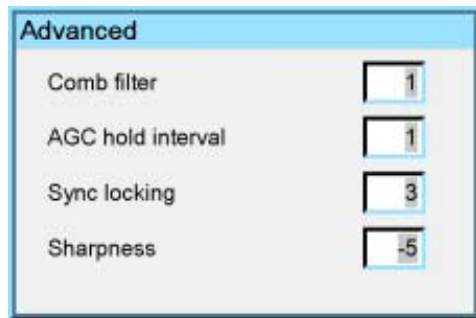

Image 8-63

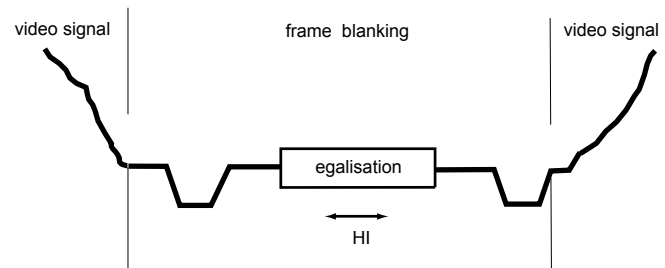

Image 8-64
HI AGC Hold interval

The **Comb filter** is by default enabled.

The **AGC hold interval** is the time interval in which the AGC is inhibited (AGC hold = no update in video amplitude measurement), the advanced parameter allows to choose a short or long hold interval.

A long AGC hold interval eliminates Macrovision® disturbances since the AGC is hold during a long interval, thus reducing the probability to encounter a Macrovision® pulse.

The **sync locking setting** is recommended for poor video signals (ex: poor TV signals).

Sharpness adjustment can be chosen to be coarse or fine.



It is recommended to use the default values.

Advanced Data settings

The **advanced** button enables the advanced settings for a data source.



Image 8-65

- color space : allows to select between 5 different color spaces
 - RGB
 - ITU_BT_709
 - SMPTE_240M
 - ITU_BT_601
 - EBU
- Clamp position : allows to set the clamp pulse position in the clamping circuit
- Clamp width : allows to set the width of clamp pulse in the clamping circuit

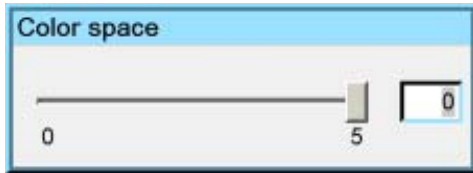

Image 8-66



It is recommended to use the default values.

8.6.6 Save as (create a custom file)

Creating a custom file

When the loaded file is a standard file there is a possibility of saving it as a custom file (= creating a custom file), this is done with the save as function. The saved file will always be a custom file (saved in the custom directory)



For sources that are often used, a custom file should be created. This custom file will then be loaded automatically and will prevent the AutoImage from being launched.

How to save a file ?

1. Press **MENU** to activate the Tool bar
2. Press → to select the *Image files* item
3. Press ↓ to Pull down the *Image files* menu
4. Use ↑ or ↓ to select *Save as...*



Image 8-67

5. Press **ENTER**
A dialog box is displayed
Use ← or →, ↓ or ↑ the numeric keys on the remote, or the keypad to edit and change the file name, confirm with ENTER.

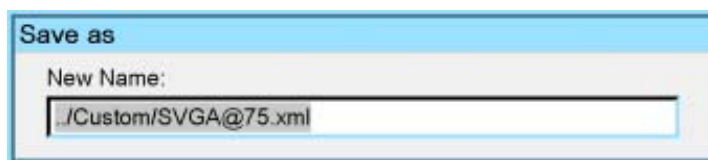

Image 8-68

8.6.7 Rename file

How to rename a file ?

1. Press **MENU** to activate the Tool bar
2. Press → to select the *Image files* item

8. Advanced

3. Press ↓ to Pull down the *Image files* menu
4. Use ↑ or ↓ to select *Rename*

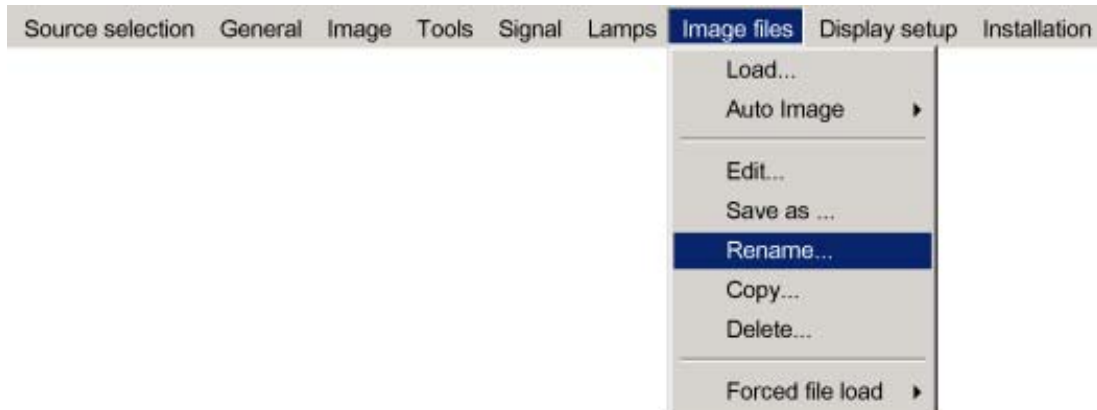

Image 8-69

5. Press **ENTER**
A dialog box is displayed
Use ← or →, ↓ or ↑ the numeric keys on the remote, or the keypad to edit and change the values, confirm with ENTER.

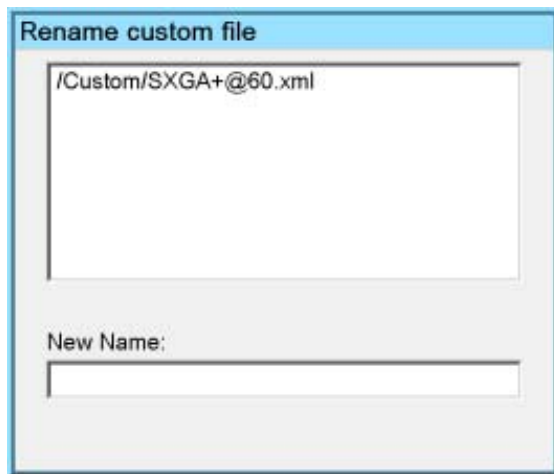

Image 8-70

8.6.8 Copy

Copy a file

The copy function allows to copy a file (standard or custom) to a custom file (to the custom directory).

How to copy a file ?

1. Press **MENU** to activate the Tool bar
2. Press → to select the *Image files* item
3. Press ↓ to Pull down the *Image files* menu
4. Use ↑ or ↓ to select *copy*

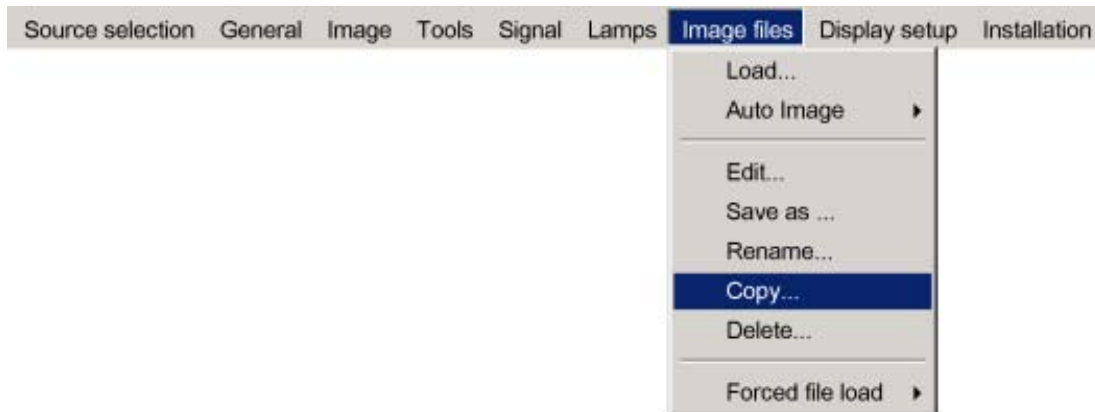

Image 8-71

5. Press **ENTER**
A dialog box is displayed

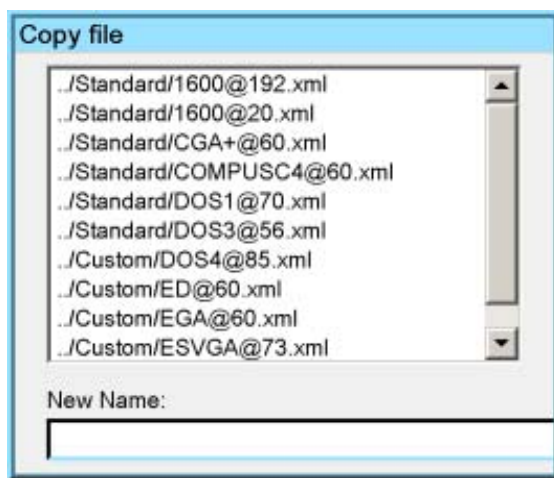

Image 8-72

6. Use ↑ or ↓ to select the file to be copied
7. Press **ENTER**
The file name is copied in the edit field
8. Use the keys on the remote to change the name of the destination file

8.6.9 Delete

How to delete a file ?

1. Press **MENU** to activate the Tool bar
2. Press → to select the *Image files* item
3. Press ↓ to Pull down the *Image files* menu
4. Use ↑ or ↓ to select *delete*



Image 8-73

5. Press **ENTER**
A dialog box is displayed

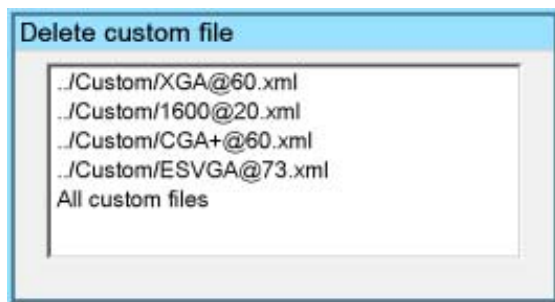

Image 8-74

6. Use ↑ or ↓ to select the desired file
7. Press **ENTER**
The selected file is deleted and is removed from the list

8.7 Display setup

Overview

- Full screen synchronous representation
- Textbox
- Menu bar position
- Status bar position
- Sliderbox position

8.7.1 Full screen synchronous representation

What can be done ?

In the full screen mode, the projector will always try to lock on the input source. Some monitors (connected on the DVI output of the projector) may fail to synchronize on this type of signal (number of total lines may vary in such a signal).

The *Full-screen synchronous representation* function in the *Display setup* menu allows to disable this mode.



Note that disabling the synchronous mode may introduce some image artefacts in the displayed DVI output signal (on the monitor)

How to enable/disable the full-screen synchronous representation ?

1. Press **MENU** to activate the Tool bar
2. Press → to select the *Display setup* item
3. Press ↓ to Pull down the *Display setup* menu

4. Use ↑ or ↓ to select *Full-screen synchronous representation*
5. Press → to open the menu
6. Use ↑ or ↓ to select ON(enable)/OFF(disable)
7. Press **ENTER**

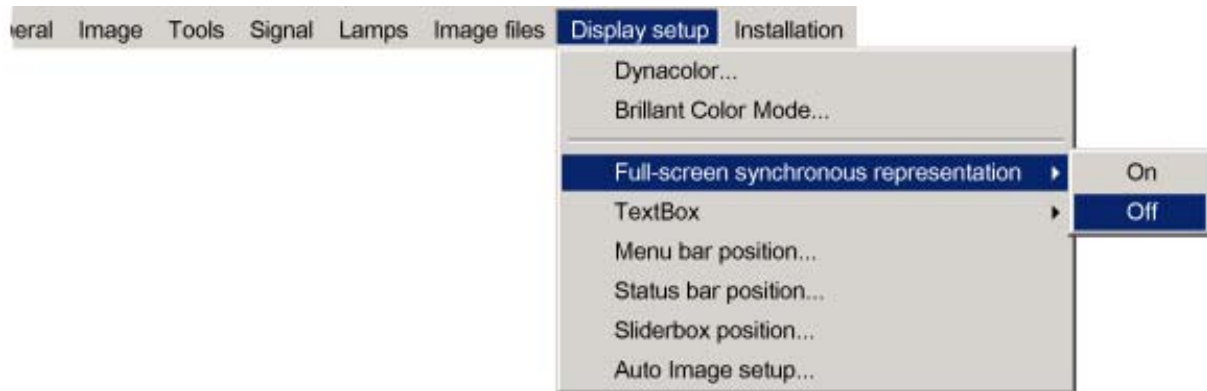

Image 8-75

8.7.2 Textbox

What can be done ?

The Textbox function allows to display or not the different textboxes used for instance for picture settings (contrast,...), it also affects the source information windows (displayed in the right lower corner of the screen).

How to enable/disable the Textbox ?

1. Press **MENU** to activate the Tool bar
2. Press → to select the *Display setup* item
3. Press ↓ to Pull down the *Display setup* menu
4. Use ↑ or ↓ to select *Textbox*
5. Press → to pull down the menu
6. Use ↓ or ↑ to enable/disable the textbox

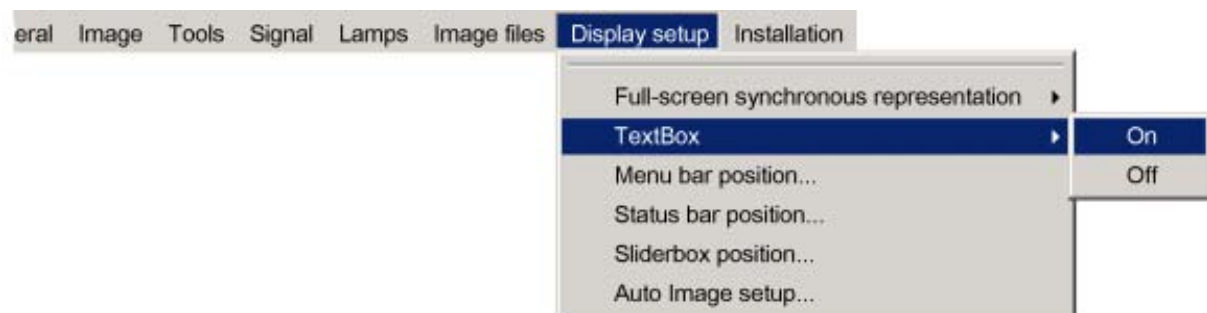

Image 8-76

7. Press **ENTER**

8.7.3 Menu bar position

What can be done ?

The menu tool bar can be centered vertically, the range being from top of the screen to the middle of the screen. This can be useful in applications where the top image content is not displayed.

How to center the menu ?

1. Press **MENU** to activate the Tool bar
2. Press → to select the *Display setup* item
3. Press ↓ to Pull down the *Display setup* menu
4. Use ↑ or ↓ to select *Menu bar position menu*

5. Press **ENTER**



Image 8-77

6. Use ↑ or ↓ to position the Menu bar

8.7.4 Status bar position

What can be done ?

The status bar (wizard menu) can be centered vertically , the range being from bottom of the screen to the middle of the screen. This can be useful in applications where the bottom image content is not displayed.

How to center the menu ?

1. Press **MENU** to activate the Tool bar
2. Press → to select the *Display setup* item
3. Press ↓ to Pull down the *Display setup* menu
4. Use ↑ or ↓ to select *Status bar position*

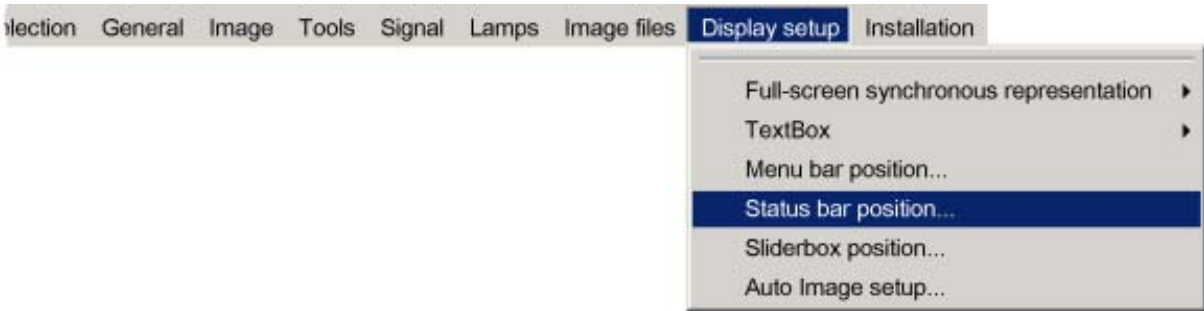

Image 8-78

5. Press **ENTER**

6. Use ↑ or ↓ to position the status bar

8.7.5 Sliderbox position

What can be done ?

The sliderbox can be displayed anywhere on the screen, the position can be set in this menu.

How to reposition the sliderbox?

1. Press **MENU** to activate the Tool bar
2. Press → to select the *Display setup* item
3. Press ↓ to Pull down the *Display setup* menu
4. Use ↑ or ↓ to select *Sliderbox position*



Image 8-79

5. Press **ENTER**

A slider box is displayed. Use the 4 arrow keys to drag the box to the desired position.



There is a coarse and a fine adjustment of the position, use **ENTER** (when slider box is displayed) to switch between the two.

9. NETWORK CENTRIC OPERATIONS

9.1 Introduction

Overview

- Network architecture
- Network functionality
- iCon server specifications

9.1.1 Network architecture

**SBC**Single Board Computer,

**GUI**Graphic User Interface

Topology

The network centric projector (iCon and iQPro) uses an integrated PC (SBC) and can be connected to a LAN.

The projector performs the role of Server while each PC is declared as a Client within the system.

Each client PC has to be configured (projector IP address, ...), see "Configuring the client software"

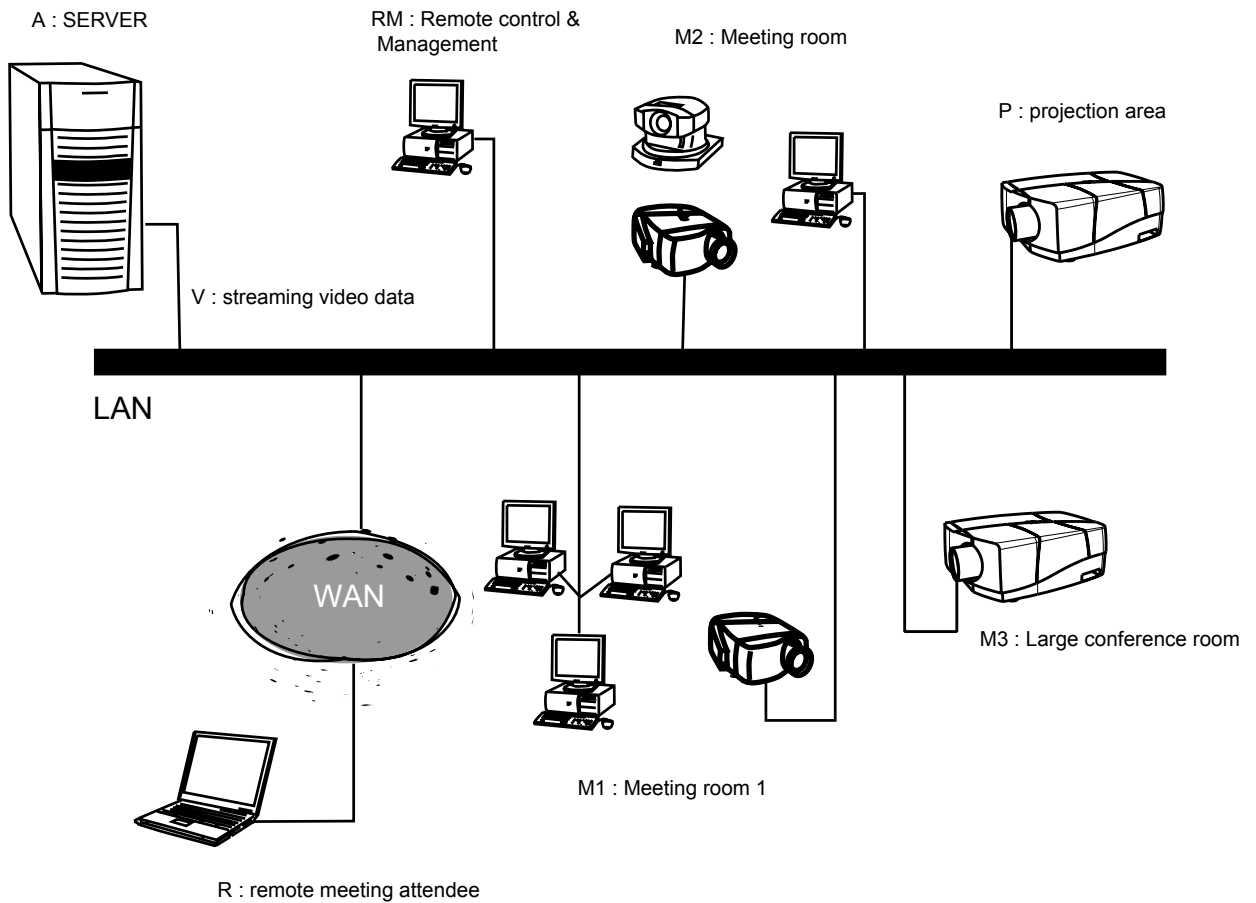

Image 9-1
Typical iQ Pro network architecture

- A server
- RM Remote Control and Management
- M1 Meeting room 1
- M2 Meeting room 2
- M3 Large screen conference room
- P Projection area
- R Remote meeting attendee
- V Streaming Video data



Wireless LAN (point-to-point) is also possible (using the PCMCIA connection on the projector) and complements the functionality of direct cabling.

9.1.2 Network functionality

What can be done ?

The network functionality allows the projector to perform several network functions thanks to network features which are required in most corporate environments:

- **Control & Management** : wireless/wired (remote) control and monitoring of the projector(s) thanks to a user-friendly GUI (the Client software).
- **Diagnostics** : diagnostics through a user-friendly GUI and automatic E-mail sending.
- Easy file (MS PowerPoint,...) manipulation and projection using the **DropZone** interface.
- **Remote control** of the projector by allowing the desktop to be shared over the network (the **DropZone** interface).
- **Streaming media** : The projector's onboard computer is streaming video data ready, i.e. allowing the decoding of video streaming data coming from a server via the LAN.



The network centric projector may be configured in the same way as a standard PC to support :

- **SNMP service** : provides diagnostics, basic control via SNMP messaging
- **Microsoft Exchange services**: for scheduling of projector tasks.
- **Web client** : offers an alternative to the Client software through a user-friendly internet based interface (includes almost the same features as the Client software)

See the Appendix "General guidelines on Network configuration" for general guidelines on how to enable these services.

9.1.3 iCon server specifications

Specifications

- 2.6 GHz Pentium IV processor ¹
- 1GB DDR RAM
- 40 GB Hard Disk storage
- Microsoft XP Operating System
- Barco Server Software for network communication between Server and clients

9.2 Control

Overview

- Description
- How to use the control manager?
- General
- The source selection screen
- The PiP screen
- Image settings
- Advanced control

9.2.1 Description

What can be done ?

The projector allows a software client (client PC) to communicate locally with the server and hereby control the projector's settings, in this case one has a **point to point** communication, image 9-2. The client PC or laptop communicating with the projector may be locally installed or may be remote, communication may then happen over a LAN, image 9-3

The projector performs the role of Server while the PC acts as a Client within the system.

The control and management client software includes the possibility to create groups of projectors and that way control a whole fleet of projectors.

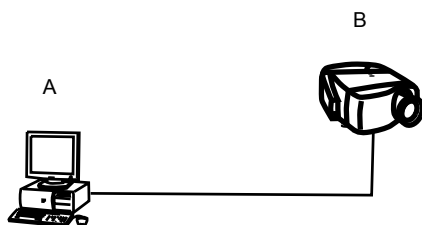

Image 9-2
point to point iQ Pro network communication

- A facility manager's desk
- B projector area

¹. the pentium IV socket is upgradeable

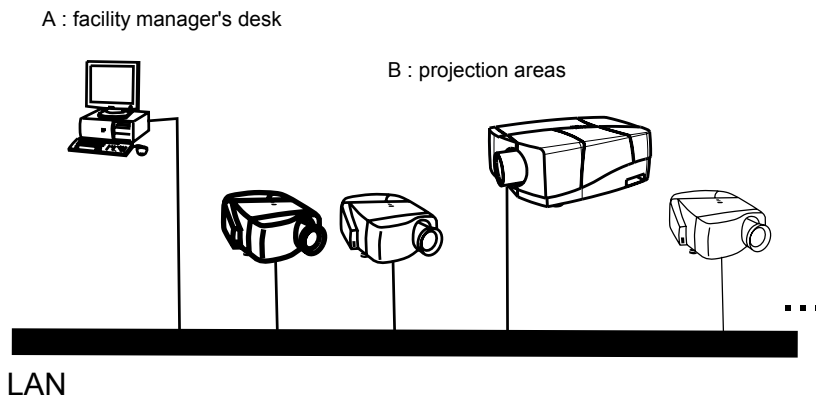

Image 9-3
control & management of network centric projector(s)

- A facility manager's desk
- B projector area

What can be controlled ?

Almost every menu item can be controlled through the control manager

- standby on/off
- lamp mode
- source selection
- switching effects
- background setting
- all PiP settings (layout, window)
- Image settings
- lens adjustments

The control manager

The control interface in the client software is divided into 5 subscreens, image 9-4:

- General
- source selection
- PiP
- image settings
- advanced

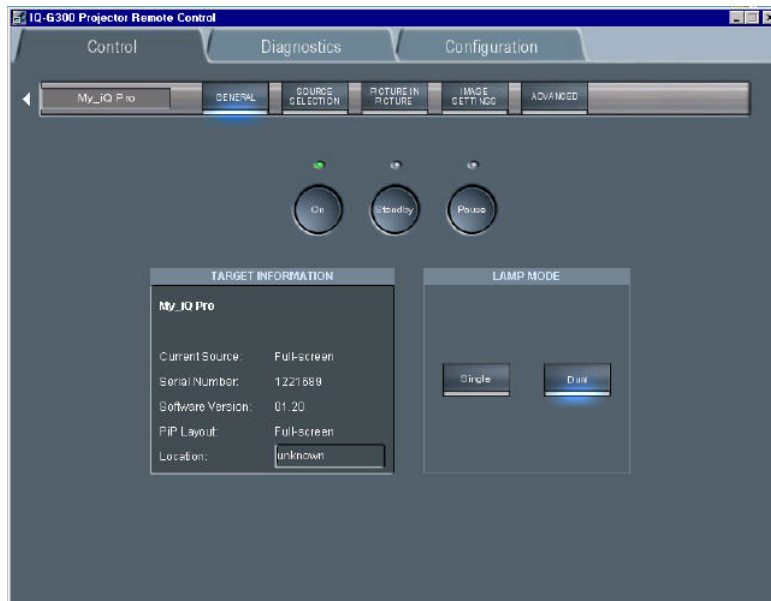

Image 9-4
The control interface: the general sub screen is active (see tool bar)

9.2.2 How to use the control manager?

How to use the control manager?

1. Choose the sub screen by clicking on the desired item on the tool bar in the upper part of the control interface
The active sub screen is indicated with a blue spot

9.2.3 General

What can be done ?

Basic controlling, monitoring and general parameter setting of the projector can be done in this screen, image 9-4.

- 3 buttons *ON*, *STANDBY* and *PAUSE*
- The *target information* part gives the main characteristics of the projector
- 2 buttons allow to switch between dual and the single lamp mode

How to change the general settings?

1. Click on the lamp mode button to select the desired mode
A blue spot indicates the active mode
2. Click on one of the three buttons to start up, pause or put in standby the projector
A green led indicates the status of the projector.

9.2.4 The source selection screen

What can be done ?

- A source selection dialog box allows to visualize all the sources or only the detected sources.
- 3 buttons to activate, freeze, pause and logo
- selection of 12 different switching effects
- selection of 3 different backgrounds: logo, Blue, Black

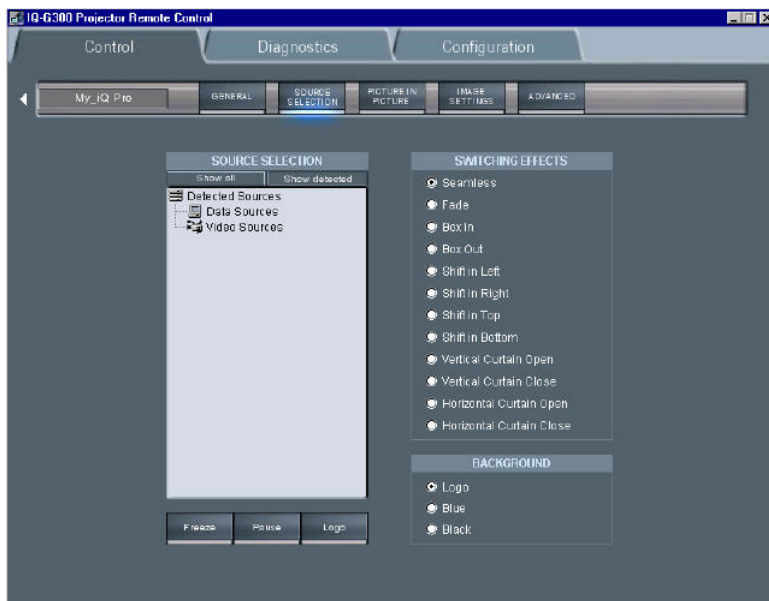

Image 9-5
The source selection screen

How to select a source ?

1. Click on *show all* or *show detected*

Depending on the option (show all/detected) selected, a list is displayed.

In case *show all* is selected, a list of all possible sources is displayed, signal presence is indicated with an orange dot.

When *show detected* is selected, all the detected sources are displayed with an orange dot.

2. Double click on the desired source

The selected source is now projected



In group mode there are only grey or green nodes, no orange (detected).

On start up, a green node will be shown when all projectors are playing the same source type.

Grey will be shown when some of the projectors are not showing the same source type.

If we double click on a grey node, it should go green as long as at least one of the projectors in the group can show the source.

9.2.5 The PiP screen



Following screenshots are taken for an iQPro projector. The layouts may be slightly different for an iCon (layout automatically adapted after projector type detection by the client).

What can be done ?

The PiP tool allows to manage the PiP of the projector in a more user friendly way:

- a check box list allows to choose between 10 PiP layout (5 preset layouts and 5 personal layouts)
- several buttons allow operations on windows (add, remove) as well as on the PiP layouts (save, ...)
- a graphical screen allows easy altering of the PiP layout : re sizing, positioning of the different windows.

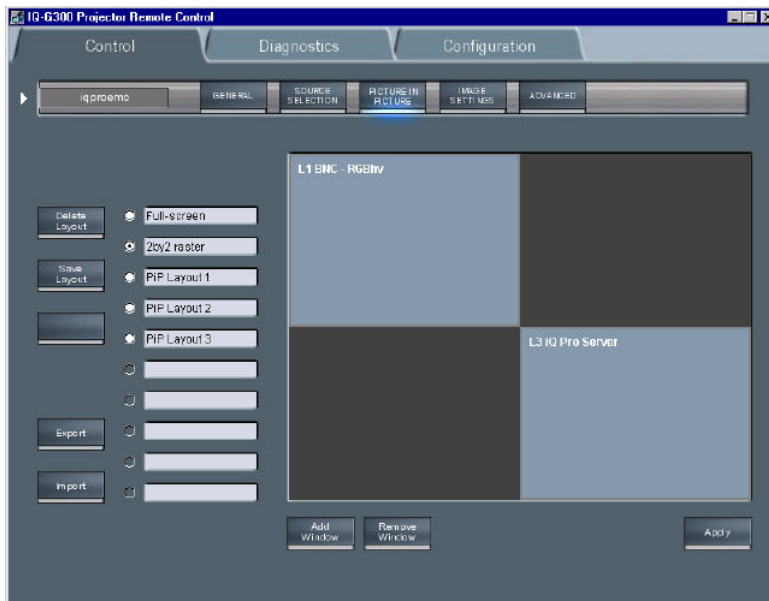

Image 9-6
PiP screen

How to perform operations on a PiP layout

As an example, let us choose a personal (non preset) layout, add a window, reposition the windows, and save the layout under a different name.

1. Click on one of the check boxes to choose a layout

Choose a personal layout



Image 9-7

9. Network centric operations

The PIP screen (as well as the projected layout) is updated

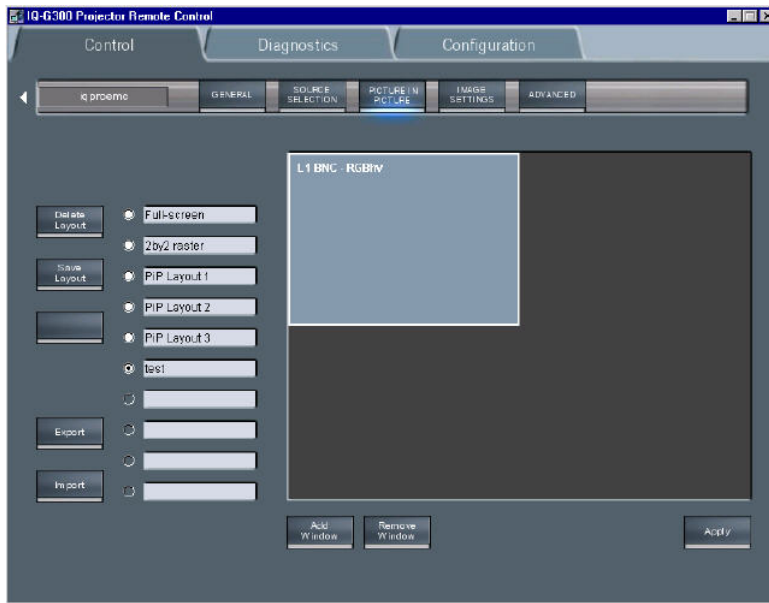

Image 9-8

This layout contains one window being an RGBHV Data source

2. Click on the *Add window* button

Note: if the layout already contains 4 window, it will be impossible to add a new one. In that case a window is displayed, image 9-9



Image 9-9

A dialog box is displayed showing the possible sources to be added.

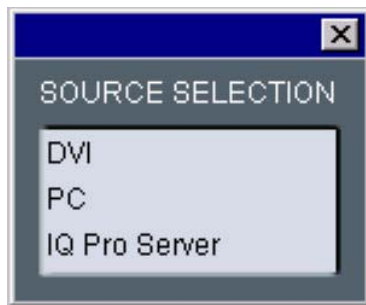

Image 9-10
Add window dialog box

3. Select the source to be linked to the new window.

The window is added to the layout.

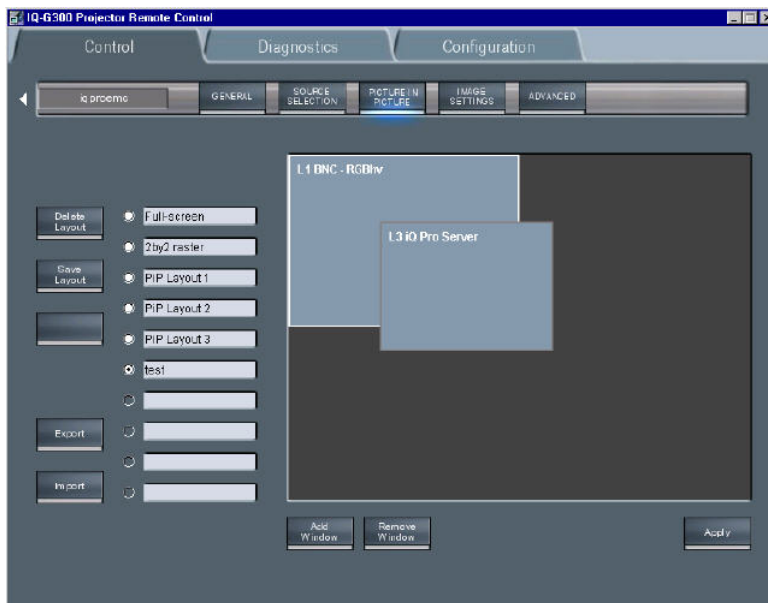

Image 9-11

4. When entering the PiP screen the cursor is replaced by a hand, Click on the window to be repositioned.
The window is surrounded by a white frame.
5. Drag the window to the desired position.
6. Place the cursor on one of the corners of the window to be re sized.
A double arrow is displayed.
7. Drag to re size.
Note: *the window is re sized by keeping the same aspect ratio.*

Importing/exporting a layout

Every PiP layout can be exported and saved as backup on the network or on the hard disk of the Client PC. It can then be imported at any time.

How to import/export a layout ?

1. Click on the *Export* button.
A dialog box is displayed.

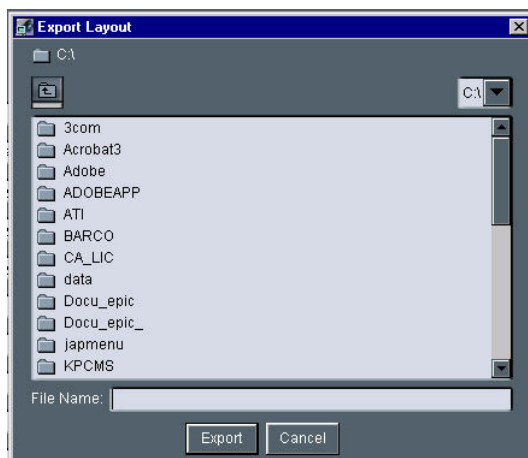

Image 9-12

2. Browse to the desired location and fill in the filename.

How to import a layout ?

1. Click on the import button.

A dialog box is displayed.

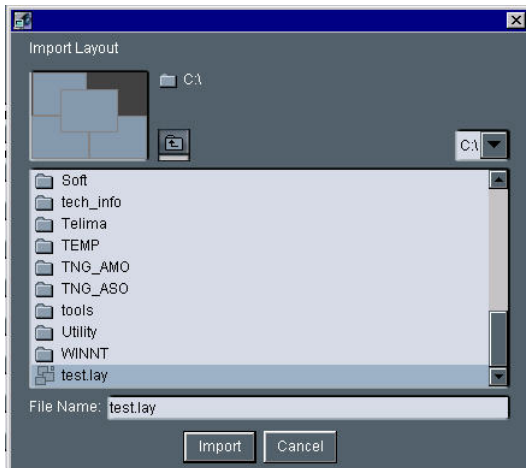

Image 9-13

2. Select the layout to be imported.



For more information on Picture in Picture see the PiP chapter.

9.2.6 Image settings

What can be done ?

- General settings
- Color temperature
- Geometry

General image settings

1. Click on *Image settings* menu in the tool bar to drop down the submenu



Image 9-14

2. Click on *General*
3. Slide the cursors to set the corresponding value

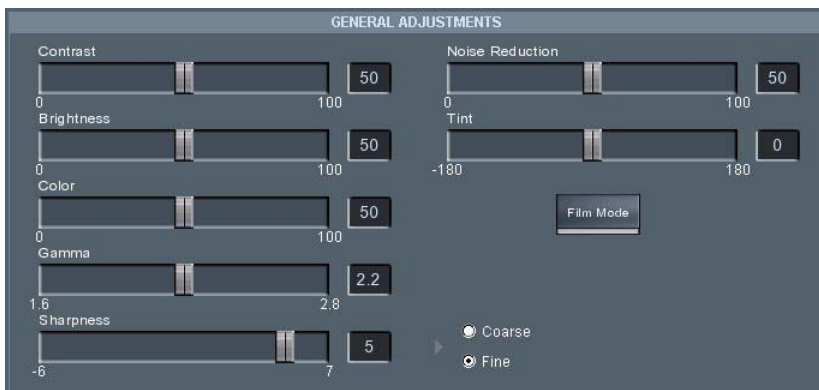

Image 9-15



Use the checkbox to define a coarse or a fine setting.



Click on the *Filmmode* button to enable or disable the filmmode.

Color temperature preset settings

1. Click on *Image settings* menu in the tool bar to drop down the submenu.
2. Click on *color temp*, image 9-14
3. Click on the desired preset color temperature.

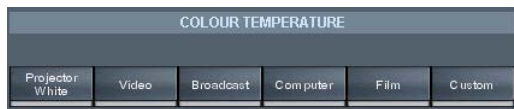

Image 9-16

Custom color temperature setting

1. Click on the *Custom* button.
A dialog box is displayed.

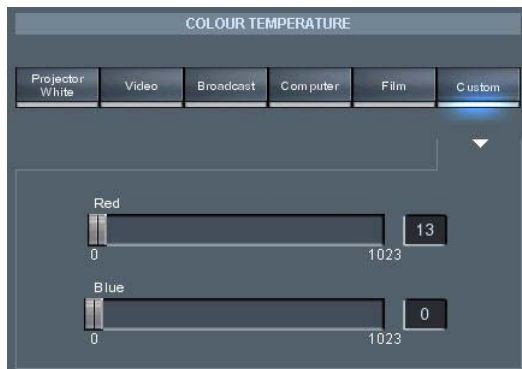

Image 9-17

2. Use the sliders to set the red and the blue color temperature.

Geometry settings

1. Click on *Image settings* menu in the tool bar to drop down the submenu.



Image 9-18

2. Click on *Geometry*.

9. Network centric operations

a dialog box is displayed.



Image 9-19

3. Use the buttons to zoom or pan.
Tip: Use the buttons to choose small, medium or large adjustment steps.
Each click changes the setting.
4. Click on the desired aspect ratio and resolution handling mode.

9.2.7 Advanced control

Overview

- Lens adjustments
- Options

9.2.7.1 Lens adjustments

How to adjust the lens ?

1. Click on the *Advanced* menu in the tool bar to drop down the submenu
2. Click on *lens adjustments*



Image 9-20
the Advanced control submenu

3. Use the buttons to shift/zoom/focus the lens



Image 9-21

Tip: Use the buttons to choose small, medium or large adjustment steps. Each click changes the setting.

9.2.7.2 Options

How to start up the options menu ?

1. Click on the *Advanced* menu in the tool bar to drop down the submenu.
2. Click on *Options* .

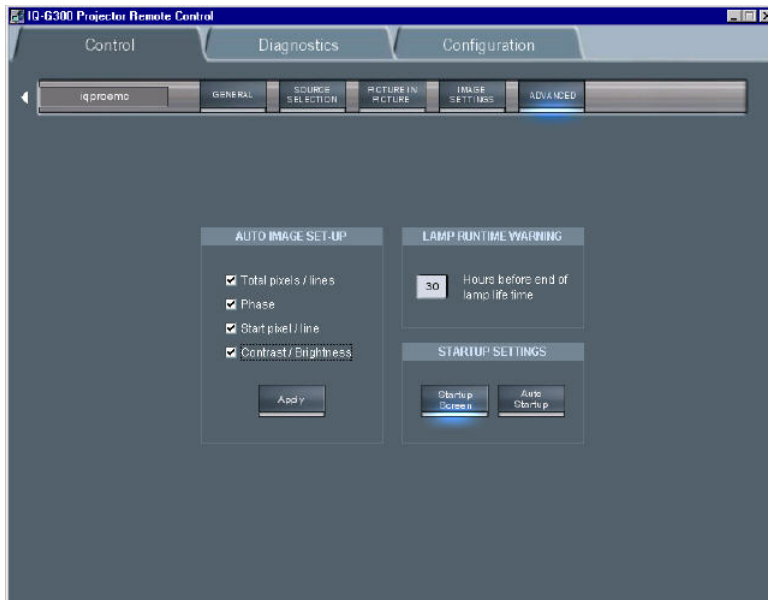

Image 9-22
The advanced Options screen

How to set up and perform AutoImage ?

1. Check the boxes corresponding to the desired setting of AutoImage.



Image 9-23

2. Click on Apply to perform AutoImage.

Lamp runtime warnings startup settings

1. Fill in the lamp runtime warning time.



Image 9-24

2. Click on startup screen to enable the startup screen.
3. Click on Auto Startup to enable automatic startup.



A blue spot indicates that the function is enabled.

9.3 Configuration

9.3.1 E-mail messaging

What can be done ?

E-mail messaging allows the projector to generate automatically E-mail and send them to three configurable recipients.

The mail can be sent on a regular basis i.e. daily, weekly or monthly or can be triggered by warnings.

Basically two different configurations must be done:

- content
- timing

Content configuration

The content configuration allows to define the content of the E-mail

- general content
- advanced content

Timing configuration

E-mail sending can be set to be time dependent or status dependent

- daily : E-mail is sent every day, the time can be set
- weekly: the day can be set with a calendar
- on warning : a E-mail is sent whenever a warning is generated by the projector

9.3.2 E-mail configuration

How to configure the E-mail ?

1. Click on *Configuration* in the toolbar
2. Click on *Mail Config* to open the mail configuration screen

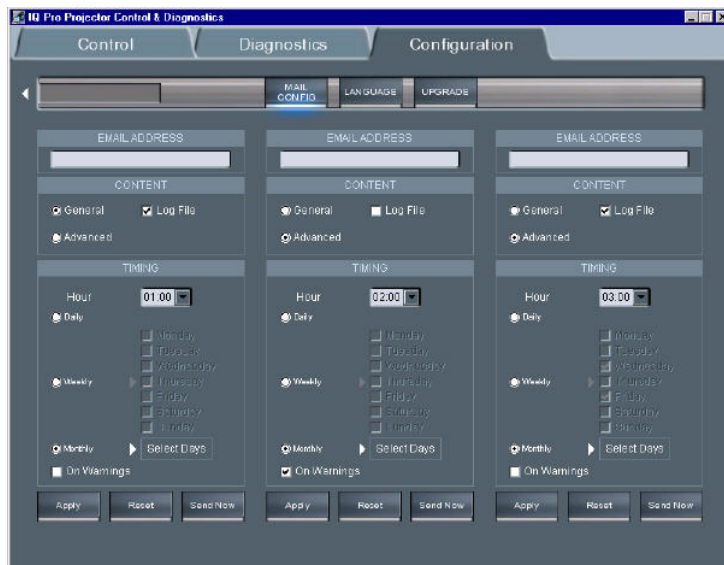

Image 9-25
mail configuration screen

3. set the content by clicking the desired content

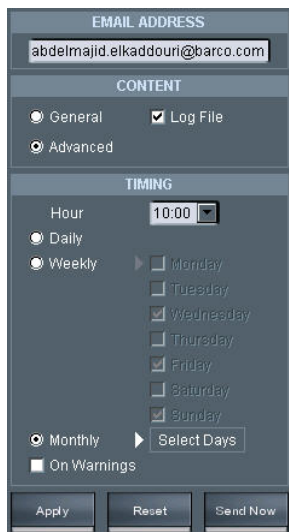

Image 9-26

4. set the timing by clicking the desired time interval

Note: if the timing is chosen to be monthly, a calendar is displayed, click the days on which the E-mail should be sent

Mail “from” configuration

The “from” field of the received mails i.e. the name of the sender (in this case the iQ Pro server) can be configured in the server software.

Therefore the E-mail address has to be filled in the *Networking* tab of the *iQ Control Server properties* dialogbox

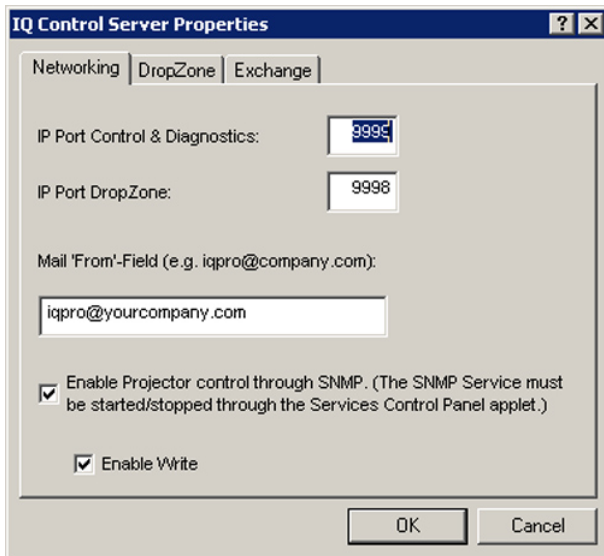

Image 9-27

9.3.3 Projector Firmware Upgrade

What can be done ?

The client software allows to do an upgrade of the projector's firmware.

The upgrade is done with a binary file (extension = ".bin") which is sent to the projector using the LAN connection.

Single projector as well as multiple projector (group) upgrade is possible

How to upgrade the firmware ?

1. Click on *Configuration* in the toolbar
2. Click on *Upgrade* to open the firmware upgrade screen

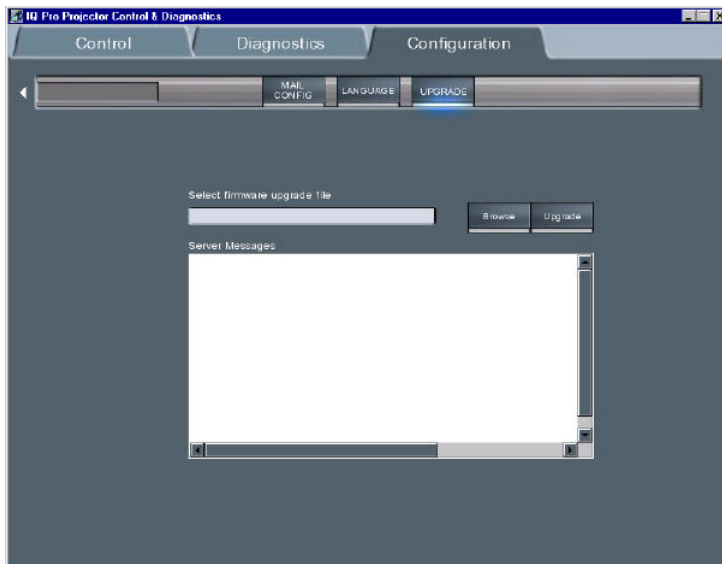

Image 9-28
upgrade interface

3. Use the **Browse** key to select the desired **bin** file.
4. Press the **Upgrade** button on the browser to select the file to start the operation

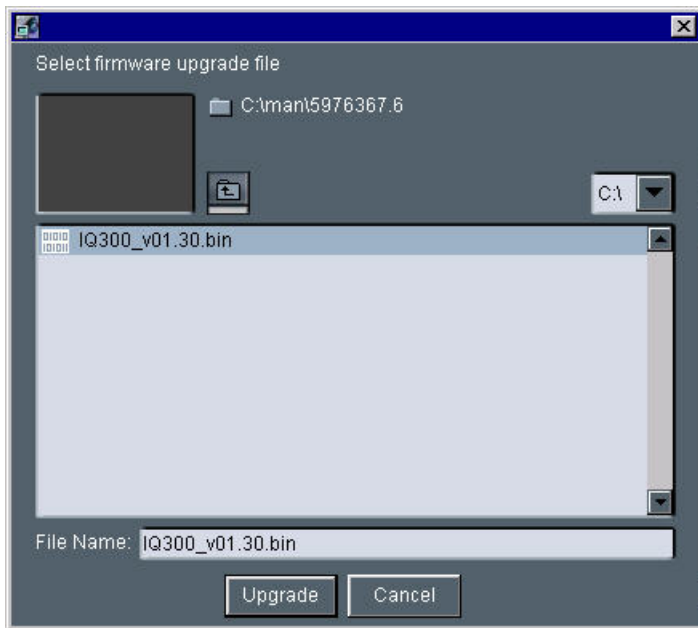

Image 9-29

5. Press the **Upgrade** button on the upgrade screen to start the operation
The information screen will show the progress of the operation.



If the download doesn't succeed please contact Barco

9.4 Remote desktop sharing (virtual meeting)

What can be done ?

The remote desktop sharing in the DropZone allows to visualize the projected image i.e. the desktop of the projector PC on a local PC.

Besides **Desktop sharing** one can take the **Control** (mouse and keyboard control) over a presentation (using Netmeeting™). The control over the presentation can be taken or passed at any time.

The configuration consisting of several remote or local meeting participants sharing the same information content is called a **virtual meeting**.

In this **virtual meeting** each meeting participant can participate to the meeting either in a passive way, by following the meeting on his local desktop (remote desktop sharing), or in an active way by controlling the server's desktop (mouse and keyboard).

Control over the desktop can be requested, forwarded or released.

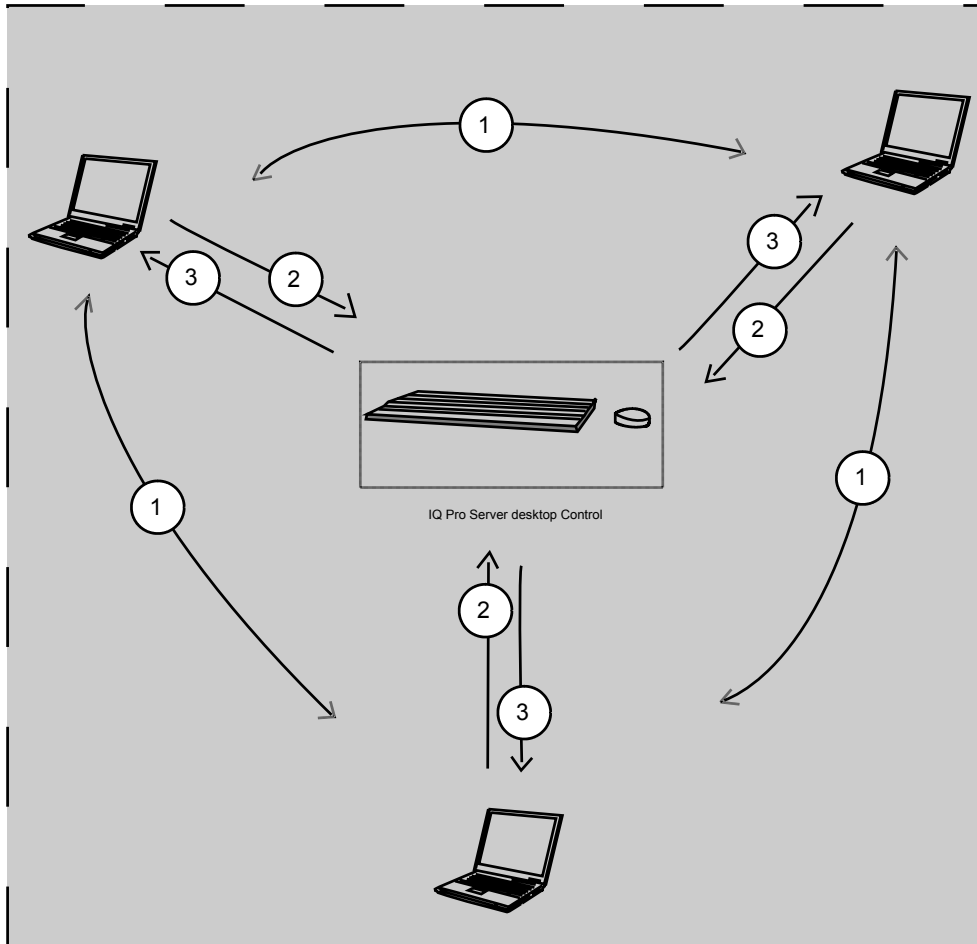

Image 9-30
Virtual Meeting

- 1 forward control
- 2 release control
- 3 request control

How to perform remote desktop sharing ?



- 1. Click on the middle button



The middle button indicates the activation of the remote

The desktop is displayed on the local PC monitor.

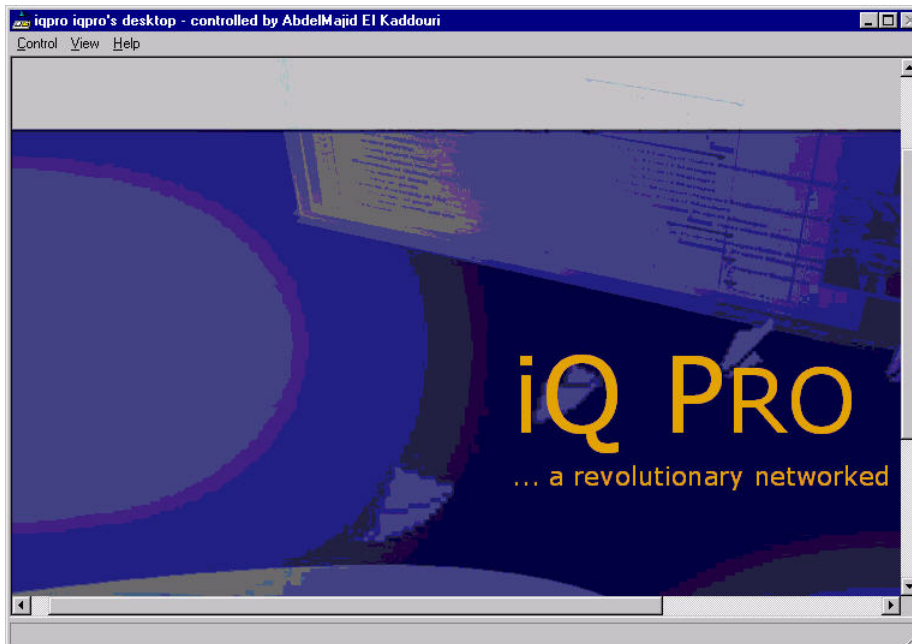

Image 9-31
remote desktop sharing in case of a PowerPoint™ presentation

How to take (mouse and keyboard)Control over the desktop ?

1. Click on the *Control* menu

The *Control* menu is displayed

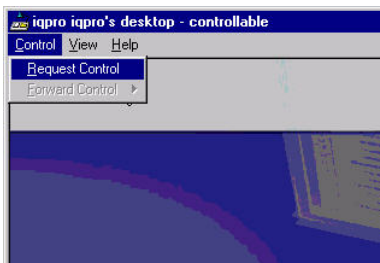

Image 9-32

2. Select the *Request Control* item

The desktop can now be remote controlled.



The control over the desktop is now done by the local PC. However, the user can at any time decide to release or forward the control to someone else.

How to release control over the desktop ?

1. Click on the *Control* menu

The *Control* menu is displayed

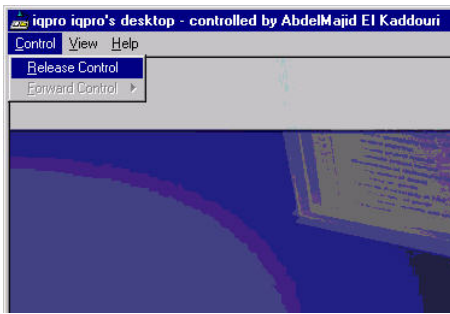

Image 9-33

2. Select the *Release Control* item

The desktop remote control can now be requested by someone else.

How to forward control over the desktop ?

1. Click on the *Control* menu

The *Control* menu is displayed

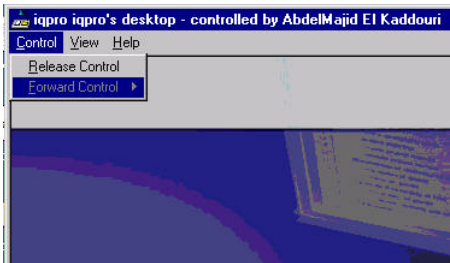

Image 9-34

2. Select the *Forward Control* item

A pop up menu shows the meeting participants i.e. the users which are connected to the server and which participate to the **Remote sharing** of the desktop.

3. Select the meeting participant

The control is transferred and the user which has the control is now indicated in the title bar.

9.5 The Web client

Web based functionality

The aim of the web services is to allow each network client within the LAN environment to browse via its internet browser to the web client.

This may be seen as an alternative to the client software since the main control & diagnostic tools are also present. Its advantage resides in the fact that no software has to be installed on the local PC, the internet takes while the html page generation is done locally on the server.

How to access the web client via the internet browser ?

To access the web client, the http link has to be filled in on the client's internet browser.

This http link contains the name of the projector/display i.e. the name under which it is identified within the LAN.

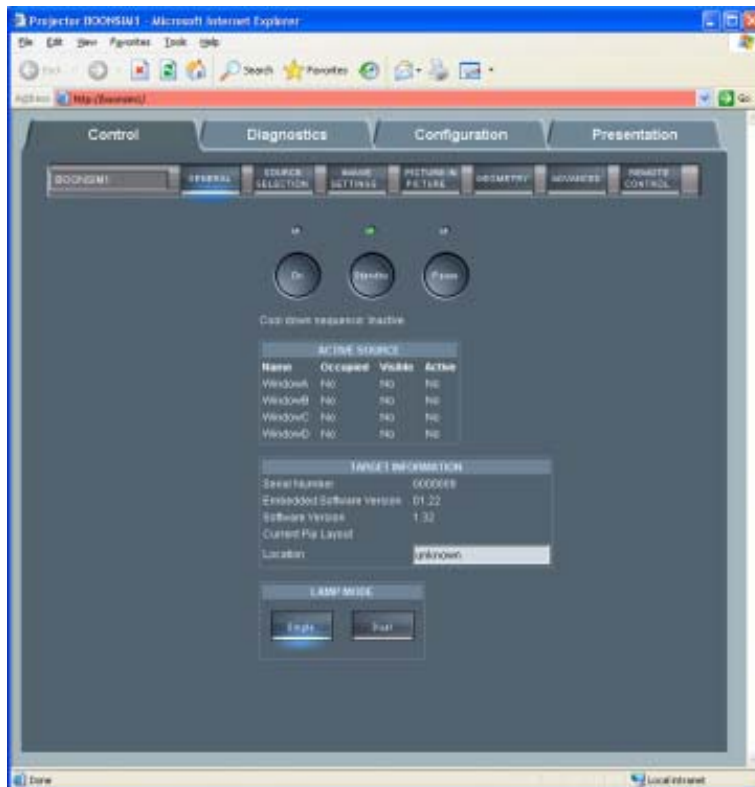

Image 9-35
Web interface

What can be done ?

The possibilities are mainly the same as on the client software.

The web interface allows a user friendly way to manage the projector/display, its use being straightforward and similar to the client interface (ref).

Requirements for the use of the Web client



Some components have to be installed or enabled on your local (client) operating system to allow access to the Web client.

See the Appendix “ General guidelines on network configuration” for general guidelines on how to enable these services. .



The minimal server software version should be V1.10 to allow the use of the Web client.

A. TROUBLESHOOT

A.1 Using the OSD

What can be done ?

The projector bus allows the diagnostic of different hardware components divided in two main groups.

- I²C diagnostics : a number of internal electronic boards can be diagnosed and a graphical interface shows whether an error is
- Lamps and power supply : lamp temperature and power related failures are logged and can be checked at any time.

How to display the I²C diagnostics menu ?

1. Press **MENU** to activate the Tool bar
2. Press → to select the *Tools* item
3. Press ↓ to Pull down the *Tools* menu
4. Use ↑ or ↓ to select *Diagnostics*
5. Press → to pull down the menu
6. Press **ENTER** to select I²C



Image A-1

A textbox is displayed

How to display the Lamps and power supply diagnostic menu ?

1. Press **MENU** to activate the Tool bar
2. Press → to select the *Tools* item
3. Press ↓ to Pull down the *Tools* menu
4. Use ↑ or ↓ to select *Diagnostics*
5. Press → to pull down the menu
6. Press **ENTER** to select *Lamps and power supply*



Image A-2

A textbox is displayed

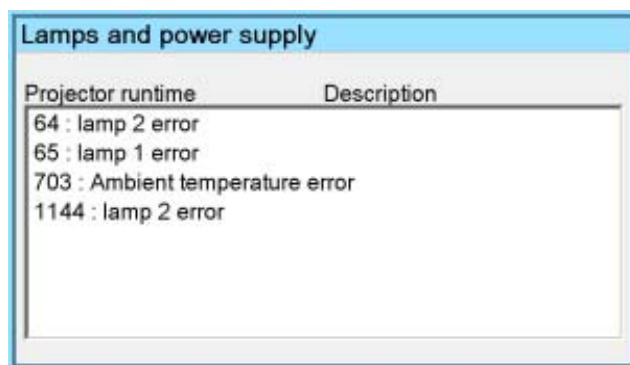

Image A-3



For Barco certified service technicians only: For more information on possible hardware failures refer to the Service Manual.

B. GENERAL GUIDELINES ON NETWORK CONFIGURATION

Overview

- General Network
- The Internet and Web services



The installation of the iQ Pro in a Local Area Network must be done in the same way as the installation of a standard PC in that particular network meaning that the same rules and accepted practice should be respected.

The assistance of qualified IT personnel is advised.

B.1 General Network



An Administrator password has been installed for security reasons (worm and virus protection):

Password : Barco (case sensitive !)

Microsoft NT Domain

To enable access to your network resources, the iQ Pro must be a member of your NT Domain.

This can be configured in the Control Panel, under "System", in the "Computer Name" tab, under the button "Network ID". You'll need some help from the Network Administrator, since you need special rights to do this.

TCP/IP

The iQ Pro uses TCP/IP networking, so it needs the IP address, network mask, broadcast address, gateway, dns, wins, etc. to be configured. This can be done in the Control Panel, under "Network Connections". This can however be configured automatically, if your network uses DHCP.

B.2 The Internet and Web services

Internet access

If you want to access the Internet from the iQ Pro, and the projector is located behind a firewall, you will also need to configure the proxy to use. This can be done in the Control Panel, under "Internet Options", in the tab "Connections", under the button "LAN Settings".

iQ Pro Web services

To use the iQ Pro web client, you might need to change the "LAN Settings" on your local computer

If the client thinks the projector is on the Internet, and tries to connect to it through the proxy, you can turn on the "Bypass proxy server for local addresses" feature, or add the projector to the Exceptions list under the "Advanced" button.

The "Internet Information Services(IIS)" component has to be installed on the operating system.

SNMP

To enable management via the IQProSNMP Agent, you must enable the SNMP system service, and configure the communities accordingly.

This can be done in the Control Panel, under Administrative Tools, in the Services, under the entry "Management and Monitoring tools". You may also need to enable SNMP in the iQ Pro Control Server in the system tray, see image below.

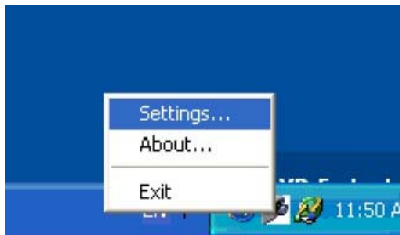

Image B-1
system tray

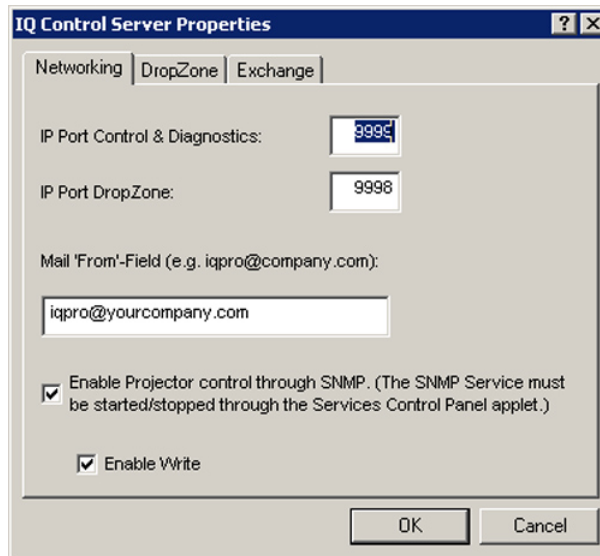

Image B-2
server settings dialog box



For more info, see "SNMP services", page 151

Microsoft Exchange and Outlook

To enable control via the Microsoft Exchange integration, you need to install, enable and configure the IQProEXCH module.

To enable control from Microsoft Outlook, you need to install, enable and configure the IQProEXCH module, and install an Outlook Form on the Exchange Server in your network.



For more info, see "Exchange", page 143

C. EXCHANGE

Introduction

Some parameters values are installation dependent, and are shown here as an example.

You may need assistance from you network administrator, IT Manager or MIS helpdesk to obtain the settings or to configure the projector for you, since this is a task description targeted to 'Administrators' and needs knowledge and/or permissions normally held by those persons.

It is advised that you first try to follow the procedure to obtain a working setup, before changing the settings for conforming to your local security requirements.

Use of this software requires a working Microsoft Exchange server installed somewhere in your corporate network.

C.1 Exchange Installation

C.1.1 Installation procedure

Creating a user account and mailbox

1. Create a user account in your NT Domain (on the projector).
The service will use this account to log on to the domain, and as credentials to authenticate to Microsoft Exchange to read the entries in the Calendar folder of the Mailbox.
Username: iqpro
Domain: BARCO
Password: pwiqpro
2. Create a Mailbox for the projector's account on the Microsoft Exchange Server (on your LAN).
The NT Domain user created in step 1 should have read access to this Mailbox.
Server: "BARCOEXCHSRV"
Mailbox: "Projector, IQPRO"
User: BARCO\iqpro

Installing and configuring Microsoft Outlook (on the projector)

1. Install Microsoft Outlook on the Projector.
Note: *To be able to access Microsoft Exchange, you need a Client Access License.*
Once you have one of those, you also have a license to Microsoft Outlook.
Refer to the following URL for more information: http://www.microsoft.com/resources/sam/licensing/cal_guide/exchange.asp
Tip: *Outlook can be installed from the Microsoft Exchange Server CDROM or from a Microsoft Office Suite Installation CDROM.*
Since the IQ Pro has no CDROM drive, you may need to use a CDROM drive shared from a PC in the network.
Alternatively, you could use a USB CDROM drive.
2. Make sure the projector is part of the domain
Tip: *This can be done in Control Panel->System->Computer Name->Change*
3. Log in on the projector as the user
User: iqpro
Domain: BARCO
Password: pwiqpro
Tip: *If the user cannot log on, the Local Administrator should add the right "Log on locally" for the user.*
This must be configured in Start->Control Panel->Administrative Tools->Local Security Policy
4. Configure Outlook
Profile Name: "MS Exchange Settings"
This is what the wizard proposes by default, and what is used in this document.
Default Mail Client: yes
Note: *Make sure that MS Outlook is the default Mail Client for this account.*
You can do this afterwards from this configuration page: Start->Control Panel->Internet Options->Programs->Email For more information, refer to :
<http://www.microsoft.com/mspress/troubleshooting/outlook/LS/101801.asp>

Enabling the account

1. Log on to the projector as an Administrator for the next steps.

For security reasons, you will probably not want to make the projector account part of one of the administrator groups.

2. Enable the account to be used by the "iQ Pro Exchange Integration" service
3. In the Tree of the "Local Security Settings" application, navigate to Security Settings->Local Policies->User Right Assignment.
4. In the List, edit the "Log on as a service", and add the account, in the example "BARCO\iqpro".

Installing and configuring the iQProEXCH service

Step 1,2,3 refers to the manual installation. One can use the SETUP.EXE program instead.

1. Copy the file IQProEXCH.EXE to (eg.) C:\Program Files\BARCO\iQ Pro Server
2. Open a command line, and go to the that directory
3. Type the following command IQProEXCH /Service
4. To configure, right click the "iQ Pro Server" tray icon, and go to the tab "Exchange"
Enter the credentials

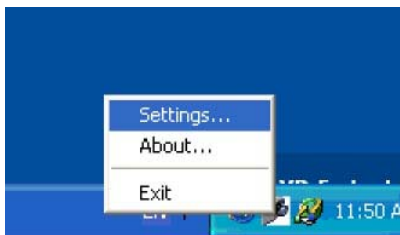

Image C-1
system tray



Image C-2
server exchange tab

5. To enable the "iQProEXCH" service go to Control Panel->Administrative Tools->Services->iQPro Exchange go to the TAB "General Startup" and Type: Automatic
Make the service use the correct account TAB Log On
Select "Local System Account"
Check "Allow service to interact with desktop"
6. Start the service, or reboot the projector.



You should now be able to schedule commands from a Microsoft Exchange client such as Outlook running on any computer on the local network, provided you have the necessary permissions on the Calendar in the projector mailbox.

C.1.2 Troubleshooting



The file C:\Program Files\BARCO\iQ Pro Server\iQProEXCH.log and the "Event Log" may contain helpful information to diagnose what's going wrong

What can go wrong and what to do ?

1. The log file contains "**Logon failure: unknown user name or bad password**"
Check Username, Password and Domain in Control Server/Exchange
2. The log file contains "**Logon failure: the user has not been granted the requested logon type at this computer.**"
The user account must be given the "**Log on as a service**" permission. This is done in Start/Control

Panel/Administrative Tools/ Local Security Settings/Security Settings/Local Policies/User Right Assignment. In the list, add the user to the entry "**Log on as a service**"

3. The log file contains "**Could not log on with Profile 'MS Exchange Settings'**" Make sure the profile exists. To check this, log in to the projector as the user (BARCO\iqpro), as the profile should be owned by the projector account, and Outlook-profiles are per-account. Start/Control Panel/Mail
4. The user cannot log on to the projector. The Administrator should add the right "**Log on locally**" for the user. This must be configured in the Start/Control Panel/Administrative Tools/Local Security Policy
In the list, add the user to the entry "**Log on as a service**"
5. When trying to start the service, the projector beeps, and the service stays in the 'starting' state
This happens when the service tries to display an error in a popup, but cannot access the desktop. Control Panel/Administrative Tools/Services/iQPro Exchange
Check "**Allow service to interact with desktop**"
You may need to end the process '**IQProEXCH**' from the task manager.
6. The commands are not executed at the right time
Check the time of the computer and the timezone Start/Control Panel/Date and Time/Timezone
7. An Outlook dialog box is displayed stating that there is no default mail client.
Make sure that MS Outlook is the default Mail Client for this account. You can do this from this configuration page: Start/Control Panel/Internet Options/Programs/Email
You may need to do this as administrator, since the service is started as 'Local System' account.
Tip: For more information, refer to <http://www.microsoft.com/mspress/troubleshooting/outlook/LS/101801.asp>

C.2 Exchange Integration

Introduction

The projector must be configured to connect to a mailbox on a Microsoft Exchange server in the network, which is dedicated to the projector, and to which of course the projector has rights to connect to.

The commands should be put in the SUBJECT of an appointment in the Exchange Calendar of the projector. The Start Time and End Time of the appointments are used for timing info. The other fields (location, categories, body, ...) are not used by the software, and thus can be used to store extra information for the USERS of the projector mailbox.

C.2.1 Command

How are the commands build up ?

- Command **filename/filepath**

The parameter **filename** is a filename relative to the "Receive" directory of the iQ Pro Control Server, which, in a default installation, would typically be the local folder "C:\Documents and Settings\All Users\Received" The parameter **filepath** is an absolute path to a file.

The commands should be put in the SUBJECT of an appointment in the Exchange Calendar of the projector. This is a mailbox on a Microsoft Exchange server in the network, which is dedicated to the projector, and to which of course the projector has rights to connect to.



The command and the filename are separated by a space.

Overview of the commands

- ON
- STANDBY
- PAUSE
- PAUSE ON
- PAUSE OFF
- LOGO
- LOGO ON
- LOGO OFF
- SWITCH SOURCE
- SWITCH LAYOUT
- LAUNCH ATTACHMENT
- STORE ATTACHMENT
- STORE **filename**
- STORE FILE **filepath**
- LAUNCH **filename**
- LAUNCH FILE **filepath**
- DELETE **filename**
- DELETE FILE **filepath**

ON, STANDBY

The projector is put in the specified state at the beginning of this event. Beware that if the SBC (Single Board Computer) is to be powered-down during STANDBY, that further events will not be processed, since the integration runs on that SBC.

PAUSE, LOGO

The projector is put in the specified state at the beginning of this event, and the state is undone at the end of this event. o A parameter ON or OFF can be specified to choose between the actions. This action will then be executed at the beginning. So "PAUSE from 12:00 to 13:00" is equivalent to "PAUSE ON at 12:00" + "PAUSE OFF at 13:00"

SWITCH SOURCE, SWITCH LAYOUT

The projector switches source or layout at the beginning of this event.

LAUNCH ATTACHMENT

The attachment is saved at the beginning of this event. Then the associated application is started. o At the end of the event, the application is killed. This can not be guaranteed if the application was already running on the projector. For example, if a web page is being displayed, and a second one is launched, the application is not started, but the original browser displays the page. In this case the second event can not control the browser. This is a limitation of the Windows platform.

STORE ATTACHMENT

The attachment is saved at the beginning of this event. The name of the attachment is used and the file is placed in the Receive folder.

STORE filename

The attachment is saved at the beginning of this event. The name filename is used and the file is placed in the Receive folder. For example "STORE MYFILE.PPS" will save the attached file to "C:\Documents and Settings\All Users\Received\MYFILE.PPS"

STORE FILE filepath

The attachment is saved at the beginning of this event. The path filepath is used as absolute filename. For example, the command "STORE FILE C:\My Videos\MYFILE.AVI" will store the attachment as C:\My Videos\MYFILE.AVI. This of course if permissions are correct and the directory C:\My Videos exists

DELETE filename

The file with name filename is deleted from the receive folder. For example "DELETE MYFILE.PPS" will delete "C:\Documents and Settings\All Users\Received\MYFILE.PPS"

DELETE FILE filepath

The file with absolute name filepath is deleted. For example, the command "DELETE FILE C:\My Videos\MYFILE.AVI" will store the attachment as C:\My Videos\MYFILE.AVI.

Drop down list

Besides the above commands some predefined commands can be selected from a drop down list in the iQPro tab.



Image C-3

C.2.2 Example

Schedule projector tasks in Microsoft Outlook 2000

following tasks are scheduled:

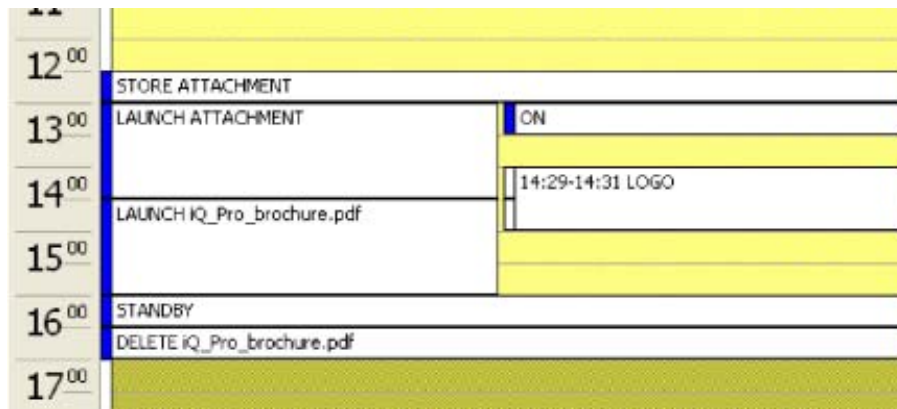

Image C-4

1. store attachment at 12:30 (The attached file is iQ_Pro_brochure.pdf)
2. turn the projector on at 13:00 and launch a different attached file
3. show the logo from 14:29 to 14:31 to hide the killing of the application and the starting of the PDF Viewer
4. at 14:30, launch the PDF file that was stored in step 1
5. kill the application and put the projector in standby at 16:00
6. delete the PDF file that was stored in step 1

C.2.3 Microsoft Outlook Integration

Adding Outlook forms

To make things easier for users, you can install an Outlook Form that adds a tab called "iQ Pro" to the appointment. The form contains the most-used commands in easy-to-use drop-down lists. It looks as follows:

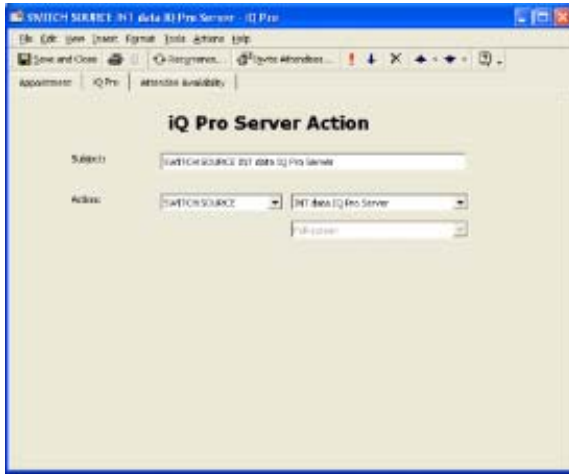

Image C-5

The form contains the functionality that a normal user should be able to use without consulting the documentation.

The attachments, date and time fields must be edited in the "Appointment" tab.

Choosing items from the drop-down boxes fills in the subject.

By default, the layouts "Full-screen" and "2by2 raster" are defined in the form.

If you add layouts on the projector(s) or change the defaults, the user must type the name of the layout in the subject.

The form can be modified to make things easier for users, one can also add the defined layouts to the drop-down list. This must be done from Outlook, in the menu "Tools->Forms->Design This Form"

Organizational Forms



The administrator should install Organizational Forms on the Exchange Server in the "Organizational Forms" library.

Default form

Now the form still needs to be set as a default for creating new items. When returning to the "Forms" tab in the "Calendar Properties" you should now see the "iQ Pro" template installed. Now go to the "General" tab and select the template as default for posting to the folder.



Image C-6

If the form was installed as an "Organizational Form", you need to select the "Forms..." entry, which will display the "Choose Form" dialog,

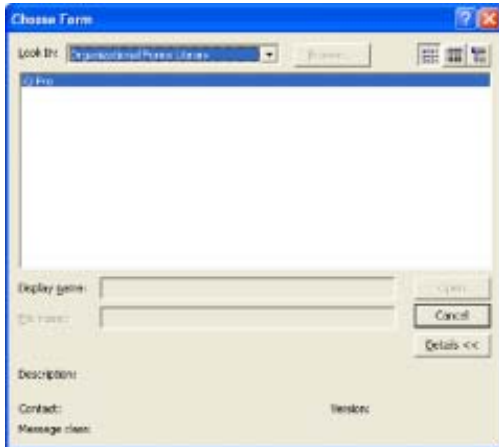

Image C-7

C.2.4 Folder form

Folder form

Alternatively, the form can be installed for the Calendar folder only, by following the procedure described below

How to configure a folder form

1. In Outlook, right-click on the "Calendar" icon in the "Outlook Shortcuts" tab in the "Outlook Bar" to open the "Properties" page, while logged-on as the projector (Or display the "Folder List", and right-click the "Calendar" folder to open the "Properties" page).
2. In the "Calendar Properties" dialog, go to the "Forms" tab, and click the "Manage..." button.



Image C-8

3. On the "Forms Manager" dialog, click the "Install..." button and select the file "iQ Pro.fdm".



Image C-9

4. When returning to the "Forms" tab in the "Calendar Properties" you should now see the "iQ Pro" template installed. Now go to the "General" tab and select the template as default for posting to the folder.



Image C-10

C.2.5 Limitations and known “problems”

Overlapping tasks

When launching 2 attachments with overlapping times it is possible for the application to exit at the end of the first period. For example, let's say we try to display PRES1.PPT from 12:00 to 13:30, and PRES2.PPT from 13:00 to 14:30, it is possible for BOTH presentations to exit at 13:30. This is because Windows uses the same process to display both files, and activates them via DDE.

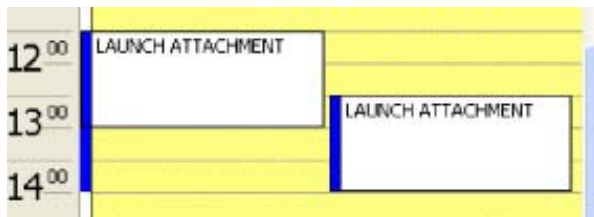

Image C-11



This is a limitation in the Microsoft Windows ShellExecuteEx API



Avoid overlapping schedules in this case, or change the associations in: My Computer->Tools->Folder Options->File Types->(extension)

Try to disable DDE (under Edit with the default action, eg 'open', selected) and/or disable 'Browse in same window' or using a different viewer/player for the file type.

D. SNMP SERVICES

Introduction

Some parameters values are installation dependent, and are shown here as an example.

You may need assistance from you network administrator, IT Manager or MIS helpdesk to obtain the settings or to configure the projector for you, since this is a task description targeted to 'Administrators' and needs knowledge and/or permissions normally held by those persons.

It is advised that you first try to follow the procedure to obtain a working setup, before changing the settings for conforming to your local security requirements.

D.1 SNMP installation

Introduction



The Control Server version should be at least version 1.10.

To check the version, open the about box from the server tray:

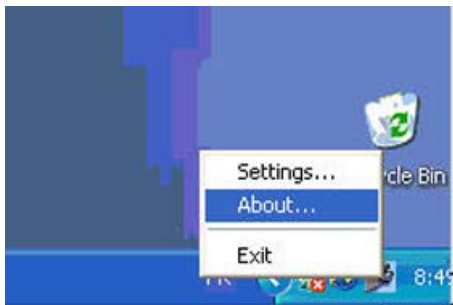

Image D-1

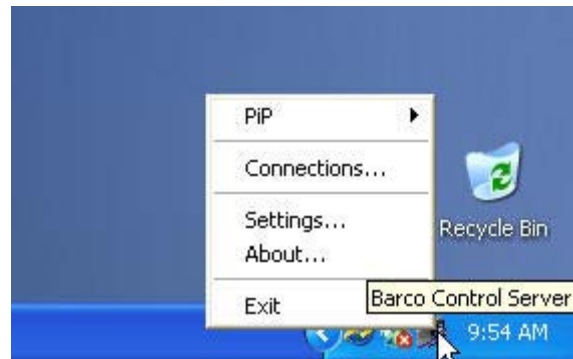

Image D-2



Image D-3

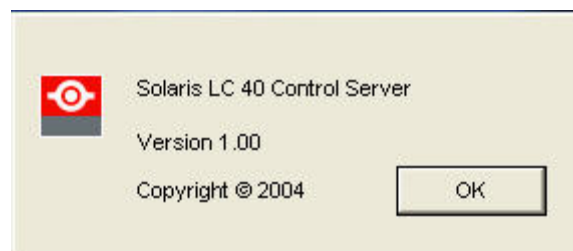

Image D-4



Software updates can be obtained from the BARCO support website: ftp://ftp.barco.com/pub/iq_pro_software/ or from secured website PartnerZone

How to install SNMP (only if necessary)

1. The Microsoft SNMP service must be installed
You may need to install this service from the Windows XP CDROM.
2. Install the SNMP Agent Extension dll **regsvr32 IQProSNMP.dll**
The agent should now be registered as "iqpro" under
HKEY_LOCAL_MACHINE\SYSTEM\CurrentControlSet\Services\SNMP\Parameters\ExtensionAgents

How to configure SNMP (only if necessary)

1. Go to the Control panel, under the Administrative Tools, in the Services, in the "SNMP" entry.
2. In the "General" tab, you can enable the service, and make it start automatically.

3. In the "Security" tab, the default Community is called 'public' and is read-only.
You may want to give read-write permission to 'public' (not recommended) or create a 'private' community with read-write permissions.
4. In the Control Server, enable the SNMP support, and optionally, enable read-write support.
5. The SNMP service should be restarted, to take the changed settings into account.



To uninstall the snmp agent: `regsvr32 /u IQProSNMP.dll`

D.2 SNMP integration

Commands

Following commands are provided stored in the MIB :

Command	Type
PROJECTORTYPE	READ
SERIALNUMBER	READ
LAMPPRODUCTNUMBER	READ
LAMP SERIALNUMBER	READ
SERVERTYPE	READ
SERVERVERSION	READ
EMBEDED SOFTWAREVERSION	READ
PROJECTORLANGUAGE	READ
PROJECTORNAME	READ
LOCATION	READ
ORIENTATION	READ
RESOLUTION	READ
DESKTOPRESOLUTION	READ
PROJECTORSTATE-cooldown	READ
PROJECTORSTATE-textbox	READ
PROJECTORSTATE-projector	READ/WRITE
PAUSE	READ/WRITE
FREEZE	READ/WRITE
PROJECTORRUNTIME	READ
LAMPWARNINGSTATUS	READ
LAMPALERTSTATUS	READ
LAMPMODE	READ/WRITE
LAMPRUNTIME	READ
LAMPSTATUS	READ
LAMPWARNINGTIME	READ/WRITE
I2CDIAGNOSTICS	READ

Command	Type
POWERSUPPLYERROR	READ
LAMPERROR	READ
PCSTATEPROJECTORON	READ/WRITE
PCSTATEPROJECTORSTANDBY	READ/WRITE
PCSTATE	READ/WRITE

E. MAINTENANCE

E.1 Cleaning the lens



To minimize the possibility of damage to optical coatings, or scratches to lens surfaces, we have developed recommendations for cleaning. **FIRST**, we recommend you try to remove any material from the lens by blowing it off with clean, dry deionized air. **DO NOT** use any liquid to clean the lenses.

Necessary tools

Toraysee™ cloth (delivered together with the lens kit). Order number : R379058.

How to clean the lens ?

Proceed as follow :

1. Always wipe lenses with a CLEAN Toraysee™ cloth.
 2. Always wipe lenses in a single direction.
Warning: *Do not wipe back and forwards across the lens surface as this tends to grind dirt into the coating.*
 3. Do not leave cleaning cloth in either an open room or lab coat pocket, as doing so can contaminate the cloth.
 4. If smears occur when cleaning lenses, replace the cloth. Smears are the first indication of a dirty cloth.
-



CAUTION: Do not use fabric softener when washing the cleaning cloth or softener sheets when drying the cloth.

Do not use liquid cleaners on the cloth as doing so will contaminate the cloth.



Other lenses can also be cleaned safely with this Toraysee™ cloth.

F. IMAGE FILES

F.1 Image files

Table overview

The following standard image files are pre-programmed in the projector.

Name ²	Resolution ³	Fvert Hz ⁴	FHor kHz ⁵	Fpix MHz ⁶	Ptot ⁷	Pact ⁸	Ltot ⁹	Lact ¹⁰
1600@48V	1600x600i	48,040	62,500	135,000	2160	1600	651	600
1600@60V	1600x900	60	56	119	2128	1600	932	900
1600@192	1600x600	96	63	135	2160	1600	651	600
1920x1440@60	1920x1440	60	90	234	2600	1920	1500	1440
CGA	640x200i	59,924	15,700	14,318	912	640	262	200
COMPUSC4	1024x480i	29,945	30,694	39,779	1296	1024	512	480
DOS3@56	640x400	56	24,800	21,030	848	640	440	400
EGA	640x350	59,702	21,851	16,257	744	640	366	350
ESVGA@75	832x624	73	47,900	53,648	1120	832	660	624
EXGA@60	1152x864	60	54,900	79,934	1456	1152	916	864
EXGA@80	1152x864	80,000	76,499	110,159	1140	1152	958	864
EXGA@85	1152x864	85,000	77,202	121,671	1576	1152	907	864
EXGA1@70	1152x864	70	63,800	94,424	1480	1152	912	864
EXGA2@70	1152x864	70	66,098	99,941	1512	1152	945	864
EXGA2@75	1152x864	75	75,199	110,092	1464	1152	1002	864
FMR	640x400i	42,323	36,440	28,570	784	640	431	400
GE@50	640x400	50	31,200	44,928	1440	1163	625	522
GE@60	1085x480	60	30,700	41,261	1344	1085	512	480
hd@1080i	1920x540	60	33,750	74,249	2200	1920	563	540
hd@24p	1920x1080	24,000	27,000	74,000	2750	1920	1125	1080
hd@24sf	1950x540	48,000	27,000	74,000	2750	1950	562	540
hd@25i	1920x540	50,000	28,125	74,000	2640	1920	562	540
hd@25p	1920x1080	25,000	28,125	74,000	2640	1920	1125	1080

2. Name: name of file, contains the settings.

3. Resolution: image resolution, when followed by ..i means interlaced.

4. Fvert Hz: vertical frame frequency of the source

5. FHor kHz: horizontal frequency of the source

6. Fpix MHz: pixel frequency

7. Ptot : total pixels on one horizontal line.

8. Pact: active pixels on one horizontal line.

9. Ltot: total lines in one field

10. Lact: active lines in one field.

F. Image files

Name ²	Resolution ³	Fvert Hz ⁴	FHor kHz ⁵	Fpix MHz ⁶	Ptot ⁷	Pact ⁸	Ltot ⁹	Lact ¹⁰
hd@30p	1920x1080	30,000	33,750	74,000	2200	1920	1125	1080
hd@60p	1280x720	60,000	45,000	74,000	1650	1280	750	720
INTER_GR	1184x886	67,170	61,796	92,941	1504	1184	920	886
IQPC_SXGA_2	1366x1024	59	62,933	106,230	1688	1366	1067	1024
IQPC_SXGA_D	1280x1024	60	63,857	107,791	1688	1280	1063	1024
IQPC_XGA_1	1024x768	61	49,005	65,863	1344	1024	807	768
IQPC_XGA_2	1024x768	60	48,485	65,164	1344	1024	807	768
IQPC_XGA_D	1024x768	61	49,005	65,863	1344	1024	806	768
MAC_3	512x384	60,147	24,480	15,667	640	512	407	384
MAC_5	512x342	60,158	22,259	16,670	704	512	370	342
MAC_6	832x624	74,546	49,722	57,280	1152	832	667	624
MAC_7	1024x768	74,907	60,150	80,000	1330	1024	803	768
MAC_POR	640x870	74,996	68,846	57,280	932	640	918	870
MXGA@100	1152x864	100	92,997	145,820	1568	1152	930	864
NTSC	675x240	60	15,748	13,512	858	675	263	240
NTSC_LIMO_x2	834x482	60	31,496	32,252	1024	834	525	482
PAL	675x286	50	15,625	13,500	864	675	313	286
PAL_LIMO_x2	834x574	50	31,250	32,000	1024	834	626	574
PAL_LIMO_x3	834x850	50	46,296	47,407	1024	834	926	850
PAL_LIMO_x4	834x1146	50	62,500	64,000	1024	834	1250	1146
PAM500	640x400	60,000	26,400	22,810	864	640	440	400
PAM800	1120x375i	44,936	36,443	50,000	1372	1120	406	375
PC98_2	1120x375i	39,994	32,835	47,840	1457	1120	411	375
PC98_3	1120x750	60,000	50,000	78,569	1571	1120	833	750
QXGA@56	2048x1536	56	89	247	2784	2048	1586	1536
QXGA@60	2048x1536	60	95	267	2800	2048	1589	1536
S1152@66	1152x900	66,004	61,846	94,500	1528	1152	937	900
S1152@76	1152x900	76,637	71,809	108,000	1504	1152	937	900
S1600@67	1600x1280	67	89,286	200,000	2240	1600	1334	1280
SDI_625	675x278i	25,000	15,625	13,500	864	720	313	278
SDI_525	675x240i	29,970	15,734	13,500	858	720	263	240
SG@50	1600x1200	50,000	62,500	130,313	2085	1600	1250	1200

Name ²	Resolution ³	Fvert Hz ⁴	FHor kHz ⁵	Fpix MHz ⁶	Ptot ⁷	Pact ⁸	Ltot ⁹	Lact ¹⁰
SG@60_1	1280x1024	60,000	63,900	107,352	1680	1280	1065	1024
SG@60_3	960x680	60,000	43,200	54,432	1260	960	720	680
SG@60_4	1600x1200	60,000	75,000	156,375	2085	1600	1250	1200
STOR@100	764x287	100	31,300	30,361	970	764	313	287
STOR@50	1024x512	50	31,300	40,064	1280	1024	625	512
STOR@60	1024x512	60	31,300	40,064	1280	1024	525	512
SUNews@76	1280x1024	76,107	81,130	135,000	1664	1280	1066	1024
SUP_MAC	1024x768	60,000	48,780	63,999	1312	1024	813	768
SVGA_@56V	800x600	56,250	35,156	36,000	1024	800	625	600
SVGA_@60V	800x600	60,317	37,879	40,000	1056	800	628	600
SVGA_@72_1	800x600	72,084	48,080	50,003	1040	800	666	600
SVGA_@75	800x600	75,000	46,875	75,000	1056	800	625	600
SVGA_@85	800x600	85,000	53,635	56,250	1048	800	631	600
SXGA_@72_1	1280x1024	72	76,699	128,854	1680	1280	1061	1024
SXGA_@72_2	1280x1024	72	76,970	130,080	1690	1280	1069	1024
SXGA_@75	1280x1024	75	79,974	134,997	1688	1280	1066	1024
SXGA_@76	1280x1024	76	81,103	134,955	1664	1280	1066	1024
SXGA_@85	1280x1024	85	91,149	157,506	1728	1280	1072	1024
SXGA_L	1280x1024	60	62,500	84,000	1344	1280	1041	1024
SXGA+1_60	1400x1050	60	63,980	107,997	1688	1400	1066	1050
SXGA+2_60	1400x1050	60	65	123	1880	1400	1087	1050
SXGA2@60	1280x960	60	59,999	107,998	1800	1280	1000	960
SXGA2@85	1280x960	85	85,940	148,505	1728	1280	1011	960
SXGA@50	1280x1024	50	52,351	88,368	1688	1280	1047	1024
SXGAP@70	1024x1280	70	92,902	133,779	1440	1024	1326	1280
SXGAP2@60	1024x1280	60	79,498	110,661	1392	1024	1325	1280
UXGA@60	1600x1200	60	75,002	162,004	2160	1600	1250	1200
UXGA@70	1600x1200	70	87,497	188,993	2160	1600	1250	1200
UXGA@75	1600x1200	75	93,747	202,494	2160	1600	1250	1200
UXGA@85	1600x1200	85	106,247	229,494	2160	1600	1250	1200

F. Image files

Name ²	Resolution ³	Fvert Hz ⁴	FHor kHz ⁵	Fpix MHz ⁶	Ptot ⁷	Pact ⁸	Ltot ⁹	Lact ¹⁰
UXGAP1@59	1200x1600	59	95,804	119,946	1252	1200	1620	1600
UXGAP2@60	1200x1600	60	99,404	163,817	1648	1200	1656	1600
VGA@60	640x480	60	31,326	25,061	800	640	525	480
VGA@66	640x480	67	35,100	30,326	864	640	525	480
VGA@73	640x480	73	37,860	31,500	832	640	520	480
VGA@75	640x480	75,000	37,500	31,500	840	640	500	480
VGA1@85	640x480	85,000	43,369	36,000	832	640	509	480
VGA75ISO	640x480	75,000	39,375	31,500	800	640	525	480
VIDEO525	1302x239i	29,970	15,734	32,207	1302	1024	263	239
VIDEO625	1024x278i	25,000	15,625	31,984	1310	1024	313	278
WSXGA@60	1600x1024	60	64	137	2144	1600	1060	1024
WSXGA+@60	1680x1050	60	79	178	2272	1680	1304	1050
WUXGA@60	1920x1200	60	75	194	2592	1920	1245	1200
WUXGA_2@60	1920x1200	60	89	234	2624	1920	1490	1200
XGA@43	1024x384	87	35,500	44,872	1264	1024	409	384
XGA@60	1024x768	60,000	48,360	64,996	1344	1024	806	768
XGA@70_1	1024x768	70,000	56,475	74,999	1328	1024	806	768
XGA@70_2	1024x768	70,000	57,052	78,047	1368	1024	815	768
XGA@72	1024x768	71,955	58,140	80,000	1376	1024	808	768
XGA@75_1	1024x768	75	60,024	78,752	1312	1024	800	768
XGA@85	1024x768	85,000	68,680	94,500	1376	1024	808	768
XGA@87	1024x768	43	36	45	1264	1024	817	768
XGA@75_GS	1024x768	74,534	59,701	79,284	1328	1024	801	768

Table F-1

INDEX

A

address 35
 RCU 35
 Address 36
 Projector address 36
 AGC 96
 Auto Image 106
 automatic startup 43

B

brightness 84

C

cable basket 16
 removal 16
 Cleaning 155
 Lens 155
 color 85
 configuration 48
 server 48
 connection 26–29
 Component video 28
 computer 29
 RGB 27
 S-Video 26
 connections 24
 input 24
 output 24
 Connections 21
 contrast 84
 Control 119
 description 119
 Controls overview 30

D

desktop 57, 59–60, 64, 71–72, 74
 add window 57
 configuration 74
 polling 74
 renaming 74
 examples 59
 management 72
 projector controls 72
 projector menu 71
 open 71
 window 60, 64
 image adjustments 64
 menu 60
 window manipulation 60
 Desktop 71
 Management 71
 desktop management 71
 menu 71
 projector 71
 Digital 29
 DVI 29
 display 112
 synchronous 112
 dropzone 67
 dropping 67

E

exchange 143–144, 147
 example 147
 installation 143
 troubleshooting 144
 Exchange 145

exchange integration 149
 folder form 149

F

File 107, 109–111
 copy 110
 delete 111
 edit 107
 rename 109
 save 109
 files 157
 firmware 132
 upgrade 132
 freeze 82

G

gain control 97
 manual 97
 gamma 86
 general 81
 getting started 57, 61, 66
 desktop 57, 66
 creating 57
 save 66
 windows 61
 manipulations 61
 guidelines 141
 general network config 141
 Network 141

I

Identification 82
 image 84, 87, 91
 Color temperature 91
 noise reduction 87
 settings 84
 image file 64
 controls 64
 image files 103
 introduction 103
 Image files 103, 157
 image setup 83
 Input 29
 Input source connection 29
 DVI 29
 input balance 93
 input boards 25
 installation 11, 13, 15, 17–18, 21, 24, 26, 35, 37, 143
 address 35
 configuration 17
 configurations 17
 connection 21, 26
 composite video 26
 power 21
 connections 24
 signal 24
 guidelines 11
 lens 15
 lens adjustments 37
 positioning 18
 procedure 143
 RCU 15
 setup 37
 orientation 37
 installation guidelines 12
 network 12
 Installation guidelines 11
 guidelines 11
 Safety 11

safety warnings 11
 Introduction 5, 117

L

lamp 97–98, 100–102
 error 101
 clear 101
 history 100
 mode 98
 reset runtime 100
 runtime 102
 warning 102
 runtimes 97
 lens 16
 range 16
 Lens 155
 Cleaning 155
 Lenses 17
 formulas 17
 Load file 104–105
 logon 57

M

Maintenance 155
 manual 5
 use 5
 menu 97
 lamp 97
 Menu 36, 77, 88, 92, 107, 109–111, 113
 Image files menu 107, 109–111
 copy file 110
 custom file 109
 delete file 111
 edit file 107
 rename file 109
 Image menu 88, 92
 aspect ratio 88
 filmmode detection 92
 Installation 36
 projector address 36
 Installation menu 113
 textbox 113
 Using the dialog boxes 77
 menu bar 113
 Menu structure 77
 Using the dialog boxes 77
 menus 77

N

network 12, 45, 53–54, 68, 121, 128, 133, 136, 141
 additional config info 141
 configuration 45
 control 121, 128
 advanced 128
 general 121
 interface 121
 source selection 121
 dropzone 133
 remote desktop sharing 133
 Dropzone 68
 file manager 68
 DropZone 53–54
 settings 53
 start up 54
 web 136
 Network 44, 117–119, 122, 126, 128–131
 architecture 117
 configuration 130–131
 E-mail 130–131
 control 128–129
 advanced lens adjustments 128
 advanced options 129

Control manager 122, 126
 image settings 126
 PiP 122
 functionality 118
 installing 44
 software 44
 Projector 119
 control 119
 Network centric visualisation 6
 Network management 117

O

OSD 77, 81
 general 81
 outlook integration 150
 limitations 150
 outlook intagratin 147

P

packaging 7
 parameter 145
 list 145
 pause 81
 phase 86
 power up 33
 projector 33
 preferences 41

R

representation 112
 synchronous 112

S

S-Video 79
 serial comms 39
 baudrate 39
 server 22, 40
 Connections 22
 setup 33, 39–43, 83
 automatic startup 43
 baudrate 39
 image 83
 language 41
 quick access keys 42
 server 40
 sharpness 85
 signal 44
 background 44
 sliderbox 114
 SNMP 151–152
 installation 151
 integration 152
 source 78
 selection 78
 source selection 78–80
 composite video 78
 PC 80
 RGB-YUV 79
 Source selection 81
 DVI 81
 Source Selection 78
 specifications 119
 server 119
 start up 34, 57
 projector 34, 57
 status bar 114

T

Textbox 113

tint 85
troubleshoot 139
 OSD 139

U
Unpacking 7

LIST OF IMAGES

1-2	Network centric architecture	6
2-1	Projector packaging	8
4-6	On-Axis projector installation	19
4-7	Off-Axis projector installation	20
4-10	Server section	22
4-11	Server connections	23
4-12	Typical server connection	23
4-14	Input section of the Icon : default configuration	25
4-15	RGB analog input board	25
4-16	DVI digital input board	25
4-17	DVI output board	26
4-20	RGB source connection	28
5-3	Standby state : L3 is red	34
5-24	Control interface	45
5-26	projector list: contains a projector and a projector group sub list	46
5-29	connected and active projector	48
5-39	client-server soft incompatibility	52
5-45	installation menu	55
6-1	The Startup menu in Windows	57
6-2	Desktop source selection menu representing also the standard input configuration (L1,L2,L3 input layers installed)	58
6-8	positioning a video window	61
6-9	free sizing a video window	62
6-10	Data (RGB) and Video (S-Video) displayed at native resolution	62
6-11	Video source in Full screen representation	63
6-12	Re-sizing of a video window with unlocked aspect ratio	63
6-13	Source rename dialog box	64
6-14	Image controls dialog box	64
6-15	Image file controls	65
6-16	image file controls: cursor on scroll bar	65
6-17	Start pixels: wrong setting	65
7-4	The projector control menu	73
8-22	Common non- anamorphic aspect ratios in DVD sources	88
8-23	Anamorphic aspect ratios in DVD sources	88
8-24	Possible aspect ratio settings and their effect on different sources	89
8-32	film to video conversion: 2/2 and 2/3 pull down method	92
8-46	Single mode operation: switching principle	99
9-1	Typical iQ Pro network architecture	118
9-2	point to point iQ Pro network communication	119
9-3	control & management of network centric projector(s)	120
9-4	The control interface: the general sub screen is active (see tool bar)	121
9-5	The source selection screen	122
9-6	PIP screen	123
9-10	Add window dialog box	124
9-20	the Advanced control submenu	128
9-22	The advanced Options screen	129
9-25	mail configuration screen	131
9-28	upgrade interface	132
9-30	Virtual Meeting	134
9-31	remote desktop sharing in case of a PowerPoint™ presentation	135
9-35	Web interface	137
B-1	system tray	142
B-2	server settings dialog box	142
C-1	system tray	144
C-2	server exchange tab	144

Free Manuals Download Website

<http://myh66.com>

<http://usermanuals.us>

<http://www.somanuals.com>

<http://www.4manuals.cc>

<http://www.manual-lib.com>

<http://www.404manual.com>

<http://www.luxmanual.com>

<http://aubethermostatmanual.com>

Golf course search by state

<http://golfingnear.com>

Email search by domain

<http://emailbydomain.com>

Auto manuals search

<http://auto.somanuals.com>

TV manuals search

<http://tv.somanuals.com>