

BarcoSLM G10 Performer



Owners Manual

R9010000

R5976562/03
20/10/2004

BARCO

Visibly yours

Barco nv Events

Noordlaan 5, B-8520 Kurne

Phone: +32 56.36.89.70

Fax: +32 56.36.88.24

E-mail: events@barco.com

Visit us at the web: www.barco.com

Printed in Belgium

Changes

Barco provides this manual 'as is' without warranty of any kind, either expressed or implied, including but not limited to the implied warranties or merchantability and fitness for a particular purpose. Barco may make improvements and/or changes to the product(s) and/or the program(s) described in this publication at any time without notice.

This publication could contain technical inaccuracies or typographical errors. Changes are periodically made to the information in this publication; these changes are incorporated in new editions of this publication.

Copyright ©

All rights reserved. No part of this document may be copied, reproduced or translated. It shall not otherwise be recorded, transmitted or stored in a retrieval system without the prior written consent of Barco.

Federal Communications Commission (FCC Statement)

This equipment has been tested and found to comply with the limits for a class A digital device, pursuant to Part 15 of the FCC rules. These limits are designed to provide reasonable protection against harmful interference when the equipment is operated in a commercial environment. This equipment generates, uses, and can radiate radio frequency energy and, if not installed and used in accordance with the instruction manual, may cause harmful interference to radio communications. Operation of this equipment in a residential area may cause harmful interference, in which case the user will be responsible for correcting any interference.

Trademarks

Brand and product names mentioned in this manual may be trademarks, registered trademarks or copyrights of their respective holders. All brand and product names mentioned in this manual serve as comments or examples and are not to be understood as advertising for the products or their manufactures.

TABLE OF CONTENTS

1. Safety Instructions	5
1.1 Warnings	5
1.2 FCC statement	5
1.3 Note	5
2. Packaging and Dimensions	7
2.1 Projector Packaging	7
2.2 Box Content	7
2.3 Lamp Packaging	8
2.4 Lens Packaging	8
2.5 Projector Case	8
3. Installation Guidelines	11
3.1 General	11
3.2 Configuration	12
3.3 Safety Area around projector	14
3.4 Projector tilting	16
3.5 Mounting the projection lamp	16
3.5.1 Access to the Lamp Unit	17
3.5.2 Installation of the new Lamp Unit	17
3.5.3 Reinstalling the Side Panel	19
3.6 Re-adjusting the lamp position in the lamp casing	20
3.7 Lenses	22
3.7.1 Lenses	22
3.7.2 Lens selection	23
3.7.3 Lens formulas	23
3.7.4 Lens Installation	24
3.7.5 Cleaning the lens	24
3.8 Battery Installation in the RCU	25
3.9 Stacking Projectors	25
3.10 Rigging points and Accessories	28
4. Connections	31
4.1 Power connection	31
4.2 Switching on	31
4.3 Switching to standby	33
4.4 Switching off	33
4.5 Input Source Connections	33
4.5.1 Input Facilities	33
4.5.2 Inputs via RCVD505	33
4.5.3 Input module insertion	34
4.5.4 Fixed slot (slot 1 & 2)	35
4.5.5 Serial Digital Input (slot 3 & 4)	36
4.5.6 HD SDI Digital input (slot 3 & 4)	37
4.5.7 Digital Video Decoder Input	38
4.6 Communication Connections	40
4.6.1 RS232 (RS422) Connection	40
4.6.2 Linked System	40
4.6.3 Communication with peripherals	43
4.6.4 Network connection	43
5. Getting Started	45
5.1 RCU & Local keypad	45
5.2 Terminology overview	45
5.3 Operating the projector	46
5.3.1 Switching on	46
5.3.2 Switching to standby	47
5.3.3 Switching off	47
5.3.4 Temperature error DMD	47
5.4 Quick Set Up Adjustments	48
5.4.1 Quick Language Change	48
5.4.2 Quick Lens Adjustment	48
5.4.3 Quick On Screen Color change	49
5.5 Using the RCU	50
5.6 Projector Address	52
5.6.1 Controlling the projector	52
5.6.2 Displaying and Programming addresses	53
5.7 Controlling the Projector	53
6. Start up of the Adjustment mode	55
6.1 Start up	55
6.2 Password	55
6.3 Menus on Local LCD Display	56

7. Random Access Adjustment Mode	57
7.1 Overview Flow	57
7.2 Picture Services	58
7.2.1 File annotation	58
7.2.2 Possible file manipulations	58
7.2.3 Start up	59
7.2.4 Load file	59
7.2.5 Edit File	60
7.2.5.1 Start up	60
7.2.5.2 Changing the settings	61
7.2.5.3 Correct value	61
7.2.6 Rename	64
7.2.7 Copy	65
7.2.8 Delete	65
7.2.9 File Options	66
7.3 Picture Tuning	67
7.3.1 Start up	67
7.3.2 CTI	67
7.3.3 Color Temperature	68
7.3.4 Gamma	68
7.3.5 Decoding	69
7.3.6 Dynamic Color Depth	69
7.3.7 Noise Reduction	70
7.3.8 Input Balance	70
7.3.8.1 Input Balance for RGB input signals	71
7.3.8.2 Input Balance for YUV signals	72
7.3.8.3 Returning to the factory defaults	72
7.4 Geometry	73
7.4.1 Introduction	73
7.4.2 Geometry start up	73
7.4.3 Shift	73
7.4.4 Size	74
7.4.5 Side Keystone	75
7.4.6 Blanking	76
7.4.7 Aspect Ratio	77
7.4.8 Geometry Options	78
7.5 ScenergiX	78
7.5.1 Order information	79
7.5.2 Introduction	79
7.5.3 Preparations	80
7.5.4 ScenergiX	80
7.5.5 ScenergiX overlap zone (horizontal scenergiX)	80
7.5.6 ScenergiX overlap zone (vertical scenergiX)	81
7.5.7 ScenergiX size adjustment	82
7.5.8 Adjusting the black level of the images	84
7.6 Picture in Picture (PiP)	85
7.6.1 Introduction to PiP	85
7.6.2 Picture in Picture activation	86
7.6.3 Picture in Picture source	86
7.6.4 Position of Picture in Picture window	86
7.6.5 Set up of the Quick Selection	87
7.7 Save Changes	87
8. Installation Mode	89
8.1 Start up of the Installation mode	89
8.2 Input Slots	89
8.3 800 peripheral	91
8.3.1 Defining the output module of the RCVDS05	91
8.3.2 Defining the Infrared Communication protocol	91
8.3.3 CLO using Comm 800	92
8.4 Source Switching	92
8.5 No Signal	93
8.5.1 Changing the Background Color	93
8.5.2 Changing the Shutdown Setting	94
8.5.3 Changing the Shutdown Time	94
8.6 Contrast Enhancement	94
8.7 Convergence	95
8.8 Configuration	95
8.9 Lens Adjustment	96
8.10 Quick Access Keys	98
8.11 OSD	99
8.11.1 Color Settings	99
8.11.2 Menu Position	99
8.12 Internal Patterns	99

9. Service Mode	101
9.1 Built-up	101
9.2 Start up	101
9.3 Identification	101
9.4 Password	102
9.4.1 Change Password	102
9.4.2 Access Control List	103
9.5 Changing Language.....	105
9.6 Change Projector Address.....	105
9.7 Serial Communication.....	106
9.7.1 Start Up of the Serial Communication	106
9.7.2 Baud rate Setting	107
9.7.3 Setting up the Interface Standard	107
9.7.4 RS422 Termination	108
9.8 Network Configuration	108
9.9 Lamp.....	109
9.10 Dimming	112
9.11 BARCO Logo.....	113
9.12 Add-Ins	114
9.13 Preset Input Balance	114
9.14 Advanced Processing	115
9.14.1 Minimum Delay	115
9.15 Diagnosis	116
9.15.1 How to start up the Diagnosis?.....	116
9.15.2 I ² C Diagnoses	116
9.15.3 Formatter.....	117
9.15.4 SMPS	117
9.15.5 LPS (lamp power supply).....	117
9.15.6 Voltages.....	118
9.16 Factory defaults	118
10. Programmable Function Keys	119
10.1 Function Keys	119
A. Standard Source set up Files	121
A.1 Table overview	121
B. Cleaning the dust filters	125
B.1 Dust filter on the front side	125
B.2 Dust filter on the back side.....	128
B.3 Dust filter on the bottom side	129

1. SAFETY INSTRUCTIONS

1.1 Warnings

To prevent personnel injury

The customer should never attempt to disassemble the lamp casing or to dispose of the lamp casing other than by returning it to BARCO.

To prevent injuries and physical damage, always read this manual and all labels on the system before connecting to the wall outlet, or adjusting the projector.

To prevent injuries, take note of the weight of the projector. Minimum 4 persons are needed to carry the projector.

NEVER look into the lens ! Due to the high luminance damage to the eye can happen.

Before attempting to remove the projector's cover, you must turn off the projector and disconnect from the wall outlet.

When performing set up work at a ceiling mounted projector, to prevent injury caused by falling objects or the system, set out a keep out area.

Consult a professional structural engineer prior to suspending the ceiling mount from a structure not intended for that use. Always ensure the working load limit of the structure supporting the projector.

The power input at the projector side is considered as the disconnect device. When mentioned to switch of the projector, to access some parts inside, always disconnect the power cord at the projector side.

To prevent projector damage

If the Air Filters are not regularly replaced, the air flow inside the projector could be disrupted, causing overheating. Overheating may lead to the projector shutting down during operation.

In order to ensure that correct airflow is maintained, and that the projector complies with Electromagnetic Compatibility requirements, it should always be operated with all of it's covers in place.

Ensure that nothing can be spilled on, or dropped inside the projector. If this does happen, switch off and unplug the mains supply immediately. Do not operate the projector again until it has been checked by qualified service personnel.

The projector must always be mounted in a manner which ensures free flow of air into its air inlets and unimpeded evacuation of the hot air exhausted from its cooling system. Heat sensitive materials should not be placed in the path of the exhausted air.

Special care should be used when DLP projectors are used in the same room as performant laser equipment. Direct or indirect hitting of a laser beam on to the lens can severely damage the Digital Mirror Devices (TM) in which case there is a loss of warranty

To prevent battery explosion

Danger of explosion if battery is incorrectly replaced.

Replace only with the same or equivalent type recommended by the manufacturer.

Dispose of used batteries according to the manufacturer's instructions.

1.2 FCC statement

Federal Communication Commission (FCC Statement)

This equipment has been tested and found to comply with the limits for a class A digital device, pursuant to Part 15 of the FCC rules. These limits are designed to provide reasonable protection against harmful interference when the equipment is operated in a commercial environment. This equipment generates, uses, and can radiate radio frequency energy and, if not installed and used in accordance with the instruction manual, may cause harmful interference to radio communications. Operation of this equipment in a residential area may cause harmful interference, in which case the user will be responsible for correcting any interference.

1.3 Note

Definitions

Definition Qualified service technicians or Qualified technicians : Persons having appropriate technical training and experience necessary to be aware of hazards to which they are exposed in performing a task and of measures to minimize the danger to themselves or other persons.

1. *Safety Instructions*

Extra Safety manual

Read also safety instructions in separate manual (**R5976125**).

2. PACKAGING AND DIMENSIONS

Overview

- Projector Packaging
- Box Content
- Lamp Packaging
- Lens Packaging
- Projector Case

2.1 Projector Packaging

Way of Packaging

The projector is packed in a carton box. To provide protection during transportation, the projector is surrounded with foam. The package is secured with banding and fastening clips.

To unpack

1. Release the fastening clips.
2. Remove the banding. Handle as shown in the drawing. (image 2-1)
3. Take the projector out of its shipping carton and place it on a table.

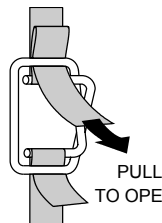

Save the original shipping carton and packing material, they will be necessary if you ever have to ship your projector. For maximum protection, repack your projector as it was originally packed at the factory.



CAUTION: Never transport the projector with the lens mounted on it !
Always remove the lens before transporting the projector.

2.2 Box Content

Content

- 1 projector BARCO SLM G10 (weight \pm 56 kg or 123.5 lbs)
- 1 remote control unit RCU + 1 battery.
- 1 European and 1 American power cable.
- 1 Terminator for linked CLO
- 1 owners manual
- 1 safety manual

2.3 Lamp Packaging

Way of packaging

As it is not allowed to transport the projector with the lamp mounted inside the projector, this lamp is packed in a separate carton box. Save this carton box, it can be used to repack the lamp when you ever have to transport your projector.

2.4 Lens Packaging

Way of Packaging

Lenses are supplied as an individual item. They are packed in a carton.

2.5 Projector Case

Dimensions

The dimensions are given in mm

25.4mm = 1 inch

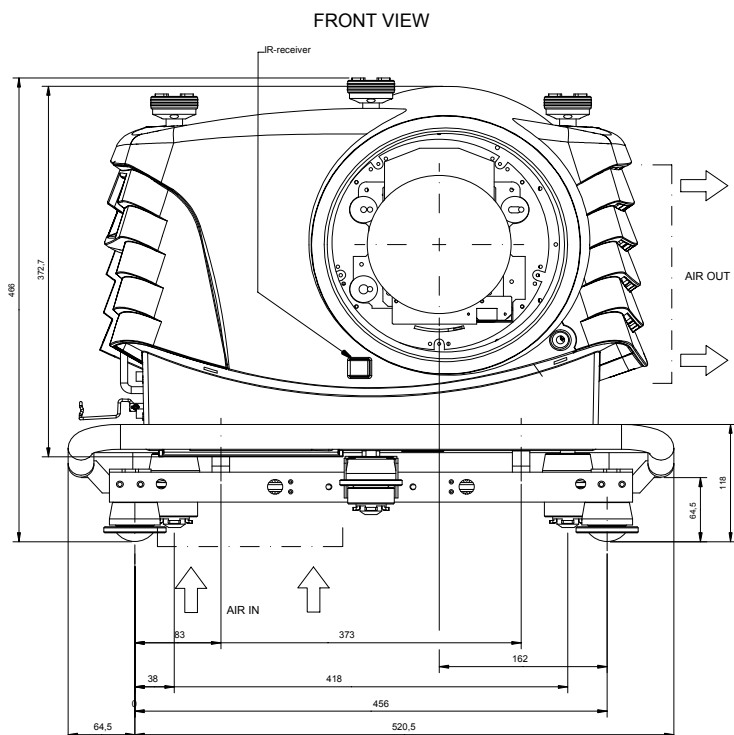

Image 2-2
Front view dimensions

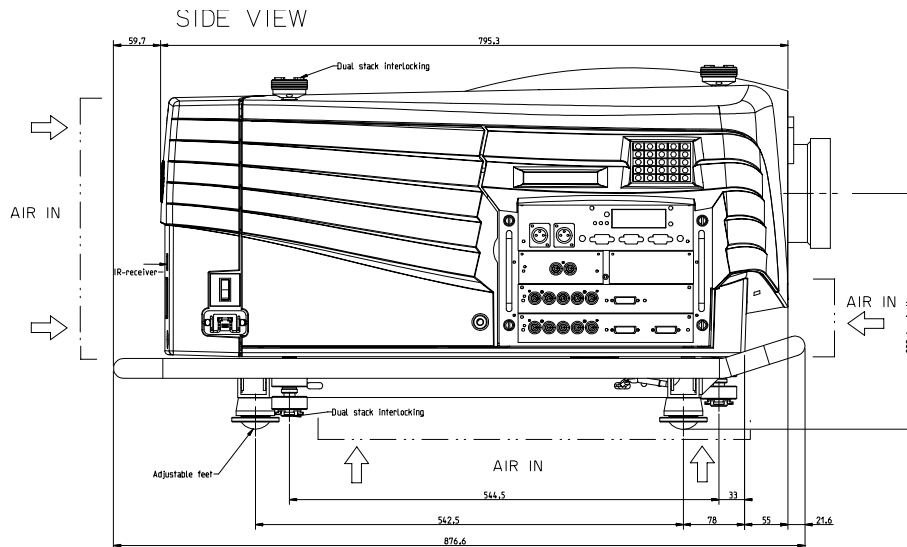

Image 2-3
Side view dimensions

3. INSTALLATION GUIDELINES



The engines are non sealed versions.

3.1 General



WARNING: Before installing the projector, read first the safety instructions.

Ambient Temperature Conditions.

Careful consideration of things such as image size, ambient light level, projector placement and type of screen to use are critical to the optimum use of the projection system.

Max. ambient temperature : 35°C or 95 °F

Min. ambient temperature : 10 °C or 50 °F

The projector will not operate if ambient air temperature falls outside this range (10°C- 35°C or 50°F-95°F).

Storage temperature: -35°C to +65°C (-31°F to 149°F)

Humidity Conditions

Storage: 0 to 98 % RH Non-condensing

Operation: 0 to 95 % RH Non-condensing



CAUTION: Harmful Environmental Contamination Precaution

Environment

Do not install the projection system in a site near heat sources such as radiators or air ducts, or in a place subject to direct sunlight, excessive dust or humidity. Be aware that room heat rises to the ceiling; check that temperature near the installation site is not excessive.

Environment condition check

A projector must always be mounted in a manner which ensures the free flow of clean air into the projectors ventilation inlets. For installations in environments where the projector is subject to airborne contaminants such as that produced by smoke machines or similar (these deposit a thin layer of greasy residue upon the projectors internal optics and imaging electronic surfaces, degrading performance), then it is highly advisable and desirable to have this contamination removed prior to it reaching the projectors clean air supply. Devices or structures to extract or shield contaminated air well away from the projector are a prerequisite, if this is not a feasible solution then measures to relocate the projector to a clean air environment should be considered.

Only ever use the manufacturer's recommended cleaning kit which has been specifically designed for cleaning optical parts, never use industrial strength cleaners on the projector's optics as these will degrade optical coatings and damage sensitive optoelectronics components. Failure to take suitable precautions to protect the projector from the effects of persistent and prolonged air contaminants will culminate in extensive and irreversible ingrained optical damage. At this stage cleaning of the internal optical units will be non-effective and impracticable. Damage of this nature is under no circumstances covered under the manufacturer's warranty and may deem the warranty null and void. In such a case the client shall be held solely responsible for all costs incurred during any repair. It is the clients responsibility to ensure at all times that the projector is protected from the harmful effects of hostile airborne particles in the environment of the projector. The manufacturer reserves the right to refuse repair if a projector has been subject to wantful neglect, abandon or improper use.

Special Care for Laser Beams

Special care should be used when DLP projectors are used in the same room as performant laser equipment. Direct or indirect hitting of a laser beam on to the lens can severely damage the Digital MicroMirror Devices™ in which case there is a loss of warranty

Which screen type ?

There are two major categories of screens used for projection equipment. Those used for front projected images and those for rear projection applications.

3. Installation Guidelines

Screens are rated by how much light they reflect (or transmit in the case of rear projection systems) given a determined amount of light projected toward them. The 'GAIN' of a screen is the term used. Front and rear screens are both rated in terms of gain. The gain of screens range from a white matte screen with a gain of 1 (x1) to a brushed aluminized screen with a gain of 10 (x10) or more. The choice between higher and lower gain screens is largely a matter of personal preference and another consideration called the Viewing angle. In considering the type of screen to choose, determine where the viewers will be located and go for the highest gain screen possible. A high gain screen will provide a brighter picture but reduce the viewing angle. For more information about screens, contact your local screen supplier.

What image size? How big should the image be?

The projector is designed for projecting an image size : min 1.00m (3.3ft) to max 15 m (49.2ft) (depending on the ambient light conditions), with an aspect ratio of 4 to 3.

3.2 Configuration

Which configuration can be used?

The projector can be installed to project images in four different configurations:

- Front/table
- Rear/table
- Front/ceiling
- Rear/ceiling

Positioning the projector

Table mounted, front projection

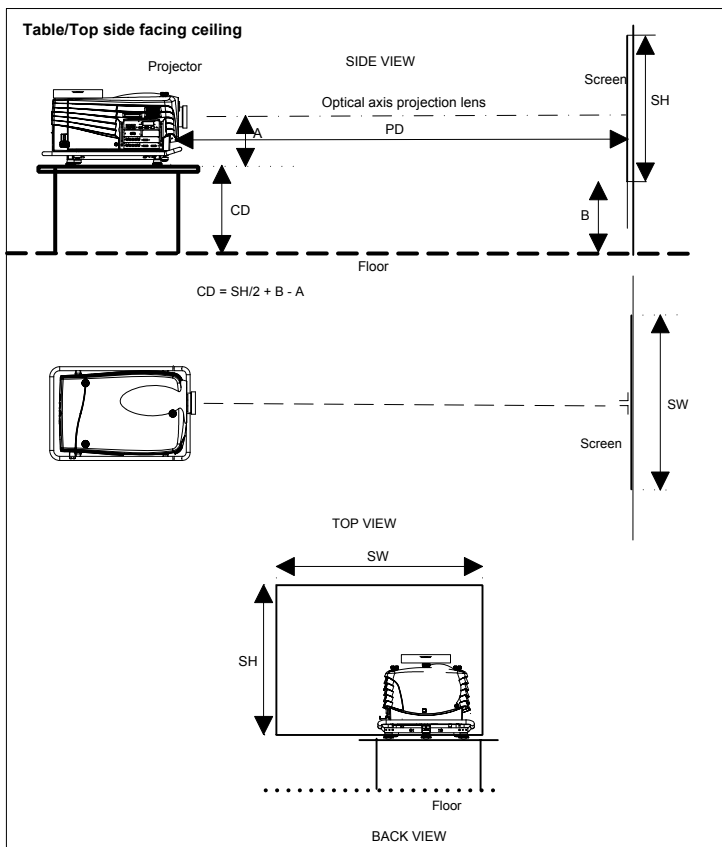

Image 3-1
Table mounted configuration

Table mounted, front projection, second way.

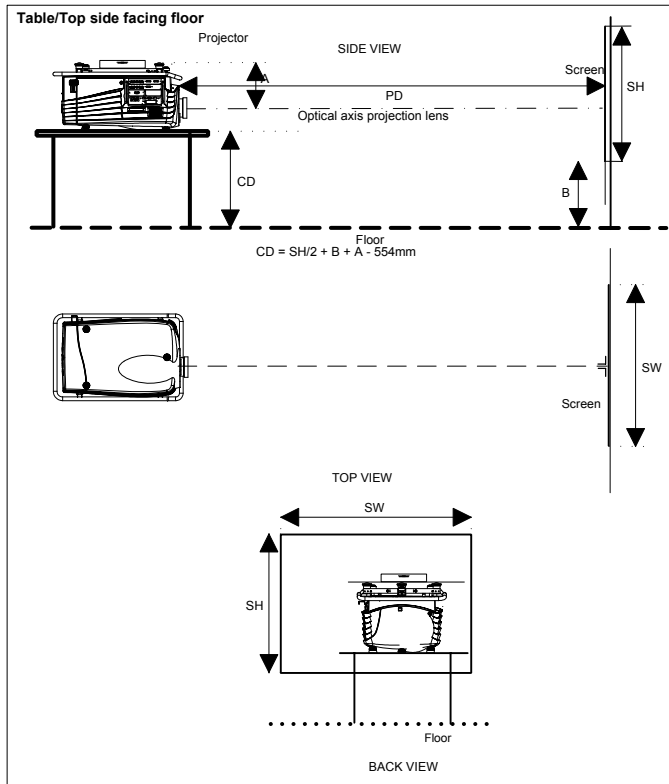

Image 3-2
Table mounted configuration up side down

Ceiling mounted, front projection

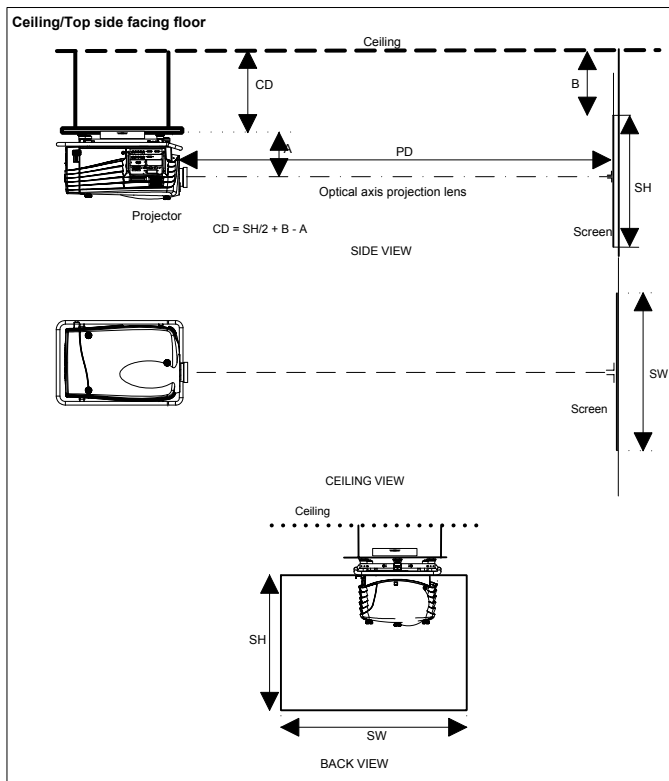

Image 3-3
Ceiling mounted projector

3. Installation Guidelines

Ceiling mounted, front projection, second way.

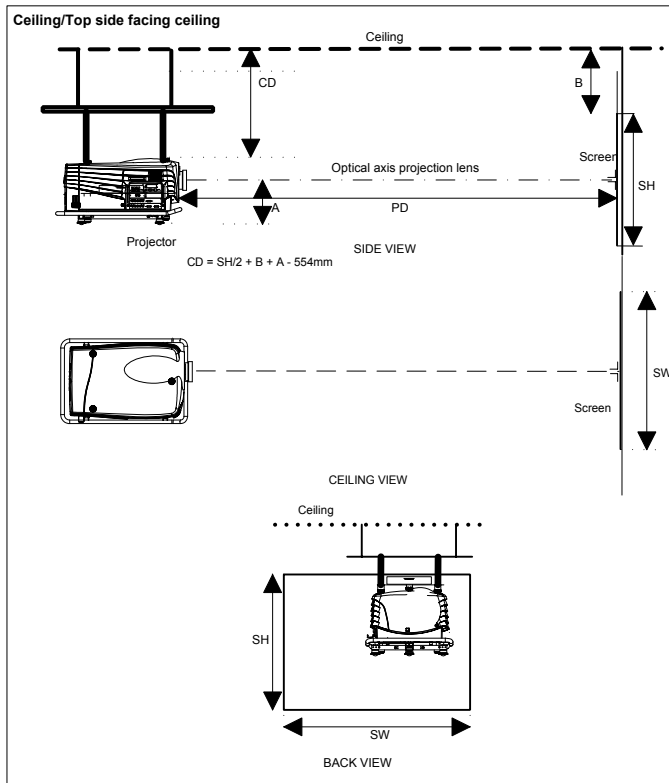

Image 3-4
Ceiling mounted projector

3.3 Safety Area around projector

Safety area

Make sure the projector is located so that the air inlets and outlets for the cooling system are not obstructed. Leave a safety area A of about 1 meter on the left and the right side of the projector.

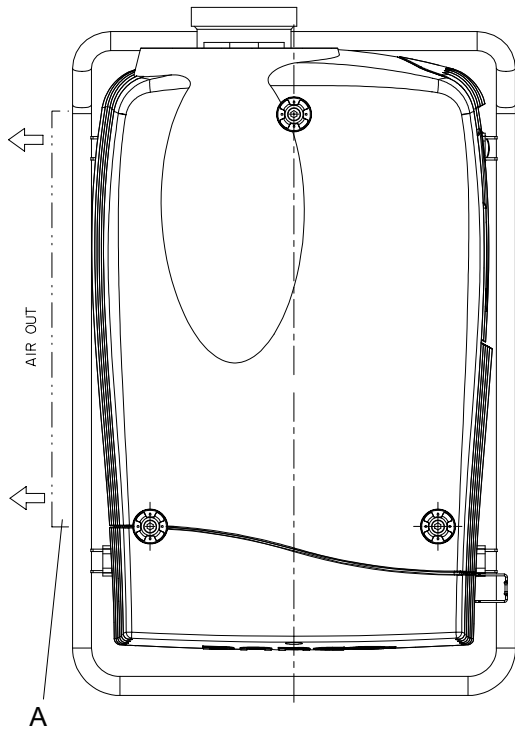

Image 3-5
Safety area around the projector

3.4 Projector tilting

Turning around the projection axes

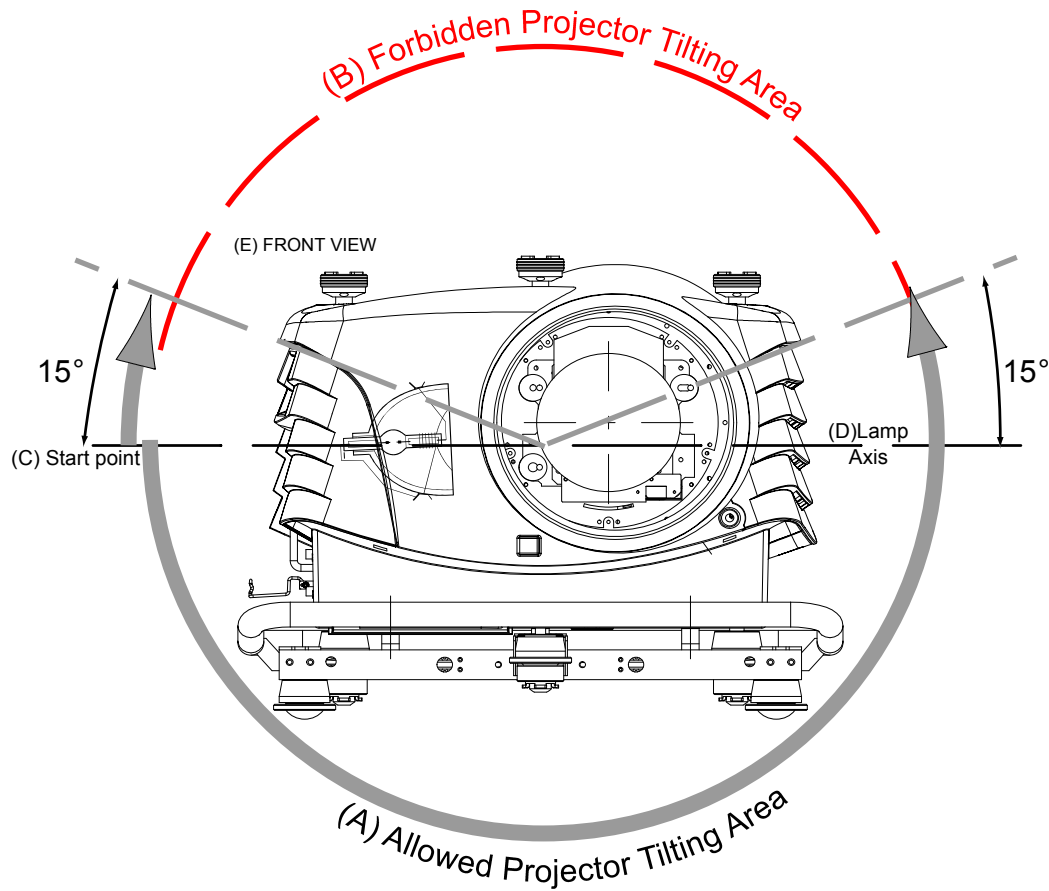

Image 3-6
Tilting diagram

- A Allowed Projector Tilting Area
- B Forbidden Projector Tilting Area
- C Start point
- D Lamp axis
- E Front view

Consider the starting point at the lamp side (input side), the following tilting is possible :

- Maximum 15° upwards
- Maximum 195° downwards (indicated by the allowed projector tilting area)

Forwards and backwards tilting

Forwards and backwards tilting is allowed.

3.5 Mounting the projection lamp



WARNING: Unplug the power cord from the wall outlet before starting with the mounting procedure.



WARNING: Mounting the projection lamp should be done by qualified service technician.

3.5.1 Access to the Lamp Unit.

What has to be done

To access the lamp casing, a side panel has to be removed.

Necessary tools

A flatblade screwdriver of 5 mm

Removing the side panel

1. Turn with a screwdriver the side panel lock screw a quarter turn counter clockwise. (image 3-7)
2. Pull the right side of the panel towards you and further to the right to remove. (image 3-8)

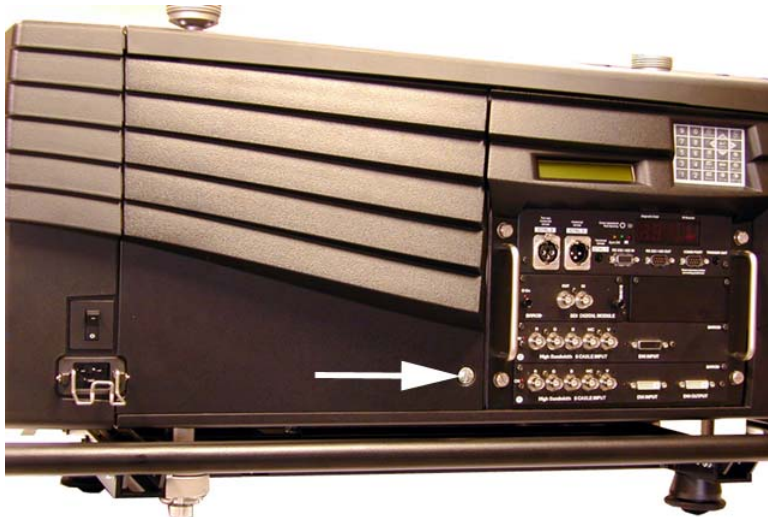

Image 3-7
Unlocking the side cover



Image 3-8
Pull and remove the side cover

3.5.2 Installation of the new Lamp Unit.

What has to be done

First remove the lock nut on each spacer screw and next slide the lamp unit into the projector frame.

3. Installation Guidelines

Necessary tools

Flatblade screwdriver of 5mm or Nut driver 8mm

Installing the lamp unit

1. Remove the lock nut on the 3 spacer screws (A). (image 3-9)
2. Line up the lamp unit guides with the guides on the projector frame (B) and push the unit into the frame until it fits. (image 3-10)
3. Secure the position of the lamp unit with the 3 spacer screws. (image 3-11)

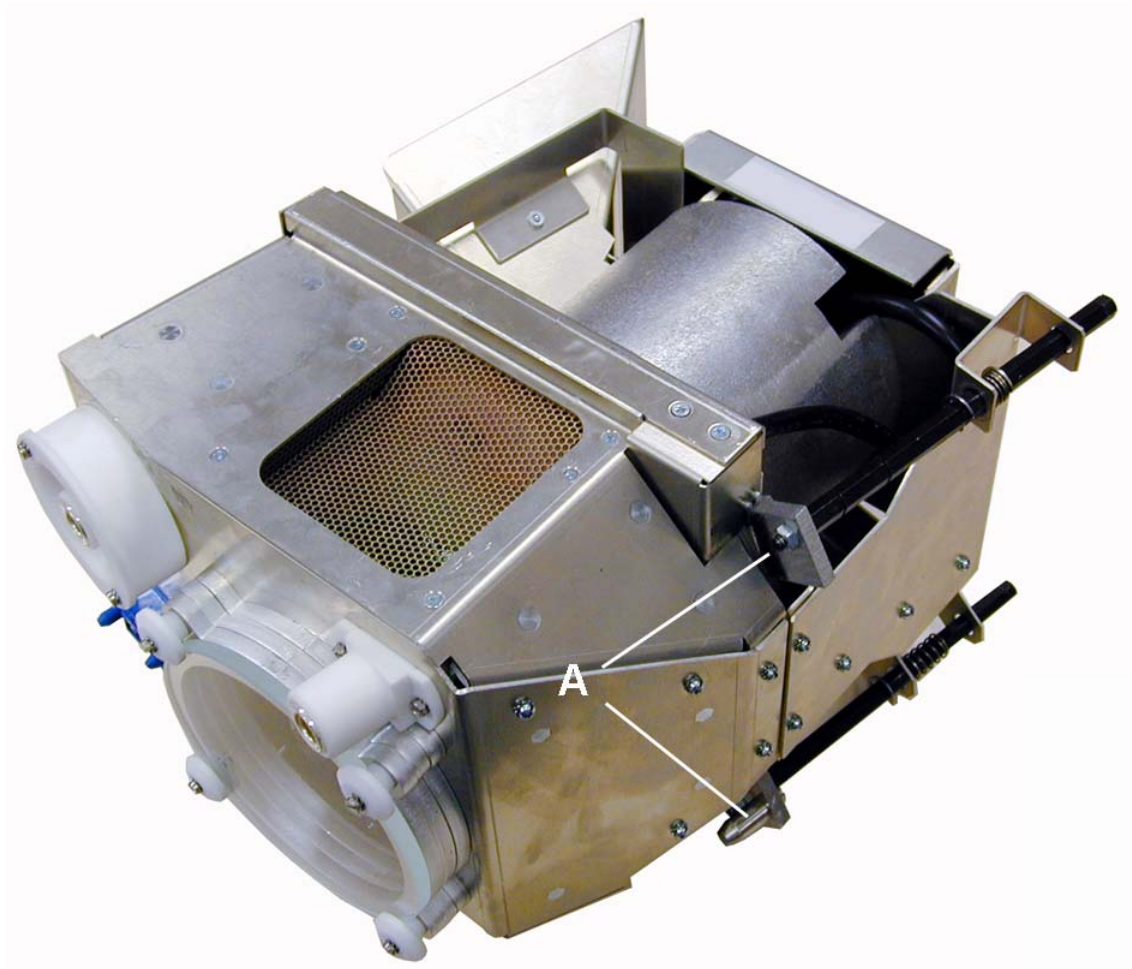

Image 3-9
Lamp unit, removing the lock nuts



Image 3-10
Inserting the lamp

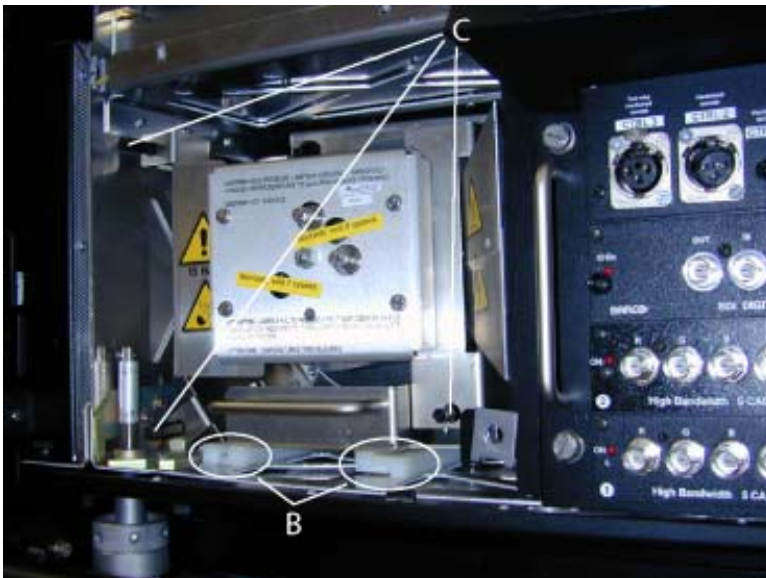

Image 3-11
Securing the lamp

3.5.3 Reinstalling the Side Panel

What has to be done

After the new lamp unit has been installed, the side panel has to be remounted.

Necessary tools

A flatblade screwdriver of 5 mm

Reinstalling the side panel

1. Move the cover guides under the back cover and push the front of the cover against the projector frame lining up the cover lock screw with the speed nut (A) on the frame. (image 3-12, image 3-13)
2. Turn with a screwdriver the side panel lock screw (B) a quarter turn clockwise to lock. (image 3-14)

3. Installation Guidelines



Image 3-12
Mounting the side cover



Image 3-13
Closing the side cover

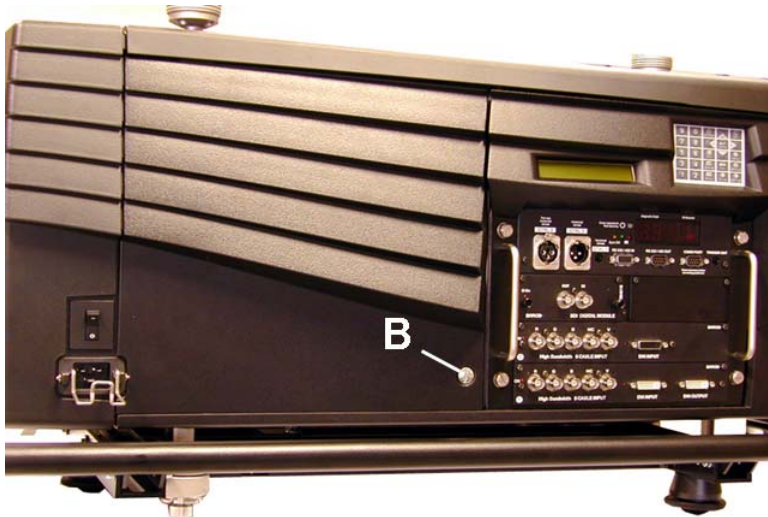

Image 3-14
Locking the side cover

3.6 Re-adjusting the lamp position in the lamp casing



WARNING: As the projector has to be opened, this procedure has to be performed by qualified service technician.

Why

With higher run times, the light output of the lamp will decrease, which results in a lower light output on the screen. This light output decrease can be compensated by readjusting the position of the lamp.

A suggestion dialog box will be displayed when the projector is restarted after 100 hours and 250 hours. Once **ENTER** is pressed when that box is open, this box will not be displayed again till the next alert point is reached.

```

Suggestion

Lamp runtime is
105 hours

It is advisable to
adjust the Z-axis
of the lamp to
obtain maximum
light output
(see owners manual)

<ENTER> to confirm

```

Menu 3-1

The user can now adjust the Z-axis by following the next procedure.

How to readjust.

1. On the side of the inputs, turn the retaining bolt a quarter counter clockwise.
2. Flip the cover to the left side and take off. (image 3-15)
3. Start up the adjustment mode and select *Service*. (menu 3-2)
4. Select Lamp. The Z-axis indication (lamp menu in service mode) will be helpful while turning screw B. (menu 3-3)
5. Loosen the nut A (image 3-16) on the back of the lamp casing (nutdriver 10).
6. Adjust the screw B (image 3-16) with an Allen key by turning a little clockwise until the maximum light output is reached (the maximum value of the Z-AXIS indication on the lamp menu).
7. Fasten the nut on the back of the lamp casing to secure this position (nutdriver 10).

```

ADJUSTMENT MODE

Select a path from below :

RANDOM ACCESS
INSTALLATION
SERVICE

Select with ↑ or ↓
then <ENTER>
<EXIT> to return

```

Menu 3-2

```

SERVICE

IDENTIFICATION
CHANGE PASSWORD
CHANGE LANGUAGE
CHANGE PROJ. ADDRESS
SERIAL COMMUNICATION
NETWORK
LAMP
DIMMING
MORE...

Select with ↑ or ↓
then <ENTER>
<EXIT> to return

```

Menu 3-3

```

LAMP

Constant Light output [OFF]
Using [RS port]
Mode [NORMAL]
Serial number : R101111
Article number : R9840xxx
Run time : 10 hours
Remaining run time : 490
hours
Number of strikes : 10
Z_AXIS : 100

Select with ↑ or ↓
then <ENTER>
<EXIT> to return.

```

Menu 3-4



Image 3-15
Lamp adjustment access

3. Installation Guidelines

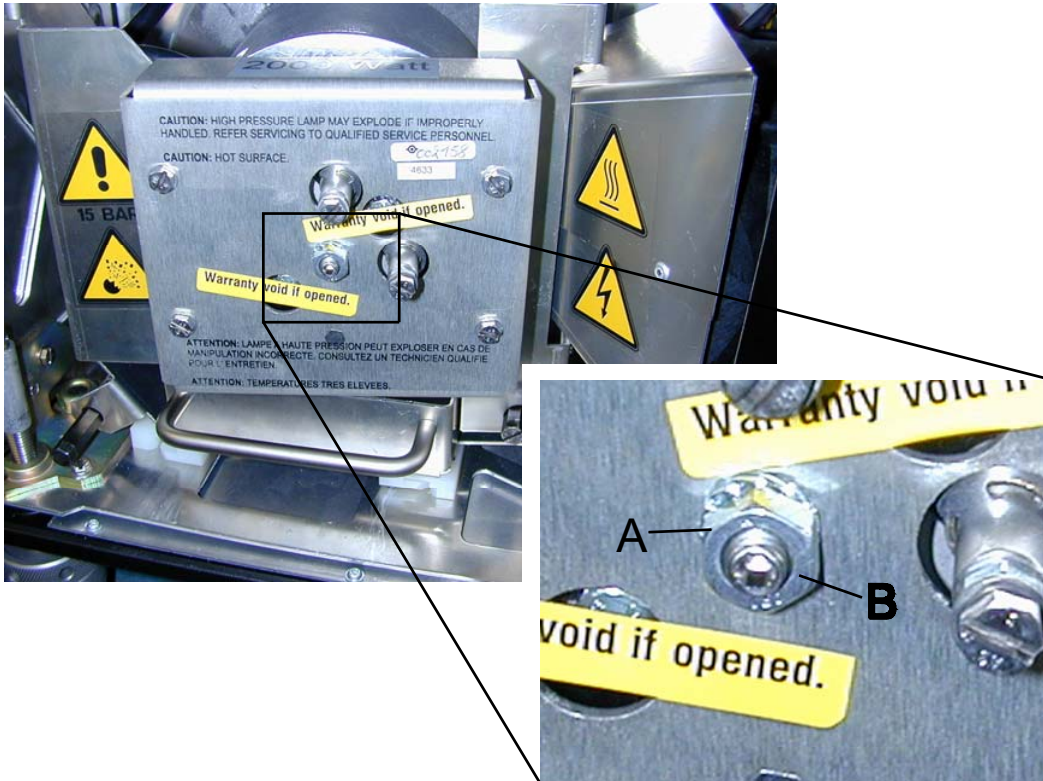

Image 3-16



CAUTION: Never turn the other screws ! These are factory aligned.

3.7 Lenses

Overview

- Lenses
- Lens selection
- Lens formulas
- Lens Installation
- Cleaning the lens

3.7.1 Lenses

Available lenses

TLD(1.6–2.0:1)	R9840670
TLD(2.0–2.8:1)	R9840680
TLD(2.8–5.0:1)	R9840690
TLD(1.2:1)	R9840770
TLD(0.8:1)	R9840900
TLD(5.0–8.0:1)	R9840910
TLD HB(0.8:1)	R9842040
TLD HB(1.6–2.0:1)	R9842060

TLD HB(2.0–2.8:1)	R9842080
TLD HB(2.8–5.0:1)	R9842100
TLD HB(5.0–8.0:1)	R9842120

3.7.2 Lens selection

How to select ?

1. Determine the required screen width.
2. Determine the approximate position of the projector in the projection room with regard to the screen and measure the projector-screen distance (PD).
3. Use the lens formulas to find the best corresponding PD with regard to the measured projector-screen distance for the required screen width.

3.7.3 Lens formulas

Formulas

	Metric formulas (meter)	Inch formulas (inch)
TLD(0.8:1)	$PD=0.85 \times SW-0.05$	$PD=0.85 \times SW-1.97$
TLD(1.2:1)	$PD=1.22 \times SW-0.01$	$PD=1.22 \times SW-0.39$
TLD(1.6–2.0:1)	$PD_{min}=1.62 \times SW-0.09$ $PD_{max}=2.03 \times SW-0.13$	$PD_{min}=1.62 \times SW-3.54$ $PD_{max}=2.03 \times SW-5.12$
TLD(2.0–2.8:1)	$PD_{min}=2.03 \times SW-0.17$ $PD_{max}=2.88 \times SW-0.24$	$PD_{min}=2.03 \times SW-6.69$ $PD_{max}=2.88 \times SW-9.45$
TLD(2.8–5.0:1)	$PD_{min}=2.84 \times SW-0.16$ $PD_{max}=5.18 \times SW-0.38$	$PD_{min}=2.84 \times SW-6.30$ $PD_{max}=5.18 \times SW-14.96$
TLD(5.0–8.0:1)	$PD_{min}=4.97 \times SW-0.01$ $PD_{max}=8.28 \times SW-0.29$	$PD_{min}=4.97 \times SW-0.39$ $PD_{max}=8.28 \times SW-11.42$
TLD HB(0.8:1)	$PD=0.85 \times SW-0.05$	$PD=0.85 \times SW-1.97$
TLD HB(1.2:1)	$PD=1.22 \times SW-0.01$	$PD=1.22 \times SW-0.39$
TLD HB(1.6–2.0:1)	$PD_{min}=1.62 \times SW-0.09$ $PD_{max}=2.03 \times SW-0.13$	$PD_{min}=1.62 \times SW-3.54$ $PD_{max}=2.03 \times SW-5.12$
TLD HB(2.0–2.8:1)	$PD_{min}=2.03 \times SW-0.17$ $PD_{max}=2.88 \times SW-0.24$	$PD_{min}=2.03 \times SW-6.69$ $PD_{max}=2.88 \times SW-9.45$
TLD HB(2.8–5.0:1)	$PD_{min}=2.84 \times SW-0.16$ $PD_{max}=5.18 \times SW-0.38$	$PD_{min}=2.84 \times SW-6.30$ $PD_{max}=5.18 \times SW-14.96$
TLD HB(5.0–8.0:1)	$PD_{min}=4.97 \times SW-0.01$ $PD_{max}=8.28 \times SW-0.29$	$PD_{min}=4.97 \times SW-0.39$ $PD_{max}=8.28 \times SW-11.42$

3.7.4 Lens Installation

How to install ?

Follow the next procedure:

1. Remove the foam rubber in the opening of the lens holder.
2. Take the lens assembly out of its packing material and remove the lens caps on both sides.
3. Move the handle (A) of the lens anchor system to the right. (image 3-17)
4. Push the lens, motors at the top, in the lens block gap horizontally, lining up the motor connector on the lens with the connector on the lens block (B), until the lens clicks in the lens anchor system. (image 3-18)

Caution: On a table mounted projector, hold the projector when pushing the lens into the lens block to avoid sliding off from the table.

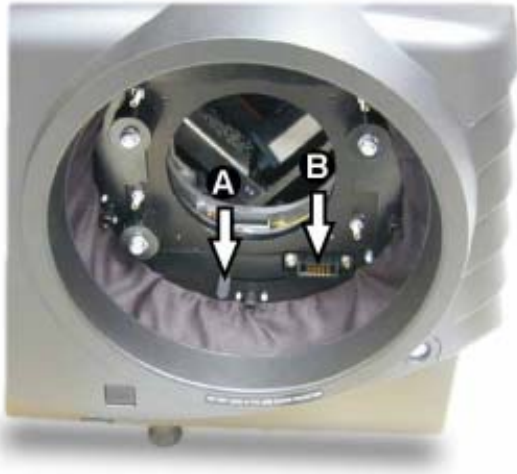

Image 3-17
Lens installation



Image 3-18
Mounted Lens

3.7.5 Cleaning the lens



To minimize the possibility of damaging the optical coating or scratching exposed lens surface, we have developed recommendations for cleaning the lens. **FIRST**, we recommend you try to remove any material from the lens by blowing it off with clean, dry deionized air. **DO NOT** use any liquid to clean the lenses.

Necessary tools

Toraysee™ cloth (delivered together with the lens kit). Order number : R379058.

How to clean the lens ?

Proceed as follow :

1. Always wipe lenses with a CLEAN Toraysee™ cloth.
2. Always wipe lenses in a single direction.
Warning: Do not wipe back and forwards across the lens surface as this tends to grind dirt into the coating.
3. Do not leave cleaning cloth in either an open room or lab coat pocket, as doing so can contaminate the cloth.
4. If smears occur when cleaning lenses, replace the cloth. Smears are the first indication of a dirty cloth.



WARNING: Do not use fabric softener when washing the cleaning cloth or softener sheets when drying the cloth.

Do not use liquid cleaners on the cloth as doing so will contaminate the cloth.



CAUTION: Other lenses can also be cleaned safely with this Toraysee™ cloth.

3.8 Battery Installation in the RCU

How is the battery delivered ?

A battery (not yet installed to save the battery life time) is delivered inside the plastic bag with the power cord.

How to install ?

1. Remove the battery cover on the backside of the remote control by pushing the indicated handle a little towards the bottom of the RCU. (image 3-19)
2. Lift up the top side of the cover at the same time. image 3-19
3. Insert the new 9 V battery (type E-block or equivalent) in the lower compartment.
4. Connect the battery (B) to the contact plate (A). (image 3-20)
5. Insert the battery into the lower compartment and put the cover back.
6. Insert a overview card (C) in the back side. image 3-20

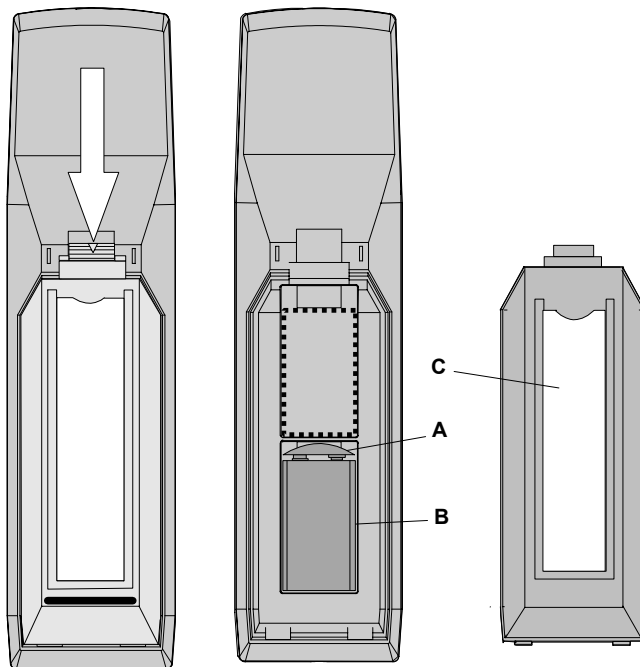

Image 3-19
Opening the battery cover of
the RCU

Image 3-20
Mounting the battery into the RCU

3.9 Stacking Projectors

What is possible?

Up to 3 projectors can be stacked on each other without using extra tools or accessories.

How to stack?

Handle as follow:

1. Put the second projector on the first one so that base plate of the second projector matches with the rigging socket of the first projector. (image 3-21)
2. Turn the rigging sockets of the second projector counter clockwise until they are free to move up and down. (image 3-22)
3. Secure the projectors on each other by bringing the free part of the second projector into the socket of the first projector and turn a quarter clockwise while pushing downwards until it clicks in.
4. For ceiling mounted configurations, pull on the hook (A) with the cable of the lowest projector. (image 3-23)
5. Guide hook and cable around the carry handle and guide it around the carry handle of the upper projector. (image 3-24)
6. Hook it in the foreseen hole B in the base plate of the upper projector. (image 3-25)

3. Installation Guidelines

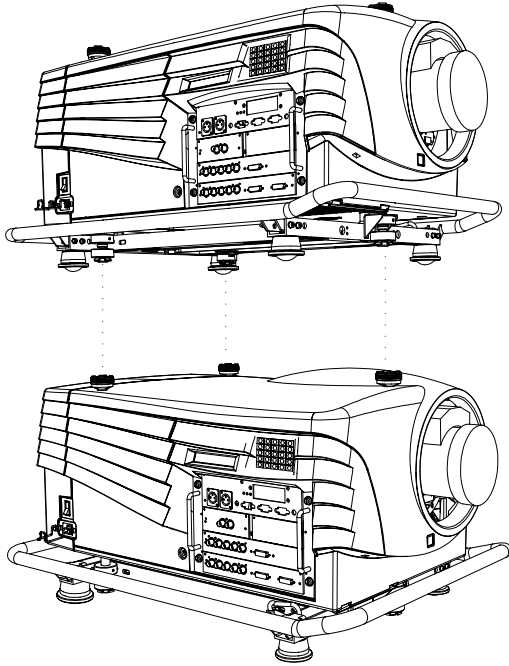

Image 3-21
Stacking two projectors

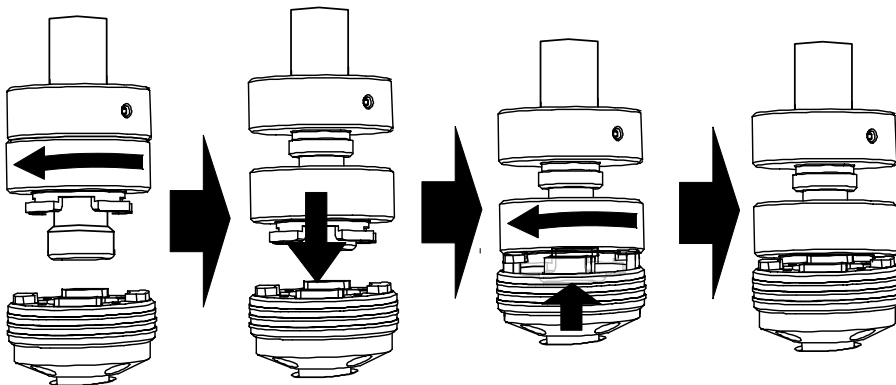

Image 3-22
Closing the rigging sockets

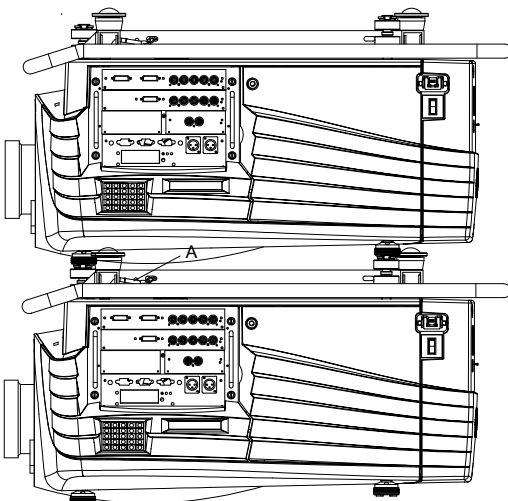

Image 3-23
Mounting the security chain

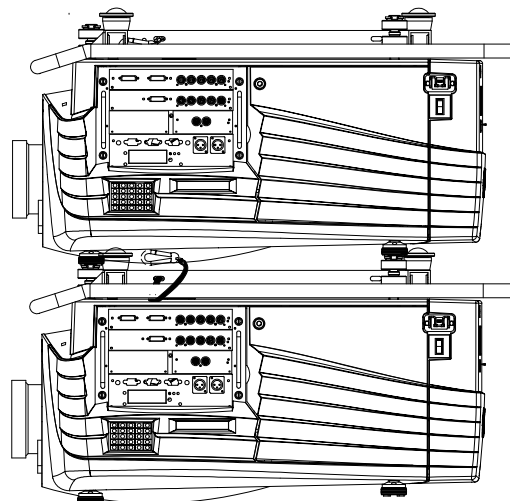

Image 3-24
Mounting the security hook

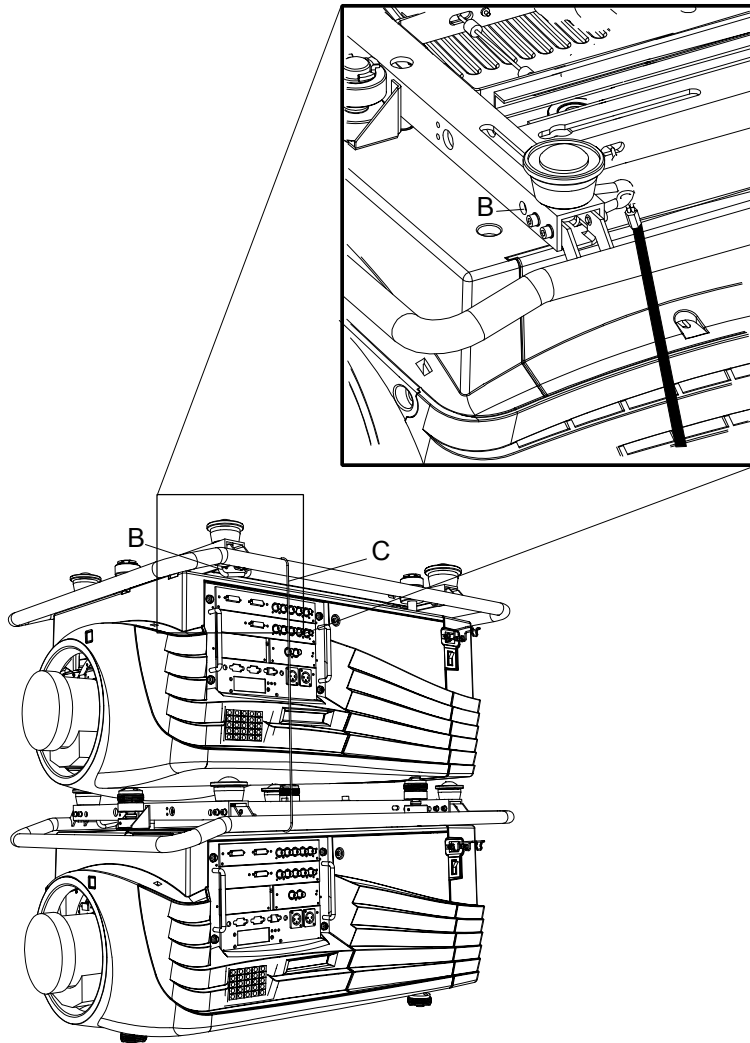

Image 3-25
Mounting the security hook (detail)

How to open a secured rigging point?

1. Push the ring (A) of the first projector downwards and hold it in that position. (image 3-26)
2. Turn the locked part (B) of the second projector a quarter counter clockwise and move it upwards.

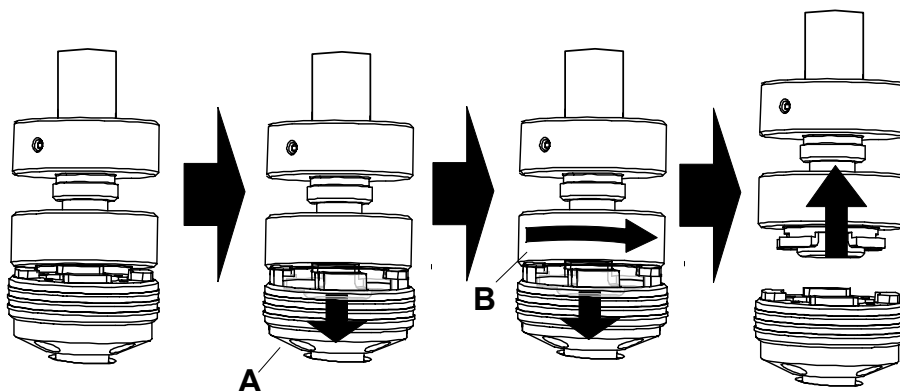

Image 3-26
Opening the rigging sockets

3.10 Rigging points and Accessories

Clamps

Slots are made in the carry handle frame for easy inserting the overlockers and for easy adjusting the clamps position so that this position matches with the rigging points.

Consult a professional structural engineer prior to suspending the ceiling mount from a structure not intended for that use. Always ensure the working load limit of the structure supporting the projector.

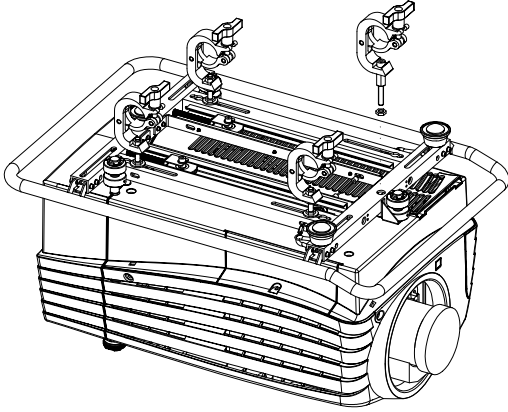

Image 3-27
Mounting the clamps

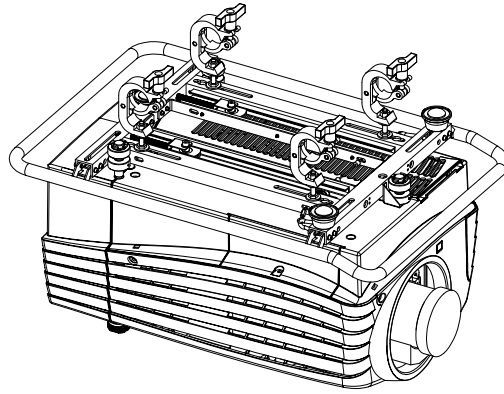

Image 3-28
Mounting the clamps



WARNING: When mounting the projector to the ceiling or to a rigging system, always mount security chains.

How to mount the clamps?

To fix the clamps to the U-profile, follow the next procedure :

1. Measure the distance, center tube as reference, between the two used support bars of a truss.
2. Slide the clamps holders (2 per profile) on its place in the U-profile according the measured distance and secure this position. (image 3-29)
3. Turn the overlockers in the holes of the clamp holder.

The overlocker can turn around.

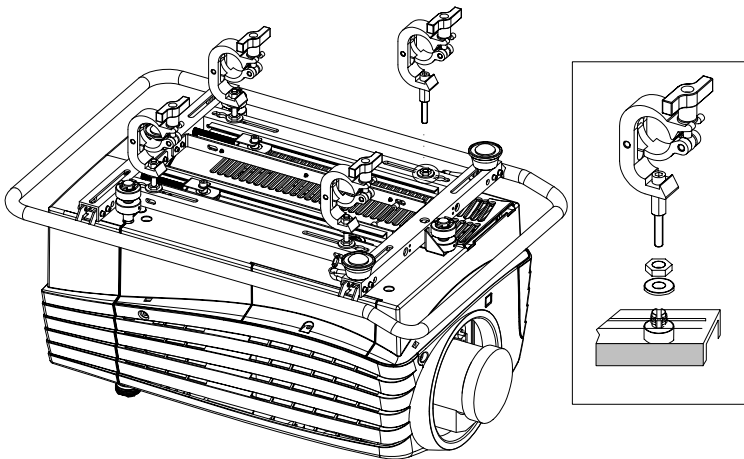

Image 3-29
Mounting the clamp — detail

How to mount the Overlockers to the truss?

To mount the overlocker to the truss, handle as follow :

1. Open the fixation handle. (image 3-30)

2. Hook the clamp around the tube.

The trigger automatically shuts the clamp.

3. Close the fixation handle and secure it by turning the hand screw. (image 3-31)



Image 3-30
Opening the rigging clamp



Image 3-31
Closing the rigging clamp

4. CONNECTIONS

Overview

- Power connection
- Switching on
- Switching to standby
- Switching off
- Input Source Connections
- Communication Connections

4.1 Power connection

AC Power cord connection

Use the supplied power cord to connect your projector to the wall outlet. Plug the female power connector into the male connector at the left of the projector. The power input is 230 VAC.

Fuses

The projector is protected with an automatic circuit breaker of 15A which is built in into the power switch.

4.2 Switching on

How to switch on.

1. Press the power switch to switch on the projector.
 - When '0' is visible, the projector is switched off.
 - When '1' is visible, the projector is switched on

The projector starts in standby mode. The projector indication lamp is red.

Starting image projection.

1. Press **Stand by** key once on the local keypad or on the remote control.

The projector mode indication lamp will be green (image 4-1)

Or,

Press a digit button to select an input source.

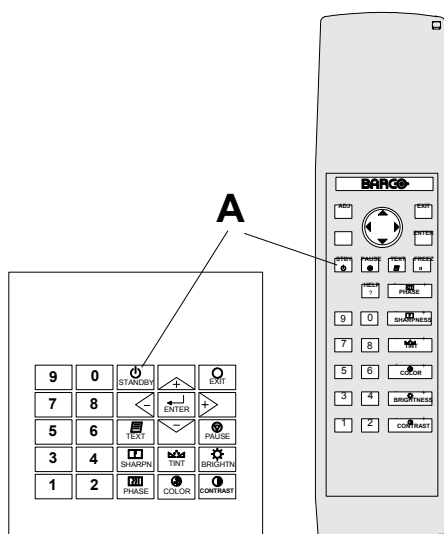

Image 4-1
Standby indication

4. Connections

Lamp run time indication while running

When the total run time of the lamp is 30 hours less than 1000, the following warning message will be displayed for 1 minute. This warning message will be repeated every 30 minutes. Press **EXIT** to remove the message before the minute is over.

```
Remaining  
Lamp run time  
20h
```

Image 4-2

When the total run time of the lamp is 1000 hours or more, the following warning message, with the exact run time is displayed on the screen.

```
WARNING  
  
Lamp run time is x hours  
operating the lamp longer  
than x hours may damage  
the projector.  
Please replace the lamp  
  
<ENTER> to continue
```

Menu 4-1

Lamp run time is 1000 hours. Operating the lamp longer than maximum runtime hours may damage the projector. Please replace the lamp.

When **ENTER** is pressed to go on, the warning will be repeated every 30 min.

The total lifetime of the lamp for a safe operation is 1000 hours max. Do not use it longer. Always replace with a same type of lamp. Call a BARCO authorized service technician for lamp replacement.



CAUTION: Using a lamp for more than 1000 hours is dangerous as the lamp could explode.

Lamp Light Output Indication

When starting up and the center lumens measurement is lower than 50 % of its initial value, the lamp light output warning will be displayed. Press **ENTER** to continue. The message will not be repeated during operation.

```
WARNING  
  
Lamp run time is X hours  
The light output of the lamp  
is less  
than 50% of its initial value.  
It is advisable to replace the  
lamp  
before damage occurs.  
  
<ENTER> to confirm
```

Menu 4-2

When the 'Constant Light Output' (CLO) options is installed, the light output message will appear on the screen when the light output is reduced with 33% from its initial value.

This message will be repeated every hour.

Lamp Z-axis indication

When starting up and the run time is 100 hours or 250 hours a Z-axis warning will be displayed. This warning will advise to adjust the Z-axis of the lamp to obtain maximum light output. Press **ENTER** to continue. The message will not be repeated during operation.

```
WARNING  
  
Lamp run time is X hours.  
It is advisable to  
adjust the Z-axis  
of the lamp to  
obtain maximum  
light output  
(see owner's manual)  
  
<ENTER> to confirm
```

Menu 4-3

4.3 Switching to standby

How to switch to standby?

1. Press **Standby** to switch the projector to standby.

4.4 Switching off

How to switch off the projector?

1. Press first **Standby**.
2. Let cool down the projector until the fans stop blowing, at least 15 min.
3. Switch off the projector with the power switch.

4.5 Input Source Connections

4.5.1 Input Facilities

Overview input facilities

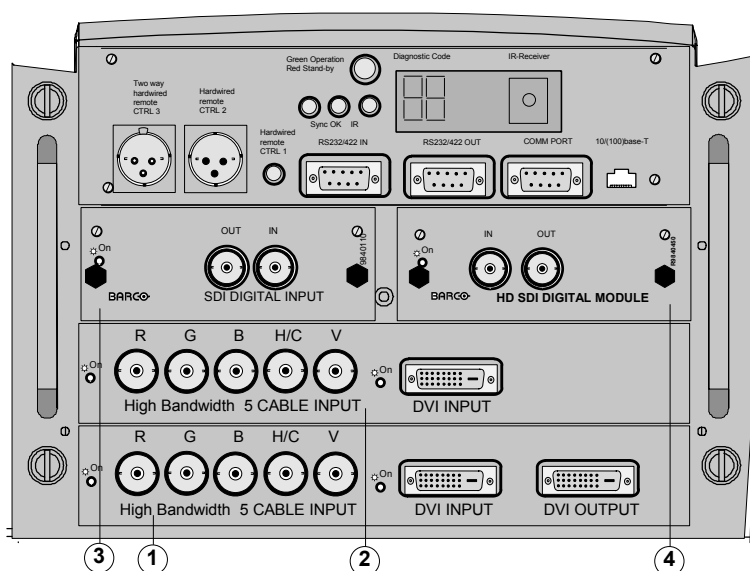

Image 4-3
Input facilities

Input number	Type of input
1	Fixed input, 5 cable input or DVI input and DVI output
2	Fixed input, 5 cable input or DVI input
3 & 4	Variable inputs Two digital inputs available. <ul style="list-style-type: none"> • SDI input (R9840110) • HD SDI Digital input (R9840450) Digital Video Decoder (R9841170)

4.5.2 Inputs via RCVDS05

Overview

When using a RCVDS05, the input configuration must be as follows:

4. Connections

slot 1	RGB/Component
slot 2	Video
slot 3	not used
slot 4	not used

When using a RCVDS05, it is recommended to use a 5-cable output module in the RCVDS. The outputs of this module has to be connected to slot 1 of the projector. To switch the projector in the 5-cable mode see "Fixed slot (slot 1 & 2)", page 35.

4.5.3 Input module insertion

How to insert an input module?

To insert a module in one of the free slots, handle as follow :

1. Power down the projector and disconnect the power cord from the wall outlet.
2. Remove the dummy plate covering the chosen input slot by turning out both screws.
3. Slide the input module in the free slot. Insure the module is seated correctly in the guide grooves.
4. Press on both handles of the input module until the module plug seats in the connector of the projector. (image 4-4)
5. Secure the input module by tightening both retaining screws.
6. Reconnect the power cord to the wall outlet and switch on the projector.

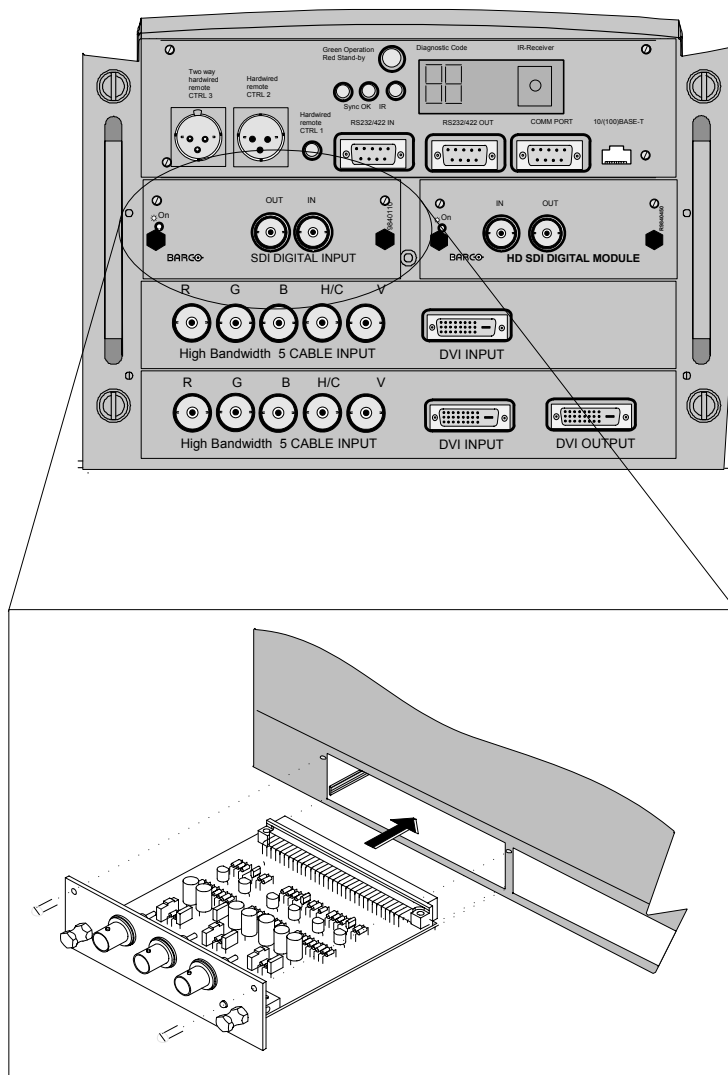

Image 4-4

How to select the new installed module?

The new installed module can be selected with the digit buttons on the RCU or the local keypad.

4.5.4 Fixed slot (slot 1 & 2)

Where to find?

Slot 1 & 2 has 5 BNC input terminals for 5 cable input and a DVI plug for DVI input. Slot 1 has also an DVI output for loop through to a second projector. Within the installation mode it is possible to setup the input for 5 cable or DVI (PanelLink).

Which signals can be connected to slot 1 & 2?

Connector name/ Input signal	R	G	B	H	V
RGBHV	R	G	B	H	V
RGBS	R	G	B	S	-
RGsB	R	Gs	B	-	-
Composite Video	-	Video	-	-	-
Super Video	-	Y	-	-	C
Component Video — SS	R-Y	Y	B-Y	S	-
Component Video — SOY	R-Y	Ys	B-Y	-	-

DVI signals can be connected to the DVI input connector.

Pin assignment for the DVI connector.

Pin 1	TMDS DATA2-	Pin 13	TMDS DATA3+
Pin 2	TMDS DATA2+	Pin 14	+5 Power
Pin 3	TMDS DATA2/4 Shield	Pin 15	Ground (for +5V)
Pin 4	TMDS DATA4-	Pin 16	Hot Plug Detect
Pin 5	TMDS DATA4+	Pin 17	TMDS DATA0-
Pin 6	DDC Clock	Pin 18	TMDS DATA0+
Pin 7	DDC Data	Pin 19	TMDS DATA0/5 Shield
Pin 8	No connect	Pin 20	TMDS DATA5-
Pin 9	TMDS DATA1-	Pin 21	TMDS DATA5+
Pin 10	TMDS DATA1+	Pin 22	TMDS Clock Shield
Pin 11	TMDS DATA1/3 Shield	Pin 23	TMDS Clock+
Pin 12	TMDS DATA3-	Pin 24	TMDS Clock-

How to select input slot 1 or 2 ?

1. Key in 1 or 2 on the RCU or the local keypad.

How to change the input slot setting?

1. Press **ADJUST** or **ENTER** key to start up the Adjustment mode.
2. Push the cursor key \uparrow or \downarrow to select *Installation*. (menu 4-4)
3. Press **ENTER**.
4. Press the cursor key \uparrow or \downarrow to select *Input Slots*. (menu 4-5)

4. Connections

5. Press **ENTER**.

The internal system will scan the inputs and displays the result in the *Input Slots* menu.

6. Push the cursor key ↑ or ↓ to select the first or second slot. (menu 4-6)

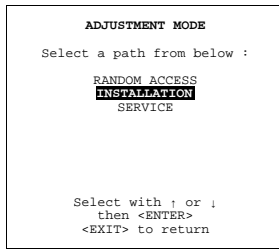

Menu 4-4

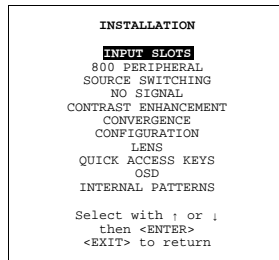

Menu 4-5

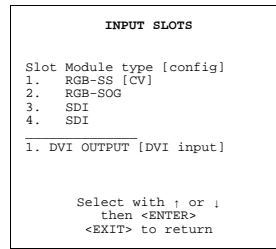

Menu 4-6

Possible indications on the input slot menu.

For the input side:

- RGS-SS [CV or HS&VS] = RGB analog signals, separate sync is composite sync or horizontal and vertical sync.
- RGB-SS [CV] = RGB analog signals, separate sync is composite video.
- RGB-SOG [SOG or 3LSOG] = RGB analog signals, sync on green is composite sync or composite tri-level sync.
- COMPONENT VIDEO - SS [SS or 3LSS] = separate sync is composite sync or composite tri-level sync.
- COMPONENT VIDEO - SOY [SOY or 3LSOY] = component video with composite sync on Y or composite tri-level sync on Y.
- VIDEO
- S-VIDEO
- DVI

When changing from an analog signal on the 5 cable module to the PanelLink input the indication led on the front panel of the module will switch from the 5 cable input to the DVI (PanelLink) input also.

For the output on fixed slot 1:

- DVI input : DVI in signal is looped through to the DVI out connector as it is.
- Active image : active image signal, what ever the input is, is available in DVI on the DVI output signal (processing is incorporated in the signal). Set the minimum delay in *Installation > Advanced processing* to OFF.
- DVI resync : DVI in signal is resynchronized with a stable clock and put on the DVI out connector



When using an RCVDS 05 with a 5 cable output module, connect these 5 cables to this fixed 5-input slot (slot 1) of the projector. All sources of the RCVDS can now be accepted by the projector.

4.5.5 Serial Digital Input (slot 3 & 4)

What can be connected to this input?

This input is full compatibility with digital Betacam, or other digital video sources. This avoids the need for analog video processing anywhere in the video production chain and guarantees the ultimate image quality.

An active loop-through of the SDI input signal is provided for monitoring or for double and or triple stacking applications.

How to connect ?

1. Connect the output of your SDI source to the input BNC of the SDI input. (image 4-5)
Note: *The input is always 75 Ω terminated.*
2. If loop through is needed, use the OUT to connect to the next device.

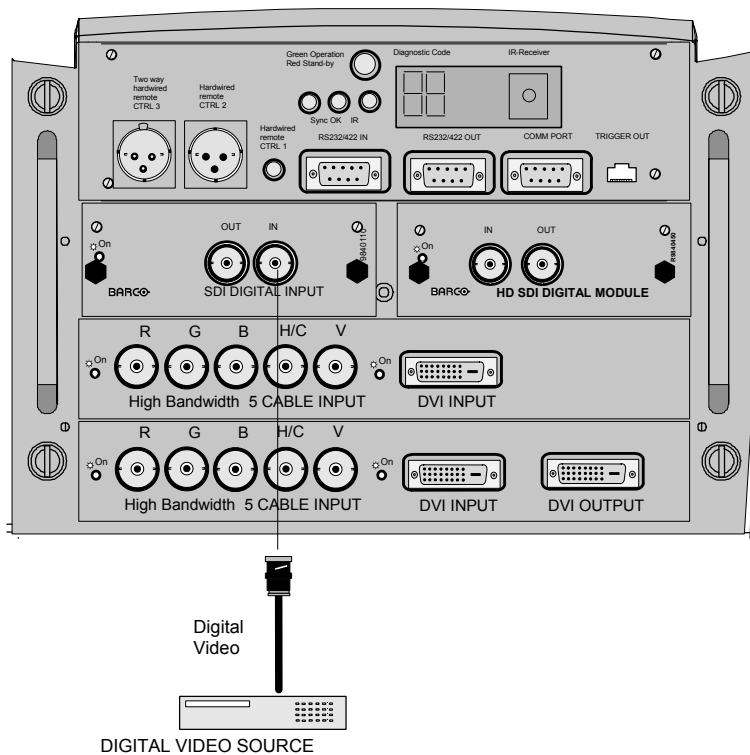

Image 4-5

How to select the digital input?

1. Key in the corresponding slot number on the RCU or the local keypad.



When a RCVDS05 is connected to the projector, the SDI input is available by keying in 83 or 84 on the RCU.

4.5.6 HD SDI Digital input (slot 3 & 4)

What can be connected to this input?

This input is full compatibility with HD digital sources. This avoids the need for analog video processing anywhere in the video production chain and guarantees the ultimate image quality.

An active loop-through of the HD SDI input signal is provided for monitoring or for double and or triple stacking applications.

How to connect ?

1. Connect the output of your HD SDI source to the input BNC of the HD SDI input. (image 4-6)
Note: The input is always 75 Ω terminated.
2. If loop through is needed, use the OUT to connect to the next device.

4. Connections

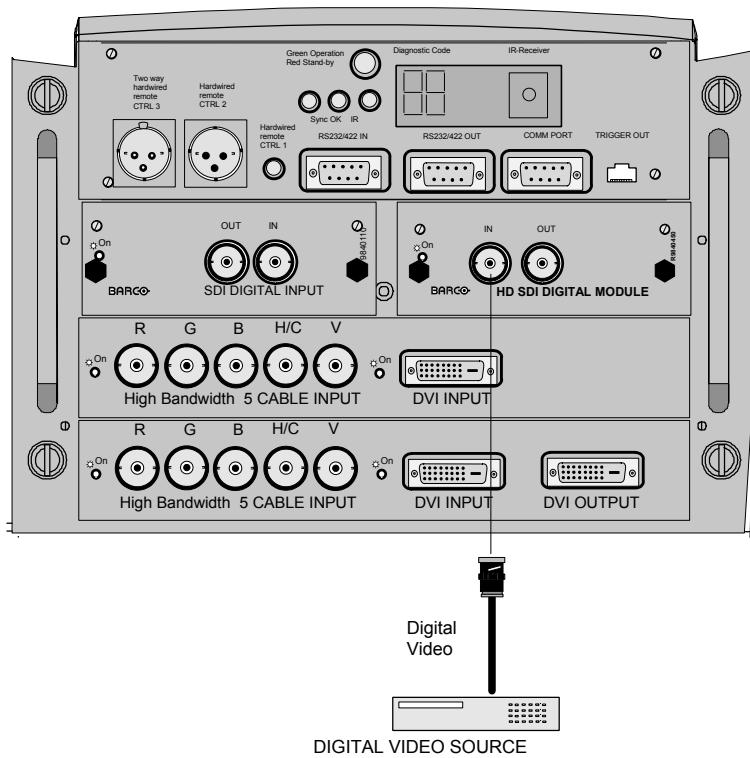

Image 4-6

How to select the digital input?

1. Key in the corresponding slot number on the RCU or the local keypad.



When a RCVDS05 is connected to the projector, the SDI input is available by keying in 83 or 84 on the RCU.

4.5.7 Digital Video Decoder Input

What can be connected to this input?

The following source types can be connected:

- S-Video
- Component Video
- Composite Video

Which signal can be connected to the Digital Video Decoder module?

Connector name/ Input signal	Pb	Y/Vid	Pr	S-Video
Component Video	B-Y	Ys	R-Y	-
Composite Video	-	Video	-	-
S-Video	-	-	-	S-Video

How to connect?

1. Connect the output of your source to the corresponding inputs on the Digital Video Decoder module. (image 4-7)

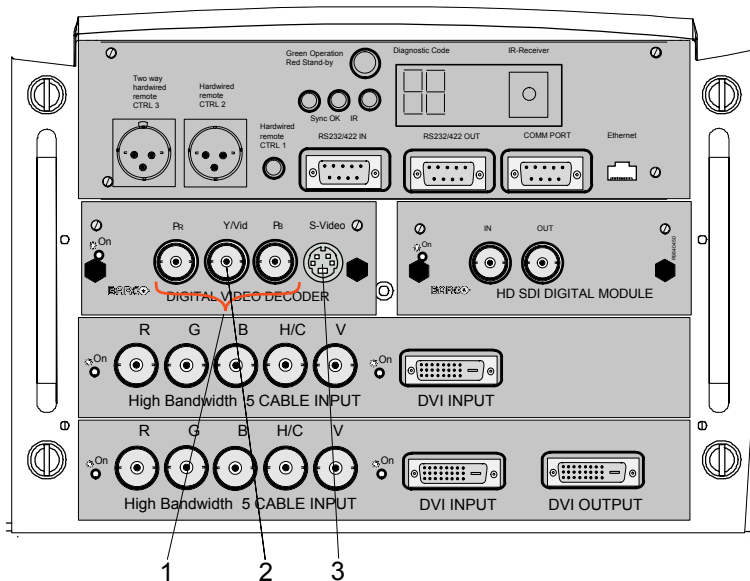

Image 4-7

- 1 Component video input
- 2 Composite Video input
- 3 S-Video input

How to select the digital video decoder input?

1. Key in the corresponding slot number on the RCU or the local keypad.

How to change the input slot setting?

1. Press **ADJUST** or **ENTER** key to start up the Adjustment mode.
2. Push the cursor key \uparrow or \downarrow to select *Installation*. (menu 4-7)
3. Press **ENTER**.
4. Press the cursor key \uparrow or \downarrow to select *Input Slots*. (menu 4-8)
5. Press **ENTER**.

The internal system will scan the inputs and displays the result in the *Input Slots* menu.

6. Push the cursor key \uparrow or \downarrow to select the third or fourth slot. (menu 4-9)
7. Press **ENTER** to toggle.

Possible indications on the input slot menu.

- VIDEO[VDEO]
- VIDEO[S-VIDEO]
- VIDEO[YUV]

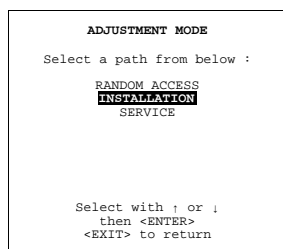

Menu 4-7

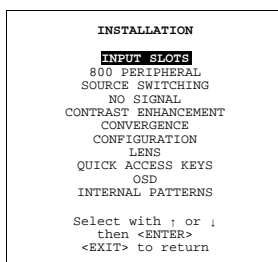

Menu 4-8

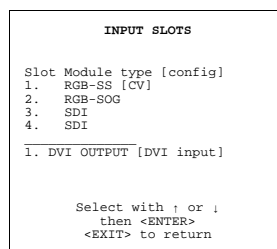

Menu 4-9

4.6 Communication Connections

Overview

- RS232 (RS422) Connection
- Linked System
- Communication with peripherals
- Network connection

4.6.1 RS232 (RS422) Connection

Application

1. Remote control :
 - easy adjustment of projector via an IBM PC (or compatible) or MAC connection.
 - allow storage of multiple projector configurations and set ups.
 - wide range of control possibilities.
 - address range from 0 to 255.
2. data communications : sending data to the projector or copying the data from the projector to a hard memory device (hard disc, floppy, etc.).

Set up of the Baud Rate for communication with a computer.

see "Baud rate Setting", page 107.

4.6.2 Linked System



CAUTION: Always use the Barco COM 800 Splitter, R9827941 (240V) or R9827948 (110V), when using the COM 800 protocol.

What can be done?

In a complex multi-channel setup, projectors can be controlled using the RS232 or COM800 Protocol.

CLO can be controlled by both protocols, however by using the COM800 port for this adjustment, the RS232 Port can still be used for general RS232 commands.

The following procedure will describe how to connect COM800 Linked System.

How to connect a COM800 Setup

Always use the Barco COM 800 Splitter, **R9827941** (240V) or **R9827948** (110V), when using the COM 800 protocol.

1. Use a data cable with at least 9 cores and 2 DB9 female connectors, just cross the pin 2 and pin 3 connection to make a Custom Null Modem Cable. (image 4-8)
2. Use the Custom Null Modem Cable to connect the COM 800 port of the master-projector to the 'To Switcher' port on the frontside of the COM 800 Splitter. (image 4-9)
3. Continue by connecting the slave projectors to the 'To Proj.' connectors on the backside of the COM 800 Splitter (image 4-9).
4. When dealing with more than 4 slave projectors, the 'To Proj.' connectors on the backside of the COM 800 Splitter can also be used to connect extra COM 800 Splitters (image 4-9).

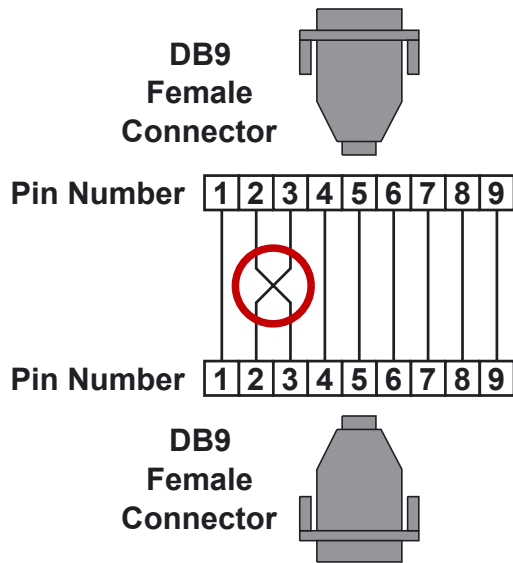

Image 4-8
Make a Custom Null Modem Cable

4. Connections

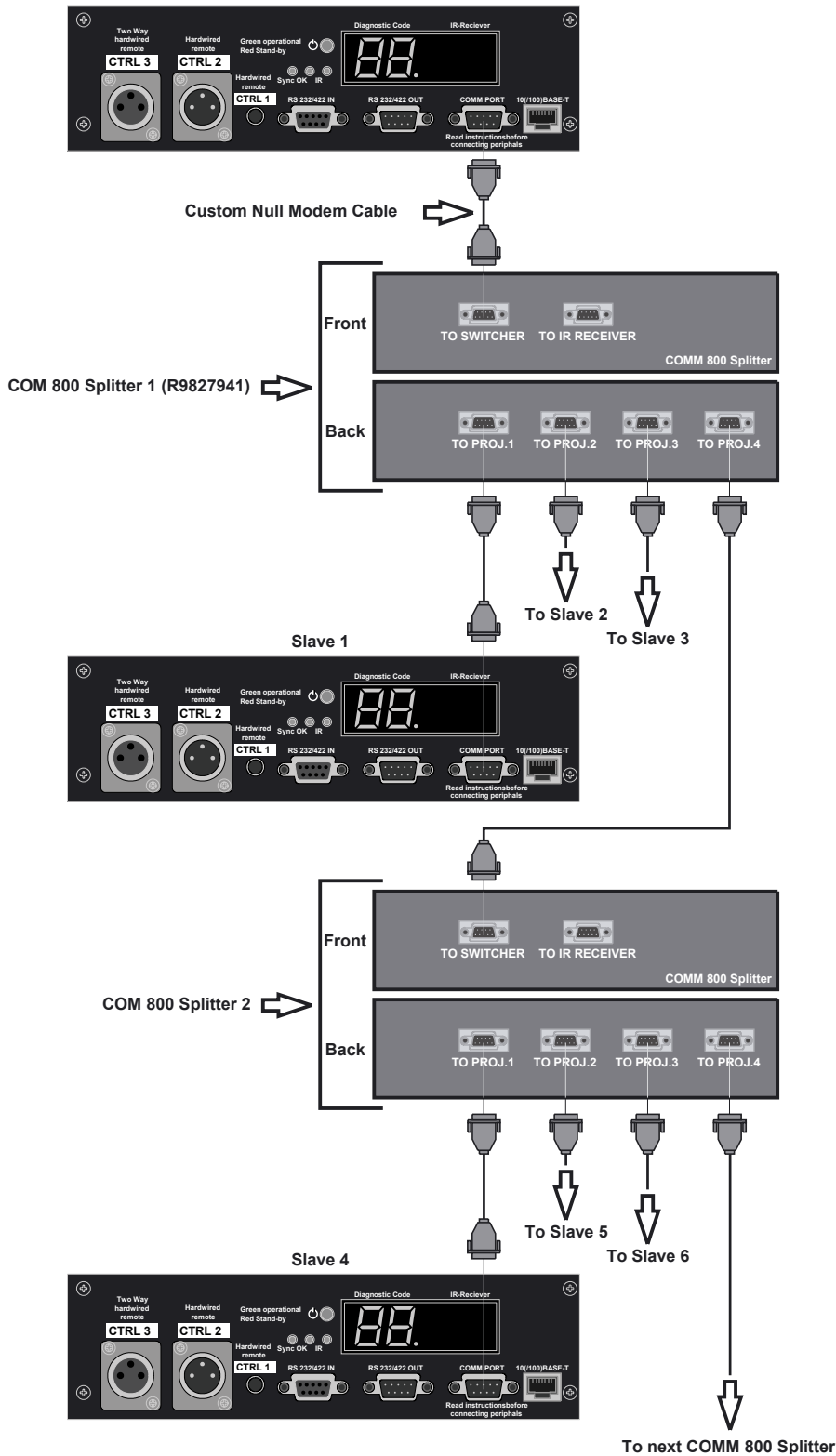

Image 4-9
Com 800 Connection

4.6.3 Communication with peripherals

What is possible with an RCVDS05 connected.

- Up to 20 inputs with the RCVDS 05 and 90 inputs when RCVDS's are linked via the expansion module.
- Serial communication with the projector.
- Remote control buttons on the RCVDS to control the projector (source selection and analog settings).
- The selected source number will be displayed on a 2 digit display and the selected input module will be indicated with a LED on the rear.

For more information about the use of the RCVDS05, consult the owner's manual of the RCVDS05.

What is possible with an VS05 connected.

The VS05 can switch up to 5 Composite Video sources, 3 Super Video sources and 1 RGB analog or component video source to the projector. In addition, the audio signal proper to the source, can be switched to an audio amplifier. Order number : R9827890

For more information about the use of the VS05, consult the VS05 owner's manual.

Connecting an IR Remote Receiver to the projector.

This infrared receiver unit makes it possible to control the projector from another room. There is a communication line cable between the IR receiver and the projector or the RCVDS. The control information from the RCU can now be sent to the IR Remote Receiver.

The IR Remote Receiver displays the selected source on a 7-segment display.

Connecting a Rugged Remote to the projector.

The Rugged Remote Control allows following functions:

- Remote mode : sends actions to and reads information from the projector.
- Lamp read mode : reads information stored in the lamp information module.

The following types of Rugged Remote Control are available:

- wireless (order number **R9840171**)
- wired to CTRL3 (order number **R9840170**)

For more information about the use of this remote control, consult the user manual R5976251.

4.6.4 Network connection



Only 10 Base-T connection

What can be done?

When the optional network connection is installed, the projector can be connected to a LAN (local area network) (Ethernet). Once installed and connected to the LAN, users are capable of accessing the projector from any location, inside or outside their company network from a standard web browser. The projector acts as web server and generates a web site with all functions of the projector listed. Via an internet explorer 4.0 or higher, or a Netscape communicator, the user can insert the correct IP-address of the projector and access the webpages. Once the web site is accessed, it is possible to check and manipulate all the projector settings. Remote diagnostics, control and monitoring of the projector can then become a daily and very simple operation. The network connectivity permits to detect potential errors and consequently improve the time to servicing.

4. Connections

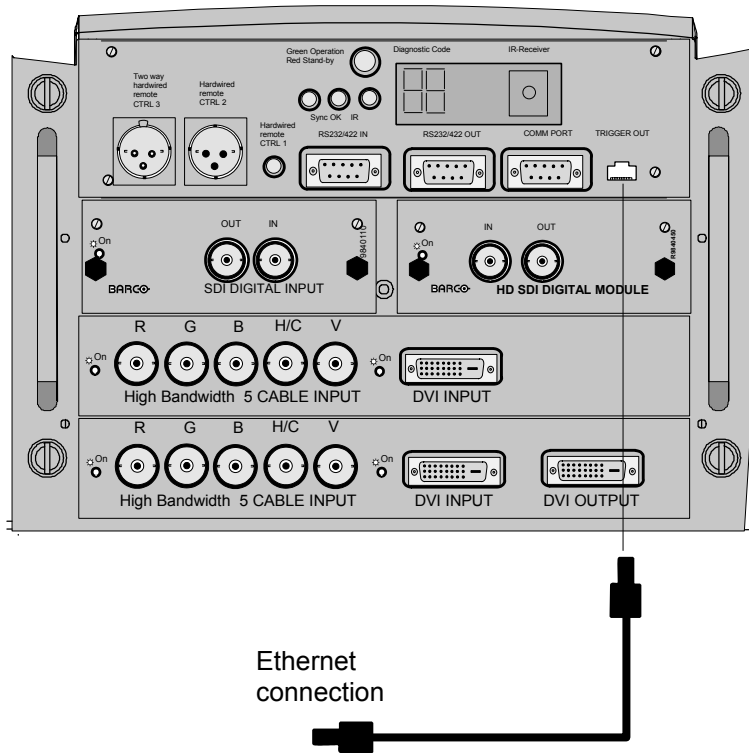

Image 4-10



Always use an Ethernet cable with ferrite core to connect the projector to the LAN.

5. GETTING STARTED

5.1 RCU & Local keypad

How controlling the projector ?

The projector can be controlled by the local keypad or by the remote control unit.

Location of the local keypad ?

The local keypad is located on the input side of the projector.

Remote control functions.

This remote control includes a battery powered infrared (IR) transmitter that allows the user to control the projector remotely. This remote control is used for source selection, control, adaptation and set up. It includes automatic storing of picture controls (Brightness, Sharpness...) and settings.

Other functions of the remote control are :

- switching between stand by and operational mode.
- switching to "pause" (blanked picture, full power for immediate restarting)
- direct access to all connected sources.

5.2 Terminology overview

Overview

The following table gives an overview of the different functionalities of the keys.

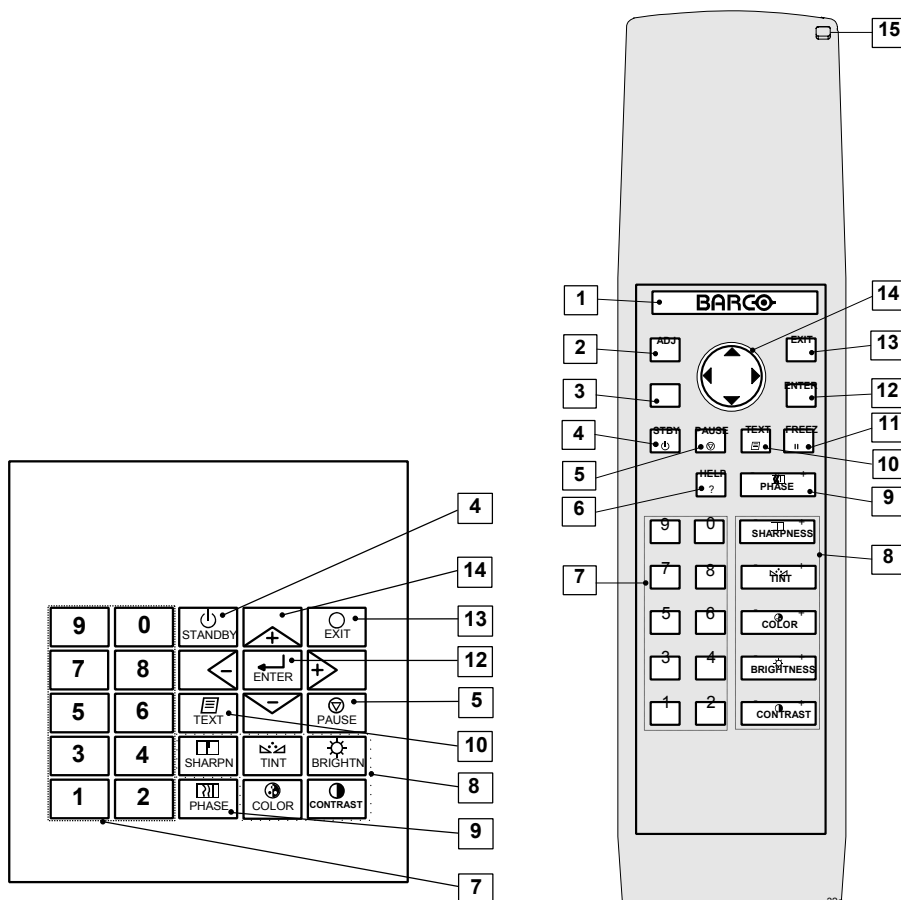

Image 5-1
Local keypad & RCU

5. Getting Started

1	Barco key	selection key, to get direct access to the lens adjustment menus.
2	ADJ	ADJUST key, to enter or exit the adjustment mode.
3	Address key	(recessed key), to enter the address of the projector (between 0 and 9). Press the recessed address key with a pencil, followed by pressing one digit button between 0 and 9.
4	STDY	stand-by button, to start projector when the power switch is switched on and to switch off the projector without switching off the power switch.
5	PAUSE	to stop projection for a short time, press 'PAUSE'. The image disappears but full power is retained for immediate restarting.
6	Help	n line help information (not yet available)
7	Digit buttons	direct input selection
8	Picture controls	use these buttons to obtain the desired picture analog level.
9	PHASE	used to remove the instability of the image.
10	TEXT	when adjusting one of the image, e.g. controls during a meeting, the displayed bar scale can be removed by pressing 'TEXT' key first. To re-display the bar scale on the screen, press 'TEXT' key again. When TEXT is 'off', no adjustment menu's will be displayed on the screen when entering the adjustment mode.
11	FREEZ	press to freeze the projected image.
12	ENTER	to start up the adjustment mode or to confirm an adjustment or selection in the adjustment mode.
13	EXIT	to leave the adjustment mode or to scroll upwards when in the adjustment mode.
14	Cursor keys	(on RCU) or '+' and '-' keys (cursor keys) on the local keypad : to make menu selections when in the adjustment mode or to zoom/focus when the direct access is active. Comparison between the cursor keys and the use of the '+' and '-' keys on the local keypad : RCU = local keypad cursor key up = '+' key up cursor key down = '-' key down cursor key right = '+' key right cursor key left = '-' key left Use the '+' and '-' keys (cursor keys) : to increase or decrease the analog level of the image controls when they are first selected.
15	RC Operating indication	lights up when a button on the remote control is pressed. (This is a visual indicator to check the operation of the remote control)

Table 5-1

5.3 Operating the projector

5.3.1 Switching on

How to switch on.

1. Press the power switch to switch on the projector.
 - When '0' is visible, the projector is switched off.
 - When '1' is visible, the projector is switched on.

The projector starts in standby mode.

Starting image projection.

1. Press **Stand by** key once on the local keypad or on the remote control.

The projector mode indication lamp will be green (image 5-2)

Or,

Press a digit button to select an input source.

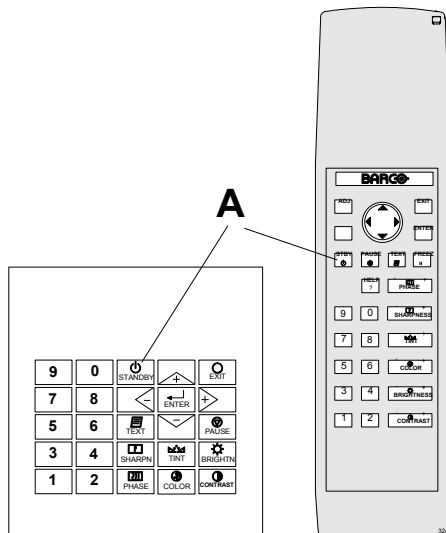

Image 5-2

Lamp Run time indication

see chapter "4. Connections", "Switching on", page 31

Lamp Light output indication

see chapter "4. Connections", "Switching on", page 31

Lamp Z-axis indication

see chapter "4. Connections", "Switching on", page 31

5.3.2 Switching to standby

How to switch to standby?

1. Press **Standby** to switch the projector to standby.



Switching to Standby. When the projector is running and you want to go to standby, press the standby key for 2 seconds until the message 'Saving data, please wait' is displayed. Do not press any longer on the standby key otherwise the projector will restart.

5.3.3 Switching off

How to switch off the projector?

1. Press first **Standby**.
2. Let cool down the projector until the fans stop blowing, at least 15 min.
3. Switch off the projector with the power switch.

5.3.4 Temperature error DMD

Overview

When the temperature of one of the DMD is too low or too high the projector will be switched automatically to standby. Before switching to standby, the following message appears for 3 seconds on the screen : 'DMD out of operating temperature range. Automatic shutdown is activated.'

A 't' appears on the LED display to indicate the user that the projector is switched to standby due to DMD temperature problems.

Operating temperature range of the DMD : +10°C and +35°C.

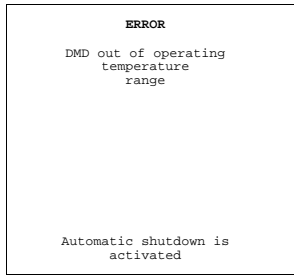

Menu 5-1

5.4 Quick Set Up Adjustments

Overview

- Quick Language Change
- Quick Lens Adjustment
- Quick On Screen Color change

5.4.1 Quick Language Change

What can be done?

Only if different on screen languages are available, these can be changed in quick way by following the next procedure.

How to change

1. Press **ENTER** to start up the adjustment mode.
2. Press the cursor key ↑ or ↓ to highlight *Service*. (menu 5-2)
When password protected, your password will be asked. (more explanation about access by password can be found in Chapter 'Start up the Adjustment mode').
3. Press **ENTER** to display the Service mode menu.
4. Push the cursor key ↑ or ↓ to highlight *Change Language*. If not visible in the menu, highlight first *More* and press **ENTER** to display a second service menu. Select then *Change Language*. (menu 5-3)
5. Press **ENTER** to display the *language selection* menu.
6. Push the cursor key ↑ or ↓ to highlight the desired language. (menu 5-4)
Note: *For the moment, only English is available.*

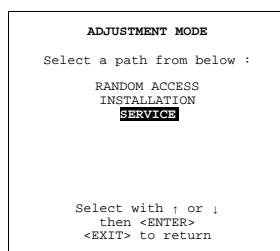

Menu 5-2

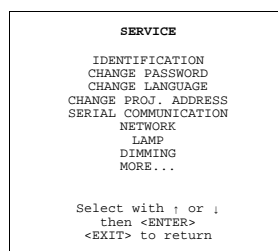

Menu 5-3

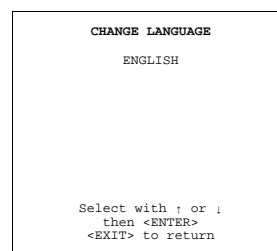

Menu 5-4

5.4.2 Quick Lens Adjustment

Quick zoom/focus adjustment

1. Press the Selection key *, Barco key.
The zoom/focus menu will be displayed. (image 5-3)
2. Push the cursor key ↑ or ↓ to zoom and ← or → to focus the image.
3. When finished, press **EXIT** key to return or **ENTER** to continue to the shift adjustment.

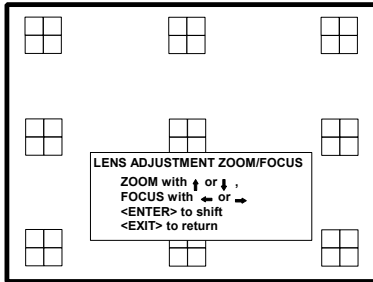

Image 5-3



Press the selection key * to switch to another pattern. Different patterns are available.

Quick shift adjustment

1. Press the Selection key *, Barco key.
The zoom/focus menu will be displayed (image 5-3).
2. Press **ENTER**.
The shift menu will be displayed. (image 5-4)
3. Push the cursor key ↑ or ↓ to shift the image up or down and ← or → to shift the image left or right.
4. When finished, press **EXIT** key to return or **ENTER** to continue to zoom/focus.

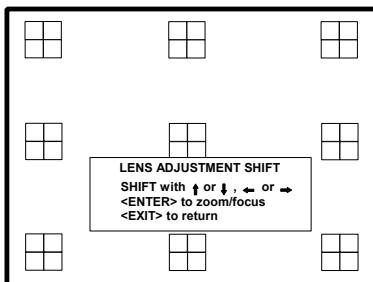

Image 5-4



Press the selection key * to switch to another pattern. Different patterns are available.

5.4.3 Quick On Screen Color change

What can be done ?

For quick change of the on-screen color of the highlighted items.

The highlighted items on the menus can be displayed in red, green or yellow.

How to change ?

1. Press **ENTER** to start up the adjustment mode.
2. Push the cursor key ↑ or ↓ to highlight *Installation*. (menu 5-5)
3. Press **ENTER** to select.
4. Push the cursor key ↑ or ↓ to highlight *OSD*. (menu 5-6)
5. Press **ENTER** to select.

The OSD menu will be displayed. (menu 5-7)

5. Getting Started

6. Push the cursor key ↑ or ↓ to highlight *Highlighted item color*.
7. Press **ENTER** to toggle between red, green and yellow.

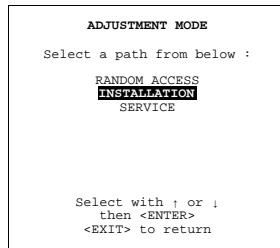

Menu 5-5

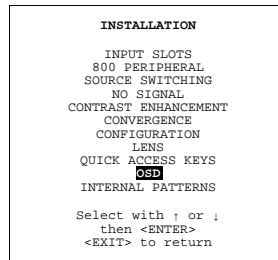

Menu 5-6

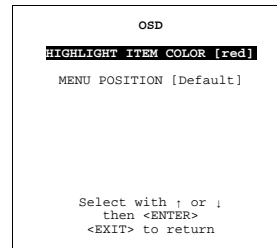

Menu 5-7

5.5 Using the RCU

Pointing to the reflective screen

1. Point the front of the RCU to the reflective screen surface. (image 5-5)

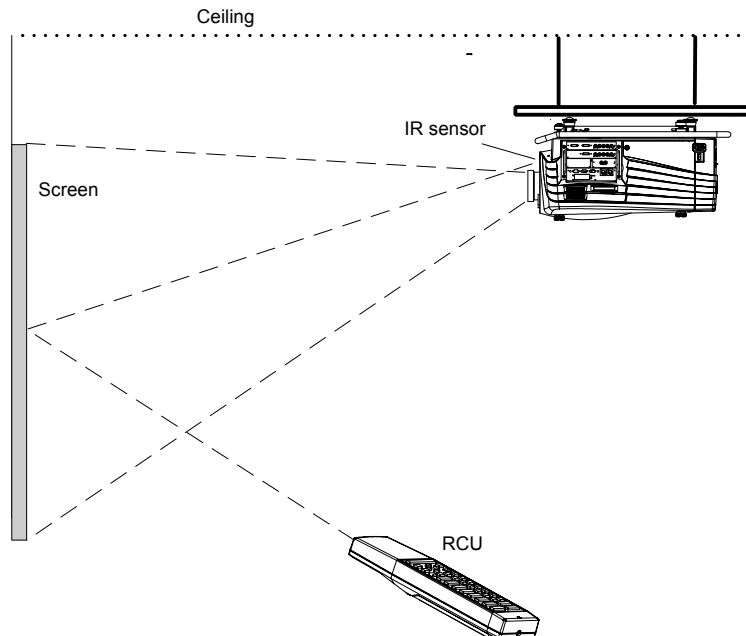

Image 5-5

Hardwired Remote Input

1. Plug one end of the remote cable in the connector on the bottom of the RCU.
2. Plug the other end in the connector in the front panel of the projector labelled **RC**. (image 5-6)

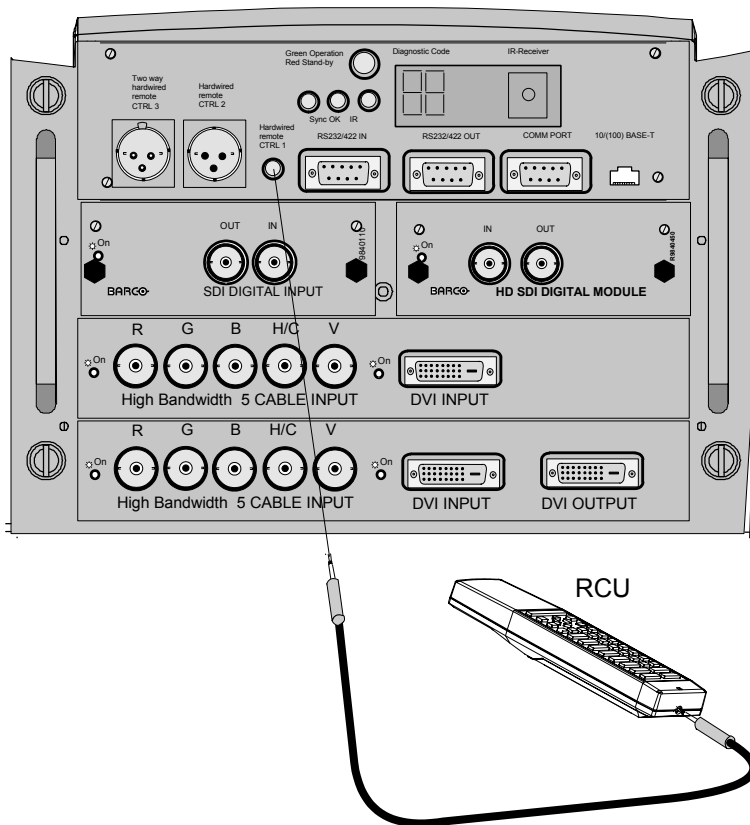

Image 5-6

Hardwired to the XLR input

1. Plug one end of the remote cable in the connector on the bottom of the RCU
2. Plug the other end in the connector in the front panel of the projector labelled **Hardwired CTRL2**. (image 5-7)

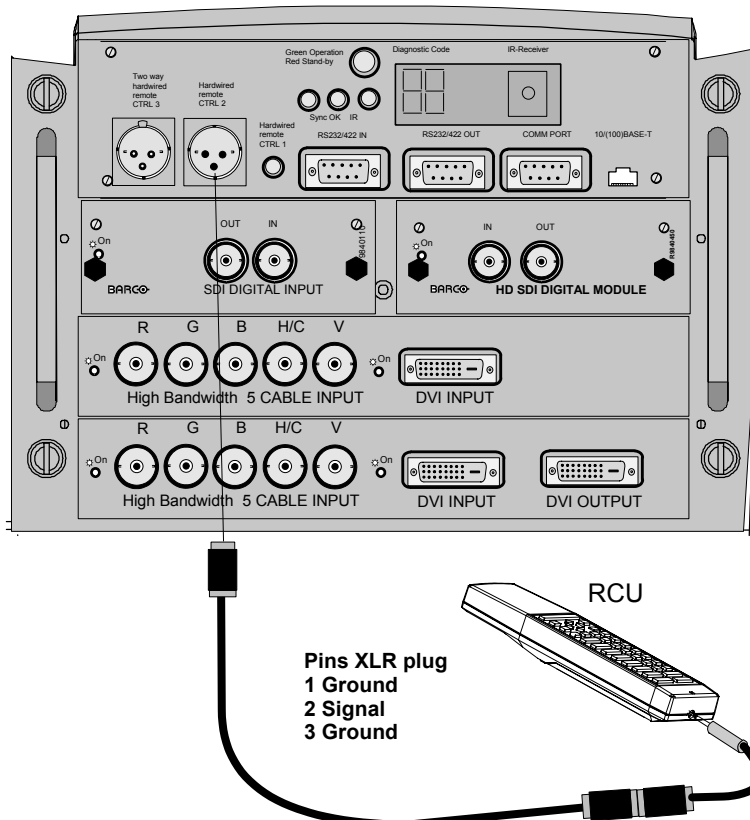

Image 5-7

Directly to one of the IR sensors

When using the wireless remote control, make sure you are within the effective operating distance (30m, 100ft in a straight line). The remote control unit will not function properly if strong light strikes the sensor window or if there are obstacles between the remote control unit and the projector IR sensor.

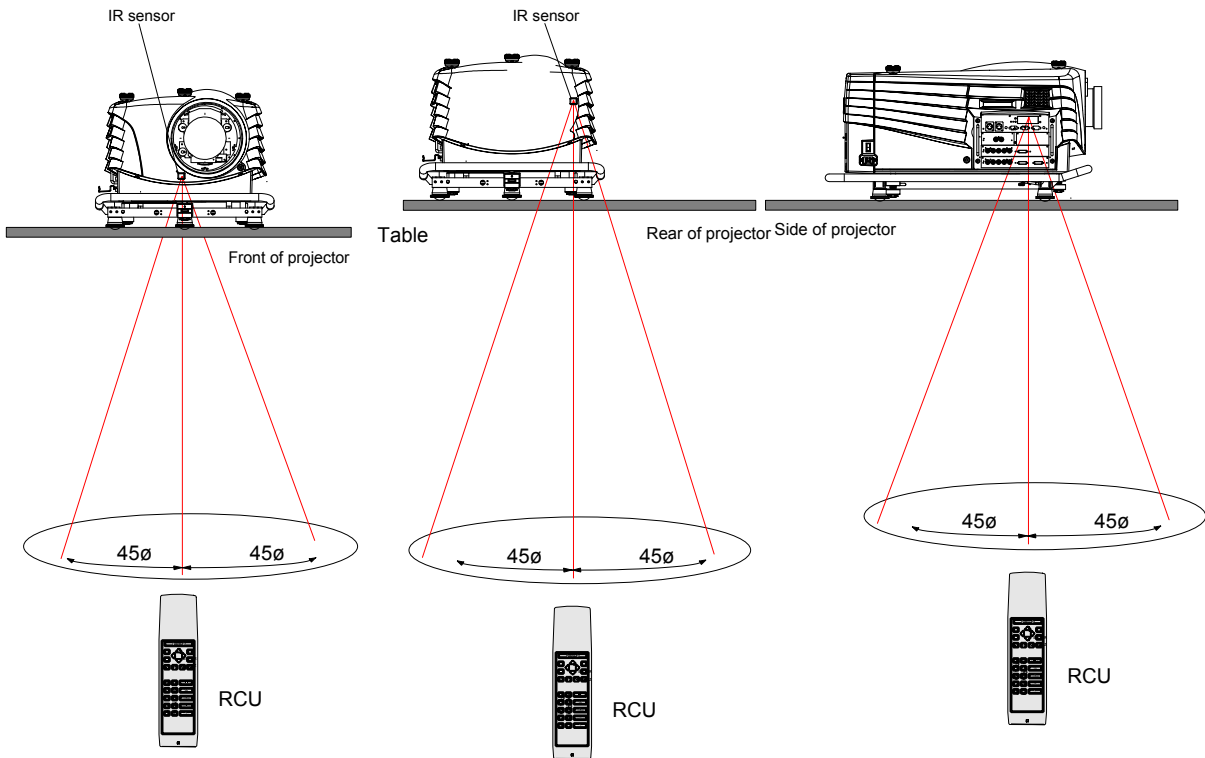

Image 5-8

5.6 Projector Address

5.6.1 Controlling the projector



Projector address

Address installed in the projector to be individually controlled.



Common address

Default address. Projector will always execute the command coming from a RCU programmed with that common address.

Why a projector address ?

As more than one projector can be installed in a room, the separate projector should be separately addressable with an RCU or computer. There for each projector has its own address.

Set up an individual Projector Address.

The set up of a projector address can be done via the software. See 'Change projector address' in chapter 'Service mode'.

Projector controlling.

Every projector requires an individual address between 0 and 255 which can be set in the Service mode.

When the address is set, the projector can be controlled now:

- RCU for addresses between 0 and 9.
- computer, e.g. IBM PC (or compatible), Apple MAC, etc. for addresses between 0 and 255.

Common Address

Every projector has a common address '0' or '1'. The choice between '0' and '1' can be selected in the Service mode.

5.6.2 Displaying and Programming addresses

Displaying the Projector Address on the Screen.

1. Press **Address** key (recessed key on the RCU) with a pencil.

The projector's address will be displayed in a 'Text box'



To continue using the RCU with that specific address, it is necessary to enter the same address with the digit buttons (address between 0 and 9) within 5 seconds after pushing the address key. For example : if the Address key displays projector address 003, then press "3" digit button on the RCU to set the RCU's address to match the projector's address. Do not press 003 digits. This will address the remote control to '0' and control all projectors in the room. If the address is not entered within 5 seconds, the RCU returns to its default address (zero address) and control all projectors in the room.

How to Program an Address into the RCU?

1. Press the **Address** key (recessed key on the RCU) with a pencil.
2. Enter the address with the digit buttons within 5 seconds after pushing the address key.

Note: That address can be any digit between 0 and 9.

5.7 Controlling the Projector

Input Selection

Key in the corresponding slot number with the digit keys on the RCU. The selected source will be displayed.

Picture Controls

When an image control is pressed, a text box with a bar scale, icon and function name of the control, e.g. 'brightness...' appears on the screen (only if text is ON). See example screen. The length of the bar scale and the value of the numeric indication indicate the current memorized setting for this source. The bar scale changes as the control stick on the RCU is pressed or the + or - buttons on the local keypad.

Brightness	A correct 'brightness' setting is important for good image reproduction. Use the + button for a higher brightness. Use the - button for a lower brightness.
Contrast	A correct 'contrast' setting is important for good image reproduction. Adjust the contrast to the level you prefer, according to room lighting conditions. Use the + button for a higher contrast. Use the - button for lower contrast.
Color	Color saturation is only active for Video and S-Video. Adjust the color intensity of the picture. Use the + button for richer colors. Use the - button for lighter colors.
Tint	Tint is only active for Video and S-Video when using the NTSC 4.43 or NTSC 3.58 system. Use the + button Use the - button.
Sharpness	no sharpness available
Phase	Use the arrow buttons to adjust the phase.

The Pause Key

When the Pause key is pressed, the image projection is stopped, a black screen will be displayed and the projector remains with full power for immediate restart. The sound is not interrupted. The display on front of the projector will show a "P".

To restart the image :

- Press **Pause** key.
- Press **EXIT** key
- Select a source number.

The Stand-by Key

When the Stand-by key is pressed, the image projection is stopped and the projector goes to stand-by. This situation is used when a projection stop is planned for a longer period.

6. START UP OF THE ADJUSTMENT MODE

6.1 Start up

Possible paths

There are 3 possible paths to follow once in the Adjustment mode. They are :

- Installation - Installation should be selected if a new input module is installed or a new source is connected to an existing input module. Also when the projector is relocated in a new configuration.
- Random Access - Random Access should be selected to set up a new source.
- Service - Service should be selected if the user intends to change general settings such as password, language, address, etc. or some service actions or get set-up information.

How to start up.

1. Press **ADJUST** or **ENTER** to enter the Adjustment mode.
The adjustment mode opens. (menu 6-1)
2. The cursor key (RCU) or '+' or '-' keys (local keypad) are used to make menu selections and also for adjustments.
3. The **ENTER** and **EXIT** keys are used to move forward and backward through the menu structure.
4. The **ADJUST** key can be used to terminate the adjustment mode while any path selection menu is displayed.

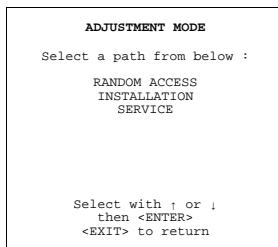

Menu 6-1

6.2 Password

Password protection of some items.

Some items in the Adjustment mode are password protected. While selecting such an item, the projector asks to enter your password (Password protection is only available when the password strap on the controller module is ON, call an authorized service center to change the position of the password strap).

Entering your password

1. The first digit position is highlighted. Enter the first digit. (menu 6-2)

The highlighted square jumps to the next position.

2. Continue with the other digits

Example : 2 3 1 9

When your password is correct, you gain access to the selected item.

When your password is wrong. The error message Invalid password is displayed on the screen. Press **EXIT** to continue and to return to the adjustment menu.

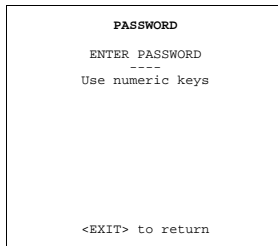

Menu 6-2



Factory programmed password : 0 0 0 0

Password remark

When re-entering the Adjustment mode, it will be necessary to enter the password again when selecting a password protected item.

Changing your password

To change your password, see chapter Service Mode, Change Password.

6.3 Menus on Local LCD Display

Overview

When text is 'off', no menus will be displayed on the projection screen. But on the local LCD display, it is still possible to scroll through the menus. The menus will be displayed line by line in the same order as they were displayed on the projection screen. Adjustments can be done while the projector is running without projecting the disturbing menus on the screen.

Use the cursor keys to scroll through the menus and press **ENTER** to activate the displayed menu.

7. RANDOM ACCESS ADJUSTMENT MODE

Overview

- Overview Flow
- Picture Services
- Picture Tuning
- Geometry
- ScenergiX
- Picture in Picture (PiP)
- Save Changes

7.1 Overview Flow

Overview

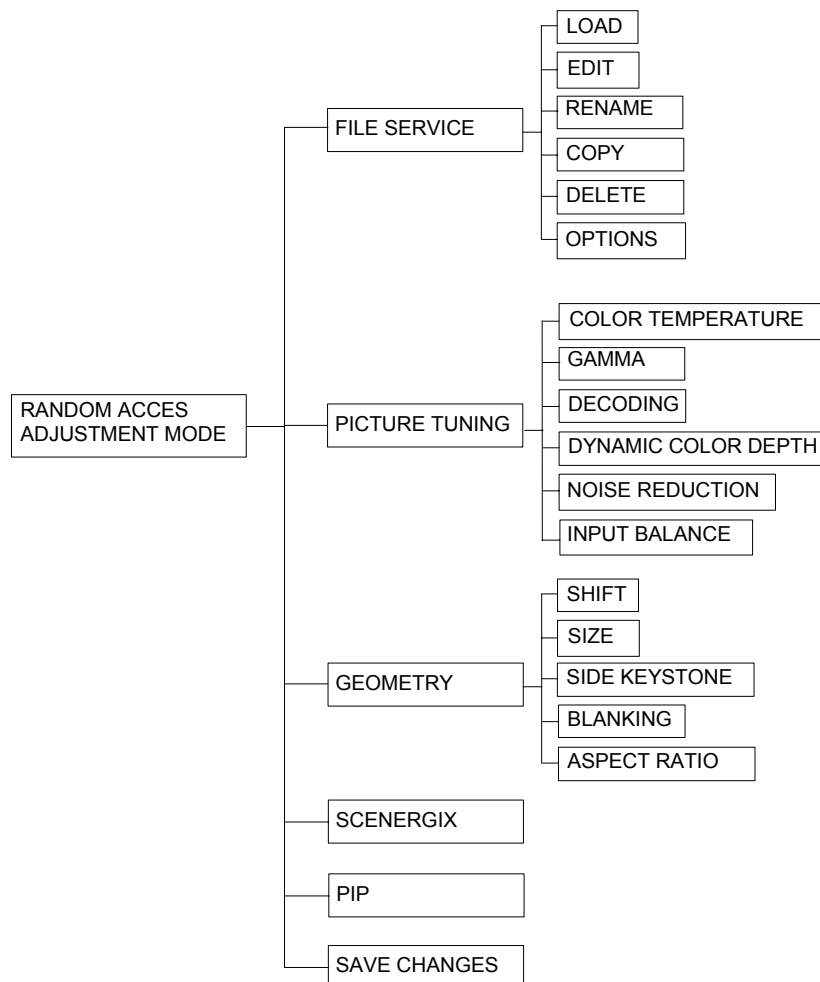
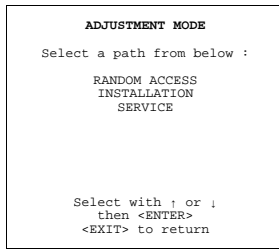

Image 7-1

Start up

1. Push the cursor key ↑ or ↓ to highlight *Random Access*. (menu 7-1)
2. Press **ENTER**. (menu 7-2)



Menu 7-1

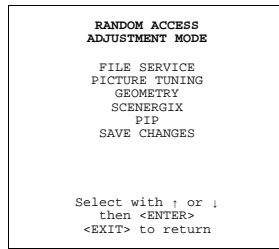

Menu 7-2

7.2 Picture Services

7.2.1 File annotation

How a file is built up

The file notation on a menu is built up in different parts. Let us have a look to these parts.

Take the following notation : xxxxxxxx.eee n ppppXppppi

xxxxxxx	base name, 8 characters
eee	file extension first character C : custom made file first character S : standard file The second and third character is used for a following number (= file index). The file index for custom files : 00 to 63.
n	source number
ppppXpppp	active pixel rating
i	i or blank i = interlaced file blank = not interlaced

Table 7-1

7.2.2 Possible file manipulations

Connecting a new source.

Before using a new source, a correct file has to be installed. The projector's memory contains a list of files corresponding to the most used sources. When the new source corresponds with one of these files, the file can be loaded and saved for future use. When there is a little difference, the file can also be loaded and then edited until the source specs are reached.



file loading can be done automatically (see "File Options", page 66). Files with a ~ in front of the file name are temporary files. These files will be deleted when switching to another source.

Possible file Manipulations

The following file manipulations are possible :

- Load : installation of a file for a new source.
- Edit : editing a loaded file to the source specs.
- Rename : renaming a file.
- Copy : copying a file.
- Delete : deleting a file
- Options : way of sorting the files.

7.2.3 Start up

Start up

To enter the File Service, handle as follow :

1. Push the cursor key ↑ or ↓ to highlight *File Service*. (menu 7-3)
2. Press **ENTER** to select.

The *File Service* menu will be displayed. (menu 7-4)

```

RANDOM ACCESS
ADJUSTMENT MODE

FILE SERVICE
PICTURE TUNING
GEOMETRY
SCENERGIX
PIP
SAVE CHANGES

Select with ; or |
then <ENTER>
<EXIT> to return

```

Menu 7-3

```

FILE SERVICE

LOAD
EDIT
RENAME
COPY
DELETE
OPTIONS

Select with ; or |
then <ENTER>
<EXIT> to return

```

Menu 7-4

7.2.4 Load file

Start up Load file

To start up the load file, handle as follow :

1. Push the cursor key ↑ or ↓ to highlight *Load*. (menu 7-5)
2. Press **ENTER** to select.

The *Load* menu displays the corresponding files depending on the installed filter. (menu 7-6)

```

FILE SERVICE

LOAD
EDIT
RENAME
COPY
DELETE
OPTIONS

Select with ; or |
then <ENTER>
<EXIT> to return

```

Menu 7-5

```

LOAD FILE
FILTER LIST [All]

Filename  Src  resolution
video525.s01 1 675x240i
video525.c01 1 675x240i
video525.c02 1 675x240i
-----
Active file : Video525.c50

Select with ; or | , -
<ENTER> to accept
<EXIT> to return

```

Menu 7-6

Changing the filter setting

1. Push the cursor key ↑ or ↓ highlight *filter list*.
2. Press **ENTER** to toggle the annotation between brackets.

[All] : all files that can be loaded will be displayed.

[Fit] : only the best fitting files will be displayed (with a distinction of ± 2 lines and line duration of ± 300 ns, if nothing is found within this small area, the projector continues searching until it finds something).

7. Random Access Adjustment Mode

How to load a file ?

1. Push the cursor key ↑ or ↓ to select the best fitting file. (menu 7-7)
2. Press **ENTER** to select.

A confirm Load file menu will be displayed with the newly created file and the one on which the new file is based on. (menu 7-8)

3. Press **ENTER** to confirm the new creation or **EXIT** to return to the load file menu.

```
LOAD FILE
FILTER LIST [All]

Filename  Src      resolution
video525.s01 1      675x240i
video525.c01 1      675x240i
video525.c02 1      675x240i
-----
Active file : Video525.c50

Select with ; or | , -
<ENTER> to accept
<EXIT> to return
```

Menu 7-7

```
CONFIRM
LOAD FILE

create file
Video525.c02
based on file
Video525.s01?

<ENTER> to return
<EXIT> to return
```

Menu 7-8



During a load file, the actual file is displayed next to the indication *Active file*.



When scrolling through the files, the image will be adapted according to the settings of the selected file (on line adaptation).

The image is not perfect ?

If the displayed image is not correct after selecting the best fitting file, go to the Edit menu, select the active file and change the File settings.

7.2.5 Edit File

7.2.5.1 Start up

How to start up the Edit menu ?

To start up the EDIT menu :

1. Push the cursor key ↑ or ↓ to highlight *Edit*. (menu 7-9)
2. Press **ENTER** to select.

The Edit file adaptation menu will be displayed. (menu 7-10)

3. Select the file which must be edited (mostly the active file).
4. Press **ENTER**.

The file name will be displayed in the upper right corner. (menu 7-11)

```
FILE SERVICE

LOAD
EDIT
RENAME
COPY
DELETE
OPTIONS

Select with ; or |
then <ENTER>
<EXIT> to return
```

Menu 7-9

```
EDIT FILE

Filename  Src      resolution
video525.s01 1      675x240i
video525.c01 1      675x240i
video525.c02 1      675x240i
-----
Active file : Video525.c50

Select with ; or | , -
<ENTER> to accept
<EXIT> to return
```

Menu 7-10

```
EDIT FILE xga.s30

HORIZONTAL
TOTAL      1344 PIXELS
ACTIVE     1024 PIXELS
START      296 PIXELS
PERIOD     20.678 µS
VERTICAL (FIELD)
TOTAL      806 LINES
ACTIVE     768 LINES
START      36 LINES
INTERLACED [OFF]
READ AMDS
OPTIONS

; , | , - , - <ENTER> , <EXIT>
```

Menu 7-11

7.2.5.2 Changing the settings

Different methods

The 3 different methods to change a setting will be described hereafter. These methods are:

- with the numeric keys on the remote control.
- with the arrow keys selecting the changing digit.
- with the arrow keys counting up or down.

How to change a setting with the numeric keys?

1. Push the cursor key ↑ or ↓ to highlight an item.
The color of the selected item will change.
2. Press **ENTER** to activate the digits.
3. Enter directly with the numeric keys on the RCU or local keypad the new value.

How to change a setting with the cursor keys?

1. Push the cursor key ↑ or ↓ to highlight an item.
The color of the selected item will change.
2. Press **ENTER** to activate the digits.
3. Push the cursor key ← or → to select the changing digit.
4. Push the cursor key ↑ or ↓ to scroll to the desired digit.
5. When finished, press **ENTER** to confirm.

How to change a setting with the cursor keys and counting up or down?

1. Push the cursor key ↑ or ↓ to highlight an item.
The color of the selected item will change.
2. Press **ENTER** to activate.
3. Counting up or down by pushing the cursor key ← or →.

7.2.5.3 Correct value

What is already available during start up?

During the installation of a file with LOAD, the horizontal period, the total number of vertical lines and the interlaced mode are automatically measured and filled in in the menu table. These values will be available when starting up the EDIT procedure of an active file.



CAUTION: Do not adjust these settings on an active file, they are used to identify the input source file.

How to find the correct values for the item in the Edit file menu?

Horizontal Total Pixels	If the value for "Horizontal Total Pixels" is wrong, sampling mistakes (small vertical bars in the projected image) will be seen in the image. Select "Total" and adjust the pixel quantity. Adjust for zero bars. hint: if the number of bars increase, adjust in the other direction.
Active Pixels	The "Active Pixels" : determine the width of the window on the screen. This value is normally given in the source specifications. If not, adjust until full image is displayed (no missing pixels).
Horizontal Start	number of pixels between the beginning of the input signal and the start of the video information in the signal.
Horizontal Period	already filled in with the correct value when active file.
Vertical Total Lines	already filled when an active file is selected to be edited
Active Lines	number of horizontal lines determining the height of the projected image. This value is normally given in the specification of the source. If not, adjust until full image height is displayed (no missing lines)

7. Random Access Adjustment Mode

Vertical Start	number of lines between the start of the input signal and start of the image on the screen.
Interlaced [On] or [Off]	this selection is automatically filled when active file has to be edited. If the image is wrong due to mismeasurement, use the ENTER key to toggle between [On] and [Off]. (for interlaced images, 1 frame contains 2 fields).
Read AMDS	AMDS = automatic mode detection & synchronization During the installation of a file with LOAD, the system automatically measured the horizontal period, the total vertical lines and the interlaced mode. When selecting Read AMDS, the system remeasures the above indicated items.

How to install the correct settings for the options in the Edit file menu.

```

EDIT FILE OPTIONS
Source number      1
Clamp position    [leading]
Clamp delay       10
Clamp width       [pos]
Field polarity    [both]
Field select      [sync]
Vertical refresh  [on]
Film Mode Detection [on]
Banner Protect    [on]

Select with ↑ or ↓
<ENTER> to toggle
↑ or ↓ to change value
<EXIT> to return
    
```

Menu 7-12

Source number	The source number of a non-active file can be changed to any other source number. This makes it possible to create a file for future source numbers.
Clamp position	Clamping determines the black level of the signal. The clamp pulse can be related to the leading or the trailing edge of the sync pulse. Use the ENTER key to toggle between [leading] and [trailing].
Clamp delay	The time between the leading edge of the clamp pulse and the locked edge of the sync pulse. Can be any value between 0 and 255. Change the value by pushing the cursor key ↑ or ↓.
Clamp width	The width of the clamp pulse can be any value between 0 and 255. Change the value by pushing the cursor key ↑ or ↓.

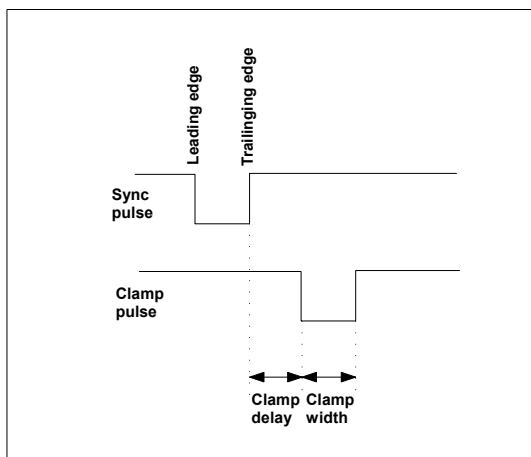

Image 7-2
Example for *Clamp position* [trailing]

Field polarity	The field polarity function is used for interlaced images. Both rasters of the image could be shifted in a wrong way (double lines are visible in the image). This can be corrected by forcing the field polarity to [neg] or [pos]. Use the ENTER key to toggle between [pos] and [neg].
Field select	Default [both] The field select is only used for interlaced images. One frame of an interlaced image contains two fields, an even and an odd field. The choice exists to project [both] fields on the screen or only the [even] or [odd] field. This can be useful for 3D projection. Use the ENTER key to toggle between [both], [even] and [odd].

Vertical refresh [sync/async]	<p>The way of updating the image information. Not available for PAL-NTSC-SECAM sources. This option will be displayed in gray.</p> <ul style="list-style-type: none"> For sources with a vertical frequency up to 60 Hz : the vertical refresh rate is the same as the vertical frequency of the incoming source. This is a necessity to project moving images without 'motion artifacts'. For stationary images with a vertical frequency up to 60 Hz it is still possible to use asynchronous refresh. When loading Pal, Secam, NTSC-files the synchronous mode is default, for all other sources below 60 Hz asynchronous mode is default. For sources with a vertical frequency higher than 60 Hz : the vertical refresh is different than the vertical frequency of the incoming source. Synchronous refresh cannot be used.
Film mode detection: [On] or [Off]	<p>Detects in the [on] mode if the source is film or video. Use the ENTER key to toggle between [on] or [off]</p> <p>When enabled, the hardware looks for tell-tale signs of 3:2 or 2:2 pull-down sequences. These are the result of converting cinema material recorded at 24 frames-per-second to the television frequencies of 60 or 50 interlaced fields per second respectively. When FILM conversion is detected, the original 24 frames-per-second are restored. This avoids deinterlacing artefacts, and results in a perfect artefact-free display. Note that in some cases (video clips, scrolling newstickers,...) FILM and VIDEO material are mixed on one screen. This may confuse the detector and cause it to go into FILM restoration mode. This will cause "jaggies" or motion artefacts. In such cases, disabling FILM mode processing is the best cure.</p>
Banner Protect: [On] or [Off]	<p>Only active when film mode detection is in the on position. Use the ENTER key to toggle between [on] or [off].</p> <p>FILM mode processing normally processes the entire display, but this may cause problems on sources where video and FILM content are mixed. One very common example is scrolling banners at the bottom of the screen (e.g. financial news). For those cases, the "banner protect" feature will force the bottom quarter of the screen to be always processed in VIDEO mode, regardless of the rest of the screen, which may be either video or FILM mode.</p>



3:2 pull-down

Method used to map the 24 fps of film onto the 30 fps (60 fields) or 25 fps (50 fields), so that one film frame occupies three video fields, the next two, etc. It means the two fields of every other video frame come from different film frames making operations such as rotoscoping impossible, and requiring care in editing. Some sophisticated equipment can unravel the 3:2 sequence to allow frame-by-frame treatment and subsequently re-compose 3:2. The 3:2 sequence repeats every five video frames and four film frames, the latter identified as A-D. Only film frame A is fully on a video frame and so exists at one time code only, making it the editable point of the video sequence.



2:2 pull-down

The process of transferring 24-frames/sec film format into video by repeating each frame (used for PAL DVD's) as two video fields. (AD)



Artefacts

Undesirable elements or defects in a video picture. These may occur naturally in the video process and must be eliminated in order to achieve a high-quality picture. Most common in analog are cross color and cross luminance. Most common in digital are macroblocks, which resemble pixelation of the video image.

7.2.6 Rename

Start Up

To change the name of a selected file :

1. Push the cursor key ↑ or ↓ to highlight *Rename*. (menu 7-13)
2. Press **ENTER**.

The Rename selection menu will be displayed. (menu 7-14)

3. Push the cursor key ↑ or ↓ to select a file name.
4. Press **ENTER** to select.

The Rename file menu will be displayed with the selected file name already filled in, in the 'From file name :' area and in the 'To file name :' area. The first character in the 'To file name :' area is highlighted. (menu 7-15)

```
FILE SERVICE
LOAD
EDIT
RENAME
COPY
DELETE
OPTIONS

Select with ; or |
then <ENTER>
<EXIT> to return
```

Menu 7-13

```
RENAME FILE
Filename Src resolution
video525.s01 1 675x240i
video525.c01 1 675x240i
video525.c02 1 675x240i

-----
Active file : Video525.c50

Select with ; or |, -
<ENTER> to accept
<EXIT> to return
```

Menu 7-14

```
RENAME FILE
From file name :
Video525.c01
To file name :
demo.c10

Select with - or -
Reprogram with ; or |
or numeric keys
<ENTER> to confirm
<EXIT> to return
```

Menu 7-15

Changing the characters

1. Push the cursor keys ← or → to select the desired character. (menu 7-16)
Or,
Change that character by pushing the cursor keys ↑ or ↓. Numeric characters can be entered directly with numeric keys on the RCU.
Or,
Press **ENTER** to confirm.

The renamed file is entered in the list of files.

2. Press **EXIT** to return to the Rename menu selection.
No changes are made.

```
RENAME FILE
From file name :
Video525.c01
To file name :
demo.c10

Select with - or -
Reprogram with ; or |
or numeric keys
<ENTER> to confirm
<EXIT> to return
```

Menu 7-16

7.2.7 Copy

Start Up

To copy the name of a selected file :

1. Push the cursor key ↑ or ↓ to highlight *Copy*.
2. Press **ENTER**.

The Copy selection menu will be displayed. (menu 7-17)

3. Push the cursor key ↑ or ↓ to select a file name.
4. Press **ENTER** to select.

The Copy file menu will be displayed with the selected file name already filled in, in the 'From file name : ' area and in the 'To file name : ' area. The first character in the 'To file name : ' area is highlighted. (menu 7-18)

```

COPY FILE
Filename  Src      resolution
video525.s01 1      675x240i
video525.c01 1      675x240i
video525.c02 1      675x240i
-----
Active file : Video525.c50

Select with ↑ or ↓, →
<ENTER> to accept
<EXIT> to return

```

Menu 7-17

```

COPY FILE

From file name :
Video525.s01
To file name :
demo.c10

Select with ← or →
Reprogram with ↑ or ↓
or numeric keys
<ENTER> to confirm
<EXIT> to return

```

Menu 7-18

Changing the characters

1. Push the cursor keys ← or → to select the desired character. (menu 7-19)
Or,
Change that character by pushing the cursor keys ↑ or ↓. Numeric characters can be entered directly with numeric keys on the RCU.
Or,
Press **ENTER** to confirm.

The copy file is entered in the list of files.

2. Press **EXIT** to return to the Copy menu selection.

No changes are made.

```

COPY FILE

From file name :
Video525.s01
To file name :
demo.c10

Select with ← or →
Reprogram with ↑ or ↓
or numeric keys
<ENTER> to confirm
<EXIT> to return

```

Menu 7-19

7.2.8 Delete

Start up and delete

To delete a selected file out of the list of files :

1. Push the cursor key ↑ or ↓ to highlight *Delete*. (menu 7-20)
2. Press **ENTER**.

The delete selection menu will be displayed. (menu 7-21)

3. Push the cursor key ↑ or ↓ to select a file name.

7. Random Access Adjustment Mode

4. Press **ENTER** to select.

If [all] is selected, your password has to be entered before all files will be deleted.

A confirmation menu "Delete file 'file name'?" is displayed. (menu 7-22)

5. Press **ENTER** to delete the file, press **EXIT** if you want to keep it.

Note: The active file cannot be deleted.

```
FILE SERVICE
LOAD
EDIT
RENAME
COPY
DELETE
OPTIONS

Select with ↑ or ↓
then <ENTER>
<EXIT> to return
```

Menu 7-20

```
DELETE FILE
Filename Src rresolution
video525.s01 1 675x240i
video525.c01 1 675x240i
video525.c02 1 675x240i
-----
Active file : Video525.c50

Select with ↑ or ↓ , →
<ENTER> to accept
<EXIT> to return
```

Menu 7-21

```
CONFIRM
DELETE FILE
Delete file :
Video525.c01?

<ENTER> to confirm
<EXIT> to return
```

Menu 7-22

7.2.9 File Options

Start up

1. Push the cursor key ↑ or ↓ to highlight *Options*. (menu 7-23)
2. Press **ENTER**.

The option selection menu will be displayed. (menu 7-24)

```
FILE SERVICE
LOAD
EDIT
RENAME
COPY
DELETE
OPTIONS

Select with ↑ or ↓
then <ENTER>
<EXIT> to return
```

Menu 7-23

```
FILE OPTIONS
FILE SORT [NAME]
FILE LOAD [AUTOMATIC]

Select with ↑ or ↓
then <ENTER>
<EXIT> to return
```

Menu 7-24

File Sort

1. Press **ENTER** to toggle between [name] and [index].
 - [name] : the files in the list will be sorted on the file name.
 - [index] : the files in the list will be sorted on the file extension.

File Load

1. Press **ENTER** to toggle between [automatic] and [manual].
 - [automatic] : correct file will be loaded automatically.
 - [manual] : correct file has to be loaded manually.

7.3 Picture Tuning

Overview

- Start up
- CTI
- Color Temperature
- Gamma
- Decoding
- Dynamic Color Depth
- Noise Reduction
- Input Balance

7.3.1 Start up

Start up

To improve the image quality, the items in the Picture Tuning menu can be toggled or adjusted. To start up the Picture Tuning :

1. Push the cursor key ↑ or ↓ to highlight *Picture Tuning*. (menu 7-25)
2. Press **ENTER** to select.

The picture tuning menu will be displayed. (menu 7-26)

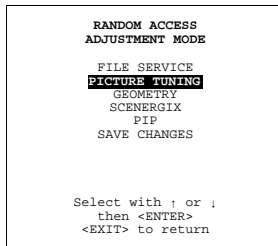

Menu 7-25

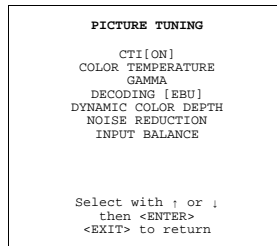

Menu 7-26

7.3.2 CTI



CTI

Color transient improvement. To improve the transition from one color to another.

Changing the CTI setting

1. Push the cursor key ↑ or ↓ to highlight *CTI*. (menu 7-27)
2. Press **ENTER** to toggle between ON and OFF.

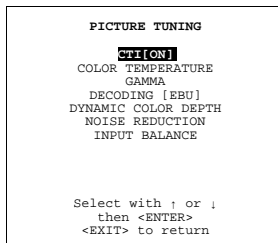

Menu 7-27



This CTI function applies to PAL and NTSC video or S-video inputs only.

7.3.3 Color Temperature

Available Color temperatures

- Projector white
- Broadcast 3200K
- Film 5400K
- Video 6500K
- Computer 9300K
- Custom balance

Start Up

1. Push the cursor key ↑ or ↓ to highlight *Color Temperature*. (menu 7-28)
2. Press **ENTER** to select.

The color temperature selection menu will be displayed. (menu 7-29)

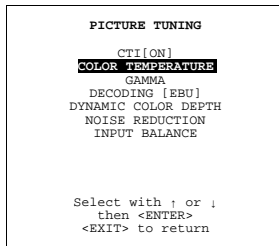

Menu 7-28

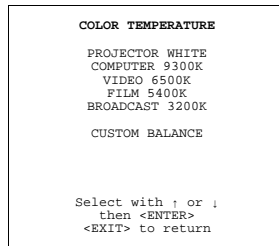

Menu 7-29

Adjusting the color balance

1. Adjusting the color balance by selecting a fixed color balance ?
If yes, Push the cursor key ↑ or ↓ to highlight one of the preprogrammed color balances. Press **ENTER** to select
Note: *Projector white will provide maximum projector light output. The calibrated 'Broadcast', 'Film', 'Video' and 'Computer' presets will provide optimum color tracking.*
If no, go to step 2
2. Push the cursor key ↑ or ↓ to adjust red and push the cursor key ← or → to adjust blue (range 0 to 2.5) in comparison with the green color. (image 7-3)



Image 7-3

7.3.4 Gamma

What can be adjusted ?

With the gamma correction adjustment, it is possible to accurately set the gamma of the projector image.

Changing the gamma value

1. Push the cursor key ↑ or ↓ to highlight *Gamma*. (menu 7-30)
2. Press **ENTER** to select.
3. Change the gamma value by pushing the cursor key ← or → until the desired value is reached.
Note: Default value of gamma : 2.2
4. Press **EXIT** to return to the *Picture Tuning* menu.

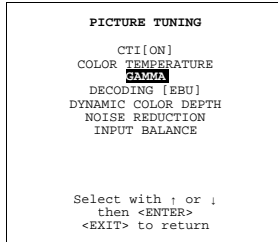

Menu 7-30

7.3.5 Decoding

What can be done ?

The possibility is offered to decode the NTSC video signals via the default American IRE standard or via the European EBU standard. Decoding a NTSC signal using the European EBU standard may result in a greenish tint.

How to change the decoding setting ?

1. Push the cursor key ↑ or ↓ to highlight *Decoding*. (menu 7-31)
2. Press **ENTER** to toggle between EBU or IRE.
3. Press **EXIT** to return.

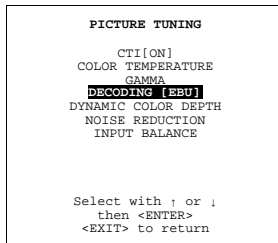

Menu 7-31

7.3.6 Dynamic Color Depth

Purpose

Increases color contrast for all video and data sources.

Changing the Dynamic Color depth value.

1. Push the cursor key ↑ or ↓ to highlight *Dynamic Color Depth*. (menu 7-32)
2. Press **ENTER** to select.
3. Change the value by pushing the cursor key ← or → until the desired dark color saturation is reached.
4. Press **EXIT** to return the *Picture Tuning* menu.

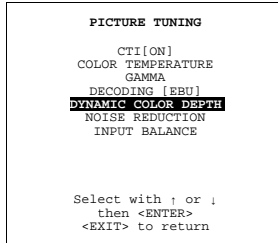

Menu 7-32

7.3.7 Noise Reduction

Purpose

Reduces noise and pixel jitter in all video and data sources

Changing the noise reduction value.

1. Push the cursor key ↑ or ↓ to highlight *Noise Reduction*. (menu 7-33)
2. Press **ENTER** to select.
3. Change the value by pushing the cursor key ← or → until the desired noise level is reached.
4. Press **EXIT** to return the *Picture Tuning* menu.

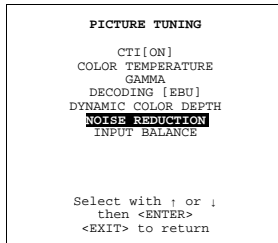

Menu 7-33

7.3.8 Input Balance

Why adjusting the input balance?

The input balance is normally correct adjusted in the factory. But due to signal distribution or signal transmission, a color imbalance can be the result. This imbalance can be adjusted source by source for color critical applications. These adjustments influence only the actual custom adjustment file. This procedure is not so easy.

Overview

- Input Balance for RGB input signals
- Input Balance for YUV signals
- Returning to the factory defaults



There are 2 different adjustment procedures, one for RGB (included Video and S-Video) and one for YUV input signals.



Before starting the Input Balance function, generate a signal with dominant black and white areas.

7.3.8.1 Input Balance for RGB input signals

Step to be taken for RGB input signals

To adjust the input balance, the following steps have to be executed in the following order :

1. Start with the black balance.
2. Continue with the white balance.



The default values are normally loaded when selecting a source. If the image is not as desired, continue with the next procedure.

Black balance adjustment

1. Is the input balance menu already activated ?
If yes, go to step 4
If no, go to step 2
2. Push the cursor key ↑ or ↓ to highlight *Input Balance*. (menu 7-34)
3. Press **ENTER** to select.
The Input Balance menu will be displayed. (menu 7-35)
4. Push the cursor key ↑ or ↓ to highlight *Black Balance* menu 7-35.
5. Press **ENTER** to select.
6. Adjust the Brightness to a maximum value until there is just no green noise visible in the black areas.
7. Adjust with the cursor keys ↑ or ↓ or ← or → until there is no red or blue noise visible in the black areas.

```

PICTURE TUNING
  CTI[ON]
  COLOR TEMPERATURE
  GAMMA
  DECODING [EBU]
  DYNAMIC COLOR DEPTH
  NOISE REDUCTION
  INPUT BALANCE

Select with ↑ or ↓
then <ENTER>
<EXIT> to return

```

Menu 7-34

```

INPUT BALANCE
  BLACK BALANCE
  WHITE BALANCE
  DEFAULT

Select with ↑ or ↓
then <ENTER>
<EXIT> to return

Adjust
red with ↑ or ↓
blue with ← or →

```

Menu 7-35

White balance adjustment

1. Push the cursor key ↑ or ↓ to highlight *White Balance*. (menu 7-36)
2. Press **ENTER** to select.
3. Put the Gain Red and Gain Blue to -32.
4. Adjust the contrast to a maximum value until the green noise becomes visible in the white areas and return one step.
5. Adjust with the cursor keys ↑ or ↓ or ← or → until the red respectively blue noise becomes visible in the white areas and return one step.

```

INPUT BALANCE
  BLACK BALANCE
  WHITE BALANCE
  DEFAULT

Select with ↑ or ↓
then <ENTER>
<EXIT> to return

Adjust
red with ↑ or ↓
blue with ← or →

```

Menu 7-36

7.3.8.2 Input Balance for YUV signals

Steps to be taken for YUV

1. Is the input balance menu already activated ?
If yes, go to step 4
If no, go to step 2
2. Push the cursor key ↑ or ↓ to highlight *Input Balance*. (menu 7-37)
3. Press **ENTER** to select.
The Input Balance menu will be displayed. (menu 7-38)
4. Push the cursor key ↑ or ↓ to highlight *Black Balance* menu 7-35.
5. Press **ENTER** to select.
6. Decrease the Brightness a lot, for example to a value 50 on the barscale.
7. Adjust RED Black Balance with the cursor key ↑ or ↓ until the red noise becomes visible in the left bar.
8. Adjust the BLUE Black Balance with the cursor key ← or → until blue noise becomes visible in the left bar.
9. Increase the brightness until the left bar displays approximately 50% white noise.
10. Correct Red and Blue Black Balance adjustment in such a way the blue and red noise are just visible and a small Brightness increase maintain a grey colour.

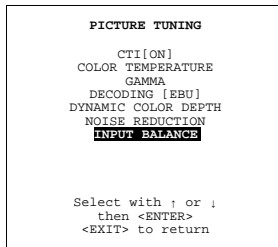

Menu 7-37

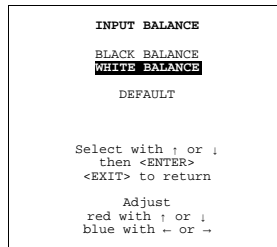

Menu 7-38

Checking the White Balance

There is no adjustment procedure for the white balance. This menu is useful for checking the color tracking in relation to Contrast and Saturation adjustment, which are adjustable in this menu item.

7.3.8.3 Returning to the factory defaults

How to return to the factory defaults

1. Push the cursor key ↑ or ↓ to highlight *Default*. (menu 7-39)
2. Press **ENTER** to select.

The default settings will be loaded.

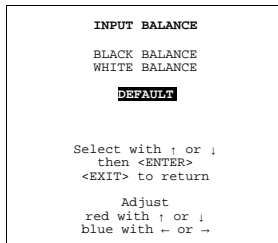

Menu 7-39

7.4 Geometry

Overview

- Introduction
- Geometry start up
- Shift
- Size
- Side Keystone
- Blanking
- Aspect Ratio
- Geometry Options

7.4.1 Introduction

Introduction

An adjustment can be done as follow :

1. Using the cursor key to adjust
2. Entering the value with the digit keys. Therefore, press **ENTER** to select the indicated value and enter the desired value with the digit keys. Press **ENTER** to confirm the entered value.

7.4.2 Geometry start up

Start up

1. Push the cursor key ↑ or ↓ to highlight *Geometry*. (menu 7-40)
2. Press **ENTER** to select.

The geometry menu will be displayed. (menu 7-41)

```

ADJUSTMENT MODE
Select a path from below :

RANDOM ACCESS
INSTALLATION
SERVICE

Select with ; or |
then <ENTER>
<EXIT> to return

```

Menu 7-40

```

GEOMETRY

SHIFT
SIZE
SIDE KEYSTONE
BLANKING
ASPECT RATIO [4:3]
OPTIONS

Select with ; or |
then <ENTER>
<EXIT> to return

```

Menu 7-41

7.4.3 Shift

What can be done ?

The image can be shifted in a horizontal or vertical direction.

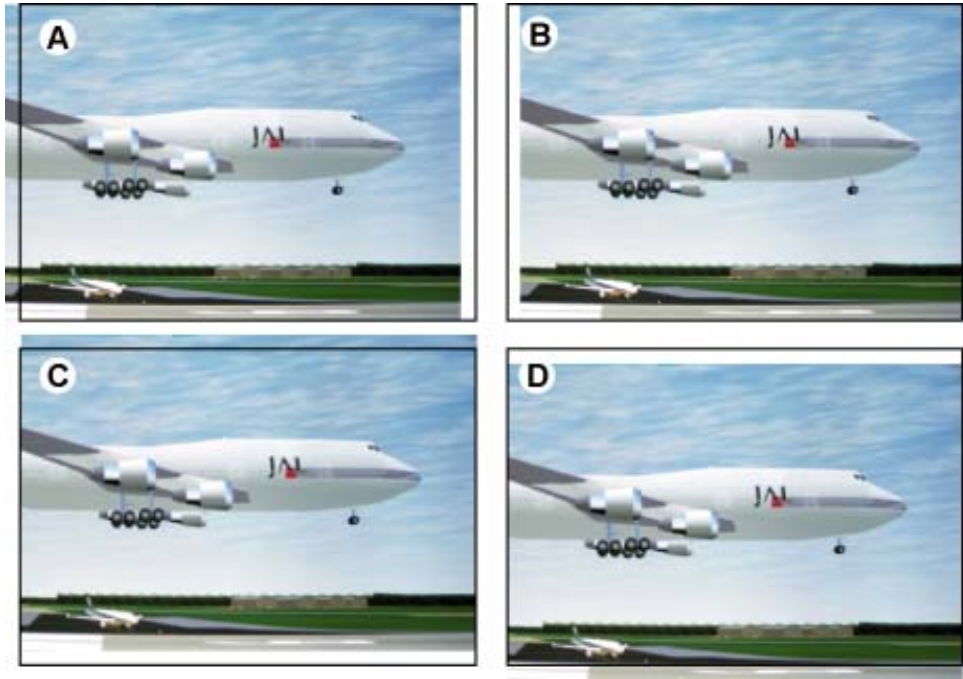

Image 7-4
Shift adjustment

- A Shift to the left
- B Shift to the right
- C Shift upwards
- D Shift downwards

How to shift the image ?

1. Push the cursor key ↑ or ↓ to highlight *Shift*. (menu 7-42)
2. Press **ENTER** to select.
3. Push the cursor key ↑ or ↓ to shift the image in a vertical direction.
Push the cursor key ← or → to shift the image in a horizontal direction.
Note: *The default value for the shift is 0.*

Shifting in a vertical direction : when the shift value is positive, the image is shifted upwards, when the value is negative, the image is shifted downwards.

Shifting in a horizontal direction : when the shift value is positive, the image is shifted to the right, when the value is negative, the image is shifted to the left.

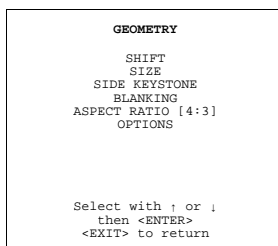

Menu 7-42



While the bar scale window is on the screen, press **ENTER** to change the value indication to an input field. Enter the desired value with the numeric keys on the RCU. Always 3 digits should be entered. To toggle + to - or vice versa, use the up or down arrow key.

7.4.4 Size

What can be done ?

The size can be adjusted in a vertical or horizontal way.

When adjusting the vertical size, The upper side of the image is fixed (table and ceiling mounted configurations) and only the lower side can be moved to its exact position.

When adjusting the horizontal size, the left side of the image is fixed and only the right side can be moved to its exact position.

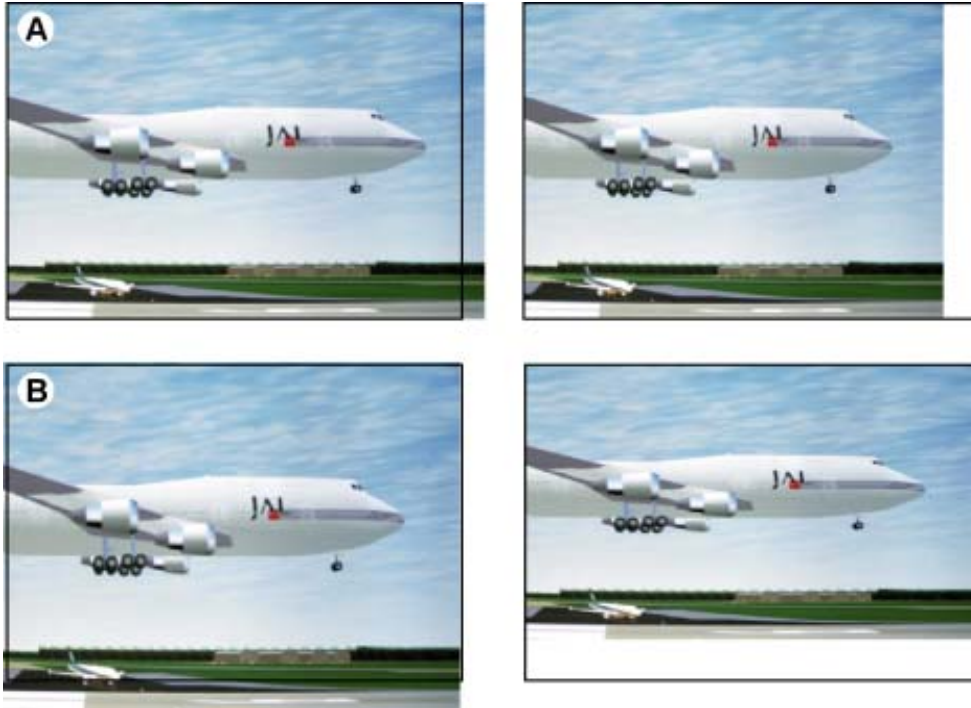
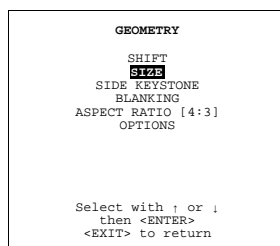

Image 7-5
Size adjustment

- A Horizontal size adjustment
- B Vertical size adjustment

Size adjustment

1. Push the cursor key ↑ or ↓ to highlight *Size*. (menu 7-43)
2. Press **ENTER** to select.
3. Push the cursor key ↑ or ↓ to size the image in a vertical direction.
Push the cursor key ← or → to size the image in a horizontal direction.



Menu 7-43



While the bar scale window is on the screen, press **ENTER** to change the value indication to an input field. Enter the desired value with the numeric keys on the RCU. Always 3 digits should be entered. To toggle + to - or vice versa, use the up or down arrow key.

7.4.5 Side Keystone

What can be done?

The side keystone adjustment is used to align the image if the projector is mounted at a non standard projection angle.



Image 7-6
Side Keystone

Side keystone adjustment

1. Push the cursor key ↑ or ↓ to highlight *Side Keystone*. (menu 7-44)
2. Press **ENTER** to select.
3. Push the cursor key ← or → to adjust the keystone of the image.
When the upper part of the image is wider than the lower part of the image, push the cursor key ←. The number indication below the bar scale will be negative.
When the upper part of the image is smaller than the lower part of the image, push the cursor key →. The number indication below the bar scale will be positive.

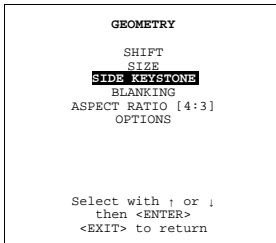

Menu 7-44



While the bar scale window is on the screen, press **ENTER** to change the value indication to an input field. Enter the desired value with the numeric keys on the RCU. Always 3 digits should be entered. To toggle + to - or vice versa, use the up or down arrow key.

7.4.6 Blanking

What can be done ?

Blanking adjustments affect only the edges of the projected image and are used to frame the projected image on to the screen and to hide or black out unwanted information (or noise). A '0' on the bar scale indicates no blanking.

Which blanking adjustments are available ?

- top blanking
- bottom blanking
- left blanking
- right blanking

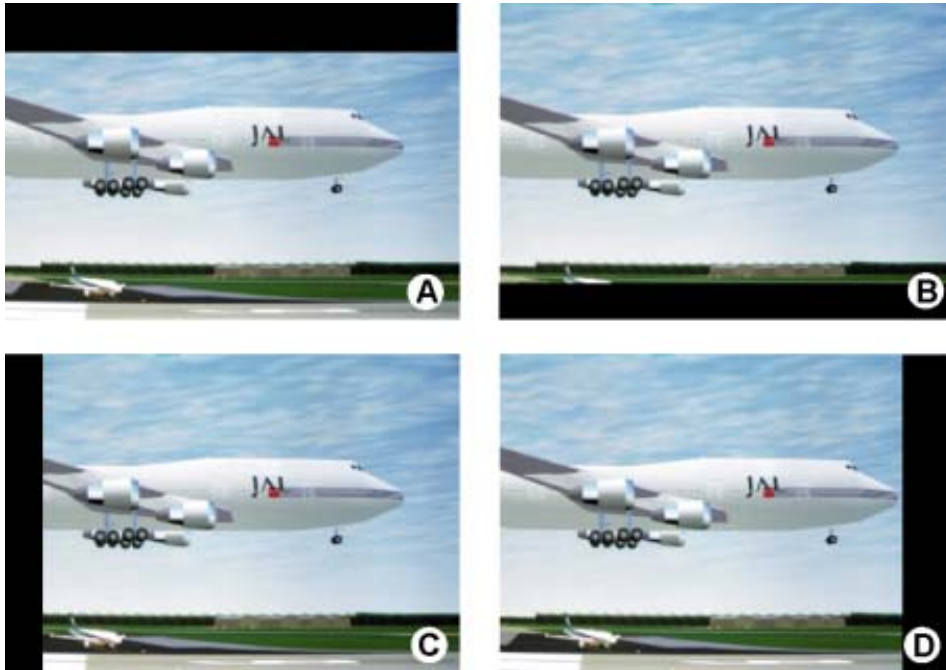
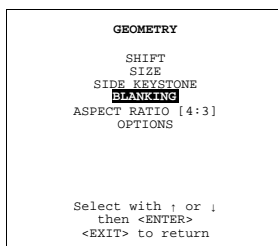

Image 7-7
Blanking

- A Top blanking
- B Bottom blanking
- C Left blanking
- D Right blanking

Adjusting the blanking.

1. Push the cursor key \uparrow or \downarrow to highlight *Blanking*. (menu 7-45)
2. Press **ENTER** to display the blanking menu. (menu 7-46)
3. Push the cursor key \uparrow or \downarrow to highlight the desired blanking.
4. Press **ENTER** to start up the chosen blanking.
5. Use the cursor keys to adjust the blanking.



Menu 7-45

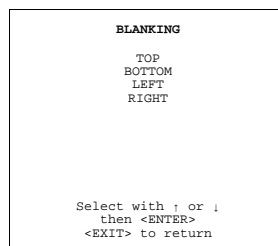

Menu 7-46



While the bar scale window is on the screen, press **ENTER** to change the value indication to an input field. Enter the desired value with the numeric keys on the RCU. Always 3 digits should be entered. To toggle + to - or vice versa, use the up or down arrow key.

7.4.7 Aspect Ratio

Purpose

To force the projector in a typical aspect ratio. E.g. projecting a 4:3 image in a 16:9 aspect ratio.

How to set up the desired aspect ratio ?

1. Push the cursor key ↑ or ↓ to highlight *Aspect Ratio*. (menu 7-47)
2. Press **ENTER** to scroll between [5:4], [4:3], [16:9], [2.35], [1.88] or [1.78].

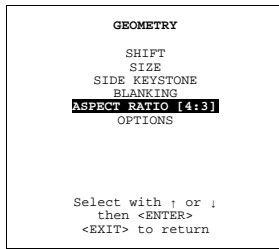

Menu 7-47

7.4.8 Geometry Options

What is possible

The same side keystone correction can be used for all files.

How to toggle

1. Push the cursor key ↑ or ↓ to highlight *Options*. (menu 7-48)
2. Press **ENTER** to select.
The *Geometry Options* menu will be displayed. (menu 7-49)
3. Press **ENTER** to toggle between [YES] or [NO].

NO Side Keystone will be adjusted for the active file only.

YES Side Keystone will be adjusted for all files.

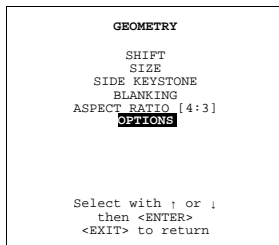

Menu 7-48

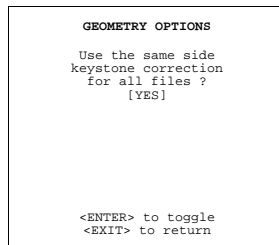

Menu 7-49

7.5 ScenergiX

Overview

- Order information
- Introduction
- Preparations
- ScenergiX
- ScenergiX overlap zone (horizontal scenergiX)
- ScenergiX overlap zone (vertical scenergiX)
- ScenergiX size adjustment
- Adjusting the black level of the images

7.5.1 Order information

Order numbers

SLM G5	R9840880
SLM R6	R9840890
SLM G8/G10	R9841500
SLM R8/R10/R9+/R12+	R9841510

7.5.2 Introduction

When available ?

ScenergiX is only available as an option, some menu items will be grayed out when this option is not installed.

Why ScenergiX ?

When working in a multichannel setup the BARCO SLM G10 and its Soft Edge possibilities enable an image blending that gives the appearance of a single view, thus achieving realistic immersion for the majority of wide screen applications.

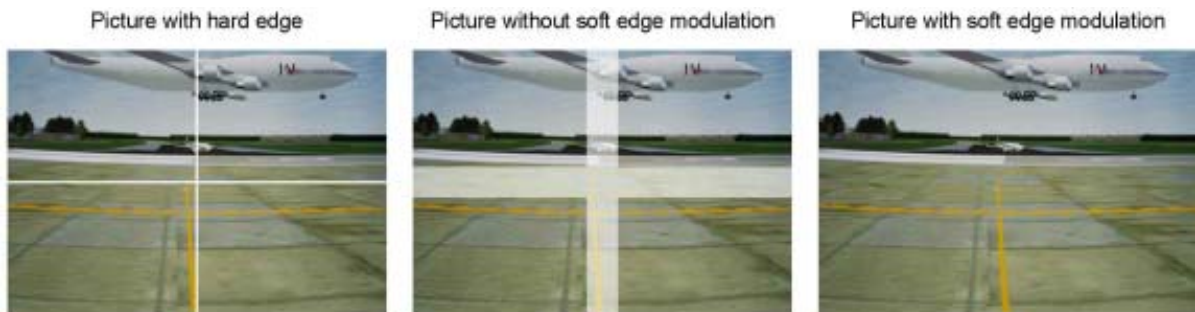

Image 7-8
Why Soft Edge?

What is the Basic Principal of ScenergiX ?

The principle of edge blending is archived by linear modulation of the light output in the overlap zone so that the light output in that zone equals the light output of the rest of the image.

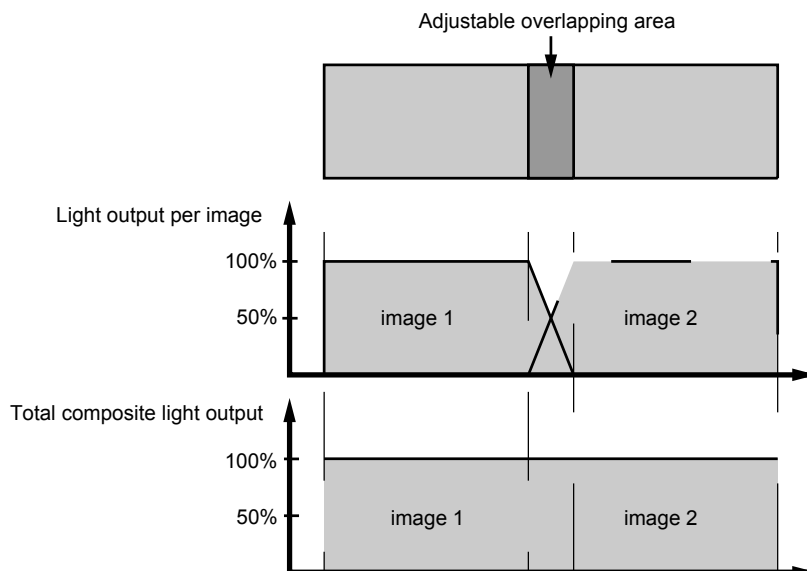

Image 7-9
ScenergiX Basic Principle

7.5.3 Preparations

ScenergiX Preparations

To ensure proper ScenergiX adjustment, be sure that the following adjustments are done perfectly on all projectors:

- Convergence (Electronic Convergence).
- Geometry
- Color Matching (Color Temperature, Input Balance, Gamma)

7.5.4 ScenergiX

How to activate ScenergiX?

1. Push the cursor key ↑ or ↓ to highlight *ScenergiX*. (menu 7-50)
2. Press **ENTER** to select.
3. Push the cursor key ↑ or ↓ to highlight *Status*. (menu 7-51)
4. Press **ENTER** to toggle between ON and OFF.

ON scenergiX is active

OFF scenergiX is not active

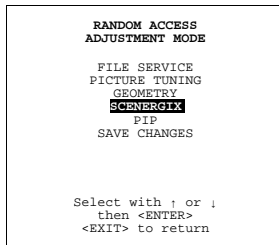

Menu 7-50

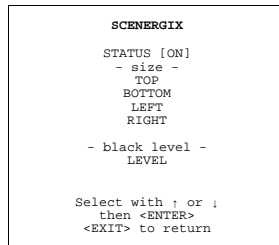

Menu 7-51

7.5.5 ScenergiX overlap zone (horizontal scenergiX)

Definitions

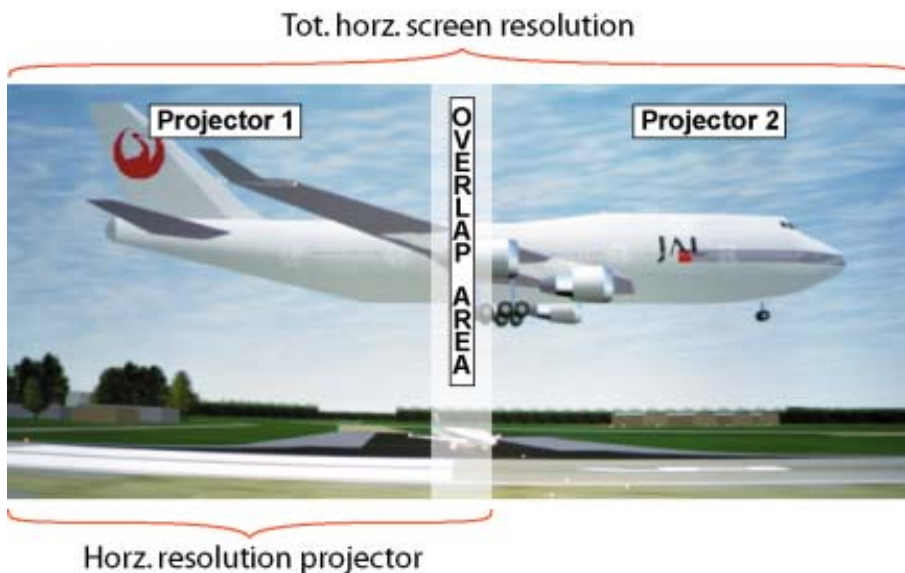

Image 7-10
ScenergiX set up

Overlap : number of pixels that overlap

Horizontal resolution of 1 projector : 1024 for Graphics versions, 1280 for Reality versions, 1400 for SLM R12+.

Total horizontal screen resolution : [(horizontal resolution of 1 projector) x 2] minus overlap.

Horizontal Resolution source : number of active pixels of the source.

Adjustment of Active pixels (Pact) of the first projector

1. Go to File → Edit menu of first projector.
2. Enter value for horizontal active (= Pact) as follows :

$$\text{Pact} = [(\text{Horz. resolution of 1 projector}) / (\text{Total horz. screen resolution})] \times (\text{horz. resolution source})$$
3. Horizontal start (= Pstart) remains the same.

Adjustment of Active pixels (Pact) of second projector

1. Go to File → Edit menu of second projector.
2. Enter value for horizontal active (= Pact) as follows :

$$\text{Pact} = [(\text{Horz. resolution of 1 projector}) / (\text{Total horz. screen resolution})] \times (\text{horz. resolution source})$$
3. Horizontal start (= Pstart) = original start + [(Horz. resolution source) minus (newly calculated Pact)]

Example

Horizontal resolution source : 1600 pixels

horizontal resolution projector 1 & 2 : 1024 pixels

Overlap : 100 pixels

Total horizontal screen size in pixels : 1948 pixels

Pact projector 1 = $[(1024 / 1948)] \times 1600 = 841$ pixels

Pact projector 2 = $[(1024 / 1948)] \times 1600 = 841$ pixels

Pstart projector 2 = Pstart projector 1 + (1600 – 841)

7.5.6 ScenergiX overlap zone (vertical scenergiX)

Definitions

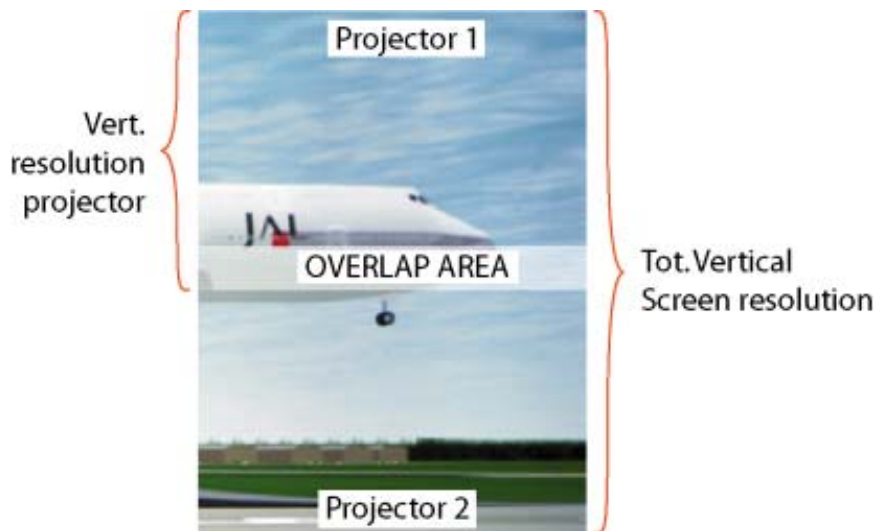

Image 7-11
ScenergiX overlap zone vertical

Overlap : number of pixels that overlap

Vertical resolution of 1 projector : 768 for Graphics versions, 1024 for Reality versions, 1050 for SLM R12+.

Total vertical screen resolution : [(Vertical resolution of 1 projector) x 2] minus (overlap)

Vertical Resolution source : number of active lines of the source

Adjustment of Active lines (Lact) of the first projector

1. Go to File → Edit menu of first projector.
2. Enter value for vertical act (= Lact) as follows :

$$\text{Lact} = [(\text{vert.. resolution of 1 projector}) / (\text{Total Vert. screen resolution})] \times (\text{Verti. resolution source})$$
3. Vertical start (= Lstart) remains the same.

Adjustment of Active lines (Lact) of second projector

1. Go to File → Edit menu of second projector.
2. Enter value for vertical act (= Lact) as follows :
Lact = [(Vert. resolution of 1 projector)/(Total vert. screen resolution)] x (vert. resolution source)
3. Vertical start (= Lstart) = original start + [(Vert. resolution source) minus (newly calculated Lact)]

Example

Vertical resolution source : 1200 lines

Vertical resolution projector 1 & 2: 768 lines

Overlap : 50 lines

Total vertical screen size : 1486 lines

Lact projector 1 = (768 / 1486) x 1200 = 620 lines

Lact projector 2 = (768 / 1486) x 1200 = 620 lines

Lstart projector 2 = Lstart projector 1 + (1200 – 620)

7.5.7 ScenergiX size adjustment

What can be done with the ScenergiX size menu?

Within this menu the width of the blending zone is set up.

How to adjust the size?

Only accessible when the status is in the ON position.

1. Push the cursor key ↑ or ↓ to highlight one of the four size adjustments, Top, Bottom, Left or Right. (menu 7-52)
2. Press **ENTER** to select.

A pattern with the different areas will be displayed. (image 7-12)

3. Use the cursor keys to move the border of the overlap area to the desired position (value between 0 and 255).
Set first the width of the first projector and repeat for the second one. (image 7-13, image 7-14)

```
SCENERGIX
STATUS [ON]
- size -
  TOP
  BOTTOM
  LEFT
  RIGHT
- black level -
  LEVEL

Select with ; or |
then <ENTER>
<EXIT> to return
```

Menu 7-52

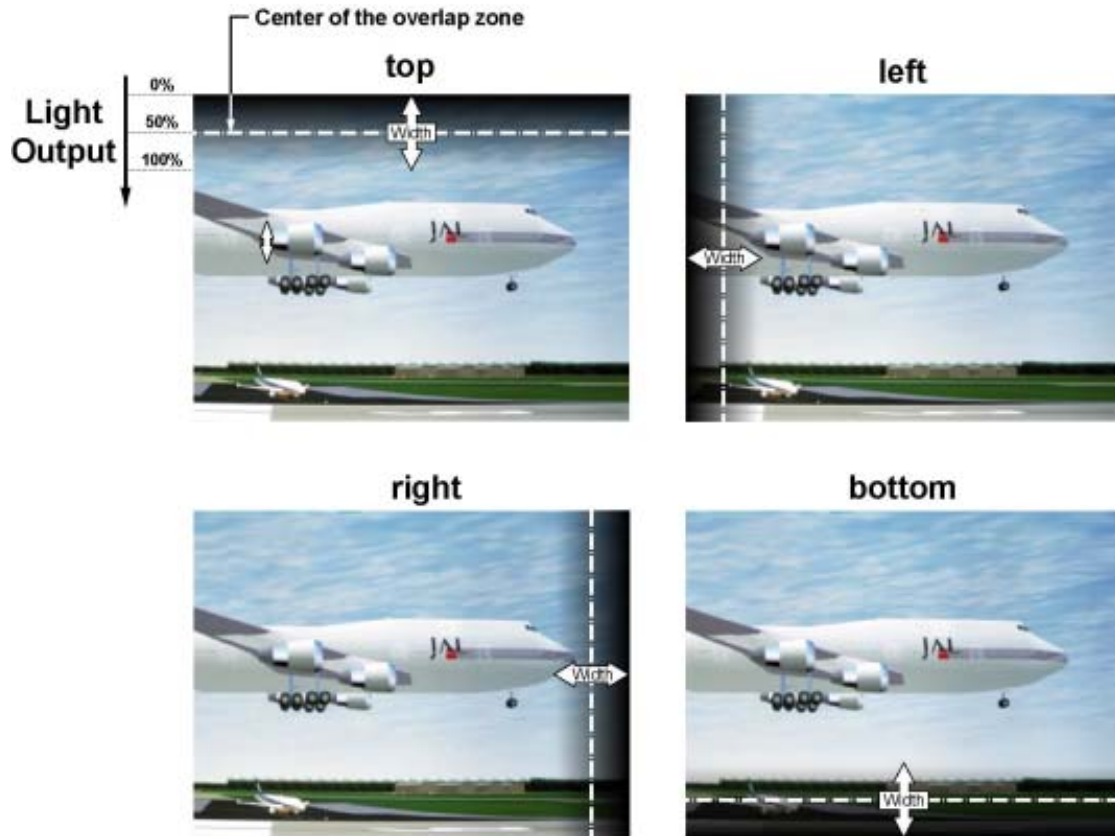

Image 7-12
Width selections

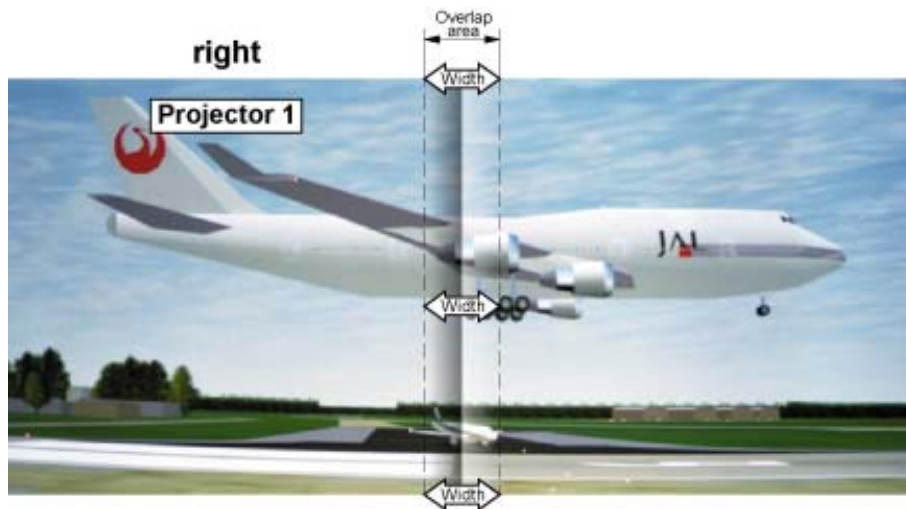

Image 7-13
Width set up for projector 1

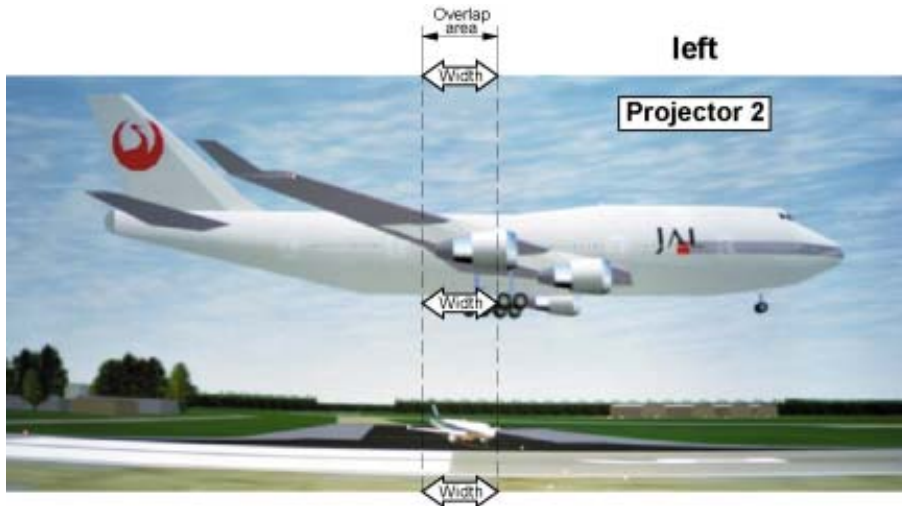

Image 7-14
Width set up for projector 2

7.5.8 Adjusting the black level of the images

Why

For dark images, the overlap zone will be brighter than the rest of the images. Therefore we can rise the black level of the remaining image (excluding the overlap zone).

How to adjust?

1. Push the cursor key \uparrow or \downarrow to highlight *Level*. (menu 7-53)
2. Press **ENTER** to activate.
3. Adjust the black level of area A until the black level of area A, B and C are equal. (image 7-15)

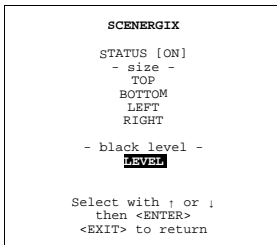

Menu 7-53

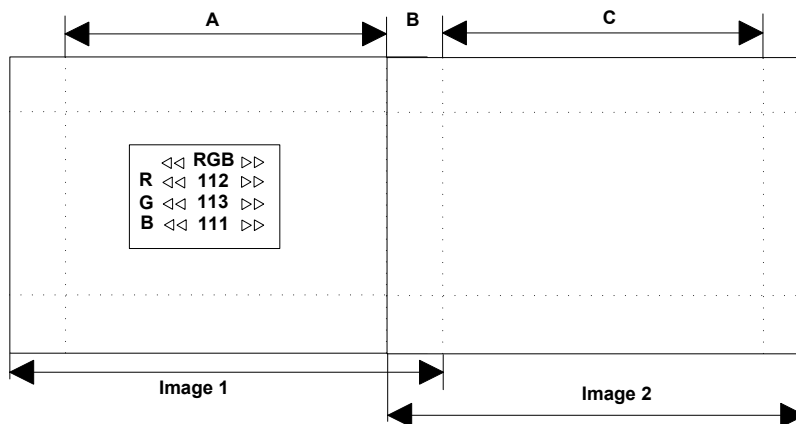

Image 7-15
Black level adjustment

7.6 Picture in Picture (PiP)

Overview

- Introduction to PiP
- Picture in Picture activation
- Picture in Picture source
- Position of Picture in Picture window
- Set up of the Quick Selection

7.6.1 Introduction to PiP



PiP

PiP stands for "Picture in Picture" and allows to display multiple windows containing each of them an image. The windows may be of the video or data type.

What are the different possibilities within the PiP mode ?

The input section of the SLM projector allows a combinations of different input signals which may be projected in the 2 windows of the PiP screen. The PiP window can be placed in one of the four corners of the main window.

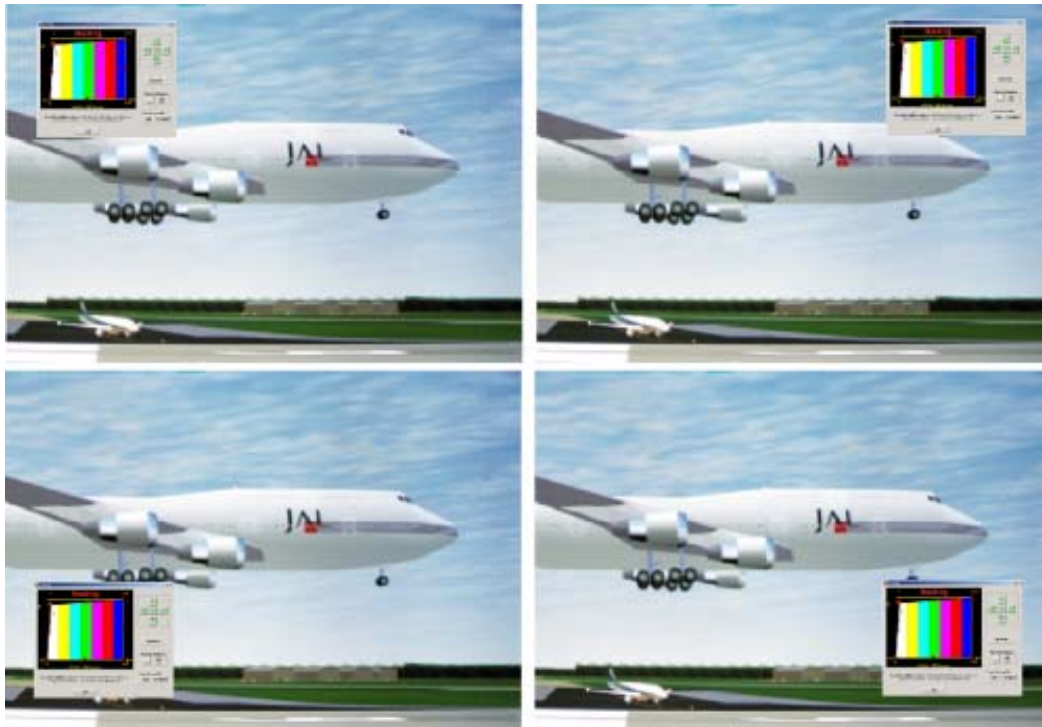

Image 7-16
Possible position for PiP

7.6.2 Picture in Picture activation

How to activate PIP?

1. Push the cursor key ↑ or ↓ to highlight *PIP*. (menu 7-54)
2. Press **ENTER** to select.
The PIP menu will be displayed. (menu 7-55)
3. Push the cursor key ↑ or ↓ to highlight *Status*.
4. Press **ENTER** to toggle between ON and OFF.

ON PIP is active
OFF PIP is not active

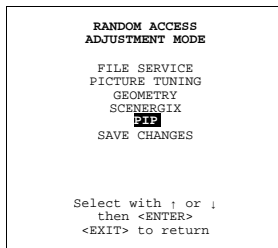

Menu 7-54

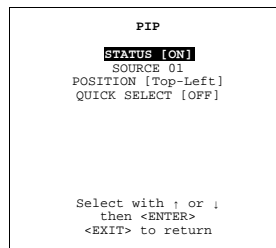

Menu 7-55

7.6.3 Picture in Picture source

Which source displayed in PiP

1. Push the cursor key ↑ or ↓ to highlight *Source*. (menu 7-56)
2. Press **ENTER** to select.
3. Enter the source number with the remote control. Start always with 0.

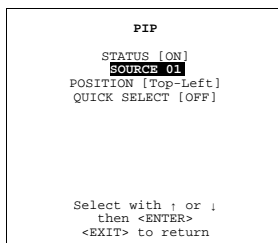

Menu 7-56

7.6.4 Position of Picture in Picture window

What can be done?

The PiP window can be placed in on of the four corners of the main window.

How to position?

1. Push the cursor key ↑ or ↓ to highlight *Position*. (menu 7-57)
2. Press **ENTER** to toggle between *Top-Left*, *Top-Right*, *Bottom-Left* or *Bottom-Right*.

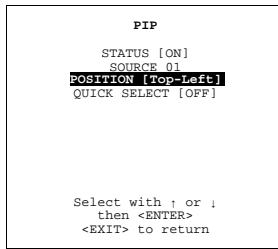

Menu 7-57

7.6.5 Set up of the Quick Selection

What is possible?

When the quick selection is active, the source inside the PiP window can be switched to another source by entering on the RCU or local keypad first 0 followed immediately by the source number. E.g. for source 2 in the PiP window, enter 02 on the RCU.

How to set

1. Push the cursor key ↑ or ↓ to highlight *Quick Select*. (menu 7-58)
2. Press **ENTER** to toggle between [OFF] and [<0>].

OFF : no quick selection allowed.

<0> : quick selection allowed by using 0 before the source number.

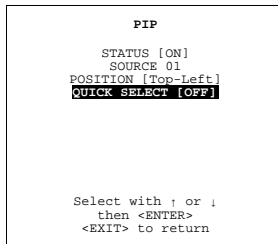

Menu 7-58

7.7 Save Changes

What can be done

The system saves automatically the changes every x minutes. When you want to save it quicker, use the save changes option.

How to save

1. Push the cursor key ↑ or ↓ to highlight *Save Changes*. (menu 7-59)
2. Press **ENTER** to save the actual settings in the active file.

A message will be displayed to wait a few second while the system is saving the data. (menu 7-60)

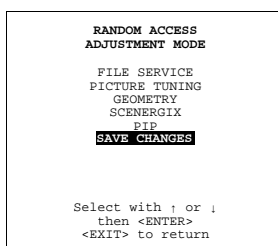

Menu 7-59

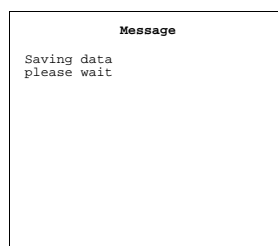

Menu 7-60

8. INSTALLATION MODE

Overview

- Start up of the Installation mode
- Input Slots
- 800 peripheral
- Source Switching
- No Signal
- Contrast Enhancement
- Convergence
- Configuration
- Lens Adjustment
- Quick Access Keys
- OSD
- Internal Patterns

8.1 Start up of the Installation mode

Start up

1. Push the cursor key ↑ or ↓ to highlight *Installation*. (menu 8-1)
2. Press **ENTER**.

The Installation mode menu will be displayed. (menu 8-2)

```

ADJUSTMENT MODE
Select a path from below :
RANDOM ACCESS
INSTALLATION
SERVICE

Select with ↑ or ↓
then <ENTER>
<EXIT> to return

```

Menu 8-1

```

INSTALLATION
INPUT SLOTS
800 PERIPHERAL
SOURCE SWITCHING
NO SIGNAL
CONTRAST ENHANCEMENT
CONVERGENCE
CONFIGURATION
LENS
QUICK ACCESS KEYS
OSD
INTERNAL PATTERNS

Select with ↑ or ↓
then <ENTER>
<EXIT> to return

```

Menu 8-2

8.2 Input Slots

What can be done ?

The input configuration of the variable inputs is shown in the *Input slots* menu.

To view or the change the input configuration.

1. Push the cursor key ↑ or ↓ to highlight *Input Slots*. (menu 8-3)
2. Press **ENTER** to select.

The input slots menu will be displayed. (menu 8-4)

```

INSTALLATION
  INPUT SLOTS
800 PERIPHERAL
SOURCE SWITCHING
  NO SIGNAL
CONTRAST ENHANCEMENT
  CONVERGENCE
  CONFIGURATION
  LENS
QUICK ACCESS KEYS
  OSD
INTERNAL PATTERNS

Select with ↑ or ↓
then <ENTER>
<EXIT> to return
    
```

Menu 8-3

```

INPUT SLOTS

Slot Module type [config]
1.  RGB-SS [CV]
2.  RGB-SOG
3.  SDI
4.  SDI

1. DVI OUTPUT [DVI input]

Select with : or ↓
then <ENTER>
<EXIT> to return
    
```

Menu 8-4

Possible results for the fixed input slots (1&2).

Source	Indication
Video or S-Video	Video S-video
RGB analog	RGB-SS[CV] : separate sync is composite video on H/C input RGB-SS[cS or HS&VS]: separate sync is composite sync or horizontal and vertical sync RGB-SOG : sync on green
Component Video	Component video - SS : Component video with separate sync Component video - SOY : Component video with sync on Y Component video - 3LSS : Component video with 3 level separate sync. Component video - 3LSOY : Component video with 3 level syncs on Y.
RGB analog with tri-level-sync	RGB-SS[3LSS] : RGB with separate Tri level sync. RGB3L-SOG[3LSOY]: RGB with Tri-level sync on green.
DVI	DVI

Possible results for input 3 and 4

SDI	Serial digital input
HD SDI	high definition digital input
Digital Video Decoder	VIDEO[VIDEO] VIDEO[S-VIDEO] VIDEO[YUV]

What if a switcher is connected to the projector ?

If a RCVDS (switched on) or VS05 is connected to the projector, it will be also indicated on the menu by adding +800 peripheral.

If no 800 peripheral indication is made on the menu, there are still two possibilities, no RCVDS or VS05 connected or RCVDS is switched off.

When a 800 peripheral is connected to the projector, the input slots are not accessible with the cursor key to toggle their function.

8.3 800 peripheral

Overview

- Defining the output module of the RCVDS05.
- Defining the Infrared Communication protocol
- CLO using Comm 800

8.3.1 Defining the output module of the RCVDS05.

Which module are available?

When a RCVDS05 is connected to the projector, the type of output module of this RCVDS05 has to be defined in the 800 peripheral menu.

- standard output module
- 5 cable output module

Defining the output module

To define the output module:

1. Push the cursor key ↑ or ↓ to highlight *800 Peripheral*. (menu 8-5)
2. Press **ENTER** to select.
3. Push the cursor key ↑ or ↓ to highlight *Output module*. (menu 8-6)

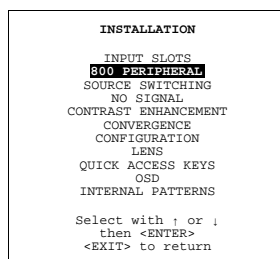

Menu 8-5

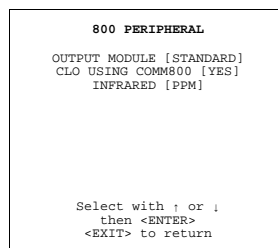

Menu 8-6

8.3.2 Defining the Infrared Communication protocol

Which protocols are available?

When a peripheral is connected to the 'Comm Port', the communication can be in PPM or RC5.

The type of communication can be set to :

- PPM
- RC5

Defining the communication protocol.

1. Push the cursor key ↑ or ↓ to highlight *800 Peripheral*. (menu 8-7)
2. Press **ENTER** to select.
3. Push the cursor key ↑ or ↓ to highlight *Infrared*. (menu 8-8)
4. Press **ENTER** to select.
5. Press **ENTER** to toggle between [PPM] or [RC5].

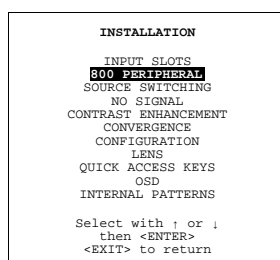

Menu 8-7

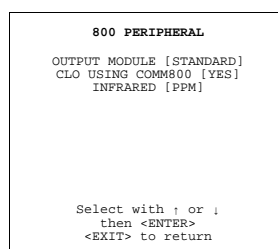

Menu 8-8

8.3.3 CLO using Comm 800

What can be done?

CLO can be activated in a linked system setup using the COM800 Protocol + Ports.



By using the COM800 Protocol + Ports, the RS232 Ports can be used for a RS232 linked setup, CLO is received through the COM800 Ports, general RS232 commands are received through the RS232 Ports.

How to change the COM800 Protocol Activation?

1. Push the cursor key ↑ or ↓ to highlight *CLO using COM800: [NO]*. (menu 8-9)
2. Press **ENTER** to toggle between [NO] or [YES].

- [No] CLO will not use Comm800 protocol
- [Yes] CLO will use Comm800 protocol

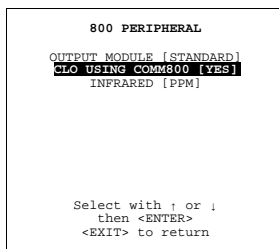

Menu 8-9

8.4 Source Switching

Switching from one source to another.

To minimize undesired effects when switching from one source to another one can use the Seamless switching mode, beside Seamless switching there is a choice between several effects which render the transitions more enjoyable.

How to select a switching mode

1. Push the cursor key ↑ or ↓ to highlight *Source Switching*. (menu 8-10)
2. Press **ENTER** to select.

The seamless source switching menu will be displayed. (menu 8-11)

3. Press **ENTER** to toggle between [NO TRANSITION], [FADE], ...

- OFF no effect installed.
- RANDOM TRANSITION source switching will happens with an effect, random chosen between the available effects.

See image 8-1.

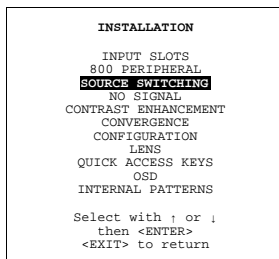

Menu 8-10

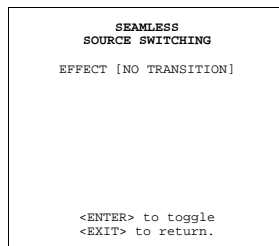

Menu 8-11



Image 8-1
Example of seamless switching with Fade effect.



When an effect is selected within seamless source switching, wait until the effect is terminated before switching to another source (± 2 seconds).

8.5 No Signal

Overview

- Changing the Background Color
- Changing the Shutdown Setting
- Changing the Shutdown Time

8.5.1 Changing the Background Color

How to change ?

1. Push the cursor key \uparrow or \downarrow to highlight *No signal*. (menu 8-12)
2. Press **ENTER** to select.

The no signal menu will be displayed. (menu 8-13)

3. Push the cursor key \uparrow or \downarrow to highlight *Color*. menu 8-13
4. Press **ENTER** to toggle between [blue] or [black].

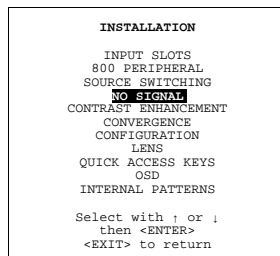

Menu 8-12

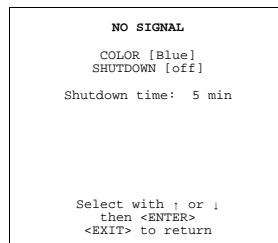

Menu 8-13

8.5.2 Changing the Shutdown Setting

How to change ?

1. Push the cursor key ↑ or ↓ to highlight *No Signal*. (menu 8-14)
2. Press **ENTER** to select.
The no signal menu will be displayed. (menu 8-15)
3. Push the cursor key ↑ or ↓ to highlight *Shutdown*. menu 8-15
4. Press **ENTER** to toggle between [On] or [Off].

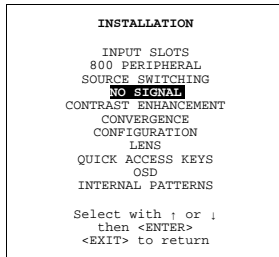

Menu 8-14

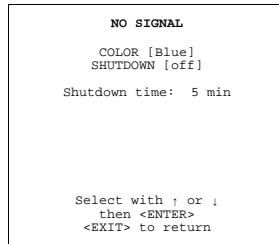

Menu 8-15

8.5.3 Changing the Shutdown Time

Range

The shutdown time can be set between 5 min. and 60 min.

How to change ?

To set up the shutdown time, handle as follow:

1. Push the cursor key ↑ or ↓ to highlight *No Signal*. (menu 8-16)
2. Press **ENTER** to select.
The no signal menu will be displayed. (menu 8-17)
3. Push the cursor key ↑ or ↓ to highlight *Shutdown Time*. menu 8-17
4. Push the cursor key ↑ or ↓ to change the digits.
Or,
Enter the digits directly with the digit keys on the RCU.

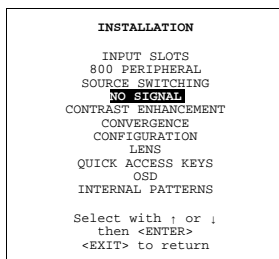

Menu 8-16

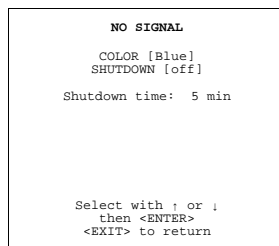

Menu 8-17

8.6 Contrast Enhancement

Purpose

Increases contrast for all video and data sources.



Contrast enhancement will reduce the light output of the projector.

To change the Contrast Enhancement value

1. Push the cursor key ↑ or ↓ to highlight *Contrast Enhancement*. (menu 8-18)
2. Press **ENTER** to select.

The contrast enhancement menu will be displayed. (menu 8-19)

3. Push the cursor key ↑ or ↓ to highlight the desired contrast enhancement, normal or high.
4. Press **ENTER** to select.

A timer will countdown from 45 seconds to 0. During this time, no action maybe undertaken. The projector is switching the contrast setting and has to recalculate the internal settings. (menu 8-20)

```

INSTALLATION
INPUT SLOTS
800 PERIPHERAL
SOURCE SWITCHING
NO SIGNAL
CONTRAST ENHANCEMENT
CONVERGENCE
CONFIGURATION
LENS
QUICK ACCESS KEYS
OSD
INTERNAL PATTERNS
Select with ↑ or ↓
then <ENTER>
<EXIT> to return

```

Menu 8-18

```

CONTRAST ENHANCEMENT
NORMAL CONTRAST
HIGH CONTRAST
Select with ↑ or ↓
then <ENTER>
<EXIT> to return

```

Menu 8-19

```

CONTRAST ENHANCEMENT
NORMAL CONTRAST
HIGH CONTRAST
Remaining time : 44 sec
Select with ↑ or ↓
then <ENTER>
<EXIT> to return

```

Menu 8-20

8.7 Convergence

What can be done?

The convergence of the displayed image can be adjusted only by a qualified service technician.

How to start up?

1. Push the cursor key ↑ or ↓ to highlight *Convergence*. (menu 8-21)
2. Press **ENTER** to select.

The following message will be displayed : "Convergence is reserved to qualified service personnel." (menu 8-22)

```

INSTALLATION
INPUT SLOTS
800 PERIPHERAL
SOURCE SWITCHING
NO SIGNAL
CONTRAST ENHANCEMENT
CONVERGENCE
CONFIGURATION
LENS
QUICK ACCESS KEYS
OSD
INTERNAL PATTERNS
Select with ↑ or ↓
then <ENTER>
<EXIT> to return

```

Menu 8-21

```

WARNING
CONVERGENCE
is reserved to
qualified
service personnel
<ENTER> to accept
<EXIT> to return

```

Menu 8-22

8.8 Configuration

What can be done?

The way of physical installation of the projector can be defined to the projector.

The following installation configurations are possible:

- front/table
- front/ceiling
- rear/table
- rear/table

Set up the Correct Configuration

1. Push the cursor key ↑ or ↓ to highlight *Configuration*. (menu 8-23)
2. Press **ENTER** to select.

The configuration menu will be displayed.

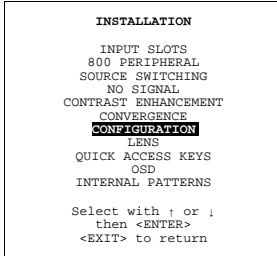

Menu 8-23



For more information, see Installation Guidelines .

8.9 Lens Adjustment

What can be done ?

All lens adjustments are motorized and can be adjusted with the RCU.

The following items can be adjusted:

- zoom/focus
- shift
- Options : same zoom/focus for all files, yes or no.

How to start up.

1. Push the cursor key ↑ or ↓ to highlight *Lens*. (menu 8-24)
2. Press **ENTER** to select.

The lens menu will be displayed. (menu 8-25)

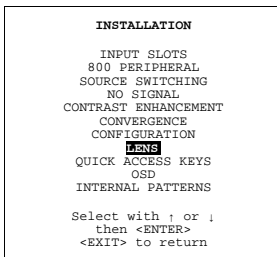

Menu 8-24

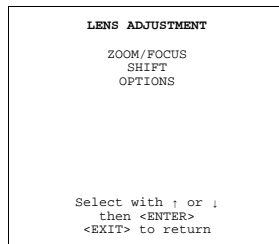

Menu 8-25

How to Zoom/Focus ?

1. Push the cursor key ↑ or ↓ to select Zoom/Focus. (menu 8-26)
2. Push the cursor key ↑ or ↓ to zoom and ← or → to focus the image.see "Quick Set Up Adjustments", page 48
3. When finished, press **EXIT** to return to the lens adjustment menu or press **ENTER** to go to the shift function.

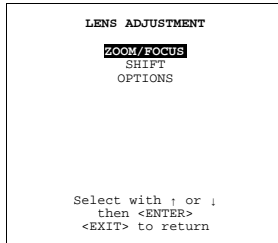

Menu 8-26



Press the selection key * to switch to another pattern. Different patterns are available.

How to shift the image?

1. When on the Zoom/Focus menu, press **ENTER** to switch to the shift menu or
2. When on the Lens Adjustment menu, Push the cursor key ↑ or ↓ to highlight *Shift* and press ENTER to display the shift menu. (menu 8-27)
3. Push the cursor key ↑ or ↓ to shift the image up or down and ← or → to shift the image left or right.
4. When finished, press **EXIT** to go to the lens adjustment menu or press **ENTER** to go to the zoom/focus function.

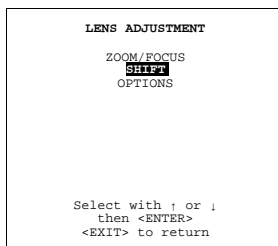

Menu 8-27



Press the selection key * to switch to another pattern. Different patterns are available.

Options

The zoom/focus and shift can be set the same for all files.

1. Push the cursor key ↑ or ↓ to highlight *Options*. (menu 8-28)
2. Press **ENTER** to select.

The Lens Options menu will be displayed. (menu 8-29)

3. Press **ENTER** to toggle between 'Yes' or 'No'.

[Yes] all lens settings will be the same for all files

[No] different lens settings for all files

Default setting : [Yes]

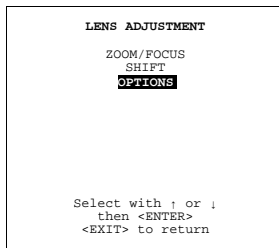

Menu 8-28

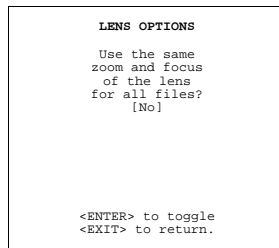

Menu 8-29



When in the 'No' position, the lens memory is using incremental motors which have an accuracy of 1 to 2 steps. This has no implication for zoom, but focus might demand some fine-tuning when switching from one source to another.

8.10 Quick Access Keys

What can be done?

It is possible to get an overview of the programmed functions of the different function keys (only accessible with an adapted RCU).

How to get an overview.

1. Push the cursor key ↑ or ↓ to highlight *Quick Access Keys*. (menu 8-30)
2. Press **ENTER** to select.

The Quick Access Overview menu will be displayed. (menu 8-31)

<*> starts up the lens adjustment functions

<0> 0 keys is used as prefix when selecting a PiP source. E.g. 0 + 2 will select source 2 as PiP source while only 2 will select source 2 as main source.

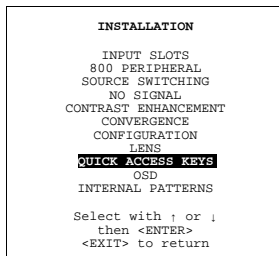

Menu 8-30

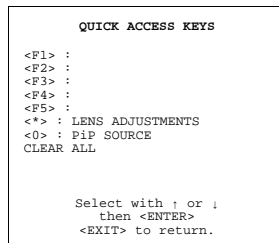

Menu 8-31



No functions are preprogrammed.

8.11 OSD

Overview

- Color Settings
- Menu Position

8.11.1 Color Settings

How to change

1. Push the cursor key ↑ or ↓ to highlight *OSD*. (menu 8-32)
2. Press **ENTER** to select.
3. Push the cursor key ↑ or ↓ to highlight *Highlighted item color*. (menu 8-33)
4. Press **ENTER** to toggle between Yellow, Red and Blue.

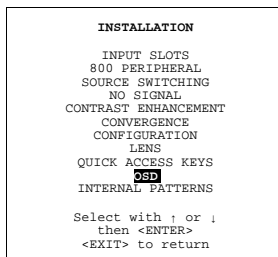

Menu 8-32

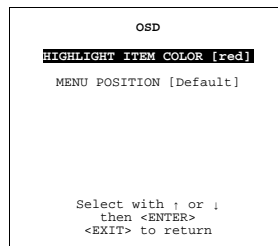

Menu 8-33

8.11.2 Menu Position

How to change

1. Push the cursor key ↑ or ↓ to highlight *OSD*. (menu 8-34)
2. Press **ENTER** to select.
3. Push the cursor key ↑ or ↓ to highlight *Menu Position*. (menu 8-35)
4. Press **ENTER** to toggle between [DEFAULT] and [CENTER].

DEFAULT menus displayed in the center, adjustment boxes displayed in the corner.

CENTER menus and adjustment boxes displayed in the center of the image.

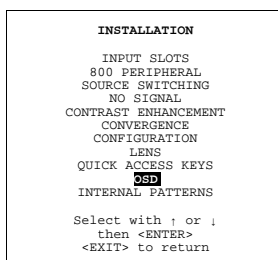

Menu 8-34

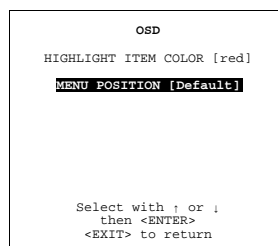

Menu 8-35

8.12 Internal Patterns

What can be done with these internal patterns?

The projector is equipped with different internal patterns which can be used for measurement purposes.

Available patterns

- Outline
- Hatch
- Color bars
- Multiburst
- Checker board
- Page Char
- Alpha numeric char

How to select an internal patterns?

1. Push the cursor key ↑ or ↓ to highlight *Internal Patterns*. (menu 8-36)
2. Press **ENTER** to select.

The internal patterns menu will be displayed. (menu 8-37)

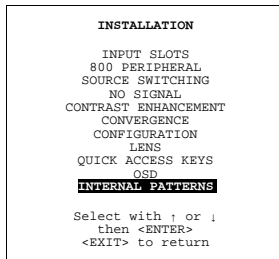

Menu 8-36

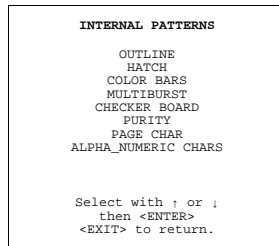

Menu 8-37

9. SERVICE MODE

9.1 Built-up

Built-up

The service menu is built-up in two parts which are connected together with the 'more' item. If the desired item is not in the list of the displayed menu, select 'more' with the cursor key and push ENTER to display the other items in the service menu.

9.2 Start up

Start up

1. Push the cursor key ↑ or ↓ to highlight *Service*. (menu 9-1)
2. Press **ENTER** to display the service mode menu. (menu 9-2)

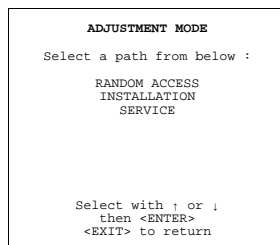

Menu 9-1

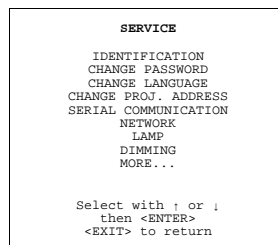

Menu 9-2

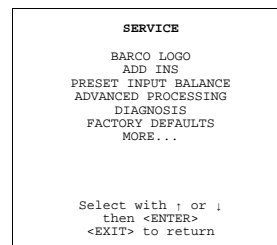

Menu 9-3



Some items in the Service mode are password protected (when the password function is active). Enter the password to continue. All other password protected items are now available if you stay in the adjustment mode.

9.3 Identification

What can be seen on the identification screen?

The identification screen shows the general information of the projector.

The following items will be displayed:

- Type of projector: BARCO SLM G10
- Software version
- Network module: yes
- Proj. address: To change the address of the projector, see "Change Projector Address", page 105
- Installation:
 - front/ceiling
 - front/table
 - rear/ceiling
 - rear/table
- Baud rate: transfer speed for communication with an IBM PC (or compatible) or MAC. The baud rate of the projector must be the same as the baud rate of the connected computer. When there is a difference, consult 'Change Baudrate PC' in this chapter.
- Projector Run Time: gives the total run time since the first start up. All projectors leave the factory with a run time of approximately 24 hours.
- Projector Serial number: indicates the fabrication number of the projector. This number can be useful when calling for technical assistance.

Start Up

1. Push the cursor key ↑ or ↓ to highlight *Identification*. (menu 9-4)
2. Press **ENTER** to display the Identification screen. (menu 9-5)

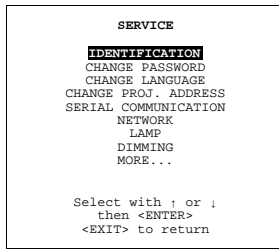

Menu 9-4

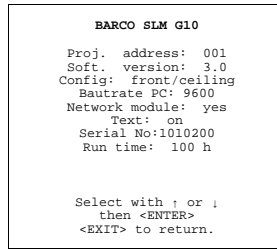

Menu 9-5

9.4 Password

Overview

- Change Password
- Access Control List

9.4.1 Change Password

How to enable or disable the password function ?

This item is password protected when the password strap is installed.

The password function is enabled when the password strap, second switch of S2 on the controller module is installed. Consult an authorized Barco service technician to change the strap position.

About password types.

3 different password levels are built in, in the projector software.

The different levels are:

- owner
- user
- guest

Depending on your password level some password protected items are accessible and others not. The owner (which has the highest level) can set up via the 'Access control list' the accessibility of the different items. See 'Access Control List'.

Get access to the controller module

1. Power down the projector and disconnect the power cord from the wall outlet.
2. Loosen the indicate screws of the input box. (image 9-1, image 9-2)
3. Pull out the input box by both handlers.
4. When a metal top cover of the box is mounted, remove first by turning out the screws. (image 9-3)
5. When looking inside the box, the controller module with the switches is situated in the middle of the box. (image 9-4)
6. Change the position of S2.



Image 9-1

Image 9-2
Access password switchImage 9-3
Metal top cover

Image 9-4

How to change the password ?

1. Push the cursor key ↑ or ↓ to highlight *Change Password*. (menu 9-6)
2. Press **ENTER** to display the *Change Password* menu. (menu 9-7)
Note: Only possible when Owner.
The old passwords are displayed.
3. Push the cursor key ↑ or ↓ to highlight the password which must be changed.
4. Press **ENTER** to select.
Enter the new password with the numeric keys of the RCU or local keypad.
5. Select the next password or press **ENTER** to save the changes.
Press **EXIT** to return without saving the new passwords.

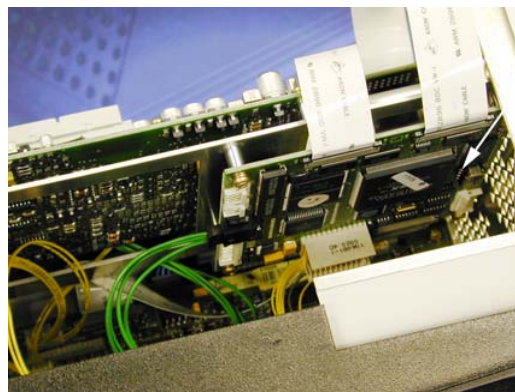
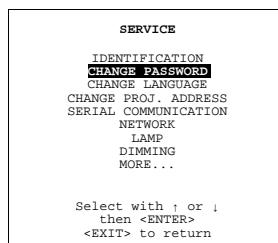

Menu 9-6

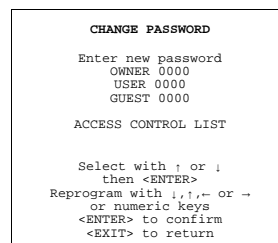

Menu 9-7

9.4.2 Access Control List

What is possible?

In the access control list the owner can set up the access possibilities for the user and the guest.

Set up of an Access Control List.

1. Push the cursor key ↑ or ↓ to highlight Change Password. (menu 9-8)
2. Press **ENTER** to display the Change password menu. (menu 9-9)
Note: Only possible when Owner.
3. Push the cursor key ↑ or ↓ to highlight Access Control List.
4. Press **ENTER** to display the Access Control List menu. (menu 9-10)

For each item an access possibility can be set for owner, user, guest or everybody.

```

SERVICE
IDENTIFICATION
CHANGE PASSWORD
CHANGE LANGUAGE
CHANGE PROJ. ADDRESS
SERIAL COMMUNICATION
NETWORK
LAMP
DIMMING
MORE...

Select with ↑ or ↓
then <ENTER>
<EXIT> to return
    
```

Menu 9-8

```

CHANGE PASSWORD
Enter new password
OWNER 0000
USER 0000
GUEST 0000
ACCESS CONTROL LIST

Select with ↑ or ↓
then <ENTER>
Reprogram with ↑, ↓, ← or →
or numeric keys
<ENTER> to confirm
<EXIT> to return
    
```

Menu 9-9

```

ACCESS CONTROL LIST
Menu      O  U  G  E
Adj mode  Y  Y  Y  Y
BARCO LOGO Y  -  -  -
Change add Y  Y  -  -

O=owner, U=user, G=Guest
E=everybody

Select with ↑ or ↓
then <ENTER>
<EXIT> to return.
    
```

Menu 9-10

Changing an access possibility

1. Push the cursor key ↑ or ↓ to select an item in the scroll list.
2. Press **ENTER** to select.
3. Push the cursor key ← or → to select owner, user, guest or everybody.
4. Press **ENTER** to toggle between Y(yes) or N(no).
5. Repeat both steps if necessary.

Access Levels

An access level can be added to the following items:

- Adjustment mode
- Barco logo
- Change projector address
- File delete
- File delete all
- Input balance
- Installation
- Random access
- Serial communication
- Service

9.5 Changing Language

Start up

1. Push the cursor key ↑ or ↓ to highlight *Change Language*. (menu 9-11)
2. Press **ENTER** to display the *Change Language* menu. (menu 9-12)
3. Push the cursor key ↑ or ↓ to highlight the desired language.
4. Press **ENTER** to change the language.

Available languages: English

```

SERVICE
IDENTIFICATION
CHANGE PASSWORD
CHANGE LANGUAGE
CHANGE PROJ. ADDRESS
SERIAL COMMUNICATION
NETWORK
LAMP
DIMMING
MORE...

Select with ↑ or ↓
then <ENTER>
<EXIT> to return

```

Menu 9-11

```

CHANGE LANGUAGE

ENGLISH

Select with ↑ or ↓
then <ENTER>
<EXIT> to return

```

Menu 9-12

9.6 Change Projector Address

How to change the projector address?

1. Push the cursor key ↑ or ↓ to highlight *Change Proj Address*. (menu 9-13)
2. Press **ENTER**.
The Change Projector Address menu will be displayed and the actual address will be filled in. (menu 9-14)
3. Push the cursor key ↑ or ↓ to highlight *Projector address*.
4. Press **ENTER** to activate.
The first digit will be highlighted.
5. Reprogram the address with ↑, ↓, ←, → keys

Use the ↑ or ↓ key to select a new value, use the ← or → key to select a new digit.

Or,

use the numeric keys on the RCU to enter the new address.

The address must be between 0 and 9 when controlling the projector with the RCU or between 0 and 255 when controlling the projector via RS232.

```

SERVICE
IDENTIFICATION
CHANGE PASSWORD
CHANGE LANGUAGE
CHANGE PROJ. ADDRESS
SERIAL COMMUNICATION
NETWORK
LAMP
DIMMING
MORE...

Select with ↑ or ↓
then <ENTER>
<EXIT> to return

```

Menu 9-13

```

CHANGE PROJ. ADDRESS

PROJECTOR ADDRESS 1
COMMON ADDRESS (RC5) 0
COMMON ADDRESS (PPM) 0

Select with ↑ or ↓
then <ENTER>
Reprogram with ↑, ↓, ←, →
or numeric keys
<ENTER> to confirm
<EXIT> to return.

```

Menu 9-14

How to change the common address

1. Push the cursor key ↑ or ↓ to highlight *Change Proj Address*. (menu 9-15)
2. Press **ENTER**.
The Change Projector Address menu will be displayed and the actual address will be filled in. (menu 9-16)
3. Push the cursor key ↑ or ↓ to highlight *Common address*.

9. Service Mode

4. Press **ENTER** to activate.

The address digit will be highlighted.

5. Select 0 or 1 with the ↑ or ↓ keys
Or,
enter the new value with the numeric keys.

```
SERVICE
IDENTIFICATION
CHANGE PASSWORD
CHANGE LANGUAGE
CHANGE PROJ. ADDRESS
SERIAL COMMUNICATION
NETWORK
LAMP
DIMMING
MORE...

Select with ↑ or ↓
then <ENTER>
<EXIT> to return
```

Menu 9-15

```
CHANGE PROJ. ADDRESS
PROJECTOR ADDRESS 1
COMMON ADDRESS (RC5) 0
COMMON ADDRESS (PPM) 0

Select with ↑ or ↓
then <ENTER>
Reprogram with ↑,↓,←,→
or numeric keys
<ENTER> to confirm
<EXIT> to return.
```

Menu 9-16

9.7 Serial Communication

Overview

- Start Up of the Serial Communication
- Baud rate Setting
- Setting up the Interface Standard
- RS422 Termination

9.7.1 Start Up of the Serial Communication

Start up

1. Push the cursor key ↑ or ↓ to highlight *Serial communication*. (menu 9-17)
2. Press **ENTER** to display the Serial Communication menu. (menu 9-18)

```
SERVICE
IDENTIFICATION
CHANGE PASSWORD
CHANGE LANGUAGE
CHANGE PROJ. ADDRESS
SERIAL COMMUNICATION
NETWORK
LAMP
DIMMING
MORE...

Select with ↑ or ↓
then <ENTER>
<EXIT> to return
```

Menu 9-17

```
SERIAL COMMUNICATION
PROJECTOR ADDRESS 001
BAUDRATE [115200]
INTERFACE STANDARD [RS232]
RS422 TERMINATION [ON]

Select with ↑ or ↓
then <ENTER>
<EXIT> to return
```

Menu 9-18

9.7.2 Baud rate Setting

Set up

To change the baud rate, handle as follow:

1. Push the cursor key ↑ or ↓ to highlight *Baudrate*. (menu 9-19)
The actual baud rate will be displayed.

2. Press **ENTER** to toggle between the available baudrates.

Default : 9600

```

SERIAL COMMUNICATION
PROJECTOR ADDRESS 001
BAUDRATE [115200]
INTERFACE STANDARD [RS232]
RS422 TERMINATION [ON]

Select with ↑ or ↓
then <ENTER>
<EXIT> to return

```

Menu 9-19

Available baud rates.

115200/57600/38400/19200/9600/4800/1200

9.7.3 Setting up the Interface Standard

Set up

The communication protocol for the communication between the projector and a computer can be set on RS232 or RS422. To set up the desired protocol, handle as follow :

1. Push the cursor key ↑ or ↓ to highlight *Interface Standard*. (menu 9-20)
The actual interface standard will be displayed.

2. Press **ENTER** to toggle between RS232 and RS422.

Default : RS232

```

SERIAL COMMUNICATION
PROJECTOR ADDRESS 001
BAUDRATE [115200]
INTERFACE STANDARD [RS232]
RS422 TERMINATION [ON]

Select with ↑ or ↓
then <ENTER>
<EXIT> to return

```

Menu 9-20

9.7.4 RS422 Termination

Set up

The last projector in a line should be RS422 terminated (ON position). All others in the line should be in the OFF position. To change the termination position :

1. Push the cursor key ↑ or ↓ to highlight RS422 Termination. (menu 9-21)

The actual setting will be displayed.

2. Press **ENTER** to toggle between ON and OFF.

Default : ON

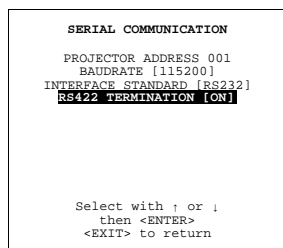

Menu 9-21

9.8 Network Configuration



DHCP

Dynamic host configuration protocol

What can be done?

The necessary network addresses (configuration) can be entered so that the projector can be connected to a LAN (local area network).

Set up the network configuration.

To set up the network configuration, follow the next procedure :

1. Push the cursor key ↑ or ↓ to highlight *Network Configuration*. (menu 9-22)
2. Press **ENTER** to display the network configuration menu. (menu 9-23)
3. Set DHCP on or off (contact your network responsible for the correct setting in your environment).

DHCP on DHCP server assigned an IP address to the client (network projector).

DHCP off the client has to fill out the IP address, the subnet mask and the default gateway.

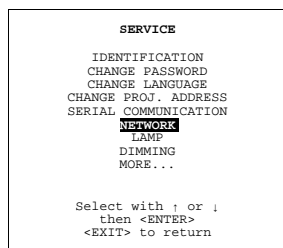

Menu 9-22

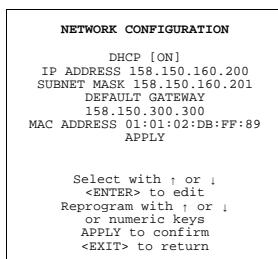

Menu 9-23

Entering the necessary addresses.

1. Select the IP address with the cursor keys. (menu 9-24)
2. Press **ENTER** to edit.
3. Enter or reprogram the address with the numeric keys (contact your network responsible for the correct address).

An address contains 4 octets with a maximum value of 255, separated by a bullet.

4. Repeat the above steps for the subnet mask and the default gateway.
5. Select **APPLY** and press **ENTER** to install the entered addresses.

If a wrong value for an octet is entered, the following error message will be displayed to indicate where the error is located.
Example of message : "Invalid octet. The maximum value is 255 for each octet ! ". (menu 9-25)

```

NETWORK CONFIGURATION
DHCP [ON]
IP ADDRESS 158.150.160.200
SUBNET MASK 158.150.160.201
DEFAULT GATEWAY
158.150.300.300
MAC ADDRESS 01:01:02:DB:FF:89
APPLY

Select with ↑ or ↓
<ENTER> to edit
Reprogram with ↑ or ↓
or numeric keys
APPLY to confirm
<EXIT> to return

```

Menu 9-24

```

ERROR
Invalid octet
the maximum value is
255 for each octet!

<EXIT> to return.

```

Menu 9-25

9.9 Lamp

Lamp information light output switching

All information about the lamp is stored inside the lamp house and can be displayed via the projector software on the projection screen. No information can be changed.

The Constant light output function can be changed between OFF, [slave] and [master].



By using the CLO function, the lamp life time will enlarge.

CLO for a single projector

When the CLO functions is in the OFF position, the lamp will follow the normal life cycle curve.

When the CLO function is ON (projector master or slave), the projector will regulate the lamp power until the preprogrammed CLO value (number of lumens) (full line) is reached. As long as this power is below the maximum power of the lamp, the projector will give a constant light output. Once the maximum power is reached, the projector will follow again the normal lamp life cycle curve.

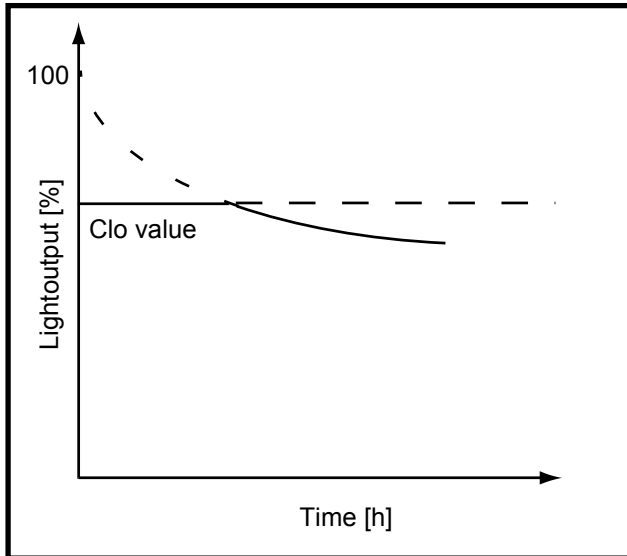

Image 9-5
CLO function of one projector

Linked CLO, used by multiple projectors

If the linked CLO function is in the OFF position, the lamp of each projector will follow its own life cycle curve (dotted lines). When in the ON position and linked as described below, all projectors will use the preprogrammed CLO value as long as no projector in the chain is using its maximum lamp power already. Once one projector is on its maximum lamp power (projector with the lowest light output) all other projectors will follow from now on the life cycle curve of this projector. That means that light output will be constant as long as no projector has reached its maximum lamp power. From then on, the light output of all projector will decrease (full line).

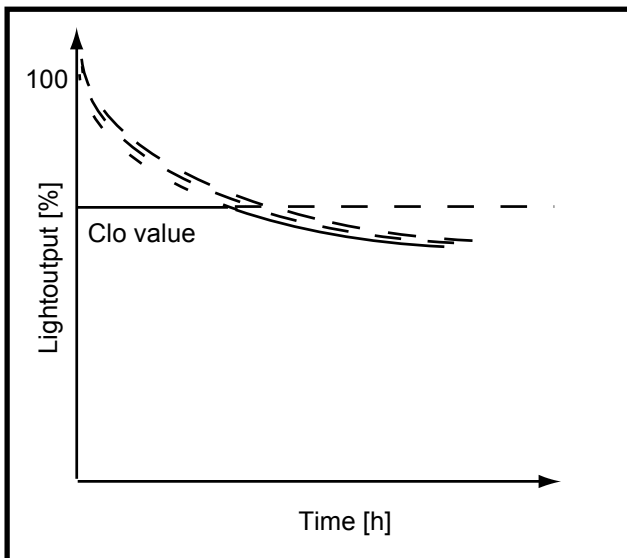

Image 9-6

Linking via the RS232 in/out

The constant light output of projectors in a chain (maximum 12 projectors) can be set to the same value by linking the projectors via the RS232 connector.

To the RS232in of the first projector, a terminator must be connected (**Z3498823**). The out of the first must be connected to the in of the next projector, etc.

All projectors must have a different projector address between 1 and 12.

All must have the same baud rate and RS mode.

The constant light output setting of one projector must be in the master position. All others must be in the slave position.

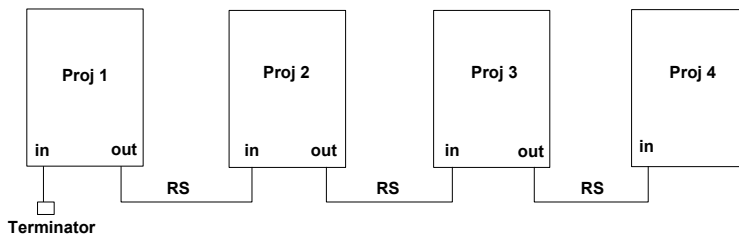

Image 9-7
Principal diagram : linking via RS port

Linking via the Comm port

The constant light output of the projectors can be set to the same value by linking the projectors via the Comm port and using one or more Comm 800 splitters (See Connections, Linked System).

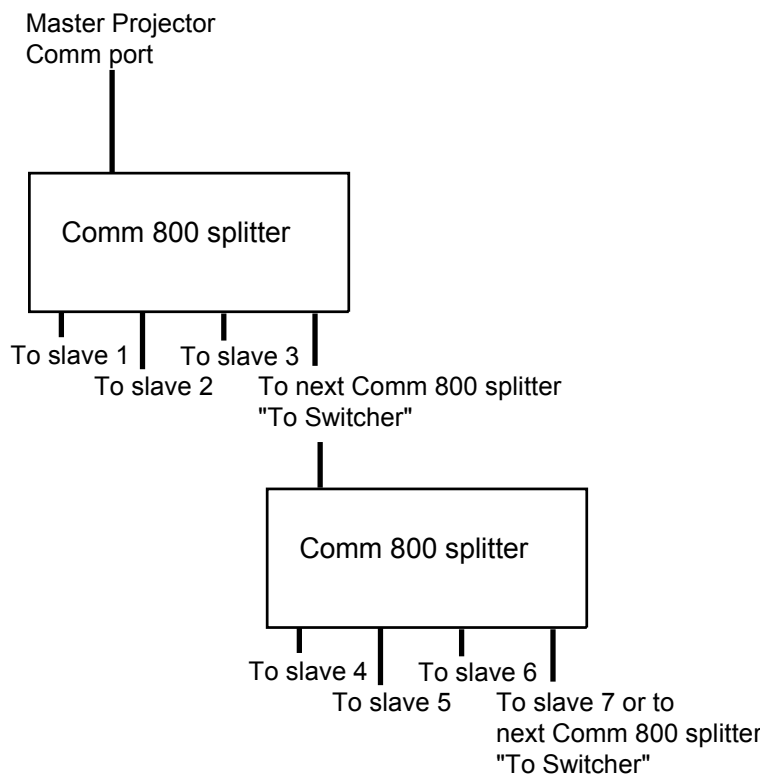

Image 9-8
Principal diagram: Linked via Comm port

For more information about the use of the Comm 800 splitter, consult the Comm 800 splitter documentation (R5976819).

Which information is available

serial number	unique serial number of the lamp
type	lamp type
run time	total time the lamp is used in this or other projectors.
remaining run time	time left before the lamp must be replaced Using the lamp longer than the maximum run time may damage the projector.
number of strikes	Total times the lamp is started up.
Z-AXIS	indication to adjust the Z-AXIS of the lamp (see Re-adjustment of the lamp position in chapter Installation Guidelines).

How to display the lamp menu

1. Push the cursor key ↑ or ↓ to highlight *Lamp*. (menu 9-26)
2. Press **ENTER** to select.

The lamp menu will be displayed. (menu 9-27)

```

SERVICE
IDENTIFICATION
CHANGE PASSWORD
CHANGE LANGUAGE
CHANGE PROJ. ADDRESS
SERIAL COMMUNICATION
NETWORK
LAMP
DIMMING
MORE...

Select with ; or |
then <ENTER>
<EXIT> to return

```

Menu 9-26

```

LAMP
Constant Light output [OFF]
Using [RS port]
Mode [NORMAL]
Serial number : R101111
Article number : R9840xxx
Run time : 10 hours
Remaining run time : 490
hours
Number of strikes : 10
Z_AXIS : 100

Select with ; or |
then <ENTER>
<EXIT> to return.

```

Menu 9-27

How to switch the constant light output?

1. Push the cursor key ↑ or ↓ to highlight *Constant Light Output*.menu 9-27
2. Press **ENTER** to toggle between [OFF], [SLAVE] and [MASTER].

- [OFF] fixed power, no power adaptation.
- [SLAVE] follows the master projector to adjust the CLO. When stand alone and the light output should be adjusted, put on slave.
- [MAS-TER] master projector to control the CLO in a chain of projectors.

Linked port

1. Push the cursor key ↑ or ↓ to highlight *Using*.menu 9-27
2. Press **ENTER** to toggle between [RS port] or [Comm port].

- [RS port] RS port is used to make a linked connection
- [Comm port] Comm port is used to make a linked connection

Mode switching

1. Push the cursor key ↑ or ↓ to highlight *Mode*.menu 9-27
2. Press **ENTER** to toggle between [NORMAL] and [ECONOMIC].

- normal normal light output
- economic reduced light output (+ less noise)

9.10 Dimming

What is possible

The lamp can be dimmed in small steps only when the lamp is used in *Normal* mode. The dimming can be done between normal mode and economic mode.

How to dim

1. Push the cursor key ↑ or ↓ to highlight *Dimming*. (menu 9-28)
2. Press **ENTER** to select.
A dimming slider box appears on the screen.
3. Use the ↑ or ↓ keys to dim the lamp until the desired light output is reached.

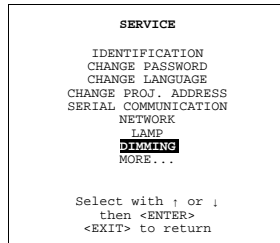

Menu 9-28

9.11 BARCO Logo

What can be done?

The BARCO logo can be added to the image, in overlay or on a background, on any place on the screen.

How to add the BARCO logo or to change the setting?

1. Push the cursor key ↑ or ↓ to highlight *BARCO logo*. (menu 9-29)
2. Press **ENTER** to select.

The *BARCO logo* menu will be displayed. (menu 9-30)

The actual settings will be displayed. Within this menu, three toggle settings and a shift control are available.

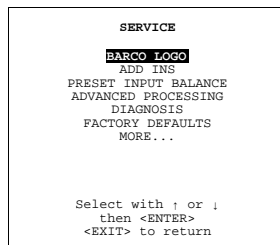

Menu 9-29

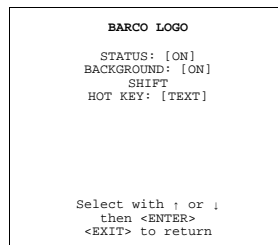

Menu 9-30

Available Settings

- STATUS [ON/OFF]
ON : BARCO logo will be displayed on the screen.
OFF: NO BARCO logo displayed on the screen.
- BACKGROUND [ON/OFF]
ON: BARCO logo will be displayed on a black background.
OFF: BARCO logo will be displayed without any background.
- SHIFT
By pushing the cursor key ↑, ↓, ← or →, the BARCO logo can be positioned anywhere on the screen.
- HOT KEY [TEXT/OFF]
OFF: no key on the RCU is used to display the BARCO logo.
TEXT: the TEXT key on the RCU is used to display or to remove the BARCO logo with one single push on this key (only in operational mode).

9.12 Add-Ins

How to get add ins?

The available add-ins can be activated by entering your personal access key when buying this function. Please contact your reseller. He will ask for the serial number of your projector.

Available Add Ins

CLO : When activated, the lamp option 'Constant light output' in the menu 'Lamp' becomes available.

Scenergix : When activated, soft edging becomes possible in the Random access adjustment mode.

How to activate an add-ins?

1. Push the cursor key ↑ or ↓ to highlight *Add-Ins*. (menu 9-31)
The Add-Ins menu will be displayed. (menu 9-32)
2. Push the cursor key ↑ or ↓ to highlight an Add-Ins.
3. Press **ENTER** to activate.
The Install Add-Ins menu will be displayed. E.g. (menu 9-33)
4. Enter your personal key.
The key exists out of 16 alphanumeric characters.
5. To reprogram the key, use the cursor key ↑, ↓, ← or → or the numeric keys for the digits.
When the entered key is correct, the indication 'Software : not activated' will change in 'activated'.
6. Press **ENTER** to confirm.

```

SERVICE
  BARCO LOGO
  PRESET INPUT BALANCE
  ADD INS
  ADVANCED PROCESSING
  DIAGNOSIS
  FACTORY DEFAULTS
  MORE...

Select with ; or |
then <ENTER>
<EXIT> to return
    
```

Menu 9-31

```

ADD-INS
  CLO [INACTIVE]
  SCENERGIX [INACTIVE]

Select with ; or |
then <ENTER>
<EXIT> to return.
    
```

Menu 9-32

```

INSTALL ADD-INS
  CLO
  KEY :xxxxxxxxxxxxxxxx
  Hardware : OK
  Software : Not activated

Select with ; or |
Reprogram with ;,|,← or →
<ENTER> to confirm
<EXIT> to return.
    
```

Menu 9-33

9.13 Preset Input Balance



CAUTION: Changing these settings may seriously affect the performance of the projector.

Start Up

1. Push the cursor key ↑ or ↓ to highlight *Preset Input Balance*. (menu 9-34)
2. Press **ENTER** to select.

The following warning will be displayed : (menu 9-35)

Preset input balance is reserved to qualified service personnel. If you are not qualified, press **EXIT** to cancel the panel adjustments.

```

SERVICE
BARCO LOGO
ADD INS
PRESET INPUT BALANCE
ADVANCED PROCESSING
DIAGNOSIS
FACTORY DEFAULTS
MORE...

Select with ; or |
then <ENTER>
<EXIT> to return

```

Menu 9-34

```

WARNING

PRESET INPUT BALANCE
is reserved to
qualified
service personnel

<ENTER> to accept
<EXIT> to return

```

Menu 9-35

9.14 Advanced Processing

Overview

- Minimum Delay

9.14.1 Minimum Delay

Purpose

In normal mode, the processing (scaling and de-interlacing) in DLP projectors introduces a few frames delay (from input to screen). Setting the option *Minimum Delay* to "ON" disables all scaling and de-interlacing in the processing and reduces frame delay of the projector (from input to screen) to ONE frame, caused by the formatter board (DLP technology restriction). The intended use of this option is to apply native and progressive data to the projector and displaying it with minimum delay, using the full resolution of the projector. Other formats will be displayed either unscaled and/or interlaced.

This feature can be used if additional delay in the projector is not acceptable. For instance if a projector is showing the DVI loop out of another DLP or if an external scaler/de-interlacer does the processing.

How to toggle

1. Push the cursor key ↑ or ↓ to highlight *Advanced Processing*. (menu 9-36)
2. Press **ENTER** to select.

The *Advanced Processing* menu will be displayed. (menu 9-37)

3. Select Minimum Delay and press ENTER to toggle between [ON] or [OFF].

```

SERVICE
BARCO LOGO
ADD INS
PRESET INPUT BALANCE
ADVANCED PROCESSING
DIAGNOSIS
FACTORY DEFAULTS
MORE...

Select with ; or |
then <ENTER>
<EXIT> to return

```

Menu 9-36

```

ADVANCED PROCESSING
MINIMUM DELAY [ON]

<ENTER> to toggle
<EXIT> to return

```

Menu 9-37

9.15 Diagnosis

9.15.1 How to start up the Diagnosis?

What can be seen?

The diagnosis menu gives the possibility to select an overview of the I²C controlled IC's and an overview of the working of the formatter.

Start up

1. Push the cursor key ↑ or ↓ to highlight *Diagnosis*. (menu 9-38)
2. Press **ENTER** to select.

The diagnosis menu will be displayed. (menu 9-39)

```
SERVICE
BARCO LOGO
ADD INS
PRESET INPUT BALANCE
ADVANCED PROCESSING
DIAGNOSIS
FACTORY DEFAULTS
MORE...

Select with ↑ or ↓
then <ENTER>
<EXIT> to return
```

Menu 9-38

```
DIAGNOSIS
I2C
FORMATTER
SMPS
LPS1
LPS2
LPS3
VOLTAGES
FANSPEED

Select with ↑ or ↓
then <ENTER>
<EXIT> to return
```

Menu 9-39

9.15.2 I²C Diagnoses

How to select?

1. Push the cursor key ↑ or ↓ to highlight *I2C*. (menu 9-40)
2. Press **ENTER** to select.

The I²C Diagnosis overview will be displayed.

If the indication behind the hex code is green, everything is ok.

If the indication is red, something is wrong with that indicated address. (menu 9-41)

```
DIAGNOSIS
I2C
FORMATTER
SMPS
LPS1
LPS2
LPS3
VOLTAGES
FANSPEED

Select with ↑ or ↓
then <ENTER>
<EXIT> to return
```

Menu 9-40

```
I2C DIAGNOSIS
DECODER 12H ###
MOTOR DRIVER 1AH ###
LIGHT SENSOR 1CH ###
LAMP DRIVER 20H ###
POWER SUPPLY 30H ###
FORMATTER 34H ###
PMP 4AH ###
INPUT SELECTOR 72H ###
INPUT SELECTOR 98H ###
INPUT SELECTOR 9AH ###
LAMP MODULE A0H ###

Select with ↑ or ↓
<EXIT> to return.
```

Menu 9-41

9.15.3 Formatter

How to select the overview?

1. Push the cursor key ↑ or ↓ to highlight *Formatter*. (menu 9-42)
2. Press **ENTER** to select.

An overview of the working of the formatter will be displayed. (menu 9-43)

```

DIAGNOSIS
 I2C
 FORMATTER
 SMPS
 LPS1
 LPS2
 LPS3
 VOLTAGES
 FANSPEED

Select with ↑ or ↓
then <ENTER>
<EXIT> to return

```

Menu 9-42

```

FORMATTER
 I2C (34H)      OK
 CONFIGURATION OK
 INITIALISATION OK
 SELF TEST     OK
 RED DISPLAY   OK
 GREEN DISPLAY OK
 BLUE DISPLAY  OK

<EXIT> to return.

```

Menu 9-43

9.15.4 SMPS

How to select the overview?

1. Push the cursor key ↑ or ↓ to highlight *SMPS*. (menu 9-44)
2. Press **ENTER** to select.

The SMPS overview menu will be displayed. (menu 9-45)

```

DIAGNOSIS
 I2C
 FORMATTER
 SMPS
 LPS1
 LPS2
 LPS3
 VOLTAGES
 FANSPEED

Select with ↑ or ↓
then <ENTER>
<EXIT> to return

```

Menu 9-44

```

SMPS
µC VERSION      03.01
EEPROM VERSION  03.00
Internal T.     26(45)C
NTC T.         38(80)C
Internal temp.  OK
NTC            OK
TILT SWITCH    OK
MICRO SWITCH   OK
LAMP TEMP      OK
LPS MAINS      OK
SMPS OUTPUT    OK

<EXIT> to return

```

Menu 9-45

9.15.5 LPS (lamp power supply)

How to select the overview?

1. Push the cursor key ↑ or ↓ to highlight *LPS*. (menu 9-46)
2. Press **ENTER** to select.

The *LPS* overview menu will be displayed. (menu 9-47)

```

DIAGNOSIS
 I2C
 FORMATTER
 SMPS
 LPS1
 LPS2
 LPS3
 VOLTAGES
 FANSPEED

Select with ↑ or ↓
then <ENTER>
<EXIT> to return

```

Menu 9-46

```

LPS1
µC Version      02.01
EEPROM Version  01.11
Internal T.     029(075)C
Rectifier T.    037(105)C
Heats. PFC T.   029(100)C
Heats. LPS T.   028(100)C
Trafo T.        032(105)C
I2C            OK

<EXIT> to return

```

Menu 9-47

9.15.6 Voltages

How to select the overview?

1. Push the cursor key ↑ or ↓ to highlight *Voltages*. (menu 9-48)
2. Press **ENTER** to select.

The *voltage* overview window will be displayed. (menu 9-49)

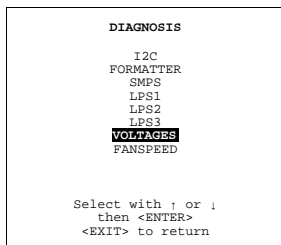

Menu 9-48

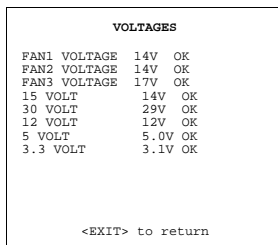

Menu 9-49

9.16 Factory defaults

What is possible ?

The projector will set all settings to the factory defaults which are by default stored in the projector. All custom settings will be deleted and the custom files will be removed.

How to return to the factory defaults ?

1. Push the cursor key ↑ or ↓ to highlight *Factory defaults*. (menu 9-50)
2. Press **ENTER** to select.

The *Factory defaults* confirmation and warning menu will be displayed. (menu 9-51)

3. Are you sure to restore the factory defaults ?
If yes, press the cursor key ↑ or ↓ to highlight *Continue*.

A message will be displayed. (menu 9-52)
If no, press the cursor key ↑ or ↓ to highlight *Return*.

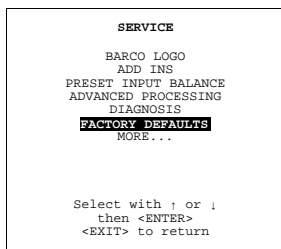

Menu 9-50

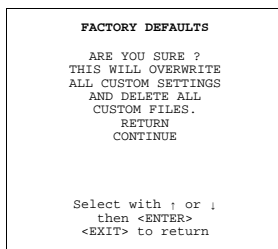

Menu 9-51

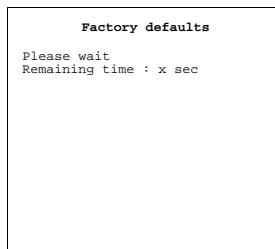

Menu 9-52



Restoring the factory defaults can take a while. When finished, the projector will automatically reboot and those factory settings will be loaded.

10. PROGRAMMABLE FUNCTION KEYS

10.1 Function Keys

What can be done with these keys?

The five function keys on top of an adapted remote control can be programmed as short cut keys (quick access) to almost any adjustment menu.

How can a function key be programmed?

A function key can only be programmed when in the adjustment mode. Handle as follow :

1. Scroll through the menus until the desired menu is reached.
2. Press the desired function key for this menu during a few seconds.

A confirmation menu will be displayed : " <F1> will be used to quickly access this menu". (menu 10-1)

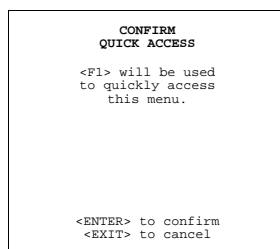

Menu 10-1

A. STANDARD SOURCE SET UP FILES

A.1 Table overview

Table overview

The following standard source files are pre-programmed in the projector.

Name ¹	Resolu- tion ²	Fvert Hz ³	FHor kHz ⁴	Fpix MHz ⁵	Ptot ⁶	Pact ⁷	Ltot ⁸	Lact ⁹
1600_48V	1600x600i	48,040	62,500	135,000	2160	1600	651	600
1600_60V	1600x1200	60,000	75,000	162,000	2160	1600	1250	1200
1600_65V	1600x1200	65,000	81,250	175,500	2160	1600	1250	1200
1600_70V	1600x1200	70,000	87,500	189,000	2160	1600	1250	1200
8514_A	1024x384i	43,479	35,522	44,900	1264	1024	409	384
CGA	640x200	59,924	15,700	14,318	912	640	262	200
COMPUSC4	1024x480i	29,945	30,694	39,779	1296	1024	512	480
ED	735x480	59,943	31,470	28,638	910	735	525	480
EGA	640x350	59,702	21,851	16,257	744	640	366	350
EWS_50	1280x1024	50,000	52,350	87,948	1680	1280	1047	1024
EWS_60	1280x1024	60,000	63,900	107,352	1680	1280	1065	1024
EWS_60V	1280x1024	60,282	63,657	110,000	1728	1280	1056	1024
EWS_72	1280x1024	72,000	76,968	130,076	1690	1280	1069	1024
EWS_75	1280x1024	75,025	79,976	135,000	1688	1280	1066	1024
FMR	640x400i	42,323	36,440	28,570	784	640	431	400
FMT0_2	640x400	55,370	24,370	21,056	864	640	440	400
HD_24P	1920x1080	24,000	27,000	74,250	2750	1920	1125	1080
HD_25I	1920x540I	25,000	28,125	74,250	2640	1920	563	540
HD_25P	1920x1080	25,000	28,125	74,250	2640	1920	1125	1080
HD_30I	1920x540I	30,000	33n750	74,250	200	1920	563	540
HD_30I_2	1920x517I	30,000	33,750	74,250	2200	1920	563	517
HD_30P	1920x1080	30,000	33,750	74,250	2200	1920	1125	1080
HD_60P	1920x720	60,000	45,000	74,250	1650	1280	750	720
HDMAC	1252x570i	25,020	31,250	39,125	1252	1024	625	570
INTER_GR	1184x886	67,170	61,796	92,941	1504	1184	920	886
MAC_2	640x480	66,667	35,000	30,240	864	640	525	480

1. Name: name of file, contains the settings.
2. Resolution: image resolution, when followed by ..i means interlaced.
3. Fvert Hz: vertical frame frequency of the source
4. FHor kHz: horizontal frequency of the source
5. Fpix MHz: pixel frequency
6. Ptot : total pixels on one horizontal line.
7. Pact: active pixels on one horizontal line.
8. Ltot: total lines in one field.
9. Lact: active lines in one field.

A. Standard Source set up Files

Name ¹	Resolu- tion ²	Fvert Hz ³	FHor kHz ⁴	Fpix MHz ⁵	Ptot ⁶	Pact ⁷	Ltot ⁸	Lact ⁹
MAC_3	512x384	60,147	24,480	15,667	640	512	407	384
MAC_4	560_384	60,147	24,480	17,234	704	560	407	384
MAC_5	512x342	60,158	22,259	16,670	704	512	370	342
MAC_6	832x624	74,546	49,722	57,280	1152	832	667	624
MAC_7	1024x768	74,907	60,150	80,000	1330	1024	803	768
MAC_LC	640x480	66,619	34,975	31,338	896	640	525	480
MAC_POR	640x870	74,996	68,846	57,280	932	640	918	870
MUSE	1172x518i	30,000	33,750	37,125	1172	1024	563	518
VIDEO525	1302x239i	29,970	15,734	32,207	1302	1024	263	239
VIDEO625	1024x278i	25,000	15,625	31,984	1310	1024	313	278
PAM500	640x400	60,000	26,400	22,810	864	640	440	400
PAM800	1120x375i	44,936	36,443	50,000	1372	1120	406	375
PC98_1	640x400	56,416	24,823	21,050	848	640	440	400
PC98_2	1120x375i	39,994	32,835	47,840	1457	1120	411	375
PC98_3	1120x750	60,000	50,000	78,569	1571	1120	833	750
S1152_66	1152x900	66,004	61,846	94,500	1528	1152	937	900
S1152_76	1152x900	76,637	71,809	108,000	1504	1152	937	900
SDI_625	675x2781	25,000	15,625	13,500	864	720	313	278
SDI_525	675x2401	29,970	15,734	13,500	858	720	263	240
SG_50	1600x1200	50,000	62,500	130,313	2085	1600	1250	1200
SG_60_2	1024x768	60,000	48,780	64,390	1320	1024	813	768
SG_60_3	960x680	60,000	43,200	54,432	1260	960	720	680
SG_60_4	1600x1200	60,000	75,000	156,375	2085	1600	1250	1200
SUNNEWS67	1280x1024	67,189	71,691	117,000	1632	1280	1067	1024
SUNNEWS76	1280x124	76,107	81,130	135,000	1664	1280	1066	1024
SUNXGA60	1024x768	59,984	48,287	64,125	1328	1024	805	768
SUNXGA70	1024x768	70,041	56,596	74,250	1312	1024	808	768
SUNXGA77	1024x768	77,069	62,040	84,375	1360	1024	805	768
SUP_MAC	1024x768	60,000	48,780	63,999	1312	1024	813	768
SVGA_56V	800x600	56,250	35,156	36,000	1024	800	625	600
SVGA_60V	800x600	60,317	37,879	40,000	1056	800	628	600

Name ¹	Resolu- tion ²	Fvert Hz ³	FHor kHz ⁴	Fpix MHz ⁵	Ptot ⁶	Pact ⁷	Ltot ⁸	Lact ⁹
SVGA_72V	800x600	72,084	48,080	50,003	1040	800	667	600
VGA_72V	640x480	72,800	37,856	31,496	832	640	520	480
VGA_GR	640x480	59,941	31,469	25,175	800	640	525	480
VGA_TXT	720x400	70,087	31,469	28,322	900	720	449	400
VGA75ISO	640x480	75,000	39,375	31,500	800	640	525	480
XGA_60	1024x768	60,000	48,360	64,996	1344	1024	806	768
XGA_70	1024x768	70,000	57,050	78,044	1368	1024	815	768
XGA_70V	1024x768	69,705	56,182	74,610	1328	1024	806	768
XGA_72	1024x768	71,955	58,140	80,000	1376	1024	808	768
XGA_75	1024x768	75,781	61,080	86,000	1408	1024	806	768
XGA75_GS	1024x768	74,534	59,701	79,284	1328	1024	801	768

Table A-1

B. CLEANING THE DUST FILTERS



WARNING: As the projector has to be opened, this procedure has to be performed by qualified service technician.

When should it be done?

Depending on the environment, the dust filters should be cleaned at least when replacing the lamp. When the projector operates in dusty environment, clean the dust filters earlier than when replacing the lamp.

B.1 Dust filter on the front side

Necessary tools

- Allen key 8mm
- Flat screw driver 5mm
- Philips screwdriver

What should be done

To get access to the front dust filters, the top cover must be removed.

How to remove

1. Take off the lens (see chapter lenses).
2. Turn out the bolts securing the stacking sockets. (image B-1)
3. Remove the stacking sockets.
4. Loosen the security screw of the input box. (image B-2)
5. Slide out the input box a little.
6. Loosen the screw on the front side. (image B-3)
7. Remove the back cover, see "Dust filter on the back side", page 128.
8. Turn out the screw on the top and the right side.
9. Take off the top cover.
10. Turn out the 4 screws holding the dust filter. (image B-4)
11. Take out the dust filter on the inside of the cover.

B. Cleaning the dust filters



Image B-1
Removing stacking sockets

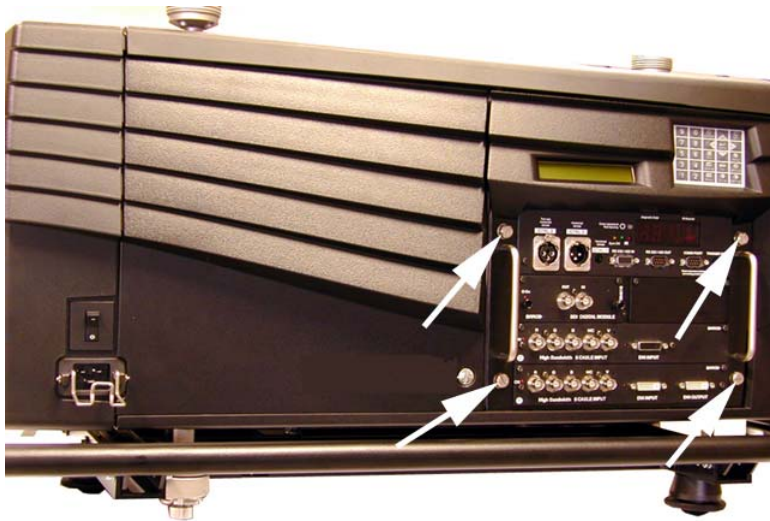

Image B-2
Input box slide out



Image B-3
Front screw top cover removal



Image B-4
Dust filter removal

How to clean

1. Clean the dust filter with a dry cloth or blow out with compressed air.



Reinsert the dust filters and put the cover back on its place by following the opposite procedure. Take care to click the lens light cover into its position.

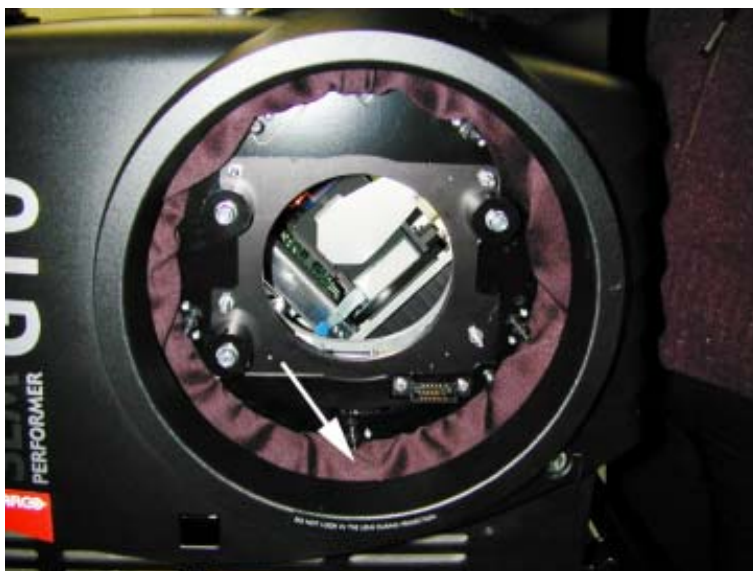

Image B-5

B.2 Dust filter on the back side

Necessary tools

- Flat screwdriver
- Philips screwdriver

What should be done

To get access to the dust filters, the back cover must be removed.

How to remove

1. Loosen the 3 screw on the back side. (image B-6)
2. Take off the cover.
3. Turn out 2 times 4 screws to remove both dust filters on the back side of the cover. (image B-7)
4. Take out the dust filters.
5. Turn out the 4 screw on the bottom side and take out the dust filter. (image B-8)



Image B-6
Back cover removal



Image B-7
Dust filter removal



Image B-8
Dust filter removal

How to clean

1. Clean the dust filter with a dry cloth or blow out with compressed air.



Reinsert the dust filters and put the cover back on its place by following the opposite procedure.

B.3 Dust filter on the bottom side

Necessary tools

No tools.

How to remove

1. Pull on both lips of the dust filter on the front side of the projector until the filter is completely removed. (image B-9)



Image B-9
Dust filter bottom side

How to clean

1. Clean the dust filter with a dry cloth or blow out with compressed air.
2. Reinsert the dust filter.

Revision Sheet

To:

► **Barco nv Events/Documentation**
Noordlaan 5, B-8520 Kuurne
Phone: +32 56.36.89.70, Fax: +32 56.36.88.24
E-mail: antoon.dejaegher@barco.com, Web: www.barco.com

From: _____

Date: _____

Please correct the following points in this documentation (**R5976562/03**):

page

wrong

correct

Free Manuals Download Website

<http://myh66.com>

<http://usermanuals.us>

<http://www.somanuals.com>

<http://www.4manuals.cc>

<http://www.manual-lib.com>

<http://www.404manual.com>

<http://www.luxmanual.com>

<http://aubethermostatmanual.com>

Golf course search by state

<http://golfingnear.com>

Email search by domain

<http://emailbydomain.com>

Auto manuals search

<http://auto.somanuals.com>

TV manuals search

<http://tv.somanuals.com>