



**BARCO PROJECTION SYSTEMS**



**R9001070**

**OWNER'S MANUAL**

Date: 140798

Rev. : 04

Art. No. :R5975696

Due to constant research, the information in this manual is subject to change without notice.

Produced by BARCO NV, July 1998  
All rights reserved.

Trademarks are the rights of their respective owners.

Printed in Belgium

WARNINGS & SAFETY INSTRUCTIONS .....	1-1
AVERTISSEMENTS & PRESCRIPTIONS DE SECURITE .....	1-1
Remarque sur la Sécurité .....	1-2
Notice on Safety .....	1-3
Instructions pour l'installation .....	1-2
Installation Instructions .....	1-3
Prescriptions de securite générales. ....	1-6
Sécurité .....	1-6
General Safety Instructions. ....	1-7
On safety .....	1-7
L'Installation .....	1-8
Entretien et Réparation .....	1-8
On Installation .....	1-9
On Servicing .....	1-9
Nettoyage .....	1-10
Ré-emballage .....	1-10
On Cleaning .....	1-11
On Repacking .....	1-11
Eclairage .....	1-12
On Illumination .....	1-13
UNPACKING & DIMENSIONS .....	2-1
Unpacking .....	2-2
Projector Dimensions .....	2-3
Battery Installation in the RCU. ....	2-4
INSTALLATION GUIDELINES .....	3-1
Installation Guidelines .....	3-2
Environment .....	3-2
What about Ambient Light ? .....	3-2
Which Screen Type? .....	3-3
What Image Size? How Big should the Image be? .....	3-3
Where to Install the Projector? .....	3-4
How to Install a Projection Lens? .....	3-6

## Table of contents

---

INSTALLATION SET UP .....	4-1
LOCATION AND FUNCTION OF CONTROLS .....	5-1
Front Panel Terminology .....	5-2
Control Panel Terminology .....	5-4
a. Local Keypad .....	5-4
b. Remote Control .....	5-4
POWER CONNECTION .....	6-1
Power (Mains) Cord Connection .....	6-2
Fuses .....	6-2
Switching ON .....	6-2
Lamp Life Time .....	6-4
Switching to Stand-by. ....	6-4
Switching OFF .....	6-4
INPUT CONNECTIONS .....	7-1
Signal Input Connection to the Projector. ....	7-2
Connecting a Video Source to the BNC Input (source 1) .....	7-3
Connecting a Video Source to the Cinch Input (source 2) .....	7-4
Connecting a S-Video Source to the 4-pin mini DIN Input (source 3) .....	7-5
Connecting a RGB Analog Source to Source 4 or 5 .....	7-6
Connecting a RGB3S Analog Source to Source 4 or 5. ....	7-8
Connecting a computer, e.g. IBM PC (or compatible), Apple Macintosh to the RS 232 Input of the Projector. ....	7-9
Set Up of the Baud Rate for Communication with a Computer. ....	7-9
Connecting a RCVDS 800 or RCVDS 05 to the BARCODATA 2100. ....	7-10
Connecting a VS05 to the BARCODATA 2100. ....	7-10
Connecting an IR Remote Receiver 800 to the BARCODATA 2100. ....	7-10
CONTROLLING .....	8-1
How to Use the RCU? .....	8-2
Projector Address .....	8-3
How to Display a Projector Address? .....	8-4
How to Program an Address into the RCU? .....	8-4

Picture Controls with Direct Access .....	8-4
Sound Controls with Direct Access .....	8-5
The Pause Key .....	8-6
The Mute Key .....	8-6
<b>START UP OF THE ADJUSTMENT MODE .....</b>	<b>9-1</b>
Adjustment Mode .....	9-2
<b>RANDOM ACCESS ADJUSTMENT MODE .....</b>	<b>10-1</b>
Starting Up the Random Access Adjustment Mode .....	10-2
File Service .....	10-3
Load File .....	10-4
Edit File .....	10-5
Rename .....	10-10
Copy .....	10-11
Delete .....	10-12
File Options .....	10-13
Picture Tuning .....	10-13
Sync SLOW/FAST .....	10-14
Still Video .....	10-14
Color Balance .....	10-15
Gamma .....	10-16
Audio Tuning .....	10-17
Volume, Bass, Balance, Treble .....	10-17
Mute .....	10-18
Lock [OFF/AUDIO A/AUDIO B/AUDIO C] .....	10-18
Fade .....	10-19
Geometry .....	10-20
Shift .....	10-20
Size .....	10-21
Zoom .....	10-22
Blanking .....	10-23
Scale [1:1] .....	10-25

## Table of contents

---

INSTALLATION .....	11-1
Starting Up the Installation Mode .....	11-2
Configuration .....	11-3
Internal Patterns .....	11-3
SERVICEMODE .....	12-1
Starting Up the Service Mode .....	12-2
Identification .....	12-5
Change Password .....	12-6
How to Enable or Disable the Password Function ? .....	12-6
How to Change the Password ? .....	12-7
Change Projector Address .....	12-8
Change Baudrate PC .....	12-8
Reset Lamp Runtime .....	12-9
Lamp Run Time History .....	12-10
Preset Input Balance .....	12-11
Change Language .....	12-12
75 W Termination .....	12-13
Dimming .....	12-13
I2C Diagnosis .....	12-14
OPTIONALEQUIPMENT .....	14-1
IR Receiver 800 .....	14-2
Hardwired RCU .....	14-2
RCVDS 800 / RCVDS 05 .....	14-3
VS05 .....	14-3
Interface .....	14-4
Adapter and Communication Cables .....	14-4
Ceiling Mount Kit CM50 .....	14-4
Appendix A : Standard Source Set Up Files .....	A-1
Appendix B : Battery Replacement in the RCU .....	B-1
Appendix C : Focusing the Lens .....	C-1

*Table of contents*

---

Appendix D : Lens Cleaning Procedure .....	D-1
Appendix E : Source numbers 90 - 99 .....	E-1
Appendix F : Lenses .....	F-1

**WARNINGS**  
**AVERTISSEMENTS**

**Safety Instructions**  
***Prescriptions de sécurité***

**On Safety**  
***sécurité***

**On Installation**  
***installation***

**On Servicing**  
***entretien et réparation***

**On Cleaning**  
***nettoyage***

**On Repacking**  
***re-emballage***

**On Illumination**  
***éclairage***



## *Prescriptions de sécurité*

---

### *Remarque sur la Sécurité*

Les projecteurs sont fabriqués conformément aux exigences des normes de sécurité internationales EN60950, UL 1950 et CSA C22.2 No. 950. Ces normes de sécurité sont imposées aux équipements de la technologie informatique incluant les équipements électriques.

Ces normes de sécurité imposent des exigences importantes sur l'emploi des composantes, des matériaux et de l'isolation dont la sécurité est critique, afin de protéger l'utilisateur contre le risque d'une décharge électrique et d'avoir accès aux parties sous tension. Les normes de sécurité aussi imposent des limitations concernant la hausse de la température interne et externe, les niveaux de radiation, la stabilité et la force mécanique, la construction du cadre métallique à l'intérieure et la protection contre les risques d'incendie.

Les épreuves auxquelles l'équipement a été subi assurent la sécurité totale de l'utilisateur, même lorsque l'équipement ne fonctionne pas normalement.

### *Instructions pour l'installation*

Lire ce manuel complètement avant de mettre l'appareil en fonctionnement et le conserver pour consultation ultérieure.

L'installation et les réglages préliminaires devraient être faits par du personnel qualifié BARCO ou par des agents autorisés du service BARCO.

### **DONNÉES POUR LE PROPRIÉTAIRE**

Le numéro de pièce et le numéro de série sont situés à l'avant du projecteur. Copier ces numéros dans les espaces prévus ci-dessous. Se référer à ces numéros chaque fois que vous consultez votre agent BARCO concernant cet appareil.

**NUMERO DE PIECE :**

**NUMERO DE SERIE :**

**AGENT :**

### *Notice on Safety*

Projectors are built in accordance with the requirements of the international safety standards EN60950, UL 1950 and CSA C22.2 No. 950, which are the safety standards of information technology equipment including electrical business equipment.

These safety standards impose important requirements on the use of safety critical components, materials and isolation, in order to protect the user or operator against the risk of electric shock and energy hazard, and having access to live parts.

Safety standards also impose to the internal and external temperature rises, radiation levels, mechanical stability and strength, enclosure construction and protection against risk of fire.

Simulated single fault condition testing ensures the safety of the equipment to the user even when the equipment's normal operation fails.

### *Installation instructions*

Before operating your projector please read this manual thoroughly, and retain it for future reference.

Installation and preliminary adjustments should be performed by qualified BARCO personnel or authorized BARCO service dealers.

### **OWNER'S RECORD**

The part number and serial number are located at the front of the projector. Record these numbers in the spaces provided below. Refer to them whenever you call upon your BARCO dealer regarding this product.

**PART NUMBER:**

**SER. NUMBER:**

**DEALER:**



L'éclair avec une tête de flèche dans un triangle indique à l'utilisateur que les pièces à l'intérieur de l'appareil présentent un risque de chocs électriques.



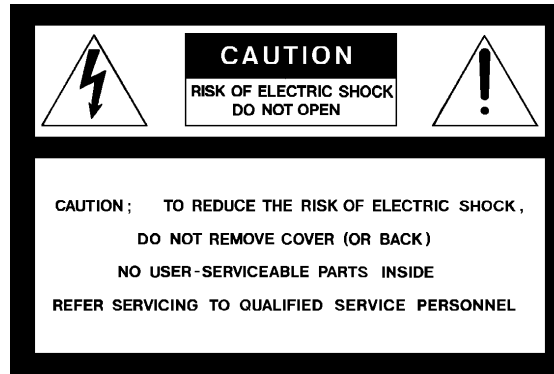
Le point d'exclamation dans un triangle indique à l'utilisateur que des instructions de fonctionnement et/ou de service sont comprises dans la documentation technique de cet équipement.

**POUR EVITER DES RISQUES D'INCENDIE OU DE CHOCS ELECTRIQUES, NE PAS EXPOSER CE PROJECTEUR A LA PLUIE OU A L'HUMIDITE**

### *Fédéral communication commission (FCC statement)*

Cet équipement a été testé et trouvé conforme aux limites imposées aux appareils digitaux de classe B, selon la section 15 des règles FCC. Ces limites sont conçues pour fournir une protection raisonnable contre les interférences lorsque l'utilisation doit se faire dans un environnement commercial. Cet équipement génère, utilise et peut émettre de l'énergie aux fréquences radio, et s'il n'est pas installé

et utilisé conformément aux instructions du manuel, il peut créer des interférences désavantageuses dans les communications radio. L'utilisation de cet équipement dans des zones résidentielles peut créer des interférences. Le cas échéant, l'utilisateur devra prendre toutes les mesures requises pour les amoindrir, à ses propres frais.



The lightning flash with an arrowhead within a triangle is intended to tell the user that parts inside this product are risk of electrical shock to persons.



The exclamation point within a triangle is intended to tell the user that important operating and/or servicing instructions are included in the technical documentation for this equipment.

**Warning**  
To prevent fire or electrical shock hazard, do not expose this projector to rain or moisture

### *Federal communication commission (FCC statement)*

This equipment has been tested and found to comply with the limits for a class B digital device, pursuant to Part 15 of the FCC Rules. These limits are designed to provide reasonable protection against harmful interference when the equipment is operated in a commercial environment. This equipment generates, uses, and can radiate radio

frequency energy and, if not installed and used in accordance with the instruction manual, may cause harmful interference to radio communications. Operation of this equipment in a residential area is likely to cause harmful interference in which case the user will be required to correct the interference at his own expense.

## Prescriptions de sécurité

Instructions pour l'utilisateur :

Si cet équipement cause des interférences de radio ou de télévision, l'utilisateur peut essayer de corriger les interférences en appliquant une ou plusieurs de les mesures suivantes :

- Ré-orienter l'antenne radio ou télévision.
- Déplacer l'équipement concernant le récepteur.
- Brancher l'appareil sur une autre prise de telle sorte que l'appareil et le récepteur se trouvent sur différents circuits électriques.
- Fixer les connecteurs des câbles à l'équipement au moyen des vis.

Remarque :

L'utilisation de câbles blindés est exigée afin d'observer les règles de la section 15 des règles FCC et EN55022

### Prescriptions de sécurité générales.

- \* Lire toutes les prescriptions de sécurité et de fonctionnement avant d'utiliser cet appareil.
- \* Le manuel de prescriptions de sécurité et de fonctionnement doit être conservé pour consultation ultérieure.
- \* Il faut respecter tous les avertissements mentionnés sur le projecteur et dans les manuels.
- \* Suivre fidèlement toutes les prescriptions d'utilisation et de fonctionnement de cet équipement.

## SECURITE

- \* Cet équipement doit fonctionner sur une source à courant alternatif. Ce projecteur peut être branché sur un système à IT courant.
- \* Cet appareil est équipé d'un connecteur à trois broches dont une mise à la terre. Le connecteur n'est adapté qu'à des prises de courant

du type avec terre. Ceci est une mesure de sécurité. Si le connecteur ne s'adapte pas dans la prise, contacter votre électricien pour remplacer la prise non valable. Ne pas compromettre le but du connecteur de terre.

Avertissement pour les utilisateurs: CE PROJECTEUR DOIT ÊTRE MIS À LA TERRE avec le cordon secteur fourni.

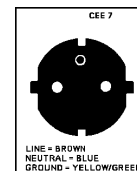
(Si le cordon secteur n'est pas correct, consulter votre revendeur.)

### A. Cordon d'alimentation avec connecteur CEE7

Les couleurs des fils du cordon d'alimentation sont codées comme suit :

Vert et jaune :	terre
Bleu :	neutre
Brun :	sous tension

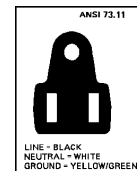
(actif)



### B. Cordon d'alimentation avec connecteur ANSI 73.11

Les couleurs des fils du cordon d'alimentation sont codées comme suit :

Vert/Jaune :	terre
Blanc :	neutre
Noir :	actif



- \* Ne rien laisser en appui sur le cordon d'alimentation. Ne pas placer ce cordon là où des personnes risquent de marcher dessus.

Instructions to the user :

if this equipment does cause interference to radio or television reception, the user may try to correct the interference by one or more of the following measures :

- Re-orientation of the receiving antenna for the radio or television.
- Relocate the equipment with respect to the receiver.
- Plug the equipment into a different outlet so that the equipment and receiver are on different branch circuits.
- Fasten cables connectors to the equipment by mounting screws.

Note :

*The use of shielded cables is required to comply within the limits of Part15 of FCC rules and EN55022.*

### General safety instructions.

- \* All the safety and operating instructions should be read before using this unit.
- \* The operating instructions manual should be retained for future reference.
- \* All warnings on the projector and in the documentation manuals should be adhered to.
- \* All instructions for operating and use of this equipment must be followed precisely.

### ON SAFETY

- \* This product should be operated from an AC power source. This projector may be connected to an IT-power system.
- \* This product is equipped with a 3-wire grounding plug, a plug having a third (grounding) pin. This plug will only fit into a grounding-type

power outlet. This is a safety feature. If you are unable to insert the plug into the outlet, contact your electrician to replace your obsolete outlet. Do not defeat the purpose of the grounding-type plug.

**WARNING FOR THE CUSTOMERS:** THIS APPARATUS MUST BE GROUNDED (EARTHED) via the supplied 3 conductor AC power cable.

(If the supplied power cable is not the correct one, consult your dealer.)

#### A. Mains lead (AC Power cord) with CEE 7 plug:

The colors of the mains lead are colored in accordance with the following code:

Green-and-yellow: Earth (safety

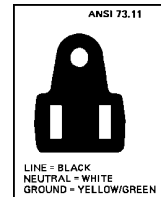
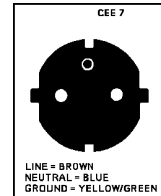
earth)

Blue: Neutral  
Brown: Live

#### B. Power cord with ANSI 73.11 plug:

The wires of the power cord are colored in accordance with the following code.

Green/yellow: ground  
White: neutral  
Black: live



## Prescriptions de sécurité

---

- \* Pour débrancher le cordon, le tirer par le connecteur, jamais par le cordon lui-même.
  - \* Si on utilise une rallonge, vérifier que le total des courants des appareils raccordés à cette rallonge ne dépasse pas la capacité nominale du câble de rallonge. Vérifier aussi que la somme des consommations des appareils raccordés à la prise murale ne dépasse pas 15 ampères.
  - \* Ne jamais introduire un objet quelconque dans l'appareil à travers les fentes du boîtier, car ils pourraient être en contact avec des points de tension dangereux ou court-circuiter des pièces, ce qui pourrait entraîner un risque d'incendie ou de choc électrique.
  - \* Ne jamais répandre un liquide quelconque sur l'appareil. Si un liquide ou un objet solide tombe dans le boîtier, débrancher l'appareil et le faire vérifier par du personnel qualifié avant de reprendre l'utilisation.
  - \* Foudre - Pour une protection supplémentaire de cet appareil vidéo lors d'un orage ou s'il n'est pas employé et laissé sans surveillance pendant de longues périodes, le débrancher de la prise murale. Ceci évite tout endommagement au projecteur par la foudre ou par des impulsions sur le secteur.
  - \* Avant de débrancher le projecteur, réduire la chaleur de la lampe en commutant le projecteur en mode d'attente et laisser refroidir la lampe du projecteur pendant 15 minutes au moins. Puis le projecteur peut être débranché par l'interrupteur secteur.
- \* Ne pas utiliser le projecteur à proximité d'eau.
  - \* N'utiliser que le cordon d'alimentation fourni avec votre projecteur. Bien qu'ils se ressemblent, d'autres cordons d'alimentation n'ont pas subi des tests de sécurité dans l'usine et pour cette raison ils ne peuvent pas être utilisés pour actionner le projecteur. Si vous avez besoin d'un cordon d'alimentation de remplacement, contactez votre agent.
  - \* Les fentes et les ouvertures pourvues dans le boîtier et au dos ou sur le fond, sont destinées à la ventilation. Pour assurer un fonctionnement fiable du projecteur et le protéger de toute surchauffe, ses ouvertures ne doivent être ni obstruées ni recouvertes. Les ouvertures ne devraient jamais être obstruées en plaçant l'appareil sur un lit, un divan, un tapis ou toute autre surface similaire. L'appareil ne devrait jamais être placé près ou au-dessus d'un radiateur ou autre source de chaleur. Ce projecteur ne doit pas être installé dans une installation encastrée ou fermée, sauf si une ventilation suffisante est assurée.
  - \* Laisser suffisamment d'espace autour du projecteur et ne pas obstruer la circulation de l'air. Ne pas mettre des feuilles libres ou d'autres objets plus près de 11 cm du projecteur.

## L'Installation

- \* Ne pas placer le projecteur sur un chariot, un support ou une table instable. Le projecteur risquerait de tomber causant des dégâts sérieux au projecteur.

## Entretien et Réparation

Ne pas essayer de réparer le projecteur vous-même, puisque ouvrir le boîtier ou l'enlèvement des blindages peuvent vous exposer à une puissance électrique dangereuse et au risque d'une décharge électrique.

- \* Do not allow anything to rest on the power cord. Do not locate this product where persons will walk on the cord.
- \* To disconnect the cord, pull it out by the plug. Never pull the cord itself.
- \* If an extension cord is used with this product, make sure that the total of the ampere ratings on the products plugged into the extension cord does not exceed the extension cord ampere rating. Also make sure that the total of all products plugged into the wall outlet does not exceed 15 amperes.
- \* Never push objects of any kind into this product through cabinet slots as they may touch dangerous voltage points or short out parts that could result in a risk of fire or electrical shock.
- \* Never spill liquid of any kind on the product. Should any liquid or solid object fall into the cabinet, unplug the set and have it checked by qualified service personnel before resuming operations.
- \* Lightning - For added protection for this video product during a lightning storm, or when it is left unattended and unused for long periods of time, unplug it from the wall outlet. This will prevent damage to the projector due to lightning and AC power-line surges.
- \* To reduce the lamp heat of the projector, switch the projector **first** to stand-by and let the projector lamp cool down for at least 15 minutes. Then the projector may be switched off with the power switch.
- \* Do not use this projector near water.
- \* Use only the power cord supplied with your projector. While appearing to be similar, other power cords have not been safety tested at the factory and may not be used to power the projector. For a replacement power cord, contact your dealer.
- \* Slots and openings in the cabinet and the sides are provided for ventilation; to ensure reliable operation of the projector and to protect it from overheating, these openings must not be blocked or covered. The openings should never be blocked by placing the product on a bed, sofa, rug, or other similar surface. This product should never be placed near or over a radiator or heat register. This projector should not be placed in a built-in installation or enclosure unless proper ventilation is provided.
- \* Do not block the projector cooling fans or free air movement under and around the projector. Loose papers or other objects may not be nearer to the projector than 4" on any side.

### *On Servicing*

Do not attempt to service this projector yourself, as opening or removing covers may expose you to dangerous voltage potential and

### *On Installation*

- \* Do not place this projector on an unstable cart, stand, or table. The projector may fall, causing serious damage to it.



## Prescriptions de sécurité

---

Contactez le service technique qualifié dans les cas suivants :

- Si le cordon secteur ou la prise de courant est endommagé ou effiloché.
- Si on a répandu du liquide dans le projecteur.
- Si l'appareil a été exposé à la pluie ou à de l'eau.
- Si l'appareil ne fonctionne pas normalement, bien que les instructions soient correctement suivies. Ne régler que les commandes décrites dans les instructions de fonctionnement, car un mauvais réglage d'autres commandes peut entraîner des dégâts et souvent nécessiter un travail important par un technicien qualifié pour remettre l'appareil en conditions de fonctionnement normal.
- Si l'appareil est tombé ou si le boîtier est endommagé.
- Si l'appareil présente des changements nets de performance, indiquant un besoin de réparation.

**Pièces de rechange** - Lorsqu'on a besoin des pièces de rechange, veiller à ce que le technicien de service utilise des pièces d'origine BARCO ou des pièces équivalentes autorisées qui ont les mêmes caractéristiques que la pièce d'origine BARCO. Un remplacement par des pièces de rechange non autorisées peut nuire à la performance et la fiabilité, entraîner incendies, chocs électriques ou d'autres dangers. L'utilisation de pièces de rechange non autorisées peut annuler la garantie.

**Vérification de sécurité** - Lorsqu'un service ou une réparation sur ce projecteur est terminé, demander au technicien de service de faire les vérifications de sécurité pour s'assurer que le projecteur est en bon état de fonctionnement.

Le projecteur emploie une lampe halogène à vapeurs métalliques de 575 W. Remplacer la lampe par une lampe de projection quelconque peut causer la surchauffe ou une qualité de l'image inacceptable. N'utiliser que des lampes de projection indiquées par BARCO ou un agent autorisé de BARCO ou un service.

### Nettoyage

Débrancher l'appareil de la prise avant tout nettoyage. Ne pas utiliser des détergents liquides ou des aérosols. Utiliser un chiffon humide pour le nettoyage.

Pour garder au boîtier son aspect neuf, le nettoyer régulièrement avec un chiffon doux. Des tâches tenaces peuvent être enlevées avec un chiffon humidifié par une solution de détergent doux. Ne jamais utiliser des solvants forts, tels que du 'thinner' ou du benzène, ni des produits de nettoyage abrasifs, car ils pourraient endommager le boîtier.

Pour garantir les meilleures performances et définition, les objectifs de projection sont spécialement traités avec un revêtement anti-reflets. En conséquence : éviter de toucher les objectifs. Pour enlever la poussière de l'objectif, utiliser un chiffon sec et doux. Ne pas utiliser de chiffon humide, de solution détergente ou de diluant. Respecter la méthode de nettoyage des objectifs indiquée dans l'annexe D au manuel d'utilisateur.

### Ré-emballage

Conserver l'emballage et les produits d'emballage d'origine, ils seront d'un précieux secours s'il avère utile d'expédier le projecteur. Pour une protection maximale, ré-emballer l'appareil de la même manière qu'à l'usine.

risk of electric shock! Refer all projector service to a qualified BARCO service center.

Call for service in the following conditions :

- When the power cord or plug is damaged or frayed.
- If liquid has been spilled into the projector.
- If the product has been exposed to rain or water.
- If the product does not operate normally when the operating instructions are followed.  
Adjust only those controls that are covered by the operating instructions since improper adjustment of the other controls may result in damage and will often require extensive work by a qualified technician to restore the product to normal operation;
- If the product has been dropped or the cabinet has been damaged;
- If the product exhibits a distinct change in performance, indicating a need for service.

**Replacement parts** - When replacement parts are required, be sure the service technician has used original BARCO replacement parts or authorized replacement parts which have the same characteristics as the BARCO original part. Unauthorized substitutions may result in degraded performance and reliability, fire, electric shock or other hazards. Unauthorized substitutions may void warranty.

**Safety check** - Upon completion of any service or repairs to this projector, ask the service technician to perform safety checks to determine that the projector is in proper operating condition.

The projector uses a 575 W metal halide projection lamp. Replacing the projection lamp with any other projection lamp can cause overheating or unacceptable image quality. Use only the projection lamps specified by BARCO, or an authorized BARCO dealer or service center.

### *On Cleaning*

Unplug this product from the wall outlet before cleaning. Do not use liquid cleaners or aerosol cleaners. Use a damp cloth for cleaning.

To keep the cabinet looking brand-new, periodically clean it with a soft cloth. Stubborn stains may be removed with a cloth lightly dampened with mild detergent solution. Never use strong solvents, such as thinner or benzene, or abrasive cleaners, since these will damage the cabinet.

To ensure the highest optical performance and resolution, the projection lenses are specially treated with an anti-reflective coating, therefore : avoid touching the lens. To remove dust on the lens, use a soft dry cloth. Do not use a damp cloth, detergent solution, or thinner. Follow the lens cleaning procedure on Appendix D in the Owners Manual.

### *On Repacking*

Save the original shipping carton and packing material; they will come

### *Eclairage*

Pour garantir la meilleure qualité possible de l'image projetée, il est essentiel que l'éclairage ambiant incident sur l'écran soit réduit au strict minimum.

Lors de l'installation du projecteur et de l'écran, il faut veiller à éviter toute exposition directe de l'écran à la lumière ambiante. Eviter tout éclairage perturbateur sur l'écran par des rayons du soleil ou des éclairages fluorescents.

L'utilisation d'un éclairage ambiant contrôlable, tel qu'un spot incandescent ou un variateur de lumière est recommandée pour obtenir un éclairage correct de la pièce. Dans la mesure du possible veiller à ce que les parois et le sol de la pièce dans laquelle le projecteur doit être installé soient non-réfléchissants et de couleur foncée. Des surfaces brillantes réfléchissent et diffusent la lumière ambiante et par conséquent réduisent le contraste de l'image sur l'écran.

in handy if you ever have to ship your projector. For maximum protection, repack your set as it was originally packed at the factory.

### *On Illumination*

In order to obtain the best quality for the projected image, it is essential that the ambient light which is allowed to fall on the screen be kept to an absolute minimum.

When installing the projector and screen, care must be taken to avoid exposure to ambient light directly on the screen. Avoid adverse illumination on the screen from direct sunlight or fluorescent lighting fixtures.

The use of controlled ambient lighting, such as incandescent spot light or a dimmer, is recommended for proper room illumination. Where possible, care should also be taken to ensure that the floors and walls of the room in which the projector is to be installed are non-reflecting, dark surfaces. Brighter surfaces will tend to reflect and diffuse the ambient light and hence reduce the contrast of the projected image on the screen.

**UNPACKING**

**DIMENSIONS**

**BATTERY INSTALLATION ON THE RCU**

## Unpacking & Dimensions

---

### Unpacking

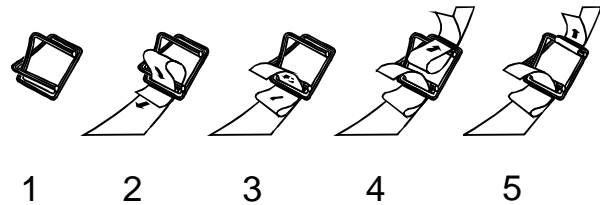
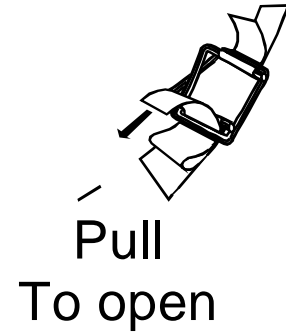
To open the banding, pull on the clip as shown in the first drawing.

Take the projector out of its shipping carton and place it on a table.

For transportation, the projector is mounted on a wooden board with 3 bolts (M5). Use a 8 mm wrench to remove these bolts.

When using the projector as a table mounted configuration, always mount the 3 plastic supporting feet by turning in into the provided holes (see drawing on next page).

Save the original shipping carton and packing material, they will come in handy if you ever have to ship your projector. For maximum protection, repack your projector as it was originally packed at the factory.

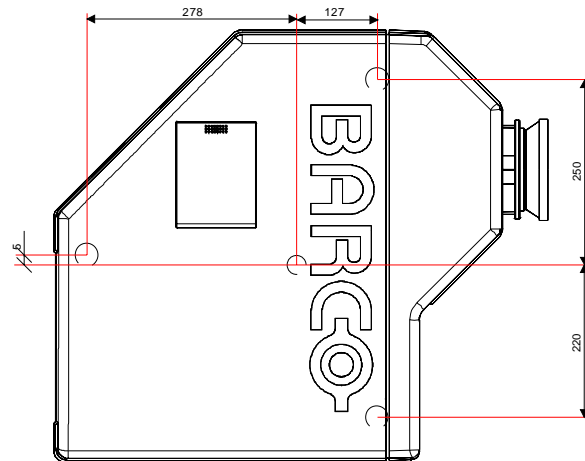
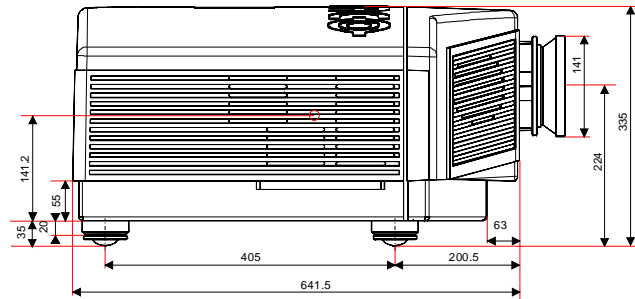
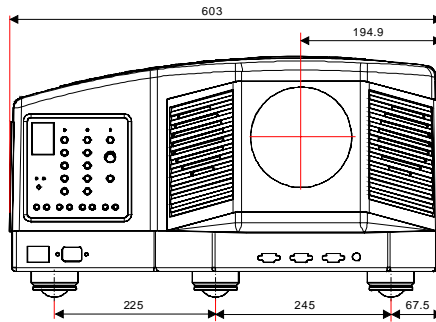


Contents of the shipped box :

- 1 BARCODATA 2100
- 1 remote control unit RCU + 1 9V battery
- 1 power cable with outlet plug type CEE7 or ANSI 73.11.
- 1 owner's manual.
- 1 installation manual.
- 3 plastic supporting feet.
- 2 supporting feet extensions for 100% off-axis projection.

## Projector Dimensions

(units : mm)



### Battery Installation in the RCU.

A battery (not yet installed to save the battery life time) is delivered inside the plastic bag with the power cord. Before using the RCU, start first the battery installation procedure.

Remove the battery cover on the backside of the remote control by pushing the indicated handle a little to the bottom of the RCU. Lift up the top side of the cover at the same time (fig. 1).

Insert the new 9 V battery in the lower compartment and connect the battery to the contact plate. Insert the battery into the lower compartment and put the cover back.

*Note : projector address has to be programmed on the RCU before using the RCU (see chapter 'Controlling').*

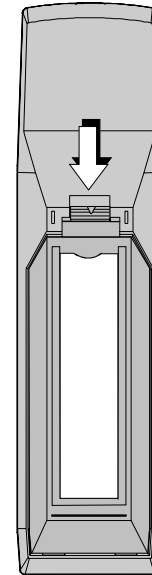


fig.1

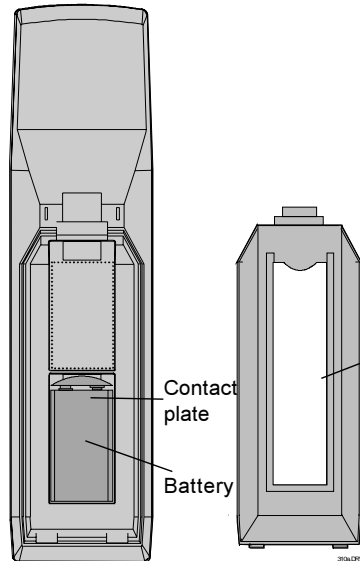


fig.2

Insert here the 'Insert card RCU' which you can cut out on the last page of this manual.



## **INSTALLATION GUIDELINES**

### **Environment**

**What about Ambient Light?**

**Which Screen Type?**

**What Image Size? How Big should the Image be?**

**Where to Install the Projector?**

**How to Install the Projector?**

### Installation Guidelines

Careful consideration of things as image size, ambient light level, projector placement and type of screen to use are critical to the optimum use of the projection system.

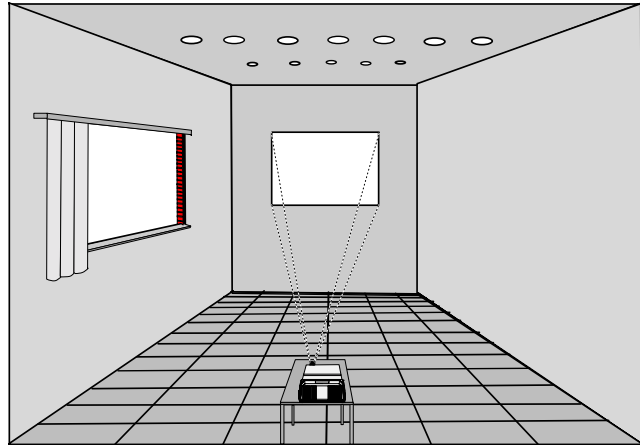
#### \* *Environment*

Do not install the projection system in a site near heat sources such as radiators or air ducts, or in a place subject to direct sunlight, excessive dust or humidity. Be aware that room heat rises to the ceiling; check that temperature near the installation site is not excessive.

#### \* *What about Ambient Light ?*

The ambient light level of any room is made up of direct or indirect sunlight and the light fixtures in the room. The amount of ambient light will determine how bright the image will appear. So, avoid direct light on the screen.

Windows that face the screen should be covered by opaque drapery while the set is being viewed. It is desirable to install the projecting system in a room whose walls and floor are of non-reflecting material. The use of recessed ceiling lights and a method of dimming those lights to an acceptable level is also important. Too much ambient light results in a 'wash out' of the projected image. That appears as less contrast between the darkest and lightest parts of the image. With bigger screens, the 'wash out' becomes more important. As a general rule, darken the room to the point where there is just sufficient light to read or write comfortably. Spot lighting is desirable for illuminating small areas so that interference with the screen is minimal.



### \* Which Screen Type?

There are two major categories of screens used for projection equipment. Those used for front projected images and those for rear projection applications.

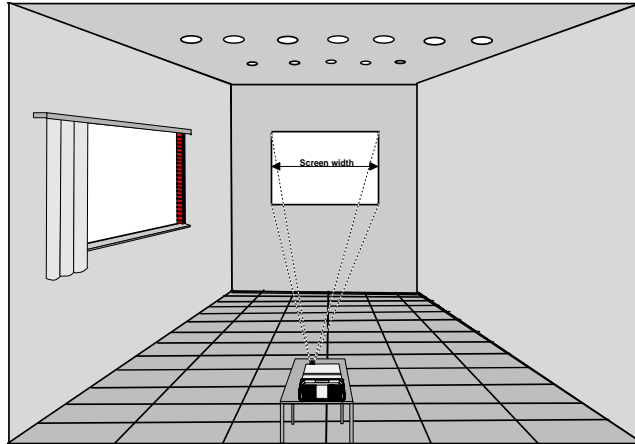
Screens are rated by how much light they reflect (or transmit in the case of rear projection systems) given a determined amount of light projected toward them. The 'GAIN' of a screen is the term used. Front and rear screens are both rated in terms of gain. The gain of screens range from a white matte screen with a gain of 1 (x1) to a brushed aluminized screen with a gain of 10 (x10) or more. The choice between higher and lower gain screens is largely a matter of personal preference and another consideration called the Viewing angle.

In considering the type of screen to choose, determine where the viewers will be located and go for the highest gain screen possible. A high gain screen will provide a brighter picture but reduce the viewing angle.

*For more information about screens, contact your local screen supplier.*

### \* What Image Size? How Big should the Image be?

The BARCODATA 2100 is designed for projecting an image size from 1.00m (3.2ft) to 6.00m (20ft) with a aspect ratio of 4 to 3.



## Installation Guidelines

---

### \* Where to Install the Projector?

#### Definitions of the Abbreviation on drawings

B = Distance between ceiling and top of the screen or between floor and bottom of the screen.

A = Correction value, distance between bottom side of projector and middle of the lens. Value to be subtracted from B to obtain the correct installation position. (A value is a constant value for all screen widths and type of lenses. A = 200 mm or 7.874")

CD = Total distance between projector and ceiling or projector and floor.

SW = Screen width.

SH = Screen height (image height).

PD = Projector Distance, distance between screen and projector.

#### Inputs and computer video format input compatibility :

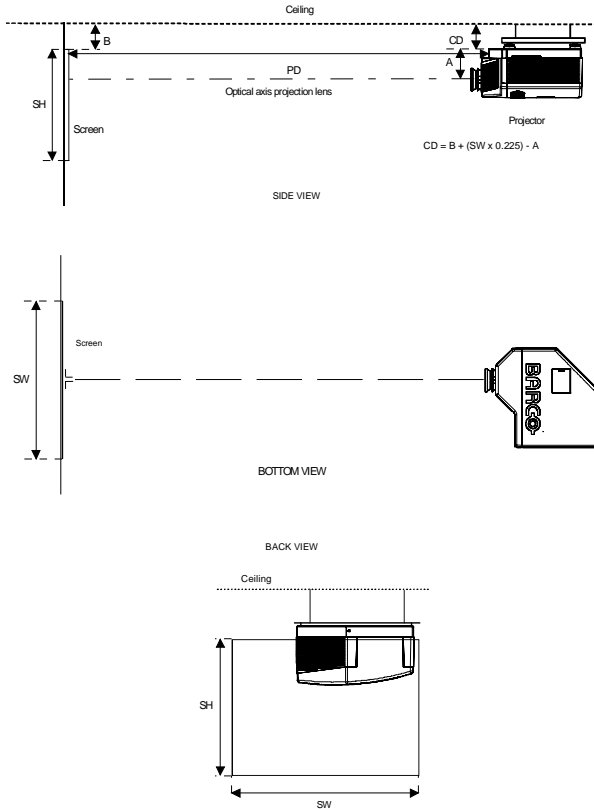
VIDEO and S-VIDEO

RGB ANALOG with STANDARD SYNC (SYNC ON GREEN or SEPARATE SYNC)

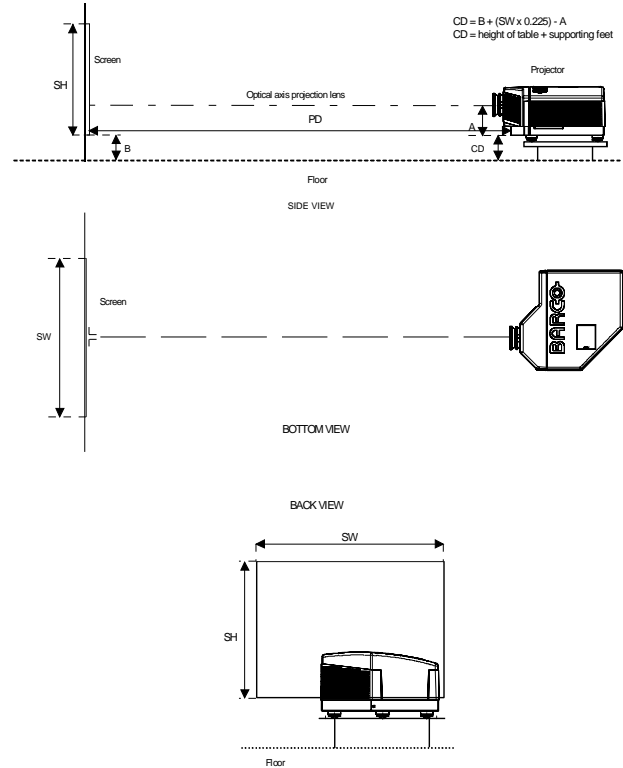
RGB ANALOG with TRI-LEVEL SYNC (SYNC ON GREEN or SEPARATE SYNC)

All computer sources with resolutions up to 1024 x 768 pixels

**Ceiling mounting of the BARCODATA 2100**  
(70% off-axis projection)

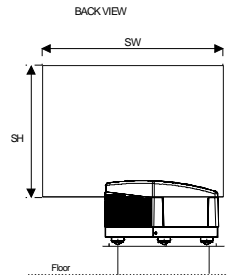
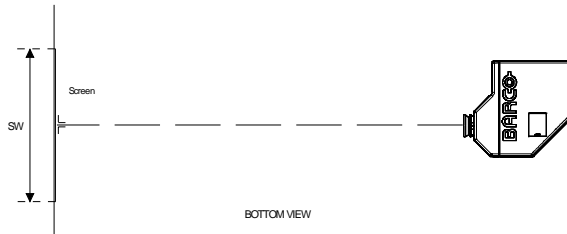
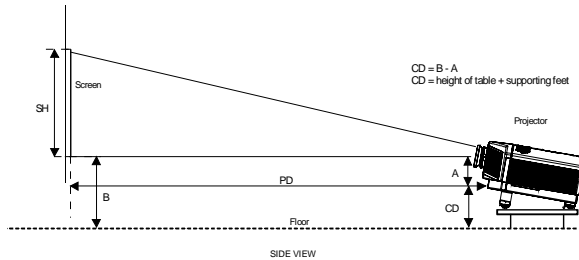


**Table mounting of the BARCODATA 2100**  
(70% off-axis projection)



## Installation Guidelines

### Table mounting of the BARCODATA 2100 (100% off-axis projection)



To install the projector 100 % off-axis, consult a qualified serv-

ice technician.

### \* How to Install a Projection Lens?

The BARCODATA 2100 is supplied without any lens.  
The following lens is available :

- SD(1.2:1) - Video
- SD(1.2:1)
- SD(1.7:1)

How to install the lens on the BARCODATA 2100?

Remove the foam rubber in the opening of the lens holder.

- Take the new lens out of its shipping carton and remove the lens covers.
- Turn the lens into the lens holder by turning clockwise.
- Focus the lens (see appendix C) and secure the correct position with the fastener ring by turning this ring clockwise.

### \* How to Install the Projector?

Ceiling mount or table mount?

To install the BARCODATA 2100, it is recommended that the BARCO mounting kits which are specially designed for this function be used at all times.

BARCO ceiling support CM50.

CM50 with pulley system, Order number : R9827990.

CM50 without pulley system, Order number : R9827991.

**Note : The CM50 in combination with the adapter plate can only be used for 70 % OFF-AXIS projection.**

Always use the BARCO ceiling support to attach your BARCODATA 2100 to the ceiling.

The installation instruction for this support is enclosed in the packet of the set.

Note : A ceiling mount adapter plate is needed to mount the projector to the ceiling mount support. BARCO order number : R9829450.

When using the adapter plate and the CM50 to mount the BD2100 to the ceiling, only 70% off-axis projection is possible.

*BARCO projection table.*

BARCO's projection table provides adjustable height and offers a stable surface for the projector  
Order number R9827740.

## **INSTALLATION SET UP**

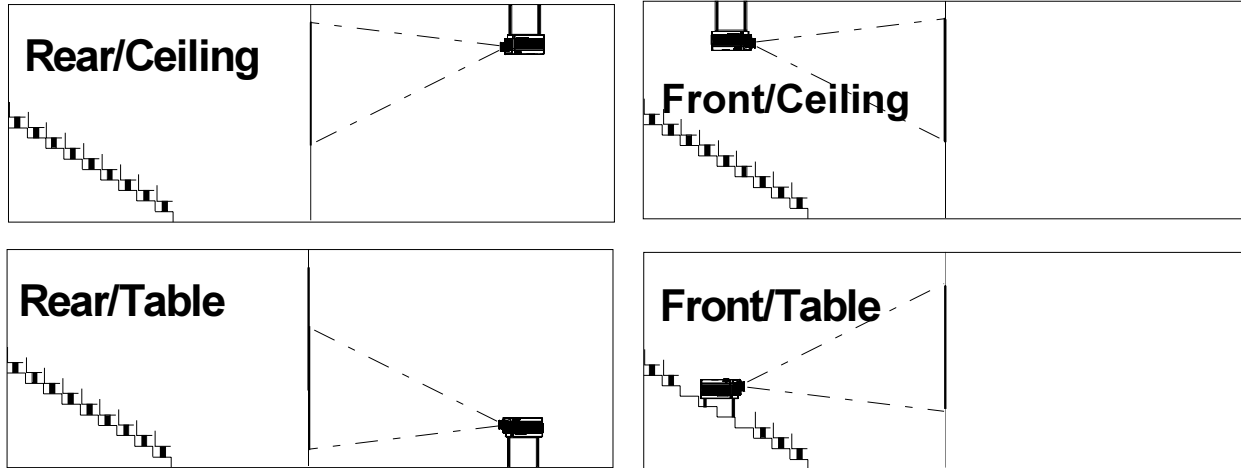
### **Projector Configuration**



## Installation Set Up

---

The BARCODATA 2100 can be installed to project images in four different configurations : front/table, front/ceiling, rear/table and rear/ceiling.



To change the Configuration, enter the adjustment mode by pushing **ADJUST** or **ENTER**. Highlight Installation by pushing the control disk up or down and press **ENTER** to select. The installation menu will be displayed.

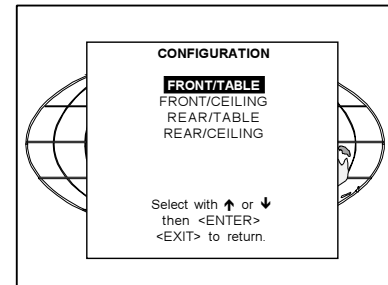
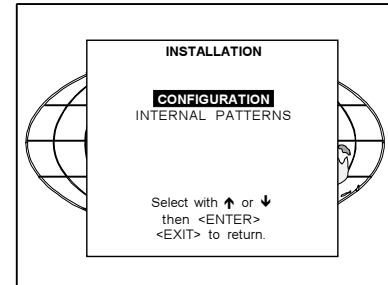
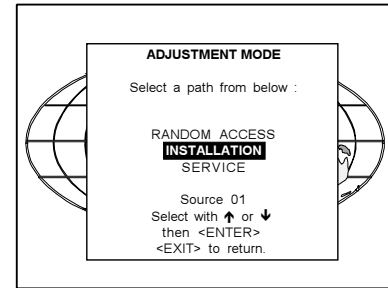
**ENTER** displays the Installation menu.  
**EXIT** returns to operational mode.

Highlight Configuration by pushing the control disk up or down and press **ENTER** to select. The configuration menu will be displayed.

**ENTER** displays the Configuration menu.  
**EXIT** returns to the path selection menu.  
**ADJUST** returns to operational mode.

The actual selected configuration will be highlighted.  
Push the control disk up or down to select the corresponding configuration with regard to the projector environment. Press **ENTER** to confirm your selection.

**ENTER** to confirm the selection.  
**EXIT** returns to the installation menu.  
**ADJUST** returns to operational mode.



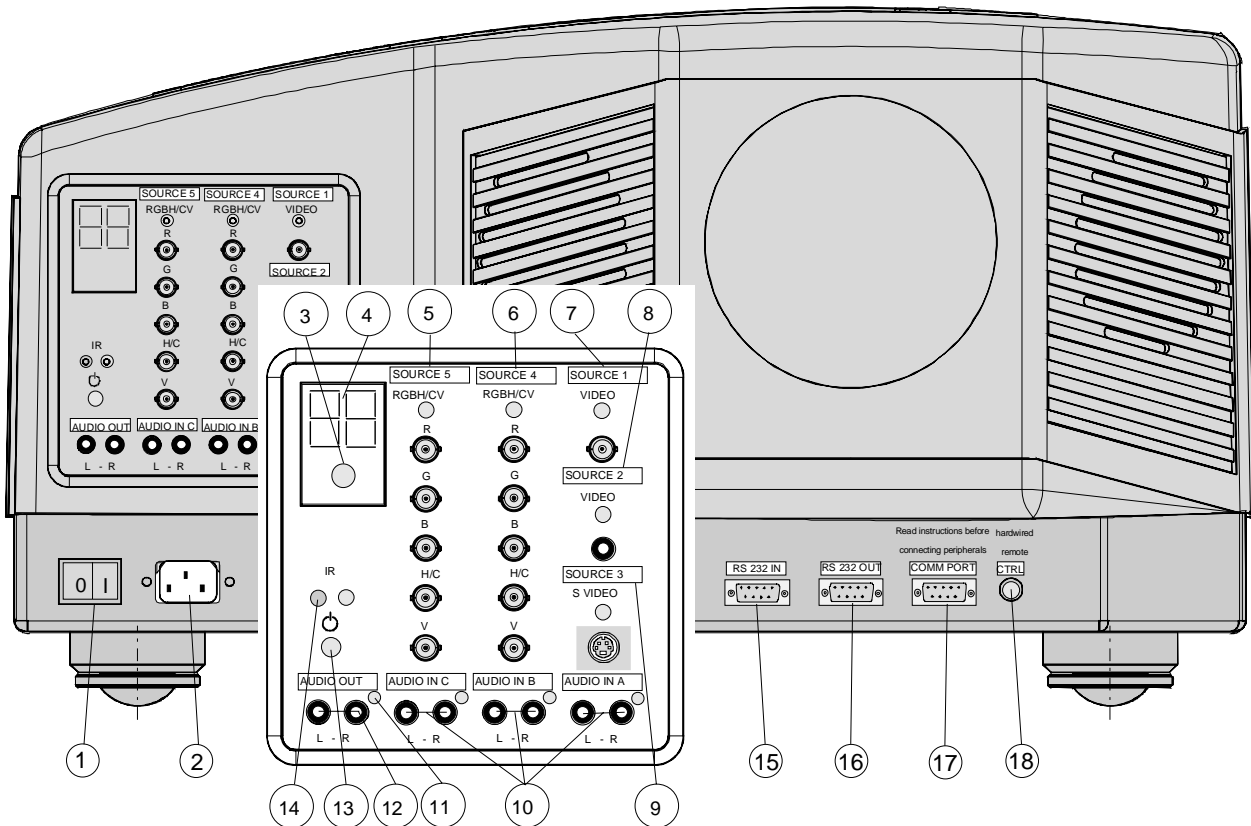
## **LOCATION AND FUNCTION OF CONTROLS**

**Front Panel Terminology**

**Local Keypad**

**Remote Control**

## Front Panel Terminology



- 1** **Power switch** : '1' = on, '0' = off
- 2** **Power input** : switchable between 120 VAC and 230 VAC
- 3** **IR receiver** : receiver for control signals transmitted from the RCU.
- 4** **Diagnostics code** : a) source number  
b) error code : a two digit error code is displayed when something goes wrong inside the projector.
- 5** **Source 5 : RGB H/C V input** : RGB analog input with standard sync on 5 BNC connectors. The sync can be sync on green, composite sync, separate sync (H & V) or 3 level sync.
- 6** **Source 4 : RGB H/C V input** : RGB analog input with standard sync on 5 BNC connectors. The sync can be sync on green, composite sync or separate sync (H & V)
- 7** **Source 1 : Video input** (composite video) on BNC connector. Allows a video tape recorder, video camera, color receiver/monitor, etc. having a video line output to be connected to the projector.
- 8** **Source 2 : Video input** on Cinch (RCA) connector. Allows a video tape recorder, video camera, color receiver/monitor, etc. having a video line output to be connected to the projector.
- 9** **Source 3 : S-Video** on 4-pin mini-DIN connector. Separate Y/C (luma-chroma) signal inputs for higher quality playback of Super VHS signals.
- 10** **AUDIO IN** : 3 audio inputs on 2 Cinch (RCA) connectors for audio (L-R).
- 11** **MUTE LED** : lit up when mute key is pressed.
- 12** **AUDIO OUT** : 2 x Cinch (RCA) stereo audio output.
- 13** **Projector mode indication** : indicates the status of the projector.  
  
no light : power switch is not pressed.  
red light : power switch is pressed, projector in stand by mode.  
green light : projector in operational mode.
- 14** **IR-Acknowledged** : (green LED) IR signals are recognized.  
**IR-Received** : (red LED) IR signals are received without knowing for which projector.
- 15** **RS232 IN** : to allow communication with external computer, e.g. IBM PC or compatible, Macintosh ...
- 16** **RS232 OUT** : used to connect to next projector, RS232IN plug (communication link for PC or MAC to the next projector).
- 17** **Communication port** : allows communication with the 800 peripherals.
- 18** **CTRL** : remote input for wired remote control.

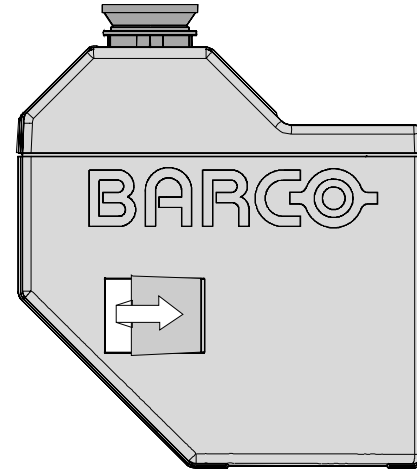
## **Control Panel Terminology**

### *a. Local Keypad*

Getting access

The keypad is located behind a door, screened with the name of the projector.

To open the door, push once on the indicated side of the door and turn it to the right side of the projector.



### *b. Remote Control*

This remote control includes a battery powered infrared (IR) transmitter that allows the user to control the projector remotely.

This remote control is used for source selection, control, adaptation and set up. It includes automatic storing of :

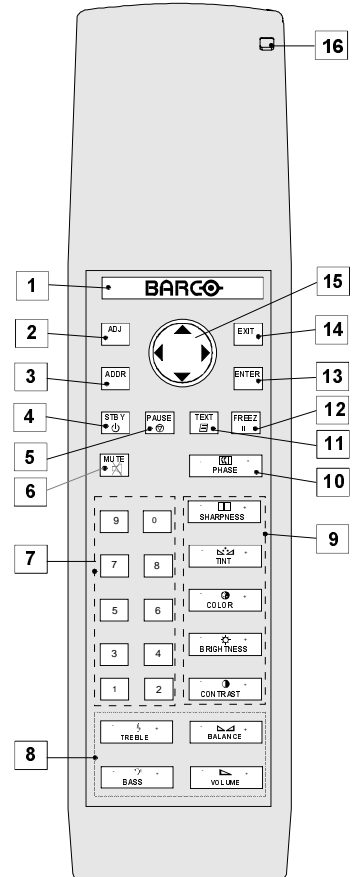
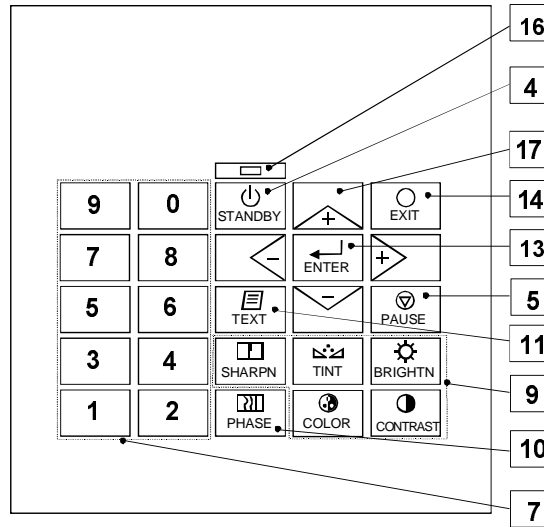
- picture controls (Brightness, Sharpness...)
- settings

Other functions of the remote control are :

- switching between standby and operational mode.
- switching to "pause" (blanked picture, full power for immediate restarting)
- direct access to all connected sources.
- variable adjustment speed : when pushing continuously on the arrow keys or the picture keys, the adjustment will be executed in an accelerated fashion.

Remote Control (RCU)

Local keypad



## Location and Functions of Control

---

### Terminology

1

**Back light key** : when activated, all keys will lit up and visible in the dark.

2

**ADJ.** : ADJUST key, to enter the adjustment mode or for quick exit in the adjustment mode.

3

**Address key (sunk key)**, to enter the address of the projector (between 0 and 9). Press the recessed address key with a pencil, followed by pressing one digit button between 0 and 9.

4

**STBY** : stand by button - to start projection when the power switch is switched on.  
- to switch off the projector without switching off the power switch.

5

**PAUSE** : to stop projection for a short time, press 'PAUSE'. The image disappears but full power is retained for immediate restarting.

6

**MUTE** : to interrupt the sound reproduction.

7

**Digit buttons** : direct input selection.

8

**Sound controls** : use these buttons to obtain the desired sound reproduction (see also 'Controlling').

9

**Picture controls** : use these buttons to obtain the desired picture analog level (see also 'Controlling').

10

**PHASE** : used to remove instability of the image.

11

**TEXT** : when adjusting one of the image, e.g. controls during a meeting, the displayed bar scale can be removed by pressing 'TEXT' key first. To re-display the bar scale on the screen, press 'TEXT' key again. 'TEXT' key only active in operational mode.

12

**FREEZ** : press to freeze the projected image.

13

**ENTER** : to start up the adjustment mode or to confirm an adjustment or selection in the adjustment mode.

14

**EXIT** : to leave the adjustment mode or to scroll upwards when in the adjustment mode.

15

**Control Disk** : To make menu selections when in the adjustment mode. Also allows to increment or decrement an adjustment in the adjustment mode.  
Control Disk Up = up arrow in the menus  
Control Disk Down = down arrow in the menus  
Control Disk to the Right = arrow to the right on the menus  
Control Disk to the Left = arrow to the left on the menus

16

**RC operating indication** : lights up when a button on the remote control is pressed. (This is a visual indicator to check the operation of the remote control)



## **POWER CONNECTION**

## Power Connection

### Power (Mains) Cord Connection

Use the delivered power cord to connect your projector to the wall outlet. Plug the female power connector into the male connector at the front of the projector.

The power voltage for the projector is indicated on the identification plate on the rear of the projector.

The projector input voltage is internally switchable between 230 Vac and 120Vac. Consult a qualified service technician to adapt the input voltage to the correct voltage on the wall outlet.

This projector may be connected to an IT-power system.

### Fuses

#### Warning

For continued protection against fire hazard :

- replace with the same type of fuse.
- refer replacement to qualified service personnel

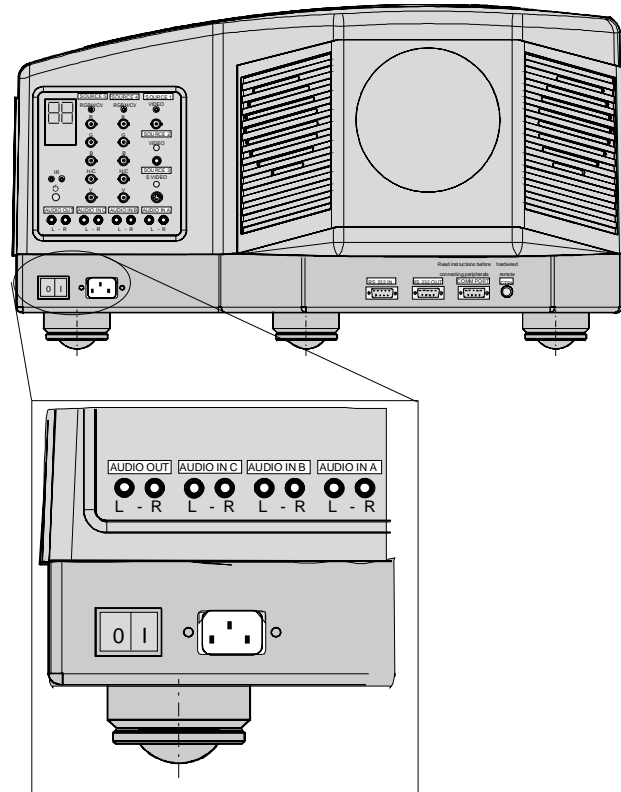
Fuse type : T16 AH/125V    Order no. : B370076

### Switching ON

Use the power switch to switch on.

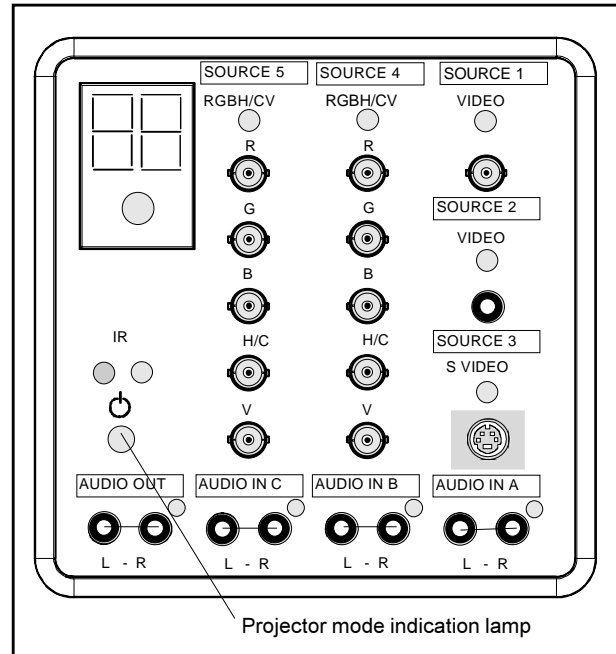
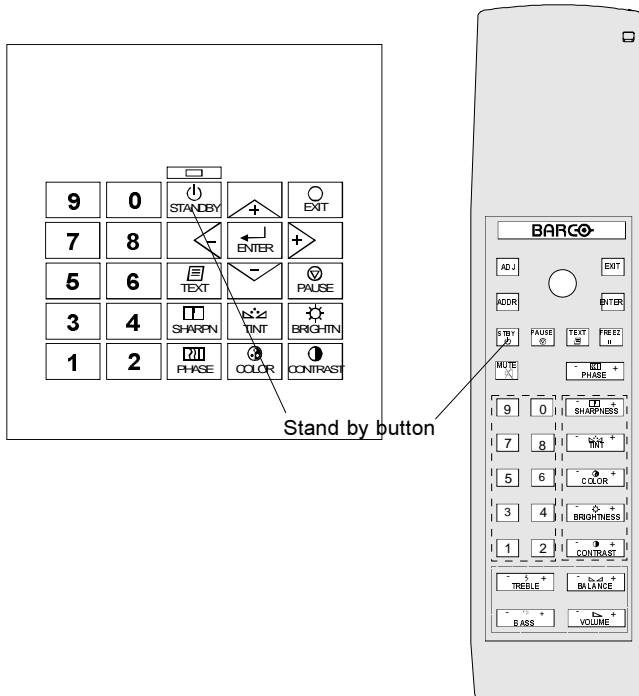
When '0' is visible, the projector is switched off.

When '1' is visible, the projector is switched on.



When switching on with the power switch, the projector starts in the stand by mode. The projector mode indication lamp is red.

To start image projection, press the 'Stand by' button on the local keypad or on the remote control. The projector mode indication lamp will be green.



## Lamp Lifetime

30 hours before end of lamp lifetime, the following message will scroll over the screen for 1 minute. This message will be repeated every 30 minutes. Press EXIT to remove the message before the minute is over.

When the end of the lamp lifetime is reached, the following message, with the exact run time is displayed on the screen.

*Lamp run time is 1000\* hours. Operating the lamp longer than 1000 \*hours may damage the projector. Please replace the lamp.*

When OK (ENTER) is pressed to go on, the warning will be repeated every 30 min.

\* The total lifetime of the lamp for a safe operation is depending on the type of lamp and on the operating mode. The different values are shown in Table 1.

Do not use it longer. Replace always with a same type of lamp. Call a BARCO authorized service technician for lamp replacement.

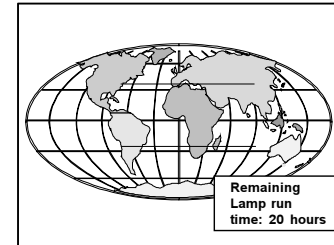
**Warning : Using a lamp for more than Lamp Lifetime is dangerous, the lamp could explode.**

**Note: Switching the projector OFF and ON again, adds 45 minutes to the lamp run time.**

### Switching to Stand-by.

When the projector is running and you want to go to stand-by, press the stand-by key.

**Caution :** Before powering down the projector, switch the projector to stand-by and let the projector lamp cool down until the fans stop blowing (or for at least 15 minutes).



Article Numbre	Dimming / Lamp Drive Mode	Lamp Lifetime
R9829510	Dimming	1000
R9829600	Economic Normal	3500 2000
R9829740	Dimming	4000

### Switching OFF

To switch off:

- press first **STANDBY** key and let cool down until the fans stop blowing ( or at least 15 min).
- switch off the projector with the power switch.

## **INPUT CONNECTIONS**

**Connecting a Video Source to the Video Input**

**Connecting a S- Video Source to the S- Video Input**

**Connecting a RGB Analog Source to the RGB Analog Input**

**Connecting a Component Video Source to the RGB Inputs.**

## **Peripheral Equipment Connection**

**Connecting a Computer**

**Connecting a RCVDS800 or RCVDS05**

**Connecting a VS05**

**Connecting an IR Remote Receiver 800**

### Signal Input Connection to the Projector.

The following sources can be connected to the projector :

- Composite Video
- S-Video
- RGBS or RGsB
- RGBHV
- RGB3S or RG3sB
- Component Video

Source input	Input type	Digit button on RCU	Audio input (lock is off)
source 1	Comp. Video	1	A
source 2	Comp. Video	2	B
source 3	S-Video	3	C
source 4	RGB (*)	4	B
source 5	RGB (*)	5	C
source 4	RGB3S (**)	6	B
source 5	RGB3S (**)	7	C
source 4	RGB[CV] (***)	8	B
source 5	RGB[CV] (***)	9	C

(\*) RGB with separate sync (composite or hor. or vert. sync) or with sync signals on green.

(\*\*) RGB with Tri-level sync

(\*\*\*) RGB with composite video as sync signal.

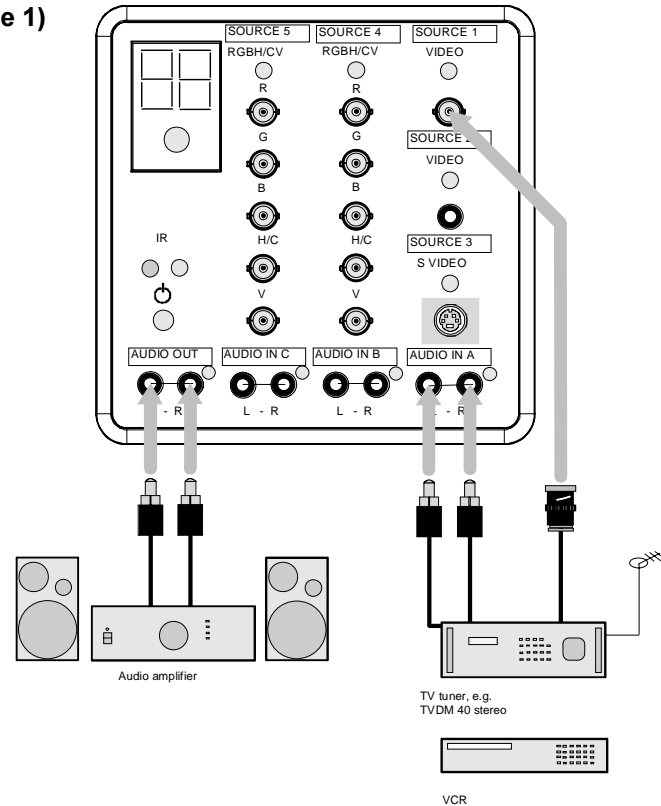
## Connecting a Video Source to the BNC Input (source 1)

Coposite video signals from a VCR, OFF air signal decoder, etc. ...  
 1 x BNC 1.0Vpp ± 3 dB

Connect the audio input signals to the AUDIO A input when the audio lock is OFF (see also chapter "Controlling")

### Video Input Selection :

Press digit button 1 on the RCU.



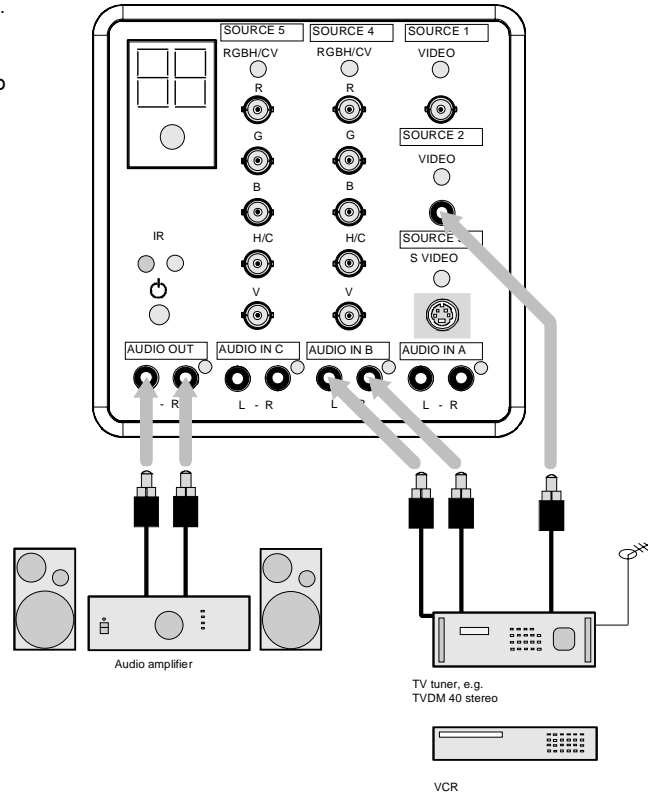
## Connecting a Video source to the Cinch (RCA) input (source 2)

Coposite video signals from a VCR, OFF air signal decoder, etc. ...  
1 x Cinch (RCA) 1.0Vpp ± 3 dB

Connect the audio input signals to the AUDIO A input when the audio lock is OFF (see also chapter "Controlling")

### Video Input Selection :

Press digit button 2 on the RCU.





## Connecting a S-Video Source to the 4-pin mini DIN Input (source 3)

Separate Y-luma/C-chroma signals for higher quality playback of Super VHS signals..

1 x 4 pins plug

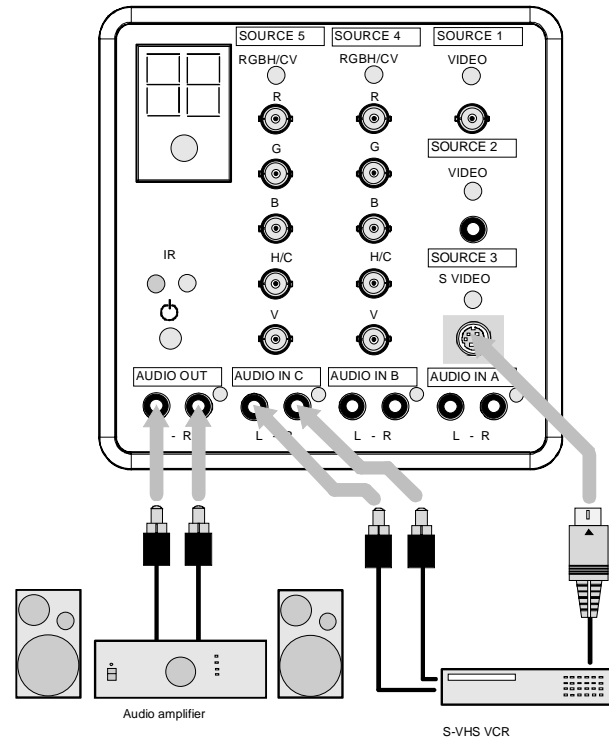
pin configuration :

- 1 ground luminance
- 2 ground chrominance
- 3 luminance  $1.0 \text{ Vpp} \pm 3 \text{ dB}$
- 4 chrominance  $282 \text{ mVpp} \pm 3 \text{ dB}$

Connect the audio input signals to the AUDIO A input when the audio lock is OFF (see also chapter "Controlling")

### S-Video Input Selection :

Press digit button 3 on the RCU.



## Connections

### Connecting a RGB Analog Source to Source 4 or 5

RGB analog input terminals with automatic sync detection. Sync can be separate Horizontal and Vertical sync (RGB-HV), Composite sync (RGB-S) or Sync signals on green (RGsB).

Always use an interface when a computer and local monitor have to be connected to the projector. Recommended interfaces to be applied:

Universal analog interface.

Order number : R9826100.

RGB 120 MHz analog interface.

Order number : R9826570.

VGA interface

Order number 120V : R9828079.

Order number 230V : R9828070

MAC interface

Order number 120V : R9828059

Order number 230V : R9828050

MAGIK interface

Order number 120V : R9828129

Order number 230V : R9828120

RGBS/RGsB analog : 5 x BNC

Red : 0.7 Vpp  $\pm$  3 dB

Blue : 0.7 Vpp  $\pm$  3 dB

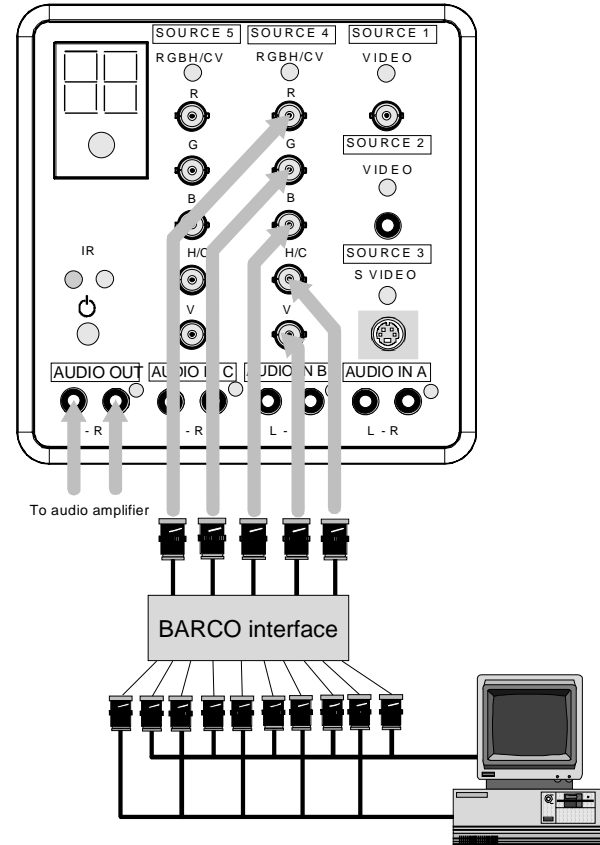
Green : 0.7 Vpp  $\pm$  3 dB

1 Vpp  $\pm$  3 dB if sync on green

Vert. sync : 1 Vpp to 4 Vpp  $\pm$  3 dB

Hor. sync / Composite sync : 1 Vpp to 4 Vpp  $\pm$  3 dB

All inputs are non-floating inputs.



All input signals can be 75 ohm terminated via soft switches (see also Service mode).

Connect the possible audio input signals for source 4 to the AUDIO B input when the audio lock is OFF and for source 5 to the AUDIO C input when the audio lock is OFF (see also chapter "Controlling")

**RGB Input Selection :**

For source 4, press digit button 4 on the RCU.

For source 5, press digit button 5 on the RCU.

If the sync input is a composite video signal, select the inputs as follows :

For source 4, press digit button 8 on the RCU.

For source 5, press digit button 9 on the RCU.

## Connections

### Connecting a RGB3S Analog Source to Source 4 or 5.

Connect your RGB signals with Tri-level sync, e.g. a professional VCR to the RGB input terminals of source 4 or source 5.

RGB3S/RG3sB analog : 5 x BNC

Red :  $0.7 \text{ Vpp} \pm 3 \text{ dB}$

Blue :  $0.7 \text{ Vpp} \pm 3 \text{ dB}$

Green :  $0.7 \text{ Vpp} \pm 3 \text{ dB}$

1  $\text{Vpp} \pm 3 \text{ dB}$  if Tri-level sync on green

Vert. Tri-level sync : 1  $\text{Vpp}$  to 4  $\text{Vpp} \pm 3 \text{ dB}$

Hor. Tri-level sync / Composite Tri-level sync:

1  $\text{Vpp}$  to 4  $\text{Vpp} \pm 3 \text{ dB}$

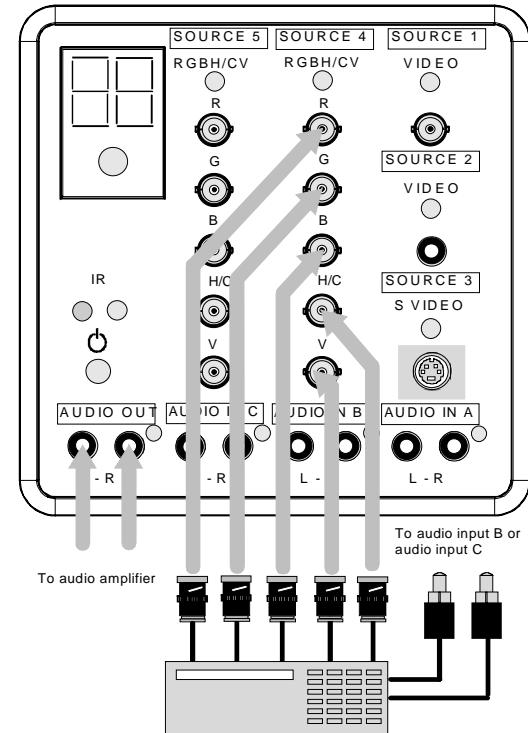
All input signals can be 75 ohm terminated via soft switches (see also Service mode).

Connect the possible audio input signals for source 4 to the AUDIO B input when the audio lock is OFF and for source 5 to the AUDIO C input when the audio lock is OFF (see also chapter "Controlling")

#### Input Selection :

For source 4, press digit button 6 on the RCU.

For source 5, press digit button 7 on the RCU.



## Connecting a Computer, e.g. IBM PC (or compatible), Apple Macintosh to the RS 232 Input of the Projector.

The BARCODATA 2100 projector has a RS232 port that allows it to communicate with a computer.

Applications : remote control and data communications.

a) remote control :

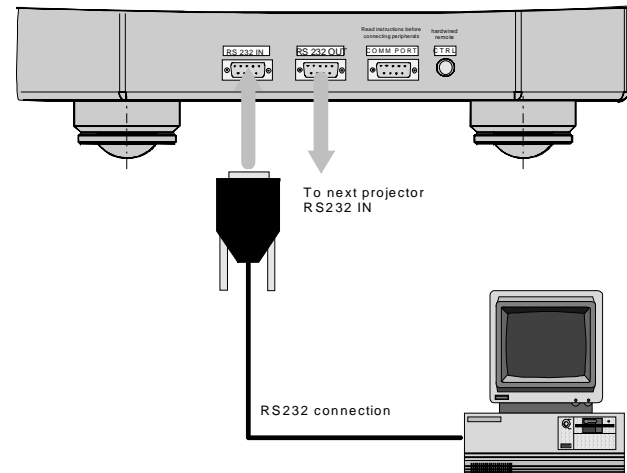
- easy adjustment of projector via IBM PC (or compatible) or MAC connection.
- allow storage of multiple projector configurations and set ups.
- wide range of control possibilities.
- address range from 0 to 255.

b) data communications :

- sending data to the projector or copying the data from the projector to a hard memory device.

## Set Up of the Baud Rate for Communication with a Computer.

See '*Change Baudrate PC*' in chapter '*Service mode*'.



## Connections

### Connecting a RCVDS 800 or RCVDS 05 to the BARCODATA 2100.

- Up to 10 inputs with one RCVDS800 or 20 inputs with the RCVDS 05 and 90 inputs when RCVDS's are linked via the expansion module.
- Serial communication with the projector.
- Remote control buttons on the RCVDS to control the BARCODATA 2100 (source selection and analog settings).
- The selected source number will be displayed on a 2 digit display and the selected input module will be indicated with a LED on the rear.

For more information about the use of :  
the RCVDS 800, consult the owner's manual, order number : R5975004.  
the RCVDS 05, consult the owner's manual, order number : R5975765.

### Connecting a VS05 to the BARCODATA 2100.

The VS05 can switch up to 5 Composite Video sources, 3 Super Video sources and 1 RGB analog or component video source to the BARCODATA 2100. In addition, the audio signal proper to the source, can be switched to an audio amplifier.

Order number : R9827890

For more information about the use of the VS05, consult the VS05 owner's manual, BARCO order number : R5975245.

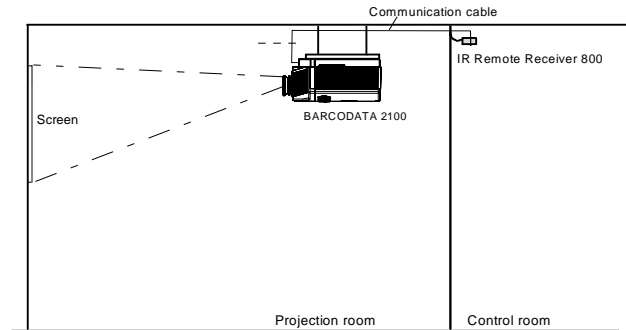
### Connecting an IR Remote Receiver 800 to the BARCODATA 2100.

This infrared red receiver unit makes it possible to control the BARCODATA 2100 from another room.

There is a communication line cable between the IR receiver and the projector or the RCVDS. The control information from the RCU can now be sent to the IR Remote Receiver 800.

The IR Remote Receiver 800 displays the selected source on a 7-segment display.

Order number : R9827515.



## **CONTROLLING**

**How to Use the RCU**

**Projector Address**

**How to Display a Projector Address**

**How to Program an Address into the RCU**

**Picture Controls with Direct Access**

**Sound Controls with Direct Access**

**The Pause Key**

**The Mute Key**

## Controlling

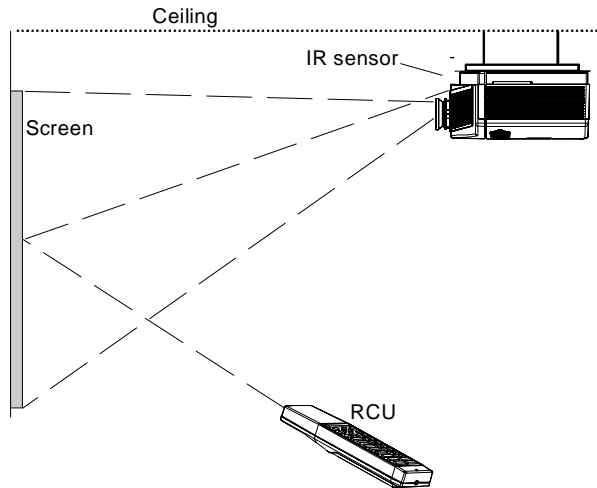
The BARCODATA 2100 can be controlled with

- a. the RCU
- b. the hardwired RCU (cable is not included)
- c. the local keypad.

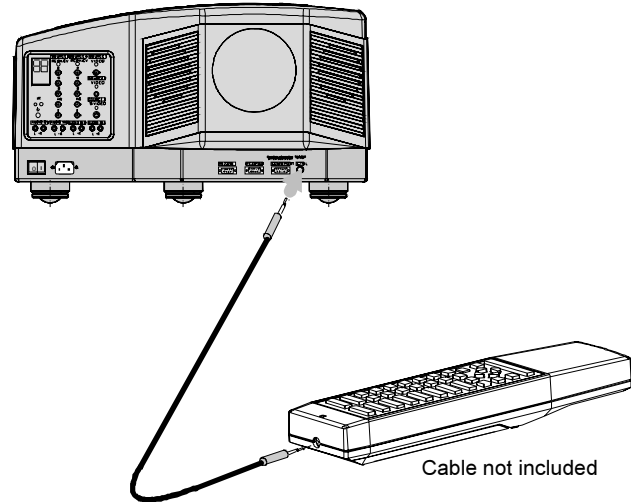
Controlling the projector with the RCU and the hardwired RCU is equal.

### How to Use the RCU?

- a) Point the front of the RCU to the reflective screen surface.



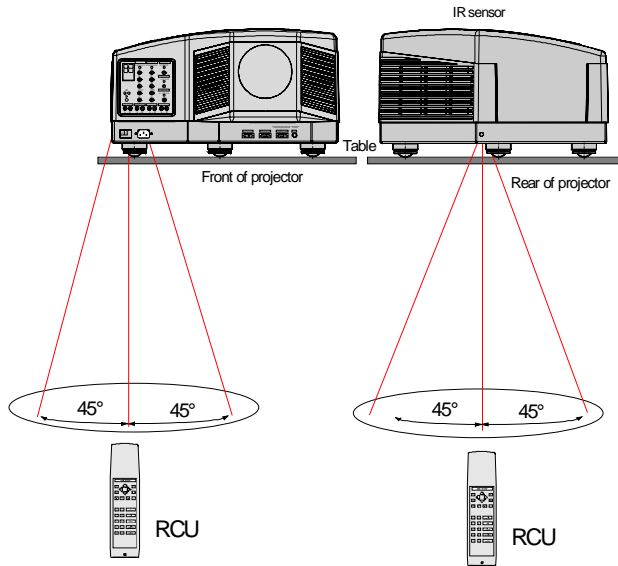
- b) RCU used in a hardwired configuration.



Plug one end of the remote cable in the connector on the bottom of the RCU and the second side in the connector in the front panel of the BARCODATA 2100 labelled 'CTRL'.



c) Point the front of the RCU directly at one of the IR sensors of the projector.



When using the wireless remote control, make sure you are within the effective operating distance (30m (100ft) in a straight line). The remote control unit will not function properly if strong light strikes the sensor window or if there are obstacles between the remote control unit and the projector IR sensor.

## Projector Address

### a. Software Set Up of the Projector Address.

See 'Change projector address' in chapter 'Service mode'.

Every projector requires an individual address between 0 and 255 which can be set in the Service mode.

Only projectors with addresses between 0 and 9 can be controlled with the RCU.

### b. How to Control the Projector or Projectors.

The projector's address may be set to any value between 0 and 255. When the address is set, the projector can be controlled now :

- RCU for addresses between 0 and 9.
- computer, e.g. IBM PC (or compatible), Apple MAC, etc. for addresses between 0 and 255.

Note : a projector will respond to a RCU set to an address of '0' regardless of what address is set in the projector itself.

### c. Using the RCU.

Before using the RCU, it is necessary to enter the projector address into the RCU (only when that address is between 1 and 9). The projector with the corresponding address will listen to that specific RCU.

When address 0, 'zero address' is programmed into the RCU, every projector, without exception will listen to the commands given by this RCU.

### How to Display a Projector Address?

Press the **ADDRESS** key (recessed key on the RCU) with a pencil. The projector's address will be displayed in a 'Text box'. This text box disappears after a few seconds. To continue using the RCU, it is necessary to enter the same address with the digit buttons (address between 0 and 9). For example : if the Address key displays projector address 003, then press "3" digit button on the RCU to set the RCU's address to match the projector's address.

### How to Program an Address into the RCU?

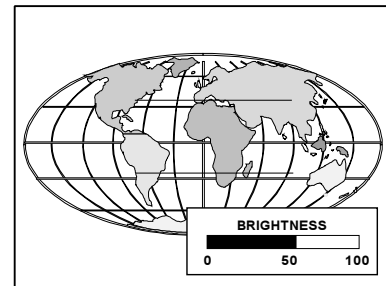
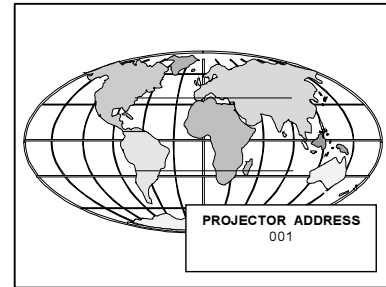
Press the **ADDRESS** key (recessed key on the RCU) with a pencil and enter the address with the digit buttons. That address can be any digit between 0 and 9. When programming '0', zero address, the RCU will control any projector regardless of the projector's address. This feature allows multiple projectors with different addresses to be controlled by a single RCU.

### Picture Controls with Direct Access.

When an image control is pressed, a text box with a bar scale, icon and function name of the control, e.g. 'brightness...' appears on the screen (only if text is ON). See example screen. The length of the bar scale and the value of the numeric indication indicate the current memorized setting for this source. The bar scale changes as the + or - buttons of the control on the RCU are pressed or the + or - buttons on the local keypad.

#### Brightness Control

A correct '*brightness*' setting is important for good image reproduction.  
Use the + button for a higher brightness.  
Use the - button for a lower brightness.



### Contrast Control

A correct 'contrast' setting is important for good image reproduction. Adjust the contrast to the level you prefer, according to room lighting conditions.

Use the + button for a higher contrast.  
Use the - button for lower contrast.

### Color Saturation

Color saturation is only active for Video and S-Video. Adjust the color intensity of the picture.

Use the + button for richer colors.  
Use the - button for lighter colors.

### Tint Control

Tint is only active for Video and S-Video when using the NTSC 4.43 or NTSC 3.58 system.

Use the + button  
Use the - button.

### Sound Controls with Direct Access.

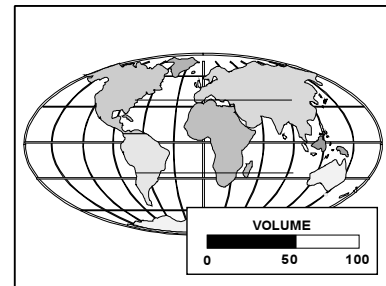
When a sound control is pressed, a text box with a bar scale, icon and function name of the control, e.g. 'volume...' appears on the screen (only if text is ON). See example screen. The length of the bar scale indicates the current memorized setting for this source. The bar scale changes as the + or - buttons of the control are pressed. The picture controls can only be adjusted with the RCU.

### Sharpness Control.

Use the + button for a sharper picture.  
Use the - button for a softer picture.

### Phase Control

Use the Phase key to adjust the phase. Within the total adjustment range there are 2 or 3 areas where the phase is correctly aligned.



## *Controlling*

---

### **Volume Control**

Volume control adjusts the volume.  
Use the + button for a higher volume.  
Use the - button for a lower volume.

### **Bass Control**

Bass control adjusts the bass level (low tones).  
Use the + button for more low tones.  
Use the - button for less low tones.

### **Treble Control**

Treble control adjusts the treble level (high tones).  
Use the + button for more high tones.  
Use the - button for less high tones.

### **Balance Control**

The balance control adjust the sound level between the left and the right box.  
Use the + button for a higher sound level on the right box than on the left one.  
Use the - button for a higher sound level on the left box than on the right one.

### **The Pause Key**

When the Pause key is pressed, the image projection is stopped but the projector remains with full power for immediate restart. The sound is not interrupted.

The display on front of the projector will show a 'P'.

To restart the image reproduction :

- press pause key,
- press exit key or
- select a source number.

### **The Mute Key**

When the Mute key is pressed, the sound reproduction is stopped. The image is still displayed.

To restart the sound reproduction, press the Mute key again.

## **START UP OF THE ADJUSTMENT MODE**

## Start Up of the Adjustment Mode

---

### Adjustment Mode

All source set ups, picture tunings and geometry are made while in the 'Adjustment mode'. Press the **ADJUST** or **ENTER** key to enter the 'Adjustment mode'.

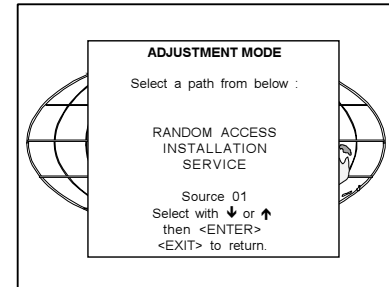
You are now in the 'Adjustment mode'. The control disk (RCU) or '+' or '-' keys (local keypad) are used to make menu selections and also for adjustments. The **ENTER** and **EXIT** keys are used to move forward and backward through the menu structure. The **ADJUST** key can be used to terminate the adjustment mode while any path selection menu is displayed.

There are 4 possible paths to follow once in the Adjustment mode. They are :

**Installation** - Installation should be selected when the projector is relocated in a new configuration.

**Random Access** - Random Access should be selected if the user is used to set up a source.

**Service** - Service should be selected if the user intends to change general settings such as password, language, address, etc. or some service actions as reset lamp run time, etc. or get set-up information.



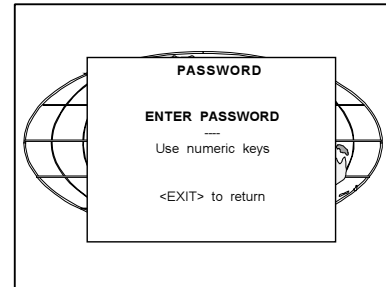
Some items in the Adjustment mode are password protected. While selecting such an item, the projector asks to enter your password (Password protection is only available when the password strap on the controller module is ON, see 'Change password' in chapter 'Service mode').

Your password contains 4 digits.

Enter the digits with the numeric keys.

Example : 2 3 1 9

The first digit position is highlighted. Enter with the numeric keys. The highlighted square jumps to the next position. Continue until all 4 digits are filled in.



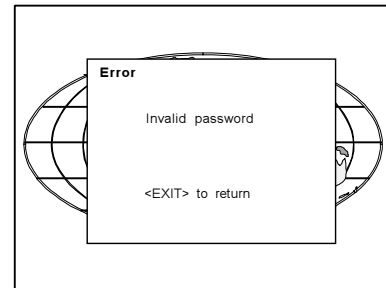
When your password is correct, you get access to the selected item.

When your password is wrong. The error message "Invalid password" is displayed on the screen. Press ENTER to continue and to return to the Service menu.

Factory programmed password : 0 0 0 0

Once the password is correctly entered, all other password protected items are accessible without re-entering your password.

When re-entering the Adjustment mode, it will be necessary to enter your password again when selecting a password protected item.



**RANDOM ACCESS ADJUSTMENT MODE**

**File Service**

**Picture Tuning**

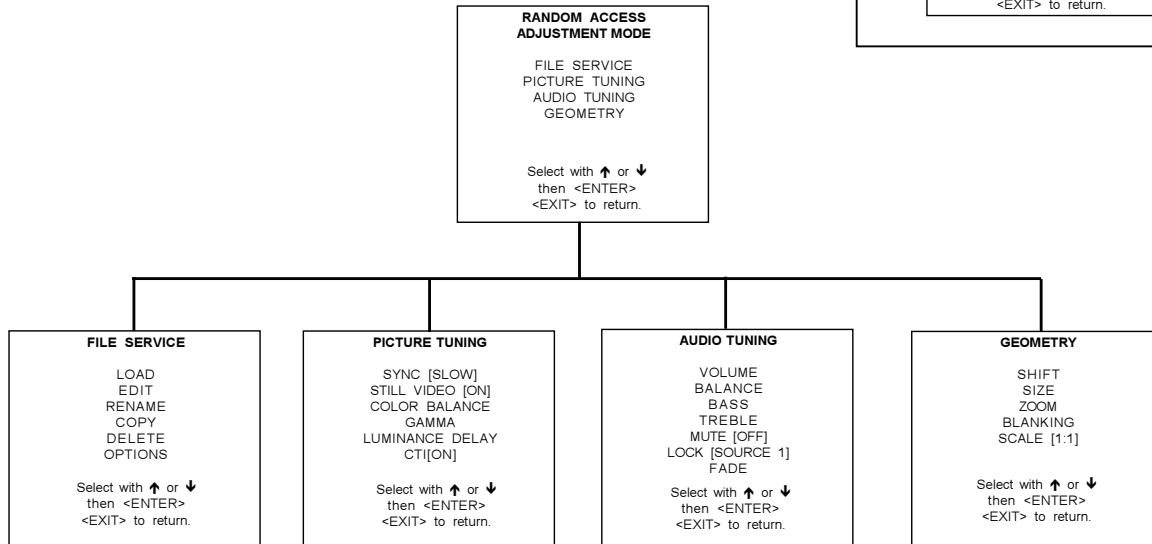
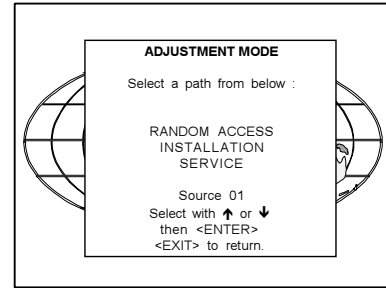
**Audio Tuning**

**Geometry**



## Starting Up the Random Access Adjustment Mode

Push the control disk up or down to highlight 'Random Access' and then press **ENTER**.



## File Service

Before using a new source, a correct file has to be installed. The projector's memory contains a list of files corresponding to the most used sources. When the new source corresponds with one of these files, the file can be loaded and saved for future use. When there is a little difference, the file can also be loaded and then edited until the source specs are reached.

File annotation :

xxxxxxxx.xxx x xxxxXxxxxi

i or blank : i = interlaced, blank = not interlaced

xxxxXxxxx : active pixel rating

x : source number

xxx : file extension, first character is C (for custom made files) or S (for standard files).

The second and third character is used for a following number (=file index)

file index for custom files : 00 to 63.

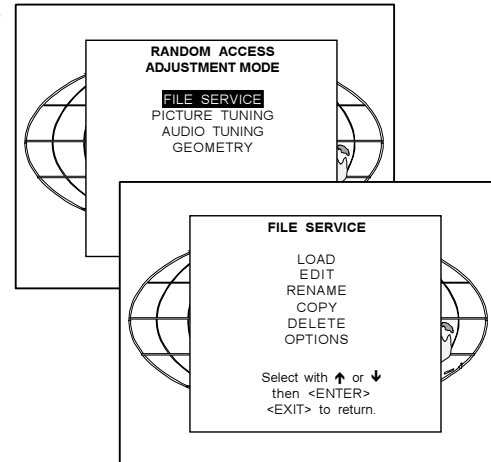
xxxxxxxx : base name, 8 characters.

Highlight *File Service* by pushing the control disk up or down and press **ENTER** to select. The File service menu will be displayed.

**ENTER** displays the File Service menu;  
**EXIT** returns to the Path selection menu.  
**ADJUST** returns to operational mode.

The following file manipulations are possible :

- Load : installation of a file for a new source.
- Edit : editing a loaded file to the source specs.
- Rename : renaming a file.
- Copy : copying a file to a new file.
- Delete : deleting an existing file.
- Options : way of displaying the file annotation and sort possibilities.



## Random Access Adjustment Mode

### Load File

Push the control disk up or down to select **LOAD** and press **ENTER** to display the Load menu.

The Load menu displays the corresponding files depending on the installed filter.

This filter can be "Fit" or "All". To change the filter, push the control disk to the right to select "filter list" (filter list will be highlighted) and press **ENTER** to toggle the annotation between brackets.

"All" : all files that can be loaded will be displayed.

"Fit" : only the best fitting files will be displayed (with a distinction of  $\pm 2$  lines and line duration distinction of  $\pm 300$  ns)

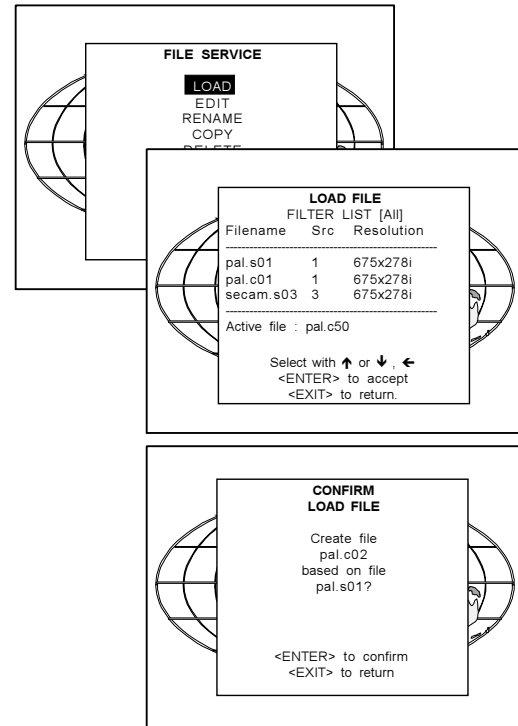
Push the control disk up or down to select the most fitting file and press **ENTER** to select.

When scrolling through the files, the image will be adapted according to the settings of the selected file (on line adaptation). When the best fitting image is displayed, press **ENTER** to select this file. A confirm Load file menu will be displayed with the new created file and the on which the new file is based on.

Press **ENTER** to confirm your new creations or **EXIT** to return to the load file menu.

If the displayed image is not yet as it has to be, select the most corresponding file and go to the Edit menu to change the file settings.

During a load file, the actual active file is displayed next to the indication 'Active file'.

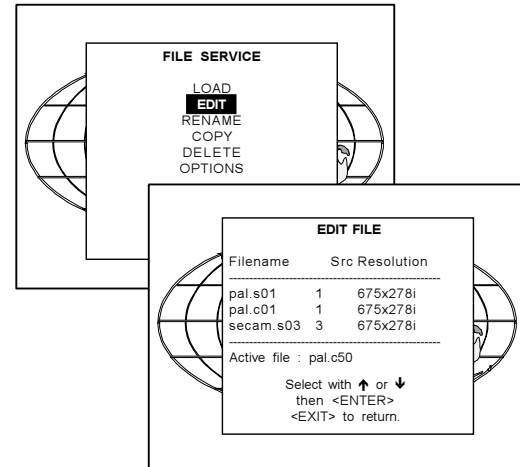


## Edit File

The Edit file menu makes it possible to change the settings of the file according to the real settings of the connected source. Consult the source specification before entering the data.

To start up the EDIT menu, push the control disk up or down to select EDIT in the FILE menu and press **ENTER**.

Select the file which must be edited (mostly the active file) and press **ENTER**.



The Edit file adaptation menu will be displayed.

The following items can be adjusted :

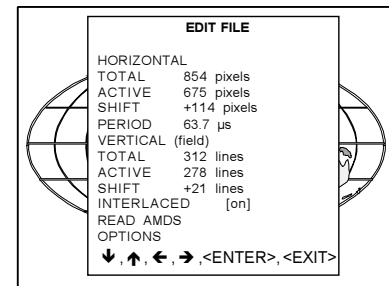
Total quantity horizontal pixels

Active quantity horizontal pixels

Horizontal shift in pixels

Horizontal period in  $\mu\text{s}$  (is automatically adapted during the installation of a file with LOAD)

Total vertical lines (is automatically adapted during the installation of



## *Random Access Adjustment Mode*

---

a file with LOAD)

Active vertical lines

Vertical shift in lines

Interlaced : toggle on/off (is automatically set to its correct position during the installation of a file with LOAD)

All settings can individually be changed. Push the control disk key up or down to select an item. The color of the selected item will change and follow one of the three methods to change the value.

- a. press **ENTER** to activate the digits and enter directly with the numeric keys on the RCU or local keypad the new value or
- b. press **ENTER** to activate the digits. Push the control disk key to the right or to the left to select the changing digit. Push the control disk key up or down to scroll to desired digit. When finished press **ENTER** to confirm.
- c. counting up or down by pushing the control disk key to the right or to the left.

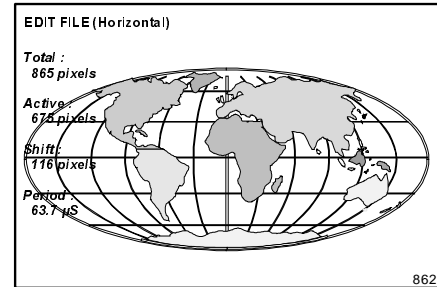
To have a better view during an adjustment of the 'active' file, select "*Horizontal*" or "*Vertical*" by pushing the control disk up or down and press **ENTER**.

A full image is displayed with the settings on the left side.

To change the values, highlight (color change) first the changing value by pushing the control disk up or down and continue by pushing the control disk to the left or to right to count up or down.

How to find the correct values for the displayed item?

During the installation of a file with LOAD, the horizontal period, the total number of vertical lines and the interlaced mode are automatically measured and filled in in the menu table. These values will be available when starting up the EDIT procedure of an active file. Select first "Horizontal" and press **ENTER** to display a full image.



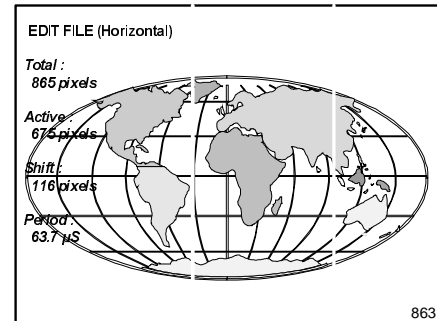
If the value for "Horizontal total pixels" is wrong, sampling mistakes (small vertical bars in the projected image) will be seen in the image. Select "Total" and adjust the pixel quantity. Adjust for zero bars (hint : if the number of bars increase, adjust in the other way).

The active pixels : determine the width of the window on the screen. This value is normally given in the source specifications. If not, adjust until full image is displayed (no missing pixels).

Horizontal shift : to shift the image on the screen.  
When changing the horizontal shift setting in the 'Edit' menu, the horizontal shift and horizontal size setting in 'geometry' are reseted.

Horizontal period : already filled in with the correct value when active file.

Press **EXIT** to return to the normal Edit file menu.



## Random Access Adjustment Mode

Select "*Vertical*" by pushing the control disk key up or down and press **ENTER**. The full image is displayed.

The "*Vertical Total lines*" are already filled when an active file is selected to be edited.

The "*Active lines*": number of horizontal lines determining the height of the projected image. This value is normally given in the specification of the source. If not, adjust until full image height is displayed (no missing lines)

*Vertical shift* : shift the image up and down (push control disk up or down) on the screen until the correct image position is obtained.

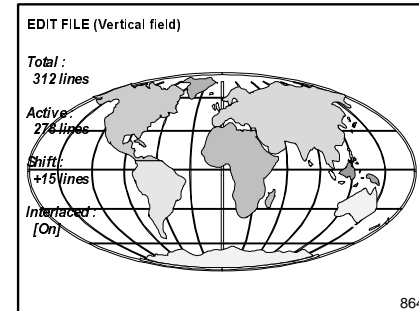
When changing the vertical shift setting in the 'Edit' menu, the vertical shift and vertical size settings in 'geometry' are reseted.

*Interlaced [On] or [Off]* : this selection is automatically filled when active file has to be edited. If the image is wrong due to mismeasurement, use the ENTER key to toggle between [On] and [Off]. (for interlaced images, 1 frame contains 2 fields).

### Read AMDS

AMDS = automatic mode detection & synchronisation  
During the installation of a file with LOAD, the system automatically measured the horizontal period, the total vertical lines and the interlaced mode.

When selecting Read AMDS, the system remeasures the above indicated items.



**Options**

Source number : The source number of a non-active source can be changed to any other source number. This makes it possible to create already a file for future source numbers.

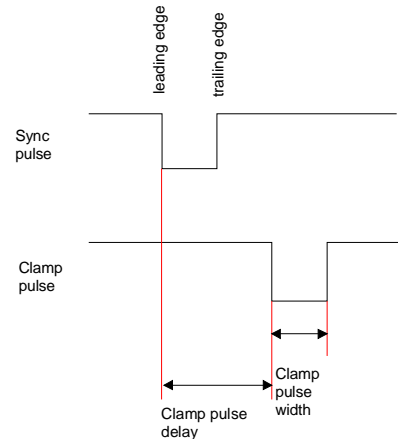
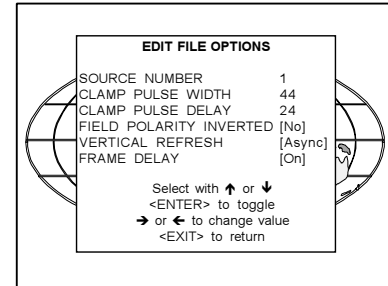
Clamp pulse width : The width of the clamp pulse  
 Can be any value between 10 and 100. Change the value by pushing the control disk to the left or to the right.

Clamp pulse delay : Clamping determines the black level of the signal. The clamp pulse can be related to the leading edge of the sync pulse. Can be any value between 2 and 512. Change the value by pushing the control disk to the left or to the right.

Field polarity inverted : Default [No]  
 This function is used for interlaced images. Both rasters of the image could be shifted in a wrong way (double lines are visible in the image). This can be corrected by inverting the field polarity to [Yes]  
 Use the **ENTER** key to toggle between [No] and [Yes].

Vertical refresh [sync/async] : The way of updating the image information on the LCD panels. For moving images, the vertical refresh has to be done on a synchronous way, for still images, asynchronous vertical refresh is possible.

Frame delay [On/Off] : default [On]  
 When [On] : there is a delay between input signal and displayed image of 1 frame.  
 When [Off] : minimum delay between input signal and displayed image. Only possible the 'Vertical refresh' is done synchronous and the projector is mounted in a ceiling mounted configuration (installation menu)  
 Press **EXIT** to leave the Edit File Option menu.





### Rename

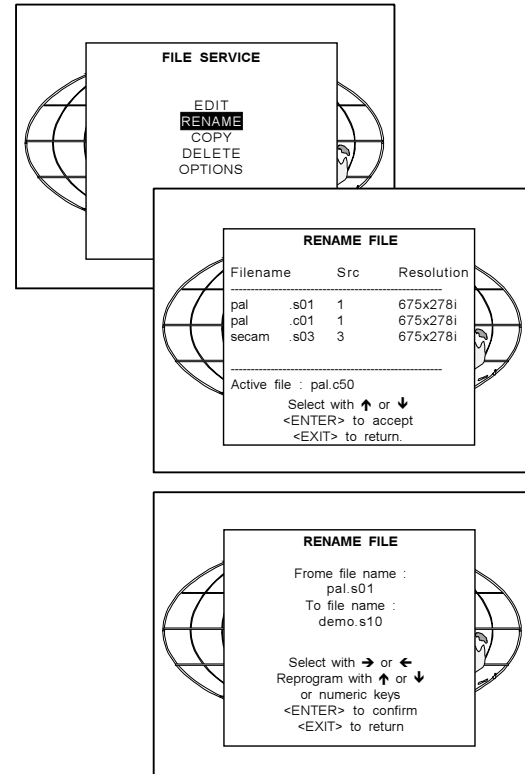
To change the name of a selected file.

Use the control disk to select **RENAME** and press **ENTER**. The Rename selection menu will be displayed.

Use the control disk to select a file name and press **ENTER** to select.

The Rename menu will be displayed with the selected file name already filled in in the 'From file name : ' area and in the 'To file name : ' area.

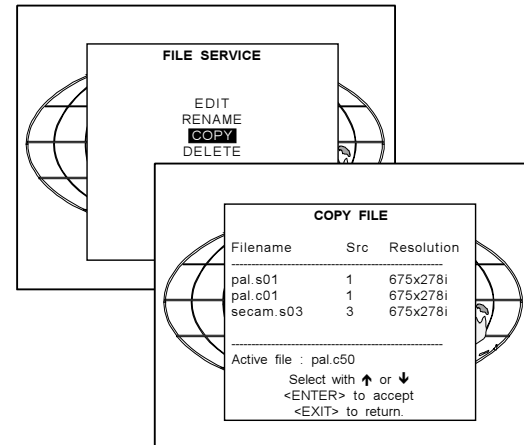
Press **ENTER** to select the separate characters. Push the control disk to the right or to the left to select the desired character. Change that characters by pushing the control disk up or down. Numeric characters can be entered directly with numeric keys on the RCU. Press **ENTER** to confirm. The renamed file is entered in the list of files. Press **EXIT** to return to the Rename menu selection. No changes are made.



## Copy

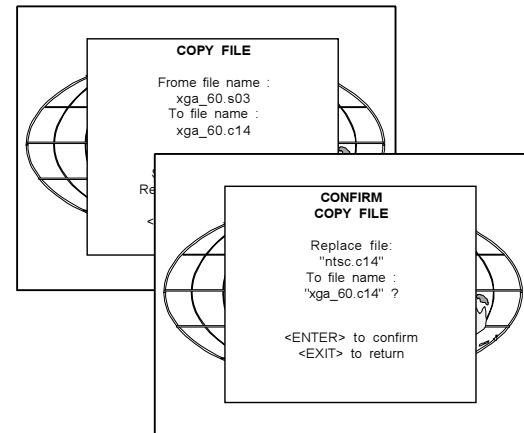
To copy a selected file into a new file.  
 Use the control disk to select COPY and press **ENTER**. The Copy selection menu will be displayed.  
 Use the control disk to select a file name and press **ENTER** to select.

The Copy menu will be displayed with the selected file name already filled in in the 'From file name : ' area and in the 'To file name : ' area.



Press **ENTER** to select the separate characters. Push the control disk to the right or to the left to select the desired character. Change that characters by pushing the control disk up or down. Numeric characters can be entered directly with numeric keys on the RCU. Press **ENTER** to confirm. The copied file is entered in the list of files. Press **EXIT** to return to the Copy selection menu. No copies are made.

If the file extension already exists, a confirmation menu will be displayed to ask the user to overwrite the existing file by the new file.



## Random Access Adjustment Mode

### Delete

To delete a selected file out of the list of files.

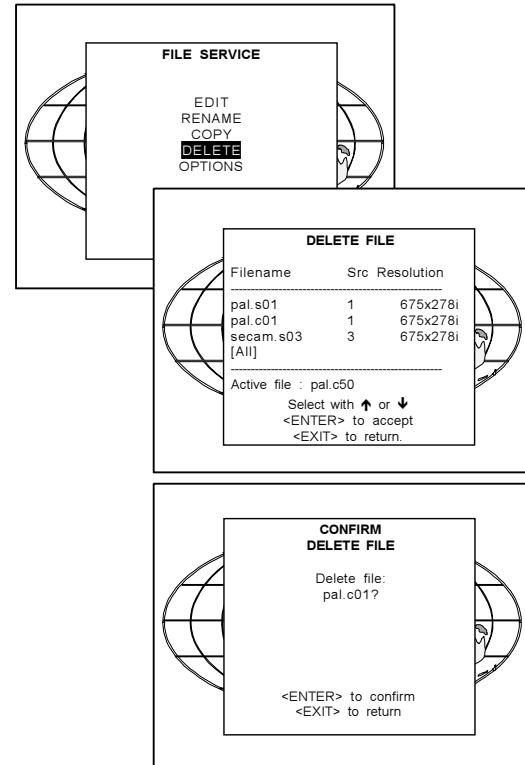
Use the control disk to select DELETE and press **ENTER**. The delete selection menu will be displayed.

Push the control disk up or down to select a file and press **ENTER**. If [All] is selected, your password has to be entered before all files will be deleted.

A confirmation menu "Delete file 'file name'?" is displayed. When you

want to delete the file, press **ENTER**. If you do not want to delete the file, press **EXIT**.

Note : the active file cannot be deleted.



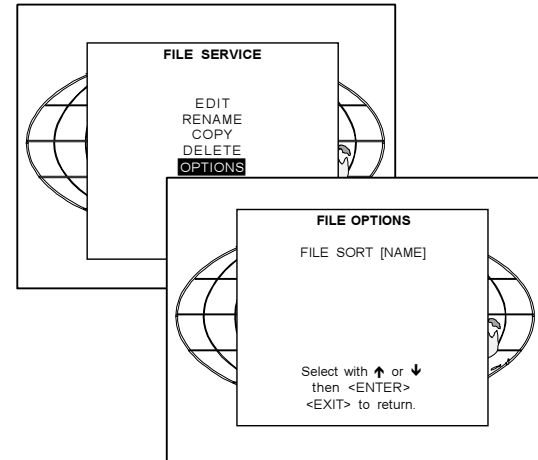
## File Options

Use the control disk to select **OPTIONS** and press **ENTER**. The option selection menu will be displayed.

Press **ENTER** to toggle between **[name]** and **[index]**

**[name]** : The files in the file list will be sorted on the file name.

**[index]** : The files in the file list will be sorted on the file extension.



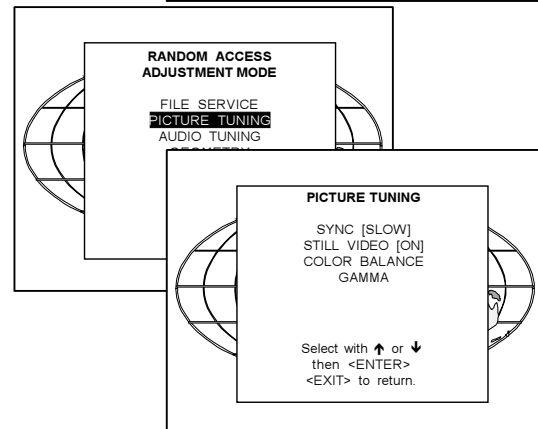
## Picture Tuning

Highlight Picture Tuning by pushing the control disk up or down and press **ENTER** to select.

The Picture Tuning menu will be displayed.

The next items are available :

- sync slow/fast
- still video
- color balance
- gamma



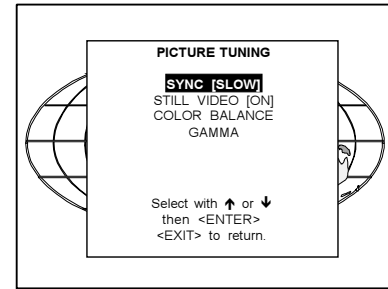
## Random Access Adjustment Mode

### Sync SLOW/FAST

Only active for sources 1, 2 and 3. When not source 1, 2 or 3, the following indication will be given on the menu : Sync (-).

Highlight Sync by pushing the control disk up or down and press **ENTER** to toggle between [SLOW] and [FAST].

The FAST position is used to compensate for unsteady sync pulses from older video playback equipment. This is the default position. For more stable sources it is preferable to use the SLOW position.



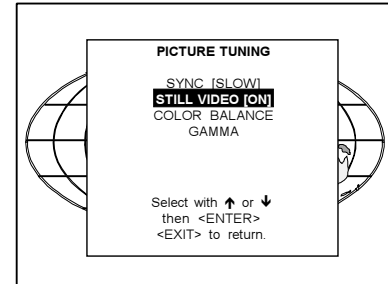
### Still Video

This function is only used for stationary interlaced images.

Highlight Still Video by pushing the control disk up or down and press **ENTER** to toggle between [ON] and [OFF].

Still Video : ON : the displayed image contains less jitter and gives a sharper image.

Still Video : OFF : for moving picture.



## Color Balance

Highlight Color Balance by pushing the control disk up or down and press **ENTER** to select the color balance selection menu.

The next choices are possible :

Fixed color balance :

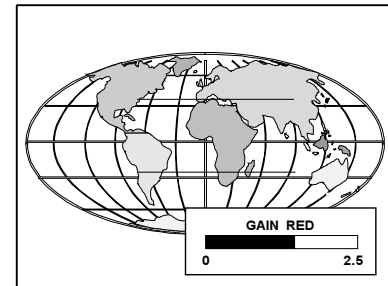
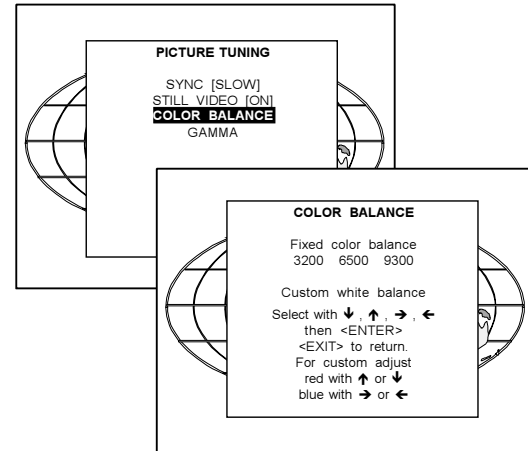
- 3200 K (reddish)
- 6500 K (white)
- 9300 K (bluish)

Custom white balance.

Push the control disk up or down to select Fixed Color Balance or Custom Color Balance.

If Fixed Color Balance is selected, use the control by pushing it to the right or to the left to select one of the 3 preprogrammed color temperatures.

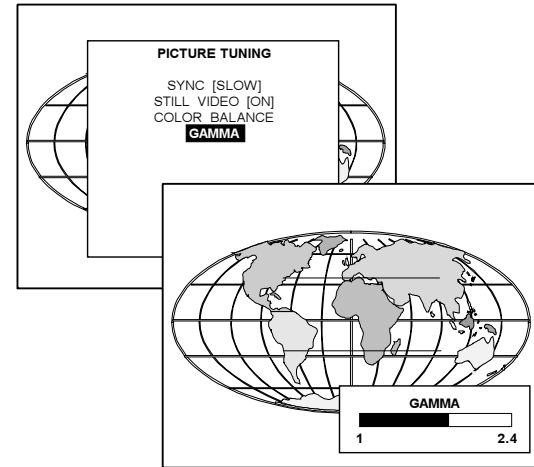
When Custom Color Balance is selected, push the control disk up or down to adjust red and push the control disk to the right or to the left to adjust blue (range 0 to 2.5) in comparison with the green color (value 1).



### Gamma

With the gamma correction adjustment, it is possible to bring the details in dark image parts more to the front (lower gamma values) or to reduce the importance of these details (higher gamma values).

To change the gamma value, highlight Gamma by pushing the control disk up or down and press ENTER.



## Audio Tuning

Highlight Audio Tuning by pushing the control disk up or down and press **ENTER** to select.

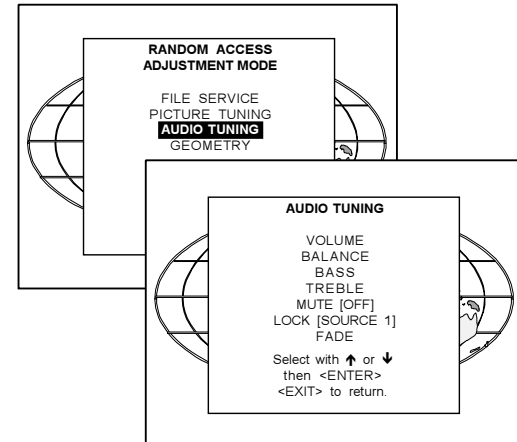
The Audio Tuning menu will be displayed.

The next items are available :

- volume
- balance
- bass
- treble
- mute
- lock
- fade

## Volume, Balance, Bass and Treble

When a sound control is selected by highlighting the item with the control disk, a text box with a bar scale, icon and function name of the control, e.g. 'Volume' appears on the screen (only when text is ON). The length of the bar scale indicates the current memorized setting for this source. For more information about the sound controls, see 'Sound controls with direct access' in Chapter 'Control-





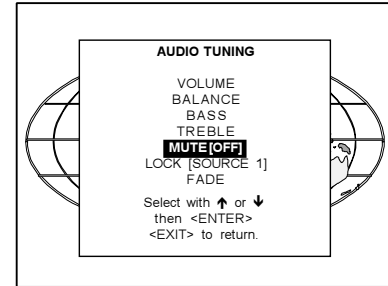
## Random Access Adjustment Mode

ling'.

### Mute

Select 'Mute' to stop the sound reproduction. The image is still displayed.

Highlight 'Mute' with the control disk and press ENTER to toggle



between Mute [on] or Mute [off].

### Lock [OFF/AUDIO A/AUDIO B/AUDIO C]

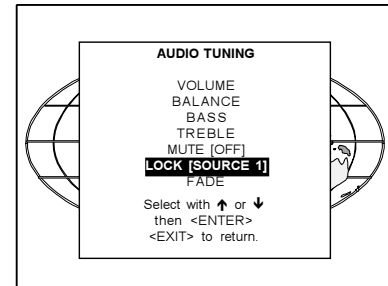
Select 'Lock' by pushing the control disk up or down and press ENTER to toggle between OFF, AUDIO A, AUDIO B, AUDIO C.

Lock [OFF] : the sound corresponding to the selected input source will be reproduced (see table in chapter 'Connections')

Lock [audio a] : the sound corresponding to audio a input will be reproduced independent the selected input source.

Lock [audio b] : the sound corresponding to audio b input will be reproduced independent the selected input source.

Lock [audio c] : the sound corresponding to audio c input will be reproduced independent the selected input source.



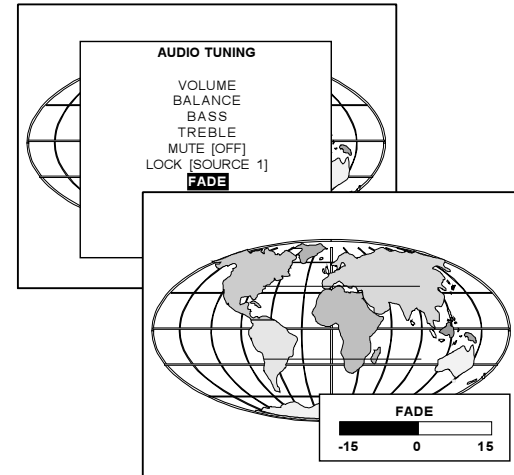
## Fade

Select Fade by pushing the control disk up or down.

The fade can be adjusted between -15 and 15.

Fade on -15 : no sound reproduction on the external loudspeakers, max on the internal loudspeaker with the same volume level as adjusted with the volume control.

Fade on 15 : no sound reproduction on the internal loudspeakers but max on the external loudspeakers with the same volume level as adjusted with the volume control.

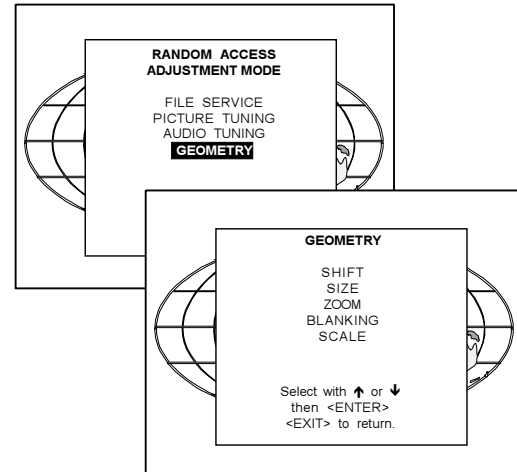


### Geometry

Highlight Geometry by pushing the control disk up or down and press **ENTER** to select the geometry selection menu.

The following adjustment are possible :

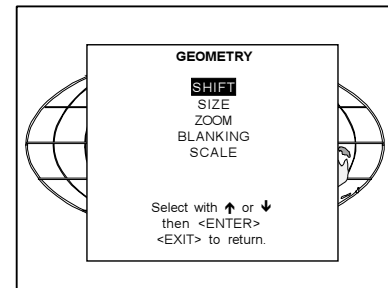
- horizontal and vertical image shift.
- horizontal and vertical image size
- zoom
- blanking
- scale [1:1]



### Shift

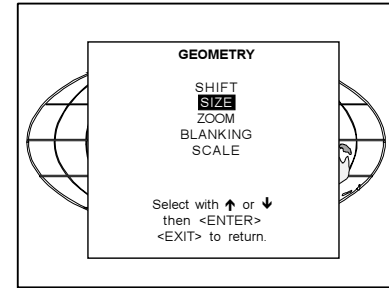
Highlight Shift by pushing the control disk up or down and press **ENTER**. A bar scale will be displayed.

The image can be shifted in a horizontal or vertical direction. Push the control disk up or down to shift the image in a vertical direction. Push the control disk to the right or to the left to shift the image in a horizontal direction.



## Size

Highlight Size by pushing the control disk up or down and press



**ENTER** to select.

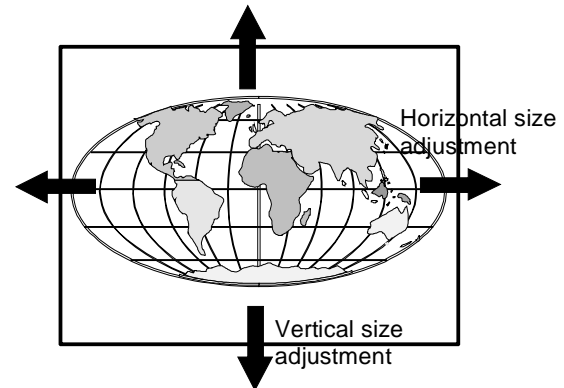
The size can be adjusted in a vertical or horizontal way.

Push the control disk to the right or to the left for a vertical resizing, push the control disk up or down for a horizontal resizing.

The default value for both directions on the bar scale is 0.

When a negative value for the horizontal size, the image will be smaller, when a positive value, the image will be larger.

When a negative value for the vertical size, the image will be less high, when a positive value, the image will be higher.

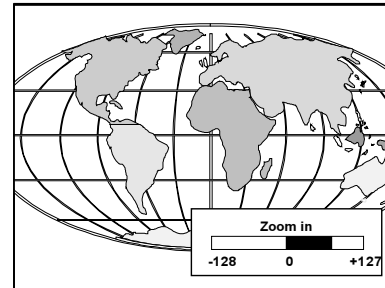
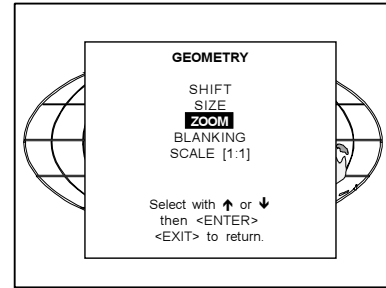


## Random Access Adjustment Mode

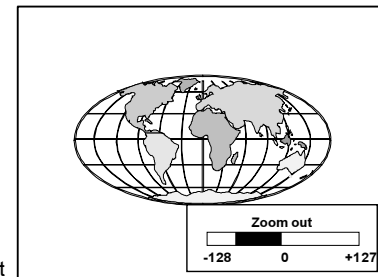
### Zoom

Highlight Zoom by pushing the control disk up or down and press **ENTER** to select.

Push the control disk to the right or forward to zoom in (more detail).  
Push the control disk to the left or backward to zoom out (less detail).  
A bar scale with number indicator which can go positive (zoom in) or negative (zoom out).



Zoom in



Zoom out

## Blanking

Highlight Blanking by pushing the control disk up or down and press ENTER to select.

Blanking adjustments affect only the edges of the projected image and are used to frame the projected image on to the screen and to hide or black out unwanted information (or noise). A 0 on the bar scale indicates no blanking.

The Blanking can be switched [ON] or [OFF]. Select Blanking [xx] by pushing the control disk up or down and press ENTER to toggle between [ON] or [OFF].

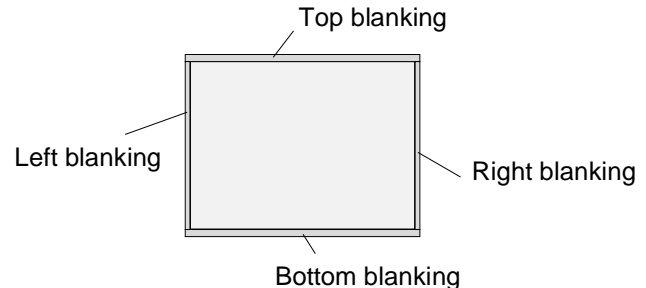
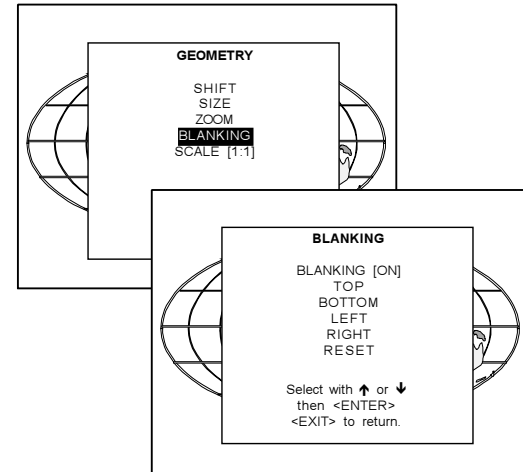
When [OFF], the image is displayed without blanking. The installed settings are still in memory for later use.

The following blanking corrections are possible :

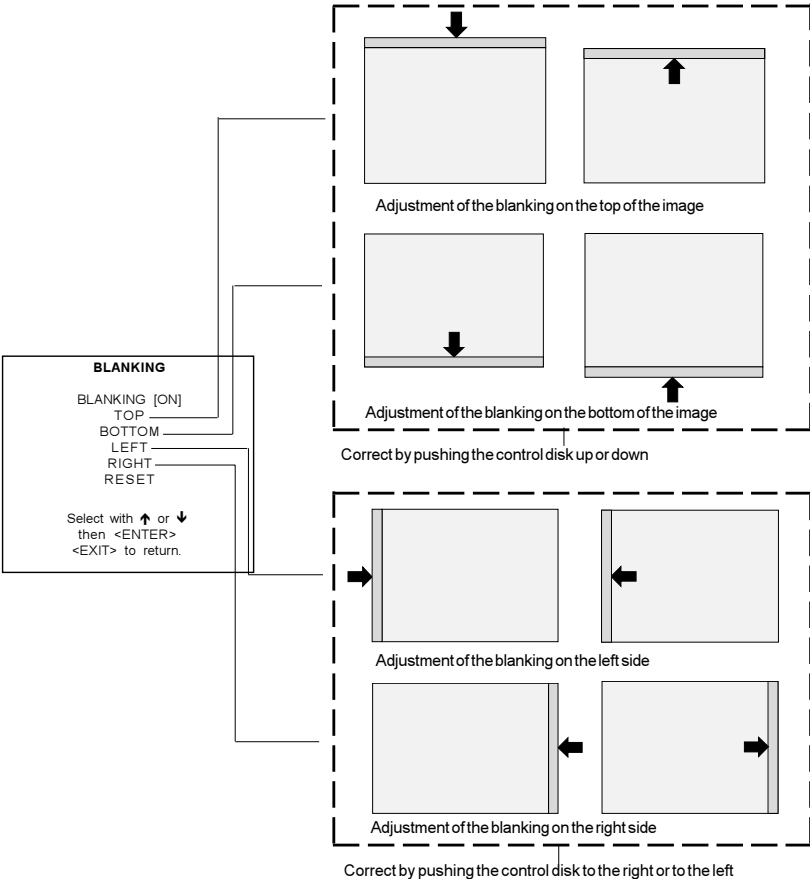
- top blanking
- bottom blanking
- left blanking
- right blanking
- reset

When the blanking ON/OFF toggle is in the OFF position and one of the blanking adjustment is selected, the toggle jumps in the ON position.

When Reset is selected, the 4 blanking settings are set to zero. The saved settings are erased.



*Random Access Adjustment Mode*

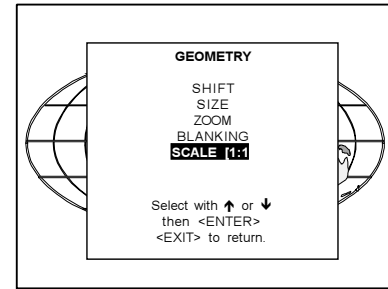


## Scale [1:1]

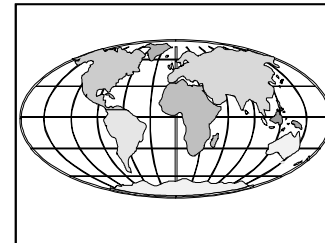
When 'Scale 1:1' is selected, the real input signal without image conversion is displayed on the screen with a resolution of 800 x 600 pixels. Parts of the image cannot be displayed and will be lost. Press **ENTER** to toggle scale between [1:1] and [1:x]. When toggled to [1:x] the full image will be displayed.

*Note : When Scale [1:1], the blanking is OFF.*

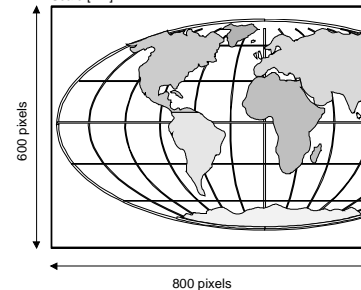
The indication Scale (-) is displayed on the menu when the pixel frequency of the input source is higher than 68 MHz.



Scale [1:x]



Scale [1:1]





## *Random Access Adjustment Mode*

---

## **INSTALLATION**

**Configuration**

**Internal Patterns**

## Starting Up the Installation Mode

Push the control disk up or down to highlight Installation and then press **ENTER**.

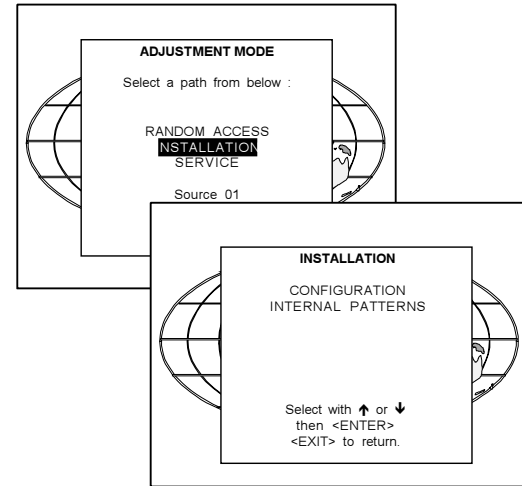
**ENTER** continues to the Installation mode selection menu.  
**EXIT** returns to operational mode.

The following item can be selected in the Installation mode :

Configuration : to set up the projector position.

Internal Patterns :

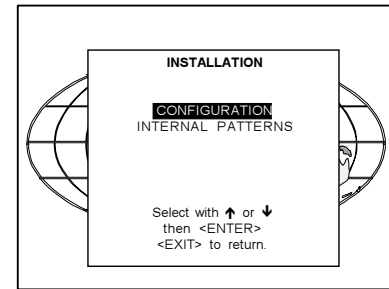
- outline
- color bars
- multiburst
- checker board
- purity



## Configuration

Highlight "Configuration" by pushing the control disk up or down and press **ENTER** to select.

For more information, see Projector configuration in chapter Installation Set Up.



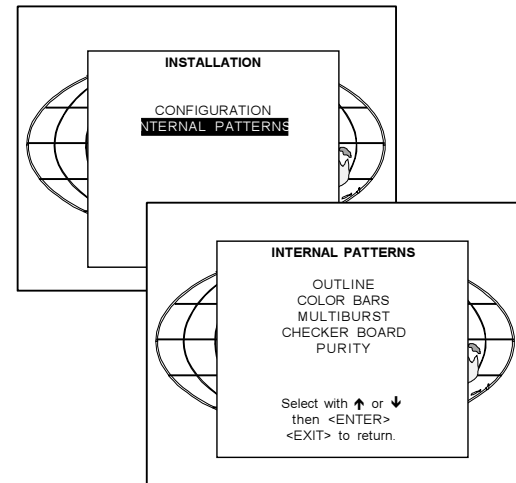
## Internal Patterns

The projector is equipped with different internal patterns which can be used for measurement purposes.

Highlight "Internal Patterns" by pushing the control disk up or down and press **ENTER** to display the Internal Pattern selection menu.

The following test pattern are available :

- Outline
- Color Bars
- Multiburst
- Checker Board
- Purity





## **SERVICE MODE**

**Identification**

**Change Password**

**Change Projector Address**

**Change Baudrate PC**

**Reset Lamp Run Time**

**Lamp Run Time History**

**Preset Input Balance**

**Change Language**

**PC Diagnosis**

**75 Ω Termination**

**Dimming**

### Starting Up the Service Mode

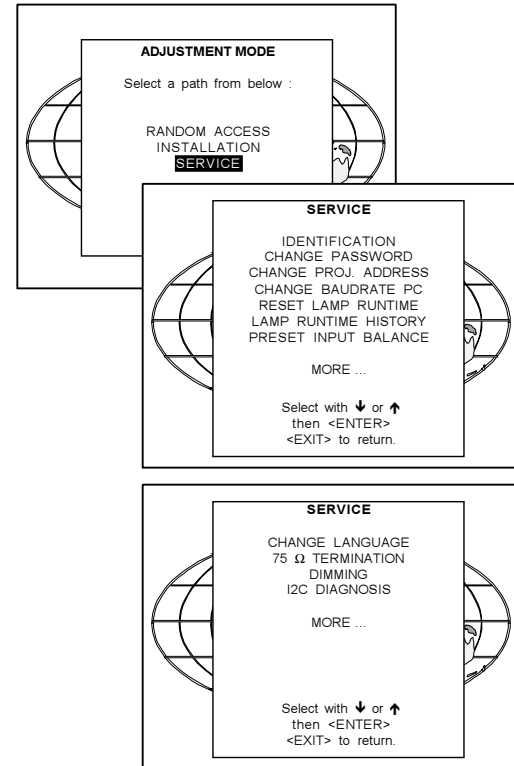
Push the control disk up or down to highlight Service and then press **ENTER**.

Some items in the Service mode are password protected (when the password function is active). Enter your password to continue. All other password protected items are now also free available if you stay in the adjustment mode.

The service menu is built-up in two parts which are connected together with the 'more' item. If the desired item is not in the list of the displayed menu, select more with the control disk and push **ENTER** to display the other items in the service menu.

**ENTER** continues to the Service mode selection menu.  
**EXIT** returns to operational mode.

Remark: The item 'LAMP DRIVE MODE' in this menu can be replaced by 'DIMMING' depending on the used lamp.  
LAMP DRIVE MODE for the lamp with order number R9829600  
DIMMING for lamps with order number R9829510 and R9829740.



**SERVICE**  
 IDENTIFICATION  
 CHANGE PASSWORD  
 CHANGE PROJ. ADDRESS  
 CHANGE BAUDRATE PC  
 RESET LAMP RUNTIME  
 LAMP RUNTIME HISTORY  
 PRESET INPUT BALANCE

MORE ...

Select with ↓ or ↑  
 then <ENTER>  
 <EXIT> to return.

**SERVICE**

CHANGE LANGUAGE  
 75 Ω TERMINATION  
 DIMMING  
 12C DIAGNOSIS

MORE ...

Select with ↓ or ↑  
 then <ENTER>  
 <EXIT> to return.

**BARCO DATA 2100**

Proj. address : 001  
 Soft. version : 3.0  
 Config : front/  
 ceiling  
 Baudrate PC : 9600  
 text : ON  
 Serial no. : 1010200  
 Run time : 100 h

Select with ↓ or ↑  
 then <ENTER>  
 <EXIT> to return.

**CHANGE PASSWORD**

Enter new password  
 0000

Select with ↓ or ↑  
 then <ENTER>  
 <EXIT> to return.

**CHANGE PROJ. ADDRESS**

Enter new address  
 001

Select with → or ←  
 Reprogram with ↓ or ↑  
 or numeric keys  
 <ENTER> to confirm  
 <EXIT> to return

**CHANGE BAUDRATE PC**

9600  
 4800  
 2400  
 1200  
 600  
 300  
 150  
 75

Select with ↓ or ↑  
 then <ENTER>  
 <EXIT> to return.

**RESET LAMP RUN TIME**

Enter the  
 serial number  
 of the new lamp  
 0000000

Select with → or ←  
 Reprogram with ↑ or ↓  
 or numeric keys  
 <ENTER> to confirm  
 <EXIT> to return

**LAMP RUNTIME HISTORY**

Serial No	Runtime
> 0111121	600 h
0110031	750 h
0110010	745 h

<EXIT> to return

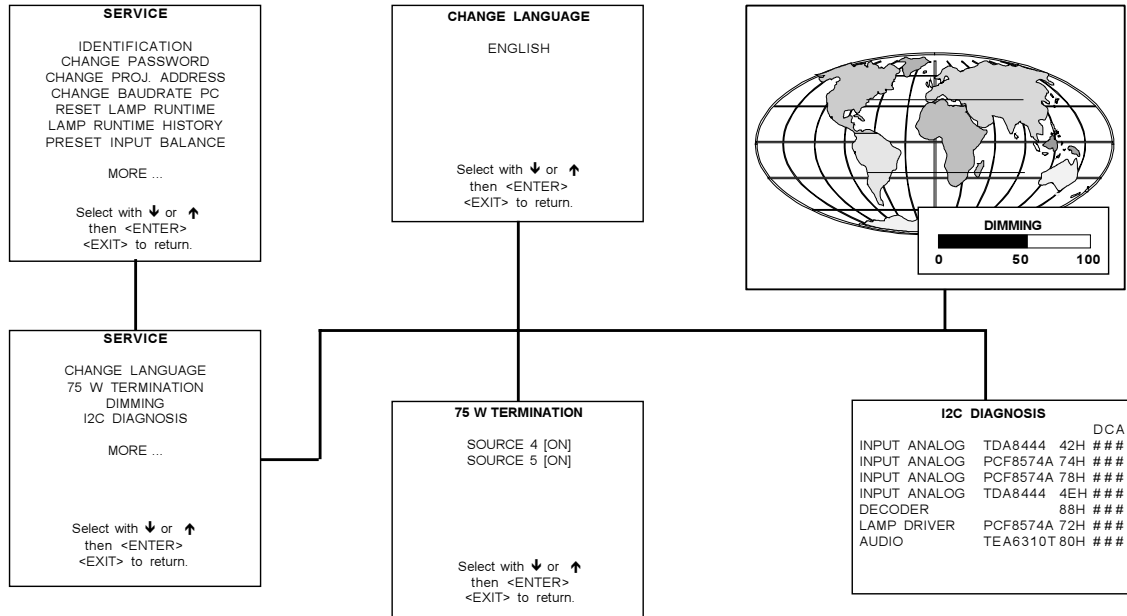
**PRESET INPUT BALANCE**  
 FILTER : XGA

BLACK BALANCE  
 WHITE BALANCE

Select with ↓ or ↑  
 then <ENTER>  
 adjust red with ↓ or ↑,  
 blue with → or ←  
 <EXIT> to return.



## Service Mode



## Identification

To display the Identification screen, push the control disk up or down to highlight *Identification* and press **ENTER** to display the *Identification* screen.

The Identification screen gives an overview of :

- type of projector
- projector address
- soft version
- installation configuration
- baud rate
- text ON
- projector serial number
- projector run time

- *type* of projector : BARCODATA 2100

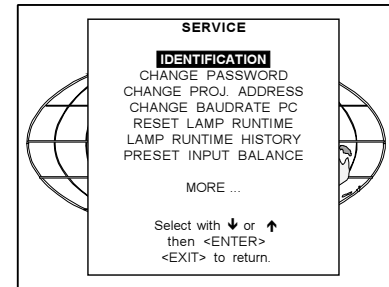
- *software version*

- *Proj. Address* : to change the address of the projector, see Change Projector Address in this chapter.

- *Installation* : possible installations :

- \* Front/Ceiling
- \* Front/Table
- \* Rear/Ceiling
- \* Rear/Table

To change the installation configuration follow the instructions in chapter Installation Set Up.



## *Service Mode*

---

- *Baud rate* : transfer speed for communication with a IBM PC (or compatible) or MAC. The baud rate of the projector must be the same as the baud rate of the connected computer. When there is a difference, consult Set up of the baud rate for communication with a computer in chapter Connections.

- *Projector Run Time* : gives the total run time since the first start up. All projectors leave the factory with a run time of approximately 24 hours.

- *Projector Serial number* : indicates the fabrication number of the projector. This number can be useful when calling for technical assistance.

## **Change Password**

This item is password protected when the password strap is installed.

### *How to Enable or Disable the Password Function ?*

The password function is enabled when the password strap on the controller module is installed.

To change the setting of the password strap, consult a qualified service technician or an authorised BARCO service center.

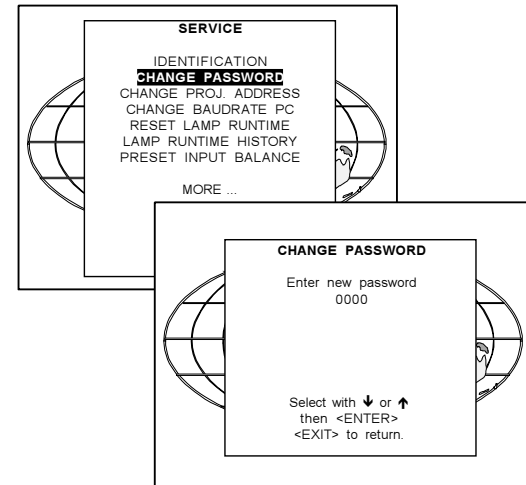
### How to Change the Password ?

Highlight Change password by pushing the control disk up or down and press **ENTER** to display the Change Password menu.

**ENTER** displays the Change Password menu  
**EXIT** returns to the adjustment selection menu.

The old password is displayed and can be changed by entering the digit with the numeric keys of the RCU or local keypad.

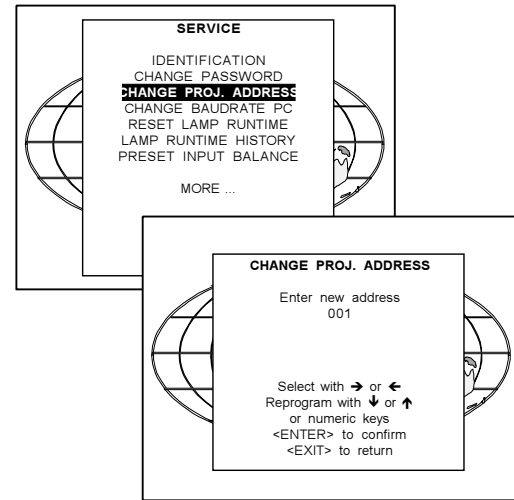
Press **ENTER** to save the new entered password.  
Press **EXIT** if no changes have to be made.



## Change Projector Address

Every projector requires an individual address between 0 and 255. This address can be software installed. To change that address, push the control disk up or down to highlight Change Proj. Address and press **ENTER**. The Change Projector Address menu will be displayed and the actual address will be filled in. The first digit is highlighted. Enter the new projector address with:

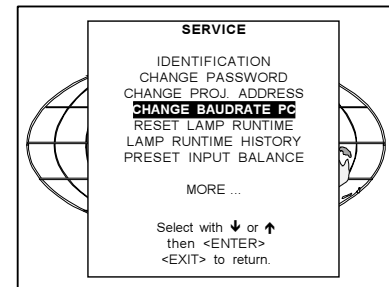
- the digit keys on the RCU or the local keypad or
- use the control disk to the right or to the left to select a digit and change the value by pushing the control disk up or down until the new value is reached. Continue with the other digits on the same way.



## Change Baud rate PC

The communication speed between projector and computer, e.g. PC or MAC, has 8 possible speeds. The baud rate speed can be software set up. Highlight Change Baud rate PC by pushing the control disk up or down and press **ENTER** to display the Change Baudrate PC.

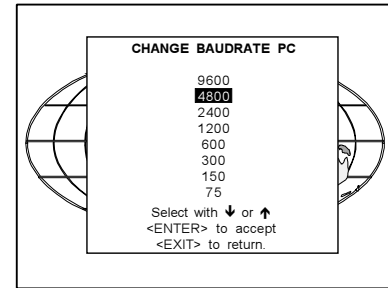
**ENTER** displays the Change Baudrate PC menu.  
**EXIT** returns to the adjustment selection menu.



The next baud rates are available :

- 9600
- 4800
- 2400
- 1200
- 600
- 300
- 150
- 75

The actual baud rate will be highlighted. To change the baud rate, push the control disk up or down and press **ENTER** to accept the new baud rate setting.



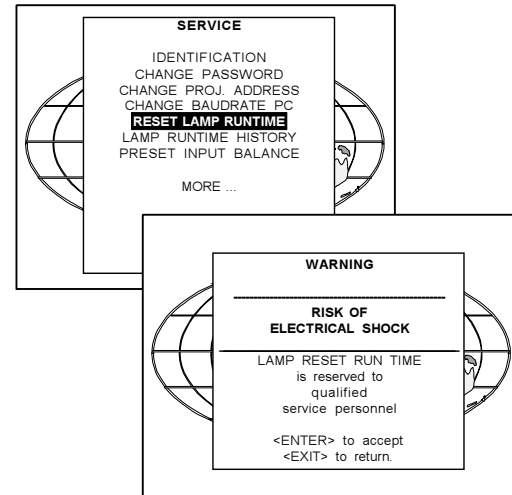
## Reset Lamp Runtime

Reset lamp run time is only allowed when a new lamp is installed. Highlight Reset Lamp Run Time by pushing the control disk up or down and press **ENTER** to select.

When Reset Lamp Run Time is selected in the Service Mode selection menu, the following warning will be displayed :

Risk of electrical shock. Reset lamp run time is reserved to qualified service personnel.

If you are not qualified, press **EXIT** to cancel the reset operation.



## Lamp Run Time History

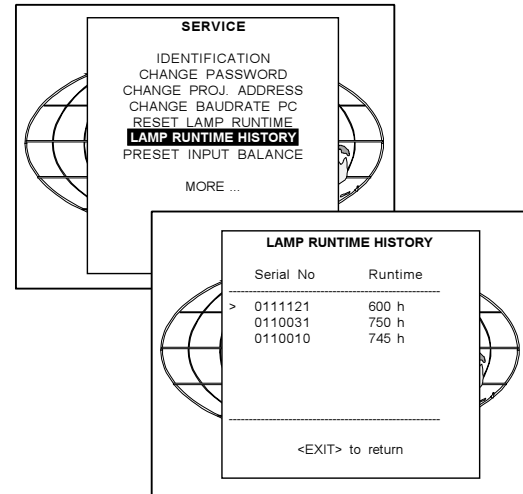
To get an overview of the different lamp run times, highlight Lamp Run Time History by pushing the control disk up or down and press **ENTER**.

**ENTER** displays the Lamp Run Time History menu.  
**EXIT** returns to the adjustment selection menu.

A listing with the lamp serial number and the corresponding run time will be displayed.

The actual installed lamp will be marked.

Press **EXIT** to return to the service mode selection menu.



## Preset Input Balance

Highlight the Black Balance by pushing the control disk up or down and press ENTER to select.

With the Black Balance adjustment, the black level of the red and blue channels can be adjusted in comparison with the green channel.

Use the control disk by pushing forward or backward to change Red or by pushing to the right or to the left to change Blue.

Press EXIT to return to the Preset Input Balance menu.

Highlight the White Balance by pushing the control disk up or down and press ENTER to select.

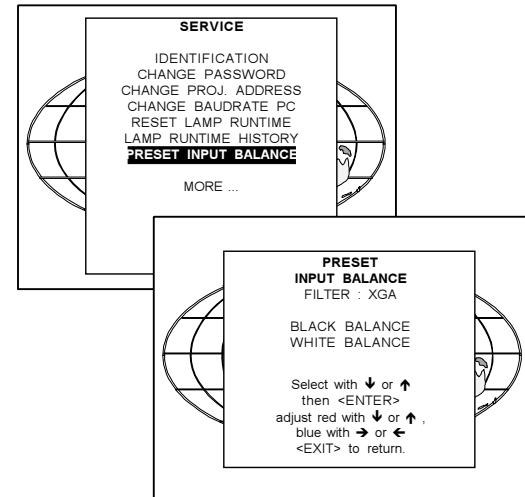
With the White Balance adjustment, the gain of the red and blue channels can be adjusted in comparison with the green channel.

(To adjust the gain of the complete video signal, use the contrast adjustment).

Use the control disk by pushing forward or backward to change Blue or by pushing to the right or to the left to change Red.

Press EXIT to return to the Preset Input Balance menu.

Depending the pixel frequency of the connected source, 3 different filters are selected : VIDEO, VGA, XGA or no filter (if Scale [1:1] is selected in the geometry menu). For each of these filters, the Preset Input Balance settings are memorised separately. During the adjustment, the used filter is indicated.

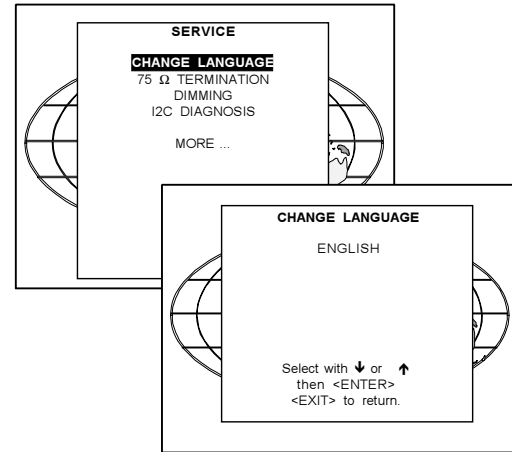




## Change Language

Highlight Language by pushing the control disk up or down and press **ENTER** to select the Language Selection menu.  
For the moment, only English is available.

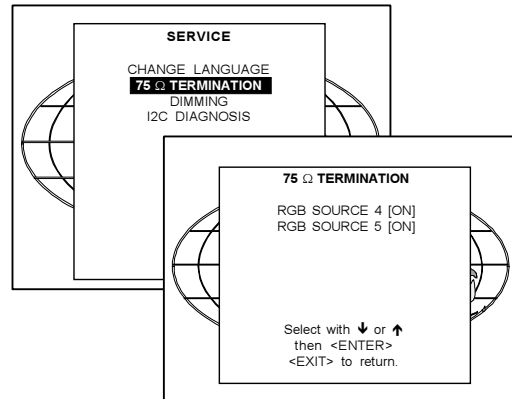
**ENTER** displays the Change Language menu.  
**EXIT** returns to the adjustment selection menu.



## 75 Ω Termination

The RGB inputs (source 4 and source 5) can be terminated on 75 Ω. Highlight '75 Ω Termination' by pushing the control disk up or down and press **ENTER** to display the 75 Ω termination menu. Select the corresponding input by pushing the control disk up or down and press **ENTER** to toggle between [ON] or [OFF].

Note : when there is no loop through connection, the inputs have to be terminated on 75 Ω.



## Dimming

(for lamps with order numbers R9829510 and R9829740)

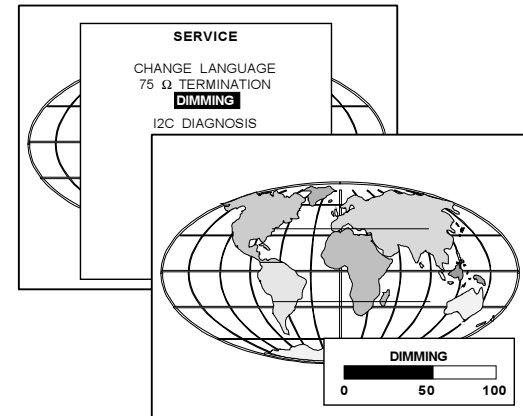
Highlights 'Dimming' by pushing the control disk up or down in the Service menu and press **ENTER** to select.

The projector starts always with full lamp power but it can be reduced to 50% of its maximum power in 8 steps.

Push the control disk to the left or to the right to reduce or increase the lamp power. Press EXIT when the desired lamp power is installed.

The Service menu returns on the screen.

Due to start up conditions of the lamp (always full power), the Dimming setting is not saved when the projector is powered down.



## Lamp Drive Mode

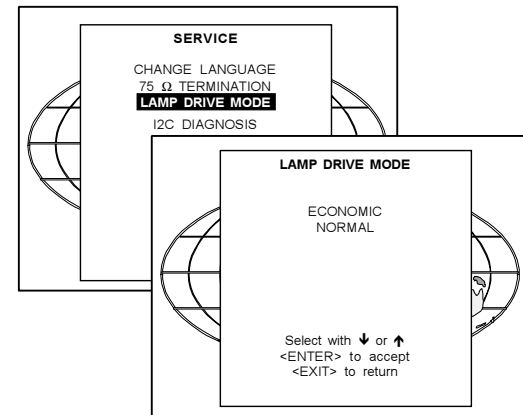
(for lamps with order number R9829600)

Highlight 'Lamp drive mode' by pushing the control disk up or down in the Service menu and press **ENTER** to select.

The projector always starts in NORMAL MODE.

Highlight the desired mode by pushing the control disk up or down and press **ENTER** to select.

Due to start up conditions of the lamp (always normal mode), the Lamp drive mode is not saved when the projector is powered down.

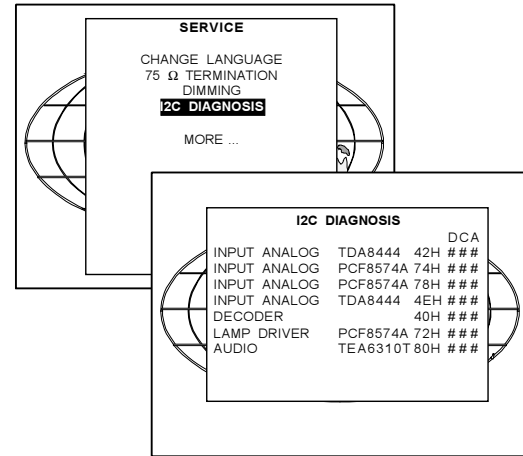


## Service Mode

---

### I2C diagnosis.

Give an overview of the correct working of the I<sup>2</sup>C controlled IC's.  
Highlight I2C diagnosis by pushing the control disk up or down and press **ENTER** to display the overview.  
**ENTER** displays the I2C diagnosis menu.  
**EXIT** returns to the adjustment selection menu.



**OPTIONAL EQUIPMENT**

**IR Remote Receiver**

**Hardwired RCU**

**RCVDS800/RCVDS05**

**VS05**

**Interfaces**

**Adapter and Communication Cables**

**Ceiling Mount Kit CM50**

## Optional Equipment

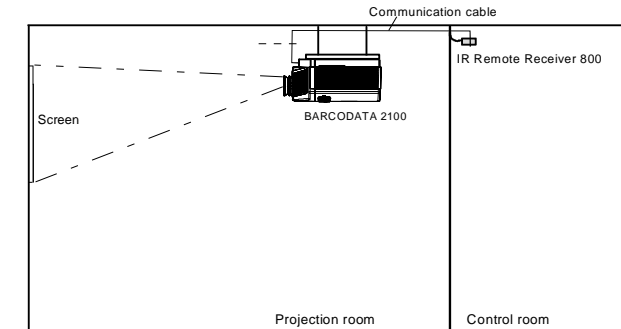
### IR Receiver 800

This infra red receiver unit makes it possible to control the BARCODATA 2100 from another room.

There is a communication line with cable between the IR receiver and the projector or the RCVDS. The control information from the RCU can now be sent to this IR receiver.

The IR receiver 800 displays the selected source on a 7-segment display.

Order number : R9827515



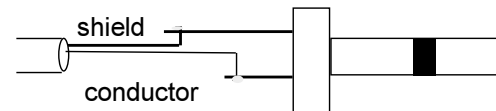
### Hardwired RCU.

The control signals from the RCU can be sent to the projector via a wired connection. (How to use the hardwired RCU, see chapter Controlling)

Preparing your remote cable :

Use a shielded cable with a maximum length of 100 m and two mini-jack 3.5 mm connectors (order number : R3131991).

- Peel back the vinyl covering of the cable on both sides and twist the wire core.
- Solder a jack plug as shown in drawing above to each end of the cable.
  - shield = ground
  - conductor = data information



When the cable is ready, plug one side in the remote control and the other side in the connector on the rear of the projector labelled 'remote'.

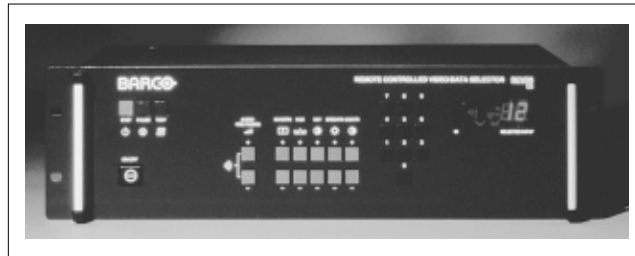
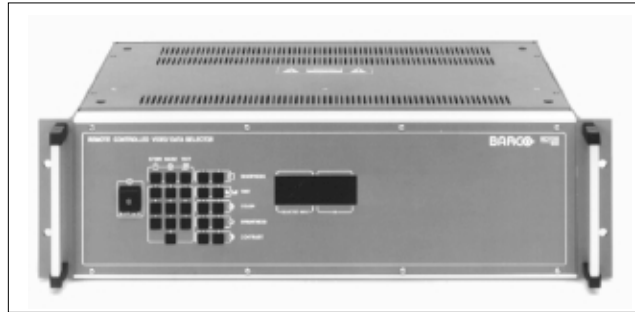
## RCVDS 800 / RCVDS 05

An optional RCVDS 800 source selector makes it possible to connect up to ten sources to the projector, an optional RCVDS 05 source selector makes it possible to connect up to 20 sources to the projector. When RCVDS's are linked via the expansion module, even 90 inputs can be connected to the projector.

The selected source number will be displayed on a 2 digit display and the selected input module will be indicated with a LED on the rear.

Order number : R9827450 (230V) without input modules  
 RCVDS800 R9827458 (120V) with input modules  
 R9827459 (120V) without input modules

Order number : R9828880 (230V) without input modules  
 RCVDS 05 R9828888 (120V) with input modules  
 R9828889 (120V) without input modules



## VS05

The VS05 is a versatile Video and HDTV source selector for all BARCO's digitally controlled large screen projectors. It offers the possibility to connect and switch up to 5 different Video sources, 3 different S-Video sources and 1 RGB Analog source to a BARCO projector. In addition, the audio signal proper to the source, can be switched to an audio amplifier.

Order number : R9827890



## Optional Equipment

---

### Interface

Universal Analog Interface  
Order number : R9826100

RGB 120 MHz Analog Interface  
Order number : R9826570

VGA interface  
Order number : R9828070 (230V)  
R9828079 (120V)

MAC interface  
Order number : R9828050 (230V)  
R9828059 (120V)

Multifunctional Analog Graphics Interface Kit (MAGIK)  
Order numbers MAGIK with cables and case :  
R9828120 (230V)  
R9828129 (120V)  
Order number MAGIK only :  
R9828121 (230V)  
R9828128 (120V)

### Adapter and Communication Cables

BARCO provides several cables to connect peripheral equipment to the BARCODATA 2100.

#### a. D9-D9 communication cable

- To connect an IBM PC (or compatible) to the projector.
- To connect a RCVDS 800/RCVDS 05 to the projector.
- To connect a IR receiver to the RCVDS or to the projector.

- To be used as extension cable for all other adapter cables.  
Available length : 5 m (16ft), order number R982770; 15 m(50ft), order number R9827640; and 30 m (100ft), order number R9827570

#### b. Din Mini8-D9 adapter cable.

- To connect a Macintosh computer to the projector.  
Available length : 1 m, order number R9827640.

#### c. D25-D9 adapter cable

- To connect a workstation to the projector.  
Available length : 1 m, order number R9827630

#### d. 5 BNC to 5 BNC cable

- To connect an analogue source to the BNC input of the projector.  
Available length : 60 cm, order number R9828260  
150 cm, order number R9828261  
5 m, order number R9828262  
15 m, order number R9828263

### Ceiling Mount Kit CM50

This ceiling mount with or without pulley system enables to mount the projector to the ceiling. The concept makes it possible to adapt the projector perfectly to the local mounting requirements in a safe and solid manner. The ceiling mount is specifically developed for rooms with a lowered ceiling, but can be used in other rooms as well by omitting the upper plate and the four screwed rods.

The CM50 has to be used in combination with an adaptor plate.

Order number CM50 without pulley : R9827990

Order number CM50 with pulley : R9829991

Order number adaptor plate : R9829450

**Standard Source Set Up Files.**

Standard preprogrammed set up files

NAME	RESOLUTION	FVERT Hz	FHOR kHz	FPIX MHz	PTOT	PACT	LTOT	LACT
CGA	640 X 200	59,924	15,700	14,318	912	640	262	200
NTSC	675 X 240I	29,970	15,734	13,500	858	720	263	240
PAL	675 X 278I	25,000	15,625	13,500	864	720	313	278
SECAM	675 X 278I	25,000	15,625	13,500	864	720	313	278
EGA	640 X 350	59,702	21,851	16,257	744	640	366	350
MAC_5	512 X 342	60,158	22,259	15,670	704	512	370	342
MAC_3	512 X 384	60,147	24,480	15,667	640	512	407	384
MAC_4	560 X 384	60,147	24,480	17,234	704	560	407	384
8514-A	1024 X 384I	43,479	35,522	44,900	1264	1024	409	384
VGA_TXT	720 X 400	70,087	31,469	28,322	900	720	449	400
COMPUSC4	1024 X 480I	29,945	30,694	39,779	1296	1024	512	480
VGA_72V	640 X 480	72,800	37,856	31,496	832	640	520	480
VGA_GR	640 X 480	59,941	31,469	25,175	800	640	525	480

*Name* : name of file, contains the settings  
*Resolution* : image resolution, when followed by ...I means interlaced.

*FVERT Hz* : vertical frequency of the source

*FHOR kHz* : horizontal frequency of the source.

*FPIX MHz* : pixel frequency

*PTOT* : total pixels on one horizontal line

*PACT* : active pixels on one horizontal line

*LTOT* : total lines in one frame

*LACT* : active lines in one frame



## Appendix A : Standard Source Set Up Files

---

NAME	RESOLUTION	FVERT Hz	FHOR kHz	FPIX MHz	PTOT	PACT	LTOT	LACT
VGA75ISO	640 X 480	75,000	39,375	31,500	800	640	525	480
MAC_2	640 X 480	66,667	35,000	30,240	864	640	525	480
MAC_LC	640 X 480	66,619	34,975	31,338	896	640	525	480
MUSE	960 X 518I	30,000	33,750	37,125	1100	960	563	518
HDMAC	1008 X 570I	25,020	31,250	39,125	1252	1008	625	570
SVGA_56V	800 X 600	56,250	35,156	36,000	1024	800	625	600
SVGA_60V	800 X 600	60,317	37,879	40,000	1056	800	628	600
SVGA_72V	800 X 600	72,084	48,080	50,003	1040	800	667	600
XGA_70V	1024 X 768	69,705	56,182	74,610	1328	1024	806	768
XGA_60	1024 X 768	60,000	48,360	64,996	1344	1024	806	768
XGA_75	1024 X 768	75,781	61,080	86,000	1408	1024	806	768
XGA_72	1024 X 768	71,955	58,140	80,000	1376	1024	808	768
SUP_MAC	1024 X 768	60,000	48,780	63,999	1312	1024	813	768
XGA_70	1024 X 768	70,000	57,050	78,044	1368	1024	815	768
MAC_POR	640 X 870	74,996	68,846	57,280	832	640	918	870
SG_60_2	1024 X 768	60,000	48.780	64,390	1320	1024	812	768

*Appendix A : Standard Source Set Up Files*

NAME	RESOLUTION	FVERT Hz	FHOR kHz	FPIX MHz	PTOT	PACT	LTOT	LACT
SG_60_3	960 X 680	60,000	43,200	54,432	1260	960	720	680

## Battery Replacement in the RCU.

Remove the battery cover on the backside of the remote control by pushing the indicated handle a little to the bottom of the RCU. Lift up the top side of the cover at the same time. (fig. 1)

Remove the battery from the compartment and disconnect the contact plate. (fig. 2)  
Connect a new 9 V battery (E-block type, e.g. type 6F22S or equivalent) to the contact plate.  
Insert the battery back into the compartment.  
Put the cover back.

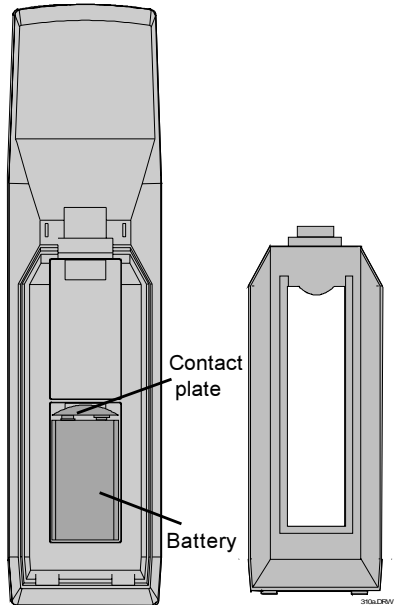


fig. 2

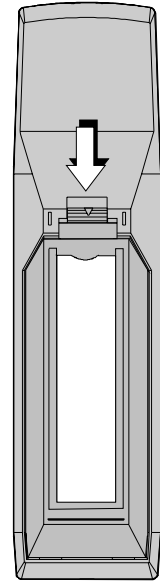


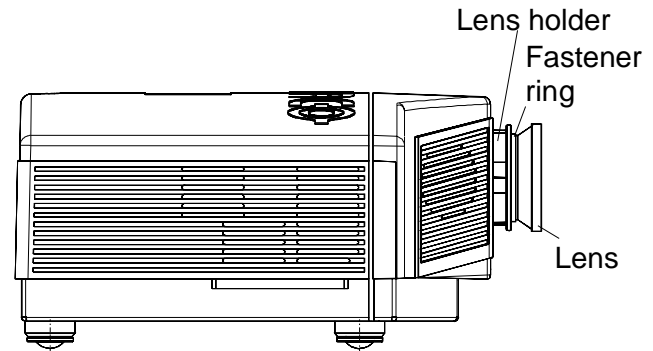
fig. 1

## Focusing the Lens

Loosen the fastener ring of the lens by turning counter clockwise.

Focus the image by turning the lens barrel to the left or the right.  
Attention : Do not turn out the lens too far, otherwise it will fall out of the lens holder.

When the image is focused, secure the correct position of the lens with the fastener ring by turning this ring clockwise.



## Lens Cleaning Procedure

### *Cleaning procedure for the SD lens*

To minimize the possibility of damaging the optical coating or scratching exposed lens surfaces, we have developed recommendations for cleaning lenses. **FIRST**, we recommend you try to remove any material from the lens by blowing it off with deionized air or **lightly** brushing it with a soft, camel's hair brush.

Plastic lens with multilayer coatings & all glass lens elements.

1. **DO NOT** spray any type of fluid directly on the lens surface.
2. **DO NOT** use any dry material to clean the surface (dry rag, tissue, etc.)
3. Use a commercial liquid window cleaner. **DO NOT use an aerosol.** Other cleaning agents, such as laboratory-grade acetone or a 70-30 mixture of ethyl ether and ethyl alcohol may also be used. If you are not sure of the cleaning agent, experiment with a small area of the lens first.
4. Use a soft cotton cloth (cotton diapers laundered several times to remove sizing) or any soft facial tissue (Charmin, Softweve, etc.).
5. When using window cleaner, **moisten the cloth or tissue** and lightly wipe the surface. Then lightly dry with a new tissue.
6. When using acetone or ethyl ether mixture, proceed as follows : Fold the cloth or tissue several times to form a pad. Soak the folded end of the pad in the acetone. Starting at the diameter opposite you, immediately wipe the coated lens, with very little pressure, toward you in a straight line and off the lens. Do not stop with the tissue

on the lens. Wipe at a speed that is equal to the evaporation rate. This is very important to prevent streaking and spotting. Start your wiping at one side of the lens and, with successive wipes, move to the other side. Turn the pad over for each wipe, then inside out. Do not make more than one wipe per clean area of pad. Be careful of the painted edge, since acetone will soften it.

*It is recommended to use a Toraysee™ cloth.*

Proceed as follows :

- \* Always wipe lenses in a single direction. Do not wipe back and forth across the lens surface as this tends to grind dirt into the coating.
- \* Do not leave cleaning cloth in either an open room or lab coat pocket, as doing so can contaminate the cloth.
- \* If smears occur when cleaning lenses, replace the cloth. Smears are the first indication of a dirty cloth.
- \* Do not use fabric softener when washing the cleaning cloth or softener sheets when drying the cloth.
- \* Do not use liquid cleaners on the cloth as doing so will contaminate the cloth.

Order number Toraysee™ cloth : R379058.

## Source Numbers 90 - 99

These source numbers do not correspond to physical inputs. They can only be used when the projector is equipped with a RCVDS 800 or RCVDS 05 or VS05. An additional adjustment file can be created for these source numbers. This file can contain different settings. The relationship between sources 0 - 9 and 90 - 99 is shown in the diagram below.

source input 1	source number 1 source number 91	file A file A'
source input 2	source number 2 source number 92	file B file B'
source input 3	source number 3 source number 93	file C file C'
	•	
	•	
source input 9	source number 9 source number 99	file I file I'

Follow the steps below to create a second file for sources 0 to 9 :

1. Select the source between 0 and 9.
2. Select the corresponding source number between 90 and 99 with the digit keys on the RCU.
3. Enter the adjustment mode and load a corresponding file. Edit this file if necessary.
4. Save the file and exit the adjustment mode.

## Lenses

This APPENDIX gives an overview of the table and formula for the available lenses for the BARCODATA 2100. An overview of all tables, diagrams and formulas can also be found in the manual "Installation diagrams for BARCO projectors", order number : R5975924.

The following lenses are available:

Name	length lens mm (inch)	diam.lens mm (inch)	weight kg (lbs)	order number
<b>SD(1.15:1)</b>	124 (4.88)	min : 110 (4.33) max : 141 (5.55)	1.92 (4.23)	R9829480
<b>SD(1.2:1)</b>	124 (4.88)	min : 110 (4.33) max : 141 (5.55)	1.92 (4.23)	R9829485
<b>SD(1.7:1)</b>	137.5 (5.41)	min : 110 (4.33) max : 117.5 (4.63)		R9829500
<b>QSD(0.8:1)</b>	210 (8.27)	min : 110 (4.33) max : 186 (7.32)	3.71 (8.18)	R9829640
<b>QSD(1.2:1)</b>	135 (5.3)	min : 110 (4.33) max : 135 (5.3)	3.0 (6.6)	R9829730

## Appendix F : Lenses

---

### Lens formulas to calculate the projector distance.

SD(1.15:1)	Metric Inch	PD= 1.079 x SW + 0.2929 PD= 1.079 x SW + 11.53
SD(1.2:1)	Metric Inch	PD= 1.135 x SW + 0.334 PD= 1.135 x SW +13.15
SD(1.7:1)	Metric Inch	PD= 1.4304 x SW + 0.4908 PD= 1.4304 x SW + 19.32
QSD(0.8:1)	Metric Inch	PD= 0.713 x SW + 0.2881 - (0.00328 / SW) PD= 0.713 x SW + 11.34 - (5.084 / SW)
QSD(1.2:1)	Metric Inch	PD= 1.1633 x SW + 0.2543 - (0.0875 / SW) PD= 1.1633 x SW + 10 - (3.58 / SW)





RCU		
PROJECTOR		
INPUT SELECTION SOURCE		
1	Video (BNC)	1
2	Video (Cinch)	2
3	S-Video	3
4	RGB-S/HV	4
5	RGB-S/HV	5
6	RGB-3S	4
7	RGB-3S	5
8	RGB-CV	4
9	RGB-CV	5
INPUT SOURCES		
RCVDS		
1		
2		
3		
5		
6		
7		
8		
9		
10		

RCU		
PROJECTOR		
INPUT SELECTION SOURCE		
1	Video (BNC)	1
2	Video (Cinch)	2
3	S-Video	3
4	RGB-S/HV	4
5	RGB-S/HV	5
6	RGB-3S	4
7	RGB-3S	5
8	RGB-CV	4
9	RGB-CV	5
INPUT SOURCES		
RCVDS		
1		
2		
3		
5		
6		
7		
8		
9		
10		

RCU		
INPUT SOURCES		
PROJECTOR		
1		
2		
3		
4		
5		
6		
7		
INPUT SOURCES		
RCVDS		
1		
2		
3		
5		
6		
7		
8		
9		
10		

RCU		
INPUT SOURCES		
PROJECTOR		
1		
2		
3		
4		
5		
6		
7		
INPUT SOURCES		
RCVDS		
1		
2		
3		
5		
6		
7		
8		
9		
10		

## Free Manuals Download Website

<http://myh66.com>

<http://usermanuals.us>

<http://www.somanuals.com>

<http://www.4manuals.cc>

<http://www.manual-lib.com>

<http://www.404manual.com>

<http://www.luxmanual.com>

<http://aubethermostatmanual.com>

Golf course search by state

<http://golfingnear.com>

Email search by domain

<http://emailbydomain.com>

Auto manuals search

<http://auto.somanuals.com>

TV manuals search

<http://tv.somanuals.com>