Refrigeration, Heating & Air Conditioning

Common Furnace Components and Blower Maintenance Procedures



Bard Manufacturing Company
Bryan, Ohio 43506

*Since 1914...Moving ahead, just as
planned.*

Manual No.: 2100-066 Rev. A
Date: 10/18/95

© Copyright 1995

Contents

Cabinet	1
Temperature Treatment Section	1
Heat Sections	1
Cooling Section	3
Blower	3
Belt Drive Blower	3
Direct Drive Blower	3
Filter	3
Thermostat	3
Electrical System Components	4
Furnace Circuits	4
Blower Motors	4
Fan Control Switch	4
Downflow and Horizontal Units	5
Limit Control	6
Upper Limit Control	6
Additive Cooling Relay	7
24 Volt or Low Voltage Control Circuit	7
Transformer	7
Thermostat	7
Basic Maintenance Procedures	7
Maintenance Check Sheet	7
Maintenance Checksheet	8
Pre-Service Check	9
Thermostat	9
Blower Compartment Check	10
Nondisposable Slab (Polyurethane)	10
Disposable Slab (Fiberglass/Cardboard)	10
Direct Drive Blower	10
Post-Service Checks	12
Heat Section Checks	12

Cabinet

Generally speaking, all heating and cooling components (except the thermostat) are housed in sheet steel cabinets. The cabinet helps protect the components and adds to the attractiveness of the units.

The heating unit or furnace cabinet is normally located indoors. It has connection provisions for attaching the cooling coil, supply air plenum and return air plenum. The cabinet also contains openings or knockouts for electrical service and required plumbing. Designed into the cabinet are removable access doors to allow for servicing the unit. The front door to oil and gas furnaces is slotted to allow combustion air to enter (this is not necessary on electric furnaces, since no fuel is burned).

Since the cooling system's outdoor unit is exposed to the weather elements and in the public eye, it is especially important the cabinet is durable, weather resistant and attractive in appearance. Like the furnace cabinet, the outdoor cooling unit cabinet has service access doors and provisions for electrical and mechanical (i.e. refrigerant line) connections.



Temperature Treatment Section

The temperature treatment section of a heating or cooling unit is that portion of the unit which produces the heating or cooling. (All types of heating units and cooling systems are discussed in greater detail in the sections that follow.)

Heat Sections

Most residential furnaces use either natural or liquefied propane (LP) gas, oil or electricity as their source of heat.

The heat section of an electric furnace consists of one or more electric heating elements. The element is much like that in an electric toaster, only bigger. When the thermostat demands heat, an electrical resistance to the flow of electricity in the element produces heat. The heated air is moved by the furnace blower through the ducts and distributed to points all over the home.

The heat section of a gas (either natural or propane) furnace consists of a steel heat exchanger and gas burners. The burners fit in a cavity at the bottom of the heat exchanger.

Gas is fed into the burners and ignited by a pilot flame on a call for heat from the thermostat. The burning gas warms the heat exchanger and the blower distributes the heat throughout the house.

The oil heat section is made up of a firebrick pot and steel heat exchanger. When the thermostat calls for heat, oil is pumped through a nozzle and ignited by a spark from a set of high voltage electrodes. A ball of fire is produced in the firebrick pot, which heats the steel heat exchanger. The blower then moves this heated air to the various distribution points.

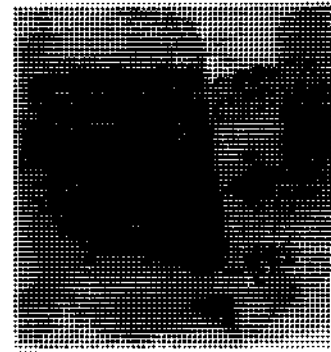

Bard Total Electric Features

Built-In Cooling Coil Compartment—Slide-in type for easier conversion to summer cooling. Accommodates 1-1/2, 2, 2-1/2, and 3 ton cooling coils.

Controls—On demand from the wall thermostat, the heating elements are energized by electrical contactors. The 15 thru 30KW versions have the blower motor interlocked with each stage for safety. Easily two staged.

Limit Switch—Thermal snap disc in each heating element shuts off power automatically if system air temperature becomes excessive.

Built-In Transformer—Provides power supply for heating and optional cooling controls.

Blower Relay—Provides automatic blower speed change-over to meet heating and cooling air delivery requirements.

Branch Circuit Fusing—Factory installed in models rated over 48 amps.

Heating Elements—Nickel-chrome wire with individual fusible links for long life. Entire assembly slides out for easy maintenance.

Motor—Multi-speed for both heating and cooling.

Blower—Heated air is quietly circulated by large volume centrifugal blower that is matched to the electrical heating system for efficiency. Slides out for easy maintenance.

Filters—Twin permanent type slide out from front for easy cleaning on all models except Models EFC5 and EFC10.

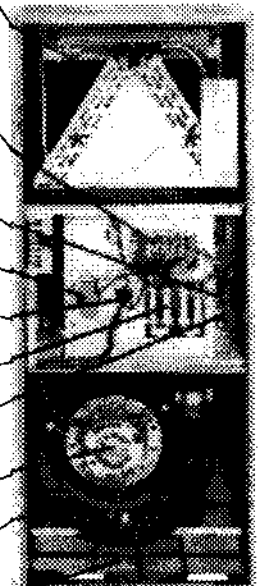

Typical Gas Furnace

Steel Cabinet is acoustically and thermally insulated for quieter operation and minimum heat loss.

Filter is extra large for better system air cleaning efficiency.

Heat Exchanger efficiently extracts all usable heat for greater fuel economy.

Safety Pilot provides 100% automatic shut-off for safety.

Mono-Jet® Burner provides ease in adjustment and has uniform flame distribution for maximum efficiency.

Powerful Blower Motor is resilient mounted for quieter operation.

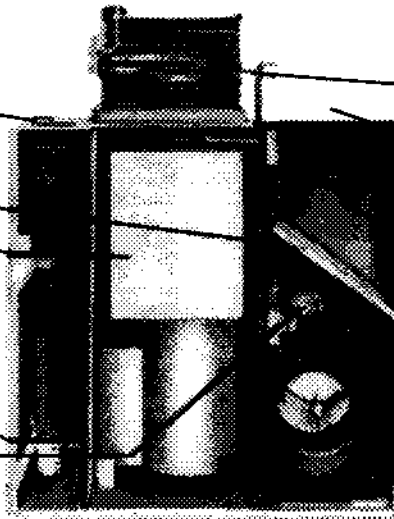

Hard Cooling Coils with plenum and system matched components are optional for converting to summer air conditioning.

Electrostatic Air Cleaner traps up to 95% of air-borne dust, bacteria-size particles, smoke, odors and 99% pollen. This optional accessory may be installed with furnace or added later.

Fan and Limit Control with helix element automatically controls blower and burner operation.

Blower is capacity matched to heating components and quietly circulates air throughout system.

Model G152

All components are easily accessible for service and inspection.

Typical Oil Furnace

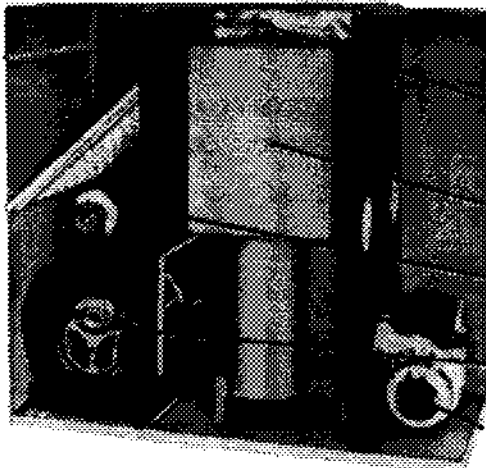

Steel Cabinet is acoustically and thermally insulated for quieter operation and minimum heat loss.

Fan and Limit Control with helix element automatically controls blower and burner operation.

Heat Exchanger provides more heating surface for efficiency.

Motor has resilient base mounting for both heating or cooling applications.

Blower is centrifugal type, dynamically balanced and mounted on rubber grommets for quieter operation.

Burner is designed for super-quiet efficiency.

Typical Installations

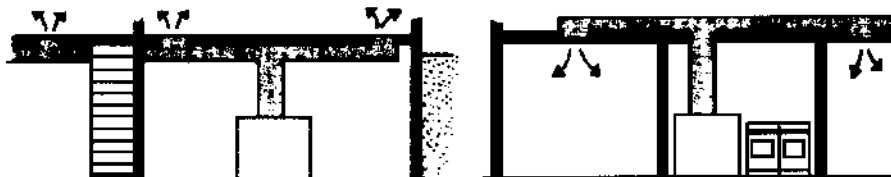

Basement

Utility Room

Cooling Section

This cooling section in a typical split-system application is the indoor evaporator coil. This coil is located in the supply plenum of the furnace. Stated simply, cool refrigerant is pumped through the evaporator coil by the cooling unit. The refrigerant in the evaporator coil removes heat from the air, and the furnace blower distributes this cool air to the conditioned spaces.

Blower

The device which moves the treated air to points throughout the home is called the blower. The blower consists of a wheel with air scoops sometimes called a scroll and a motor to drive the wheel. There are two types of blowers; a belt drive and a direct drive.

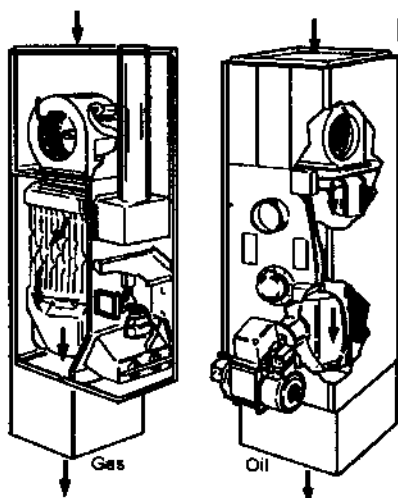

Illustrated here are typical gas-fired and oil-burning counterflow furnaces.

Belt Drive Blower

A belt runs from a pulley mounted on the motor to a pulley mounted on the blower wheel. All moving parts are anchored on a rigid U-frame, which in turn is fastened on resilient mountings to the furnace. The design of this frame insures easy adjustment and alignment of pulleys and belts for optimum performance. Varying amounts of air can be moved by a belt drive blower, depending upon the motor pulley size adjustment (see diagram). The pulley can be made larger by screwing one side of the pulley inward toward the other side; this causes the blower wheel to rotate faster. Screwing one side outward from the other side reduces the pulley's effective circumference, which in turn reduces the speed of the blower wheel. If volumes of air are desired, which cannot be obtained by motor pulley adjustment, the motor or blower pulleys themselves can be changed.

NOTE: A larger pulley might also necessitate a larger motor.

Direct Drive Blower

The direct drive blower motor is mounted inside the blower and is directly linked to the blower wheel. Air volume changes are made by electrically varying the speed of the motor. The speed in direct drive blowers is changed depending upon which of several wire leads (speed taps) coming from the motor are used. Usually two to five speeds can be obtained by wiring the hot wire to the desired

speed tap lead and the neutral wire to the common motor lead. The unused hot wire leads must be taped separately to prevent coming in contact with an electrical ground. The rotating motor produces a back voltage (emf) of approximately 200 vac through electromagnetic induction.



WARNING

Use caution when handling these leads with 200 vac electrical potential. If not taped, they could cause arcing to ground, shorts or serious electrical shocks.

Filter

A filter is the device in a forced air heating or cooling unit which mechanically screens out dust, dirt, lint and other impurities from the system's airstream.

The filter is usually located just upstream from the blower, in the return air side of the system. A fiberglass media commonly acts as the screen, cleaning the air before it is recirculated throughout the system by the blower.

A dirty filter greatly reduces the system's airflow, which greatly reduces the operating efficiency of the heating or cooling unit. For this reason, The homeowner should be instructed to check the filter monthly and clean or replace it if necessary. (Never reuse a dirty filter by turning it bottomsides up; this will result in the collected dirt being dumped back into the airstream.)

Two types of filters are the disposable and the permanent. Most slab filters are disposable, consisting of rectangular fiberglass screen in a cardboard frame. These come in a variety of sizes to fit completely across the airstream. Arrows marked on the frame indicate correct placement with respect to system airflow. When the filter becomes dirty, it should simply be removed and a new one put in its place. A nondisposable slab filter uses a polyurethane media encased in a metal frame. When this filter becomes dirty, the media may be cleaned (washed or vacuumed) and reused.

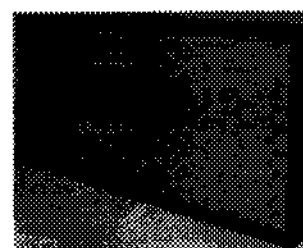

Thermostat

The thermostat is a heat sensitive switch that serves as the automatic control center for heating and cooling system operation. Since the thermostat was discussed in detail in a previous manual, its story will not be repeated here. The student should review the manual on thermostats if necessary.

Electrical System Components

Furnace Circuits

All circuits within the oil furnaces are designed and wired in accordance with Underwriters Laboratories' requirements. They have been inspected and tested at the factory to qualify for the UL label which is attached to the furnace.

All circuits within the gas furnace are designed and wired in accordance with American Gas Association requirements. They have been inspected and tested at the factory to qualify for the AGA Label which is attached to the furnace.

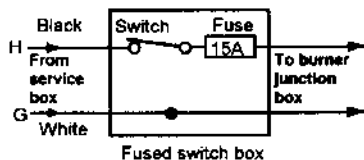

All switching within the furnace line voltage circuits is done in the hot 120V leg. The reason is that switching, if done in the ground leg, could result in an unsafe grounding fault. See diagram.

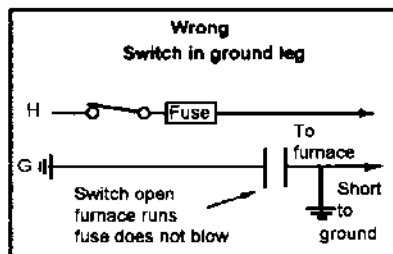
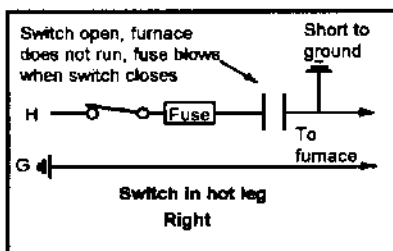

The first load in all forced warm air systems is the blower motor which is always line voltage. Therefore, the furnace blower motor is the first electrical component wired into the system.

Now when the disconnect switch lever is closed to the "on" position, this will make a complete circuit and energize the blower motor. This motor, in turn, drives the blower which delivers the air through the furnace and duct system. When the lever is placed in the "off" position, the circuit is not complete and the blower motor will not run. Airflow in the system will stop. The fuse in the switch is placed there to monitor the amount of current flow in the circuit. If there should be excessive current flowing in the circuit, the fuse will burn out and open the circuit.

Blower Motors

At this point, the blower motor has been wired into the circuit. This is the basic circuit shown in the wiring diagrams. However, there are variations in the blower motors used and the way they are

connected electrically. These variations and the reasons for each are discussed in Manual 2100-058, "Basic Electricity."

The type and size of blower motor installed in a furnace depends upon the blower load required to deliver the correct amount of air to the heating system. Because the heating system varies from one installation to another, the blower speed needs to be adjustable to match the needs of the air distribution system. This speed adjustment may be done either mechanically or electrically.

The motor may be connected to the blower by a belt and pulley. In this case, the speed adjustment is accomplished mechanically by a change in the pulleys. This is referred to as a "belt-drive blower."

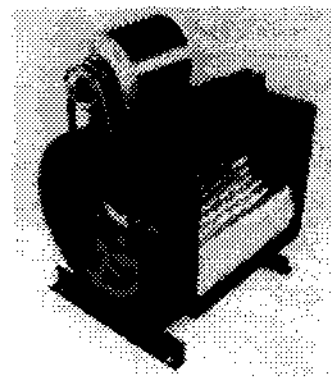

Or the blower wheel may be mounted directly on the motor shaft. In this case, the motor speed must be changed electrically. This is referred to as a "direct-drive blower."

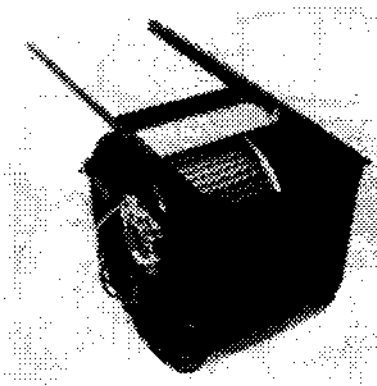

Fan Control Switch

One of the major controls in the line voltage circuit will be the fan control. The fan control switch is a heat-actuated switch which is equipped with normally open contacts. It contains a bi-metal type of heat sensing probe which senses the temperature of the air passing from the furnace into the system.

The furnace illustration shows the location of the fan control in an upflow type furnace. The probe is usually a "spiral" type and is installed into the heating unit on the front side of the cabinet with the bimetal probe inserted through the cabinet into the heat exchanger portion of the furnace. Its position must be such that the bimetal probe can sense the temperature of the air passing from the

heat exchanger. When this temperature reaches a predetermined point, the bi-metal closes the normally open contacts thus making a complete circuit, starting the blower motor.

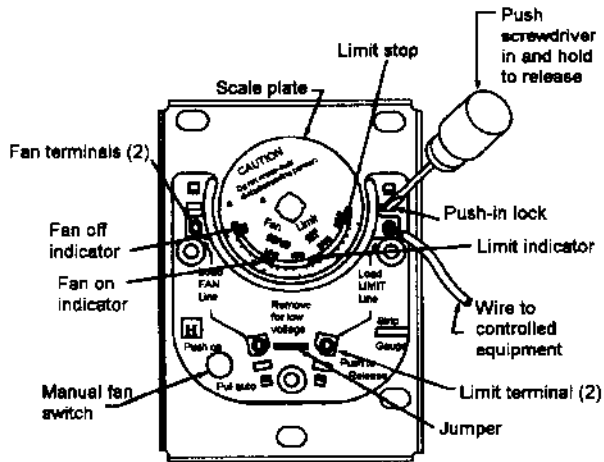

Internal view of L4004, showing use of screwdriver to connect to disconnect wires at push-in terminals. NOTE: Because the dial turns when the element temperature changes, the lettering on the dial may not be horizontal.

There are basically two types of fan controls. One is called a combination control. See illustration. The fan control portion is provided with two adjustable levers—one to set the blower “on” temperature and the other to set the blower “off” temperature.

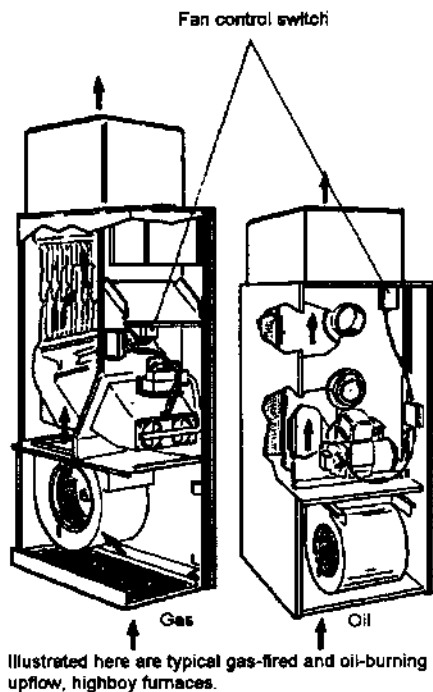

The settings of the fan control are normally field adjusted according to the desires of the homeowner and the “on” or “make” point is usually somewhere around 100°. This means that when the air passing over the heat exchanger reaches approximately 100°, the switch will “make” and the fan will come on, delivering air to the space.

The “break” or “off” point on the switch can be field set and should usually be set about 25° below the make point. If the switch is set well below return air or room temperature during the normal heating season, continuous blower operation would be accomplished.

The difference between the fan “on” and “off” points is called the fan control **differential**. The temperature difference between these two points may be set from 15 to 25°. If the differential is set too low, the control will cycle because of slight temperature fluctuations. This causes undesirable fan cycling. If set at more than 25°, the blower would have to wait too long before coming “on” increasing the heat loss from the furnace and reducing the furnace efficiency.

The other type is the single fan control. It has just one adjustable lever by which the desired blower “off” temperature is set. This is a fixed differential control with a built-in differential of 25° F. Therefore, the blower “on” temperature will always be 25° F higher than the blower “off” dial setting.

Note that if the homeowner desires to have **continuous air circulation (CAC)**, it will be necessary to set the open or break point below the normal return air temperature. In this way, the air passing over the heat exchanger will remain above the setting even though the burners are off and the blower will continue to run.

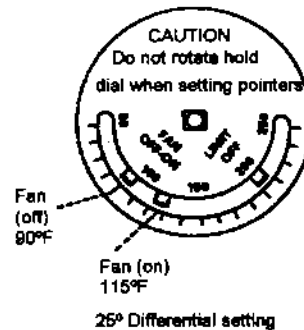
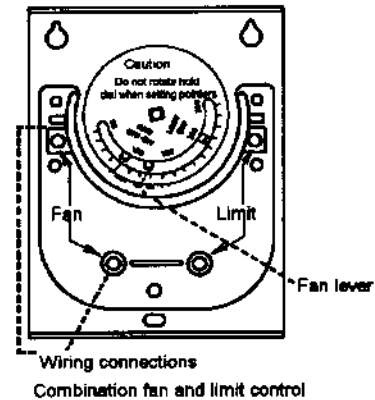

Downflow and Horizontal Units

Downflow and horizontal units present a little different problem than the upflow units. The fan control probe location in a downflow unit will work fine on the “make” or “on” cycle, because the fan would not be running and the heat exchanger would rise through the heat exchanger actuating the probe. However, once the fan is

running, the air is flowing in the opposite direction from the probe and when the burners would go off, the probe would sense the cool return air rather than the heat in the heat exchanger. This would fool the probe into thinking that the heat exchanger had cooled down and could actuate the contacts to their normal position, cycling the fan off too soon. Once off, it would sense the residual heat in the heat exchanger being transferred to the air around it and again, actuate the contacts energizing the blower and cycling it until the heat exchanger has been cooled sufficiently.

The same type of problem would be true for a horizontal type furnace, since it would not be possible to locate the blower control in an ideal position for both the "make" and "break" actions.

Limit Control

A safety device is connected into the line voltage circuit next. It is called a **limit control**. The purpose for this "limit" is to turn off the burner and control circuits if the air temperature becomes too high.

Some limit controls are combined with the fan control. See photograph. In this case, one bimetal actuates both the fan control switch and the limit control switch. As the temperature rises, the bimetal will first turn on the fan switch and start the blower. If a condition exists which causes overheating, the bimetal will continue to warp or turn until the limit cutout temperature is reached and it trips the limit switch.

The limit switch in the combination control is provided with an adjustable lever. A stop is installed which will not allow the lever to be set above the safe cutout temperature—usually 200° F. The lever should not be adjusted below this high limit temperature since it will cause false or nuisance burner cycling.

The limit control prevents overheating of the furnace which could cause a fire or damage to the furnace components. It shuts off the burner if conditions or failure should occur such as blower failure, dirty air filter, blockage of the duct system or any condition which abnormally restricts air flow through the furnace.

The limit control is actuated by a bimetal element in the discharge air stream. Therefore, it monitors the air temperature leaving the heat exchanger. The bimetal is linked to a normally closed switch which has an SPST action. If the air temperature rises to the limit cutout temperature, the bimetal opens the switch and breaks the line voltage circuit to the burner and controls.

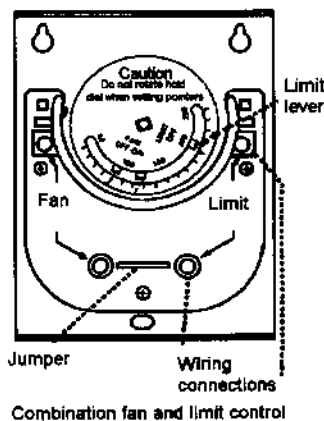

Combination fan and limit control

Limit Control

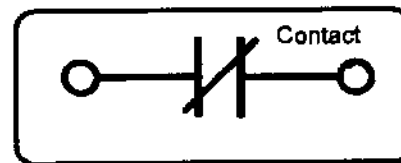

Pictorial symbol

On most furnaces, the limit control is calibrated to shut off the burner if the discharge air temperature reaches or exceeds 200° F. The limit control will automatically recycle (reclose its contacts) when the temperature drops 25° below the cutout point. Therefore, the limit control will recycle the burner if the thermostat is calling for heat, but will not allow the temperature to exceed 200° F.

The limit cutout temperature is factory set and the differential is built into the switch. Neither should be readjusted or changed in the field. Otherwise the equipment warranty will be voided and a hazardous condition will be created.

Another common limit control is illustrated. This limit has its own bimetal element and is located at a different point on the furnace than the fan control. It acts the same as the combination limit but does not have a dial setting. It is a fixed setting and fixed differential control. Again the setting is usually 200° F and the differential is 25° F. These are set and sealed by the control manufacturer.

Upper Limit Control

As was outlined under the discussion of the fan control, for downflow and horizontal heating units, an additional limit control is used. This **upper limit** is installed in the blower outlet or between the blower outlet and the heating section, or very near the blower section of the unit.

The reason is that the high temperature limit is at the discharge end of the heat exchanger. Before the blower comes on, the warm air rises away from this high limit preventing it from sensing the temperature and providing the protection needed. During this period, the upper limit provides backup protection by sensing the heated air that rises upward in the unit by gravity.

This upper limit control provides protection in case of blower failure or excessive restriction in the system which prevents the movement of air. Usually the limit cutout temperature is 140° F with a differential of 25° F.

The switch in the upper limit control is an SPDT action. The normally closed contacts are located in series ahead of the high limit contacts in the electrical circuit. Therefore, if either limit is "open" the burner and control circuits become deenergized.

The upper limit does one other thing. When the limit contacts are open, the other normally open contacts then close. This completes a circuit directly to the blower motor starting the blower.

There are several reasons for this feature. One is to put the upper limit back in step if it should trip open from residual heat after the fan control has turned the blower off. It simply overrides the fan control to provide cool air on its own elements. When the limit contacts reclose the blower contacts open, shutting off the blower.

A second reason is to back up the fan control timer if it should fail to operate as it should.

A third reason is that the upper limit control de-energizes the control circuit. Under some circumstances, this secondary limit could be open up to one hour preventing the control circuit from operating the fan timer or burner circuits. For the thermostat to do its job and get the furnace back in operation, power must be provided to the control circuit.

Additive Cooling Relay

NOTE: When cooling is added to a standard furnace, an **additive cooling relay** is required.

The line voltage side of this relay has a set of contacts which bypass the fan control, delivering power directly to the blower motor. The contacts are pulled in by a low voltage coil which is energized on a call for cooling from the thermostat or if the thermostat fan switch is set for constant blower operation. Note that electrically both the 24V and 120V circuits are completely independent, but one controls the other by pulling in its contacts.

The blower relay is necessary because on cooling, the temperature of the air being circulated through the system would be below the set point of the fan control and this would shut off and not allow the blower to run. Under cooling without the blower running, the evaporator coil would ice up and the condensing unit would go off on its limit control.

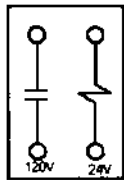

Additive cooling relay

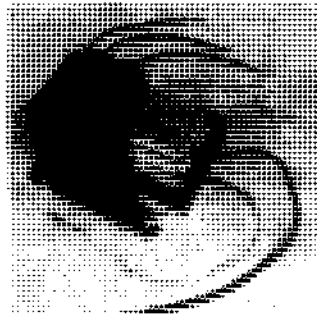

24 Volt or Low Voltage Control Circuit

In almost all residential forced warm air heating systems, the control circuits are powered with low voltage (24 volts). There are several reasons for using low voltage: ease of installation, lower installation cost, closer (better) temperature control and less possibility of electrical shocks.

Transformer

In order to supply 24 volt power in control circuits, a “step-down” transformer is used. The line side is wired directly into the 115V power supply.

Basically a transformer consists of **two** coils of insulated wire wound on a common iron core. The coil connected to the line voltage or input side is the **primary coil** and the output or load side is always the **secondary**. If the voltage on the line side is greater than that on the load side, it is a “stepdown” transformer. If the voltage on the load side is greater than the line side, it is a “setup” transformer. Therefore, to supply 24V on the load side from 115V line, a stepdown transformer is used.

Transformers are always rated in volt amperes (VA), which is the amount of electrical power (volts x amps) it can supply.

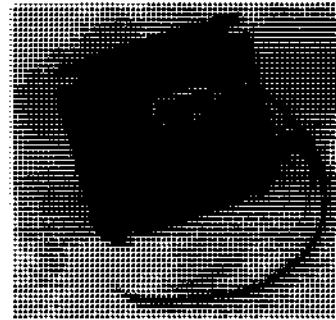
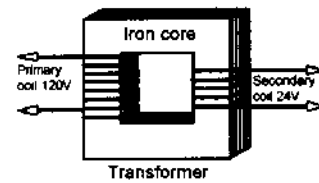

The transformer must be sized to handle the current (amperage) requirement of the load or loads connected to the secondary side of the transformer. The transformer select may be **larger** than the load requirement, but the transformer can never be smaller than the load requirement (amp-draw). Short circuit protection for the 24V side of the transformer is provided in some cases by a replaceable fuse and in others as fusible link. The fusible link is built in and requires replacement of the entire transformer if it burns out.

Thermostat

The first load that will be attached to the low voltage circuit is the **thermostat**. Basic operation of the thermostat and its internal wiring has been discussed in a previous manual, and here the common leg will be connected to one side of the transformer and the fan and heating circuits will be connected to the other side of the transformer. The thermostat can now control the fan circuit independently from the heating and cooling circuits.

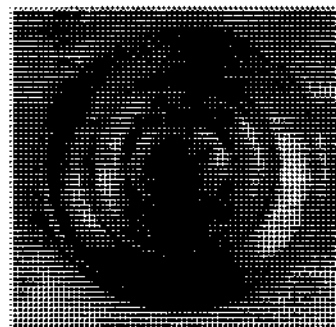

Basic Maintenance Procedures

Regularly scheduled basic maintenance calls are mutually beneficial to both the service firm and the homeowner/customer. Normally, this involves two maintenance calls per year—one in the fall prior to the heating season and one in the spring prior to the cooling season.

Maintenance Check Sheet

A maintenance check sheet has been developed which has checklists for residential gas, oil and electric heating units and cooling systems and accessories. The check sheet had checklists

Maintenance Checksheet

Dealer _____

Address _____

Customer _____

Address _____

Date _____ Person _____

Time In _____ Time Out _____

Equipment Make & Model _____

Notes _____

Pre-Service Check

Customer satisfied with system performance _____

Customer dissatisfied with system performance _____

Thermostat Checks

Record thermostat settings: Temp.: _____ F

Mode: HEAT OFF COOL FAN ON AUTO

Check terminal connections for tightness

Clean bimetal. Inspect mercury switch

Check thermostat for level

Check control circuit amperage: _____ A

If customer dissatisfied with temperature control in heating season, adjust anticipator to match control circuit amp draw

Initiate appropriate seasonal demand from thermostat

Blower Compartment Checks

Check supply voltage at junction box: _____ vac _____ time

Check blower motor amperage: _____ A _____ nameplate rating

Turn power at unit main disconnect to OFF

Check all wiring for loose connections and bad insulation

Clean or change filter

Direct Drive Blower

Check blower bearings

Lubricate blower bearings

Clean blower and compartment

Check blower wheel for free and balanced rotation

Check all blower housing mounts and setscrews for tightness

Unused motor leads taped and out of way

Belt Drive Blower

Remove blower belt and check for wear

Check motor bearings for wear

Lubricate motor bearings

Check blower wheel bearings for wear

Lubricate blower wheel bearings

Clean blower and compartment

Check blower wheel for free and balanced rotation

Check pulley alignment

Check motor and blower pulley setscrews for tightness

Put belt back on blower and motor pulley and check belt tension

Check all blower housing and motor mounts for tightness

Heating Section Checks

Electric

Check electrical wiring — connections and insulation

Check amperage draw of each element

Check total amperage draw of elements _____ amps

Check temperature rise _____ F

Return outdoor thermostats to original settings if present

Gas

Check all electrical wiring for loose connections and damaged insulation

Check burners for lint, dust and scale

Check for cracks in heat exchanger

Check furnace vent for size and deterioration

Check for quiet, even burner ignition

Check supply line gas pressure NAT _____ in. w.c. LP _____ in. w.c.

Check manifold gas pressure NAT _____ in. w.c. LP _____ in. w.c.

Electronic Ignition Control

Check electronic ignition control sequence of operation

Check safety lockout _____ min.

Check pressure switch _____

Standing Pilot

Check pilot flame

Check thermocouple open circuit _____ dcmv closed circuit _____ dcmv

Check pilot valve safety drop-out time _____ min.

Check automatic vent damper system

Check limit safety

Check temperature rise _____ °F

Gas manifold hand valve is open before leaving

Oil

Check electrical wiring — connections and insulation

Inspect combustion chamber

Inspect for soot in heat exchanger

Change fuel oil tank for sludge/water

Change oil line filter

Check oil lines

Service oil burner

Conduct combustion efficiency test:

_____ in. w.c. smoke _____ % CO₂ _____ °F net

Check limit safety

Check temperature rise

Check primary control

Check furnace vent for rust

Cooling

Check electrical wiring — connections and insulation (indoor)

Check/clean evaporator coil

Check/clean condensation drain

Check static pressure drop _____ in. w.c. _____ cfm (dry coil)

Check wiring — connections and insulation (outdoor)

Check/clean condenser coil

Lubricate condenser fan motor

Check line set and connections for evidence of leaks

Check and record supply voltage

Check refrigerant charge

Check amperage draw on condenser fan motor

Check amperage draw on compressor

Humidifier

Check electrical wiring — connections and insulation

Check transformer voltage _____ vac

Check damper position

Spray Type

Check solenoid valve

Check nozzle spray pattern

Drum Type

Check for free rotation and scale

Check water level adjustment

Check overflow/drain line

Electronic Air Cleaner

Check electrical wiring — connections and insulation

Check sail switch or electrical blower interlock

Check test button operation

Check supply voltage _____ vac (120 vac)

Check voltage to collecting plates _____ vdc (3500 vdc)

Check voltage to ionization wires _____ vdc (8000 vdc)

TURN POWER OFF

Wash cells

Wash prefilter screens

Post-Service Checks

Return thermostat to original settings recorded at beginning of service call

Leave copy of completed checksheet with customer

Power ON before leaving

which itemize the basic maintenance steps and assist in organizing the service tasks to be performed.

It is suggested the service person attach the check sheet to a clipboard and carry it to the service call. Filing in the checklists while proceeding with the call will ensure that all the necessary checks are performed efficiently. The check sheet should be completed in duplicate. One copy is for the customer. The check sheet folder copy is for the firm's reference file.

The check sheet also has other potential uses. For example, listing the make and model of the equipment gives the firm quick reference for service and parts information. And by analyzing "time in and out", the firm can accumulate labor cost data on its planned service operation. It is a valuable sales tool for add-on and replacement and accessory business. Service personnel should always keep this important aspect in mind. Tips that generate sales will help you and your company grow. The maintenance sheet is a convenient means to document this information.

The checks common to all heating and cooling units, namely those at the thermostat, blower and filter, will now be covered.



Talk to homeowner

Pre-Service Check

- Customer satisfied with system performance.
- Customer dissatisfied with system performance.
 1. The planned service appointment should be scheduled in advance so that arrangements can be made to gain access to the comfort equipment.
 2. Prior to beginning the maintenance checks, the service person should ask the customer how the system is performing. This will help get a reading on current system operation and pinpoint possible problems to investigate and correct.
 3. If the customer indicates satisfaction with the system operation, the service person can concentrate on the routine maintenance checks.

Thermostat

Record thermostat settings:

Temp _____ °F Mode: Heat Off
 Cool Fan switch: On Auto

1. Recording these settings will enable service personnel to reset thermostat to customer's desires at end of service call.
2. Some electric units may also employ an outdoor thermostat for multiple staging of heat elements (see Electric Heat Section). Record outdoor thermostat setting.

- Check terminal connections for tightness.
 1. Remove thermostat cover.
 2. Tighten terminal connections if necessary.
- Clean bimetal.
 1. Carefully remove dust and dirt from bimetal with soft brush or by blowing on it.
 2. Inspect the mercury switch for cracks in the glass bulb and brush away any accumulated dust. If mercury switch is damaged, discuss problem with homeowner and notify sales manager.
- Check thermostat for level.
 1. Place level on thermostat and adjust thermostat position if not perfectly level. A level thermostat is a necessity for precise temperature control.
- Check control circuit amperage _____ amps.
 1. Single-stage heating or cooling thermostat. Connect one clip of 10 loop amperage multiplier to "power from transformer" thermostat terminal; connect other multiplier clip to "heating" thermostat terminal if checking heating system or "cooling" terminal if checking cooling system; snap amprobe just around multiplier coil and record actual amperage draw (move decimal point of amprobe reading one place to the left to obtain actual amp draw, i.e. 4.5 reading = .45 actual amp draw).
 2. With two-stage heating thermostat. Check first stage circuit amperage using method outlined above for single thermostat.

To check second stage circuit amperage, attach one jumper wire clip to power terminal and other clip to "first stage heat" terminals; attach one amperage multiplier clip to "power" terminal; connect other multiplier clip to the "second stage heating" thermostat terminal; record actual amperage draw (by adjusting reading one decimal to the left).
- If customer is dissatisfied with temperature control in heating season, adjust heat anticipator setting to match control circuit amp draw reading.
 1. If customer is satisfied with temperature control, do not adjust anticipator and proceed with next service check.

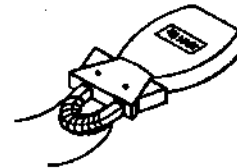

2. If during the heating season the customer complains of being too hot even after the furnace has cycled off, the heat anticipator setting should be adjusted to shorten the furnace's "on" cycle; if the customer is too cool, the anticipator should be adjusted to lengthen the "on" cycle. The cooling anticipator is usually nonadjustable. Review the thermostat manual details on anticipator adjustment.

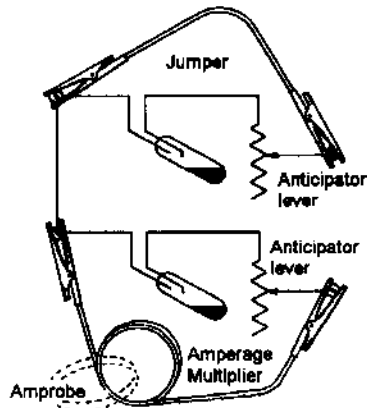
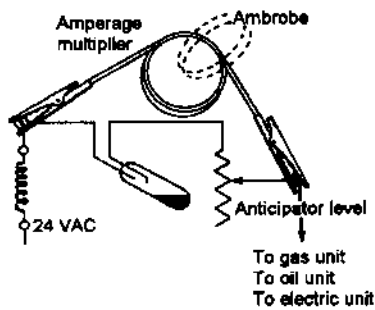

- Initiate appropriate seasonal demand from the thermostat with fan switch on **auto**: Heat Cool
- 1. If making heating unit checks, demand is created by turning thermostat to highest setting with mode switch on **heat**.
- 2. If making cooling system checks, demand is created by turning thermostat to lowest setting with mode switch on **cool**.
- 3. If the electric furnace employs an outdoor thermostat for staging of heat elements, set the dial at its highest setting to initiate a multiple stage demand. Return dial to original set points before leaving the site.

Blower Compartment Check

- Check supply voltage at unit junction box.
_____ vac _____ time
- 1. Remove access doors on front of unit.
- 2. Set volt-ohm meter above 120 vac.
- 3. Attach volt-ohm meter probes to incoming line voltage and neutral wires in junction box.
- Check blower motor amperate _____ A.
_____ Nameplate A rating
- 1. Snap amprobe around neutral or common wire leading to the blower motor.
- 2. In order to stimulate the true operating condition, put blower compartment door in place. Leave a small opening to allow for reading the amprobe.

3. Compare amp reading with amp rating on motor nameplate. An excessive amp draw reading is a clue the motor is working too hard. Possible causes:

Extremely dirty motor prevents air from dissipating heat and motor runs hot. Seized or worn bearings cause excess pull or drag; motor (and/or pulley on belt drive blowers) improperly sized in relation to blower wheel. Poorly designed system application.

If following service checks do not alleviate high motor amperage, refer problem to residential equipment troubleshooter or service manager.

4. Remove blower compartment door.
- Turn power at unit main disconnect to **off**.
 - Check all wiring for loose connections and bad insulation.
 1. Tighten loose connections. Wrap electrical tape around wires with cracked or worn insulation.
 - Clean or change filter.

NOTE: See unit installation instructions for removing filters from downflow furnaces.

Nondisposable Slab (Polyurethane)

1. Remove filter from unit.
2. Remove media from frame.
3. Wash or vacuum media.
4. If media is washed, use hot water and detergent.
5. Squeeze water from media, put in frame and coat side of media opposite the blower with a filter spray (the oil spray enhances collection of dirt particles).
6. Place filter back into unit.

Disposable Slab (Fiberglass/Cardboard)

1. Remove filter from unit.
2. Wrap in newspaper and discard.
3. Place new filter of same size in unit. Make sure filter is placed so that arrows on filter frame agree with system airflow, if applicable.

Direct Drive Blower



WARNING

Be sure power to furnace is off.

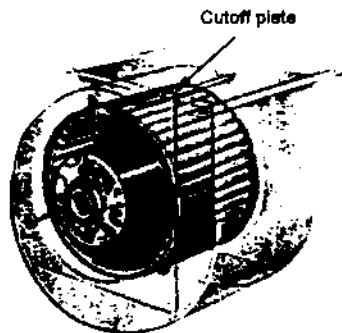

Direct drive blower showing cutoff plate

- Check blower motor bearings.
 1. Grasp blower wheel and move in back and forth and up and down directions.
 2. There should be no more than 1/8 inch back and forth movement. There should not be any up and down movement.
 3. If there is movement, bearings are wearing. Service person should inform customer of bearing condition. If problem is severe, blower motor should be replaced. Notify service manager.
- Lubricate blower motor bearings.
 1. Check motor for service instructions and lubrication instructions in unit installation instruction manual.
 2. Prelubricated motor bearings with oil ports require a few drops of SAE No. 10 nondetergent oil every two years.



CAUTION

Do not over lubricate motor bearings. Excessive oil attracts dust and dirt.

- Clean blower compartment.



CAUTION

Do not dislodge balance weights attached to blower wheel blades.



Balance weight clip

1. Remove dust and dirt for air scoops or vanes of blower wheel. This may be done with moist rag or vacuum.
 2. If blower is excessively dirty, it should be removed from unit and thoroughly washed/cleaned using high pressure hose. Remove motor from blower assembly when washing blower. Make sure motor is completely dry before it is put back into operation.
- NOTE:** It is necessary to remove cutoff plate when removing motor. Be sure to replace plate before replacing motor to ensure proper airflow.
- Check blower wheel for free and balanced rotation.

1. Spin wheel. If wheel is badly out of balance or hits against housing, blower should be replaced. Notify service manager.
2. If dislodged balance weights are found, place them in exact location they formerly occupied. Look for scratches on blades to show where weight clip was attached.

When wheel is spun, the heavier side will fall to bottom. This means the side minus the weight is probably on top. If the old location cannot be found, leave weights off rather than risk further imbalance by incorrect placement.

3. If blower was removed for cleaning, reinstall at this time.
- Check all blower housing mounts and setscrews for tightness.
 - Check that unused motor leads are taped and out of the way.

Belt Drive Motor



WARNING

Be sure power to furnace is off.

- Remove belt and check for wear.
 1. Loosen motor mount and push motor toward blower wheel.
 2. Remove belt by sliding it off the pulleys.
 3. Check for wear by turning belt inside out and looking for splits and cracks in the rubber.
 4. Replace belt if there are signs of wear. (Leave belt off to perform the following checks. You will be instructed when to put it back on.)
- Check motor bearings for wear.
 1. Grasp motor pulley.
 2. Push pulley in inward and outward directions. Assuming the pulley is mounted tightly to the motor shaft or drive, there should be no more than 1/8 inch movement or play in either direction.
 3. Move pulley in up and down directions. There should be no movement in either direction.
 4. If there is movement in motor shaft, bearings are wearing. Service person should inform customer of bearing condition. If problem is severe, motor should be replaced. Notify service manager.
- Lubricate motor bearings.
 1. Check motor for service instructions and lubrication instruction in unit installation manual.
 2. Prelubricated bearings require a few drops of SAE No. 10 nondetergent oil every two years.



CAUTION

Do not over lubricate motor bearings. Excessive lubrication attracts dirt and dust. Oil splash on the belt causes shortened belt life.

3. Motor bearings with oil cups or holes. Add a few drops of automotive 10 nondetergent oil.
- Check blower wheel bearings for wear.
1. Grasp blower pulley and move in up and down directions. Also push in and out. There should be no movement in any direction if the pulley is mounted tightly to the blower shaft.
 2. Grasp shaft and test bearings on opposite side of blower wheel. There should be no movement.
 3. If there is in and out movement on either side, move locking collars on the affected side closer to bearing as follows:

On the pulley side, loosen set screw on shaft and remove pulley.

Loosen collar set screw and move collar snugly against bearing housing. Tighten collar setscrew.

4. If there is still movement, bearings are worn. Inform customer of bearing condition. If problem is severe, blower bearings should be replaced. Notify service manager.
- Lubricate blower wheel bearings.
1. Bearings with no lubricant fittings. These are permanently sealed and lubricated and require no service.
 2. Bearings with grease cups. Turn grease cup down approximately one turn yearly. When cups are turned to the bottom, refill with lubricant.
- Bearings with grease plugs. These are normally prelubricated and require lubrication about every two years. If lubricant is required, use No. 2 neutral mineral grease. Check lubrication instruction.
- Clean blower and compartment.
1. Remove dirt from air scoops or vanes of blower wheel. This may be done with moist rag or vacuum.
 2. If blower is excessively dirty, it should be removed and thoroughly washed/cleaned using high pressure hose. Remove motor from blower assembly before washing blower. Make sure motor is completely dry before it is put back into operation.
- Check blower wheel for free and balanced rotation.
1. Spin wheel. If wheel is badly out of balance or hits against housing, blower should be replaced.
 2. If dislodged balance weights are found, place them in exact location they formerly occupied. Look for scratches on blades to show where weight clip was attached.
- When wheel is spun, the heavier side will fall to bottom. This means the side minus the weight is probably on top. If old location cannot be found, leave weights off rather than risk further imbalance by incorrect placement.
3. If blower was removed from unit for cleaning, reinstall at this time.

- Check pulley alignment.

1. Check alignment by placing a straight rod across grooves of the motor and blower pulleys.

2. If grooves of pulleys do not line up, loosen shaft setscrew and move motor pulley until it is aligned with blower pulley.
3. Tighten motor pulley setscrew and recheck alignment.

- Check motor and blower pulley setscrews for tightness.

An adjustable motor pulley has two setscrews, one to tighten the adjustable pulley sheave and one to tighten the pulley to the motor shaft.

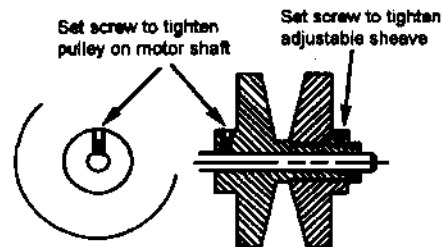

- Put belt back on blower and motor pulleys and check belt tension.

1. Place belt around pulleys.
2. Adjust motor mount to tighten belt.
3. Check tension by pushing down on belt halfway between pulleys. Belt should move or deflect from 3/4" to 1".

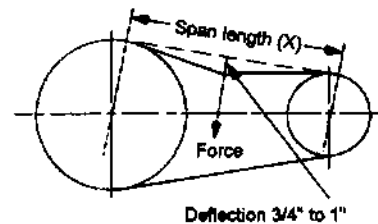

4. When proper tension is obtained, tighten adjustable motor mount.
- Check all blower housing and motor mounts for tightness.

Post-Service Checks

- Return thermostat(s) to original setting(s) recorded at beginning of service call.
- Leave copy of completed check sheet with customer.
- Power on before leaving.
1. Be sure unit disconnect has been turned on before leaving to avoid a needless, time consuming callback.
- Leave all service areas neat and clean.

Heat Section Checks

These are discussed individually, according to type of fuel used, in the next sections.

1. Coil
2. Flue connection
3. Cabinet
4. Heat exchanger
5. Gas valves & controls
6. Gas burner & manifold
7. Blower
8. Electronic air cleaner

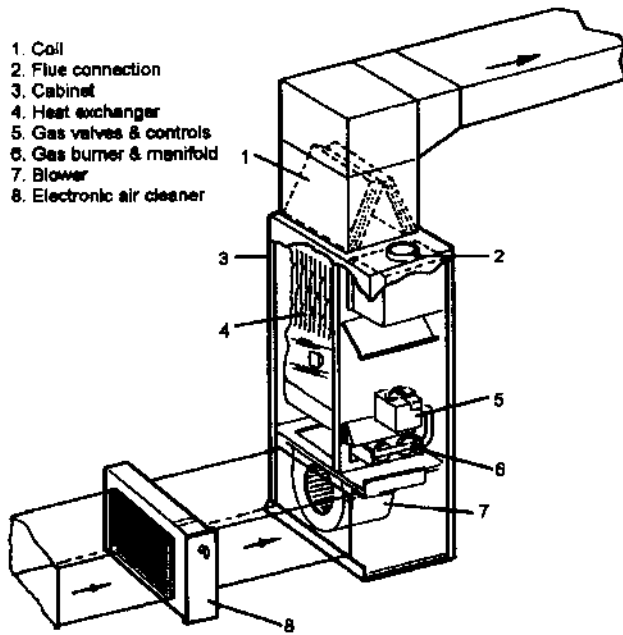

With properly designed systems, add-on equipment and components will increase the degree of comfort produced for the homeowner.

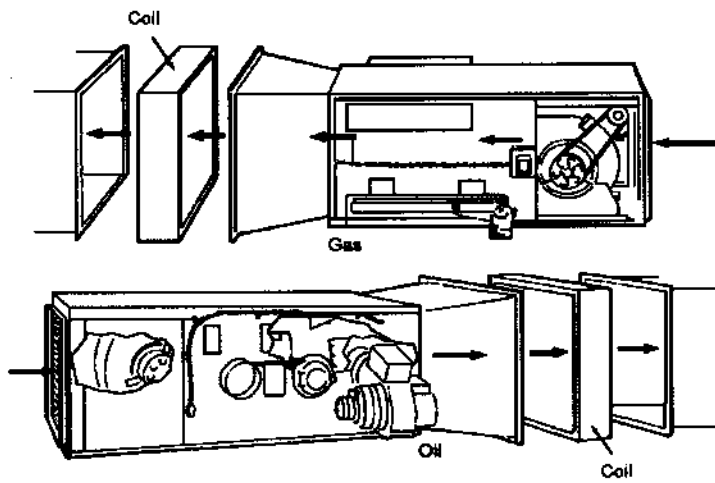

Illustrated here are typical gas-fired and oil-burning horizontal furnaces.

Free Manuals Download Website

<http://myh66.com>

<http://usermanuals.us>

<http://www.somanuals.com>

<http://www.4manuals.cc>

<http://www.manual-lib.com>

<http://www.404manual.com>

<http://www.luxmanual.com>

<http://aubethermostatmanual.com>

Golf course search by state

<http://golfingnear.com>

Email search by domain

<http://emailbydomain.com>

Auto manuals search

<http://auto.somanuals.com>

TV manuals search

<http://tv.somanuals.com>