

EUROLIVE

B412DSP

User manual

en

A50-15713-00003



www.behringer.com



Important safety instructions



CAUTION: To reduce the risk of electric shock, do not remove the top cover (or the rear section). No user serviceable parts inside; refer servicing to qualified personnel.

WARNING: To reduce the risk of fire or electric shock, do not expose this appliance to rain and moisture. The apparatus shall not be exposed to dripping or splashing and no objects filled with liquids, such as vases, shall be placed on the apparatus.



This symbol, wherever it appears, alerts you to the presence of uninsulated dangerous voltage inside the enclosure—voltage that may be sufficient to constitute a risk of shock.



This symbol, wherever it appears, alerts you to important operating and maintenance instructions in the accompanying literature. Please read the manual.

WARNING
THIS EQUIPMENT IS CAPABLE OF DELIVERING SOUND PRESSURE LEVELS IN EXCESS OF 90 dB, WHICH MAY CAUSE PERMANENT HEARING DAMAGE.

Ventilation:

The appliance should be situated so that its location or position does not interfere with its proper ventilation. For example, the appliance should not be situated on a bed, sofa rug, or similar surface that may block the ventilation openings or placed in a built-in installation, such as a bookcase or cabinet that may impede the flow of air.

Check the floor:

Always check the floor for stability before you set up the speaker cabinet. Vibrating floors (e.g. elements/components on the stage) do not provide reliable support for speaker stacks. So, always place your speakers on a stable and level surface.

Make sure that speaker cabinets are set up properly:

Set up your speaker cabinet at a distance to dance floors or other audience areas, so as to avoid a speaker stack being knocked over.

- 1) Read these instructions.
 - 2) Keep these instructions.
 - 3) Heed all warnings.
 - 4) Follow all instructions.
 - 5) Do not use this apparatus near water.
 - 6) Clean only with dry cloth.
 - 7) Do not block any ventilation openings. Install in accordance with the manufacturer's instructions.
 - 8) Do not install near any heat sources such as radiators, heat registers, stoves, or other apparatus (including amplifiers) that produce heat.
 - 9) Do not defeat the safety purpose of the polarized or grounding-type plug. A polarized plug has two blades with one wider than the other. A grounding type plug has two blades and a third grounding prong. The wide blade or the third prong are provided for your safety. If the provided plug does not fit into your outlet, consult an electrician for replacement of the obsolete outlet.
 - 10) Protect the power cord from being walked on or pinched particularly at plugs, convenience receptacles, and the point where they exit from the apparatus.
 - 11) The apparatus shall be connected to a MAINS socket outlet with a protective earthing connection.
 - 12) Where the MAINS plug or an appliance coupler is used as the disconnect device, the disconnect device shall remain readily operable.
 - 13) Only use attachments/accessories specified by the manufacturer.
 - 14) Use only with the cart, stand, tripod, bracket, or table specified by the manufacturer, or sold with the apparatus. When a cart is used, use caution when moving the cart/apparatus combination to avoid injury from tip-over.
- 
- 15) Unplug this apparatus during lightning storms or when unused for long periods of time.
 - 16) Refer all servicing to qualified service personnel. Servicing is required when the apparatus has been damaged in any way, such as power supply cord or plug is damaged, liquid has been spilled or objects have fallen into the apparatus, the apparatus has been exposed to rain or moisture, does not operate normally, or has been dropped.
 - 17) CAUTION - These service instructions are for use by qualified service personnel only. To reduce the risk of electric shock do not perform any servicing other than that contained in the operation instructions unless you are qualified to do so.

EUROLIVE

Digital Processor-Controlled 600-Watt 12" PA Speaker System with Integrated Mixer

- ▲ High-power 600-Watt 2-way PA sound reinforcement speaker system with integrated mixer for live and playback applications
- ▲ State-of-the-art 24-bit digital signal processor for ultimate system control
 - Digital crossover, phase and time correction for perfect driver alignment plus dual compressor/limiter for total system protection
 - Digital noise gate, low-cut filter, 2-band EQ, dynamic Contour filter for ultimate sound reproduction
- ▲ 2 ULN Mic/Line inputs with individual volume controls and peak LEDs
- ▲ Extremely powerful 12" long-excursion driver provides incredibly deep bass and acoustic power
- ▲ State-of-the-art 1.75" titanium-diaphragm compression driver for exceptional, high-frequency reproduction
- ▲ Ultra-wide dispersion and large format exponential/conical horn with multi-cell aperture throat
- ▲ Additional Line output enables linking of additional speaker systems
- ▲ Versatile trapezoidal enclosure design allows different positioning:
 - Stand mounting with 35-mm pole socket
 - Tilts on its side for use as a floor monitor
- ▲ Ergonomically shaped handles for easy carrying and setup
- ▲ High-quality components and exceptionally rugged construction ensure long life
- ▲ Conceived and designed by BEHRINGER Germany

B412DSP

Foreword



Dear customer,

Welcome to the team of BEHRINGER users, and thank you very much for expressing your confidence in us by purchasing these PA loudspeakers.

Writing this foreword for you gives me great pleasure, because it represents the culmination of many months of hard work delivered by our engineering team to achieve a very ambitious goal: to develop an outstanding PA system that offers a maximum in flexibility and performance through its impressive

sound character and outstanding features. The task of designing our new B412DSP certainly meant a great deal of responsibility, which we assumed by focusing on you, the discerning user and musician. Meeting your expectations also meant a lot of work and night shifts. But it was fun, too. Developing a product usually brings a lot of people together, and what a great feeling it is when all who participated in such a project can be proud of what they've achieved.

It is our philosophy to share our enjoyment with you, because you are the most important member of the BEHRINGER team. With your highly competent suggestions for new products you've made a significant contribution to shaping our company and making it successful. In return, we guarantee you uncompromising quality as well as excellent technical and audio properties at an extremely reasonable price. All of this will enable you to give free rein to your creativity without being hampered by budget constraints.

We are often asked how we manage to produce such high-quality devices at such unbelievably low prices. The answer is quite simple: it's you, our customers! Many satisfied customers mean large sales volumes enabling us to get better purchasing terms for components, etc. Isn't it only fair to pass this benefit on to you? Because we know that your success is our success too!

I would like to thank all people whose help on the B412DSP has made it all possible. Everybody has made very personal contributions, starting from the designers of the unit to the many staff members in our company and finally to you, the user of BEHRINGER products.

My friends, it's been worth the effort!

Thank you very much,

Uli Behringer

Table of contents

1. Introduction	5
1.1 Before you get started	5
1.1.1 Shipment	5
1.1.2 Initial operation	5
1.1.3 Online registration	5
2. Control elements and connections	6
3. Setting up the B412DSP	7
3.1 Tweeter	7
3.2 How to avoid feedback	7
4. Application examples	7
4.1 Presentations	7
4.2 PA systems	8
4.3 Other uses	9
5. Installation	9
6. Specifications	9
7. Warranty	10

1. Introduction

Thank you very much for expressing your confidence in BEHRINGER products by purchasing the EUROLIVE B412DSP. The B412DSP is a state-of-the-art digitally controlled PA speaker system that will simply blow you away. Its bi-amped 600-Watt engine drives a high-efficiency 12" woofer for brutal punch and a 1.75" titanium driver for high-end resolution. The built-in mixer allows you to run the show without any extra equipment. A powerful 24-bit DSP controls the crossover, a dual compressor/limiter, phase and time corrections and even a noise gate. The intelligent dynamic EQ makes sure your system sounds perfect at any sound level.

 **Please read this manual to familiarize yourself with the control elements of the unit and its functions. After you have carefully read this manual, keep it for future reference.**

1.1 Before you get started

1.1.1 Shipment

Your B412DSP was carefully packed at the assembly plant to assure secure transport. Should the condition of the cardboard box suggest that damage may have taken place, please inspect the unit immediately and look for physical indications of damage.

 **Damaged equipment should NEVER be sent directly to us. Please inform the dealer from whom you acquired the unit immediately as well as the transportation company from which you took delivery. Otherwise, all claims for replacement/repair may be rendered invalid.**

 **Please always use the original packaging to avoid damage due to storage or shipping.**

 **Never let unsupervised children play with the B412DSP or with its packaging.**

 **Please dispose of all packaging materials in an environmentally friendly fashion.**

1.1.2 Initial operation

Be sure that there is enough space around the unit for cooling. To avoid overheating, do not place the B412DSP on top of power amps or near radiators, etc.

The mains connection is made using the enclosed power cord and a standard IEC receptacle. It meets all international safety certification requirements.

 **Please make sure that all equipment is properly grounded at all times. For your own safety, never remove or disable the ground conductor of the unit or of the AC power cord.**

IMPORTANT NOTE CONCERNING INSTALLATION

 **The sound quality may diminish within the range of powerful broadcasting stations and high-frequency sources. Increase the distance between the transmitter and the device and use shielded cables for all connections.**

1.1.3 Online registration

Please remember to register your new BEHRINGER equipment right after your purchase by visiting www.behringer.com and read the terms and conditions of our warranty carefully.

Should your BEHRINGER product malfunction, our goal is to have it repaired as quickly as possible. To arrange for warranty service, please contact the retailer from whom the equipment was purchased. Should your BEHRINGER dealer not be located in your vicinity, you may directly contact one of our subsidiaries. Corresponding contact information is included in the original equipment packaging (Global Contact Information/European Contact Information). Should your country not be listed, please contact the distributor nearest you. A list of distributors can be found in the support area of our website (www.behringer.com).

Registering your purchase and equipment with us helps us process your repair claims quicker and more efficiently.

Thank you for your cooperation!

2. Control elements and connections

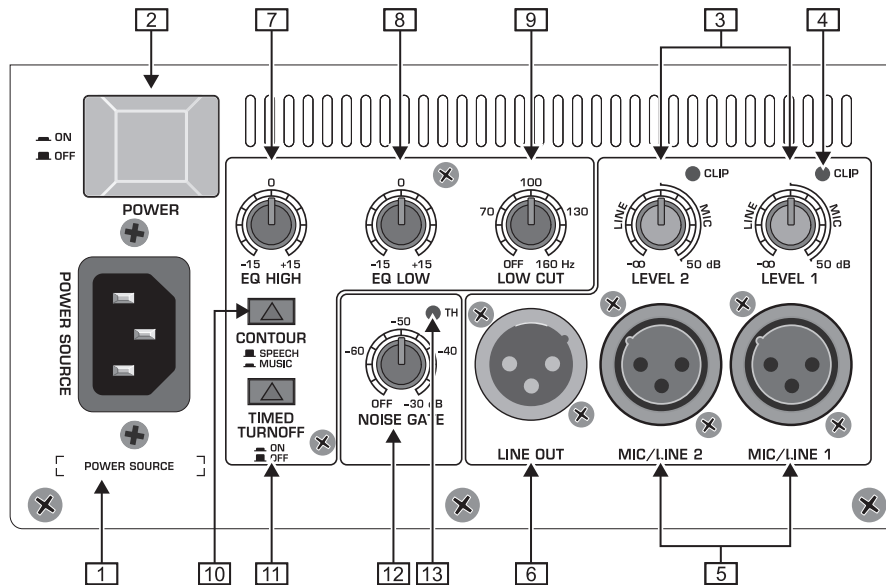

Fig. 2.1: Control elements and connections

- 1 Power is supplied via an IEC connector. The matching cable is provided with the unit.
 - 2 Use the **POWER** switch to turn on the B412DSP. Before connecting the unit to the power mains, ensure that the **POWER** switch is in OFF position.
- Attention:** The **POWER** switch does not fully disconnect the unit from the mains. To disconnect the unit from the mains, pull out the main cable plug or appliance coupler. When installing the product, ensure the plug or appliance coupler is readily operable. Unplug the power cord completely when the unit is not used for long periods of time.
- 3 Use the **LEVEL** control to adjust the signal gain of the MIC/LINE inputs. Before you connect or disconnect a signal source to or from one of the inputs, please turn the corresponding control fully to the left. Once the signal source is connected, increase the volume as desired by turning the control clockwise. Always make sure that the **CLIP LED** 4 does not light up at all or with signal peaks only.

Line-level signals:
Devices with high output levels (e.g. the outputs of mixing consoles or CD players) only need little gain. In this case, the **LEVEL** control will mostly be positioned somewhere in the area marked "LINE" (left half of the control range).

Microphone signals
Low-level microphone signals need more gain. When microphones are used, the control will be positioned in the MIC area (right half of the control range).
 - 4 The **CLIP LED** lights up when the input signal level is too high. In this case, turn the **LEVEL** control 3 to the left until the LED goes out or only lights up at peak levels.
 - 5 Use the **MIC/LINE** inputs (XLR connectors) for connecting audio signals.
 - 6 The **LINE OUT** XLR jack provides the signal with no additional gain applied in order to connect another loudspeaker, for example. The output signal is a mix of both input signals. (See chapter 4.2 for more information on how to use several loudspeakers)
- The B412DSP is equipped with a 2-band tone control. Each band allows you to apply a maximum boost/cut of 15 dB, in its center position the equalizer is set to neutral.
- 7 Use the **EQ HIGH** control to cut or boost the treble range by 15 dB. The cut-off frequency is 12 kHz.
 - 8 Use the **EQ LOW** control to cut or boost the bass range by 15 dB. The cut-off frequency is 100 Hz.
 - 9 The B512DSP features a high-pass filter with a slope of 24 dB/oct. to eliminate unwanted low-frequency content, such as pop sounds produced by hand-held microphones, or rumble or wind noise when using high-sensitivity microphones. The **LOW CUT** control adjusts the cut-off frequency. If you want to use the B412DSP in combination with a subwoofer, you can use the high-pass filter to lower the bass range reproduced by the subwoofer. This allows you to operate the B412DSP even without an external frequency crossover. Set the cut-off frequency to the highest frequency that can be reproduced by the subwoofer.
 - 10 The **CONTOUR** switch governs the dynamic contour filter:

SPEECH
Setting the **CONTOUR** switch to **SPEECH** (switch not pressed) will optimize the frequency response for speech applications. This ensures better intelligibility.

MUSIC
Setting the **CONTOUR** switch to **MUSIC** (switch pressed) will optimize the frequency response for music playback.
 - 11 The **TIMED TURNOFF** switch activates the automatic turn-off function:

ON
When the switch is actuated (**ON** position), the automatic turn-off function is active. The loudspeaker is turned off automatically when it receives no signal for more than 3 minutes. As soon as a signal is received, the loudspeaker is switched back on.

OFF

If the switch is not actuated (OFF position) then the speaker remains switched on and can only be deactivated via the POWER switch [2].

- [12] A noise-gate allows you to eliminate unwanted noise during signal pauses. This is done by a circuit that mutes the output when the signal level drops below a preset threshold. Use the *NOISE GATE* control to determine the threshold below which the noise-gate closes.
- [13] The *TH* LED lights up as soon as the signal level drops below the threshold value adjusted with the *NOISE GATE* control [12] (the noise-gate closes).

The LED on the front indicates the following operating status:

Indicator	Operating status
BLUE light	The device is switched on
BLUE light (dimmed)	Device is on standby (if <i>TIMED TURN-OFF</i> activated)
VIOLET light	same function as <i>CLIP LED</i> [4]
flashing RED	Device is overheating! Switch off the speaker until it cools down

Tab. 2.1: Frontal LED operating status

3. Setting up the B412DSP

The sound of your B412DSP largely depends on the room acoustics. Please observe the following hints to get the most out of your B412DSP.

3.1 Tweeter

High frequencies are the very part of the audio spectrum that ensure a clear perception of sound and speech intelligibility. Although these frequencies can be located most easily, they are also the first to be blocked acoustically. We therefore recommend that you set up your speakers on speaker stands (not included), so that the tweeter radiates its signals slightly above the heads of the audience. This will ensure both an optimum dispersion of the high-frequency content and a considerably improved speech intelligibility.

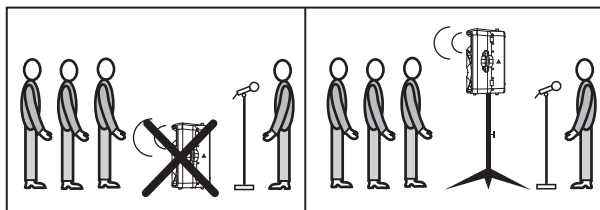

Fig. 3.1: B412DSP mounted on a stand

3.2 How to avoid feedback

Always place the microphones (viewed from the audience) behind the B412DSP, never in front of it (Fig. 3.2). When you wish to adjust the controls on the B412DSP while holding a microphone, please approach the loudspeaker from the rear to avoid feedback.

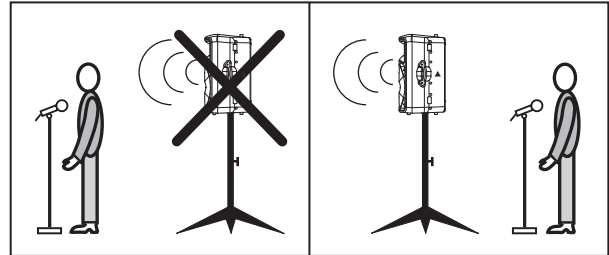

Fig. 3.2: Right and wrong positioning

Since the B412DSP can be placed on the floor at an angle as shown in the illustration below, you can also use it as a monitor speaker on stage. In contrast to PA speakers, stage monitors are used to direct sound towards individual performers on stage. When microphones are used, it is not easy to position the monitor speakers, since the microphones are moved around in front of them, often coming very close. To avoid feedback, it is recommended that you carefully select and direct the microphones used. Basically, you should use microphones with a high directivity, i.e. with a cardioid or hyper-cardioid polar pattern. Never hold a microphone so that its main pick-up area points directly towards the loudspeaker. When you hold it with its less sensitive side towards the speaker box, you can move closer to the speaker.

Microphones with a cardioid polar pattern should always be directed at a 90° angle to the axis of the loudspeaker (Fig. 3.3, left). Microphones with a hyper-cardioid polar pattern should always be positioned at an acute angle to the axis (Fig. 3.3, right).

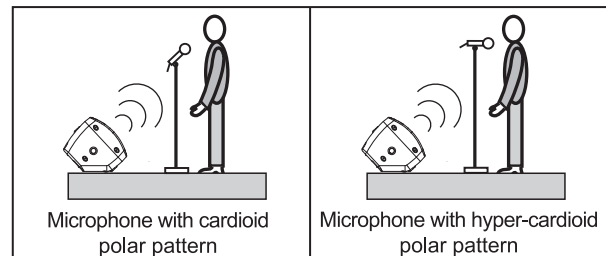

Fig. 3.3: The B412DSP as a monitor loudspeaker

⚠ If you encounter persistent feedback problems, consider using our proven FEEDBACK DESTROYER PRO FBQ2496 for line-level signals. For signals with line or microphone level, we recommend our BEHRINGER SHARK DSP110.

4. Application examples

4.1 Presentations

With just one B412DSP and one or two dynamic microphones, you can set up a basic audio system with very little effort. Thanks to the built-in mixer section, you can connect the microphones directly to the B412DSP. Mount the B412DSP on a speaker stand for optimum presentation and intelligibility of announcements. If one B412DSP is not enough, you can, of course, use a second or even more loudspeakers.

Connecting microphones:

- ▲ Turn the LEVEL controls [3] fully to the left.
- ▲ Connect your microphones to the MIC/LINE inputs.
- ▲ Switch on the B412DSP.
- ▲ Turn the LEVEL controls [3] gradually clockwise to set the volume of your choice. Observe the CLIP LEDs while adjusting the volume. Make sure they never shine constantly but only light up at peak levels.
- ▲ Use the LINE OUT connector [6] to connect an (optional) second B412DSP.

⚠ **Never place a microphone directly in front of the loudspeaker owing to danger of feedback! When operating the B412DSP make sure that you always stay behind the loudspeaker to avoid feedback.**

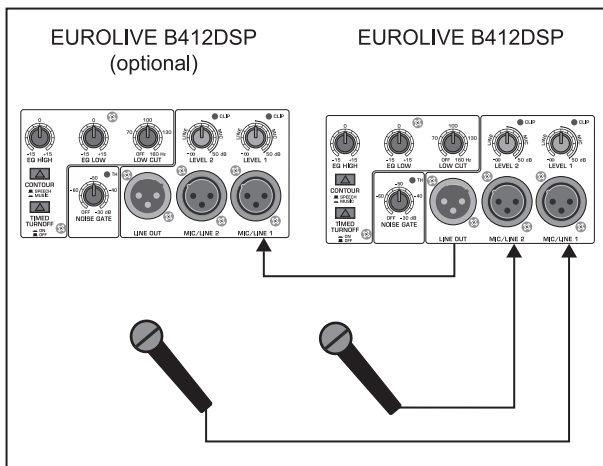

Fig. 4.1: Connecting microphones

4.2 PA systems

PA is short for "public address" and includes all applications that involve a larger audience. This example uses a mixing console as its central unit for system operation and connections. All microphones, feeding and effects devices, etc. are connected to the mixing console, which is then linked to the B412DSP.

Connecting a mixing console:

- ▲ Turn the LEVEL controls [3] fully to the left.
- ▲ Connect the left output of the mixing console to the MIC/LINE connector of the left loudspeaker, and the right mixing console output to the right loudspeaker.
- ▲ Switch on the B412DSP.
- ▲ Raise the level of the mixing console output to a level of 0dB.
- ▲ Turn the LEVEL controls [3] gradually clockwise to set the volume of your choice. When the CLIP LEDs light up, this indicates that the maximum volume has been reached.

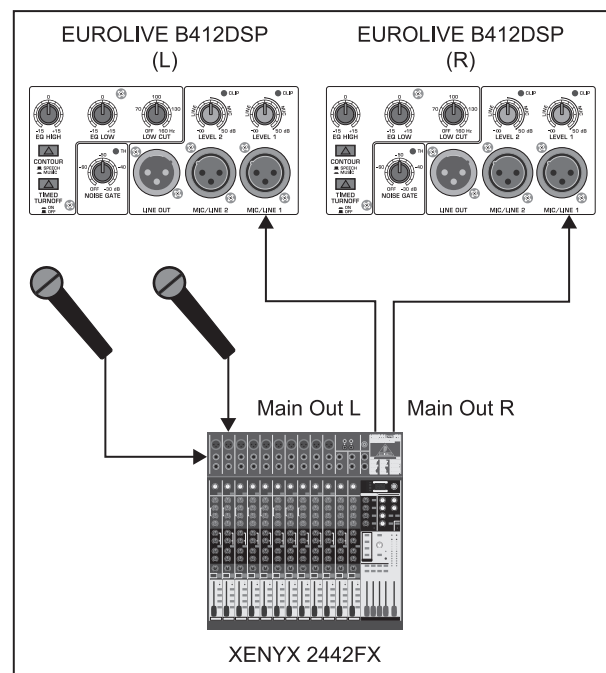

Fig. 4.2: Connecting a mixing console

Instead of a mixing console, you can also connect a stereo signal source, e.g. a CD player. In this case, one B412DSP is connected to each of the outputs of the signal source.

Connecting a stereo signal source:

- ▲ Turn the LEVEL controls [3] fully to the left.
- ▲ Connect the left output of the stereo device to the MIC/LINE connector of the left loudspeaker, and the right stereo device output to the MIC/LINE connector of the right loudspeaker.
- ▲ Switch on the B412DSP.
- ▲ Raise the output level of the stereo signal source (if available), ensuring that it does not overload the input.
- ▲ Turn the LEVEL controls [3] gradually clockwise to set the volume of your choice.

Linking several B412DSP:

If you need more sound pressure, for example in larger rooms, simply increase the number of loudspeakers on each stereo side. You could place two B412DSP on each stereo side and interconnect them (see Fig. 4.3). The loudspeakers can be stacked or placed one beside the other. When you stack the speakers, the carrying recesses built into the cabinets ensure the stability of the stack. You can connect a microphone, a mixing console or stereo signal source.

▲ Connect the LINE OUT connector [6] of the first B412DSP to the MIC/LINE input of the next B412DSP.

👉 With several B412DSP speakers connected to each other, their input impedance will be reduced by half (two B412DSPs), or to one third (three B412DSPs), etc. Always use the output impedance of the mixing console as a basis for your calculations!

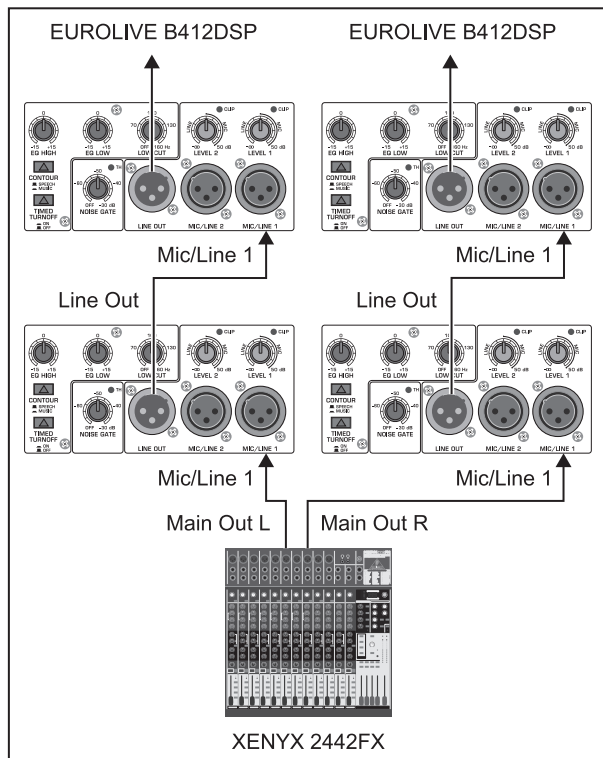

Fig. 4.3: Linking several B412DSP speakers

4.3 Other uses

Monitoring:

When used as a monitor, the B412DSP receives its audio signal from the monitor or aux output of the mixing console. If additional B412DSPs are to be used, you can loop the audio signal from the first speaker to the next B412DSP using the line output. The sound and volume of each B412DSP can be adjusted with their own operating elements [3] (LEVEL), [7] (EQ HIGH) and [8] (EQ LOW).

Keyboard amplification:

Guitarists and bassists usually have their own amplifiers on stage to make sure they can hear their own instrument—even when no monitors are used. In particular on smaller stages, the power delivered by these amps is enough to match the volume produced by other sound sources on stage. Things are different with keyboards and synthesizers as these usually have no built-in speakers. The B412DSP allows you to connect and mix two keyboards. If you want to play more than two keyboards, you can use a submixer (e.g. MicroMIX MX400) to mix down the signals and route them to the B412DSP using submixer output connectors. The second MIC/LINE input can be used to connect the monitor signal from the PA mixing console, so that you can also hear the other members of your band.

5. Installation

Both audio inputs and outputs of the BEHRINGER B412DSP are fully balanced. To maximize interference compensation, try to establish balanced connections to other equipment, whenever possible.

👉 Make sure that only competent people install your B412DSP. They must be sufficiently earthed during and after the installation process. Otherwise, electrostatic discharges may negatively affect the operating characteristics of your equipment.

Balanced use with XLR connectors

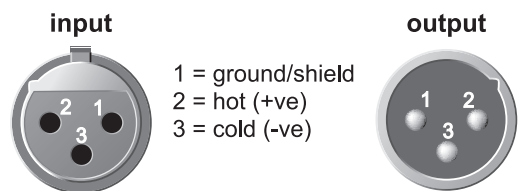

For unbalanced use, pin 1 and pin 3 have to be bridged

Fig. 5.1: XLR connector

6. Specifications

AUDIO INPUTS

MIC/LINE (2)	XLR (balanced)
Input impedance	27 kOhm
Sensitivity	-40 to +10 dBu

AUDIO OUTPUTS

LINE OUT	XLR (balanced)
Output impedance	120 Ohm

PROCESSING

DSP	24-bit fixed-point Motorola
AD/DA converter	24-bit / 48 kHz
Limiter	dual protection for woofer and driver
Dynamic EQ	dual parametric EQ's
NOISE GATE	variable (off to -30 dB < -45 dB)
TIMED TURNOFF	switchable (3 min)
CONTOUR	switchable speech / music contour
EQ HIGH	+/- 15 dB (12 kHz)
EQ LOW	+/- 15 dB (100 Hz)
LOW CUT	40 - 160 Hz (24 dB/Oct.)

SYSTEM DATA

Frequency range	45 Hz to 20 kHz
Crossover	Butterworth, 1.7 kHz, 24 dB/Oct.
Max. sound pressure level	127 dB @ 1 m
Dispersion angle	90° x 45°

OUTPUT POWER

Low-frequency range

RMS @ 1% THD	320 W @ 8 Ohm
Peak Power	460 W @ 8 Ohm

High-frequency range

RMS @ 1% THD	80 W @ 8 Ohm
Peak Power	140 W @ 8 Ohm

POWER SUPPLY

Mains Voltage/Fuse	
100 V~, 50/60 Hz	T 6,3 A H 250 V
120 V~, 60 Hz	T 6,3 A H 250 V
220 V~, 50 Hz	T 4,0 A H 250 V
230 V~, 50 Hz	T 4,0 A H 250 V
Power consumption	max. 650 W
Mains connector	Standard IEC receptacle

DIMENSIONS/WEIGHT

Dimensions (H x W x D)	26" x 15 1/2" x 15" 660 mm x 395 mm x 380 mm
Weight	approx. 65 lbs. approx. 30 kg

BEHRINGER is constantly striving to maintain the highest professional standards. As a result of these efforts, modifications may be made from time to time to existing products without prior notice. Specifications and appearance may differ from those listed or illustrated.

7. Warranty

§ 1 OTHER WARRANTY RIGHTS AND NATIONAL LAW

1. This warranty does not exclude or limit the buyer's statutory rights provided by national law, in particular, any such rights against the seller that arise from a legally effective purchase contract.
2. The warranty regulations mentioned herein are applicable unless they constitute an infringement of national warranty law.

§ 2 ONLINE REGISTRATION

Please do remember to register your new BEHRINGER equipment right after your purchase by visiting www.behringer.com (alternatively www.behringer.de) and kindly read the terms and conditions of our warranty carefully.

Registering your purchase and equipment with us helps us process your repair claims quicker and more efficiently.

Thank you for your cooperation!

§ 3 WARRANTY

1. BEHRINGER (BEHRINGER International GmbH including all BEHRINGER subsidiaries listed on the enclosed page, except BEHRINGER Japan) warrants the mechanical and electronic components of this product to be free of defects in material and workmanship for a period of one (1) year* from the original date of purchase, in accordance with the warranty regulations described below. If the product shows any defects within the specified warranty period that are not excluded from this warranty as described under § 5, BEHRINGER shall, at its discretion, either replace or repair the product using suitable new or reconditioned parts. In the case that other parts are used which constitute an improvement, BEHRINGER may, at its discretion, charge the customer for the additional cost of these parts.
2. If the warranty claim proves to be justified, the product will be returned to the user freight prepaid.
3. Warranty claims other than those indicated above are expressly excluded.

§ 4 RETURN AUTHORIZATION NUMBER

1. To obtain warranty service, the buyer (or his authorized dealer) must call BEHRINGER (see enclosed list) during normal business hours **BEFORE** returning the product. All inquiries must be accompanied by a description of the problem. BEHRINGER will then issue a return authorization number.
2. Subsequently, the product must be returned in its original shipping carton, together with the return authorization number to the address indicated by BEHRINGER.
3. Shipments without freight prepaid will not be accepted.

§ 5 WARRANTY REGULATIONS

1. Warranty services will be furnished only if the product is accompanied by a copy of the original retail dealer's invoice. Any product deemed eligible for repair or replacement under the terms of this warranty will be repaired or replaced.

2. If the product needs to be modified or adapted in order to comply with applicable technical or safety standards on a national or local level, in any country which is not the country for which the product was originally developed and manufactured, this modification/adaptation shall not be considered a defect in materials or workmanship. The warranty does not cover any such modification/adaptation, irrespective of whether it was carried out properly or not. Under the terms of this warranty, BEHRINGER shall not be held responsible for any cost resulting from such a modification/adaptation.

3. Free inspections and maintenance/repair work are expressly excluded from this warranty, in particular, if caused by improper handling of the product by the user. This also applies to defects caused by normal wear and tear, in particular, of faders, crossfaders, potentiometers, keys/buttons, tubes, guitar strings, illuminants and similar parts.

4. Damages/defects caused by the following conditions are not covered by this warranty:

- ▲ improper handling, neglect or failure to operate the unit in compliance with the instructions given in BEHRINGER user or service manuals.
- ▲ connection or operation of the unit in any way that does not comply with the technical or safety regulations applicable in the country where the product is used.
- ▲ damages/defects caused by force majeure or any other condition that is beyond the control of BEHRINGER.

5. Any repair or opening of the unit carried out by unauthorized personnel (user included) will void the warranty.

6. If an inspection of the product by BEHRINGER shows that the defect in question is not covered by the warranty, the inspection costs are payable by the customer.

7. Products which do not meet the terms of this warranty will be repaired exclusively at the buyer's expense. BEHRINGER will inform the buyer of any such circumstance. If the buyer fails to submit a written repair order within 6 weeks after notification, BEHRINGER will return the unit C.O.D. with a separate invoice for freight and packing. Such costs will also be invoiced separately when the buyer has sent in a written repair order.

§ 6 WARRANTY TRANSFERABILITY

This warranty is extended exclusively to the original buyer (customer of retail dealer) and is not transferable to anyone who may subsequently purchase this product. No other person (retail dealer, etc.) shall be entitled to give any warranty promise on behalf of BEHRINGER.

§ 7 CLAIM FOR DAMAGES

Failure of BEHRINGER to provide proper warranty service shall not entitle the buyer to claim (consequential) damages. In no event shall the liability of BEHRINGER exceed the invoiced value of the product.

* Customers in the European Union please contact BEHRINGER Germany Support for further details.

Technical specifications and appearance are subject to change without notice. The information contained herein is correct at the time of printing. All trademarks (except BEHRINGER, the BEHRINGER logo, JUST LISTEN and EUROLIVE) mentioned belong to their respective owners and are not affiliated with BEHRINGER. BEHRINGER accepts no liability for any loss which may be suffered by any person who relies either wholly or in part upon any description, photograph or statement contained herein. Colors and specifications may vary slightly from product. Products are sold through our authorized dealers only. Distributors and dealers are not agents of BEHRINGER and have absolutely no authority to bind BEHRINGER by any express or implied undertaking or representation. No part of this manual may be reproduced or transmitted in any form or by any means, electronic or mechanical, including photocopying and recording of any kind, for any purpose, without the express written permission of BEHRINGER International GmbH.

ALL RIGHTS RESERVED.

© 2008 BEHRINGER International GmbH, Hanns-Martin-Schleyer-Str. 36-38, 47877 Willich-Muencheide II, Germany, Tel. +49 2154 9206 0, Fax +49 2154 9206 4903

FEDERAL COMMUNICATIONS COMMISSION COMPLIANCE INFORMATION

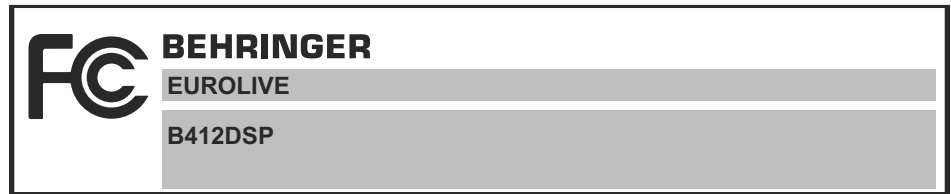

Responsible party name: **BEHRINGER USA, Inc.**

Address: **18912 North Creek Parkway, Suite 200
Bothell, WA 98011, USA**

Phone/Fax No.: **Phone: +1 425 672 0816,
Fax: +1 425 673 7647**

hereby declares that the product(s)



EUROLIVE B412DSP



complies/comply with the FCC rules as mentioned in the following paragraph:

This device complies with Part 15 of the FCC rules. Operation is subject to the following two conditions: (1) this device may not cause harmful interference, and (2) this device must accept any interference received, including interference that may cause undesired operation.

Note: This equipment has been tested and found to comply with the limits for a Class B digital device, pursuant to part 15 of the FCC Rules. These limits are designed to provide reasonable protection against harmful interference in a residential installation. This equipment generates, uses and can radiate radio frequency energy and, if not installed and used in accordance with the instructions, may cause harmful interference to radio communications. However, there is no guarantee that interference will not occur in a particular installation. If this equipment does cause harmful interference to radio or television reception, which can be determined by turning the equipment off and on, the user is encouraged to try to correct the interference by one or more of the following measures:

- ▲ Reorient or relocate the receiving antenna.
- ▲ Increase the separation between the equipment and receiver.
- ▲ Connect the equipment into an outlet on a circuit different from that to which the receiver is connected.
- ▲ Consult the dealer or an experienced radio/TV technician for help.

Important information:

Changes or modifications to the equipment not expressly approved by BEHRINGER USA can void the user's authority to use the equipment.

www.behringer.com



Free Manuals Download Website

<http://myh66.com>

<http://usermanuals.us>

<http://www.somanuals.com>

<http://www.4manuals.cc>

<http://www.manual-lib.com>

<http://www.404manual.com>

<http://www.luxmanual.com>

<http://aubethermostatmanual.com>

Golf course search by state

<http://golfingnear.com>

Email search by domain

<http://emailbydomain.com>

Auto manuals search

<http://auto.somanuals.com>

TV manuals search

<http://tv.somanuals.com>