

User Manual



XENYX 1204FX/1204

Premium 12-Input 2/2-Bus Mixer with Xenyx Mic Preamps,
British EQs, (1204FX: 24-Bit Multi-FX Processor) and
USB Audio Interface

Table of Contents

Thank you	2
Important Safety Instructions	3
Legal Disclaimer	3
Limited Warranty	3
1. Introduction	5
1.1 General mixing console functions	5
1.2 The user's manual.....	5
1.3 Before you get started.....	5
1.3.1 Shipment	5
1.3.2 Initial operation.....	5
1.3.3 Online registration.....	6
2. Control Elements and Connectors	6
2.1 Mono channels	6
2.1.1 Microphone and line inputs	6
2.1.2 Equalizer.....	6
2.1.3 Aux sends	6
2.1.4 Routing switch, solo and channel fader	7
2.2 Stereo channels.....	7
2.2.1 Channel inputs	7
2.2.2 Equalizer stereo channels	7
2.2.3 Aux sends stereo channels	7
2.2.4 Routing switch, solo and channel fader.....	7
2.3 Connector panel and main section	7
2.3.1 Aux sends 1 and 2	7
2.3.2 Aux send connectors 1 and 2	7
2.3.3 Stereo aux return connectors.....	8
2.3.4 Stereo aux return.....	8
2.3.5 Tape input / tape output	8
2.3.6 Level meter and monitoring	8
2.3.7 Alt 3-4 and main mix fader	9
2.4 Rear view of 1204FX/1204	9
2.4.1 Main mix outputs, Alt 3-4 outputs and Control room outputs.....	9
2.4.2 Voltage supply, phantom power and fuse.....	10
3. Digital Effects Processor	10
4. Installation	11
4.1 Rack mounting.....	11
4.2 Cable connections	11
4.2.1 Audio connections.....	11
5. Specifications.....	12

Thank you

Congratulations! In purchasing our XENYX 1204FX/1204 you have acquired a mixing console whose small size belies its incredible versatility and audio performance.

The BEHRINGER XENYX mixing console offers you premium-quality microphone preamplifiers with optional phantom power supply, balanced line inputs and the ability to connect external effects processors. Because of its extensive and carefully thought-out routing possibilities, your XENYX lends itself equally to both live and studio use.

EN Important Safety Instructions



Terminals marked with this symbol carry electrical current of sufficient magnitude to constitute risk of electric shock. Use only high-quality commercially-available speaker cables with ¼" TS plugs pre-installed. All other installation or modification should be performed only by qualified personnel.



This symbol, wherever it appears, alerts you to the presence of uninsulated dangerous voltage inside the enclosure - voltage that may be sufficient to constitute a risk of shock.



This symbol, wherever it appears, alerts you to important operating and maintenance instructions in the accompanying literature. Please read the manual.



Caution

To reduce the risk of electric shock, do not remove the top cover (or the rear section). No user serviceable parts inside. Refer servicing to qualified personnel.



Caution

To reduce the risk of fire or electric shock, do not expose this appliance to rain and moisture. The apparatus shall not be exposed to dripping or splashing liquids and no objects filled with liquids, such as vases, shall be placed on the apparatus.



Caution

These service instructions are for use by qualified service personnel only. To reduce the risk of electric shock do not perform any servicing other than that contained in the operation instructions. Repairs have to be performed by qualified service personnel.

1. Read these instructions.
2. Keep these instructions.
3. Heed all warnings.
4. Follow all instructions.
5. Do not use this apparatus near water.
6. Clean only with dry cloth.
7. Do not block any ventilation openings. Install in accordance with the manufacturer's instructions.
8. Do not install near any heat sources such as radiators, heat registers, stoves, or other apparatus (including amplifiers) that produce heat.

9. Do not defeat the safety purpose of the polarized or grounding-type plug. A polarized plug has two blades with one wider than the other. A grounding-type plug has two blades and a third grounding prong. The wide blade or the third prong are provided for your safety. If the provided plug does not fit into your outlet, consult an electrician for replacement of the obsolete outlet.

10. Protect the power cord from being walked on or pinched particularly at plugs, convenience receptacles, and the point where they exit from the apparatus.

11. Use only attachments/accessories specified by the manufacturer.



12. Use only with the cart, stand, tripod, bracket, or table specified by the manufacturer, or sold with the apparatus. When a cart is used, use caution when moving the cart/apparatus combination to avoid

injury from tip-over.

13. Unplug this apparatus during lightning storms or when unused for long periods of time.

14. Refer all servicing to qualified service personnel. Servicing is required when the apparatus has been damaged in any way, such as power supply cord or plug is damaged, liquid has been spilled or objects have fallen into the apparatus, the apparatus has been exposed to rain or moisture, does not operate normally, or has been dropped.

15. The apparatus shall be connected to a MAINS socket outlet with a protective earthing connection.

16. Where the MAINS plug or an appliance coupler is used as the disconnect device, the disconnect device shall remain readily operable.



Legal Disclaimer

Technical specifications and appearance are subject to change without notice. The information contained herein is correct at the time of printing. All trademarks are the property of their respective owners. MUSIC Group accepts no liability for any loss which may be suffered by any person who relies either wholly or in part upon any description, photograph or statement contained herein. Colors and specifications may vary slightly from product. BEHRINGER products are sold through authorized dealers only. Distributors and dealers are not agents of MUSIC Group and have absolutely no authority to bind MUSIC Group by any express or implied undertaking or representation. This manual is copyrighted. No part of this manual may be reproduced or transmitted in any form or by any means, electronic or mechanical, including photocopying and recording of any kind, for any purpose, without the express written permission of MUSIC Group IP Ltd.

ALL RIGHTS RESERVED.
© 2011 MUSIC Group IP Ltd.
Trident Chambers, Wickhams Cay, P.O. Box 146,
Road Town, Tortola, British Virgin Islands

Limited Warranty

§ 1 Warranty

1 This limited warranty is valid only if you purchased the product from a BEHRINGER authorized dealer in the country of purchase. A list of authorized dealers can be found on BEHRINGER's website behringer.com under "Where to Buy", or you can contact the BEHRINGER office closest to you.

2 MUSIC Group* warrants the mechanical and electronic components of this product to be free of defects in material and workmanship if used under normal operating conditions for a period of one (1) year from the original date of purchase (see the Limited Warranty terms in § 4 below), unless a longer minimum warranty period is mandated by applicable local laws. If the product shows any defects within the specified warranty period and that defect is not excluded under § 4, MUSIC Group shall, at its discretion, either replace or repair the product using suitable new or reconditioned product or parts. In case MUSIC Group decides to replace the entire product, this limited warranty shall apply to the replacement product for the remaining initial warranty period, i.e., one (1) year (or otherwise applicable minimum warranty period) from the date of purchase of the original product.

3 Upon validation of the warranty claim, the repaired or replacement product will be returned to the user freight prepaid by MUSIC Group.

4 Warranty claims other than those indicated above are expressly excluded.

PLEASE RETAIN YOUR SALES RECEIPT. IT IS YOUR PROOF OF PURCHASE COVERING YOUR LIMITED WARRANTY. THIS LIMITED WARRANTY IS VOID WITHOUT SUCH PROOF OF PURCHASE.

§ 2 Online registration

Please do remember to register your new BEHRINGER equipment right after your purchase at behringer.com under "Support" and kindly read the terms and conditions of our limited warranty carefully. Registering your purchase and equipment with us helps us process your repair claims quicker and more efficiently. Thank you for your cooperation!

§ 3 Return materials authorization

1 To obtain warranty service, please contact the retailer from whom the equipment was purchased. Should your BEHRINGER dealer not be located in your vicinity, you may contact the BEHRINGER distributor for your country listed under "Support" at behringer.com. If your country is not listed, please check if your problem can be dealt with by our "Online Support" which may also be found under "Support" at behringer.com. Alternatively, please submit an online warranty claim at behringer.com BEFORE returning the product. All inquiries must be accompanied by a description of the problem and the serial number of the product. After verifying the product's warranty eligibility with the original sales receipt, MUSIC Group will then issue a Return Materials Authorization ("RMA") number.

- ② Subsequently, the product must be returned in its original shipping carton, together with the return authorization number to the address indicated by MUSIC Group.
- ③ Shipments without freight prepaid will not be accepted.

§ 4 Warranty Exclusions

- ① This limited warranty does not cover consumable parts including, but not limited to, fuses and batteries. Where applicable, MUSIC Group warrants the valves or meters contained in the product to be free from defects in material and workmanship for a period of ninety (90) days from date of purchase.
- ② This limited warranty does not cover the product if it has been electronically or mechanically modified in any way. If the product needs to be modified or adapted in order to comply with applicable technical or safety standards on a national or local level, in any country which is not the country for which the product was originally developed and manufactured, this modification/adaptation shall not be considered a defect in materials or workmanship. This limited warranty does not cover any such modification/adaptation, regardless of whether it was carried out properly or not. Under the terms of this limited warranty, MUSIC Group shall not be held responsible for any cost resulting from such a modification/adaptation.
- ③ This limited warranty covers only the product hardware. It does not cover technical assistance for hardware or software usage and it does not cover any software products whether or not contained in the product. Any such software is provided "AS IS" unless expressly provided for in any enclosed software limited warranty.
- ④ This limited warranty is invalid if the factory-applied serial number has been altered or removed from the product.
- ⑤ Free inspections and maintenance/repair work are expressly excluded from this limited warranty, in particular, if caused by improper handling of the product by the user. This also applies to defects caused by normal wear and tear, in particular, of faders, crossfaders, potentiometers, keys/buttons, guitar strings, illuminants and similar parts.
- ⑥ Damage/defects caused by the following conditions are not covered by this limited warranty:
- improper handling, neglect or failure to operate the unit in compliance with the instructions given in BEHRINGER user or service manuals;
 - connection or operation of the unit in any way that does not comply with the technical or safety regulations applicable in the country where the product is used;
 - damage/defects caused by acts of God/Nature (accident, fire, flood, etc) or any other condition that is beyond the control of MUSIC Group.

- ⑦ Any repair or opening of the unit carried out by unauthorized personnel (user included) will void the limited warranty.
- ⑧ If an inspection of the product by MUSIC Group shows that the defect in question is not covered by the limited warranty, the inspection costs are payable by the customer.

⑨ Products which do not meet the terms of this limited warranty will be repaired exclusively at the buyer's expense. MUSIC Group or its authorized service center will inform the buyer of any such circumstance. If the buyer fails to submit a written repair order within 6 weeks after notification, MUSIC Group will return the unit C.O.D. with a separate invoice for freight and packing. Such costs will also be invoiced separately when the buyer has sent in a written repair order.

⑩ Authorized BEHRINGER dealers do not sell new products directly in online auctions. Purchases made through an online auction are on a "buyer beware" basis. Online auction confirmations or sales receipts are not accepted for warranty verification and MUSIC Group will not repair or replace any product purchased through an online auction.

§ 5 Warranty transferability

This limited warranty is extended exclusively to the original buyer (customer of authorized retail dealer) and is not transferable to anyone who may subsequently purchase this product. No other person (retail dealer, etc.) shall be entitled to give any warranty promise on behalf of MUSIC Group.

§ 6 Claim for damage

Subject only to the operation of mandatory applicable local laws, MUSIC Group shall have no liability to the buyer under this warranty for any consequential or indirect loss or damage of any kind. In no event shall the liability of MUSIC Group under this limited warranty exceed the invoiced value of the product.

§ 7 Limitation of liability

This limited warranty is the complete and exclusive warranty between you and MUSIC Group. It supersedes all other written or oral communications related to this product. MUSIC Group provides no other warranties for this product.

§ 8 Other warranty rights and national law

- ① This limited warranty does not exclude or limit the buyer's statutory rights as a consumer in any way.
- ② The limited warranty regulations mentioned herein are applicable unless they constitute an infringement of applicable mandatory local laws.
- ③ This warranty does not detract from the seller's obligations in regard to any lack of conformity of the product and any hidden defect.

§ 9 Amendment

Warranty service conditions are subject to change without notice. For the latest warranty terms and conditions and additional information regarding MUSIC Group's limited warranty, please see complete details online at behringer.com.

* MUSIC Group Macao Commercial Offshore Limited of Rue de Pequim No. 202-A, Macau Finance Centre 9/J, Macau, including all MUSIC Group companies

1. Introduction

The microphone channels feature high-end XENYX Mic Preamps that compare well with costly outboard preamps in terms of sound quality and dynamics and boast the following features:

- 130 dB dynamic range for an incredible amount of headroom
- A bandwidth ranging from below 10 Hz to over 200 kHz for crystal-clear reproduction of even the finest nuances
- The extremely low-noise and distortion-free circuitry guarantees absolutely natural and transparent signal reproduction
- They are perfectly matched to every conceivable microphone with up to 60 dB gain and +48 volt phantom power supply
- They enable you to use the greatly extended dynamic range of your 24-bit/192 kHz HD recorder to the full, thereby maintaining optimal audio quality

“British EQ”

The equalizers used for the XENYX Series are based on the legendary circuitry of top-notch consoles made in Britain, which are renowned throughout the world for their incredibly warm and musical sound character. Even with extreme gain settings these equalizers ensure outstanding audio properties.

Multi-effects processor

Additionally, your XENYX mixing console has an effects processor with 24-bit A/D and D/A converters included, which gives you 100 presets producing first-class reverb, delay and modulation effects plus numerous multi-effects in excellent audio quality.

The XENYX mixing consoles are equipped with a state-of-the-art switched-mode power supply (SMPS). Unlike conventional circuitry an SMPS provides an optimum supply current regardless of the input voltage. And thanks to its considerably higher efficiency a switched-mode power supply uses less energy than conventional power supplies.

USB/Audio interface

The USB interface supplied with the unit is a perfect match for the XENYX Series and serves as a powerful recording interface to your PC or MAC. It supports the digital transmission of signals on up to four channels with max. 48 kHz and extremely low latency. When wired to the CD/TAPE INPUT and OUTPUT connectors, the interface transfers the stereo mix from the console directly to a computer. Both the recording signal and the playback signal from the computer can be monitored at the same time. In this way, you can use several recording runs to produce complete multi-track recordings.



Caution!

- ◆ We should like to draw your attention to the fact that extreme volumes may damage your hearing and/or your headphones or loudspeakers. Turn the MAIN MIX faders and phones control in the main section fully down before you switch on the unit. Always be careful to set the appropriate volume.

1.1 General mixing console functions

A mixing console fulfils three main functions:

- **Signal processing:** Pre-amplification, level adjustment, mixing of effects, frequency equalization.
- **Signal distribution:** Summing of signals to the aux sends for effects processing and monitor mix, distribution to one or several recording tracks, power amp(s), control room and 2-track outputs.
- **Mix:** Setting the volume level, frequency distribution and positioning of the individual signals in the stereo field, level control of the total mix to match the recording devices/crossover/power amplifier(s). All other mixer functions can be included in this main function.

The interface of BEHRINGER mixing consoles is optimized for these tasks enabling you to easily keep track of the signal path.

1.2 The user's manual

The user's manual is designed to give you both an overview of the controls, as well as detailed information on how to use them. In order to help you understand the links between the controls, we have arranged them in groups according to their function. If you need to know more about specific issues, please visit our website at <http://behringer.com>, where you'll find explanations of e.g. effects and dynamics applications.

- ◆ The block diagram supplied with the mixing console gives you an overview of the connections between the inputs and outputs, as well as the associated switches and controls.

For the moment, just try and trace the signal path from the microphone input to the aux send 1 connector. Don't be put off by the huge range of possibilities; it's easier than you think! If you look at the overview of the controls at the same time, you'll be able to quickly familiarize yourself with your mixing console and you'll soon be making the most of all its many possibilities.

1.3 Before you get started

1.3.1 Shipment

Your mixing console was carefully packed in the factory to guarantee safe transport. Nevertheless, we recommend that you carefully examine the packaging and its contents for any signs of physical damage, which may have occurred during transit.

- ◆ If the unit is damaged, please do NOT return it to us, but notify your dealer and the shipping company immediately, otherwise claims for damage or replacement may not be granted.

1.3.2 Initial operation

Be sure that there is enough space around the unit for cooling purposes and to avoid over-heating please do not place your mixing console on high-temperature devices such as radiators or power amps. The console is connected to the mains via the supplied cable. The console meets the required safety standards. Blown fuses must only be replaced by fuses of the same type and rating.

- ◆ Please note that all units must be properly grounded. For your own safety, you should never remove any ground connectors from electrical devices or power cables, or render them inoperative.
- ◆ Please ensure that only qualified people install and operate the mixing console. During installation and operation, the user must have sufficient electrical contact to earth, otherwise electrostatic discharges might affect the operation of the unit.

1.3.3 Online registration

Please register your new BEHRINGER equipment right after your purchase by visiting <http://behringer.com> and read the terms and conditions of our warranty carefully.

Should your BEHRINGER product malfunction, it is our intention to have it repaired as quickly as possible. To arrange for warranty service, please contact the BEHRINGER retailer from whom the equipment was purchased. Should your BEHRINGER dealer not be located in your vicinity, you may directly contact one of our subsidiaries. Corresponding contact information is included in the original equipment packaging (Global Contact Information/European Contact Information). Should your country not be listed, please contact the distributor nearest you. A list of distributors can be found in the support area of our website (<http://behringer.com>).

Registering your purchase and equipment with us helps us process your repair claims more quickly and efficiently.

Thank you for your cooperation!

2. Control Elements and Connectors

This chapter describes the various control elements of your mixing console. All controls, switches and connectors will be discussed in detail.

2.1 Mono channels

2.1.1 Microphone and line inputs

MIC

Each mono input channel offers a balanced microphone input via the XLR connector and also features switchable +48 V phantom power supply for condenser microphones. The XENYX preamps provide undistorted and noise-free gain as is typically known only from costly outboard preamps.

- ◆ Please mute your playback system before you activate the phantom power supply to prevent switch-on thumps being directed to your loudspeakers. Please also note the instructions in chapter 2.4.2 "Voltage supply, phantom power and fuse".

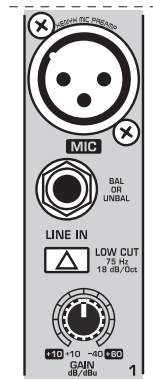

Fig. 2.1: Connectors and controls of mic/line inputs

LINE IN

Each mono input also features a balanced line input on a 1/4" connector. Unbalanced devices (mono jacks) can also be connected to these inputs.

- ◆ Please remember that you can only use either the microphone or the line input of a channel at any one time. You can never use both simultaneously!

LOW CUT

The mono channels of the mixing consoles have a high-slope **LOW CUT** filter for eliminating unwanted, low-frequency signal components (75 Hz, 18 dB/octave).

GAIN

Use the **GAIN** control to adjust the input gain. This control should always be turned fully counterclockwise whenever you connect or disconnect a signal source to one of the inputs.

2.1.2 Equalizer

All mono input channels include a 3-band equalizer. All bands provide boost or cut of up to 15 dB. In the central position, the equalizer is inactive.

The circuitry of the British EQs is based on the technology used in the best-known top-of-the-line consoles and providing a warm sound without any unwanted side effects. The result are extremely musical equalizers which, unlike simple equalizers, cause no side effects such as phase shifting or bandwidth limitation, even with extreme gain settings of ± 15 dB.

The upper (HI) and the lower band (LO) are shelving filters that increase or decrease all frequencies above or below their cut-off frequency. The cut-off frequencies of the upper and lower band are 12 kHz and 80 Hz respectively. The mid band is configured as a peak filter with a center frequency of 2.5 kHz.

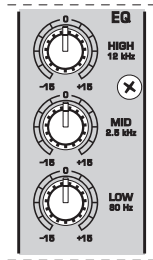

Fig. 2.2: The equalizer of the input channels

2.1.3 Aux sends

Aux sends take signals via a control from one or more channels and sum these signals to a so-called bus. This bus signal is sent to an aux send connector and then routed, for example, to an active monitor speaker or an external effects device. The return from an external effect can then be brought back into the console via the aux return connectors.

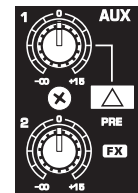

Fig. 2.3: The AUX SEND controls in the channel strips

For situations which require effects processing, the aux sends are usually switched post-fader so that the effects volume in a channel corresponds to the position of the channel fader. If this were not the case, the effects signal of the channel would remain audible even when the fader is turned to zero. When setting up a monitor mix, the aux sends are generally switched to pre-fader; i.e. they operate independently of the position of the channel fader.

Both aux sends are mono, are sourced after the equalizer and offer up to +15 dB gain.

- ◆ If you press the MUTE/ALT 3-4 switch, aux send 1 is muted, provided that it is switched post-fader. However, this does not affect the aux send 2 of the 1204FX.

AUX 1 (MON)

In the 1204FX, aux send 1 can be switched pre-fader and is thus particularly suitable for setting up monitor mixes. In the 1204, the first aux send is labeled **MON** and is permanently switched pre-fader.

PRE

When the **PRE** switch is pressed, aux send 1 is sourced pre-fader.

AUX 2 (FX)

The aux send labeled **FX** is for sending to effects devices and is thus set up to be post-fader.

In the 1204FX, the FX send is routed directly to the built-in effects processor.

- ◆ If you wish to use the internal effects processor, the STEREO AUX RETURN 2 connectors should not be in use.
- ◆ 1204FX: you can also connect an external effects processor to aux send 2, however the internal effects module will be muted.

2.1.4 Routing switch, solo and channel fader

PAN

The **PAN** control determines the position of the channel signal within the stereo image. This control features a constant-power characteristic, which means the signal is always maintained at a constant level, irrespective of position in the stereo panorama.

MUTE/ALT 3-4

You can use the **MUTE/ALT 3-4** switch to divert the channel from the main mix bus to the Alt 3-4 bus. This mutes the channel from the main mix.

MUTE-LED

The **MUTE** LED indicates that the relevant channel is diverted to the submix (Alt 3-4 bus).

CLIP-LED

The **CLIP** LED lights up when the input signal is driven too high. In this case, turn down the GAIN control and, if necessary, check the setting of the channel EQ.

SOLO

The **SOLO** switch (1204FX only) is used to route the channel signal to the solo bus (Solo In Place) or to the PFL bus (Pre Fader Listen). This enables you to monitor a channel signal without affecting the main output signal. The signal you hear is sourced either before (PFL, mono) or after (solo, stereo) both the pan control and the channel fader (see chapter 2.3.6 "Level meters and monitoring").

The channel fader determines the level of the channel signal in the main mix (or submix).

2.2 Stereo channels

2.2.1 Channel inputs

Each stereo channel has two balanced line level inputs on ¼" connectors for left and right channels. If only the connector marked "L" is used, the channel operates in mono. Stereo channels are designed to handle typical line level signals.

Both inputs can also be used with unbalanced jacks.

LEVEL

For level matching, the stereo inputs feature a **LEVEL** switch which selects between +4 dBu and -10 dBV. At -10 dBV (home-recording level), the input is more sensitive than at +4 dBu (studio level).

2.2.2 Equalizer stereo channels

The equalizer of the stereo channels is, of course, stereo. The filter characteristics and crossover frequencies are the same as those of the mono channels. A stereo equalizer is always preferable to two mono equalizers if frequency correction of a stereo signal is needed. There is often a discrepancy between the settings of the left and the right channels when using separate equalizers.

2.2.3 Aux sends stereo channels

In principle, the aux sends of the stereo channels function in just the same way as those of the mono channels. As aux send paths are always mono, the signal on a stereo channel is first summed to mono before it reaches the aux bus.

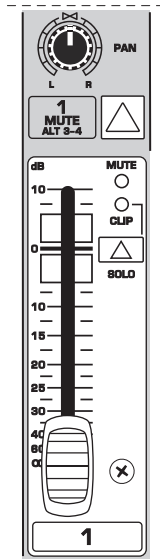

Fig. 2.4: Panorama and routing controls

2.2.4 Routing switch, solo and channel fader

BAL

The function of the **BAL**(ANCE) control corresponds to the PAN control in the mono channels.

The balance control determines the relative proportion between the left and right input signals before both signals are routed to the main stereo mix bus.

The MUTE/ALT 3-4 switch, the MUTE-LED, the CLIP-LED, the SOLO switch and the channel fader function in the same way as the mono channels.

2.3 Connector panel and main section

Whereas it was useful to trace the signal flow from top to bottom in order to gain an understanding of the channel strips, we now look at the mixing console from left to right. The signals are, so to speak, collected from the same point on each of the channel strips and then routed to the main section all together.

2.3.1 Aux sends 1 and 2

A channel signal is routed to aux send bus 1 if the AUX 1 control is turned up on the corresponding channel.

AUX SEND 1 (MON)

The AUX SEND control **MON** acts as master control for aux send 1 and determines the level of the summed signal. In the 1204FX, the MON control is called AUX SEND 1.

AUX SEND 2 (FX)

Similarly, the **FX** control (AUX SEND 2) determines the level for aux send 2.

SOLO

You can use the SOLO switch (1204FX only) to separately monitor the aux sends via the CONTROL ROOM/PHONES outputs and check these with the level meters.

♦ If you want to monitor the signal of just one AUX bus, none of the other SOLO SWITCHES should be pressed and the MODE switch must be in the SOLO position (not pressed down).

2.3.2 Aux send connectors 1 and 2

AUX SEND 1

If you use aux send 1 pre-fader, you would usually connect the **AUX SEND 1** connector to monitors via a power amp (or an active monitor system). If you use aux send 1 post-fader, proceed as described under aux send 2.

AUX SEND 2

The **AUX SEND 2** connector outputs the signal you picked up from the individual channels using the FX control. You can connect this to the input of an effects device in order to process the FX bus signal. Once an effects mix is created, the processed signal can then be routed from the effects device output back into the STEREO AUX RETURN connectors.

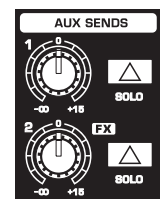

Fig. 2.6: AUX SEND controls of the main section

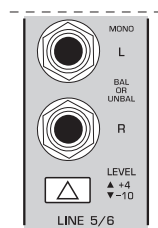

Fig. 2.5: Stereo channel inputs and LEVEL switch

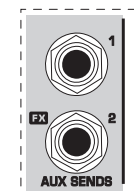

Fig. 2.7: Aux send connectors

2.3.3 Stereo aux return connectors

STEREO AUX RETURN 1

The **STEREO AUX RETURN 1** connectors generally serve as the return path for the effects mix generated using the post-fader aux send. This is where you connect the output signal of the external effects device. If only the left connector is used, the AUX RETURN automatically operates in mono.

- ◆ You can also use these connectors as additional line inputs.

STEREO AUX RETURN 2

The **STEREO AUX RETURN 2** connectors serve as the return path for the effects mix generated using the FX control. If these connectors already function as additional inputs, you can route the effects signal back into the console via a different channel, with the added benefit that the channel EQ can be used to adjust the frequency response of the effects return signal.

- ◆ In this instance, the FX control of the channel being used as an effects return should be turned fully counterclockwise, otherwise feedback problems could occur!
- ◆ If you wish to use the internal effects processor, no connectors should be plugged into STEREO AUX RETURN 2.

2.3.4 Stereo aux return

STEREO AUX RETURN 1

STEREO AUX RETURN 1 is a stereo control which determines the level of the signal in the main mix. If STEREO AUX RETURN 1 is used as effects return, you can add the effects signal to any "dry" channel signal.

- ◆ In this instance, the effects device should be set at 100% effect.

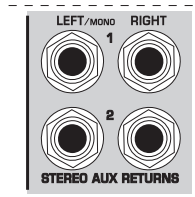

Fig. 2.8: Stereo aux return connectors

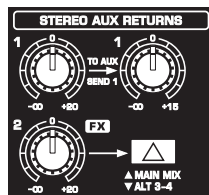

Fig. 2.9: Stereo aux return controls

STEREO AUX RETURN MON

The **STEREO AUX RETURN MON** control has a special function: it can be used to add an effect to a monitor mix. For example:

Monitor mix with effect

In this instance, the effects device should be set up as follows: AUX SEND 2 is connected to the L/Mono input of your effects device, while its outputs are connected to STEREO AUX RETURN 1. Connect the amplifier of your monitor system to AUX SEND 1. The AUX SEND 1 master control determines the volume of the monitor mix.

You can now use the STEREO AUX RETURN MON control to adjust the level of the effects signal routed to the monitor mix.

You can easily use the headphones distribution amplifier BEHRINGER POWERPLAY PRO HA4600/HA4700/HA8000 to provide you with four (or eight with the HA8000) stereo headphone mixes for your studio.

STEREO AUX RETURN 2 (FX)

The STEREO AUX RETURN 2 control determines the level of signals fed into the AUX RETURN 2 connectors which are routed to the main mix.

MAIN MIX/ALT 3-4

The MAIN MIX/ALT 3-4 switch routes the signal connected to STEREO AUX RETURN 2 to either main mix (not pressed) or submix (Alt 3-4, pressed).

2.3.5 Tape input / tape output

CD/TAPE INPUT

The **CD/TAPE INPUT** RCA connectors are provided for connecting a 2 track machine (e.g. DAT recorder). They can also be used as stereo line input. Alternatively, the output signal of a second XENYX or BEHRINGER ULTRALINK PRO MX882 can also be connected. If you connect a hi-fi amplifier with a source selection switch to the CD/TAPE INPUT, you can easily switch between additional sources (e.g. cassette recorder, CD player, etc.).

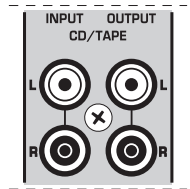

Fig. 2.10: 2-track connectors

CD/TAPE OUTPUT

These connectors are wired in parallel with the MAIN OUT and carry the main mix signal (unbalanced). Connect the **CD/TAPE OUTPUT** to the inputs of your recording device. The final output level can be adjusted via the high-precision MAIN MIX fader.

- ◆ If you connect a compressor or a noise gate after the 2-track output, the faders will probably not be able to create a satisfactory fade-out effect.

2.3.6 Level meter and monitoring

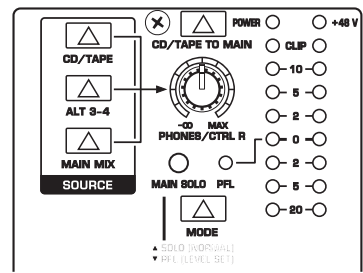

Fig. 2.11: Control room/phones section, level meter

CD/TAPE

The **TAPE** switch routes the signal from the TAPE IN connectors to the level meter, the CONTROL ROOM OUT outputs and the PHONES connector this is a simple way to check recorded signals via monitor speakers or headphones.

ALT 3-4

Similarly, the **ALT 3-4** switch routes the signal from the Alt 3-4 bus to the same path for monitoring purposes.

MAIN MIX

The **MAIN MIX** switch sends the main mix signal to the above-mentioned outputs and to the level meter.

PHONES/CTRL R(oom)

Use this control to set control room output level and head-phones volume respectively.

CD/TAPE TO MAIN

When the **CD/TAPE TO MAIN** switch is depressed, the 2-track input is routed to the main mix and thus serves as an additional input for tape machines. You can also connect MIDI instruments or other signal sources here that do not require any further processing. At the same time, this switch disables the main mix to tape output link.

POWER

The blue **POWER** LED indicates that the device is switched on.

+48 V

The red **+48 V** LED lights up when the phantom power supply is switched on. The phantom power supply is necessary for condenser microphones and is activated using the switch on the rear of the device.

- ◆ Please do not connect microphones to the mixer (or the stagebox/wallbox) while the phantom power supply is switched on. Connect microphones before you switch on the power supply. In addition, the monitor/PA loudspeakers should be muted before you activate the phantom power supply. After switching on, wait approx. one minute to allow for system stabilization.

LEVEL METER

The high-precision level meter accurately displays the appropriate signal level.

LEVEL SETTING:

When recording to a digital device, the recorder's peak meter should not exceed 0 dB. This is because, unlike analog recordings, slightly excessive levels can create unpleasant digital distortion.

When recording to an analog device, the VU meters of the recording machine should reach approx. +3 dB with low-frequency signals (e.g. kick drum). Due to their inertia VU meters tend to display too low a signal level at frequencies above 1 kHz. This is why, for example, a Hi-Hat should only be driven as far as -10 dB. Snare drums should be driven to approx. 0 dB.

- ◆ The peak meters of your XENYX display the level virtually independent of frequency. A recording level of 0 dB is recommended for all signal types.

MODE (1204FX only)

The **MODE** switch determines whether the channels' **SOLO** switch operates as PFL (Pre Fader Listen) or as solo (Solo In Place).

PFL

To activate the PFL function, depress the **MODE** switch. The PFL function should, as a rule, be used for gain setting purposes. The signal is sourced pre-fader and assigned to the mono PFL bus. In the "PFL" setting, only the left side of the peak meter operates. Drive the individual channels to the 0 dB mark of the VU meter.

Solo

When the **MODE** switch is not depressed, the stereo solo bus is active. Solo is short for "Solo In Place". This is the customary method for listening to an individual signal or to a group of signals. As soon as a solo switch is pressed, all channels in the control room (and headphones) that have not been selected are muted thereby retaining stereo panning. The solo bus can carry the output signals of the channel pan controls, the aux sends and the stereo line inputs. The solo bus is, as a rule, switched post-fader.

- ◆ The **PAN** control in the channel strip offers a constant power characteristic. This means that the signal is always at a constant level, irrespective of its position in the stereo panorama. If the **PAN** control is moved fully left or right from center, the level increases by 4 dB in that channel. This ensures that, when set in the center, the audio signal is not louder. For this reason, with the solo function activated (Solo in Place), audio signals from the channels with **PAN** controls that have not been moved fully to the left or right are displayed at a lower volume than in the PFL function.

As a rule, solo signals are monitored via the control room outputs and headphones connector and are displayed by the level meters. If a solo switch is pressed, the signals from the tape input, Alt 3-4 and main mix are blocked from the control room outputs, the headphone connector and the level meter.

MAIN SOLO (1204FX only)

The **MAIN SOLO** LED lights up as soon as a channel or aux send solo switch is pressed. The **MODE** switch also has to be set at "Solo".

PFL (1204FX only)

The **PFL** LED indicates that the peak meter is set to PFL mode.

PHONES

You can connect headphones to this ¼" TRS connector. The signal on the **PHONES** connection is sourced from the control room output.

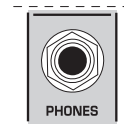

Fig. 2.12: PHONES connector

2.3.7 Alt 3-4 and main mix fader

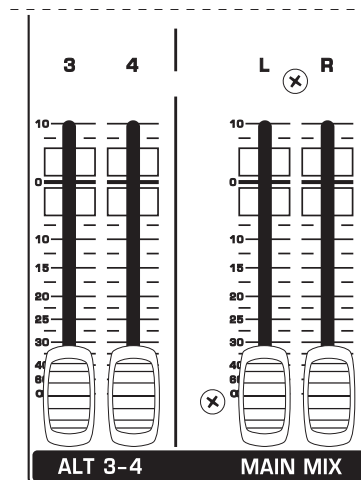

Fig. 2.13: Alt 3-4 and main mix fader

Use the high-precision quality faders to control the output level of the Alt 3-4 subgroup and main mix.

2.4 Rear view of 1204FX/1204

2.4.1 Main mix outputs, Alt 3-4 outputs and control room outputs

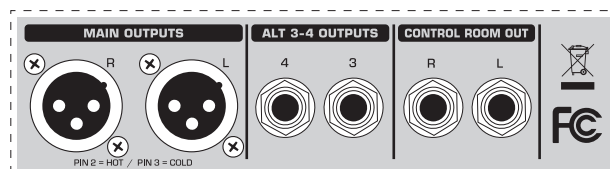

Fig. 2.14: Main mix outputs, Alt 3-4 outputs and control room outputs

MAIN OUTPUTS

The **MAIN** outputs carry the MAIN MIX signal and are on balanced XLR connectors with a nominal level of +4 dBu.

ALT 3-4 OUTPUTS

The **ALT 3-4** outputs are unbalanced and carry the signals of the channels that you have assigned to this group using the MUTE switch. This can be used to route a subgroup to a further mixing console for example, or it could be used as a recording output working in tandem with the main output. This means you could record to four tracks simultaneously. The icing on the cake, so to speak, is that you could connect Y-cables to these four outputs and then connect your 8-track recorder in such a way that you have 2 x 4 tracks (e.g. channel 1 feeds track 1 and track 2, etc.). In the first recording pass, you record on tracks 1, 3, 5 and 7 and in the second pass, on tracks 2, 4, 6 and 8.

CONTROL ROOM OUTPUTS

The control room output is normally connected to the monitor system in the control room and provides the stereo mix or, when required, the solo signal.

2.4.2 Voltage supply, phantom power and fuse

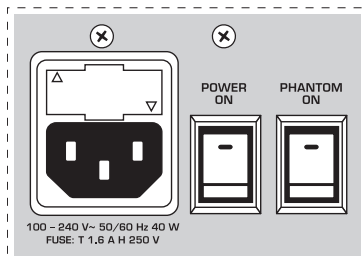

Fig. 2.15: Voltage supply and fuse

FUSE HOLDER

The console is connected to the mains via the cable supplied which meets the required safety standards. Blown fuses must only be replaced by fuses of the same type and rating.

IEC MAINS RECEPTACLE

The mains connection is via a cable with IEC mains connector. An appropriate mains cable is supplied with the equipment.

POWER

Use the **POWER** switch to power up the mixing console.

PHANTOM

The **PHANTOM** switch activates the phantom power supply for the XLR connectors of the mono channels which is required to operate condenser microphones. The red +48 V LED lights up when phantom power is on. As a rule, dynamic microphones can still be used with phantom power switched on, provided that they are wired in a balanced configuration. In case of doubt, contact the microphone manufacturer!

- ◆ After the phantom power supply has been switched on, do not connect microphones to the mixer (or the stagebox/wallbox). Connect the microphones before you switch phantom power on. In addition, the monitor/PA loudspeakers should be muted before activating the phantom power supply. After switching on, wait approx. one minute to allow the system to stabilize.

- ◆ **Caution!** You must never use unbalanced XLR connectors (PIN 1 and 3 connected) on the MIC input connectors if you want to use the phantom power supply.

SERIAL NUMBER

Please note the important information on the serial number given in chapter 1.3.3.

3. Digital Effects Processor

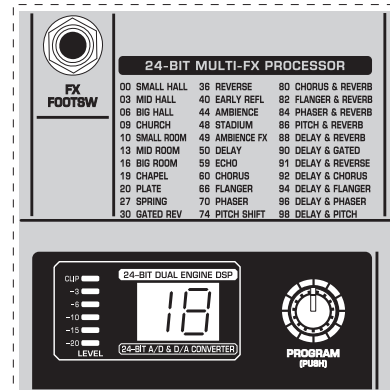

Fig. 3.1: Digital effects module (only 1204FX)

24-BIT MULTI-EFFECTS PROCESSOR

Here you can find a list of all presets stored in the multi-effects processor. This built-in effects module produces high-grade standard effects such as reverb, chorus, flanger, delay and various combination effects. The integrated effects module has the advantage of requiring no wiring. This way, the danger of creating ground loops or uneven signal levels is eliminated at the outset, completely simplifying the handling.

These effect presets are designed to be added to dry signals. If you move the FX TO MAIN control, you mix the channel signal (dry) and the effect signal.

This also goes for mixing effects signals with the monitor mix. The main difference is that the mix ratio is adjusted using the FX TO MON control. Of course, a signal has to be fed into the effects processor via the FX control in the channel strip for both applications.

- ◆ On the following page, you will find an illustration showing how to connect your foot switch correctly.

LEVEL

The LED level meter on the effects module should display a sufficiently high level. Take care to ensure that the clip LED only lights up at peak levels. If it is lit constantly, you are overloading the effects processor and this could cause unpleasant distortion. The FX control (AUX SEND 2) determines the level that reaches the effects module.

PROGRAM

You can select the effect preset by turning the **PROGRAM** control. The display flashes the number of the current preset. To recall the selected preset, press the button; the flashing stops. You can also recall the selected preset with the foot switch.

4. Installation

4.1 Rack mounting

The packaging of your mixing console contains two 19" rack mount wings which can be installed on the side panels of the console.

Before you can attach the rack mount wings to the mixing console, you need to remove the screws holding the left and right side panels. Use these screws to fasten the two wings onto the console, being careful to note that each wing fits a specific side. With the rack mount wings installed, you can mount the mixing console in a commercially available 19" rack. Be sure to allow for proper air flow around the unit, and do not place the mixing console close to radiators or power amps, so as to avoid overheating.

- ◆ Only use the screws holding the mixing console side panels to fasten the 19" rack mounts.

4.2 Cable connections

You will need a large number of cables for the various connections to and from the console. The illustrations below show the wiring of these cables. Be sure to use only high-grade cables.

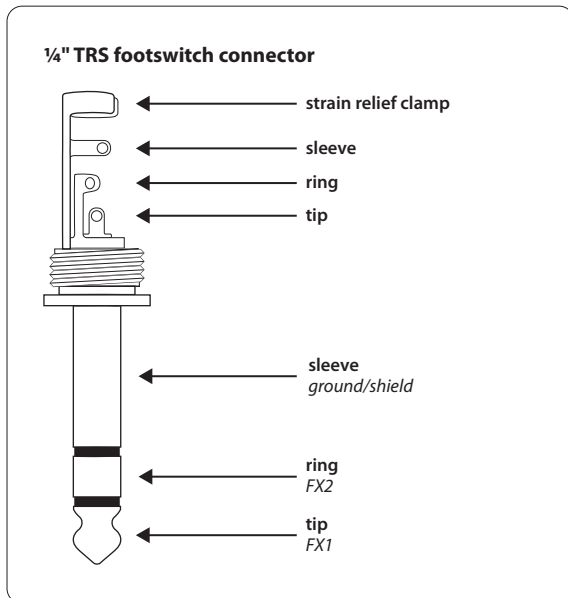

Fig. 4.1: 1/4" TS connector for foot switch

4.2.1 Audio connections

Please use commercial RCA cables to wire the 2-track inputs and outputs.

You can, of course, also connect unbalanced devices to the balanced input/outputs. Use either mono plugs, or ensure that ring and sleeve are bridged inside the stereo plug (or pins 1 & 3 in the case of XLR connectors).

- ◆ **Caution!** You must never use unbalanced XLR connectors (pin 1 and 3 connected) on the MIC inputs if you intend to use the phantom power supply.

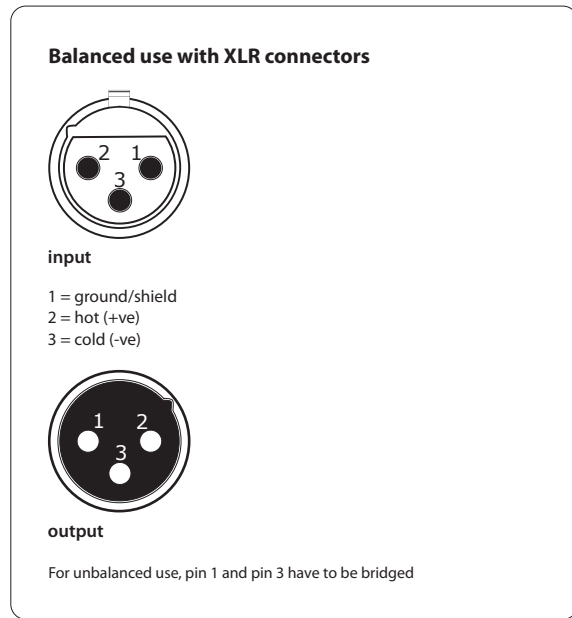

Fig. 4.2: XLR connections

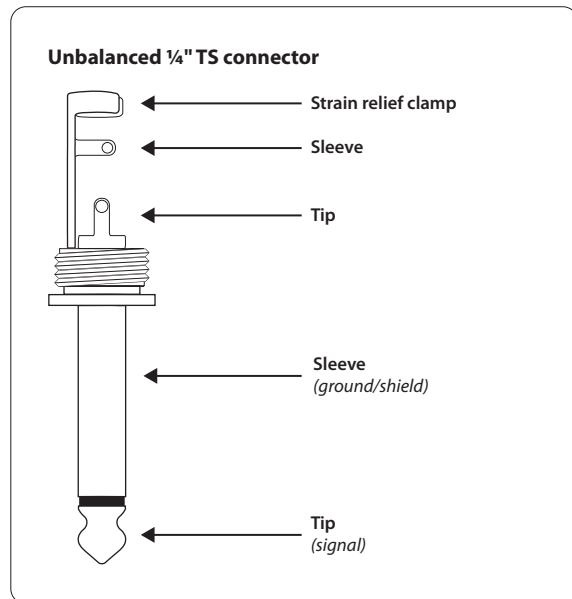

Fig. 4.3: 1/4" TS connector

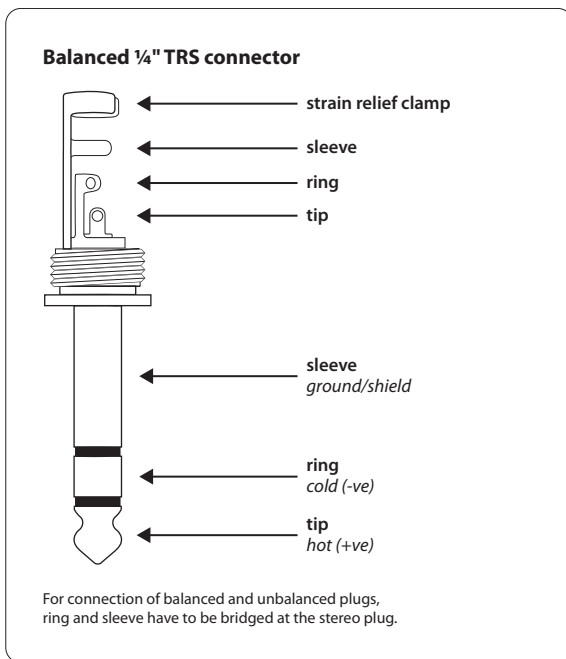

Fig. 4.4: ¼" TRS connector

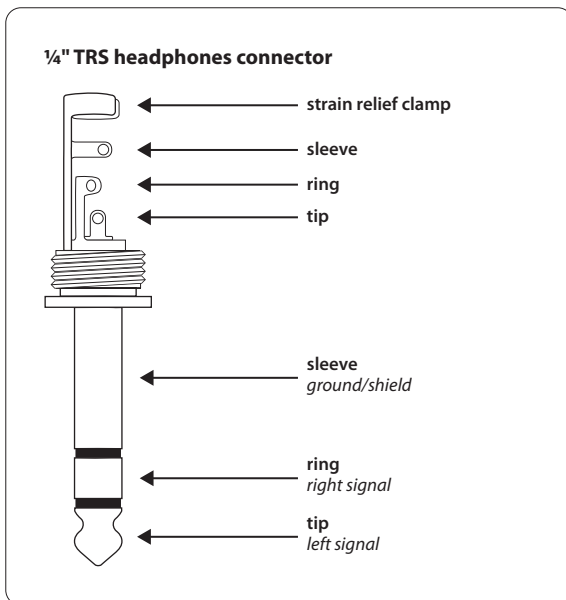

Fig. 4.5: ¼" TRS connector for headphones

5. Specifications

Mono Inputs

Microphone inputs (XENYX Mic Preamp)

Type	XLR, electronically balanced, discrete input circuit
------	---

Mic E.I.N. (20 Hz - 20 kHz)

@ 0 Ω source resistance	-134 dB / 135.7 dB A-weighted
--------------------------------	-------------------------------

@ 50 Ω source resistance	-131 dB / 133.3 dB A-weighted
---------------------------------	-------------------------------

@ 150 Ω source resistance	-129 dB / 130.5 dB A-weighted
----------------------------------	-------------------------------

Frequency response	<10 Hz - 150 kHz (-1 dB), <10 Hz - 200 kHz (-3 dB)
--------------------	---

Gain range	+10 to +60 dB
------------	---------------

Max. input level	+12 dBu @ +10 dB gain
------------------	-----------------------

Impedance	approx. 2.6 k Ω balanced
-----------	---------------------------------

Signal-to-noise ratio	110 dB / 112 dB A-weighted (0 dBu In @ +22 dB gain)
-----------------------	--

Distortion (THD+N)	0.005% / 0.004% A-weighted
--------------------	----------------------------

Line input

Type	¼" TRS connector electronically balanced
------	--

Impedance	approx. 20 k Ω balanced 10 k Ω unbalanced
-----------	--

Gain range	-10 to +40 dB
------------	---------------

Max. input level	30 dBu
------------------	--------

Fade-out attenuation¹ (Crosstalk attenuation)

Main fader closed	90 dB
-------------------	-------

Channel muted	89.5 dB
---------------	---------

Channel fader closed	89 dB
----------------------	-------

Frequency Response

Microphone input to main out

<10 Hz - 90 kHz	+0 dB / -1 dB
-----------------	---------------

<10 Hz - 160 kHz	+0 dB / -3 dB
------------------	---------------

Stereo inputs

Type	¼" TRS connector, electronically balanced
------	---

Impedance	approx. 20 k Ω
-----------	-----------------------

Max. input level	+22 dBu
------------------	---------

EQ mono channels

Low	80 Hz / \pm 15 dB
-----	---------------------

Mid	2.5 kHz / \pm 15 dB
-----	-----------------------

High	12 kHz / \pm 15 dB
------	----------------------

EQ stereo channels

Low	80 Hz / ± 15 dB
Mid	2.5 kHz / ± 15 dB
High	12 kHz / ± 15 dB

Aux sends

Type	1/4" TS connector, unbalanced
Impedance	approx. 120 Ω
Max. output level	+22 dBu

Stereo aux returns

Type	1/4" TRS connector, electronically balanced
Impedance	approx. 20 k Ω bal. / 10 k Ω unbalanced
Max. input level	+22 dBu

Main outputs

Type	XLR, electronically balanced
Impedance	approx. 240 Ω bal. / 120 Ω unbalanced
Max. output level	+28 dBu

Control room outputs

Type	1/4" TS connector, unbalanced
Impedance	approx. 120 Ω
Max. output level	+22 dBu

Headphones output

Type	1/4" TRS connector, unbalanced
Max. output level	+19 dBu / 150 Ω (+25 dBm)
DSP	24-bit Texas Instruments
Converter	24-bit Sigma-Delta, 64/128-times oversampling
Sampling rate	40 kHz

Main Mix System Data²**Noise**

Main mix @ $-\infty$, Channel fader $-\infty$	-105 dB / -108 dB A-weighted
Main mix @ 0 dB, Channel fader $-\infty$	-95 dB / -97 dB A-weighted
Main Mix @ 0 dB, Channel fader @ 0 dB	-82,5 dB / -85 dB A-weighted

Power supply

Mains voltage	100 - 240 V~, 50/60 Hz
Power consumption	40 W
Fuse	100 - 240 V~: T 1.6 A H 250 V
Mains connection	Standard IEC receptacle

Physical**1204FX**

Dimensions (H x W x D)	approx. 3 7/8 x 9 11/16 x 13 5/32" approx. 97 x 247 x 334 mm
Weight (net)	approx. 5 3/4 lbs / 2.60 kg

1204

Dimensions (H x W x D)	approx. 3 7/8 x 9 11/16 x 13" approx. 97 x 247 x 328 mm
Weight (net)	approx. 5 5/8 lbs / 2.56 kg

Measuring conditions:

1: 1 kHz rel. to 0 dBu; 20 Hz - 20 kHz; line input; main output; unity gain.

2: 20 Hz - 20kHz; measured at main output. Channels 1 - 4 unity gain; EQ flat; all channels on main mix; channels 1/3 as far left as possible, channels 2/4 as far right as possible. Reference = +6 dBu.

BEHRINGER is constantly striving to maintain the highest professional standards. As a result of these efforts, modifications may be made from time to time to existing products without prior notice. Specifications and appearance may differ from those listed or illustrated.

FEDERAL COMMUNICATIONS COMMISSION COMPLIANCE INFORMATION



Responsible party name: **MUSIC Group Services USA, Inc.**
Address: **18912 North Creek Parkway,
Suite 200 Bothell, WA 98011,
USA**
Phone/Fax No.: **Phone: +1 425 672 0816
Fax: +1 425 673 7647**

XENYX 1204FX/1204

complies with the FCC rules as mentioned in the following paragraph:

This equipment has been tested and found to comply with the limits for a Class B digital device, pursuant to part 15 of the FCC Rules. These limits are designed to provide reasonable protection against harmful interference in a residential installation. This equipment generates, uses and can radiate radio frequency energy and, if not installed and used in accordance with the instructions, may cause harmful interference to radio communications. However, there is no guarantee that interference will not occur in a particular installation. If this equipment does cause harmful interference to radio or television reception, which can be determined by turning the equipment off and on, the user is encouraged to try to correct the interference by one or more of the following measures:

- Reorient or relocate the receiving antenna.
- Increase the separation between the equipment and receiver.
- Connect the equipment into an outlet on a circuit different from that to which the receiver is connected.
- Consult the dealer or an experienced radio/TV technician for help.

This device complies with Part 15 of the FCC rules. Operation is subject to the following two conditions:

- (1) this device may not cause harmful interference, and
- (2) this device must accept any interference received, including interference that may cause undesired operation.

Important information:

Changes or modifications to the equipment not expressly approved by MUSIC Group can void the user's authority to use the equipment.



We Hear You

Free Manuals Download Website

<http://myh66.com>

<http://usermanuals.us>

<http://www.somanuals.com>

<http://www.4manuals.cc>

<http://www.manual-lib.com>

<http://www.404manual.com>

<http://www.luxmanual.com>

<http://aubethermostatmanual.com>

Golf course search by state

<http://golfingnear.com>

Email search by domain

<http://emailbydomain.com>

Auto manuals search

<http://auto.somanuals.com>

TV manuals search

<http://tv.somanuals.com>