

# FEEDBACK DESTROYER<sup>®</sup> PRO DSP1100P

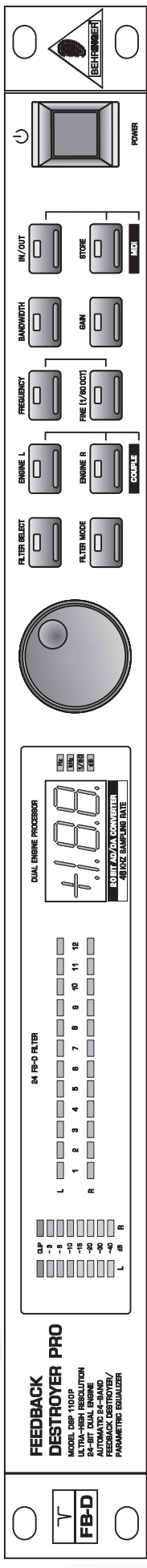

## User's Manual Bedienungsanleitung



Version 1.0 October 1998





## EG-Declaration of Conformity



Spezielle Studiotechnik GmbH

### acc. to the Directives 89/336/EWG and 73/23/EWG

We,

**BEHRINGER INTERNATIONAL GmbH**

**Hanns-Martin-Schleyer-Straße 4**

**D - 47877 Willich**

Name and address of the manufacturer or the introducer of the product on the market who is established in the EC

herewith take the sole responsibility to confirm that the product:

**FEEDBACK DESTROYER PRO DSP1100P**

Type designation and, if applicable, Article-N°

which refers to this declaration, is in accordance with the following standards or standardized documents:

- |  |  |
|--|--|
| <input checked="" type="checkbox"/> EN 60065 | <input checked="" type="checkbox"/> EN 61000-3-2 |
| <input checked="" type="checkbox"/> EN 55020 | <input checked="" type="checkbox"/> EN 61000-3-3 |
| <input checked="" type="checkbox"/> EN 55013 | <input checked="" type="checkbox"/> EN 55022     |

The following operation conditions and installation arrangements have to be presumed:

**acc. to Operating Manual**

**BEHRINGER**  
INTERNATIONAL GmbH  
Hanns-Martin-Schleyer-Str. 36-38  
D-47877 Willich, Mercurstraße II  
Tel.-Nr. 0 21 54 / 92 06-0  
Fax-Nr. 0 21 54 / 92 06-30

**B. Nier, President**

**Willich, 01.10.1998**

Name, address, date and legally binding signature of the person responsible

## SAFETY INSTRUCTIONS

**CAUTION:** To reduce the risk of electrical shock, do not remove the cover (or back). No user serviceable parts inside; refer servicing to qualified personnel.



**WARNING:** To reduce the risk of fire or electrical shock, do not expose this appliance to rain or moisture.



This symbol, wherever it appears, alerts you to the presence of uninsulated dangerous voltage inside the enclosure - voltage that may be sufficient to constitute a risk of shock.



This symbol, wherever it appears, alerts you to important operating and maintenance instructions in the accompanying literature. Read the manual.

### DETAILED SAFETY INSTRUCTIONS:

All the safety and operation instructions should be read before the appliance is operated.

#### **Retain Instructions:**

The safety and operating instructions should be retained for future reference.

#### **Heed Warnings:**

All warnings on the appliance and in the operating instructions should be adhered to.

#### **Follow instructions:**

All operation and user instructions should be followed.

#### **Water and Moisture:**

The appliance should not be used near water (e.g. near a bathtub, washbowl, kitchen sink, laundry tub, in a wet basement, or near a swimming pool etc.).

#### **Ventilation:**

The appliance should be situated so that its location or position does not interfere with its proper ventilation. For example, the appliance should not be situated on a bed, sofa rug, or similar surface that may block the ventilation openings, or placed in a built-in installation, such as a bookcase or cabinet that may impede the flow of air through the ventilation openings.

#### **Heat:**

The appliance should be situated away from heat sources such as radiators, heat registers, stoves, or other appliance (including amplifiers) that produce heat.

#### **Power Source:**

The appliance should be connected to a power supply only of the type described in the operating instructions or as marked on the appliance.

#### **Grounding or Polarization:**

Precautions should be taken so that the grounding or polarization means of an appliance is not defeated.

#### **Power-Cord Protection:**

Power supply cords should be routed so that they are not likely to be walked on or pinched by items placed upon or against them, paying particular attention to cords and plugs, convenience receptacles and the point where they exit from the appliance.

#### **Cleaning:**

The appliance should be cleaned only as recommended by the manufacturer.

#### **Non-use Periods:**

The power cord of the appliance should be unplugged from the outlet when left unused for a long period of time.

#### **Object and Liquid Entry:**

Care should be taken so that objects do not fall and liquids are not spilled into the enclosure through openings.

#### **Damage Requiring Service:**

The appliance should be serviced by qualified service personnel when:

- The power supply cord or the plug has been damaged; or
- Objects have fallen, or liquid has been spilled into the appliance; or
- The appliance has been exposed to rain; or
- The appliance does not appear to operate normally or exhibits a marked change in performance; or
- The appliance has been dropped, or the enclosure damaged.

#### **Servicing:**

The user should not attempt to service the appliance beyond that is described in the Operating Instructions. All other servicing should be referred to qualified service personnel.



# FEEDBACK DESTROYER PRO

Ultra-high performance 2-channel digital Feedback Destroyer / Parametric EQ powered by a 24-bit high-speed DSP

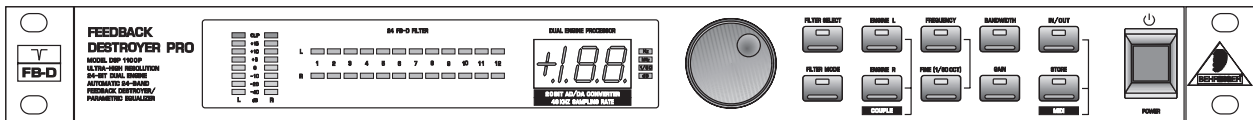

- ▲ 20-bit A/D and D/A converters with 64/128 times oversampling for ultra-high headroom and resolution
- ▲ Automatically and “intelligently” searches out and destroys up to 12 frequencies per channel
- ▲ 24 fully programmable Parametric Filters that can be set manually or via MIDI
- ▲ “Set-and-forget” default setting enables immediate and super-easy Feedback Destroyer performance
- ▲ Single-Shot mode automatically searches and destroys feedback and locks the filter until you reset them manually
- ▲ Auto mode continuously monitors the mix, resetting programmed filters automatically
- ▲ Manual mode allows for setting up to 2 x 12 fully parametric filters including Frequency, Bandwidth and Gain
- ▲ Single-Shot, Auto and Manual modes are assignable for each filter
- ▲ Free FEEDBACK DESTROYER software allows for total remote control via PC (download at [www.behringer.de](http://www.behringer.de))
- ▲ Two software engines give you independent or coupled functions on left and right channels
- ▲ Internal 24-bit processing with professional 46 kHz sampling rate
- ▲ Servo-balanced Inputs and Outputs on gold-plated XLR and TRS Jack connectors for high signal integrity
- ▲ Full MIDI capability and user preset memories to store programs for instant recall
- ▲ Accurate eight-segment LED level meters simplify level setting for optimum performance
- ▲ “Future-proof” software-upgradeable architecture
- ▲ High-quality components and exceptionally rugged construction ensures long life and durability
- ▲ Internal power supply design for professional applications
- ▲ Manufactured under the ISO9000 management system

## FOREWORD

Dear Customer,

Welcome to the team of FEEDBACK DESTROYER PRO users and thank you very much for expressing your confidence in BEHRINGER products by purchasing this unit.

It is one of my most pleasant tasks to write this letter to you, because it is the culmination of many months of hard work delivered by our engineering team to reach a very ambitious goal: making an outstanding device better still. The FEEDBACK DESTROYER has for some time been a standard tool used by numerous studios and P.A. rental companies. The task to improve one of our best-selling products certainly meant a great deal of responsibility, which we assumed by focusing on you, the discerning user and musician. It also meant a lot of work and night shifts to accomplish this goal. But it was fun, too. Developing a product usually brings a lot of people together, and what a great feeling it is when everybody who participated in such a project can be proud of what we've achieved.

It is our philosophy to share our joy with you, because you are the most important member of the BEHRINGER family. With your highly competent suggestions for new products you've greatly contributed to shaping our company and making it successful. In return, we guarantee you uncompromising quality (manufactured under ISO9000 certified management system) as well as excellent technical and audio properties at an extremely favorable price. All of this will enable you to fully unfold your creativity without being hampered by budget constraints.

We are often asked how we can make it to produce such high-grade devices at such unbelievably low prices. The answer is quite simple: it's you, our customers! Many satisfied customers means large sales volumes enabling us to get better conditions of purchase for components, etc. Isn't it only fair to pass this benefit back to you? Because we know that your success is our success, too!

I would like to thank all people whose help on "Project FEEDBACK DESTROYER PRO" has made it all possible. Everybody has made very personal contributions, starting from the designers of the unit via the many staff members in our company to you, the user of BEHRINGER products.

My friends, it's been worth the trouble!

Thank you very much,

A handwritten signature in black ink, appearing to read 'U. Behringer', with a long horizontal flourish extending to the right.

Uli Behringer



# TABLE OF CONTENT

<b>1. INTRODUCTION</b> .....	<b>7</b>
1.1 The design concept.....	7
1.2 Before you begin.....	7
1.3 Hook up & go.....	8
1.4 Control elements.....	9
1.4.1 Front panel control elements.....	9
1.4.2 Rear panel.....	11
<b>2. OPERATION</b> .....	<b>11</b>
2.1 Activating/deactivating the filters.....	12
2.2 Manual filters / parametric equalizer.....	12
2.3 Automatic filters.....	12
2.4 Working with programs.....	12
2.4.1 Recalling programs.....	12
2.4.2 Choice of mode.....	13
2.4.3 Editing filter parameters.....	13
2.4.4 Storing programs.....	14
2.5 MIDI control.....	14
<b>3. APPLICATIONS</b> .....	<b>15</b>
3.1 Level setting.....	16
3.2 Using the FEEDBACK DESTROYER PRO in the monitor path.....	16
3.3 Using the FEEDBACK DESTROYER PRO in the main mix bus.....	16
3.4 Using the FEEDBACK DESTROYER PRO in single channels and sub-groups.....	18
3.5 Using the FEEDBACK DESTROYER PRO in a studio environment.....	18
3.6 Using the FEEDBACK DESTROYER PRO as an effects device.....	18
3.7 Special remarks.....	19
3.7.1 Digital overflow.....	19
3.7.2 "Tuning in" P.A. and monitor systems.....	19
<b>4. TECHNICAL BACKGROUND</b> .....	<b>19</b>
4.1 Feedback.....	21
4.2 Graphic equalizers.....	22
4.3 Parametric equalizers.....	23
4.4 The FEEDBACK DESTROYER PRO.....	23
4.5 Digital audio processing.....	24
<b>5. INSTALLATION</b> .....	<b>25</b>
5.1 Rack mounting.....	25
5.2 Mains connection.....	25
5.3 Audio connections.....	26
5.4 MIDI connections.....	27
5.5 Operating level Switch.....	28
<b>6. APPENDIX</b> .....	<b>28</b>
6.1 Frequency chart.....	28
6.2 Preset table.....	29
6.3 MIDI implementation.....	30
6.4 Specifications.....	31
<b>7. WARRANTY</b> .....	<b>32</b>

# 1. INTRODUCTION

With the FEEDBACK DESTROYER PRO you have purchased a highly useful device for the control of sound reinforcement systems, which will enable you to focus your attention on what is essential: your music. The fully featured FEEDBACK DESTROYER PRO not only suppresses feedback but also incorporates a wealth of additional functions in one single unit. Its 24 separate filters can be edited in all parameters and automatically detect and suppress feedback frequencies. With its pro-level internal signal processing circuitry, the unit can also be used as a high-end equalizer for stage and studio applications. The MIDI interface allows for integrating the FEEDBACK DESTROYER PRO into any MIDI system, and the open system architecture enables you to update the system software whenever you want. In short: the BEHRINGER FEEDBACK DESTROYER PRO was built for the next millennium.

 **The following operational manual will introduce you to the BEHRINGER FEEDBACK DESTROYER PRO and its various functions. After reading the manual carefully, make sure it is always on hand for future reference.**

## 1.1 The design concept

Despite extensive computing work which is done in the DSP1100P by a "dual-engine" 24-bit processor, the FEEDBACK DESTROYER PRO can be operated easily and conveniently. All parameter edits are performed with the jog wheel (rotary control). 10 presets are available to store user-defined programs.

The philosophy behind BEHRINGER products guarantees a no-compromise circuit design and employs the best choice of components. Top-quality 20-bit AD/DA converters which belong to the best components available owing to its outstanding specifications and excellent sonic characteristics. Two 24-bit DSPs are used as the heart of the FEEDBACK DESTROYER PRO. These perform the precise calculations needed for the processing of the complex algorithms. Additionally, the FEEDBACK DESTROYER PRO uses high quality resistors and capacitors with very tight tolerances, high-grade switches, low-noise operational amplifiers (type 4580) as well other selected components.

The FEEDBACK DESTROYER PRO DSP1100P uses SMD technology (Surface Mounted Device). These subminiature components known from aerospace technology allow for an extreme packing density, improving the unit's reliability even further. Additionally, the unit is manufactured in compliance with a ISO9000 certified management system.

## 1.2 Before you begin

Your BEHRINGER FEEDBACK DESTROYER PRO was carefully packed in the factory and the packaging was designed to protect the unit from rough handling. Nevertheless, we recommend that you carefully examine the packaging and its contents for any signs of physical damage, which may have occurred in transit.

 **If the unit is damaged, please do not return it to us, but notify your dealer and the shipping company immediately, otherwise claims for damage or replacement may not be granted. Shipping claims must be made by the consignee.**

The BEHRINGER FEEDBACK DESTROYER PRO fits into one standard 19" rack unit of space (1 3/4"). Please allow at least an additional 4" depth for the connectors on the back panel.

Be sure that there is enough space around the unit for cooling and please do not place the FEEDBACK DESTROYER PRO on high temperature devices such as power amplifiers etc. to avoid overheating.

 **Before you connect your FEEDBACK DESTROYER PRO to the mains, please make sure that your local voltage matches the voltage required by the unit! (see chapter 5 for details)**

The mains connection of the FEEDBACK DESTROYER PRO is made by using a mains cable and a standard IEC receptacle. It meets all of the international safety certification requirements. Please make sure that all units have a proper ground connection.

 **Please ensure that only qualified persons install and operate the FEEDBACK DESTROYER PRO. During installation and operation the user must have sufficient electrical contact to earth.**

## Electrostatic charges might affect the operation of the FEEDBACK DESTROYER PRO!

For further information on correct installation see chapter 5 "Installation".

As a standard the audio inputs and outputs on the BEHRINGER FEEDBACK DESTROYER PRO are fully balanced. If possible, connect the unit to other devices in a balanced configuration to allow for maximum interference immunity.

The automatic servo function detects unbalanced connections and compensates the level difference automatically (6 dB correction). The MIDI links (IN/OUT/THRU) are made over standardized DIN patch cords. The data communication is isolated from ground by opto couplers.

### 1.3 Hook up & go

We know you are anxious to get to work with your new FEEDBACK DESTROYER PRO, the band is probably setting up now, you're half an hour behind schedule, it is hectic, dark and damp. If you promise to read the whole manual tomorrow, or at least next week, we show you how to get up and go and get through this night alive. If you've used a variety of PA gear, you'll have the FEEDBACK DESTROYER PRO up and running after quickly perusing the manual. If you're not so experienced, don't worry, it will come to you. In both cases, still read the manual! The following may then help you get it happening with a minimum of fuss.

 **In order to use the full potential of your FEEDBACK DESTROYER PRO, please bear in mind the following points:**

1. No device will fully compensate for wrong microphone handling! Be aware that there are some actions on stage may still result in feedback.
2. Allow some time for experimentation – you may need to get used to the DSP1100P over several gigs.
3. The FEEDBACK DESTROYER PRO's single shot filters are well suited to automatically attenuate resonances which are most likely to cause feedbacks.

The most probable use for the FEEDBACK DESTROYER PRO is feedback suppression in a stage monitor system or in a PA system. The unit should be placed between your console and the power amplifiers.

1. First, connect the unit as seen below.
2. Check the operating level switch on the back panel. For most PAs, this should be set to **+4 dB**.
3. On power-up, the Jog Wheel can select any of 10 programs. **Programs 1 – 3** give you instant feedback suppression for all 12 filters. Choose **Program 8 or 10** for stereo processing of the master output.

 **Note that the Bypass switch can be either Off or On, but NOT flashing! When Bypass is flashing, the whole unit is bypassed. But in the other two modes, filters set to Auto or Single Shot will still operate.**

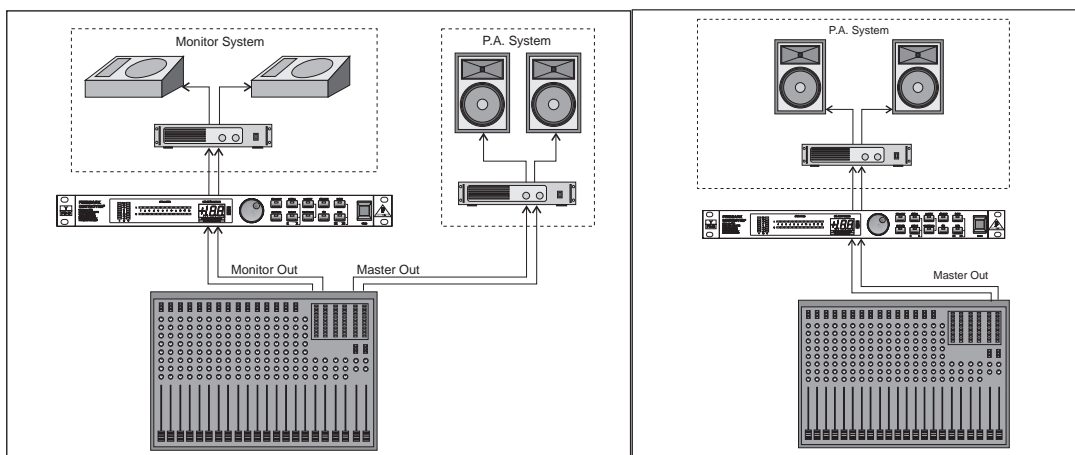

Fig. 1.1: Monitor application

Fig. 1.2: PA application

 **If you are using the FEEDBACK DESTROYER PRO for two separate monitor channels the L & R Engines should not be coupled.**





On start-up; all active filters (AU/Sl) are indicated by flashing LEDs. When feedback has been detected and dealt with, the LED stops flashing. When all filters are set the oldest automatic filter starts flashing, indicating that it will be the next filter to handle new feedback. Parametric filters are also indicated by a non-flashing LED.

In Single Shot mode the filter will not release a setting which has been achieved until you manually change it. This is particularly useful with problems at discrete frequencies like turntable resonances and fixed microphone and monitor positions. If feedback is detected the filter will deal with that frequency and the status of that filter will change to Locked (LO). It will only widen its bandwidth or increase the attenuation but it will not release that setting to destroy a new feedback. In Auto mode the oldest filter will be released to destroy a new feedback.

## 1.4 Control elements

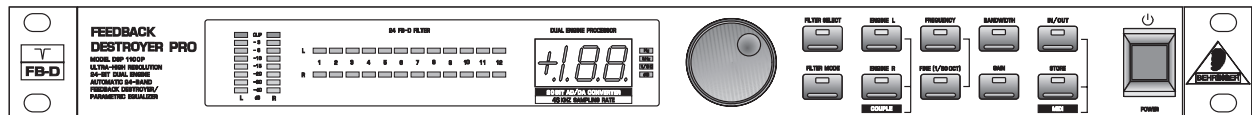

Fig. 1.1: FEEDBACK DESTROYER PRO front panel

The BEHRINGER FEEDBACK DESTROYER PRO is equipped with ten parameter keys, one jog wheel (rotary control) which is used to alter the selected parameter or preset and a numeric LED display. Each of the 24 filters has one LED assigned to it, which informs you about the status of the filter. By means of an 8-stage LED meter each of the two fully independent channels can be monitored.

### 1.4.1 Front panel control elements

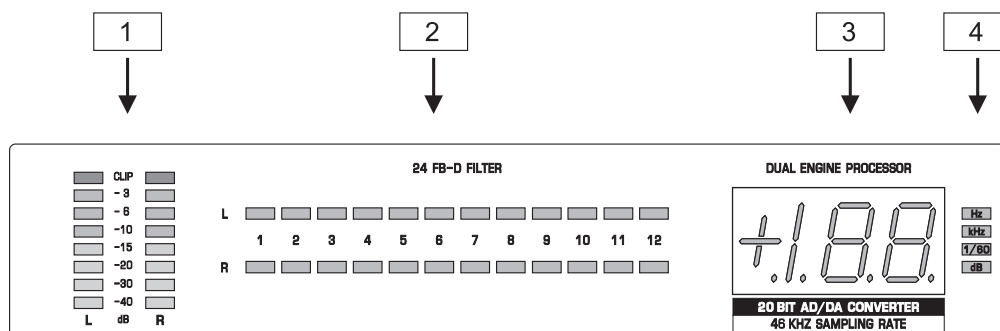



Fig. 1.2: Display section DSP1100P

- 1 The two LED chains read the output signal level in dB, referenced to the internal digital maximum. If the FEEDBACK DESTROYER PRO is set to Total Bypass mode, the level meter displays the input level.
-  **Please note that the nominal level of the FEEDBACK DESTROYER PRO can be selected with the +4 dBu / -10 dBV switch located on the back panel.**
- 2 The FEEDBACK DESTROYER PRO features 24 filters which can be monitored conveniently with the indicators next to the display. Twelve LEDs inform you about the status of the filters of each channel (left/right). A bright LED announces that a filter has been set. Cyclically flashing LEDs indicate filters that are searching in Single-Shot and Auto mode.
  - 3 After power-up, the LED display reads the number of the preset last used. This clearly legible, 2½ digit numeric display has plus/minus indicators to show that parameters are being incremented or decremented in Edit mode.
  - 4 The indicators Hz, kHz, 1/60 and dB to the right of the display light up when you change the associated parameters in Edit mode. For example, if you raise the level of a filter, the “dB” indicator lights up. A “+” to the left of the preset number signals that the level is being increased.

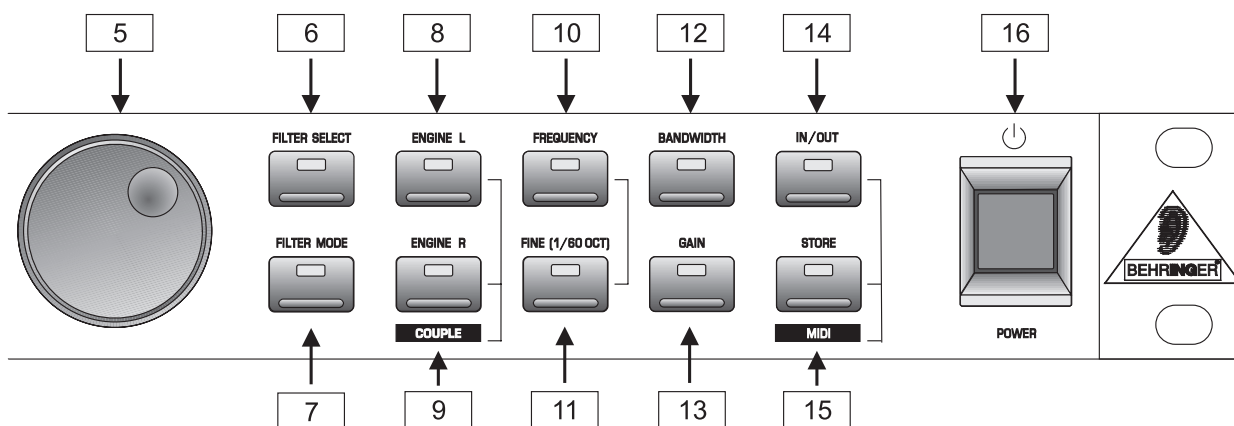



Fig. 1.3: Function keys and jog wheel

5 With the *JOG WHEEL*, a continuous rotary control, you can freely edit the selected parameters. Turn the wheel clockwise to increase the values, or counterclockwise to reduce them.

 **As long as none of the edit functions to the right of the jog wheel has been selected, you can use the wheel to select a program directly, which is shown by a dot lighting up in the display. While this dot is on, you can select a program though its settings will not take immediate effect. When the jog wheel has not been touched for one second, the LED in the display disappears and the program is loaded.**

6 With *FILTER SELECT* activated you use the jog wheel to select one of the 12 filters per channel.

7 The *FILTER MODE* key gives you access to the four operating modes: “OF”, Parametric EQ (PA), Single-Shot (SI) and Auto Mode (AU). In addition you can edit the threshold of feedback suppression (-3 to -9 dB) by pressing the *FILTER MODE* and the *GAIN* key together for about 1 seconds.

11 Use the *ENGINE L* key to select the left audio channel.

12 Use the *ENGINE R* key to select the right audio channel. If you wish to process the left and right audio channels simultaneously (*COUPLE* mode), press both *ENGINE* keys together. In couple mode both engine LEDs light up. Whenever you edit one of the two audio channels and then switch to couple mode, the parameters of the active channel will be copied to the other; i.e. if you press *ENGINE L* before *ENGINE R*, left will be copied to right.

8 Use the *ENGINE L* key to select the left audio channel.

9 Use the *ENGINE R* key to select the right audio channel. If you wish to process the left and right channels simultaneously (*Couple* mode), press both *Engine* keys at the same time.

10 Press the *FREQUENCY* key to select the frequency you wish to process. The *FEEDBACK DESTROYER PRO* splits up the adjustable frequency range (20Hz to 20 kHz) into the 31 standard ISO values of a graphic EQ (see 6.1).

11 The *FINE* key allows you to fine tune the standard ISO frequencies (in 1/60-octave steps) within a tuning range of 1/3 octave (-9/60 to +10/60).

12 *BANDWIDTH* determines the filter bandwidth of the selected filter. The adjustable value ranges from 2 octaves (120/60 octave) down to 1/60 octave.

13 The *GAIN* key sets the desired boost/cut of the selected filter in dB (+16 dB / -48 dB).

14 The *IN/OUT* key allows for optional bypassing of the parametric filters or all filters. By shorty pressing the *IN/OUT* key only the parametric filters will be deactivated and the green LED ends up lighting. Hold down the *IN/OUT* key for about two seconds to deactivate all filters. A cyclically flashing LED will indicate this Total-Bypass mode. One further pressing reactivates all filters. The LED flickers when relevant MIDI data is received.

 **Please, use the Total-Bypass function only with utmost caution because by deactivation, the *FEEDBACK DESTROYER PRO* possibly unlocks suppressed feedbacks.**

15 Any modifications made to a preset can be stored with the help of the *STORE* key. Ten presets are available on the *FEEDBACK DESTROYER PRO*. Press the *IN/OUT* and the *STORE* keys, the *FEEDBACK DESTROYER PRO* automatically enters MIDI mode.

 Press and keep the keys **FILTER SELECT** and **STORE** before powering up the **FEEDBACK DESTROYER PRO**. Then switch on the **FEEDBACK DESTROYER PRO** and keep the two keys pressed for about one second. The program numbers are counted up and reset to their original default settings.

16 Use the **POWER** switch to switch the **FEEDBACK DESTROYER PRO** on or off.

## 1.4.2 Rear panel

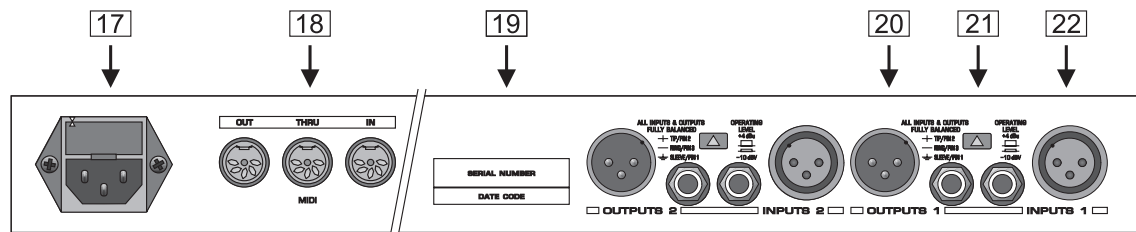

Fig. 1.4: Rear panel connectors and control elements

- 17 This is the **MAINS CONNECTOR / FUSE HOLDER / VOLTAGE SELECTOR**. Before you connect the unit, please make sure that the displayed voltage corresponds to your Mains supply. Please note that the AC voltage selection is defined by the position of the Fuse Holder. If you intend to change the operating voltage, remove the Fuse Holder and turn it by 180 degrees before you reinsert it. Matching the two markers monitors the selected voltage. Please note that, depending on the mains voltage supplied to the unit, the correct fuse type and rate must be installed (see chapter 6.4 “SPECIFICATIONS”). Please use the enclosed mains cable to connect the unit to the mains power supply. (Please note that not all appliances can be used with different mains voltage ratings. Please check the description on the back of the unit and the box.)
- 18 These are the **FEEDBACK DESTROYER PRO**'s MIDI connectors (**MIDI OUT / THROUGH / IN**). Via these connectors total remote control is possible.
- 19 Please take the time to make a note of the **SERIAL NUMBER** in the space provided on the enclosed Warranty Registration Card. Put the instruction manual in a safe place and return the completed Warranty Registration Card to us within 14 days of purchase, making sure that the dealer stamp has been acquired.
- 20 These are the **FEEDBACK DESTROYER PRO**'s analog **OUTPUTS**. Also on balanced or unbalanced XLR or TRS jacks.
- 21 Use the **OPERATING LEVEL** switch to adapt the **FEEDBACK DESTROYER PRO** to different operating levels. You can select a -10 dBV semi-pro level used for home recording and a +4 dBu level used in professional studios.
- 22 These are the **FEEDBACK DESTROYER PRO**'s analog **INPUTS**. The **FEEDBACK DESTROYER PRO** has both XLR and jack inputs and outputs. Each XLR and jack set are wired parallel and can be used either balanced and unbalanced.

## 2. OPERATION

The following chapter will familiarize you with the operation of your **BEHRINGER FEEDBACK DESTROYER PRO**. It will provide you with the basic understanding of how to obtain the desired results and should encourage you to experiment with the **DSP1100P**. Please bear in mind that the technical specifications of a unit may determine its limits, but the skill of the audio engineer determines how much use can be made from it. So do not hesitate to play with the unit, just like a musician does with an instrument, in order to explore the full functionality of your **FEEDBACK DESTROYER PRO**.

The **BEHRINGER FEEDBACK DESTROYER PRO** can operate in four different modes. To meet more complex requirements with regard to flexible signal processing, these modes can be combined in a program.

## 2.1 Activating/deactivating the filters

In “OF” mode, the corresponding filter is deactivated and can be activated by selecting one of the modes described below.

## 2.2 Manual filters / parametric equalizer

The FEEDBACK DESTROYER PRO allows you to freely process any music signals. To raise or lower specific frequencies in level, you can directly select these frequencies by means of the manual filters (*Parametric EQ* mode). Each filter has the functionality of a fully parametric EQ, i.e. you can set the center frequency, the quality factor (Q) and the amount of boost/cut (in dB).

## 2.3 Automatic filters

The FEEDBACK DESTROYER PROs automatic filters operate in two modes: *Single-Shot* and *Auto* mode. In order to find a feedback, the FEEDBACK DESTROYER PRO divides the entire frequency band into 1/60 octave steps (20 Hz to 20 kHz) and determines the respective level of these individual bands. He compares this value to the level of the entire signal. The difference of these levels determines whether a filter is set. The FEEDBACK DESTROYER PRO now provides you with the unique possibility to adapt this parameter according to your own needs. You can edit this feedback sensitivity within a range of -3 dB to -9 dB (in 1 dB steps). The standard value for this parameter is -6 dB. This value provides an optimal recognition of feedback during most applications. During e.g. a pure speech transmission, the feedback sensitivity can be lowered to -9 dB. In this way, the algorithm would recognize and would suppress a feedback even faster. On the other hand a higher adjustment of the feedback sensitivity (e.g. -3 dB) makes feedback suppression more stable. In addition to that intended feedbacks (guitars or keyboards) become recognized much more slower.

Filters in Single-Shot mode automatically analyze the music signal to detect feedback frequencies. Having detected such a frequency, the filter automatically configures its parameter to suppress feedback as efficiently as possible. As the filter is locked to the detected frequency, this mode is ideally suited to suppress feedback having a constant frequency. Possible applications are “fixed-position” microphones (e.g. on the drums). After the filter has adjusted itself automatically, it enters a special Lock mode, which means that although the frequency remains fixed, the width and depth of the filter are still being adapted to the feedback frequency, i.e. the width is increased as soon as the feedback frequency begins to shift, and the gain is cut if feedback prevails. The gain is not reduced to prevent feedback from recurring.

All microphones that are moved during a performance (e.g. vocal mics) very often have varying feedback frequencies. This type of feedback should be suppressed in Auto mode. As in Single-Shot mode, the filter automatically selects an ideal setting for feedback suppression. But in Auto mode a locked filter tracks and suppresses the feedback frequency even as it changes. The optimum frequency is selected automatically and the filter is set to narrow-band mode so as to influence the music signal as little as possible. If your music contains wanted feedback elements (e.g. guitar feedback), it is highly probable that these will be suppressed too in Auto mode, because from a physical point of view it is impossible to distinguish “wanted” from “unwanted” feedback. Please read the hints given in section 6.3 to work around this situation.

## 2.4 Working with programs

In order to store your favorite settings, the FEEDBACK DESTROYER PRO has ten user presets and a default preset. All operating parameters can be stored, i.e. your programs are recalled in full detail. Owing to state-of-the-art circuitry, no internal battery is needed, hence the memory contents will not be lost. In the default preset (display “--”), which serves as a basis for creating your own programs, all filters remain in the parametric mode, with bandwidth set to 1 octave, a frequency of 500 Hz and 0 dB gain.

### 2.4.1 Recalling programs

After power-up, the FEEDBACK DESTROYER PROs display reads the number of the preset last used. The jog wheel allows you to conveniently select the preset of your choice. Turn the rotary control to the left to step through the programs in descending order. Turn it to the right to increment the programs. The default preset is located in front of the first program.



**Please note that the FEEDBACK DESTROYER PRO generally activates the newly selected presets**



only after about one second, which is indicated by a dot in the lower right corner of the display. After loading the data, the FEEDBACK DESTROYER PRO enables the preset and the dot disappears. This brief interruption avoids the direct activation of every preset, as you scroll through the preset list with the jog wheel. Thus, the FEEDBACK DESTROYER PRO makes sure that no "unwanted" programs are loaded unintentionally. Additionally, you can rotate the jog wheel at high speed and still have the time to specifically select the preset of your choice, instead of any of its "neighbors".

### 2.4.2 Choice of mode

Each filter mode has two letters assigned to it, who appears in the display after pressing the FILTER MODE key. The following display messages can be recognized:

Display	Mode of operation
OF	Off
PA	Parametric EQ
AU	Auto
SI	Single Shot
LO	Locked (S)

Tab. 2.1: FEEDBACK DESTROYER PRO operating modes

To change the filter mode, you first have to press the FILTER SELECT key to specify the number of the filter (1 to 12) with the jog wheel. Using the ENGINE keys you can not only select the left or right channel, but also both ones at the same time. Then you can choose the filter mode by simply pressing the FILTER MODE key and turning the jog wheel. The display message "L" (locked) informs you that a filter from the Single-Shot mode is already suppressing a feedback. You can unlock such a filter by switching it back to single mode. As soon as a new feedback will be found, the FEEDBACK DESTROYER PRO switches the filter from the old frequency to the new one. If you leave the Auto or Single-Shot mode and enter the Parametric mode, the filter keeps all parameter settings.

In order to avoid an inadvertent change, the filter mode selection takes place after a period of approximately one second. This is indicated by a dot in the lower right corner of the display.

By pressing and keeping the FILTER MODE and the GAIN key for about 2 seconds you can adjust the feedback threshold within a range of -3 dB to -9 dB.

### 2.4.3 Editing filter parameters

To change filter settings, the filter has to situate in Parametric EQ mode. In this case you can adapt the center frequency by pressing the FREQUENCY key. Depending on the frequency, either the "Hz" or "kHz" indicator to the right of the display lights up. If you want to lift the frequency to e.g. 2700 Hz turn the jog wheel until the ISO frequency (2.5 kHz, see table 6.1 standard ISO frequencies) closest to this value appears in the display and the "kHz" indicator lights up. The FINE key allows you to fine tune the chosen standard ISO frequency within a tuning range of 1/3 octave (in 1/60-octave steps). The mathematical proportion between the displayed value and the absolute frequency, and an easy guide to quickly find the desired frequency is available in chapter 7 (frequency chart). The bandwidth of the filter can be adjusted by selecting the BANDWIDTH key. The adjustable bandwidth ranges from 2 octaves down to 1/60 octave. By pressing the GAIN key it is possible to set the desired boost or cut of the selected frequency. A "+" signals that the level is being increased and a "-" signals a decrease.

In Single-Shot and Auto mode it is not possible to change the filter parameters. In these modes you only are allowed to call up the parameters. However you can convert such a filter into a parametric one with same frequency, and bandwidth, but with a gain of 0 dB. You simply have to press and keep the FILTER MODE key for about 2 seconds. To reactivate a locked filter simply choose the Single-Shot or Auto mode.

## 2.4.4 Storing programs

Use the STORE key to store the program. Basically, all parameter changes in Parametric EQ mode can be saved. Filters working in Single-Shot or Auto mode will adjust and store the required parameters automatically. Example:

▲ You recall a program for editing. Then you edit the preset as desired using the function keys and the jog wheel. During this process, the flashing STORE key reminds you that the preset settings have been changed but not saved yet. Press the STORE key once. The display reads the current preset number and starts flashing. To keep the original preset, use the jog wheel to select a different preset that can be overwritten. Press the STORE key again to save the edits to the selected preset. If you wish to overwrite the original preset, simply press the STORE key twice (after editing) to save all changes you have made.

 **Whenever you have edited a preset and pressed the STORE key twice, all previous settings in this preset are erased and overwritten with the new parameter values. However, if you wish to keep the original preset, use the jog wheel to select another preset *before* you press the STORE key a second time.**

## 2.5 MIDI control

Use the MIDI key combination to select the MIDI parameters you wish to adjust. For this purpose press and keep the IN/OUT and the STORE keys for about two seconds. All parameters can be edited with the jog wheel and the IN/OUT key. The MIDI menu includes six pages which you can select by pressing the IN/OUT key (forwards) and the STORE key (backwards) several times.

On the first page you can select the MIDI channel. The display reads a small "c" (= channel). The jog wheel adjusts a channel from 1 through 16. To switch off the MIDI function simply select the "0" value (displayed as "-").

On the second page you can select MIDI Omni mode, i.e. the unit transmits/receives on all 16 MIDI channels. The display reads "O" (=Omni). Use the jog wheel to activate ("1") or deactivate ("0") Omni mode.

The third page allows for configuring controller commands. On its right-hand side, the display reads a capital "C" (=Controller). The jog wheel selects one of the following four controller modes:

Display	Mode
0	No controller data are transmitted
1	Controller data are received but not transmitted
2	Controller data are transmitted but not received
3	Controller data are transmitted and received
4	As 3, with additionally the automatic filter parameters

Tab. 2.2: Controller settings

 **When you choose value "4" the FEEDBACK DESTROYER PRO will also send the settings of the automatic filters.**

The fourth page gives you access to the program change setup. The display reads a capital "P" (=Program). Here, too, four modes can be selected with the jog wheel, as follows:

Display	Mode
0	No program change data are transmitted
1	Program change data are received but not transmitted
2	Program change data are transmitted but not received
3	Program change data are transmitted and received

Tab. 2.3: Program change settings

The fifth page of the MIDI menu shows the "store enable" flag represented by a capital "S" in the display. The value "0" disables the reception of controller #18, and therefore protects the user presets from being modified

via MIDI. Accordingly, the value "1" enables MIDI controller #18 so that you can modify or replace presets with a remote MIDI device or a sequencer. In this case the actual settings will be stored directly to the location that corresponds to the controller value.

 **Attention! Since the "store enable" mode allows you to access memory locations directly via MIDI, it is possible that stored presets will be replaced or altered if controller #18 messages are sent on the same MIDI channel. The purpose of this mode is to facilitate MIDI backup and restore operations without express confirmation at the FEEDBACK DESTROYER PRO. It is therefore recommended to disable (flag=0) this mode as soon as the intended data transfer has ended. This is done automatically when you switch off the FEEDBACK DESTROYER PRO.**

On the sixth, and presently the last, page you can access the "System Exclusive" functions. This is indicated by a "d" (for dump) in the display. To the left of this "d" a number is displayed:

- 0 means that no SYSEX data will be sent or accepted.
- 1 will enable the FEEDBACK DESTROYER PRO to receive data. When STORE is pressed the unit will wait for data, this is shown by flashing dots (LEDs) in the display. The MIDI button LED flashes signaling that SYSEX data is being received.
- 2 will enable the FEEDBACK DESTROYER PRO to send a "bulk dump". Start your sequencer and press STORE on the unit to start the transmission.

If you press the IN/OUT key again on the fifth page, the FEEDBACK DESTROYER PRO quits MIDI setup mode.

To load these settings again, select 1, press STORE and start your sequencer. If you press IN/OUT again, you will leave the MIDI setup. You can at all times press any other key to leave the MIDI setup directly.

 **During a bulk dump all audio functions of the FEEDBACK DESTROYER PRO will be deactivated.**

The full-featured MIDI implementation of the FEEDBACK DESTROYER PRO allows for easily integrating the FEEDBACK DESTROYER PRO into any MIDI system.

#### ▲ MIDI IN

Any MIDI data sent to the FEEDBACK DESTROYER PRO (sequencer, MIDI footswitch, etc.) are received via the MIDI IN jack. For example, if you wish to use the FEEDBACK DESTROYER PRO as an effects device for your guitar rack, you can connect the MIDI IN jack to a MIDI footswitch that allows for selecting program presets. If your rack includes another MIDI effects device (e.g. a multi-effects processor), the data sent from the MIDI footswitch can be routed via the FEEDBACK DESTROYER PRO's MIDI THRU jack to your multi-effects processor.

#### ▲ MIDI THRU

The MIDI THRU jack is used to loop through incoming MIDI data, i.e. any control data received at the MIDI IN of the FEEDBACK DESTROYER PRO will be transmitted via the MIDI THRU jack to other MIDI devices/instruments.

#### ▲ MIDI OUT

The MIDI OUT jack allows for transmitting MIDI data that originate from the FEEDBACK DESTROYER PRO. We are currently developing a software editor which will allow for storing single items of the FEEDBACK DESTROYER PRO's internal data on an external medium. Thus, it will be possible to archive FEEDBACK DESTROYER PRO settings and presets on a computer, sequencer or MIDI data recorder. Both MIDI Control Change and MIDI Program Change commands will be transmitted when you edit or recall filter settings. Detailed information on this future software editor are available from our BEHRINGER hotline (tel. +49 (0) 2154-920666), our international distributors and/or our Internet homepage <http://www.behringer.de>.

## 3. APPLICATIONS

The BEHRINGER FEEDBACK DESTROYER PRO features a high level of flexibility not only in the field of feedback elimination. The following chapter describes some other possible applications for your FEEDBACK DESTROYER PRO.



### 3.1 Level setting

Take care to set levels properly on the FEEDBACK DESTROYER PRO! Low levels deteriorate the dynamics of the music signal, which results in a poor, weak and noisy sound. On the other hand, excess levels overdriving the converters in the FEEDBACK DESTROYER PRO should also be avoided. Digital distortion is (unlike its analog counterpart) very unpleasant to hear as it does not occur gradually but abruptly.

Use the input level meter of the FEEDBACK DESTROYER PRO to adjust the input signal so that the Clip LED flickers only rarely. Make sure that it never lights up all the time!

### 3.2 Using the FEEDBACK DESTROYER PRO in the monitor path

Inserting the FEEDBACK DESTROYER PRO into the monitor path of your mixing console gives you maximum protection against annoying feedback. Monitor systems are particularly susceptible to feedback because on stage there are usually lots of microphones and speakers located in close proximity to each other. Vocal mics are especially critical in this context as their levels must be relatively high to be able to “compete” with other instruments. Additionally, vocal mics are not always used at fixed positions. It has therefore proven useful to protect the monitor paths against feedback. An agreeable side effect when using the FEEDBACK DESTROYER PRO in the monitor path is the positive influence on both sound and loudness of the monitors, because filtering interference makes the monitor sound more transparent and feedback suppression enables you to increase the volume level of the monitors (which is usually highly welcomed by the musicians performing on stage).

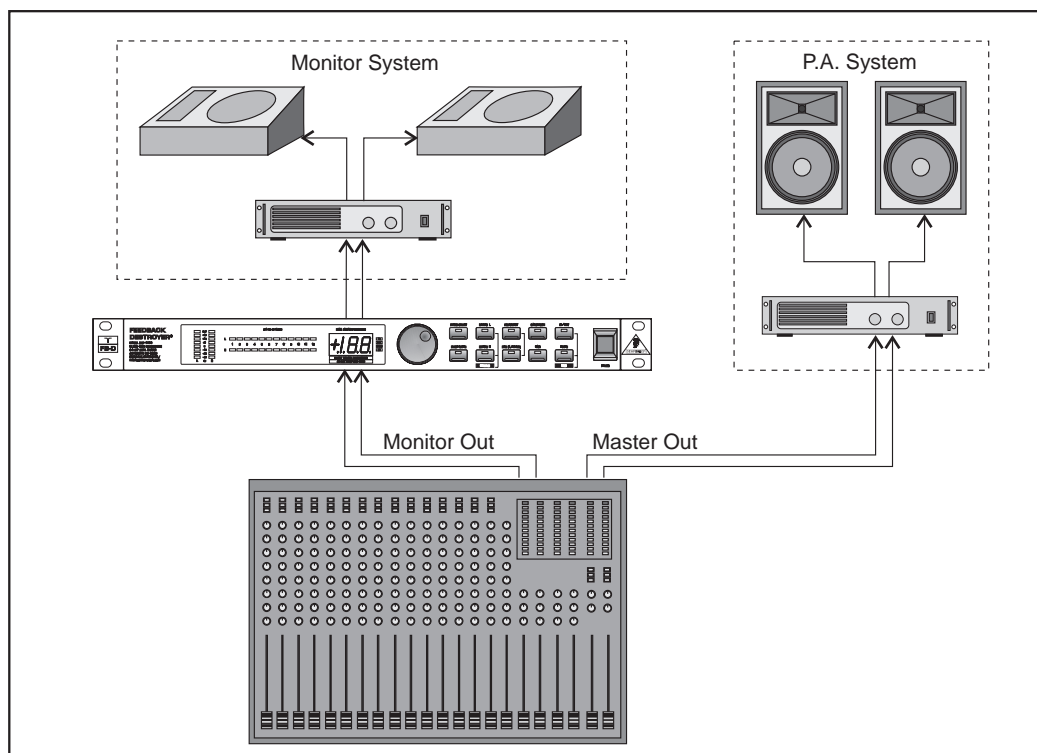

Fig. 3.1: Using the FEEDBACK DESTROYER PRO in the monitor path

### 3.3 Using the FEEDBACK DESTROYER PRO in the main mix bus

The FEEDBACK DESTROYER PRO can also be used to process main mix signals. Please consider the following remarks:

Using the FEEDBACK DESTROYER PRO in the main mix bus gives you the advantage that any feedback occurring in the individual microphone channels can be eliminated with just one FEEDBACK DESTROYER PRO. However, this also means that “wanted” feedback (e.g. guitar feedback) will be suppressed, too. Furthermore, the FEEDBACK DESTROYER PRO could cause a slight manipulation of the main mix sound in extreme



situations.

Before applying the FEEDBACK DESTROYER PRO, it is therefore advisable to remove the condition causing the feedback problems. For example, try different microphone positions! Use the FEEDBACK DESTROYER PRO in the monitor path and in single channels with critical signals. If there is no other way to eliminate feedback, you can insert the FEEDBACK DESTROYER PRO into the main mix bus. Unless your mixing console has dedicated insert points for the main mix bus, you can simply connect the FEEDBACK DESTROYER PRO between mixing console and power amp. If required, adapt the levels with the Operating Level switch.

Wire the unit as shown below:

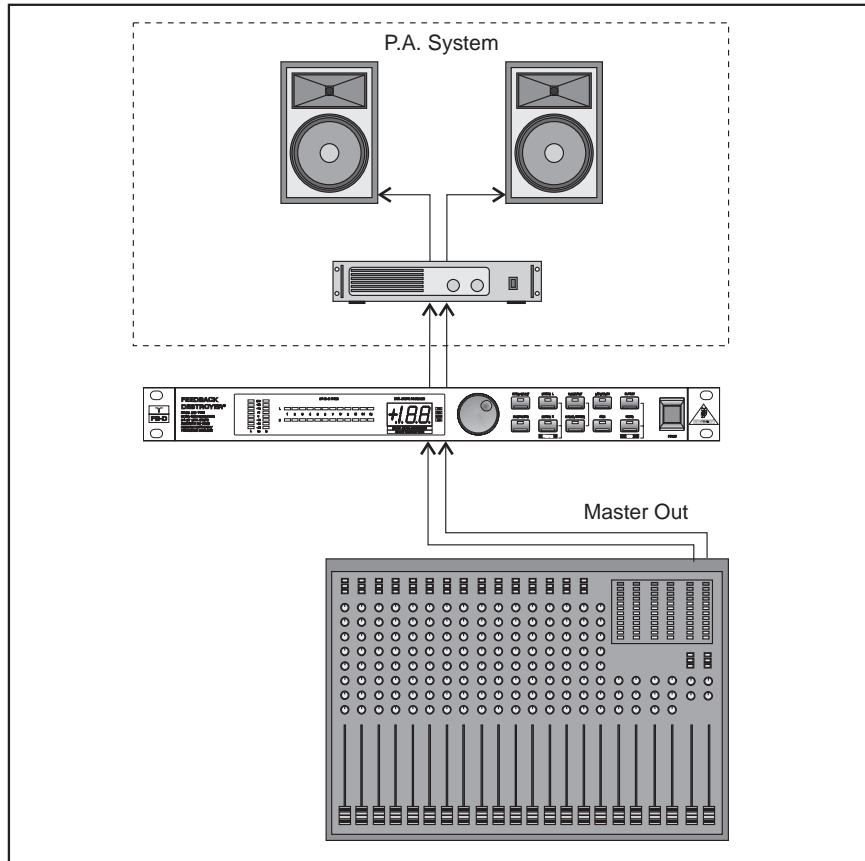

Fig. 3.2: Using the FEEDBACK DESTROYER PRO in the main mix bus



### 3.4 Using the FEEDBACK DESTROYER PRO in single channels and sub-groups

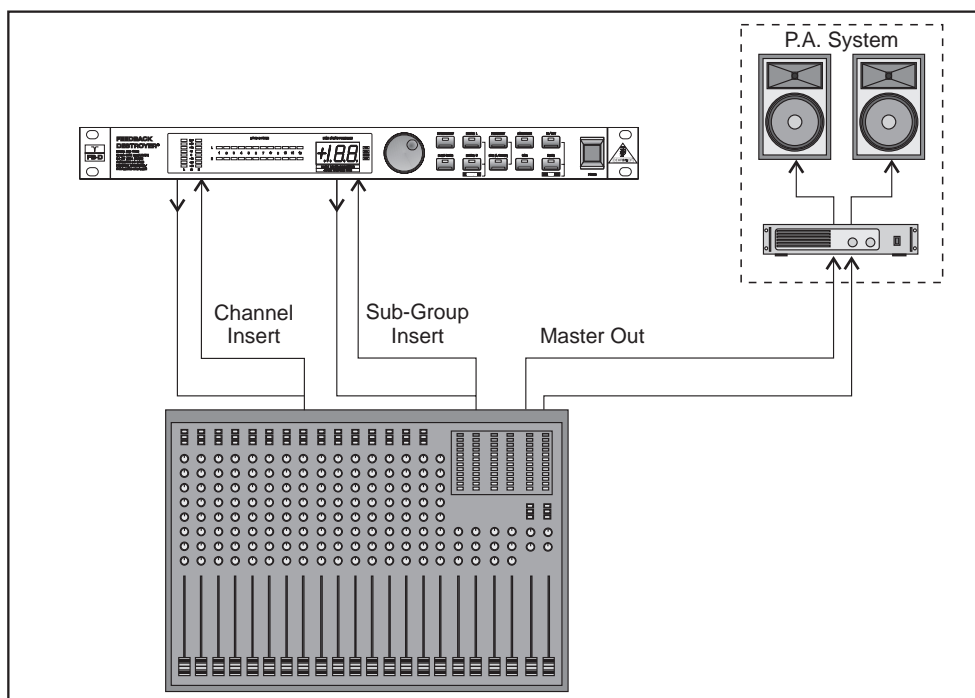

Fig. 3.3: Inserting the FEEDBACK DESTROYER PRO in single channels and sub-groups

If you want to make sure that deliberately produced feedback signals, such as “guitar feedback”, are not eliminated, you should try inserting one or several FEEDBACK DESTROYER PRO’s into single channels (e.g. vocal mics) which are susceptible to feedback. Or, you could use the sub-groups of your mixing console by routing any channels susceptible to feedback (e.g. all vocal mics) to one or several sub-groups. Thus, all less critical signals (e.g. line signals, lower-level instrumental microphones) can pass through the mixing console unaltered, while only the critical microphone channels are monitored from the FEEDBACK DESTROYER PRO. In this way, you can protect your P.A. system against feedback and still use “wanted” feedback signals.

### 3.5 Using the FEEDBACK DESTROYER PRO in a studio environment

With its highly flexible configuration the FEEDBACK DESTROYER PRO also delivers good results in a professional studio or home recording environment, as it provides a maximum of twelve fully parametric equalizers per channel in Parametric EQ mode. Thus, you can realize any application ranging from slight processing to the total manipulation of music signals. For example, you can use the FEEDBACK DESTROYER PRO as an equalizer for your studio monitors or to enhance the EQ’s in your mixing console, as these are often only semi-parametric.

### 3.6 Using the FEEDBACK DESTROYER PRO as an effects device

With its MIDI interface the FEEDBACK DESTROYER PRO can also be used as a programmable EQ - as a control unit in a guitar rack or in combination with a keyboard. If you own a MIDI footswitch with an expression pedal, you can produce interesting wah-wah effects by modifying the filter frequency with the expression pedal while playing. A similar effect is produced when the FEEDBACK DESTROYER PRO is used to generate “sweeping” sounds. Emphasize or de-emphasize a particular frequency and change the filter frequency continuously via MIDI. The resulting effect sound like a heavily modulating phaser (although the phasing effect is a different phenomenon from a physical point of view). The advantage in this application is that the sweeping sound is MIDI-controllable and can be synchronized to, for instance, a sequencer. This effect is very popular in dance and techno music.

## 3.7 Special remarks

### 3.7.1 Digital overflow

When using the FEEDBACK DESTROYER PRO as a parametric equalizer (Parametric EQ mode) and applying extreme attenuation values in the low end range of the frequency spectrum (below 50 Hz), you should perhaps set several filters to process the same frequency. Depending on the amount of attenuation applied, the use of only one filter may lead to slight distortion, which produces interference in the signal path. This is a natural physical phenomenon which should be avoided. Use for example two filters adjusted to a signal attenuation of about -12 dB (with the same frequency and bandwidth). This produces the same effect achieved with *one* filter set to -24 dB.

### 3.7.2 “Tuning in” P.A. and monitor systems

With the FEEDBACK DESTROYER PRO you can improve the protection against feedback even before the show begins, by “tuning in” your sound reinforcement system: after the system has been set up completely, open all microphone channels and activate Single-Shot mode on your FEEDBACK DESTROYER PRO. Then, slowly move up the monitor and master faders until feedback comes in. Without the FEEDBACK DESTROYER PRO you could not increase the volume level of your system any further. With your FEEDBACK DESTROYER PRO, however, you can considerably enhance the system headroom! Move the faders further up, and the first feedback signal will be suppressed by the FEEDBACK DESTROYER PRO. Continue to move up the faders until about three or four filters are suppressing various feedback signals. Subsequently, cut back the volume to the level required for the show. In this way, you can be sure that there is enough system headroom should it be necessary to raise the volume level during the concert.

If you have more than one FEEDBACK DESTROYER PRO for the monitor path, you should use these devices to protect critical signal paths. Experience has shown that musicians want to have the volume of their instrument increased on the monitor as the concert goes on. With the FEEDBACK DESTROYER PRO you can turn up the volume without having to fear feedback problems. When the show begins you should set several filters to Auto mode in order to suppress feedback produced by “moving” (vocal) microphones. In Auto mode, the FEEDBACK DESTROYER PRO automatically tracks and suppresses feedback signals with varying frequencies.

## 4. TECHNICAL BACKGROUND

The steady development of modern sound reinforcement systems has made it possible to produce almost any level of loudness. Yet, the increase in loudness goes in line with a need for optimized audio quality. Today, audiences expect to hear a powerful and transparent sound. Nothing can spoil a live event more than interference and feedback.

High volume levels and the use of ever sophisticated monitor systems with a great number of speaker boxes have increased the potential risk of feedback loops. Up to now sound engineers have used conventional 1/3-octave equalizers to suppress unwanted feedback. Now, the BEHRINGER FEEDBACK DESTROYER PRO gives you the option to delegate this task to the FEEDBACK DESTROYER PRO, so that you can pay your music your undivided attention instead of having to suppress feedback with graphic EQ's using a trial-and-error approach.

To fully understand how the BEHRINGER FEEDBACK DESTROYER PRO works you will need to know the meaning of a few fundamental terms used in signal equalization, such as:

- ▲ dB, decibel
- ▲ bandwidth / quality factor (Q)
- ▲ octave, 1/3-octave

With the FEEDBACK DESTROYER PRO, as with any other type of equalizer, the amount of boost/attenuation applied to a specific frequency is expressed in decibels (dB). What's a decibel? The abbreviation dB is not a unit (although often used as one), but describes a logarithmic proportion. The entire dynamic range of human hearing (from the threshold of audibility to a jet-airplane, see fig. 4.1) starts with about 0.00002 Pa (threshold of audibility) and goes up to 113 Pa (threshold of pain).



The range of sound pressure levels or the dynamic range of human hearing encompasses a factor of 10,000,000. This enormous range of values is difficult to handle and additionally does not represent the subjective perception of sound, since human hearing tends to use a logarithmic curve. When an increase in loudness by the factor two is perceived as one step, four times the loudness level equals two steps. So, the decibel is a unit of measurement that describes a level in relation to a reference quantity. To make clear which reference quantity is meant, the abbreviation SPL (sound pressure level) is sometimes used together with dB. Starting with a value of 0 dB SPL ( $= 2 \cdot 10^{-5}$  Pa) for the threshold of audibility, any dB values can be calculated by means of the following formula:

$$L = 20 \cdot \log \frac{p_2}{p_1}$$

L = e.g. the absolute sound pressure level in dB SPL

$p_1$  = e.g. a reference sound pressure of 0.00002 Pa

$p_2$  = the sound pressure (in Pa) produced by the sound source to be calculated

log = decimal logarithm.

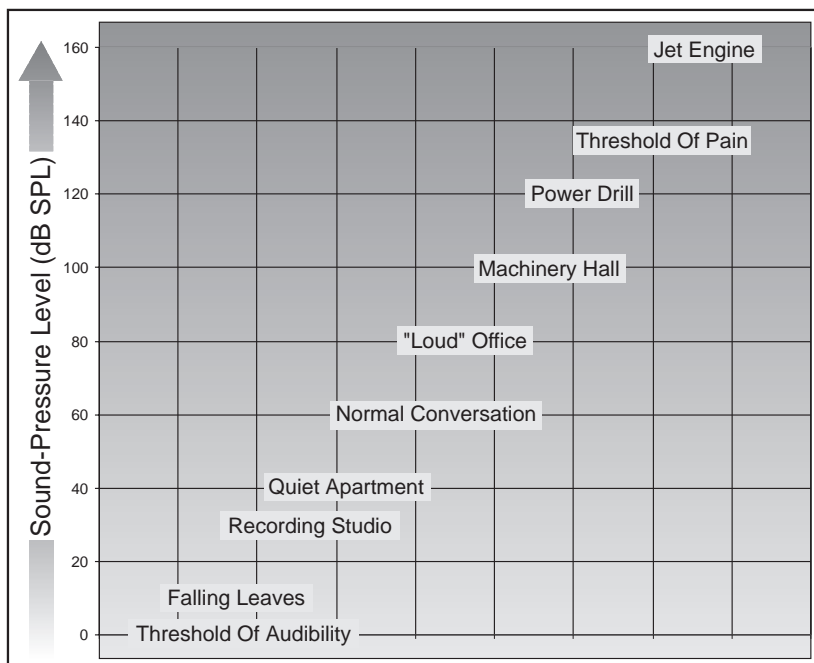

Fig. 4.1: Dynamic range of human hearing

As can be seen, human hearing has a very wide dynamic range of about 130 dB, which surpasses the range of a DAT or CD player with an approximate range of 96 dB. From a physical point of view, a 3 dB boost corresponds to an increase in power by the factor 2. However, the human ear perceives a signal to be twice as loud as before only if it is boosted by about 10 dB. This will give you an idea of the range of boost or attenuation that can be realized with the 24 filters of the FEEDBACK DESTROYER PRO. For each filter, you can apply a boost of +16 dB or a cut of -48 dB, i.e. you can boost the selected frequency by the subjectively perceived factor 3 (physically  $\approx 40$ ) or attenuate it by the factor 27 (physically  $\approx 60,000$ )!

The sound which an EQ produces not only depends on the selected frequency and the amount of gain (expressed in dB); the bandwidth of the filters also plays an important role. Here, we generally use the so-called *absolute* bandwidth of a filter, which is measured from the lower to the upper cutoff frequency. Starting from there, you can divide the absolute bandwidth by the filter's center frequency to calculate the *relative* bandwidth. The *quality factor* (Q) is simply the reciprocal value of the relative bandwidth.

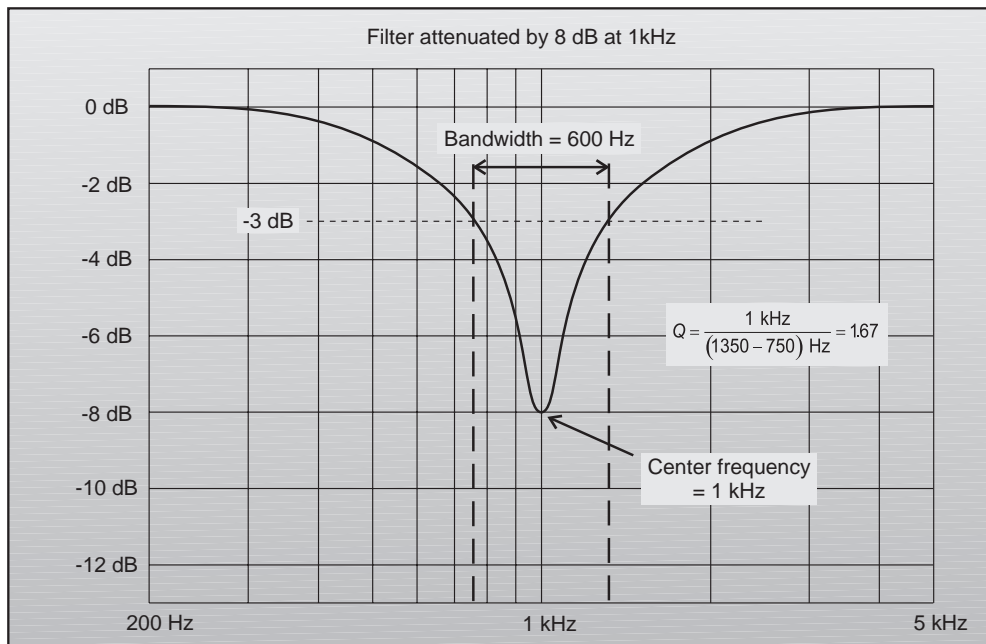

Fig. 4.2: Typical equalizer filter curve

The filter bandwidth can also be expressed in *octaves* (as on the FEEDBACK DESTROYER PRO). The following table shows a list of decimal Q values vs. octaves:

Octave	Quality factor (Q)
1/6	8.65
1/4	5.76
1/3	4.32
1/2	2.87
3/4	1.90
1	1.41
3/2	0.92
2	0.67
3	0.40

Tab. 4.1: Octaves vs. Q factors

Now the following relationship becomes clear: the higher the Q factor, the narrower the frequency band that can be cut or boosted. On the BEHRINGER FEEDBACK DESTROYER PRO you can adjust the relative bandwidth conveniently with the infinitely variable jog wheel. The filter bandwidth can be tuned from 2 octaves (120/60 octaves) down to 1/60 octave (for fine adjustments).

## 4.1 Feedback

Almost every concert goer may have experienced the howling and squealing of an improperly set sound reinforcement system. Feedback is one of the main problems encountered during live events. A feedback loop is produced when a microphone signal is reproduced by an amplifier system, to be picked up again (with the same phase) by the microphone. Thus, feedback is built up at all frequencies where the distance between microphone and speaker corresponds to a multiple of the signal's wavelength.

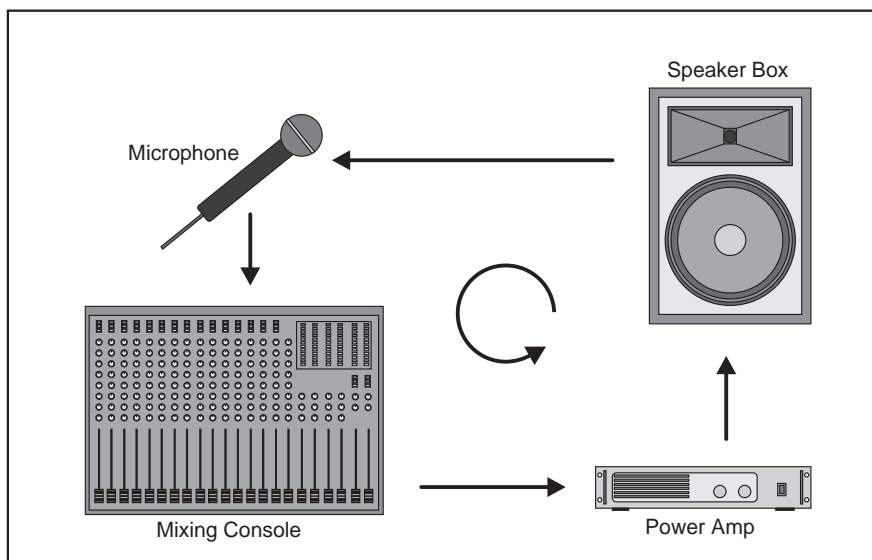

Fig. 4.3: Typical feedback loop

Basically, any microphone signal passing through an amplifier is liable to generate feedback. Unfortunately, the feedback frequencies of P.A. systems differ, and even one single system can have varying feedback frequencies, as these depend largely on the room acoustics. Feedback can be caused by the following conditions:

- ▲ The microphones are too close to the speaker boxes or the speakers are badly positioned (monitor system).
- ▲ The microphone channels on the mixing console are not set up correctly.
- ▲ The microphones used are not operated in accordance with their directivity (e.g. cardioid/super-cardioid).
- ▲ The acoustic properties of the room are unfavorable. Tiled walls and floors heavily reflect the sound.

All rooms feature a number of natural resonances sometimes with “high” quality factor. At such frequencies the potential risk of feedback is increased. In addition to the acoustic properties of the room, the relative position of the microphone with reference to the loudspeaker plays a decisive role for the generation of feedback. In practice, this phenomenon can be observed with microphone held directly in front of a speaker, thus producing feedback. Of course, the first thing to do in such a case is to move the microphone away from the speaker. When doing so, you can hear the feedback frequency change, because a variation in the distance between microphone and loudspeaker results in a variation of feedback frequencies. It is therefore very difficult to anticipate feedback frequencies and avoid their occurrence by means of equalizers with fixed settings.

## 4.2 Graphic equalizers

Graphic equalizers are part of the audio engineer’s standard equipment for live applications. In this context, graphic EQ’s usually perform three main tasks:

- ▲ Fine tuning the mix to your taste and the style of music.
- ▲ Fine tuning the mix to the room and speaker acoustics.
- ▲ To some extent, audio engineers can use graphic EQ’s to manually suppress annoying feedback.

The 1/3-octave design with 31 faders per channel has become the standard among graphic equalizers. Here, the spacing between individual filter frequencies is 1/3 octave. The quality factor (Q) of the filters (usually 1/3 octave) is fixed as are the frequencies controlled with the 31 filters.

1/3-octave equalizers are very popular (e.g. our ULTRA-CURVE PRO DSP8024) because they are so easy to operate. The fader positions clearly show how the signal is being processed, especially since graphic EQ’s have fixed frequencies based on the so-called ISO standard. So, all graphic equalizers designed to meet the ISO standard feature the same fixed frequencies. Once you’ve got used to work with a 1/3-octave equalizer, you will find the FEEDBACK DESTROYER PRO a highly convenient tool, as it splits up the audio spectrum into the ISO frequencies (see table 1.2), which enables you to access the most important frequencies quickly.

Of course, you can use the FINE button to fine tune to frequencies between the standard ISO frequencies (in 1/60-octave steps) within a range of 1/3 octave.

<b>Hz</b>	20	25	31,5	40	50	63	80	100	125	160	200	250	315	400	500	630	800
<b>kHz</b>	1	1,25	1,6	2	2,5	3,15	4	5	6,3	8	10	12,5	16	20			

Tab. 4.2: standard ISO frequencies



### 4.3 Parametric equalizers

Parametric equalizers, unlike graphic EQ's, allow for selecting both the processing frequency and the bandwidth, so that it is possible to process any given signal in full detail. Naturally, this equalizer design can also be used to "filter" unwanted signals, however, only if these signal have a fixed frequency. If the frequency changes, the parametric equalizer would have to be readjusted all the time. The majority of (analog) parametric EQ's suffers from a quite fundamental drawback: they are operated by means of rotary controls, i.e. contrary to graphic EQ's, it is much more difficult to make necessary readjustments quickly.

### 4.4 The FEEDBACK DESTROYER PRO

As you have seen, suppressing feedback with a standard graphic and/or parametric equalizer often means that you have to accept compromises. Since feedback signals fail to comply with the standard ISO frequencies of graphic EQ's and additionally can have changing frequencies, their suppression with a graphic equalizer is more or less a matter of luck.

Example: let's assume a feedback signal at 1.8 kHz is produced during a concert. To suppress it, you've got to cut the 1.8 kHz band on your EQ. However, since graphic equalizers only have 1.6 and 2 kHz bands, you might need to attenuate both bands. Result: although feedback will be eliminated due to the low filter quality, you will also fade out many music signals which you'd actually wish to keep. Additionally, cutting these midrange frequencies also means that your P.A. system loses power and performance.

In theory, a parametric EQ can be used to suppress feedback by means of high filter qualities. However, your tweeters may well have gone up in smoke before you've found the frequency at which feedback occurs and managed to eliminate it by adjusting the filter frequency, bandwidth and gain accordingly. For this reason, the FEEDBACK DESTROYER PRO also uses a highly optimized version of the automated, fully parametric filters we designed for the BEHRINGER ULTRA-CURVE. With the FEEDBACK DESTROYER PRO your P.A. system will be under your control again!

Unlike many conventional equalizers, the FEEDBACK DESTROYER PRO provides an impressive range of features:

- ▲ If required, the FEEDBACK DESTROYER PRO detects and suppresses feedback automatically by analyzing the music signal and determining the frequency of the interference signal. Additionally, it calculates the filter quality and attenuation necessary to fade out feedback.
- ▲ The FEEDBACK DESTROYER PRO calculates the filter quality with such a high precision that nothing but the feedback signal will be filtered, while retaining the original music signal. This means increased P.A. headroom and a more balanced, powerful and transparent sound image.
- ▲ With the FEEDBACK DESTROYER PRO almost all of the power delivered by the amps will reach the speakers, because the precisely set, narrow-band filters reduce energy losses to a minimum.
- ▲ The filters can be operated both in manual and automatic mode. Naturally, you can combine both modes in single programs.
- ▲ Clearly structured entry keys give you direct access to essential parameters, while the jog wheel allows you to conveniently adjust them as desired. Favorite settings can be stored in 10 preset programs. Of course, the FEEDBACK DESTROYER PRO fully integrates into any MIDI system.
- ▲ This enormous processing power is provided by a "software-separated" 24-bit Dual-Engine processor. The FEEDBACK DESTROYER PRO precisely converts your music with 20-bit AD/DA converters using a pro-level sampling rate of 46 kHz. The high-grade components and circuitry make sure that the quality of the 24 fully parametric EQ's meets studio standards.

- ▲ Quick filter settings can be realized by using standard ISO values for the allocation of frequency bands. Subsequently, you can fine tune the frequency of your choice.

## 4.5 Digital audio processing

In order to convert an analog signal - e.g. music - into a series of digital words, a so-called "Analogue to Digital Converter" or ADC is used. The converter functions by viewing the signal entering it a given number of times over a period of time, e.g. 44,100 times per second, giving a rate of 44.1 kHz, and in each case measuring the signal amplitude, and giving it a numerical value. This form of measuring the signal regularly over a period of time is known as "sampling", the conversion of the amplitude into a numerical value, quantizing. The two actions together are referred to as digitizing.

In order to carry out the opposite - the conversion of a digitized signal into its original analogue form - a "Digital to Analogue Converter" or DAC is used. In both cases the frequency at which the device operates is called the sampling rate. The sampling rate determines the effective audio frequency range. The sampling rate must always be more than twice the value of the highest frequency to be reproduced. Therefore, the well known CD sampling rate of 44.1 kHz is slightly higher than twice the highest audible frequency of 20 kHz. The accuracy at which quantization takes place is primarily dependent on the quality of the ADCs and DACs being used.

The resolution, or size of digital word used (expressed in bits), determines the theoretical Signal/Noise ratio (S/N ratio) the audio system is capable of providing. The number of bits may be compared to the number of decimal places used in a calculation - the greater the number of places, the more accurate the end result. Theoretically, each extra bit of resolution should result in the S/N ratio increasing by 6 dB. Unfortunately, there are a considerable number of other factors to be taken into account, which hinder the achievement of these theoretical values.

If you picture an analog signal as a sinusoidal curve, then the sampling procedure may be thought of as a grid superimposed on the curve. The higher the sampling rate (and the higher the number of bits), the finer the grid. The analog signal traces a continuous curve, which very seldom coincides with the cross points of the grid. A signal level at the sampling points will still be assigned a digital value, usually the one closest to the exact representation. This limit to the resolution of the grid gives rise to errors, and these errors are the cause of quantizing noise. Unfortunately, quantizing noise has the characteristic of being much more noticeable and unpleasant to the ear than "natural" analog noise.

In a digital signal processor, such as the DSPs in the FEEDBACK DESTROYER PRO, the data will be modified in a number of ways, in other words, various calculations, or processes, will be done in order to achieve the desired effect on the signal. This gives rise to further errors, as these calculations are approximations, due to their being rounded off to a defined number of decimal places. This causes further noise. To minimize these rounding off errors, the calculations must be carried out with a higher resolution than that of the digital audio data being processed (as a comparison, an electronic calculator may operate internally with a greater number of decimal places than can be shown on its display). The DSPs in the FEEDBACK DESTROYER PRO operate with a 24 bit resolution. This is accurate enough to reduce quantizing noise to levels which are usually below the audible threshold. However, when using extreme equalizer settings, some quantizing side effects may be detected.

Digital sampling has one further, very disturbing effect: it is very sensitive to signal overload. Take the following simple example using a sine wave. If an analog signal starts to overload, it results in the amplitude of the signal reaching a maximum level, and the peaks of the wave starting to get compressed, or flattened. The greater the proportion of the wave being flattened, the more harmonics, audible as distortion, will be heard. This is a gradual process, the level of distortion as a percentage of the total signal rising with the increase of the input signal level.



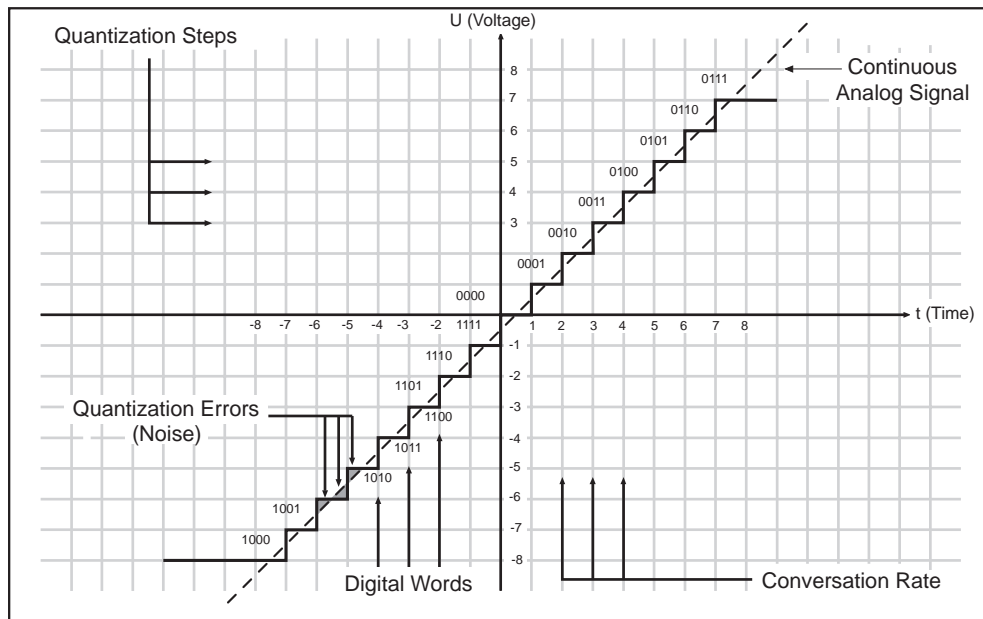



Fig. 4.4: Transfer diagram for an ideal linear ADC (2's complement representation)

Digital distortion is quite different, as illustrated by this simplified example. If we take the situation where a 4 bit word has the positive maximum value of 0111, and add to it the smallest possible value of 0001 (in other words, the smallest increase in amplitude possible), the addition of the two results in 1000 - the value of the "negative" maximum. The value is turned on its head, going instantly from positive max to negative max, resulting in the very noticeable onset of extreme signal distortion.

## 5. INSTALLATION

Your BEHRINGER FEEDBACK DESTROYER PRO was carefully packed in the factory and the packaging was designed to protect the unit from rough handling. Nevertheless, we recommend that you carefully examine the packaging and its contents for any signs of physical damage, which may have occurred in transit.

 **If the unit is damaged, please do not return it to us, but notify your dealer and the shipping company immediately, otherwise claims for damage or replacement may not be granted. Shipping claims must be made by the consignee.**

### 5.1 Rack mounting

The BEHRINGER FEEDBACK DESTROYER PRO fits into one standard 19" rack unit of space (1 3/4"). Please allow at least an additional 4" depth for the connectors on the back panel. Be sure that there is enough air space around the unit for cooling and please do not place the FEEDBACK DESTROYER PRO on high temperature devices such as power amplifiers etc. to avoid overheating.

### 5.2 Mains connection

The mains connection of the FEEDBACK DESTROYER PRO is made by using a mains cable and a standard IEC receptacle. It meets all of the international safety certification requirements.

 **Please make sure that all units have a proper ground connection. For your own safety, do not remove the ground connection within the units or at the supply, or fail to make this connection at all.**

Before you switch on the unit, check that it is configured to match your AC mains voltage requirements. If it

does not comply, then it is necessary to switch the operating voltage to the correct supply requirements BEFORE turning on the unit, otherwise the unit could be severely damaged. You will find this combined fuse holder/voltage selector at the back, adjacent to the IEC receptacle. **IMPORTANT: This does not apply for general export models which are built for one operating voltage only.**

The AC voltage selection is defined by the position of the fuse holder. If you intend to change the operating voltage, remove the fuse holder and twist it by 180 degrees before you reinsert it. Matching the two markers monitors the selected voltage.

**⚠ If the unit is switched to an other operating voltage, the fuse rating must be changed. See the technical specifications in the appendix**

A safety fuse protects the unit from serious defects. If the fuse blows, this is a warning sign and always indicates that the circuit is overloaded. The fault must always be repaired before the fuse is replaced. If the safety fuse is faulty and needs replacing after the unit is repaired, please make sure that you replace it only with the identical type and rating. NEVER use fuses of different ratings or cover faulty fuses with aluminium foil. This can cause fire and electric shocks and will endanger your life and the lives of others.

### 5.3 Audio connections

As standard, the BEHRINGER FEEDBACK DESTROYER PRO is installed with electronically servo-balanced inputs and outputs. The new circuit design features automatic hum and noise reduction for balanced signals and thus allows for trouble-free operation, even at high operating levels. Externally induced mains hum etc. will be effectively suppressed. The automatic servo-function recognizes the presence of unbalanced connectors and adjusts the nominal level internally to avoid level differences between the input and output signals (correction 6 dB).

**⚠ Please ensure that only qualified persons install and operate the FEEDBACK DESTROYER PRO. During installation and operation the user must have sufficient electrical contact to earth. Electrostatic charges might affect the operation of the FEEDBACK DESTROYER PRO!**

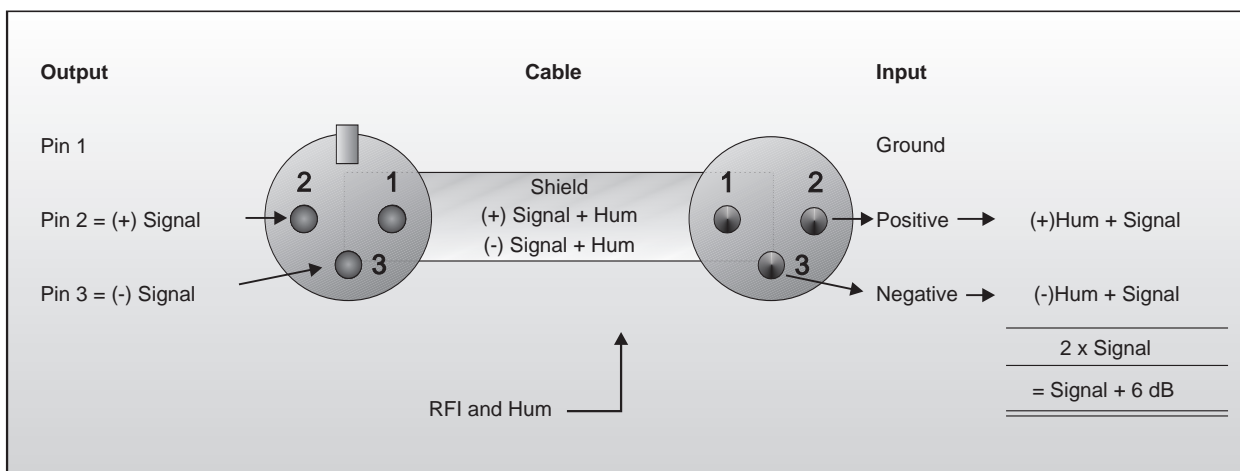

Fig. 5.1: Compensation of interference with balanced connections

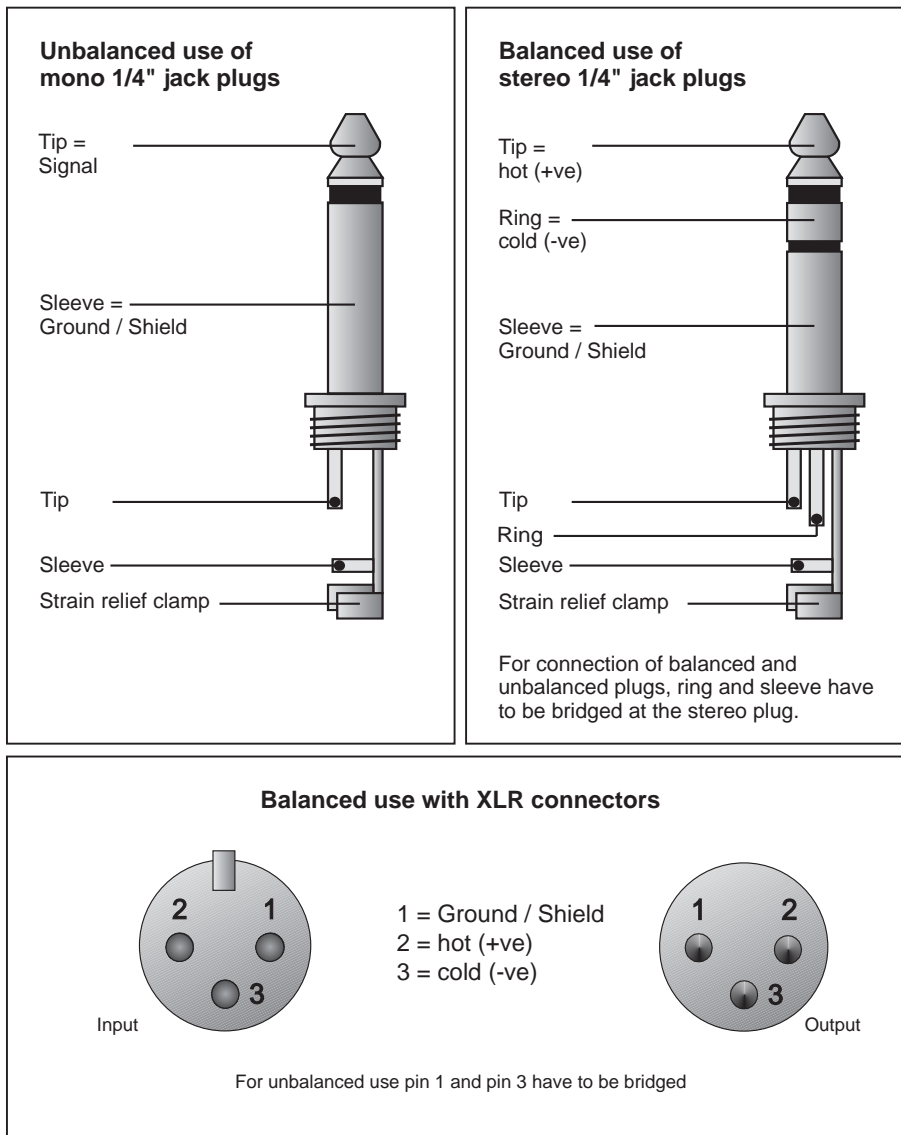

Fig. 5.2: Different plug types

## 5.4 MIDI connections

The MIDI standard was developed in the early 1980s to allow electronic musical instruments from different manufacturers to communicate with each other. The use of MIDI has developed over the intervening years to the stage where it is now common to find complete recording studios operating entirely on a MIDI basis. The centerpiece in such a studio is usually a computer running a sequencer software which not only controls various keyboards, samplers and sound modules, but can also run the programming of outboard effect devices, typically digital reverberation and delay units. The FEEDBACK DESTROYER PRO may be controlled in real time in this studio environment.

### MIDI for Musical Instruments Digital Interface.

The MIDI connectors found on the rear panel are of the universally used 5 pin DIN type. You require suitable MIDI cables to connect the FEEDBACK DESTROYER PRO to other MIDI devices. Normally complete cables will be purchased for this use, you can of course make your own, using a high quality cable with two cores and shielding (like microphone cable), with as connectors two good 180 degree DIN plugs. Pin 2 (center) is connected to the cable's shield, pins 4 and 5 (left and right next to 2) carry the two cores, pins 1 and 3 are not used. MIDI cables should have a maximum length not exceeding 45 feet.

## 5.5 Operating level Switch

To adapt the FEEDBACK DESTROYER PRO to the used operating level, the unit can be switched between homerecording level (-10 dBV) and professional level (+4 dBu). Use the LED bars on the frontpanel to determine the optimal setting. The Level indicators should read somewhere between -10 and -6 dB, while the clip LED should not light up at all.

## 6. APPENDIX

### 6.1 Frequency chart

In order to maintain a better survey only every second value is registered in the table. The adjustable values do not exactly fit into a 1/60 octave interval, because also the ISO frequencies do not perfectly fit into a physical 1/3 octave interval. Rather a linear approximation is used to specify the values.

Background  $f_1, f_2, \dots$  ISO frequency  
 1 third = 20/60 octave (idealized ISO interval)

$$\text{increment } \Delta f_n = \frac{(f_{n+1} - f_n)}{20}$$

Display	-9/60	-8/60	-6/60	-4/60	-2/60	ISO	+2/60	+4/60	+6/60	+8/60	+10/60	Display
20 Hz						20	20.5	21	21.5	22	22.5	20 Hz
25 Hz	22.8	23	23.5	24	24.5	25	25.7	26.3	27	27.6	28.3	25 Hz
32 Hz	28.6	28.9	29.6	30.2	30.9	31.5	32.4	33.2	34.1	34.9	35.8	32 Hz
40 Hz	36.2	36.6	37.5	38.3	39.2	40	41	42	43	44	45	40 Hz
50 Hz	45.5	46	47	48	49	50	51	53	54	55	57	50 Hz
63 Hz	57	58	59	60	62	63	65	66	68	70	71.5	63 Hz
80 Hz	72.4	73	75	77	78	80	82	84	86	88	90	80 Hz
100 Hz	91	92	94	96	98	100	103	105	108	110	113	100 Hz
125 Hz	114	115	118	120	123	125	129	132	136	139	143	125 Hz
160 Hz	144	146	150	153	157	160	164	168	172	176	180	160 Hz
.20 kHz	182	184	188	192	196	200	205	210	215	220	225	.20 kHz
.25 kHz	228	230	235	240	245	250	257	263	270	276	283	.25 kHz
.32 kHz	286	289	296	302	309	315	324	332	341	349	358	.32 kHz
.40 kHz	362	366	375	383	392	400	410	420	430	440	450	.40 kHz
.50 kHz	455	460	470	480	490	500	513	526	539	552	565	.50 kHz
.63 kHz	572	578	591	604	617	630	647	664	681	698	715	.63 kHz
.80 kHz	724	732	749	766	783	800	820	840	860	880	900	.80 kHz
1.00 kHz	910	920	940	960	980	1000	1025	1050	1075	1100	1125	1.00 kHz
1.25 kHz	1138	1150	1175	1200	1225	1250	1285	1320	1355	1390	1425	1.25 kHz
1.60 kHz	1443	1460	1495	1530	1565	1600	1640	1680	1720	1760	1800	1.60 kHz
2.0 kHz	1820	1840	1880	1920	1960	2000	2050	2100	2150	2200	2250	2.0 kHz
2.5 kHz	2275	2300	2350	2400	2450	2500	2565	2630	2695	2760	2825	2.5 kHz
3.2 kHz	2858	2890	2955	3020	3085	3150	3235	3320	3405	3490	3575	3.2 kHz
4.0 kHz	3618	3660	3745	3830	3915	4000	4100	4200	4300	4400	4500	4.0 kHz
5.0 kHz	4550	4600	4700	4800	4900	5000	5130	5260	5390	5520	5650	5.0 kHz
6.3 kHz	5715	5780	5910	6040	6170	6300	6470	6640	6810	6980	7150	6.3 kHz
8.0 kHz	7235	7320	7490	7660	7830	8000	8200	8400	8600	8800	9000	8.0 kHz
10.0 kHz	9100	9200	9400	9600	9800	10000	10250	10500	10750	11000	11250	10.0 kHz
12.5 kHz	11375	11500	11750	12000	12250	12500	12850	13200	13550	13900	14250	12.5 kHz
16.0 kHz	14425	14600	14950	15300	15650	16000	16400	16800	17200	17600	18000	16.0 kHz
20 kHz	18200	18400	18800	19200	19600	20000						20 kHz

Tab. 6.1: frequency chart

## 6.2 Preset table

Preset	Filter 1	Filter 2	Filter 3	Filter 4	Filter 5	Filter 6	Filter 7	Filter 8	Filter 9	Filter 10	Filter 11	Filter 12
<b>1</b>	MONO: 9 single shot filters attenuate room resonances before 3 automatic filters destroy variable feedbacks											
L	SI	SI	SI	SI	SI	SI	SI	SI	SI	AU	AU	AU
R	SI	SI	SI	SI	SI	SI	SI	SI	SI	AU	AU	AU
<b>2</b>	2 x MONITOR AS FEEDBACK DESTROYER ONLY: 7 single shots / 5 automatic filters for most monitor setups											
L	SI	SI	SI	SI	SI	SI	SI	AU	AU	AU	AU	AU
R	SI	SI	SI	SI	SI	SI	SI	AU	AU	AU	AU	AU
<b>3</b>	MONO AUTO PILOT: 12 Filters per channel constantly chase and destroy feedbacks.											
L	AU	AU	AU	AU	AU	AU	AU	AU	AU	AU	AU	AU
R	AU	AU	AU	AU	AU	AU	AU	AU	AU	AU	AU	AU
<b>4</b>	STEREO PARAMETRIC EQ: Preset with 12 ISO frequencies, all set to 1/3 Oct., Gain + 0 dB											
Couple	125 Hz	160 Hz	200 Hz	250 Hz	315 Hz	400 Hz	500 Hz	630 Hz	800 Hz	1 k	1.25 k	1.6 k
<b>5</b>	STEREO PARAMETRIC EQ: Preset with 12 ISO frequencies, all set to 2/3 Oct., Gain + 0 dB											
Couple	40 Hz	63 Hz	100 Hz	160 Hz	250 Hz	400 Hz	630 Hz	1 k	1.6 k	2.5 k	4 k	6.3 k
<b>6</b>	2 x MONO: Sample monitoring, left for handheld (lead) microphone(s), right for fixed (backing) ones											
L	SI	SI	SI	AU	AU	AU	AU	AU	PA def	PA def	PA def	PA def
R	SI	SI	SI	SI	SI	AU	AU	AU	PA def	PA def	PA def	PA def
<b>7</b>	MONO PARAMETRIC AND SINGLE SHOT FILTERS: A good start for a monitor equalization											
L	SI	SI	SI	SI	SI	SI	SI	SI	PA def	PA def	PA def	PA def
R	SI	SI	SI	SI	SI	SI	SI	SI	PA def	PA def	PA def	PA def
<b>8</b>	STEREO FOH EQ, providing 4 parametric EQ's (low roll off in filter 1 and 2), plus 8 single shot filters											
Couple	PA	PA	PA d.	PA d.	SI	SI	SI	SI	SI	SI	SI	SI
	40 Hz	80 Hz	Channels coupled, changes on one channel are valid for both									
	1 Oct.	1 Oct.										
	-8 dB	-4 dB										
<b>9</b>	MONO FREE											
L, R	SI	SI	SI	SI	SI	SI	SI	AU	AU	PA	PA	PA
	SI	SI	SI	SI	SI	SI	SI	AU	AU	PA	PA	PA
<b>10</b>	STEREO FREE											
Couple	SI	SI	SI	SI	SI	SI	SI	AU	AU	PA	PA	PA

Tab. 6.2: Factory presets

### 6.3 MIDI implementation

Parameter Name	Display Range	Midi Control Number	Control Value Range	LEDs					
				Couple	Left	Right	IN on	IN off	IN flashing
Filter Select	1..12	10	0..11						
Filter Mode	OF, PA, AU, SI	11	0..3						
Engine		12	0,1,2	0	1	2			
Frequency	20 (Hz)..20 (kHz)	13	0..30						
Fine (1/60 Oct)	-9..+10	14	0..19						
Bandwidth	1..120	15	0..119						
Gain	-48..+16	16	0..64						
Feedback Threshold	-3..-9	17	0..6						
Store	1..10	18	0..9						
In/Out		19	0..2				2	1	0

Tab. 6.3: Controller functions with MIDI

Function		Transmitted	Recognized	Remarks
Basic	Default	OFF, 1 - 16	OFF, 1 - 16	memorized
Channel	Changed	OFF, 1 - 16	OFF, 1 - 16	
Mode	Default	1,2,3,4	1,2,3,4	
	Messages	X	X	
	Altered	X	X	
Note Number		X	X	
	True Voice	X	X	
Velocity	Note ON	X	X	
	Note OFF	X	X	
After Touch	Key's	X	X	
	Ch's	X	X	
Pitch Bender		X	X	
Control		O 10 - 19	O 10 - 19	see add. Table
Progr.		O (0-9)	O (0-9)	
Change	True #	1-10	1-10	
System Exclusive		O	O	
System Common	Song Pos	X	X	
	Song Sel	X	X	
	Tune	X	X	
System Real Time	Clock	X	X	
	Commands	X	X	
Aux Messages	Local ON/OFF	X	X	
	All notes OFF	X	X	
	Active Sense	X	X	
	Reset	X	X	
Notes				

O = YES, X = NO

- Mode 1: OMNI ON, POLY
- Mode 2: OMNI ON, MONO
- Mode 3: OMNI OFF, POLY
- Mode 4: OMNI OFF, MONO

Tab. 6.4: MIDI implementation chart

## 6.4 Specifications

### Analog Inputs

Connectors	XLR and 1/4" jack
Type	RF filtered, servo balanced input
Impedance	60 kOhms balanced, 30 kOhms unbalanced
Nominal Operating Level	-10dBV to +4dBu
Max. Input Level	+16 dBu at +4 dB nominal level, +2 dBV at -10 dBV nominal level

### Analog Outputs

Connectors	XLR and 1/4" jack
Type	Electronically servo-balanced output stage
Impedance	60 Ohms balanced, 30 Ohms unbalanced
Max. Output Level	+16 dBu at +4 dB nominal level, +2 dBV at -10 dBV nominal level

### System specifications

Bandwidth	20 Hz to 20 kHz, -3 dB
Noise	>-94 dB, unweighted, 20 Hz to 20 kHz
THD	0.0075 % typ. @ +4 dBu, 1 kHz, Gain 1
Crosstalk	< -76 dB

### MIDI Interface

Type	5-Pin-DIN-Socket IN / OUT / THRU
------	----------------------------------

### Digital Processing

Converters	20-bit Sigma-Delta, 64/128-times Oversampling
Sampling Rate	46,875 kHz

### Display

Type	2 ½-digit numeric LED-Display
------	-------------------------------

### Power Supply

Mains Voltages	USA/Canada	~ 120 V AC, 60 Hz
	U.K./Australia	~ 240 V AC, 50 Hz
	Europe	~ 230 V AC, 50 Hz
	General Export Model	~ 100-120 V AC, ~ 200-240 V AC, 50-60 Hz
Fuse	100-120 V AC:	<b>125 mA (slow-blow)</b>
	200-240 V AC:	<b>63 mA (slow-blow)</b>
Power Consumption	10 Watts	
Mains Connection	Standard IEC receptacle	

### Physical

Dimensions (H * W * D)	1 3/4" (44.5 mm) * 19" (482.6 mm) * 7 1/2" (190.5 mm)
Net Weight	± 2 kg
Shipping Weight	± 3 kg

BEHRINGER is constantly striving to maintain the highest professional standards. As a result of these efforts, modifications may be made from time to time to existing products without prior notice. Specifications and appearance may differ from those listed or shown.



## 7. WARRANTY

### § 1 WARRANTY CARD

To be protected by this warranty, the buyer must complete and return the enclosed warranty card (signed/stamped by retail dealer) within 14 days of the date of purchase to BEHRINGER INTERNATIONAL (address see § 3). Failure to return the card in due time (date as per postmark) will void any extended warranty claims.

### § 2 WARRANTY

1. BEHRINGER INTERNATIONAL warrants the mechanical and electronic components of this product to be free of defects in material and workmanship for a period of one (1) year from the original date of purchase, in accordance with the warranty regulations described below. If any defects occur within the specified warranty period that are not caused by normal wear or inappropriate use, BEHRINGER INTERNATIONAL shall, at its sole discretion, either repair or replace the product.

2. If the warranty claim proves to be justified, the product will be returned freight prepaid by BEHRINGER INTERNATIONAL within Germany. Outside of Germany, the product will be returned at the buyer's expense.

3. Warranty claims other than those indicated above are expressly excluded.

### § 3 RETURN AUTHORIZATION NUMBER

1. To obtain warranty service, the buyer must call BEHRINGER INTERNATIONAL during normal business hours BEFORE returning the product (Tel.: +49 (0) 21 54 / 92 06 66). All inquiries must be accompanied by a description of the problem. BEHRINGER INTERNATIONAL will then issue a return authorization number.

2. The product must be returned in its original shipping carton, together with the return authorization number, to the following address:

**BEHRINGER INTERNATIONAL GmbH  
Service Department**

**Hanns-Martin-Schleyer-Str. 36-38**

**D - 47877 Willich-Münchheide**

3. Shipments without freight prepaid will not be accepted.

### § 4 WARRANTY REGULATIONS

1. Warranty services will be furnished only if the product is accompanied by an original retail dealer's invoice. Any product deemed eligible for repair or replacement by BEHRINGER INTERNATIONAL under the terms of this warranty will be repaired or replaced within 30 days of receipt of the product at BEHRINGER INTERNATIONAL.

2. If the product needs to be modified or adapted in order to comply with applicable technical or safety standards on a national or local level, in any country which is not the country for which the product was originally developed and manufactured,

this modification/adaptation shall not be considered a defect in materials or workmanship. The warranty does not cover any such modification/adaptation, irrespective of whether it was carried out properly or not. Under the terms of this warranty, BEHRINGER INTERNATIONAL shall not be held responsible for any cost resulting from such a modification/adaptation.

3. Free inspections, maintenance/repair work and replacement of parts are expressly excluded from this warranty, in particular if caused by inappropriate use. Likewise, the warranty does not cover defects of expendable parts caused by normal wear of the product. Expendable parts are typically faders, potentiometers, switches and similar components.

4. Damages/defects caused by the following conditions are not covered by this warranty:

▲ misuse, neglect or failure to operate the unit in compliance with the instructions given in the user or service manuals.

▲ connection or operation of the unit in any way that does not comply with the technical or safety regulations applicable in the country where the product is used.

▲ damages/defects that are caused by force majeure or by any other condition beyond the control of BEHRINGER INTERNATIONAL.

5. Any repair carried out by unauthorized personnel will void the warranty.

6. Products which do not meet the terms of this warranty will be repaired exclusively at the buyer's expense. BEHRINGER INTERNATIONAL will inform the buyer of any such circumstance. If the buyer fails to submit a written repair order within 4 weeks after notification, BEHRINGER INTERNATIONAL will return the unit C.O.D. with a separate invoice for freight and packing. Such cost will also be invoiced separately when the buyer has sent in a written repair order.

### § 5 WARRANTY TRANSFERABILITY

This warranty is extended exclusively to the original buyer (customer of retail dealer) and is not transferable to anyone who may subsequently purchase this product. No other person (retail dealer, etc.) shall be entitled to give any warranty promise on behalf of BEHRINGER INTERNATIONAL.

### § 6 CLAIM FOR DAMAGES

Failure of BEHRINGER INTERNATIONAL to provide proper warranty service shall not entitle the buyer to claim (consequential) damages. In no event shall the liability of BEHRINGER INTERNATIONAL exceed the invoiced value of the product.

### § 7 OTHER WARRANTY RIGHTS

This warranty does not exclude or limit the buyer's statutory rights provided by national law, in particular, any such rights against the seller that arise from a legally effective purchase contract.

---

The information contained in this manual is subject to change without notice. No part of this manual may be reproduced or transmitted in any form or by any means, electronic or mechanical, including photocopying and recording of any kind, for any purpose, without the express written permission of BEHRINGER GmbH.

BEHRINGER, ULTRA-CURVE and FEEDBACK DESTROYER are registered trademarks.

ALL RIGHTS RESERVED © 1998 BEHRINGER.

BEHRINGER INTERNATIONAL GmbH, Hanns-Martin-Schleyer-Str. 36-38, D-47877 Willich-Münchheide II

Tel. +49 (0) 21 54 / 92 06-0, Fax +49 (0) 21 54 / 92 06-30

---



## Free Manuals Download Website

<http://myh66.com>

<http://usermanuals.us>

<http://www.somanuals.com>

<http://www.4manuals.cc>

<http://www.manual-lib.com>

<http://www.404manual.com>

<http://www.luxmanual.com>

<http://aubethermostatmanual.com>

Golf course search by state

<http://golfingnear.com>

Email search by domain

<http://emailbydomain.com>

Auto manuals search

<http://auto.somanuals.com>

TV manuals search

<http://tv.somanuals.com>