

DENOISER®

SNR2000

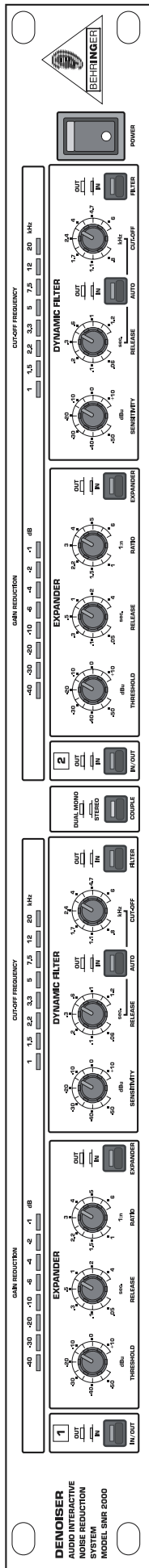

User's Manual

Version 2.3 June 2002

ENGLISH



www.behringer.com

SAFETY INSTRUCTIONS

CAUTION: To reduce the risk of electrical shock, do not remove the cover (or back). No user serviceable parts inside; refer servicing to qualified personnel.



WARNING: To reduce the risk of fire or electrical shock, do not expose this appliance to rain or moisture.



This symbol, wherever it appears, alerts you to the presence of uninsulated dangerous voltage inside the enclosure – voltage that may be sufficient to constitute a risk of shock.



This symbol, wherever it appears, alerts you to important operating and maintenance instructions in the accompanying literature. Read the manual.

DETAILED SAFETY INSTRUCTIONS:

All the safety and operation instructions should be read before the appliance is operated.

Retain Instructions:

The safety and operating instructions should be retained for future reference.

Heed Warnings:

All warnings on the appliance and in the operating instructions should be adhered to.

Follow instructions:

All operation and user instructions should be followed.

Water and Moisture:

The appliance should not be used near water (e.g. near a bathtub, washbowl, kitchen sink, laundry tub, in a wet basement, or near a swimming pool etc.).

Ventilation:

The appliance should be situated so that its location or position does not interfere with its proper ventilation. For example, the appliance should not be situated on a bed, sofa rug, or similar surface that may block the ventilation openings: or placed in a built-in installation, such as a bookcase or cabinet that may impede the flow of air through the ventilation openings.

Heat:

The appliance should be situated away from heat sources such as radiators, heat registers, stoves, or other appliances (including amplifiers) that produce heat.

Power Source:

The appliance should be connected to a power supply only of the type described in the operating instructions or as marked on the appliance.

Grounding or Polarization:

Precautions should be taken so that the grounding or polarization means of an appliance is not defeated.

Power-Cord Protection:

Power supply cords should be routed so that they are not likely to be walked on or pinched by items placed upon or against them, paying particular attention to cords and plugs, convenience receptacles and the point where they exit from the appliance.

Cleaning:

The appliance should be cleaned only as recommended by the manufacturer.

Non-use Periods:

The power cord of the appliance should be unplugged from the outlet when left unused for a long period of time.

Object and Liquid Entry:

Care should be taken so that objects do not fall and liquids are not spilled into the enclosure through openings.

Damage Requiring Service:

The appliance should be serviced by qualified service personnel when:

- the power supply cord or the plug has been damaged; or
- objects have fallen, or liquid has been spilled into the appliance; or
- the appliance has been exposed to rain; or
- the appliance does not appear to operate normally or exhibits a marked change in performance; or
- the appliance has been dropped, or the enclosure damaged.

Servicing:

The user should not attempt to service the appliance beyond that which is described in the Operating Instructions. All other servicing should be referred to qualified service personnel.

FOREWORD

Dear Customer,

Welcome to the team of DENOISER users and thank you very much for expressing your confidence in BEHRINGER products by purchasing the SNR2000.

It is one of my most pleasant tasks to write this letter to you, because it is the culmination of many months of hard work delivered by our engineering team to reach a very ambitious goal: making an outstanding device that will become a standard tool used by studios and P.A. companies. The task to design the DENOISER certainly meant a great deal of responsibility, which we assumed by focusing on you, the discerning user and musician. It also meant a lot of work and night shifts to accomplish this goal. But it was fun, too. Developing a product usually brings a lot of people together, and what a great feeling it is when everybody who participated in such a project can be proud of what we've achieved.

It is our philosophy to share our joy with you, because you are the most important member of the BEHRINGER family. With your highly competent suggestions for new products you've greatly contributed to shaping our company and making it successful. In return, we guarantee you uncompromising quality (manufactured under ISO9000 certified management system) as well as excellent technical and audio properties at an extremely affordable price. All of this will enable you to fully unfold your creativity without being hampered by budget constraints.

We are often asked how we are able to produce such high-grade devices at such unbelievably low prices. The answer is quite simple: it's you, our customers! Many satisfied customers mean large sales volumes enabling us to get better conditions of purchase for components, etc. Isn't it only fair to pass this benefit back to you? Because we know that your success is our success too!

I would like to thank all people whose help on "Project DENOISER" has made it all possible. Everybody has made very personal contributions, starting from the designers of the unit via the many staff members in our company to you, the user of BEHRINGER products.

My friends, it's been worth the trouble!

Thank you very much,

A handwritten signature in black ink, appearing to read 'U. Behringer', with a long horizontal flourish extending to the right.

Uli Behringer

DENOISER®

Professional and all-purpose “single-ended” noise reduction system

- ▲ TAC (Transient Attack Control) dynamic filters respond accurately to signals with fast attacks
- ▲ Auto-filter circuitry for automatic sliding filters
- ▲ IRC (Interactive Ratio Control) downward expander for inaudible noise reduction during signal pauses
- ▲ Accurate “gain reduction” and “cut-off frequency” meters
- ▲ Dual mono or true stereo couple function
- ▲ Servo-balanced inputs and outputs on XLR and 1/4" TRS connectors
- ▲ Relay-controlled hard bypass with auto-bypass function during power failure (failsafe relay)
- ▲ Cut-in delay to avoid switch-on “thumps”
- ▲ Ultra low-noise audio operational amplifiers offer outstanding sound performance
- ▲ High-quality detented potentiometers and illuminated switches
- ▲ High-performance output transformer BEHRINGER OT-1 retrofitable
- ▲ Manufactured under ISO9000 certified management system

TABLE OF CONTENTS

1. INTRODUCTION	6
1.1 The design concept	6
1.2 Before you begin	7
1.3 Control elements	7
1.3.1 Front panel	8
1.3.2 Rear panel	8
2. OPERATION	9
2.1 Operation of the filter section	9
2.1.1 The masking effect	9
2.1.2 The dynamic low-pass filter	9
2.2 The TAC filter of the DENOISER	10
2.2.1 SENSITIVITY control	11
2.2.2 CUT OFF control	11
2.2.3 RELEASE control	11
2.2.4 AUTO switch	12
2.2.5 FREQUENCY meter	12
2.3 Operation of the expander section	12
2.4 The IRC expander of the DENOISER	13
2.4.1 THRESHOLD control	14
2.4.2 RELEASE control	14
2.4.3 RATIO control	14
2.4.4 GAIN REDUCTION meter	14
2.5 The COUPLE function	15
3. APPLICATIONS	15
3.1 Initial settings of the DENOISER	15
3.2 Studio applications	16
3.2.1 Noise reduction during playback	16
3.2.2 Noise reduction during recording	16
3.2.3 Reducing noise on subgroups, monitor and effects buses	17
3.2.4 Noise reduction for effects devices	18
3.2.5 Noise reduction during tape duplication	18
3.2.6 Noise reduction for instruments	18
3.2.7 Reducing noise in P.A. systems	19
3.2.8 Noise reduction in Hi-Fi and video applications	19
4. TECHNICAL BACKGROUND	20
4.1 What are audio dynamics?	20
4.2 Compressors/limiters	21
4.3 Expanders/noise gates	21
4.4 Downward expansion	22
4.5 Noise as physical phenomenon	22
4.6 Companders	22
4.7 The "single-ended" principle	23
5. INSTALLATION	23
5.1 Rack mounting	23
5.2 Audio connections	23
6. SPECIFICATIONS	24
7. WARRANTY	26

1. INTRODUCTION

Thank you very much for expressing your confidence in BEHRINGER products by purchasing the BEHRINGER DENOISER SNR2000.

Electrical noise is still one of the most unpleasant problems in the field of electro-acoustics. The basic noise produced by a single unit is not considered to be annoying. The combination of several instruments, effects devices and tape machines, however, results in a drastic increase in noise level. This requires the use of a noise reduction system.

Conventional noise reduction systems

Conventional noise reduction systems often suffer from several perceivable drawbacks: either the noise reduction process deteriorates the signal by cutting the high-frequency portions, or the dynamic filter reacts too slowly, which makes percussive signals lose its "bite". Last but not least, there are systems which function as simple noise gates and produce unnatural "on/off" effects.

The interactive technology of the DENOISER

With the DENOISER we offer one of the most efficient noise reduction systems using single-ended technology. BEHRINGER's unique filter circuitry in conjunction with the new built-in BEHRINGER audio detectors represents a technical breakthrough in the field of noise reduction systems. Effective noise reduction with minimal signal interference is the result.

The noise reduction capabilities of the BEHRINGER DENOISER are based on bandwidth limiting by means of a dynamic low-pass filter and broadband noise reduction during music pauses by a "downward" expander.

The need for both a professional and all-purpose noise reduction system was the basis for the development of the BEHRINGER DENOISER. Many years of experience in the field of noise reduction technology enabled us to design a system particularly suited to the highest demands.

The TAC (Transient Attack Control) circuitry, a new BEHRINGER development, opens the filter even when processing percussive material, without e.g. cutting a drum's "kick".

A newly developed IRC (Interactive Ratio Control) expander has been integrated into the DENOISER. The ratio of which is automatically adjusted, dependent on the program material. The result is an expander which can be adjusted without deteriorating your audio. Furthermore, the expander is more tolerant of those signals which appear slightly above the background noise.

DENOISER—the professional noise reduction system

The BEHRINGER DENOISER proves to be an excellent tool for the professional sound engineer. Furthermore, the extensive control features provide specific and successful processing of all sortes of program material.

The unit can be used in broadcasting and TV, professional studios, CD mastering studios and for P.A. and intercom systems etc. It is useful for cleaning up studio tracks, tape duplications, motion picture sound tracks, during mixdown, and more.

Be it noise reduction for instruments (guitars, keyboards, etc.) or for effects devices (flangers, distortion units, phasers, chorus units, digital delays, compressors, equalizers, pedal board devices, analog delays, psycho-acoustic effects units, pitch shifters, etc.) the BEHRINGER DENOISER is the no-compromise answer when the situation demands a no-compromise solution.

 **This manual first describes the terminology used, so that you can fully understand the SNR2000 and its functions. Please read the manual carefully and keep it for future reference.**

1.1 The design concept

The philosophy behind BEHRINGER products guarantees a no-compromise circuit design and employs the best choice of components. The operational amplifiers which are used in the DENOISER are exceptional. They boast extreme linearity and very low distortion characteristics. To complement this design the choice of components includes high tolerance resistors and capacitors, detented potentiometers and several other stringently selected elements.

1.2 Before you begin

Your DENOISER was carefully packed in the factory and the packaging is designed to protect the unit from rough handling. Nevertheless, we recommend that you carefully examine the packaging and its contents for any signs of physical damage, which may have occurred during transit.

 **If the unit is damaged, please do not return it to BEHRINGER, but notify your dealer and the shipping company immediately, otherwise claims for damage or replacement may not be granted. Shipping claims must be made by the consignee.**

The BEHRINGER DENOISER fits into one standard 19" rack unit (1 3/4"). Please allow at least an additional 4" depth for the connectors on the back panel.

Be sure that there is enough space around the unit for cooling and please do not place the DENOISER on high temperature devices such as power amplifiers etc. to avoid overheating.

 **Before you connect your DENOISER to the mains, please make sure that your local voltage matches the voltage required by the unit:**

The fuse holder on the female mains connector has 3 triangular markings, with two of these triangles opposing each other. The DENOISER is set to the operating voltage printed next to these markers and can be set to another voltage by turning the fuse holder by 180°. **CAUTION: This instruction does not apply to export models exclusively designed, e.g. for 115-V operation!**

The mains connection of the DENOISER is made by using the enclosed mains cable and a standard IEC receptacle. It meets all of the international safety certification requirements.

 **Please make sure that all units have a proper ground connection. For your own safety, never remove or disable the ground conductor of the unit or of the AC power cable.**

As standard, the BEHRINGER DENOISER features electronically servo-balanced inputs and outputs. The circuit design features automatic hum rejection for balanced signals, permitting trouble-free operation even at highest operating levels. Externally induced power-line hum, etc. is thus suppressed effectively. The automatic servo function recognizes the presence of unbalanced connectors and adjusts the nominal level internally to avoid level differences between the input and output signals (6 dB correction).

You will find additional information in chapter 5 "INSTALLATION".

1.3 Control elements

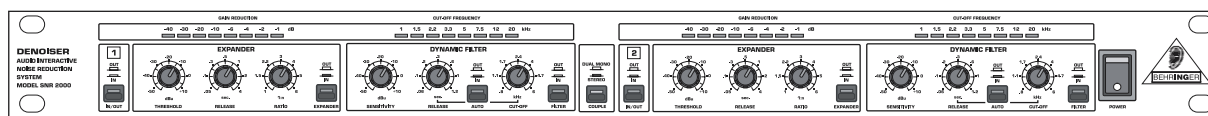

Fig. 1.1: Front panel of the DENOISER

The BEHRINGER DENOISER features two identical channels. Each channel is equipped with four push button switches, six rotary controls and 16 LEDs. The COUPLE switch is for stereo tracking.

1.3.1 Front panel

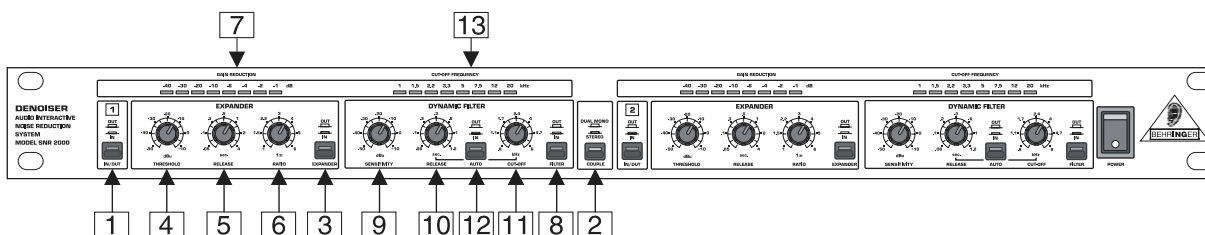

Fig. 1.2: Front panel control elements

- 1 The *IN/OUT* switch activates the relay and, consequently, the corresponding channel. The unit is bypassed when the switch is not depressed.
- 2 By depressing the *COUPLE* switch you will tie channel 1 and 2 together for stereo tracking.
- If using the *COUPLE* switch, it is recommended that all controls be set identically on both channels to ensure proper tracking.**
- 3 The *EXPANDER IN/OUT* switch activates the expander section.
- 4 Use the *THRESHOLD* control to set the threshold at which low level downward expansion starts. Once the signal falls below this threshold, the amount of expansion increases as the signal level decreases.
- 5 The *RELEASE* control allows to adjust the desired release time of the expander section.
- 6 Use the *RATIO* control to adjust the ratio of the downward expansion. Low ratios, from 1.2:1 to about 3:1 produce a more or less slight downward expansion. When, however, the ratio is set to 6:1, the *DENOISER* functions as noise gate.
- 7 This eight-segment *GAIN REDUCTION* meter indicates the amount of expansion.
- 8 The *FILTER IN/OUT* switch activates the filter section.
- 9 The *SENSITIVITY* control allows you to set the operating level of the dynamic filter relative to the level of the input signal.
- 10 The *RELEASE* control allows to adjust the desired release time of the filter.
- 11 The *CUT OFF* control allows to adjust the filter -3 dB point. Thus, the filter can be adapted perfectly to various noise conditions.
- 12 By depressing the *AUTO* switch, the *RELEASE* and *CUT OFF* controls are deactivated. Thus, release time and corner frequency of the filter are automatically derived from the input signal.
- 13 This eight-segment *FREQUENCY* meter indicates the bandwidth of the filter.

1.3.2 Rear panel

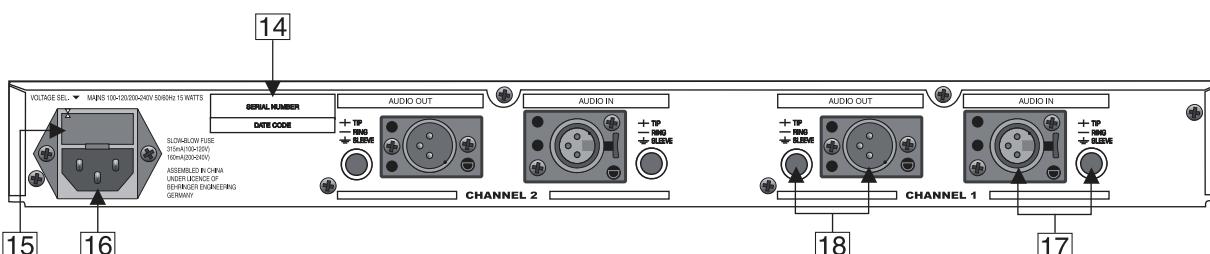

Fig. 1.3: Rear panel connectors

- 14 **SERIAL NUMBER.** Please take the time to complete and return the warranty card within 14 days of the date of purchase, otherwise you will lose the right to the extended warranty. Or just use our online-registration (www.behringer.com).

-
- 15] *FUSE HOLDER / VOLTAGE SELECTOR*. Please make sure that your local voltage matches the voltage indicated on the unit, before you attempt to connect and operate the DENOISER. Blown fuses may only be replaced by fuses of the same type and rating. Some models allow for inserting the fuse holder in two different positions, in order to switch over from 230 V to 115 V operation, and vice versa. Please note that for 115 V operation outside Europe, you need to use a fuse of a higher rating (see chapter 6 "SPECIFICATIONS").
 - 16] Use the enclosed power cord to connect the unit to the mains.
 - 17] These are the balanced 1/4" TRS and XLR *AUDIO INPUTS* of your DENOISER.
 - 18] These are the balanced *AUDIO OUTPUTS* of the DENOISER, available as 1/4" TRS and XLR connectors.

2. OPERATION

The need for an all-purpose and professional noise reduction system was the basis of the development of our DENOISER.

The system design has to meet the following criteria:

1. All-purpose application: the noise reduction design is aimed to operate with both all types of instruments as well as with all composite signal sources.
2. Most effective noise reduction while influencing the signal to the least possible extent. The signal's original sound as well as its attack response remains unaffected.
3. No side effects such as pumping, noise tails, etc. known from conventional circuitries.
4. Simple operation through comprehensive automation of control processes.

To obtain maximum performance, it is necessary to understand what is achieved by each of the separate filter and expander sections and how they perform together. Once you understand how these circuits work, it will be easier to set up the controls correctly to suit any application.

The noise reduction effect of the expander section is active only when signal levels are low. The filter section, on the other hand, is active at all times over the complete dynamic range. Since the filter section is always active, let us look at what is happening in that circuit first:

2.1 Operation of the filter section

2.1.1 The masking effect

The function of the BEHRINGER DENOISER is based on the "masking" effect: noise will be masked and thus becomes inaudible, as soon as considerably louder sound signals are added.

One of the basic components of BEHRINGER circuitry is a dynamically controlled low-pass filter which allows low frequencies to pass but filters the high-frequency information, depending on the music material. In contrast to conventional noise filters with fixed cut off frequencies, the DENOISER shifts the cut off frequency between 800 Hz and 20 kHz, depending on the program material. This is the range where noise is considered most annoying. The cut off frequency of the filter depends on both the input level and the frequency range of the audio signal.

2.1.2 The dynamic low-pass filter

The filter section features a dynamic low-pass filter which operates as follows: With no audio signal present, the dynamic filter will close down to a user selectable cut off point. This cut off point is adjustable between 800 Hz and 6 kHz. If the cut off was set for 1 kHz, the bandwidth of the filter would be from 20 Hz to 1 kHz. If an input signal had a bandwidth from 20 Hz to 2 kHz, the filter would open far enough to pass up to the 2 kHz frequency and its harmonics, while reducing any noise present from approximately 2 kHz to 20 kHz. If a broad-band signal with frequency components up to 20 kHz appears at the input, the dynamic filter would open all the way to 20 kHz.

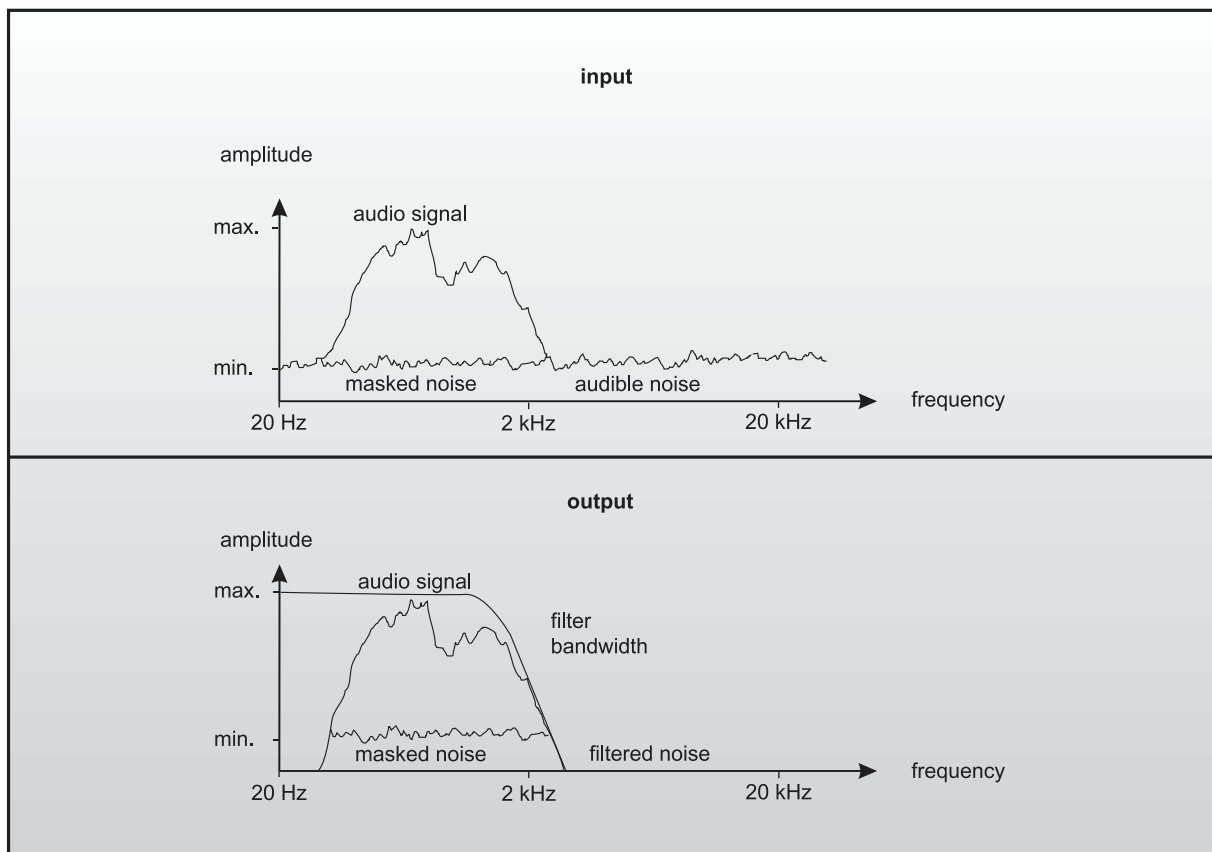

Fig. 2.1: Operation of the dynamic filter

With a low-frequency input signal present, the dynamic filter will reduce any mid or high-band noise as well as any disturbing noise tails. If the input signal is dominated by high-frequency components, however, the dynamic filter will open to its full extent to let the signal pass, maintaining high-frequency information.

2.2 The TAC filter of the DENOISER

Our main goal was to create a filter which cuts off high frequencies during pauses but lets the signal pass without modification as soon as a usable signal is present. However, its realization poses many problems. Apart from "intelligent program recognition", the filter has to meet the following criteria:

1. The control times of the dynamic filter must be fast enough so that high frequencies will not be cut off. Thus, the sound of signals with a high slope, such as percussive instruments, will not be modified.
2. However, if the control times are too fast, "flutter" may occur, i.e. intermodulation distortion could be produced.

The new BEHRINGER TAC (Transient Attack Control) filter circuit guarantees extremely fast control times without producing audible intermodulation distortion. In contrast to conventional units based on so-called RMS rectifiers, the TAC circuitry uses a peak detector. While the RMS rectifier calculates the average or mean value of the signal, i.e., requires a so-called "integration time", the peak detector exactly traces the input signal response. Thus, the TAC circuit is capable of reacting much faster to abrupt level changes produced by percussive signals. The delay which the integration time causes in RMS rectifiers is eliminated in a peak detector, i.e, the "kick" of the instrument remains almost unaltered.

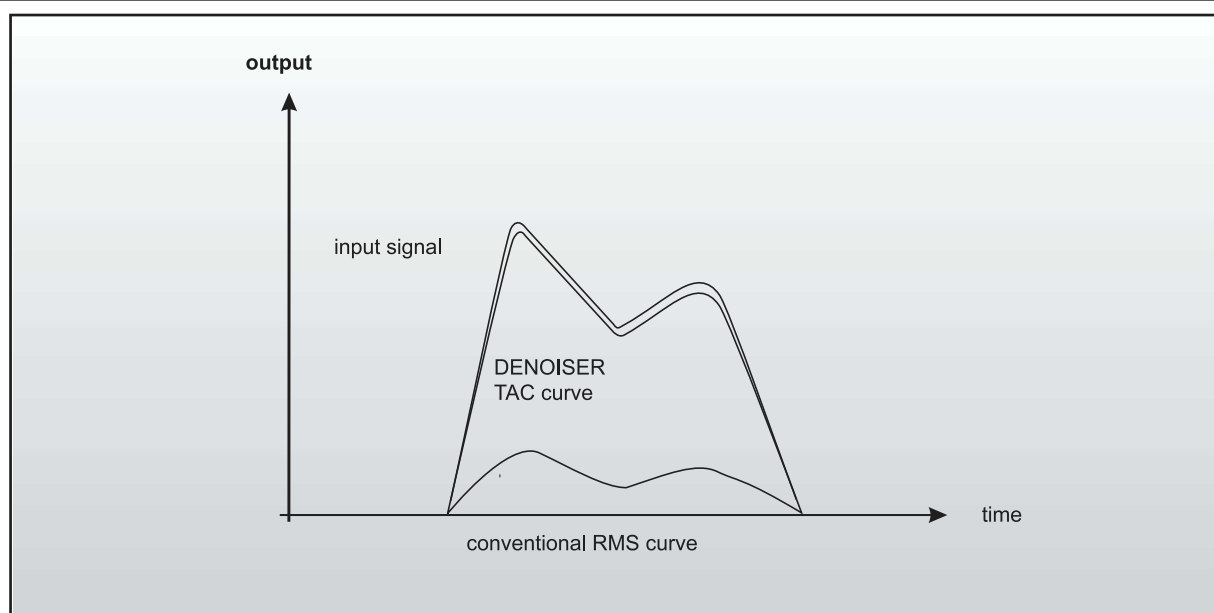



Fig. 2.2: Comparing the BEHRINGER TAC filter circuitry and the conventional RMS characteristic curve

2.2.1 SENSITIVITY control

This control determines the sensitivity of the filter. If the input level exceeds the value adjusted with the SENSITIVITY control, the dynamic filter begins to open. If the adjusted value is, for example, -30 dBu, high-frequency signals with a level above -30 dBu cause the filter to open.

 **The SENSITIVITY setting depends on the type of noise and the application on hand. If the control is set to a value which is above the noise floor level of the input signal, there is the risk of muting the signal's high-frequency portions. It is therefore necessary to set the SENSITIVITY control very carefully.**

2.2.2 CUT OFF control

The CUT OFF control sets the lower cut off frequency of the dynamic filter. Under most conditions, this control should be set at 800 Hz, allowing for the maximum possible amount of noise reduction. The cut off frequency should be increased if you want to affect noise in the upper portion of a signal only or if too drastic noise reduction leads to unwanted side effects.

For example, if you wish to only eliminate noise in the upper frequency range, say from 2 to 20 kHz, set the CUT OFF control at 2 kHz. Frequencies below 2 kHz will not be affected.

2.2.3 RELEASE control

We recommend fast release settings on individual instruments or vocals. This is because there is no real ambience to the signal. Release times about 0.06 to 0.2 seconds would be perfect.

However, with mastered signals or composite music, slower release times should be used. Release times slightly greater than 0.2 seconds are generally ideal. Avoid using very long release rates in this application to reduce the risk of audible noise tail effects.

Using longer release rates (around one second) allows the DENOISER to “denoise” effects returns. Audible and unnatural cutting-off of the reverb will thus be avoided.

2.2.4 AUTO switch

The AUTO switch allows to automatically control release time and cut off frequency of the TAC filter. Thus, by depressing the AUTO switch, the RELEASE and CUT OFF controls are deactivated. Release time and cut off frequency of the filter are now automatically derived from the input signal.

Generally, good results will be achieved with the AUTO function. However, with complex sound sources e.g. classical music featuring a great amount of disturbing noise fine tuning should be done with the RELEASE and CUT OFF controls.

2.2.5 FREQUENCY meter

A precise 8-digit LED meter indicates the current operating point of the filter. The LEDs keep you informed regarding lower cut off frequency, release time and frequency range of the audio signal. If no LED lights up, the cut off frequency is set to 800 Hz. If, on the other hand, all LEDs light up, the bandwidth is above 20 kHz and the filter has no influence on the usable signal.

It proves quite useful to set the SENSITIVITY control in that way that the noise floor causes the first LEDs to light up.

 **Please note that this meter is merely supposed to help you adjust the controls. It is recommended to perform A/B comparisons with the FILTER IN/OUT switch to find out which setting suits your demands!**

 **Please also note that after power-up the unit needs a few minutes to warm up. While the unit calibrates automatically, the LEDs might indicate values that deviate from the values stated by the controls and scales on the front panel!**

2.3 Operation of the expander section

The noise reduction system of the DENOISER is based on two signal processing techniques, which can be used separately but may also be combined with each other: in addition to the dynamically controlled low-pass filter mentioned above, the DENOISER features a so-called downward expander which uses a second noise reduction process to eliminate remaining interference noise.

A downward expander automatically reduces the overall level for all signals below an adjustable threshold and therefore extends the dynamic range of the program material.

Changing the variable release time and the expansion ratio enables the expander to operate as a noise gate. Expanders generally function with a flat ratio curve, so that the signal continually fades. Noise gates however, can be seen as a special type of expander. They normally work with a more exaggerated ratio and radically attenuate the signal if it falls below the threshold.

 **The following explanations also apply to the gate function, because the gate is a special form of the expander.**

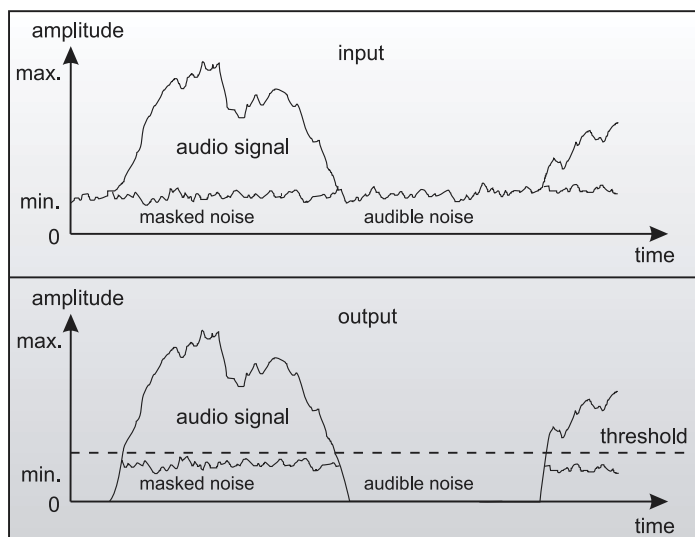

Fig. 2.3: The function of an expander

2.4 The IRC expander of the DENOISER

The response characteristics of conventional expanders tend to cut the signal abruptly and the result is generally unacceptable, since the effect is clearly audible. "Inaudible" expansion, however, requires a gentle "Soft Knee" characteristic due to a continuous transition of the straight lines at the threshold.

A newly developed IRC (Interactive Ratio Control) expander has been integrated into the DENOISER. The ratio curve characteristic automatically adapts itself, dependent on the program material.

With low ratios and a slight expansion, the transition is "gentle", whereas higher ratios and increasing expansion will result in "harder" transitions within the curve.

The IRC expander is therefore equipped with a soft, interactive non-linear ratio curve which is best suited to the human hearing. Critical signals around the threshold level are processed with low expansion ratio settings, whereas low signals will be subjected to an increasingly higher ratio which will result in greater attenuation.

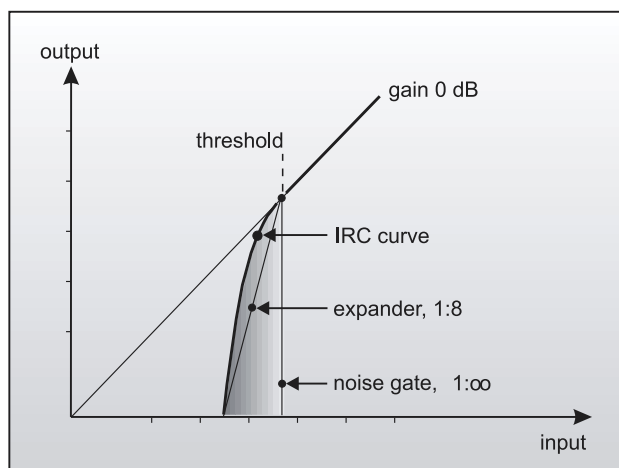

Fig. 2.4: IRC curve characteristic of the expander

The result is an expander which can be adjusted without the risk of alienating the overall sound. Furthermore, the expander is more tolerant towards those usable signals which appear slightly above the noise floor.

2.4.1 THRESHOLD control

The THRESHOLD control of the expander defines the operating level. It stretches across a very wide range and therefore applies to all working levels. Input levels above the adjusted threshold point do not experience any change. However, if the level falls below the threshold the dynamic process is active.

For example, if the THRESHOLD control was set at 0 dBu and the input signal drops below 0 dBu, downward expansion will begin. In typical applications the setting of the threshold control should be between 5 and 20 dB above the quiescent noise floor of the input signal. For example, if the quiescent noise floor was -40 dBu, a setting between -35 to -20 dBu will produce the desired expansion.

 **With the RATIO control set to maximum and the THRESHOLD control set at +10 dBu, an input signal level would have to exceed approximately +5 dBu to produce an output signal.**

2.4.2 RELEASE control

The RELEASE control determines the time the downward expander requires to decrease the level of the output signal. The RELEASE control is variable from 0.2 to 4 seconds and refers to a 20 dB gain change. The ultimate setting of the RELEASE control depends on your demands: When the expander sections are supposed to function as gates, settings between 0.2 and 0.5 seconds are recommended.

For individual instruments or vocals use a setting between 0.2 and 0.5 seconds. For composite music a setting between 0.6 and 2 seconds is recommended. If you want to use the expander section to reduce subtle background noise from effects devices, a very slow release time (2 to 6 seconds) would be perfect.

2.4.3 RATIO control

The ratio between input and output level for all signals that fall below the threshold is called expansion ratio. It is adjustable via the RATIO control. This control adjusts an important parameter: It determines whether the section functions as expander or gate.

A ratio of 1:1 indicates that the output signal will correspond to the input signal, i.e. the level does not change. A ratio of 1:2 indicates that for every 1 dB decrease in input level below the threshold, there will be resultant corresponding decrease in the output level of 2 dB. A ratio of 1:6 indicates, that for a 1 dB decrease in input level below the threshold, there will be a corresponding decrease in the output level of 6 dB etc.

Low ratios from 1:1 to about 1:3 produce precisely controlled downward expansion. At more pronounced settings up to 1:6 the DENOISER functions as gate.

The scale of the ratio is calibrated in dB on the front panel. It indicates the decrease in output level, resulting from a 1 dB decrease in input level.

The DENOISER works as an IRC expander. The interactive control function defines the soft onset of the expander, according to the characteristics of human hearing during the fade out process. This allows for a natural and thus inaudible elimination of interference noise. This means that, as the input level drops slightly below the threshold point, the expander ratio will start at 1.1:1 and increase to an ultimate ratio selected with the RATIO control. The correct setting of the ratio control depends on your demands: In order to achieve a flat expansion curve, we recommend settings of 1:1 to 1:3. This provides soft and limited expansion for difficult and noisy audio applications. Higher settings up to 1:6 are recommended for gating applications which allow for noise reduction of more than 70 dB.

2.4.4 GAIN REDUCTION meter

The eight GAIN REDUCTION LEDs on the front panel of the BEHRINGER DENOISER function as follows: If the input level falls below the threshold, the expander starts working with the current level reduction factor being indicated by the GAIN REDUCTION LEDs.

Let us consider, for example, a specific signal that falls by 2 dB below the threshold: with a ratio setting of 1:6, the output signal is attenuated by 12 dB; in comparison to the input signal the output signal has been reduced by 12 dB, which is indicated by the 10 dB LED.

Although the VCA of the BEHRINGER DENOISER provides a control range of 80 dB, it is not very useful to display the entire range, since such drastic control processes are performed very rarely in practice. The displayed range of the GAIN REDUCTION indicators is 40 dB.

2.5 The COUPLE function

The couple switch links channel 1 and channel 2. This includes each channel's expander detection and filter detection circuits. Although this allows the two channels to track each other for stereo applications, it should be pointed out that this is not a master/slave setup, but rather a link and for true stereo tracking it is necessary to set both channel's controls identically.

In master/slave operation one channel exclusively governs both channels, whereby in couple mode both channels are combined resulting in a common control voltage.

 **When using the COUPLE switch, a high-level, high-frequency signal present in one channel will cause the expander and filter of both channels to open at the same point. Accordingly, both channel's expanders and filters are supposed to close at the same point. Therefore, it is recommended that both channels are set identically. (The most critical controls are the expander THRESHOLD and the filter SENSITIVITY controls.) If the two channels are not set identically, a predominant setting in one channel will affect the other channel.**

The only two controls that operate separately when the COUPLE switch is on are the expander RELEASE and the expander RATIO controls. It is recommended to set these controls identically on both channels.

However, if one channel reveals more noise than the other, the expander RELEASE/RATIO controls of the respective channel can be used to let the expander close quicker for effective noise reduction while still tracking in stereo.

 **If using the COUPLE switch, it is recommended that all controls are set identically to ensure proper tracking.**

3. APPLICATIONS

In this section several typical applications of the DENOISER are discussed. The following basic settings can solve most dynamic problems. They are the ideal starting point.

Please take the time to study the application examples carefully, in order to be able to make full use of the DENOISER's capabilities in future.

The main applications of the DENOISER can be divided into three categories:

1. The DENOISER is used to eliminate interferences from acoustic instruments such as guitars etc. as well as keyboards, samplers or other line level instrument signals.
2. The DENOISER is used to eliminate interferences in effects devices, tape machines, mixers or other studio equipment.
3. The DENOISER can be used for removing noise from records and any tape recordings.

3.1 Initial settings of the DENOISER

The subsequent settings of the front panel controls will be based on the respective input level and noise floor. Due to the fact that it would be impossible to demonstrate every application you can think of, we recommend to carefully read this manual and the function of its controls, as the unit has a certain complexity due to the extensive setting variations. Once familiar with the functions of the individual controls, you will be able to purposefully and creatively operate the unit.

The following chart shows a typical setup and can be used as a guide for a variety of applications:

Example:	
Type of music	composite (e.g. mixdown)
Reference level	-10 dBu
Noise floor	-60 dBu

Tab. 3.1: Example for a standard application

We recommend the following control settings:

Controls	Settings
IN/OUT switch	IN
EXPANDER switch	IN
THRESHOLD control	-50 dBu
RELEASE control	2 seconds
RATIO control	3:1
FILTER switch	IN
SENSITIVITY switch	-30 dBu
AUTO switch	IN

Tab. 3.2: Initial settings of the DENOISER

3.2 Studio applications

3.2.1 Noise reduction during playback

For this standard application, the DENOISER is inserted after the master or multitrack machine, i.e. between tape machine and mixer (or amplifier). A cassette recorder or similar machine may also be the signal source.

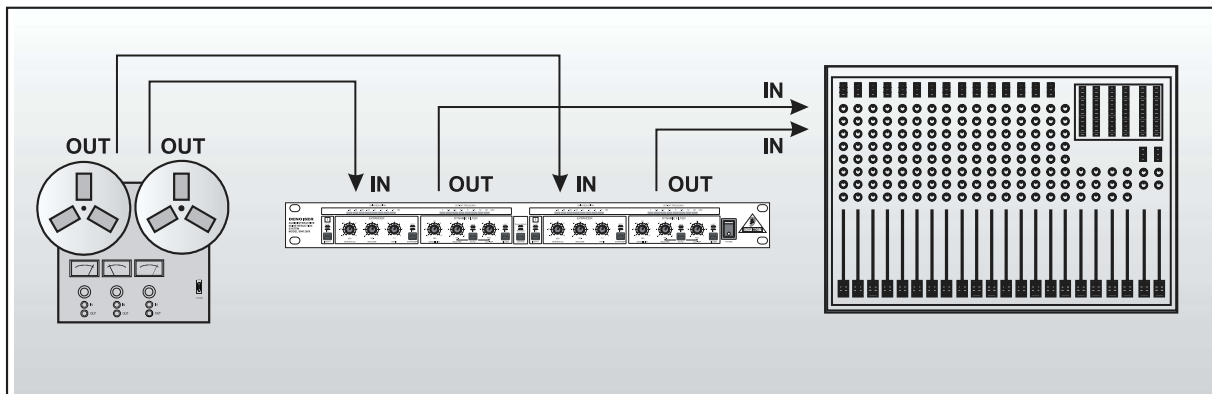

Fig. 3.1: Noise reduction during playback

1. Set up your equipment as usual, while bypassing your DENOISER.
2. Turn on the BEHRINGER DENOISER and adjust the controls as desired (if necessary, read chapter 1.3 "Control elements" once again).
3. Check your settings by making A/B comparisons using each channel's IN/OUT switch.

3.2.2 Noise reduction during recording

The noise reduction effect may be increased by using the DENOISER not only during playback but also when recording. For this purpose, insert the unit directly after the master output of the mixer into the recording path of the master or multitrack machine. Set up the unit as described in the previous section "Noise reduction during playback".

In particularly difficult cases, we recommend using the DENOISER both during recording *and* playback.

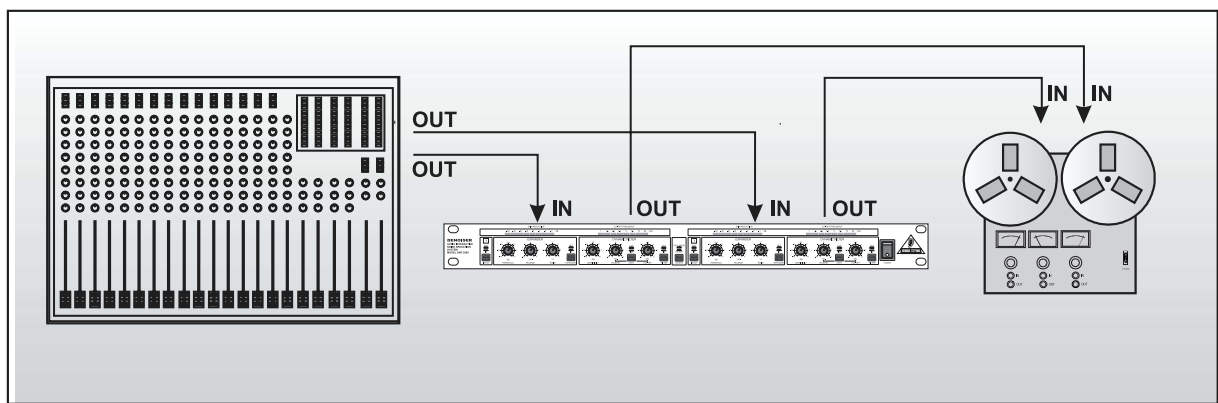

Fig. 3.2: Noise reduction during recording

If the mixer features a “line level insert” (either pre or post equalizer), the DENOISER should be inserted here.

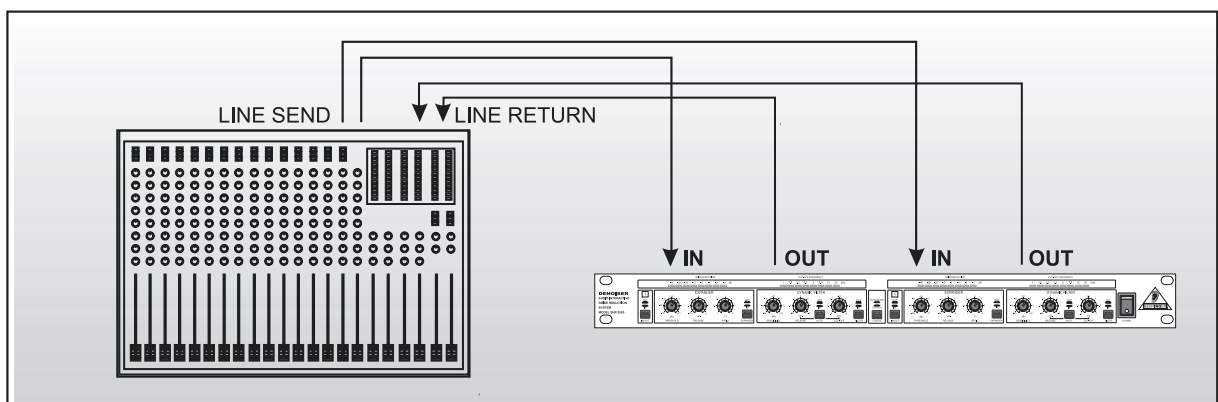

Fig. 3.3: Noise reduction using the “line insert”

3.2.3 Reducing noise on subgroups, monitor and effects buses

For this application there are several options:

1. If your mixer features subgroup inserts, you can reduce noise in subgroups separately.
2. You can also connect monitor or effects buses (aux sends) to the BEHRINGER DENOISER and route the signal back to a channel input. For this purpose, the respective signals have to be taken “pre fader”, while the respective channels must be muted. We recommend to use the DENOISER as the last component in the chain of effects devices. The overall signal will then be processed by the DENOISER and sent back to the mixer’s master section via the “effect returns”.

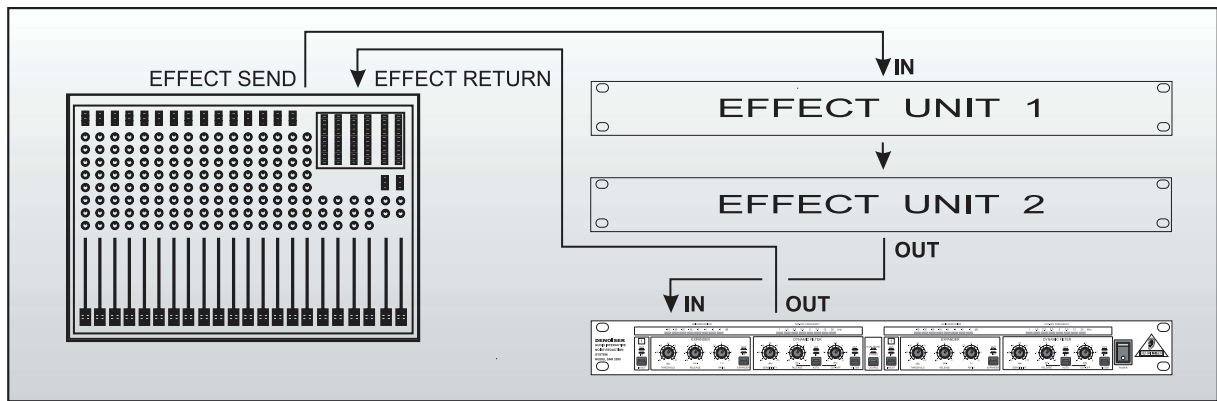

Fig. 3.4: Noise reduction in the effects bus

3.2.4 Noise reduction for effects devices

Effects devices such as flangers, phasers, distortion or chorus units, delay and reverb devices, compressors, equalizers, exciters, etc. can considerably increase the overall noise level. The DENOISER will also be useful here. Simply insert the unit after the effects device that causes noise problems. If there are several devices, insert the DENOISER as the last unit in the signal chain.

3.2.5 Noise reduction during tape duplication

The noise produced by magnetic tapes can be significantly reduced with the DENOISER. Tape/cassette copies will provide low noise and higher dynamics.

Particularly old and noisy tapes can be new lease of life with the DENOISER. If adjusted properly, it will produce copies that sound better than the original.

Simply insert the BEHRINGER DENOISER between the line outputs of the master machine and the inputs of the recorder.

Machines with tape return monitor function allow you to check the quality of the copy while duplicating the tape.

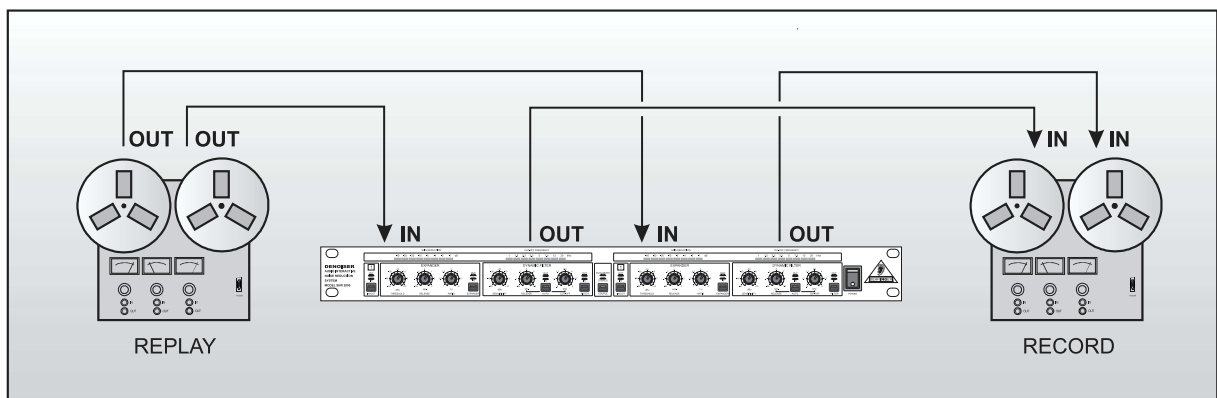

Fig. 3.5: Reducing noise during tape duplication

3.2.6 Noise reduction for instruments

Digital instruments (synthesizers, samplers, etc.) often produce quantization noise, which can be very annoying. The DENOISER can be inserted directly after the instrument and will remove typical noise tails etc.

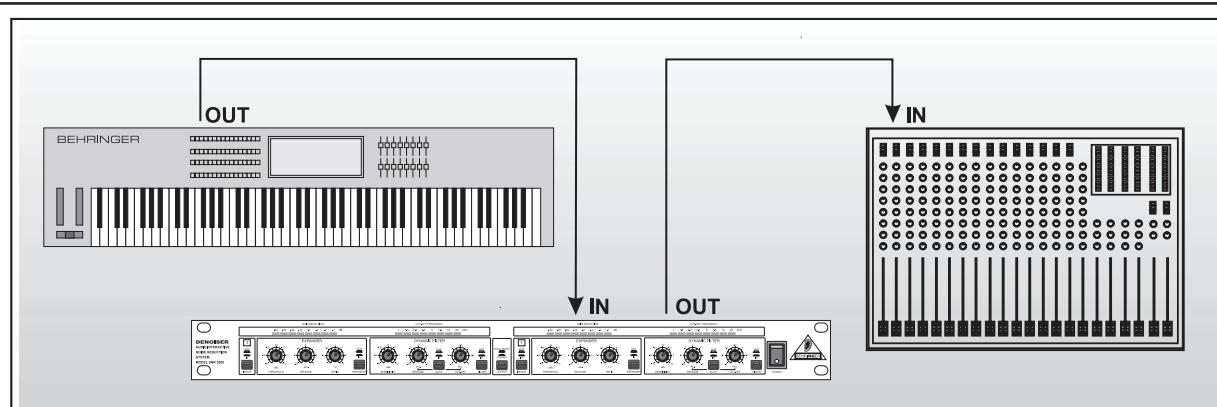

Fig. 3.6: Noise reduction on keyboards

 Please note that low level signal sources such as guitars must be pre-amplified beforehand, as the BEHRINGER DENOISER only processes line level signals (-10 dBV to +10 dBu).

3.2.7 Reducing noise in P.A. systems

The noise produced by P.A. systems is particularly annoying. Hum induced in the microphone cables combined with high gain settings results in a drastic increase of noise.

The DENOISER can solve these problems, too. Insert the unit into the individual microphone channels (line inserts) or into the master, monitor or effects buses.

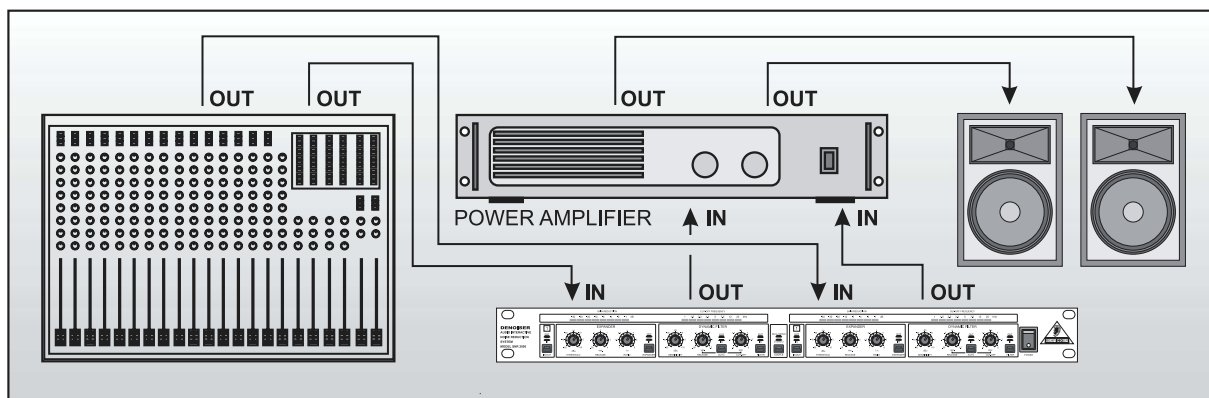

Fig. 3.7: Reducing noise in a P.A. system

3.2.8 Noise reduction in Hi-Fi and video applications

The DENOISER can also be used in Hi-Fi and video applications. The unit is simply placed between the signal source (cassette player, tuner, VCR, etc.) and the power amp. We recommend using the so-called "tape monitor" connections that most preamplifiers offer. Thus, the DENOISER can be inserted into any signal source.

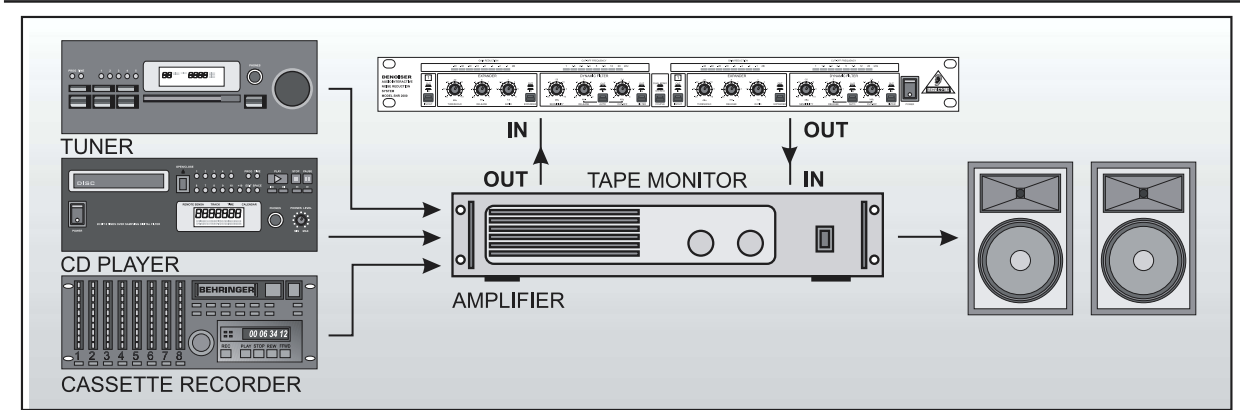

Fig. 3.8: Noise reduction in Hi-Fi systems

The BEHRINGER DENOISER can be used for:

- ▲ disc and tape recordings
- ▲ video and audio cassette playback purposes
- ▲ TV reception
- ▲ radio reception

4. TECHNICAL BACKGROUND

4.1 What are audio dynamics?

A remarkable feature of the human ear is that it can detect the widest range of amplitude changes—from the slightest whisper to the deafening roar of a jet-plane. If one tried to record or reproduce this wide sound spectrum with the help of amplifiers, cassette recorders, records or even digital recorders (CD, DAT, etc.), one would immediately be restricted by the physical limitations of electronic and acoustic sound reproduction technology.

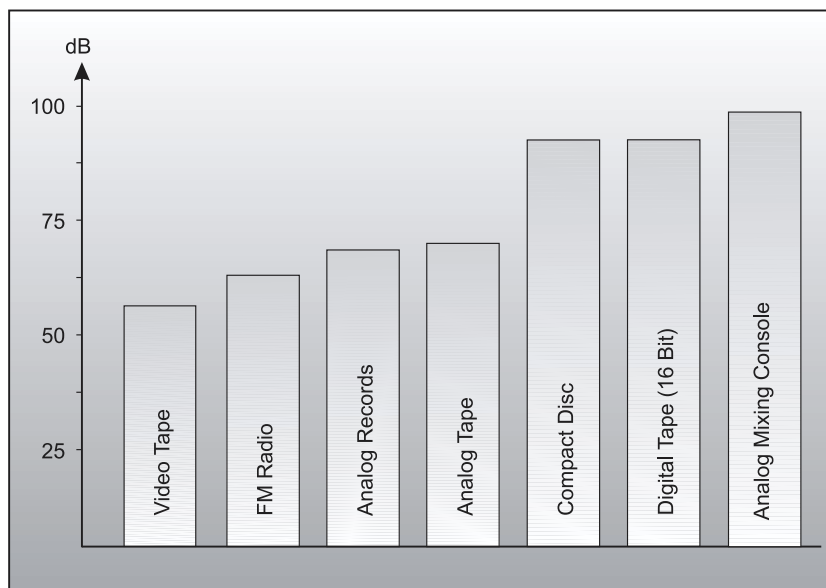

Fig. 4.1: The dynamic range of various devices

The usable dynamic range of electro-acoustic equipment is limited to both the low end and the high end. The thermal noise of the electrons in the components results in an audible basic noise floor and thus represents the bottom limit of the transmission range. The upper limit is determined by the levels of the internal operating voltages; if they are exceeded, audible signal distortion is the result. Although, in theory, the usable dynamic range is spreading from low to high end, it is considerably smaller in practice, since a certain reserve must be maintained to avoid distortion of the audio signal if sudden level peaks occur.

Technically speaking, we refer to this reserve as “headroom”—usually about 10 to 20 dB. A reduction of the operating level would allow for greater headroom, i.e. the risk of signal distortion due to level peaks would be reduced. However, at the same time, the basic noise floor of the program material would be increased considerably.

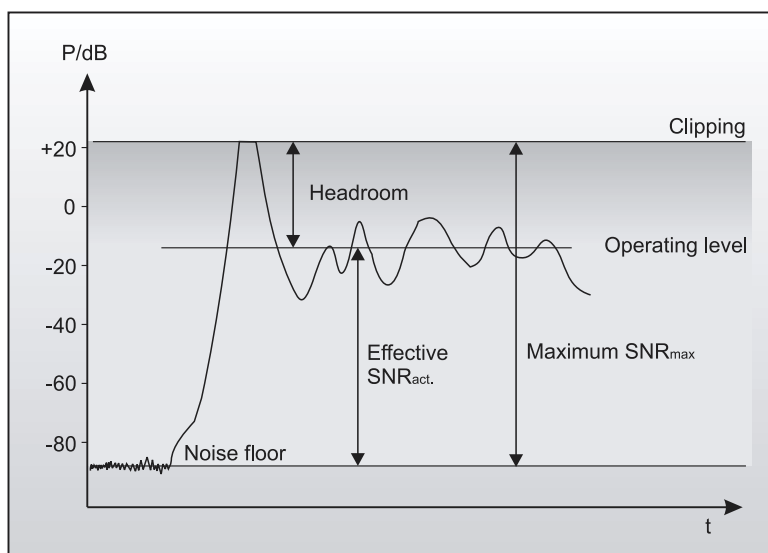

Fig. 4.2: The interactive relationship between operating level and headroom

It is therefore useful to keep the operating level as high as possible without risking signal distortion in order to achieve optimum transmission quality.

4.2 Compressors/limiters

By measuring the dynamic range of instruments in live recording situations, you will experience that extreme amplitudes occur which often lead to overload on the various devices in the signal chain. Especially in broadcasting and record cutting techniques, these signal peaks can lead to heavy distortion. To avoid this kind of distortion or, for example, to avoid loudspeaker damage, compressors or limiters are used. The basic function used in these devices is dependent on automatic gain control as mentioned in the previous section, which reduces the amplitude of loud passages and therefore restricts the original dynamics.

4.3 Expanders/noise gates

Audio, in general, is only as good as the source from which it was derived. The dynamic range of signals will often be restricted by noise. Synthesizers, effects devices, guitar pickups, amplifiers, etc. generally produce a high noise level, hum or other ambient background hiss, which can disturb the quality of the program material.

Normally, these noises are inaudible if the level of the usable signal lies significantly above the level of the noise. This perception by the ear is based on the “masking” effect: noise will be masked and thus becomes inaudible as soon as considerably louder sound signals in the same frequency band are added. However, the further the level of the usable signal decreases, the more the noise floor becomes a disturbing factor.

The noise gate is the simplest form of an expander: in contrast to the expander, which continuously attenuates a signal below the threshold, the noise gate cuts off the signal abruptly. In most applications this method is not very useful, since the on/off transition is too drastic. The onset of a simple gate function appears very obvious and unnatural. To achieve inaudible processing of the program material, it is necessary to control the signal's envelope parameters.

4.4 Downward expansion

Expanders or noise gates are the ultimate problem solvers: these devices attenuate signals when their amplitudes drop, thereby fading out background noise. Thus, expanders extend the dynamic range of a signal and are therefore the opposite of a compressor.

In practice, it has shown that an expansion over the entire dynamic range is not desired. With an expansion ratio of 5:1 and a processed dynamic range of 30 dB, an output dynamic range of 150 dB will be the result, exceeding all subsequent signal processors as well as the human hearing.

Therefore, expansion is restricted to signals whose levels fall below a certain threshold. Signals above this threshold pass without being altered. Due to the continuous attenuation of the signals below this threshold, this kind of expansion is termed "downward" expansion.

4.5 Noise as physical phenomenon

All electrical components produce a certain level of inherent noise. Current flowing through a conductor leads to uncontrolled, accidental movements of electrons. For statistical reasons, this produces frequencies within the whole audio spectrum. If these currents are amplified, the result will be perceived as noise. Since all frequencies are equally affected, we term this *white* noise.

It is fairly obvious that electronics cannot function without components. Even if special low-noise components are used, a certain degree of basic noise cannot be avoided.

This effect is similar when playing a tape. The unidirectional magnetic particles passing the audio head can also cause uncontrolled currents and voltages. The resulting sound of the various frequencies is perceived as noise. Even the best possible tape biasing can "only" provide signal-to-noise ratios of about 70 dB, which is not acceptable today since the demands of listeners have increased.

4.6 Companders

Consequently, the industry has developed systems which artificially expand the restricted dynamic range of the audio tape. These are so-called COMPANDER systems (COMpressor/exPANDER) which are based on the following principle:

During recording, the amplitude of low-level signals (which lie below the tape's inherent noise level) is increased, i.e. the signal becomes louder. The dynamics of loud passages, however, which would saturate the tape, is reduced. Due to this signal compression, a higher recording level can be achieved.

During playback, this process is reversed to restore the original dynamic range. By expanding the signal as well as the dynamic range, the inherent noise level of the tape is reduced. In order to precisely reverse the whole process, it is necessary to add a code pattern to the program material.

Despite this encoding process, unwanted side effects such as noise tails, pumping etc. frequently occur. Compander systems can cause drastic fluctuations, especially when overloaded. This basic handicap is the reason why such systems find only a limited application in audio engineering:

1. Compander systems are not compatible with each other. A cassette recorded with system A CANNOT be replayed with noise reduction system B.
2. The application of compander systems is restricted to tape machines and transmission lines, for these systems only reduce the noise produced by the tape machine, i.e. the storage medium itself, but NOT the noise already existing in the program material.

Since conventional compander systems CANNOT considerably reduce the noise of the signal source, the result will always be unsatisfactory.

4.7 The “single-ended” principle

In contrast to conventional noise reduction systems using compressors and expanders, the DENOISER is purely a “single-ended” system. “Single-ended” means that the noise reduction system is not based on a process combining both record and playback (encoding and decoding), but is simply inserted into the signal chain after the signal that is going to benefit from noise reduction. The noise reduction capabilities of the BEHRINGER DENOISER are based on bandwidth limiting by means of a dynamic low-pass filter and broadband noise reduction during music pauses by a “downward” expander.

Thus, the DENOISER can be used for any program source, since it processes during playback. Due to this outstanding feature, virtually any noise can be removed!

5. INSTALLATION

5.1 Rack mounting

The BEHRINGER DENOISER fits into one standard 19" rack unit (1 3/4"). Please allow at least an additional 4" depth for the connectors on the back panel.

Be sure that there is enough space around the unit for cooling and please do not place the DENOISER on high temperature devices such as power amplifiers etc. to avoid overheating.

5.2 Audio connections

As a standard, the BEHRINGER DENOISER is installed with electronically servo-balanced inputs and outputs. The circuit design features automatic hum rejection for balanced signals, permitting trouble-free operation even at highest operating levels. Externally induced power-line hum, etc. is thus suppressed effectively. The automatic servo function recognizes the presence of unbalanced connectors and adjusts the nominal level internally to avoid level differences between the input and output signals (6 dB correction).

 **Please ensure that only qualified persons install and operate the DENOISER. During installation and operation the user must have sufficient electrical contact to earth. Electrostatic charges might affect the operation of the DENOISER!**

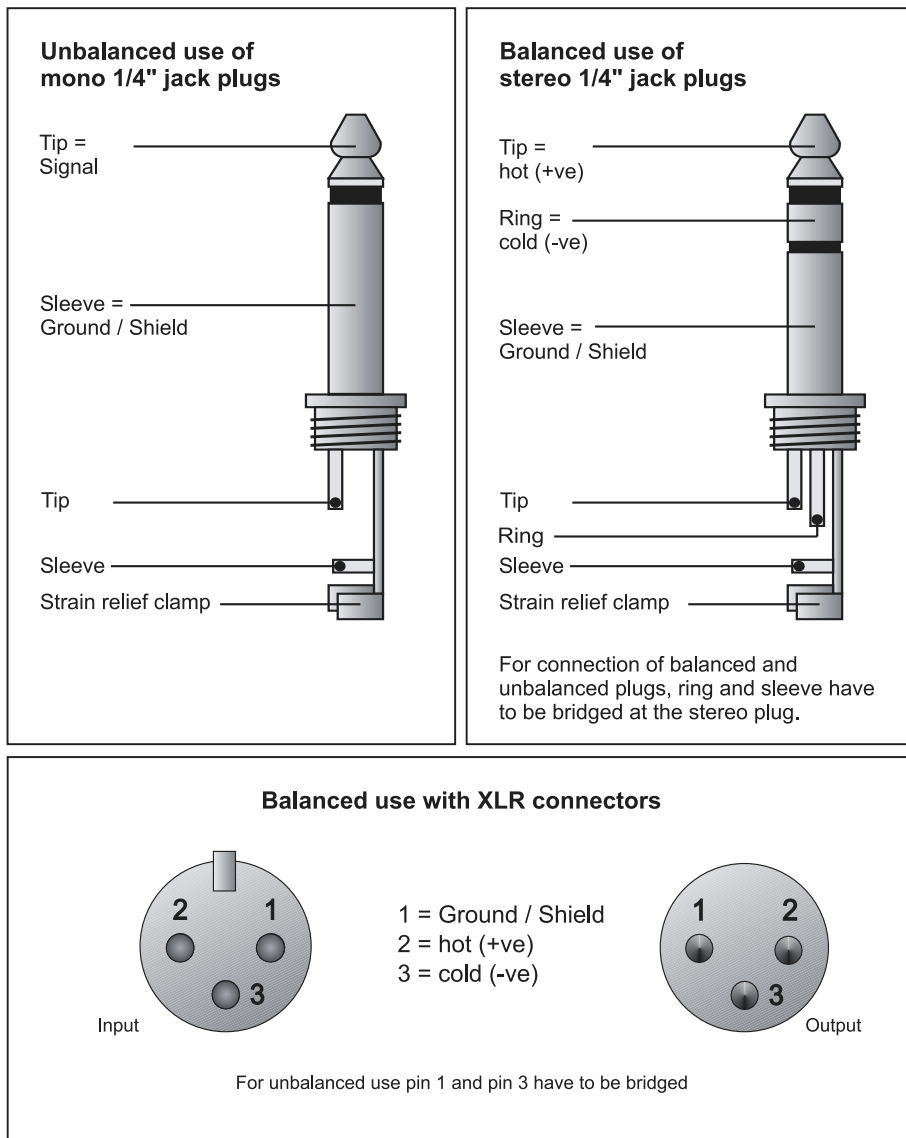

Fig. 5.1: Different plug types

6. SPECIFICATIONS

Analog inputs

Connectors	XLR and 1/4" TRS
Type	RF filtered, servo balanced input
Impedance	80 kOhms balanced
Nominal operating level	-10 dBV to +4 dBu (switchable)
Max. input level	+20 dBu balanced and unbalanced

Analog outputs

Connectors	XLR and 1/4" TRS
Type	Electronically servo-balanced output stage (optional transformer-balanced)
Impedance	40 Ohms balanced or unbalanced
Max. output level	+26 dBm balanced, +20 dBm unbalanced

System specifications

Bandwidth	5 Hz to 100 kHz, +0/-3 dB
Noise	> 104 dBu, fully off
THD	0.02% typ. @ +4 dBu, 1 kHz, Gain 1
Crosstalk	< -85 dBu

Expander section

Threshold	variable (-40 to +20 dBu)
Release	variable (0.05 to 6 seconds)
Ratio	variable (1:1 to 1:6)

Filter section

Sensitivity	variable (-50 to +10 dBu)
Release	variable (0.06 to 1.2 seconds)
Cut-off	variable (800 Hz to 6 kHz)

Function switches

Channel IN/OUT	Relay controlled hard-bypass
Expander IN/OUT	Activates the expander section
Filter IN/OUT	Activates the filter section
Auto	Activates the automatic filter circuitry
Couple	Link feature for stereo tracking

Indicators

8 LED gain reduction	1/2/4/6/10/15/20/30 dB
8 LED filter bandwidth	1/1.5/2.2/3.3/5/7.5/12/20 kHz
LED indicator for each function switch	

Power supply

Mains voltages	USA/Canada	120 V ~, 60 Hz
	U.K./Australia	240 V ~, 50 Hz
	Europe	230 V ~, 50 Hz
	General export model	100 - 120 V ~, 200 - 240 V ~, 50 - 60 Hz
Fuse	100 - 120 V ~: T 320 mA H	
	200 - 240 V ~: T 160 mA H	
Power consumption	9 Watts	
Mains connection	Standard IEC receptacle	

Physical

Dimensions (H x W x D)	1 3/4" (44.5 mm) x 19" (482.6 mm) x 8 1/2" (217 mm)
Net weight	approx. 3 kg
Shipping weight	approx. 4.2 kg

BEHRINGER is constantly striving to maintain the highest professional standards. As a result of these efforts, modifications may be made from time to time to existing products without prior notice. Specifications and appearance may differ from those listed or illustrated.

7. WARRANTY

§ 1 WARRANTY CARD/ONLINE REGISTRATION

To be protected by the extended warranty, the buyer must complete and return the enclosed warranty card within 14 days of the date of purchase to BEHRINGER Spezielle Studiotechnik GmbH, in accordance with the conditions stipulated in § 3. Failure to return the card in due time (date as per postmark) will void any extended warranty claims. Based on the conditions herein, the buyer may also choose to use the online registration option via the Internet (www.behringer.com or www.behringer.de).

§ 2 WARRANTY

1. BEHRINGER (BEHRINGER Spezielle Studiotechnik GmbH including all BEHRINGER subsidiaries listed on the enclosed page, except BEHRINGER Japan) warrants the mechanical and electronic components of this product to be free of defects in material and workmanship for a period of one (1) year* from the original date of purchase, in accordance with the warranty regulations described below. If the product shows any defects within the specified warranty period that are not excluded from this warranty as described under § 3 and 4, BEHRINGER shall, at its discretion, either replace or repair the product using suitable new or reconditioned parts. In the case that other parts are used which constitute an improvement, BEHRINGER may, at its discretion, charge the customer for the additional cost of these parts.

2. If the warranty claim proves to be justified, the product will be returned to the user freight prepaid.

3. Warranty claims other than those indicated above are expressly excluded.

§ 3 RETURN AUTHORIZATION NUMBER

1. To obtain warranty service, the buyer (or his authorized dealer) must call BEHRINGER (see enclosed list) during normal business hours **BEFORE** returning the product. All inquiries must be accompanied by a description of the problem. BEHRINGER will then issue a return authorization number.

2. Subsequently, the product must be returned in its original shipping carton, together with the return authorization number to the address indicated by BEHRINGER.

3. Shipments without freight prepaid will not be accepted.

§ 4 WARRANTY REGULATIONS

1. Warranty services will be furnished only if the product is accompanied by a copy of the original retail dealer's invoice. Any product deemed eligible for repair or replacement by BEHRINGER under the terms of this warranty will be repaired or replaced within 30 days of receipt of the product at BEHRINGER.

2. If the product needs to be modified or adapted in order to comply with applicable technical or safety standards on a national or local level, in any country which is not the country for which the product was originally developed and manufactured, this modification/adaptation shall not be considered a defect in materials or workmanship. The warranty does not cover any such modification/adaptation, irrespective of whether it was carried out properly or not. Under the terms of this warranty, BEHRINGER shall not be held responsible for any cost resulting from such a modification/adaptation.

3. Free inspections and maintenance/repair work are expressly excluded from this warranty, in particular, if caused by improper handling of the product by the user. This also applies to defects caused by normal wear and tear, in particular, of faders, potentiometers, keys/buttons and similar parts.

4. Damages/defects caused by the following conditions are not covered by this warranty:

▲ improper handling, neglect or failure to operate the unit in compliance with the instructions given in BEHRINGER user or service manuals.

▲ connection or operation of the unit in any way that does not comply with the technical or safety regulations applicable in the country where the product is used.

▲ damages/defects caused by force majeure or any other condition that is beyond the control of BEHRINGER.

5. Any repair or opening of the unit carried out by unauthorized personnel (user included) will void the warranty.

6. If an inspection of the product by BEHRINGER shows that the defect in question is not covered by the warranty, the inspection costs are payable by the customer.

7. Products which do not meet the terms of this warranty will be repaired exclusively at the buyer's expense. BEHRINGER will inform the buyer of any such circumstance. If the buyer fails to submit a written repair order within 6 weeks after notification, BEHRINGER will return the unit C.O.D. with a separate invoice for freight and packing. Such costs will also be invoiced separately when the buyer has sent in a written repair order.

§ 5 WARRANTY TRANSFERABILITY

This warranty is extended exclusively to the original buyer (customer of retail dealer) and is not transferable to anyone who may subsequently purchase this product. No other person (retail dealer, etc.) shall be entitled to give any warranty promise on behalf of BEHRINGER.

§ 6 CLAIM FOR DAMAGES

Failure of BEHRINGER to provide proper warranty service shall not entitle the buyer to claim (consequential) damages. In no event shall the liability of BEHRINGER exceed the invoiced value of the product.

§ 7 OTHER WARRANTY RIGHTS AND NATIONAL LAW

1. This warranty does not exclude or limit the buyer's statutory rights provided by national law, in particular, any such rights against the seller that arise from a legally effective purchase contract.

2. The warranty regulations mentioned herein are applicable unless they constitute an infringement of national warranty law.

* Customers in the European Union please contact BEHRINGER Germany Support for further details.

The information contained in this manual is subject to change without notice. No part of this manual may be reproduced or transmitted in any form or by any means, electronic or mechanical, including photocopying and recording of any kind, for any purpose, without the express written permission of BEHRINGER Spezielle Studiotechnik GmbH.

BEHRINGER and DENOISER are registered trademarks. ALL RIGHTS RESERVED.

© 2002 BEHRINGER Spezielle Studiotechnik GmbH.

BEHRINGER Spezielle Studiotechnik GmbH, Hanns-Martin-Schleyer-Str. 36-38, 47877 Willich-Münchheide II, Germany

Tel. +49 (0) 21 54 / 92 06-0, Fax +49 (0) 21 54 / 92 06-30

Free Manuals Download Website

<http://myh66.com>

<http://usermanuals.us>

<http://www.somanuals.com>

<http://www.4manuals.cc>

<http://www.manual-lib.com>

<http://www.404manual.com>

<http://www.luxmanual.com>

<http://aubethermostatmanual.com>

Golf course search by state

<http://golfingnear.com>

Email search by domain

<http://emailbydomain.com>

Auto manuals search

<http://auto.somanuals.com>

TV manuals search

<http://tv.somanuals.com>