

User Manual



SONIC EXCITER SX3040

Ultimate Stereo Sound Enhancement Processor

Table of Contents

| | |
|--|-----------|
| Thank you | 2 |
| Important Safety Instructions | 3 |
| Legal Disclaimer | 3 |
| Limited Warranty | 3 |
| 1. Introduction | 5 |
| 1.1 Before you get started | 5 |
| 1.1.1 Shipment..... | 5 |
| 1.1.2 Initial operation | 5 |
| 1.1.3 Online registration | 5 |
| 2. Control elements and Connections | 5 |
| 2.1 Front panel..... | 5 |
| 2.2 Rear panel | 6 |
| 3. Practical Application | 6 |
| 3.1 Two separate unit functions | 6 |
| 3.2 Application examples | 6 |
| 3.2.1 Series cable connection (Insert mode) | 7 |
| 3.2.2 Parallel cable connection (Aux Send Mode) | 7 |
| 3.2.3 Live sound..... | 7 |
| 3.2.4 Studio application..... | 8 |
| 3.2.5 Stage operation with instrument amplifiers | 8 |
| 3.3 Basic operation..... | 9 |
| 4. Installation | 9 |
| 4.1 Rack mounting..... | 9 |
| 4.2 Audio connections..... | 9 |
| 4.2.1 Cabling with jack cables..... | 9 |
| 4.2.2 Connection with insert cables..... | 10 |
| 5. Specifications..... | 10 |

Thank you

Thank you for purchasing the SONIC EXCITER SX3040. The SX3040 is a professional signal processor that lends audio signals more detail, contour and presence. Exciter technology has been part of the sound of numerous successful professional recordings since the 1970s and has gained legendary status over the years thanks to its unique sound enhancements.

EN Important Safety Instructions



Terminals marked with this symbol carry electrical current of sufficient magnitude to constitute risk of electric shock.

Use only high-quality professional speaker cables with ¼" TS or twist-locking plugs pre-installed. All other installation or modification should be performed only by qualified personnel.



This symbol, wherever it appears, alerts you to the presence of uninsulated dangerous voltage inside the enclosure - voltage that may be sufficient to constitute a risk of shock.



This symbol, wherever it appears, alerts you to important operating and maintenance instructions in the accompanying literature. Please read the manual.



Caution

To reduce the risk of electric shock, do not remove the top cover (or the rear section). No user serviceable parts inside. Refer servicing to qualified personnel.



Caution

To reduce the risk of fire or electric shock, do not expose this appliance to rain and moisture. The apparatus shall not be exposed to dripping or splashing liquids and no objects filled with liquids, such as vases, shall be placed on the apparatus.



Caution

These service instructions are for use by qualified service personnel only. To reduce the risk of electric shock do not perform any servicing other than that contained in the operation instructions. Repairs have to be performed by qualified service personnel.

1. Read these instructions.
2. Keep these instructions.
3. Heed all warnings.
4. Follow all instructions.
5. Do not use this apparatus near water.
6. Clean only with dry cloth.
7. Do not block any ventilation openings. Install in accordance with the manufacturer's instructions.
8. Do not install near any heat sources such as radiators, heat registers, stoves, or other apparatus (including amplifiers) that produce heat.

9. Do not defeat the safety purpose of the polarized or grounding-type plug. A polarized plug has two blades with one wider than the other. A grounding-type plug has two blades and a third grounding prong. The wide blade or the third prong are provided for your safety. If the provided plug does not fit into your outlet, consult an electrician for replacement of the obsolete outlet.

10. Protect the power cord from being walked on or pinched particularly at plugs, convenience receptacles, and the point where they exit from the apparatus.

11. Use only attachments/accessories specified by the manufacturer.



12. Use only with the cart, stand, tripod, bracket, or table specified by the manufacturer, or sold with the apparatus. When a cart is used, use caution when moving the cart/apparatus combination to avoid

injury from tip-over.

13. Unplug this apparatus during lightning storms or when unused for long periods of time.

14. Refer all servicing to qualified service personnel. Servicing is required when the apparatus has been damaged in any way, such as power supply cord or plug is damaged, liquid has been spilled or objects have fallen into the apparatus, the apparatus has been exposed to rain or moisture, does not operate normally, or has been dropped.

15. The apparatus shall be connected to a MAINS socket outlet with a protective earthing connection.

16. Where the MAINS plug or an appliance coupler is used as the disconnect device, the disconnect device shall remain readily operable.



LEGAL DISCLAIMER

TECHNICAL SPECIFICATIONS AND APPEARANCES ARE SUBJECT TO CHANGE WITHOUT NOTICE AND ACCURACY IS NOT GUARANTEED. BEHRINGER IS PART OF THE MUSIC GROUP (MUSIC-GROUP.COM). ALL TRADEMARKS ARE THE PROPERTY OF THEIR RESPECTIVE OWNERS. MUSIC GROUP ACCEPTS NO LIABILITY FOR ANY LOSS WHICH MAY BE SUFFERED BY ANY PERSON WHO RELIES EITHER WHOLLY OR IN PART UPON ANY DESCRIPTION, PHOTOGRAPH OR STATEMENT CONTAINED HEREIN. COLORS AND SPECIFICATIONS MAY VARY FROM ACTUAL PRODUCT. MUSIC GROUP PRODUCTS ARE SOLD THROUGH AUTHORIZED FULLFILLERS AND RESELLERS ONLY. FULLFILLERS AND RESELLERS ARE NOT AGENTS OF MUSIC GROUP AND HAVE ABSOLUTELY NO AUTHORITY TO BIND MUSIC GROUP BY ANY EXPRESS OR IMPLIED

UNDERTAKING OR REPRESENTATION. THIS MANUAL IS COPYRIGHTED. NO PART OF THIS MANUAL MAY BE REPRODUCED OR TRANSMITTED IN ANY FORM OR BY ANY MEANS, ELECTRONIC OR MECHANICAL, INCLUDING PHOTOCOPYING AND RECORDING OF ANY KIND, FOR ANY PURPOSE, WITHOUT THE EXPRESS WRITTEN PERMISSION OF MUSIC GROUP IP LTD.

ALL RIGHTS RESERVED.

© 2012 MUSIC Group IP Ltd.

Trident Chambers, Wickhams Cay, P.O. Box 146, Road Town, Tortola, British Virgin Islands

LIMITED WARRANTY

§ 1 Warranty

① This limited warranty is valid only if you purchased the product from a MUSIC Group Authorized Reseller in the country of purchase. A list of authorized resellers can be found on BEHRINGER's website behringer.com under "Where to Buy", or you can contact the MUSIC Group office closest to you.

② MUSIC Group* warrants the mechanical and electronic components of this product to be free of defects in material and workmanship if used under normal operating conditions for a period of one (1) year from the original date of purchase (see the Limited Warranty terms in § 4 below), unless a longer minimum warranty period is mandated by applicable local laws. If the product shows any defects within the specified warranty period and that defect is not excluded under § 4, MUSIC Group shall, at its discretion, either replace or repair the product using suitable new or reconditioned product or parts. In case MUSIC Group decides to replace the entire product, this limited warranty shall apply to the replacement product for the remaining initial warranty period, i.e., one (1) year (or otherwise applicable minimum warranty period) from the date of purchase of the original product.

③ Upon validation of the warranty claim, the repaired or replacement product will be returned to the user freight prepaid by MUSIC Group.

④ Warranty claims other than those indicated above are expressly excluded.

PLEASE RETAIN YOUR SALES RECEIPT. IT IS YOUR PROOF OF PURCHASE COVERING YOUR LIMITED WARRANTY. THIS LIMITED WARRANTY IS VOID WITHOUT SUCH PROOF OF PURCHASE.

§ 2 Online registration

Please do remember to register your new BEHRINGER equipment right after your purchase at behringer.com under "Support" and kindly read the terms and conditions of our limited warranty carefully. Registering your purchase and equipment with us helps us process your repair claims quicker and more efficiently. Thank you for your cooperation!

§ 3 Return materials authorization

① To obtain warranty service, please contact the retailer from whom the equipment was purchased. Should your MUSIC Group Authorized Reseller not be located in your vicinity, you may contact the MUSIC Group Authorized Fulfiller for your country listed under

“Support” at behringer.com. If your country is not listed, please check if your problem can be dealt with by our “Online Support” which may also be found under “Support” at behringer.com. Alternatively, please submit an online warranty claim at behringer.com BEFORE returning the product. All inquiries must be accompanied by a description of the problem and the serial number of the product. After verifying the product’s warranty eligibility with the original sales receipt, MUSIC Group will then issue a Return Materials Authorization (“RMA”) number.

② Subsequently, the product must be returned in its original shipping carton, together with the return authorization number to the address indicated by MUSIC Group.

③ Shipments without freight prepaid will not be accepted.

§ 4 Warranty Exclusions

① This limited warranty does not cover consumable parts including, but not limited to, fuses and batteries. Where applicable, MUSIC Group warrants the valves or meters contained in the product to be free from defects in material and workmanship for a period of ninety (90) days from date of purchase.

② This limited warranty does not cover the product if it has been electronically or mechanically modified in any way. If the product needs to be modified or adapted in order to comply with applicable technical or safety standards on a national or local level, in any country which is not the country for which the product was originally developed and manufactured, this modification/adaptation shall not be considered a defect in materials or workmanship. This limited warranty does not cover any such modification/adaptation, regardless of whether it was carried out properly or not. Under the terms of this limited warranty, MUSIC Group shall not be held responsible for any cost resulting from such a modification/adaptation.

③ This limited warranty covers only the product hardware. It does not cover technical assistance for hardware or software usage and it does not cover any software products whether or not contained in the product. Any such software is provided “AS IS” unless expressly provided for in any enclosed software limited warranty.

④ This limited warranty is invalid if the factory-applied serial number has been altered or removed from the product.

⑤ Free inspections and maintenance/repair work are expressly excluded from this limited warranty, in particular, if caused by improper handling of the product by the user. This also applies to defects caused by normal wear and tear, in particular, of faders, crossfaders, potentiometers, keys/buttons, guitar strings, illuminants and similar parts.

⑥ Damage/defects caused by the following conditions are not covered by this limited warranty:

- improper handling, neglect or failure to operate the unit in compliance with the instructions given in BEHRINGER user or service manuals;

- connection or operation of the unit in any way that does not comply with the technical or safety regulations applicable in the country where the product is used;
- damage/defects caused by acts of God/Nature (accident, fire, flood, etc) or any other condition that is beyond the control of MUSIC Group.

⑦ Any repair or opening of the unit carried out by unauthorized personnel (user included) will void the limited warranty.

⑧ If an inspection of the product by MUSIC Group shows that the defect in question is not covered by the limited warranty, the inspection costs are payable by the customer.

⑨ Products which do not meet the terms of this limited warranty will be repaired exclusively at the buyer’s expense. MUSIC Group or its authorized service center will inform the buyer of any such circumstance. If the buyer fails to submit a written repair order within 6 weeks after notification, MUSIC Group will return the unit C.O.D. with a separate invoice for freight and packing. Such costs will also be invoiced separately when the buyer has sent in a written repair order.

⑩ MUSIC Group Authorized Resellers do not sell new products directly in online auctions. Purchases made through an online auction are on a “buyer beware” basis. Online auction confirmations or sales receipts are not accepted for warranty verification and MUSIC Group will not repair or replace any product purchased through an online auction.

§ 5 Warranty transferability

This limited warranty is extended exclusively to the original buyer (customer of authorized reseller) and is not transferable to anyone who may subsequently purchase this product. No other person (reseller, etc.) shall be entitled to give any warranty promise on behalf of MUSIC Group.

§ 6 Claim for damage

Subject only to the operation of mandatory applicable local laws, MUSIC Group shall have no liability to the buyer under this warranty for any consequential or indirect loss or damage of any kind. In no event shall the liability of MUSIC Group under this limited warranty exceed the invoiced value of the product.

§ 7 Limitation of liability

This limited warranty is the complete and exclusive warranty between you and MUSIC Group. It supersedes all other written or oral communications related to this product. MUSIC Group provides no other warranties for this product.

§ 8 Other warranty rights and national law

① This limited warranty does not exclude or limit the buyer’s statutory rights as a consumer in any way.

② The limited warranty regulations mentioned herein are applicable unless they constitute an infringement of applicable mandatory local laws.

③ This warranty does not detract from the seller’s obligations in regard to any lack of conformity of the product and any hidden defect.

§ 9 Amendment

Warranty service conditions are subject to change without notice. For the latest warranty terms and conditions and additional information regarding MUSIC Group’s limited warranty, please see complete details online at behringer.com.

* MUSIC Group Macao Commercial Offshore Limited of Rue de Pequim No. 202-A, Macau Finance Centre 9/J, Macau, including all MUSIC Group companies

1. Introduction

Often used in the past to compensate for the inadequacies of analogue technology, the exciter in today's Digital Age is a secret weapon of sound engineers for generating contemporary productions that truly stand out. You can now experience this exciting circuit with the SX3040. The unit works with two independent channels, so you can selectively process stereo or two mono signals separately from each other.

Whether you purchased the SX3040 for your studio, live sound or the stage, the unit's sound qualities are so impressive that you'll never again want to do without this sound enhancer when mixing. We at BEHRINGER hope you enjoy your new acquisition.

1.1 Before you get started

1.1.1 Shipment

Your product was carefully packed at the factory to ensure safe transport. Nevertheless, if the box is damaged inspect the unit immediately for signs of damage.

- ◇ If the unit is damaged please do NOT return it to us, but notify your dealer and the shipping company immediately; otherwise, claims for damage or replacement may not be granted.
- ◇ We recommend that you use a flight case to give the unit optimum protection during use or transport.
- ◇ Otherwise, always use the original box to prevent damage during storage or transport.
- ◇ Make sure that children cannot play unsupervised with the unit or its packaging.
- ◇ Please ensure proper disposal of all packing materials. Recycle whenever possible.

1.1.2 Initial operation

Ensure adequate air supply and to avoid overheating do not place the unit near radiators etc.

- ◇ **Blown fuses must be replaced by fuses of the correct rating!** Please refer to the "SPECIFICATIONS" section for the applicable rating.

For connection to the mains use the enclosed power cord with cold connector which complies with the relevant safety regulations.

- ◇ Please make sure that all devices are properly grounded/earthed. For your own safety, never remove or disable the ground/earth conductors from the devices or on the power cords. The unit must always be connected to the mains outlet with a protective grounding connection.
- ◇ The tone quality may diminish within the range of powerful radio broadcasting stations and high-frequency sources. Increase the distance between the transmitter and the unit, and use shielded cables for all connections.

1.1.3 Online registration

Please register your new BEHRINGER equipment right after your purchase by visiting <http://behringer.com> and read the terms and conditions of our warranty carefully.

Should your BEHRINGER product malfunction, it is our intention to have it repaired as quickly as possible. To arrange for warranty service, please contact the BEHRINGER retailer from whom the equipment was purchased. Should your BEHRINGER dealer not be located in your vicinity, you may directly contact one of our subsidiaries. Corresponding contact information is included in the original equipment packaging (Global Contact Information/European Contact Information). Should your country not be listed, please contact the distributor nearest you. A list of distributors can be found in the support area of our website (<http://behringer.com>).

Registering your purchase and equipment with us helps us process your repair claims more quickly and efficiently.

Thank you for your cooperation!

2. Control elements and Connections

2.1 Front panel

The control elements for CHANNEL 1 and CHANNEL 2 are identical. In the following paragraphs the functions are described using CHANNEL 1 as an example.

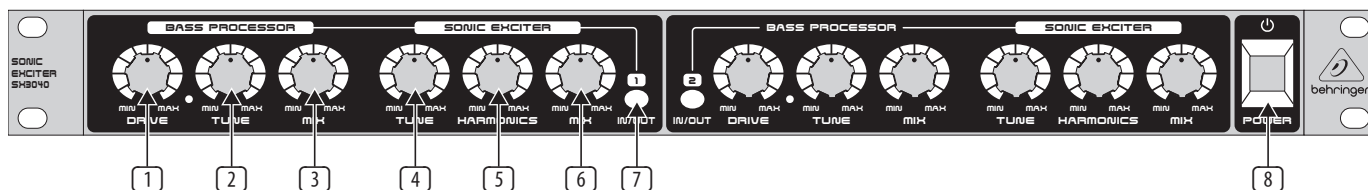

Fig. 2.1: Control elements on the front panel

BASS PROCESSOR

- 1 **DRIVE:** This control adjusts the intensity for bass processing. The optimal working point is set when the green LED lights up regularly as loud bass signal peaks occur. The longer the LED lights up, the longer the duration of the bass signal at peak levels (Sustain), leading to a tighter and more voluminous bass.

- 2 **TUNE:** This control selects an upper cut-off frequency for bass processing. The control range is from 50 Hz (MIN) to 160 Hz (MAX).
- 3 **MIX:** This control defines the portion of the processed bass signal that should be mixed with the original signal.

SONIC EXCITER

- 4 **TUNE:** Sets the cut-off frequency at which the harmonic exciter starts working. The control range is from 1.3 kHz (MIN) to 10 kHz (MAX).
- 5 **HARMONICS:** This control is used to set the number of harmonics that should be added to the signal. This parameter has a direct influence on the detail reproduction and the quality of the sound. Use the "MIN" setting for critical signals, e.g. voice, and "MAX" for extreme processing, e.g. for drums.
- 6 **MIX:** Defines the portion of the harmonic exciter signal that should be mixed with the original signal.
- 7 **IN/OUT:** Activates and deactivates signal processing. The LED lights up in the active operating mode.
- 8 **POWER:** Use the POWER switch to put the unit into operation. The POWER switch should be in the "Off" position when you connect the unit to the power feed (mains).

To disconnect the unit from the mains, pull out the power plug. When switching on the unit ensure that the power plug is easily accessible. To mount the unit in a rack ensure that the unit can easily be disconnected from the mains by means of a plug or an all-pole mains switch on the back side.

- ⚠ **Please note:** Switching the POWER switch off does not disconnect the unit completely from the mains. For this reason you should unplug the power cord if the unit is not going to be used for prolonged periods of time.

2.2 Rear panel

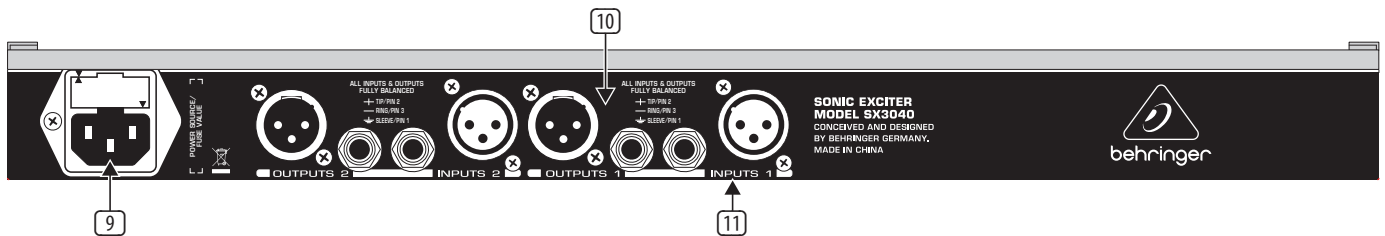

Fig. 2.2: Control elements on the rear panel

- 9 **FUSE HOLDER / IEC POWER SOCKET:** The mains connection is made via an IEC main socket. It complies with relevant safety regulations. A suitable power cord is included. Replace the fuse with a fuse of the same type.
- 10 **OUTPUTS 1:** Balanced XLR sockets and 1/4" jacks. These are used to connect amplifiers as well as further signal processors and recording devices. The jacks and XLR sockets can be used in parallel when two outputs are required.
- 11 **INPUTS 1:** Balanced XLR sockets and 1/4" jacks. These are used to connect line-level signal sources (e.g. a mixing console). To avoid interference, use only the jacks or the XLR sockets, not both at once.
- SERIAL NUMBER:** The serial number can be found on the back right side of the unit. It is needed for online registration.

3. Practical Application

The SX3040 is classified as a psychoacoustic processor. These devices improve sound with sophisticated signal modifications which are subjectively perceived as clearer and more sonically pleasing. Algorithms based on the human sense of hearing influence the quality and the time-based progression of the audio signals without changing the level ratio. The sound is thereby perceived to be more contoured and voluminous. Use the SX3040 for mastering in the studio, for live sound to improve the reproduction quality of PA systems, as a link between instruments and amplifiers or between playback and recording devices for restoring old recordings.

3.1 Two separate unit functions

The SX3040 has two different processing sections for each channel: a BASS PROCESSOR and a HARMONIC EXCITER. The advantage is that the output level is not changed with SX3040 processing. Hence, overloading of loudspeakers and other devices is avoided. Moreover, the sound modification is not static, but dynamic and adapts automatically to different signals.

The BASS PROCESSOR works like a frequency-selective compressor. Depending on the signal dynamics, an adjustable frequency range is compressed, shifted in phase and mixed with the original signal. During the compression, peak levels are temporarily extended and hence perceived to be more intense. The phase shift enhances the bass similarly to a chorus effect.

Exciter-enhanced sound has been a significant part of high-quality commercial productions for decades. The HARMONIC EXCITER enhances the audio material with additional harmonics in dependence of frequency. In instruments the harmonic structure determines the character of the sound as well as the presence and hence the punch. The more harmonics an exciter adds to the original signal and the higher their levels, the more pronounced the signal character.

3.2 Application examples

The SX3040 can be incorporated into a set-up in two different ways:

- Series cable connection
- Parallel cable connection

In the following sections the two variants are described in greater detail.

3.2.1 Series cable connection (Insert mode)

The simplest form of series connection consists of a signal chain in which several devices are connected in a row, e.g. keyboard → effects unit (SX3040) → amplifier. An input signal is fed into the effects unit (SX3040) and a mixed signal consisting of an input signal and a processed effect signal is sent to an amplifier or a recording device (MD recorder, computer etc.) for reproduction.

Another type of series connection can be made by using the Insert point of a mixing console or instrument amplifier. In this configuration the signal is sent out from the mixer channel via a special Y-lead and a mixed signal (dry and effect signals) is routed from the outputs of the effects unit (SX3040) back to the mixer channel.

- ◇ With series connection the dry/wet mix is set with the MIX controls on the effects unit (SX3040).

3.2.2 Parallel cable connection (Aux Send Mode)

Parallel connection can be made via the Aux path of a mixing console. A parallel decoupled pure effect signal from the effects unit is mixed with the unmodified dry signal via this separate effects bus. Mixing of dry and effect signals occurs on the mixing console.

- ◇ With parallel connection the portion of the effect signal that should be added to the original signal is defined with the Aux Return controls on the mixing console. The MIX control on the effects unit (SX3040) must be set to "MAX" for this.

3.2.3 Live sound

The SX3040 is ideally suited for use with live sound systems in clubs, discos, live concerts and public performances. Here the unit not only can considerably improve the signal quality, but also can compensate for the inadequacies of small or weak PA systems.

For this application the unit is ideally employed between the mixing console mix output and the amplifier input. If a graphic equalizer is also used, it should be positioned after the SX3040.

Channels 1 and 2 must have the same setting since this application involves stereo processing. Otherwise, the original stereo image will be distorted.

- ◇ With the MIX controls you define the portion of the processed signal that should be mixed with the original signal separately for the BASS PROCESSOR and SONIC EXCITER sections.

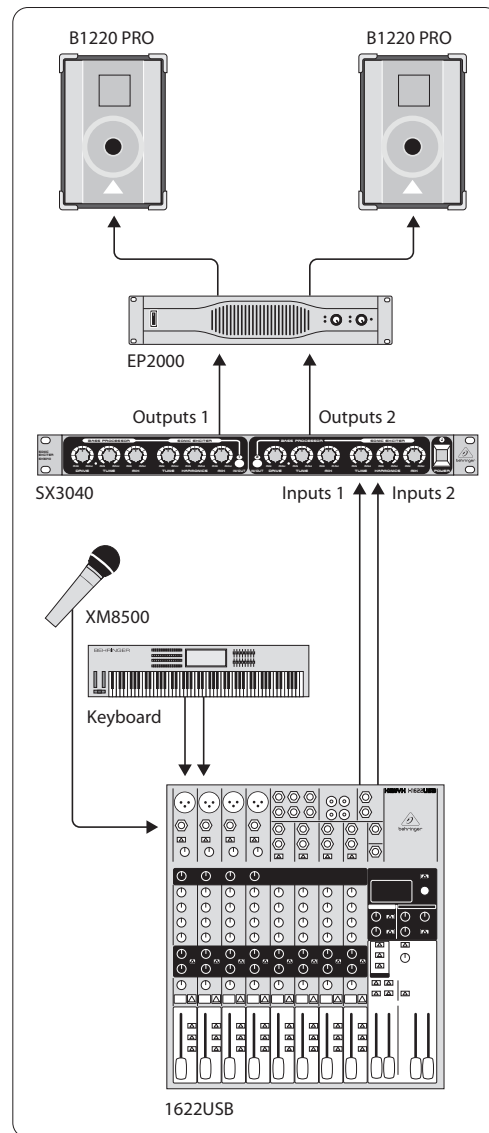

Fig. 3.1: Use of the SX3040 with live sound systems

3.2.4 Studio application

In a studio environment the SONIC EXCITER is ideal for mastering to enhance the sound of recordings. The SX3040 can lend your music the professional polish of high-quality productions in just a few steps. Even if you primarily work with a digital audio workstation, you can perform the final mastering with the SX3040 and an external recorder.

For this application connect the SX3040 before the mastering recorder. Channels 1 and 2 must have the same settings, as this application involves stereo processing. Otherwise, the original stereo image will be distorted.

- ◊ **With the MIX controls you define the portion of the processed signal that should be mixed with the original signal separately for the BASS PROCESSOR and SONIC EXCITER sections.**

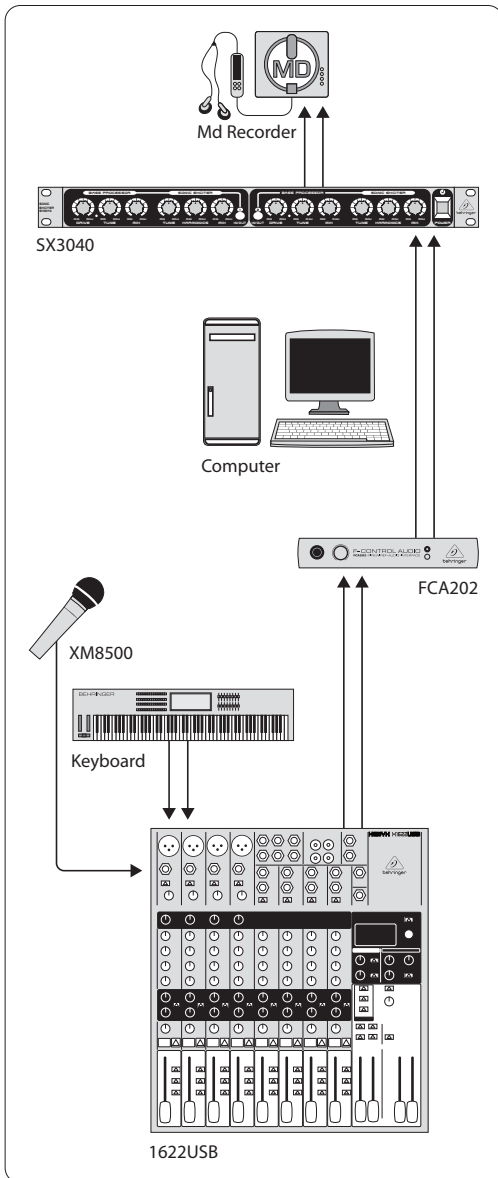

Fig. 3.2: The SX3040 in Studio mode

3.2.5 Stage operation with instrument amplifiers

Besides being ideal for use with stereo signals, the SONIC EXCITER is also suitable for use with one or two individual signals, e. g. guitars. With electric guitars it can be used in combination with a combo amp or a separate modelling processor-amplifier combination to give the guitar sound more presence, fullness and punch. A similar combination with a keyboard and an external amplifier is possible.

Because the two channels of the SX3040 work independently, even two different mono signals can be processed.

Connect the SX3040 to the effects loop connections on your combo amplifier. Determine whether the effects loop connections on your amplifier work in series in Insert mode or in parallel in Aux Send mode. Then set the MIX controls accordingly (see sections 3.2.1 and 3.2.2). If in doubt, refer to the instruction manual for your amplifier.

If you are using a modelling processor, you must connect the processor output to the SX3040 input and route the SX3040 signal to the amplifier.

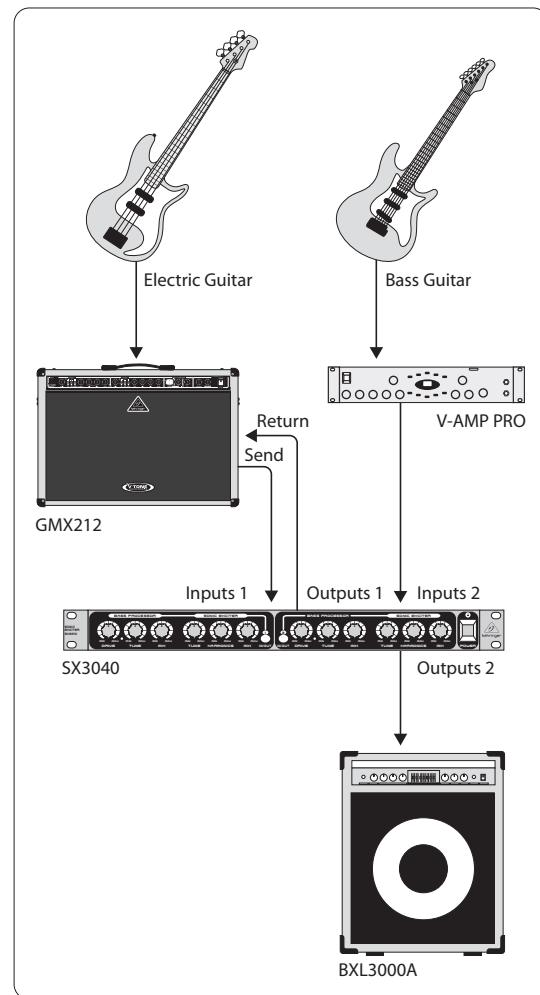







Fig. 3.3: The SX3040 in use with guitar amplifiers

3.3 Basic operation

Due to the small number of SX3040 controls, this is an easy processor to operate.

Perform the following steps:

- 1) Connect the unit according to the application as described in section 3.2.
- ◇ **First make the following settings for one channel (channel 1 or 2 depending on input assignment). For stereo applications choose the same settings for the second channel.**
- 2) Switch on all devices (amplifier and loudspeaker last) and ensure that the **IN/OUT** switch  on the SX3040 is illuminated, i.e. that the unit is working and all controls are set to "MIN". For series connection set the MIX controls to the middle positions; for parallel connection set them to "MAX" (see sections 3.2.1 and 3.2.2).
- 3) Turn the **DRIVE** control  until the desired bass saturation effect is achieved and the green LED regularly lights up when peak levels occur.
- 4) Turn the **TUNE** control  to specify the frequency range for processing.
- 5) Turn the **HARMONICS** control  until the desired enhancement effect in the high-frequency range is achieved.
- 6) Turn the **TUNE** control  to specify the frequency range for processing.
- 7) To compare the original and processed signals, repeatedly press the **IN/OUT** button. Then adjust the dry/wet balance as desired.
- 8) Repeat steps 3) to 7) until you are satisfied with the result.

4. Installation

4.1 Rack mounting

The BEHRINGER SONIC EXCITER SX3040 requires 1 U of height for installation in a 19-inch rack. Please make sure that you leave around 10 cm for the rear connections. For installation of the unit in a rack please use M6 machine screws and nuts.

4.2 Audio connections

There are various ways to integrate the SX3040 into your setup. Depending on the application you will need different connecting cables, and these will be discussed in the following section.

4.2.1 Cabling with jack cables

To operate the SX3040 in series with other equipment, you will need standard commercial 1/4" jack cables, often referred to as instrument cables or patch cables.

These cables have a 1/4" TS jack plug at each end. Connect the inputs of the equipment with the corresponding outputs of each of the other devices.

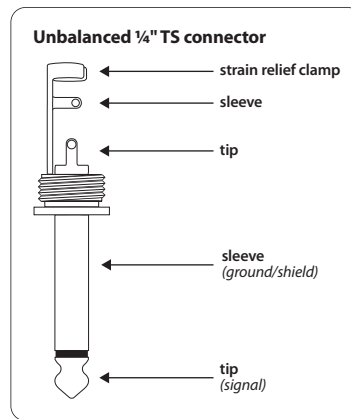

Fig. 4.1: Unbalanced jack cable with 1/4" TS jack plugs

If your other equipment has balanced inputs, use a balanced switched cable with two stereo jack plugs at the balanced outputs of the SX3040. These cables provide a high level of security against interference signals such as noise interference from power cables, and should be used for all long cable routes.

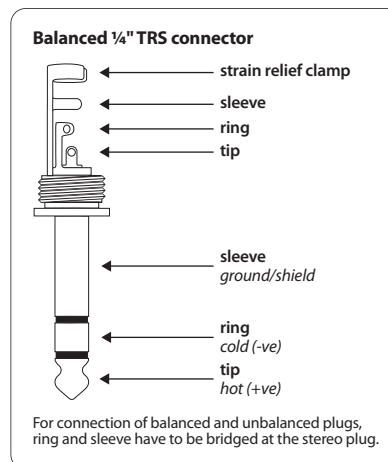

Fig. 4.2: Balanced jack cable with 1/4" TRS jack plugs

Alternatively, you can use professional XLR cables with an XLR socket on one side and an XLR plug on the other side. This cable connection is the most reliable both electrically and mechanically.

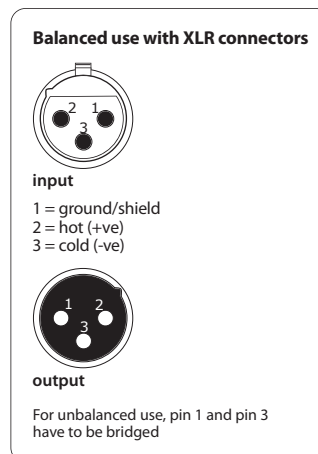

Fig. 4.3: Balanced XLR plug

4.2.2 Connection with insert cables

Use standard ¼" insert cables to connect the SONIC EXCITER to the insert path of a mixing console. These Y cables have two ¼" TS connectors at one end, and one ¼" TRS connector at the other. Connect the plug marked "Send" to the INPUT L jack on the effects unit. Connect the "Return" plug to the OUTPUT L jack on the device. Connect the TRS connector to the insert jack of the channel strip on the mixing console. Use two insert cables for stereo sub-groups and main-mix inserts. The second cable must be connected to the INPUT/OUTPUT R jacks of the SX3040.

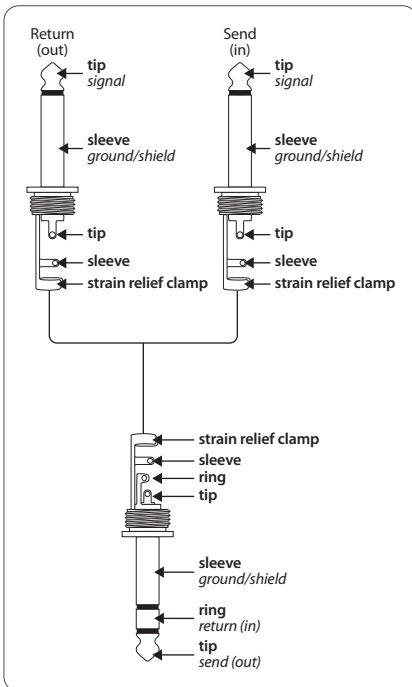

Fig. 4.4: Insert cable with one ¼" TRS (tip-ring-sleeve) jack plug on one end and two ¼" TS (tip-sleeve) jack plugs on the other end

5. Specifications

Inputs

| | |
|---------------------|----------------------------------|
| Connections | XLR sockets and ¼" stereo jacks |
| Type | Balanced |
| Input impedance | 20 kΩ balanced, 10 kΩ unbalanced |
| Nominal input level | +4 dBu |
| Maximum input level | +22 dBu |

Outputs

| | |
|----------------------|---------------------------------|
| Connections | XLR sockets and ¼" stereo jacks |
| Type | Servo-balanced |
| Output impedance | 60 Ω balanced, 60 Ω unbalanced |
| Maximum output level | +22 dBu |

Bass Processor

| | |
|--------------------------|---|
| Type | Frequency-selective compressor with phase shifter |
| Filter cut-off frequency | 50 Hz to 160 Hz |

Sonic Exciter

| | |
|--------------------------|-------------------|
| Type | Harmonic exciter |
| Filter cut-off frequency | 1.3 kHz to 10 kHz |

System Data

| | |
|-----------------------|-------------------------------------|
| Frequency response | 10 Hz to 120 kHz, ± 3 dB |
| Signal-to-noise ratio | >90 dB, unweighted, 20 Hz to 20 kHz |
| Distortion (THD + N) | 0.005 % typ. @ +4 dBu, 1 kHz (IN) |
| Crosstalk | >90 dB |

Power Supply

Mains Voltage

| | |
|---------------------|--|
| USA/Canada | 120 V AC, 60 Hz |
| China/Korea | 220 V AC, 50/60 Hz |
| Europe/UK/Australia | 230 V AC, 50 Hz |
| Japan | 100 V AC, 50-60 Hz |
| Export model | 120/230 V AC, 50-60 Hz |
| Power consumption | approx. 12 W |
| Fuse | 100-120 V AC: T 250 mA, H 250 V 220-240 V AC: T 125 mA, H 250 V |

Dimensions/Weight

| | |
|------------------------|---|
| Dimensions (H x W x D) | approx. 8.54 x 1.8 x 19" approx. 217 x 44.5 x 483 mm |
| Weight | approx. 5.1 lbs / 2.30 kg |

BEHRINGER is constantly striving to maintain the highest professional standards. As a result of these efforts, modifications may be made from time to time to existing products without prior notice. Specifications and appearance may differ from those listed or illustrated.



We Hear You

Free Manuals Download Website

<http://myh66.com>

<http://usermanuals.us>

<http://www.somanuals.com>

<http://www.4manuals.cc>

<http://www.manual-lib.com>

<http://www.404manual.com>

<http://www.luxmanual.com>

<http://aubethermostatmanual.com>

Golf course search by state

<http://golfingnear.com>

Email search by domain

<http://emailbydomain.com>

Auto manuals search

<http://auto.somanuals.com>

TV manuals search

<http://tv.somanuals.com>