

DCY 8502 XB1

# Dryer

## User Manual

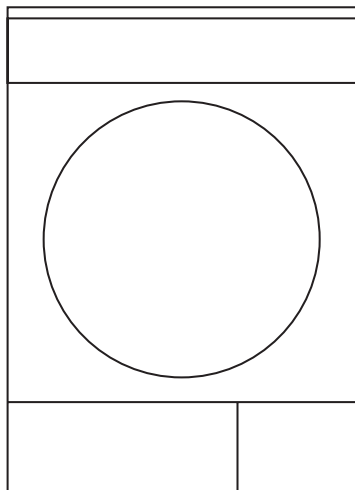

2960310884\_KM/070514.0837

**BEKO**

Download from [Www.Somanuals.com](http://www.Somanuals.com). All Manuals Search And Download.

# Please read this user manual first!

Dear Customer,

Thank you for preferring an Beko product. We hope that your product which has been manufactured with high quality and technology will give you the best results. We advise you to read through this manual and the other accompanying documentation carefully before using your product and keep it for future reference. If you transfer the product to someone else, give its manual as well. Pay attention to all details and warnings specified in the user manual and follow the instructions given therein.

Remember that this user manual is also applicable for several other models. Differences between models will be identified in the manual.

## Explanation of symbols

Throughout this user manual the following symbols are used:

	Important information or useful hints about usage.
	Warning for hazardous situations with regard to life and property.
	Warning against electric shock.
	Warning against hot surfaces.
	Warning against fire hazard.
	Read the instructions.
	Packaging of the product is made of recyclable materials pursuant to our national environment legislation.

Do not dispose of the packaging wastes with the domestic waste or other wastes, discard them to the dedicated collection points designated by the local authorities.

# 1 Important safety and environmental instructions

This section contains safety instructions that will help protect from risk of personal injury or property damage. Failure to follow these instructions shall void any warranty.

## 1.1 General safety

- Dryer can be used by the children at the age of 8 and over and the persons with physical, sensory or mental disorders or unlearned or inexperienced people as long as they are attended by a person who will be responsible for their safety or who will instruct them accordingly about use of the product. Children should not tamper with the machine. Cleaning and user maintenance works should not be carried out by the children unless they are attended by someone.
- Adjustable feet should not be removed. **(See 2.1 Overview)** The gap between the dryer and the surface should not be reduced by the materials such as carpet, wood and tape. This will cause problems with the dryer.
- Always have the installation and repairing procedures carried out by the **Authorized Service Agent**. Manufacturer shall not be held liable for damages that may arise from procedures carried out by unauthorized persons.
- Never wash the dryer by spraying or pouring water onto it! There is the risk of electric shock!

### 1.1.1 Electrical safety



Electrical safety instructions should be followed while electrical connection is made during the installation.

- Connect the dryer to a grounded outlet protected by a fuse at the value specified on the type label. **(See 2.1 Overview)** Have the grounding installation performed by a qualified electrician. Our company shall not be liable for any damages that will arise when the dryer is used without grounding in accordance with the local regulations.
- The voltage and allowed fuse protection is stated on the type label plate. **(See 2.1 Overview)**

## Important safety and environmental instructions

- The voltage specified on the type label must be equal to your mains voltage. **(See 2.1 Overview)**
- Unplug the dryer when it is not in use.
- Unplug the dryer from the mains during installation, maintenance, cleaning and repair works.
- Do not touch the plug with wet hands! Never unplug by pulling on the cable, always pull out by grabbing the plug.
- Do not use extension cords, multi-plugs or adaptors to connect the dryer to power supply in order to decrease the risk of fire and electric shock.
- Power cable plug must be within easy reach after installation.



Damaged mains cable should be changed notifying the Authorized Service.



If the dryer is faulty, it must not be operated unless it is repaired by an authorized service agent! There is the risk of electric shock!

### 1.1.2 Product safety



Points to be taken into consideration for fire hazard:

Below specified laundry or items must not be dried in the dryer considering fire hazard.

- Unwashed laundry items
- Items soiled with oil, acetone, alcohol, fuel oil, kerosene, stain removers, turpentine, paraffin or paraffin removers must be washed in hot water with plenty of detergent before being dried in the dryer.

For this reason especially the items containing the above specified stains must be washed very well, to do this use adequate detergent and choose a high washing temperature.

## Important safety and environmental instructions



Below specified laundry or items must not be dried in the dryer due to the fire hazard:

- Garments or pillows bolstered with rubber foam (latex foam), shower bonnets, water resistant textiles, materials with rubber reinforcement and rubber foam pads.
- Clothing cleaned with industrial chemicals.

Items such as lighter, match, coins, metal parts, needle etc. may damage the drum set or may lead to functional problems. Therefore check all the laundry that you will load into your dryer.

Never stop your dryer before the programme completes. If you must do this, remove all laundry quickly and lay them out to dissipate the heat.



Clothes that are washed inadequately may ignite on their own and even may ignite after drying ends.



Oil-affected items can ignite spontaneously, especially when exposed to heat sources such as in a tumble dryer. The items become warm, causing an oxidation reaction in the oil. Oxidation creates heat. If the heat cannot escape, the items can become hot enough to catch fire. Piling, stacking or storing oil-affected items can prevent heat from escaping and so create a fire hazard.



If it is unavoidable that fabrics that contain vegetable or cooking oil or have been contaminated by hair care products be placed in a tumble dryer they should first be washed in hot water with extra detergent - this will reduce, but not eliminate, the hazard.

- You must provide enough ventilation in order to prevent gases exiting from devices operating with other types of fuels including the naked flame from accumulating in the room due to the back fire effect.

## Important safety and environmental instructions



Underwear that contains metal reinforcements should not be dried in the dryer. Dryer may be damaged if metal reinforcements come loose and break off during drying.



Use softeners and similar products in accordance with the instructions of their manufacturers.



Always clean the lint filter before or after each loading. Never operate the dryer without the lint filter installed.

- Never attempt to repair the dryer by yourself. Do not perform any repair or replacement procedures on the product even if you know or have the ability to perform the required procedure unless it is clearly suggested in the operating instructions or the published service manual. Otherwise, you will be putting your life and others' lives in danger.
- There must not be a lockable, sliding or hinged door that may block the opening of the loading door in the place where your dryer is to be installed.
- Install your dryer at places suitable for home use. (Bathroom, closed balcony, garage etc.)
- Make sure that pets do not enter the dryer. Check the inside of the dryer before operating it.
- Do not lean on the loading door of your dryer when it is open, otherwise it may fall over.
- The lint must not be allowed to accumulate around the tumble dryer.

### 1.2 Mounting over a washing machine

- A fixing device should be used between the two machines when installing the dryer above a washing machine. The fitting device must be installed by the authorized service agent.
- Total weight of the washing machine and the dryer -with full load- when they are placed on top of each other reaches to approx. 180 kilograms. Place the products on a solid floor that has sufficient load carrying capacity!

## Important safety and environmental instructions



Washing machine cannot be placed on the dryer. Pay attention to the above warnings during the installation on your washing machine.

**Installation Table for Washing Machine and Dryer**

Dryer Depth	Washing Machine Depth						
	62cm	60 cm	54 cm	50 cm	49 cm	45 cm	40 cm
54 cm	Can be installed	Can be installed	Can be installed	Can be installed	Can be installed	Can be installed	Cannot be installed
60 cm	Can be installed	Can be installed	Can be installed	Can be installed	Can be installed	Cannot be installed	Cannot be installed

### 1.3 Intended use

- Dryer has been designed for domestic use. It is not designed for commercial purposes and should not be used for other purposes.
- Use the dryer only for drying laundry that are marked accordingly.
- Manufacturer denies any liability for the damages arising from misuse or faulty handling of the product.
- The service life of the dryer that you purchased is 10 years. During this period, original spare parts will be available to operate the dryer properly.

### 1.4 Children's safety

- Packaging materials are dangerous to children. Keep packaging materials away from children.
- Electrical products are dangerous for the children. Keep children away from the product when it is operating. Do not let them tamper with the dryer. Use the child-proof lock in order to prevent the children to tamper with the dryer.

## Important safety and environmental instructions



Child-proof lock is on the control panel. **(See 5.12 Child-proof lock)**

- Keep loading door closed even when the dryer is not in use.

### 1.5 Compliance with the WEEE Directive and disposing of the waste product



This product does not contain the harmful and prohibited substances which are specified in the “Control of the Waste Electrical and Electronic Equipments” as published by Republic of Turkey Ministry of Environment and Urbanization. It complies with the WEEE Directive.

This product was made of high quality items and materials which are recyclable and reusable. Therefore, do not dispose of the product at the end of its service life with the domestic and other wastes. Take them to a collection point for the recycling of the electrical and electronic devices. Ask your local administration for these collection points. By delivering the used products to recycling points, contribute to the protection of the environment and the natural resources. For children's safety, cut the power cord and break the locking mechanism, if any, of the loading door so that the product will be nonfunctional before disposing it.

### 1.6 Packaging information

Packaging of the product is made of recyclable materials pursuant to our national legislation. Do not dispose of the packaging wastes with the domestic waste or other wastes, discard them to the dedicated collection points designated by the local authorities.

Please visit the following website to get more information on the product.

**<http://www.beko.com>**



## Important safety and environmental instructions

### 1.7 Technical Specifications



EN	
Height (min./max.)	84.6 cm / 86. cm*
Width	59.5 cm
Depth	60.9 cm
Laundry drying capacity (max.)	8 kg**
Net weight (use of plastic lid)	38 kg
Net weight (use of glass lid)	40 kg
Voltage	See type labels***
Power	
Main Model Code	

\* Min. height: Height with adjustable feet are closed.

Max. height: Height with adjustable feet are opened maximum.

\*\* Dry laundry weight before washing.

\*\*\* For the location of the type label on the dryer **see 2.1 Overview.**

	Technical specifications of the dryer are subject to specification without notice to improve the quality of the product.
	Figures in this manual are schematic and may not match the product exactly.
	Values stated on markers on the dryer or in the other published documentation accompanying with the dryer are obtained in laboratory in accordance with the relevant standards. Depending on operational and environmental conditions of the dryer, these values may vary.

## 2 Your Dryer

### 2.1 Overview

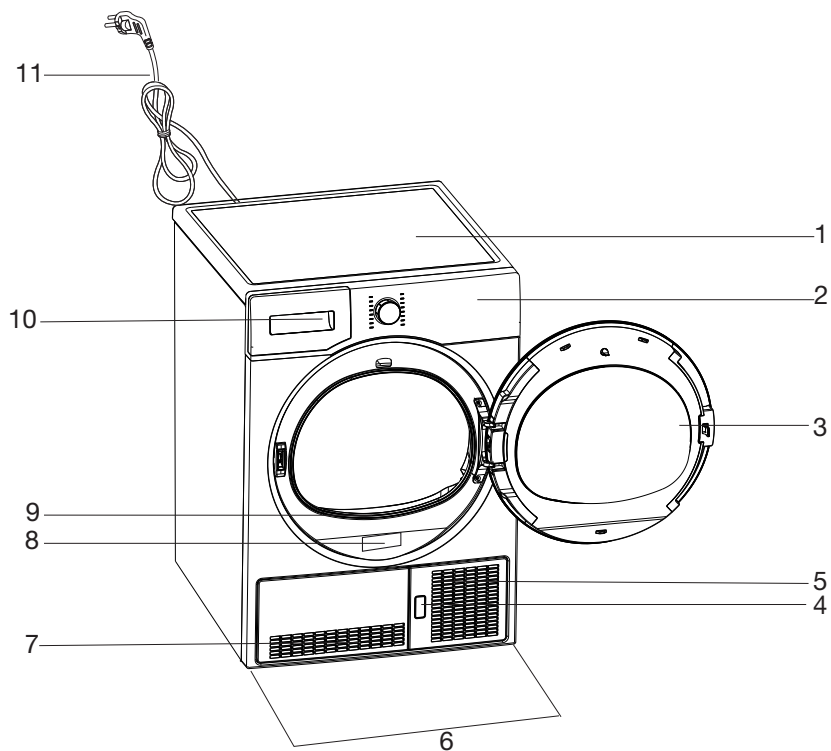

1. Top panel
2. Control panel
3. Loading door
4. Kick plate opening button
5. Ventilation grids
6. Adjustable feet
7. Kick plate
8. Type label
9. Lint filter
10. Water tank drawer
11. Power cord

### 3 Installation

Before the calling the nearest Authorized Service for the installation of the dryer, ensure that electrical installation and water drain is appropriate referring to the user's manual. **(See 3.3 Connecting to the drain and 3.5 Electrical connection)** If they are not suitable, contact a qualified electrician and technician to make necessary arrangements.



Preparation of the dryer's location as well as the electrical and waste water installations is under customer's responsibility.



Prior to installation, visually check if the dryer has any defects on it. If the drier is damaged, do not have it installed. Damaged products cause risks for your safety.

#### 3.1 Appropriate installation location

Install the dryer on a stable and level surface.

Dryer is heavy. Do not move it by yourself.

- Operate your dryer in a well ventilated, dust-free environment.
- The gap between the dryer and the surface should not be reduced by the materials such as carpet, wood and tape.
- Do not cover the ventilation grills of the dryer.
- There must not be a lockable, sliding or hinged door that may block the opening of the loading door in the place where your dryer is to be installed.
- Once the dryer is installed, it should stay at the same place where its connections have been made. When installing the dryer, make sure that its rear wall does not touch anywhere (tap, socket, etc.).
- Place the dryer at least 1 cm away from the edges of other furniture.
- Your dryer can be operated at temperatures between +5°C and +35°C. If the operating conditions fall outside of this range, operation of the dryer will be adversely affected and it can get damaged.
- The rear surface of the tumble dryer shall be placed against a wall.



Do not place the dryer on the power cable.

#### 3.2 Removing the transportation safety assembly



Remove the transportation safety assembly before using the dryer for the first time.

Open the loading door.

There is a nylon bag inside the drum that contains a piece of styrofoam. Hold it from its section marked with **XX XX**. Pull the nylon towards yourself and remove the transportation safety assembly.

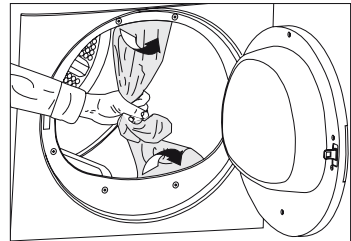

Check that no part of the transportation safety assembly remains inside the drum.

#### 3.3 Connecting to the drain

In products equipped with condenser unit, water accumulates in the water tank during the drying cycle. You should drain accumulated water after each drying cycle.

You can directly drain accumulated water through the water drain hose supplied with the product instead of periodically draining the water collected in the water tank.

##### Connecting the water drain hose

- 1-2** Pull hose at the behind of the dryer by hand in order to disconnect it from where it is connected. Do not use any tools to remove the hose.
- 3** Connect one end of the drain hose supplied with the dryer to the connection point from where you removed the hose of the product in previous step.
- 4** Connect the other end of the drain hose directly to the wastewater drain or to the washbasin.

## Installation

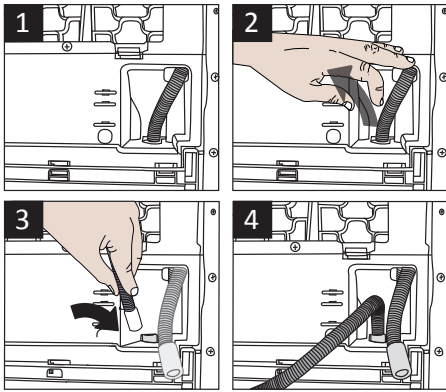

### 3.5 Electrical connection

For specific instructions for electrical connection required during installation (see 1.1.1 Electrical Safety)

### 3.6 Transportation of the dryer

Unplug the dryer before transporting it.

Drain all water that has remained in the dryer.

If direct water drain connection is made, then remove the hose connections.



We recommend carrying the dryer in upright position. If it is not possible to carry the machine in the upright position, we recommend carrying it by tilting towards the right side when looked from the front.



Hose connection should be made in a safe manner. Your drain house will be flooded if the hose comes out of its housing during water discharge.



Water drain hose should be attached to a height of maximum 80 cm.



Make sure that the water drain hose is not stepped on and it is not folded between the drain and the machine.

### 3.4 Adjusting the feet

In order to ensure that the dryer operates more silently and vibration-free, it must stand level and balanced on its feet. Balance the machine by adjusting the feet.

Turn the feet to left or right until the dryer stands level and firmly.

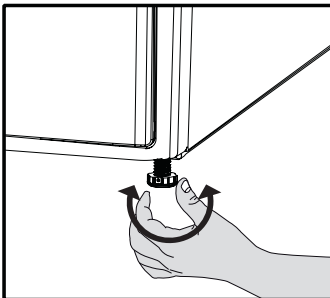

Never unscrew the adjustable feet from their housings.

## 4 Preparation

### 4.1 Laundry suitable for drying in the dryer

Always obey the instructions given on the garment tags. Dry only the laundry having a label stating that they are suitable for drying in a dryer and make sure that you select the appropriate programme.

LAUNDRY DRYING SYMBOLS																							
	Drying Symbols		Suitable for dryer		No Iron		Sensitive / Delicate dry		Do not dry with dryer		Do not dry		Do not dry-clean										
	Drying Settings		At any temperature		At high temperature		At medium temperature		At low temperature		Without heating		Hang to dry		Lay to dry		Hang wet to dry		Lay in shadow to dry		Dry-cleanable		
	IRON	Iron -		Iron at high temperature		Iron at medium temperature		Iron at low temperature		Do not iron		Iron without steam											
		Dry or Steam																					
		Maximum temperature		200 °C		150 °C		110 °C															

### 4.2 Laundry not suitable for drying in the dryer



Delicate embroidered fabrics, woolen, silk garments, delicate and valuable fabrics, airtight items and tulle curtains are not suitable for machine drying.

### 4.3 Preparing laundry for drying

- Laundry may be tangled with each other after washing. Separate the laundry items before placing them into the dryer.
- Dry garments having metal accessories such as zippers, inside out.
- Fasten the zippers, hooks and buckles and button sheets.

### 4.4 Things to be done for energy saving

Following information will help you use the dryer in an ecological and energy-efficient manner.

- Spin your laundry at the highest speed possible when washing them. Thus, the drying time is shortened and energy consumption is reduced. (See **5.7 Programme selection and consumption table**)

- Sort out the laundry depending on their type and thickness. Dry the same type of laundry together. For example thin kitchen towels and table clothes dries earlier than thick bathroom towels. (See **5.7 Programme selection and consumption table**)
- Follow the instructions in the user manual for programme selection.
- Do not open the loading door of the machine during drying unless necessary. If you must certainly open the loading door, do not to keep it open for a long time.
- Do not add wet laundry while the dryer is in operation
- Clean the lint filter before or after each drying cycle. (See **6.1 in Maintenance and cleaning**)
- Clean the condenser regularly at least once every month or after every 30 drying cycles. (See **6.4 in Maintenance and cleaning**)
- Ventilate the room, where the dryer is located, well during drying.

## Preparation

### 4.5 Correct load capacity

Follow the instructions in the “Programme selection and consumption table”. Do not load more than the capacity values stated in the table.

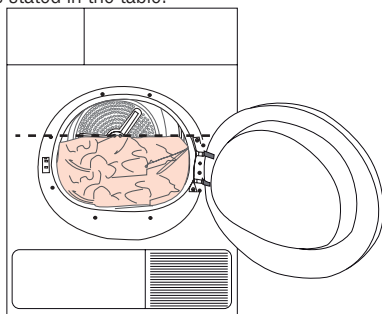

It is not recommended to load the dryer with laundry exceeding the level indicated in the figure. Drying performance will degrade when the machine is overloaded. Furthermore, dryer and the laundry can get damaged.

Following weights are given as examples.

Laundry	Approximate weights (g)*
Cotton quit covers (double)	1500
Cotton quit covers (single)	1000
Bed sheets (double)	500
Bed sheets (single)	350
Large tablecloths	700
Small tablecloths	250
Tea napkins	100
Bath towels	700
Hand towels	350
Blouses	150
Cotton shirts	300
Shirts	200
Cotton dresses	500
Dresses	350
Jeans	700
Handkerchiefs (10 pieces)	100
T-Shirts	125

\*Dry laundry weight before washing.

# 5 Operating the product

## 5.1 Control panel

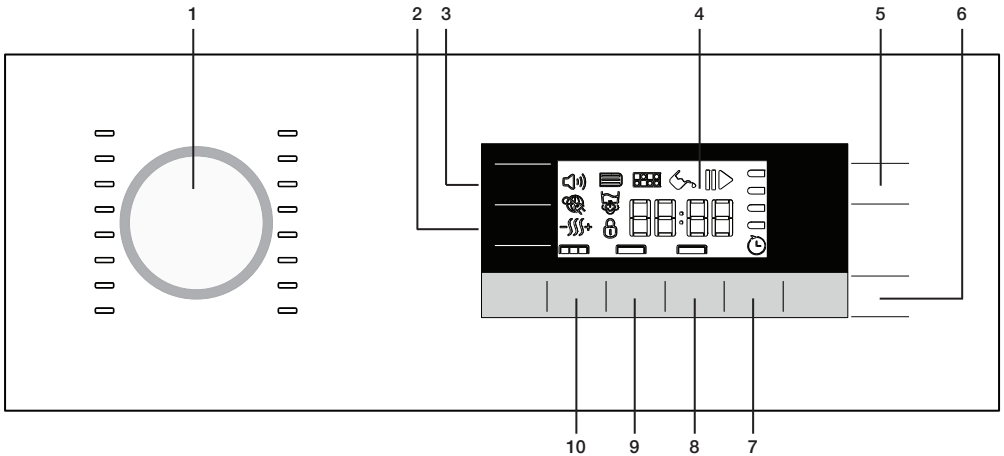

- 1. Programme Selection knob
- 2. Dryness Level Adjustment button
- 3. Audio Warning Level button
- 4. Display
- 5. On /Off/Cancel button
- 6. Start/Pause button
- 7. End Time button
- 8. Favourite button
- 9. Timer Programmes Selection button
- 10. Anti-creasing button

## 5.2 Display symbols

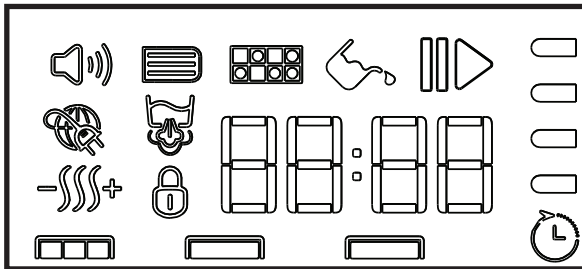

- Audio warning Symbol
- Condenser cleaning warning symbol
- Filter cleaning warning symbol
- Water tank warning symbol
- Smart grid symbol
- Steam tank warning symbol
- Child lock warning symbol
- End time symbol
- Start / Pause symbol
- Remaining time indicator\*
- Programme progress bar

\*Time that appears on display indicates the remaining time until the end of the programme and changes according to the dampness level of the laundry and model of the dryer.

## Operating the product

### 5.3 Preparing the machine

1. Plug in your machine.
2. Place the laundry in the machine.
3. Press the **On/Off/Cancel** button for 1 second (long).
4. When your machine is operated for the first time, it starts with the declaration programme (wardrobe dryness for cottons.)



Pressing the **On/Off/Cancel** button does not mean that the programme has started. Press **Start / Pause** button to start the program.

### 5.4 Programme selection

1. Decide the appropriate programme from the table below which includes drying levels.
2. Select the desired programme with the **Programme Selection** knob.

Extra Dry	Only the cotton laundry is dried at normal temperature. Thick and multi layered laundry (towels, linens, jeans and etc.) are dried in a way that they do not require ironing before being placed in the wardrobe.
Cupboard Dry	Normal laundry (tablecloths, underwear and etc.) are dried in a way that they do not require ironing before being placed in the wardrobe.
Iron Dry	Normal laundry (shirts, dresses and etc.) are dried ready to be ironed.



For further programme details, see "Programme selection and consumption table"..

### 5.5 Main programmes

Depending on the fabric type, the following main programmes are available.

#### ▪ Cottons

Dry durable laundry with this programme. Dries at normal temperature. It is recommended to use for your cotton items (bed sheets, quilt covers, towels, bathrobes, etc.).

#### ▪ Synthetics

Dry less durable laundry with this programme. Recommended for synthetics.

### 5.6 Additional programmes

For special cases, following additional programmes are available in the machine.



Additional programs may differ according to the features of your machine.



To obtain better results from your dryer, your laundry must be washed at suitable programmes and spun at the recommended spin speeds in the washing machine..

#### ▪ Jeans

Use this programme to dry your jeans that are spun at high speeds in the washing machine.

#### ▪ Mix

Use this programme to dry non-pigmenting synthetic and cotton laundry items together.

#### ▪ Sports

Use this programme to dry together the synthetic and cotton laundry items and the laundry items made of mixed fabrics.

#### ▪ Wool Refresh

Use this programme to ventilate and soften the woolen laundry that can be washed in the washing machine. Do not use to dry the laundry completely. Take out and ventilate the laundry immediately after the programme is over.

#### ▪ Xpress

You can use this programme to dry your cotton laundry that you have spun at high speeds in your washing machine. This programme dries 1 kg cotton laundry (3 Shirts / 3 T-shirts) in 35 minutes.

#### ▪ BabyProtect

This programme is used for baby clothes that bear machine dryable approval on its label.

#### ▪ Daily

This programme is used to dry cottons and synthetics daily, and lasts for 72 minutes.

#### ▪ Shirt

This programme dries the shirts more sensitively and creases them less and thus, helps to iron them more easily.



There may be a little moisture on the shirts at the end of the programme. We recommend you not to leave the shirts in the dryer.

#### ▪ Delicates

You can dry your highly delicate laundry (silk blouses, fine underwear, etc.) that are suitable for drying or laundry which is advised to be hand-washed at a lower temperature.



## Operating the product



It is recommended to use a cloth bag to avoid certain delicate garments and laundry from getting creased or damaged. Take your laundry immediately out of the dryer and hang them after the programme ends in order to prevent them being creased.

### ▪ **Freshen Up**

Only ventilation is performed for 10 minutes without blowing hot air. You can air the clothes that have been kept at closed environments for a long time and deodorize unpleasant odors thanks to this programme.

### ▪ **Timer programmes**

You can select one of the 10 min., 20 min., 30 min., 40 min., 50 min., 60 min., 80 min., 100 min., 120 min., 140 min. and 160 min. timer programmes to achieve the desired final drying level at low temperatures.







With this programme, the machine dries for the time selected regardless of the dryness level.

## Operating the product

### 5.7 Programme selection and consumption table

EN

Programs	Capacity (kg)	Spin speed in washing machine (rpm)	Approximate amount of remaining humidity	Drying time (minutes)
Cottons / Coloreds				
 Extra dry	8	1000	% 60	154
 Cupboard dry	8	1000	% 60	142
 Iron dry	8	1000	% 60	120
Xpress 35'	1,5	1200	%50	35
Shirt	1.5	1200	%50	45
Jeans	4	1200	%50	90
Mixed	4	1000	%60	90
Sport	4	1000	%60	100
Wool Refresh	1.5	600	%50	6
Daily	4	1200	%50	72
BabyProtect	3	1000	%60	80
Synthetics				
 Cupboard dry	4	800	% 40	60
Delicates				
 Cupboard dry	2	600	% 40	45
Energy consumption values				
Programs	Capacity (kg)	Energy consumption value kWh per year		Energy rating star
Cottons-Extra Dry*	8	349		2

\* : Energy Label standard program (AS/NZS 2442)

All values given in the table have been fixed according to standard laboratory conditions. These values may deviate from the table according to the laundry type, laundry spin speed, environmental conditions and voltage fluctuations.

## Operating the product

### 5.8 Auxiliary functions

#### Audio Warning

 The machine will give an audio warning when the programme comes to an end. Use the **Audio Warning Level** button to adjust the sound level.



You can change the sound level either before the programme starts or while the programme is in progress.

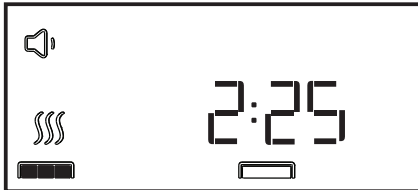

Volume level low

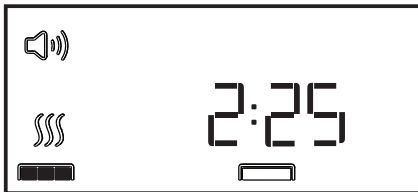

Volume level high

#### Dryness level adjustment selection

 **Dryness level adjustment** button is used to adjust the required dryness level. Programme duration can change depending on the selection.



You can activate this function only before the programme has started.

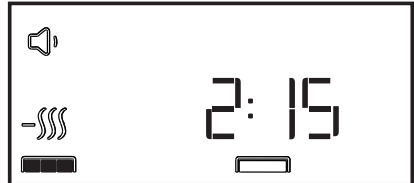

Drying level damp



Drying level normal

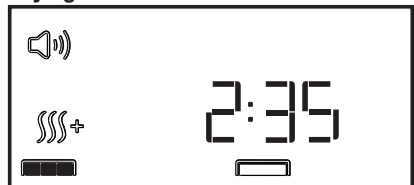

Drying level extra

## Operating the product

### Anti-creasing

 Anti-creasing programme duration may be changed with the **Anti-creasing** selection button. You can use Anti-creasing function to prevent laundry from creasing if you will not take the laundry out after the program has come to an end. This programme rotates the laundry in every 240 second for selected time to prevent creasing. Following images identify the level changes.

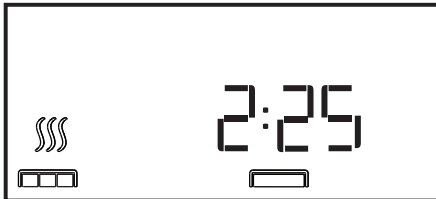

Anti-creasing 0 minute

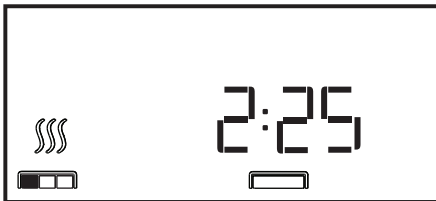

Anti-creasing 30 minute

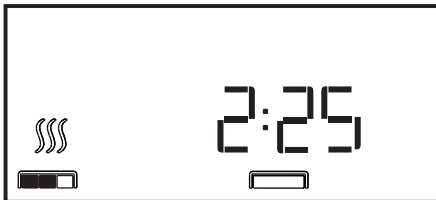

Anti-creasing 60 minute



Anti-creasing 120 minute



Press **Anti-creasing** button to activate this function.



Anti-creasing symbol will illuminate at the end of the programme if Anti-creasing function is activated.

### Favourite selection button

A programme with the set auxiliary function is saved with **Favourite selection** button. When the product is switched on and off, features of the saved programme is displayed by means of **Favourite selection** button.

1. Select the programme with the programme knob; select the auxiliary functions such as Anti-creasing, Dryness Level etc.
2. Press and hold the **Favourite selection** button for about 3 seconds. Features of set programme will be saved.

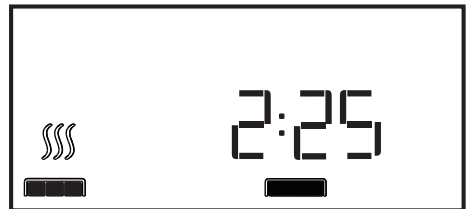

### 5.9 Warning symbols



Warning symbols may differ according to the model of your machine.

### Lint filter cleaning

When the programme is completed, a warning symbol will appear to remind that the filter needs to be cleaned.



If the Filter Cleaning symbol flashes continuously, refer to "Troubleshooting" section.

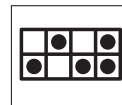

### Water tank

When the programme is completed, a warning symbol will appear to remind that the water tank needs to be drained.

If the water tank becomes full while the programme is running, the warning symbol will start to flash and machine will pause. Drain the water in the water tank and press **Start / Pause** button to resume the programme. The warning symbol turns off and the programme resumes operating.

## Operating the product



### Cleaning the condenser

Warning symbol flashes with certain intervals to remind that the condenser needs to be cleaned.



### Loading door open

This warning symbol **Pause** appears and programme progress symbol flashes when the loading door of the dryer is open.

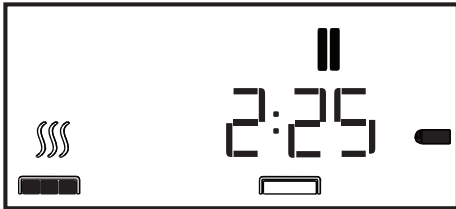

### End time

**With the End Time** function, the end time of the programme may be delayed up to 24 hours.

1. Open the loading door and put the laundry in.
2. Select the drying programme, spin speed and, if required, the auxiliary functions.
3. Press **End time** button to set the desired time delay. **End time** symbol flashes on the display. (When the button is pressed on, **End time** proceeds continuously)
4. Press **Start / Pause** button. **End time** starts countdown and **Start** symbol lights up on the display. The ":" in the middle of the displayed delay time flashes.

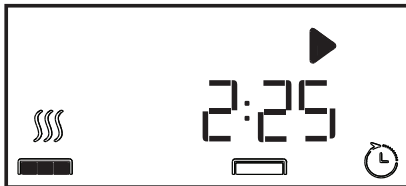

Additional laundry may be loaded / taken out during the End time. At the end of the countdown process, end time symbol disappears, drying process starts and the programme duration is displayed. The time on the display is the total of normal drying time and end time.

### Changing the End time

If you want to change the time during countdown:

1. Press **On/Off/Cancel** button for 3 seconds to cancel the programme. Restart the machine and repeat the Delay Setting procedure for the desired time.
2. When your machine is operated for the first time, it starts with the declaration programme (wardrobe dryness for cottons).

### Cancelling the end time

If you want to cancel the End time countdown and start the programme immediately:

1. Press **On/Off/Cancel** button for 3 seconds to cancel the programme.
2. Press **On/Off/Cancel** button to start the programme you have previously selected.

### 5.10 Starting the programme

Press the **Start/Pause** button to start the program.

**Start** ► symbol will light up to indicate that the programme has started and ":" symbol in the middle of the remaining time will keep flashing. Progress of Programme Symbol flashes on the screen.

### 5.11. Progress of programme

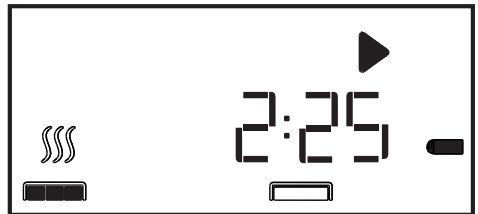

### 5.12 Child Lock

Machine is equipped with a Childproof Lock which prevents interfering with the current programme flow by pressing any button. All buttons except the **On/Off/Cancel** button on the control panel are deactivated when the Child-proof Lock is active.

**In order to activate the Childproof Lock**, press Anti-creasing button for 3 seconds.

To start a new programme after the current programme is over or to interrupt the current programme, the Child-proof Lock should be deactivated. Press the same button for 3 seconds again **to deactivate the Child-proof Lock**.



Lock symbol will appear on the display when the Child-proof Lock is activated.

## Operating the product

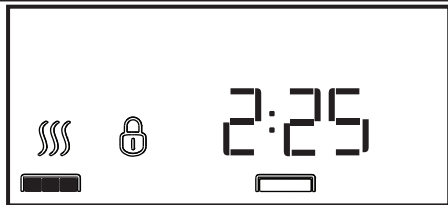

Child-proof Lock is deactivated when the machine is switched off and on with On/Off/Cancel button.

When the Child-proof Lock is activated:

Display symbols will not change even if the position of Programme Selection knob is changed while the machine is running or in halt.

### 5.13 Changing the programme after it has started

After the machine starts, you can change the selected programme and dry your laundry in a different programme.

1. If you want to select Extra Dry programme instead of Iron Dry programme, press and hold the **Start / Pause** button to stop the programme.
2. Select Extra Dry programme by turning the **Programme Selection** knob.
3. Press the **Start/Pause** button to start the program.

### Adding / removing laundry in Pause mode

In order to add or take out laundry after the drying programme has started:

1. Press **Start/Pause** button to switch the machine to Pause mode. Drying process will stop.
2. While in **Pause** mode, open the loading door, add or take out laundry and close the loading door.
3. Press the **Start/Pause** button to start the program.



Any laundry added after the drying process has started may cause the clothes that are already dried in the machine intermingle with wet clothes and the result will be wet laundry after the drying process is over.



You may repeat laundry adding or removing process as many times as you desire during drying. However, this process will increase the programme time and energy consumption since the drying process will be interrupted repeatedly. Therefore, it is recommended to add laundry before the drying programme has started.



If you select a new programme by turning the Programme Selection knob while your machine is in Pause mode, then the current program is aborted and new programme information is displayed.



**CAUTION:** Do not touch the inner surface of the drum when adding or taking out laundry while a programme is running. Surfaces of the drum are hot.

### 5.14 Canceling the programme

If you want to stop drying and cancel the programme for any reason after the machine has started to run, press and hold the **On/Off/Cancel** button for 3 seconds.



**CAUTION:** As the inside of the machine will be excessively hot when you cancel the program while the machine is running, activate the ventilation program to cool it down.

### 5.15 End of programme

Lint Filter Cleaning and Water Tank warning symbols light up in the programme follow-up indicator when the programme comes to an end. The loading door can be opened and the machine becomes ready for a second cycle.

Press **On/Off/Cancel** button to switch off the machine.

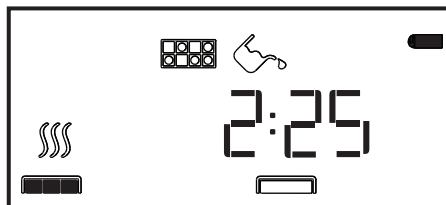

If Anti-creasing function is activated and the laundry is not taken from the machine at the end of the programme, 2-hours (depends on selection) Anti-creasing programme is activated.



Clean the lint filter after each drying. (See "Lint Filter and Loading Door Inner Surface")



Drain the water tank after each drying cycle. (See "Draining the water tank")

## 6 Maintenance and cleaning

Service life of product extends and frequently experienced problems will be reduced if it is cleaned at regular intervals.

### 6.1 Cleaning Lint Filter / Loading Door Inner Surface

Lint and fiber released from the laundry to the air during the drying cycle are collected in the Lint Filter.



Such fiber and lint are generally formed during wearing and washing.



Always clean the lint filter and the inner surfaces of the loading door after each drying process.



You can clean the lint filter housing with a vacuum cleaner.

To clean the lint filter:

- Open the loading door.
- Remove the lint filter by pulling it up and open the lint filter.
- Clean lint, fiber, and cotton raveling by hand or with a soft piece of cloth.
- Close the lint filter and place it back into its housing.

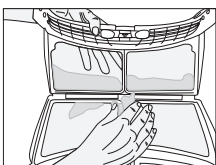
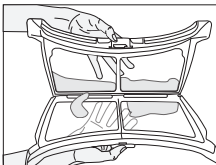
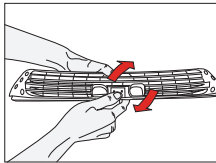
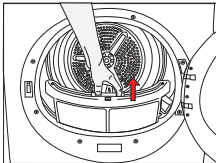

- A layer can build up on the filter pores that can cause clogging of the filter after using the dryer for a while. Wash the lint filter with warm water to remove the layer that builds up on the lint filter surface. Dry the lint filter completely before reinstalling it.

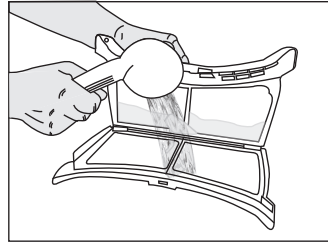

- Clean the entire inner surface of the loading door and loading door gasket with a soft damp cloth.

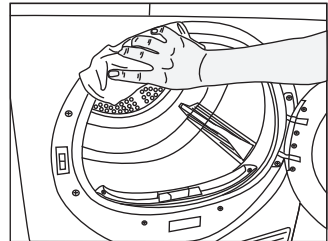
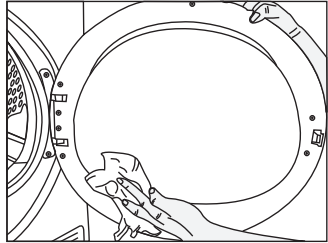

### 6.2 Cleaning the sensor

There are dampness sensors in the dryer that detect whether the laundry is dry or not.

To clean the sensors:

- Open the loading door of the dryer.
- Allow the machine to cool down if it is still hot due to the drying process.
- Wipe the metal surfaces of the sensor with a soft cloth, dampened with vinegar and dry them.



Clean metal surfaces of the sensors 4 times a year.

## Maintenance and cleaning



Do not use metal tools when cleaning metal surfaces of the sensors.



Never use solvents, cleaning agents or similar substances for cleaning due to the risk of fire and explosion!

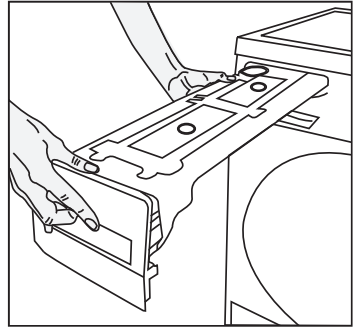
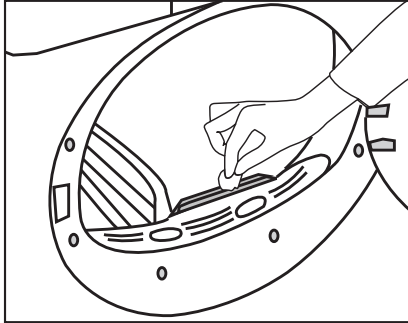

- Drain the water in the tank.

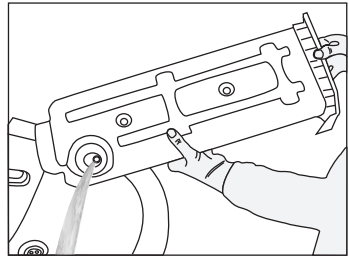

- If there is lint accumulation in the funnel of the water tank, clean it under running water.
- Place the water tank into its seat.



If the direct water draining is used as an option, there is no need to empty the water tank.

### 6.3 Draining the water tank

Dampness of the laundry is removed and condensed during drying process and the water that arise accumulates in the water tank. Drain the water tank after each drying cycle.



Condensed water is not drinkable!



Never remove the water tank when the program is running!

If you forget to drain the water tank, the machine will stop during the subsequent drying cycles when the water tank is full and the Water Tank warning symbol will flash. If this is the case, drain the water tank and press **Start / Pause** button to resume the drying cycle.

To drain the water tank:

Pull the drawer and remove the water tank carefully.



## Maintenance and cleaning

### 6.4 Cleaning the condenser;

Hot and humid air in the condenser is cooled with the cold air from the room. Thus, the humid air circulating in your dryer is condensed and then pumped into the tank.



Clean the condenser after every 30 drying cycles or once a month.

To clean the condenser:

1. If a drying process has been carried out, open the door of the machine and wait until it cools down.

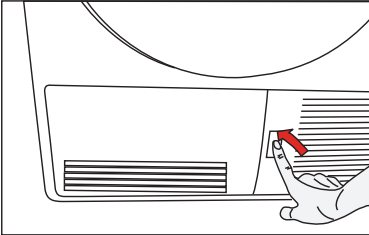

2. Unlock the 2 condenser locks after opening the kick plate.

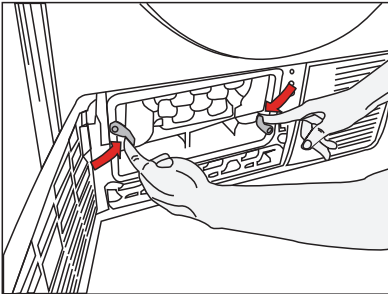

3. Pull out the condenser.

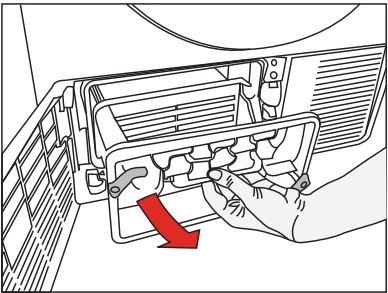

4. Clean the condenser by applying pressurized water with a shower armature and wait until the water drains.

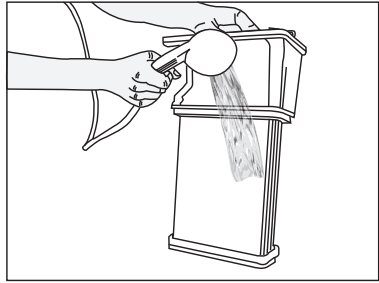

5. Place the condenser in its housing. Fasten the 2 locks and make sure that they are seated securely.

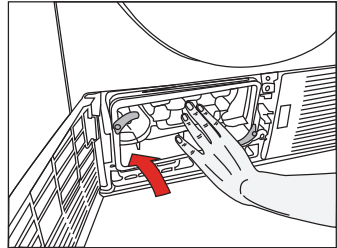

6. Close the kick plate cover.

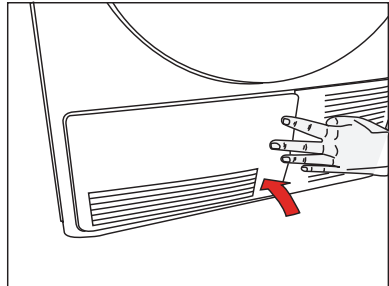

## 6 Suggested solutions for problems

Drying process takes too much time
<ul style="list-style-type: none"><li>• Meshes of the filter may be clogged. Wash with water.</li></ul>
Laundry comes out wet at the end of drying.
<ul style="list-style-type: none"><li>• Meshes of the filter may be clogged. Wash with water.</li><li>• Excessive laundry might have been loaded in. Do not load the dryer in excess.</li></ul>
Dryer does not switch on or the programme does not start. Dryer is not activated when set.
<ul style="list-style-type: none"><li>• It might have not been plugged in. Make sure that the machine is plugged in.</li><li>• The loading door may be ajar. Make sure that the loading door is properly closed.</li><li>• Programme might have not been set or the "Start/Pause/Cancel" button might have not been pressed. Make sure that the programme has been set and it is not in "Pause" mode.</li><li>• "Childproof lock" might have been activated. Deactivate the childproof lock.</li></ul>
Programme has been interrupted without any cause.
<ul style="list-style-type: none"><li>• The loading door may be ajar. Make sure that the loading door is properly closed.</li><li>• Electricity may be cut off. Press "Start/Pause/Cancel" button to start the programme.</li></ul>
Laundry has shrunk, become felted or deteriorated.
<ul style="list-style-type: none"><li>• A programme suitable for the laundry type might have not been used. Dry only the laundry which is suitable for drying in dryer after checking the labels on your clothes.</li><li>• Select a programme with suitable low temperature for the laundry type to dry your clothes.</li></ul>
Drum lightning does not come on.
<ul style="list-style-type: none"><li>• Dryer might have not been started by using the "On/Off" button. Make sure that the dryer is on.</li><li>• Bulb may have blown. Call the authorized service to replace the bulb.</li></ul>
"Final / Anti-creasing" symbol flashes.
<ul style="list-style-type: none"><li>• The 2-hour anti creasing programme to prevent laundry from creasing might have been activated. Turn off the dryer and take out the laundry.</li></ul>
"Final / Anti-creasing" symbol is on.
<ul style="list-style-type: none"><li>• Programme has come to an end. Turn off the dryer and take out the laundry.</li></ul>
Water comes out the cover.
<ul style="list-style-type: none"><li>• Clean the entire inner surface of the cover and door gasket.</li></ul>
Cover opens spontaneously.
<ul style="list-style-type: none"><li>• Push it until you hear that it is closed.</li></ul>
For products with a condenser:
"Water tank" warning symbol is on.
<ul style="list-style-type: none"><li>• Water may be full.</li><li>• Anti-creasing programme might be running. Drain the water in the tank.</li></ul>
"Filter cleaning" symbol is on.
<ul style="list-style-type: none"><li>• Filter might have not been cleaned. Clean the cover filter.</li></ul>
"Condenser cleaning" symbol is on.
<ul style="list-style-type: none"><li>• Filter drawer/Condenser might have not been cleaned. Clean the filters in the condenser/filter drawer under the kick plate.</li></ul>



Call an authorised service if the problem persists.





## Free Manuals Download Website

<http://myh66.com>

<http://usermanuals.us>

<http://www.somanuals.com>

<http://www.4manuals.cc>

<http://www.manual-lib.com>

<http://www.404manual.com>

<http://www.luxmanual.com>

<http://aubethermostatmanual.com>

Golf course search by state

<http://golfingnear.com>

Email search by domain

<http://emailbydomain.com>

Auto manuals search

<http://auto.somanuals.com>

TV manuals search

<http://tv.somanuals.com>