

**DivX Player
User Manual**

DVD 2008

BEKO

Please read this manual first!

Dear Customer,

We hope that your product which has been manufactured in modern facilities and passed through a strict quality control procedure will give you the best results.

Therefore, we advise you to read through this manual carefully before using your product and keep it for future reference.

This user manual will...

... help you use your machine in a fast and safe way.

- Please read the User Manual before installing and starting your machine.
- Particularly follow the instructions related to safety.
- Keep this User Manual within easy reach. You may need it in the future.
- Please read all additional documents supplied with this machine.

Please note that this User Manual may be applicable for several other models. Differences between models will be identified in the manual.



This product has been produced in environmentally friendly, modern facilities

FEATURES OF 2008 DVD PLAYER

- ◆ Full discs playback compatibility: DVD,DVD±R,DVD±RW, DVCD, MP3, CD-DA, HDCD , Picture CD.
- ◆ Excellent AV effect:
 - 1.Composite video, S-Video and component video output. Built-in progressive output enables a higher resolution of the pictures.
 - 2.Supports PAL or NTSC system with aspect ratio of 4:3 or 16:9. Fiber optical and coaxial audio outputs are also available.
- ◆ Totally supports multi view-angle, multi-language, multi-subtitle and multi screen mode for DVD discs.
- ◆ Supports parental lock control that prevents children to watch unsuitable scenes.
- ◆ Friendly-interfaced WINDOWS setup menu.
- ◆ Displays the JPEG picture files.
- ◆ MP3 three-dimensional (3D)dynamic playback interface.
- ◆ Possesses agile zoom function, and pictures can be zoomed during playback.
- ◆ NTSC/PAL/AUTO compatible, no compression of pictures.
- ◆ Dynamic screen saver function.
- ◆ Supports setup of video quality.
- ◆ Software update automatically.

Notes: "Dolby" and the double-D symbol are trademarks of Dolby Laboratories Licensing Corporation. Manufactured under license from Dolby laboratories.

Confidential unpublished works. © 1992-1997 Dolby Laboratories. Inc. All rights reserved.

PLEASE READ THIS MANUAL COMPLETELY BEFORE OPERATING THIS UNIT AND KEEP IT FOR FUTURE REFERENCE.

Safety Precautions



CAUTION: This symbol alerts the user that “dangerous voltage” exists in the player cabinet with the risk of electric shock to persons.



CARE: This symbol alerts the user that important operating and maintenance instructions exist in manual.

WARNING: To reduce the risk of fire or electric shock, do not expose this player to rain or moisture. Dangerous high voltages are present inside the cabinet. Do not open the cabinet, the player should be repaired by the qualified maintenance person only.

CAUTION: This DVD player employs a laser system.

To ensure proper use of this product, please read this user’s manual completely and keep it for future reference. Should the unit require maintenance, please contact an authorized service center.

To prevent direct exposure to laser beam, do not try to open the cabinet, or the laser beam may hurt your eyes.

WARNING: Without agreement of our company or any organization authorized by our company, any change or alteration to this product may bring inconvenience to you.

Position of the label

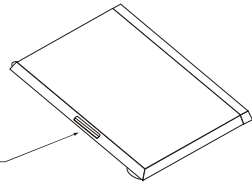

Important Safety Instructions

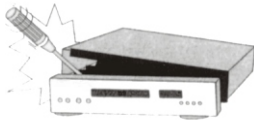

Do not take apart or modify this unit.

Do not place any metal or liquid on or near this unit to avoid the risk of fire or electric shock.

Do not place any metal or inflammable object into the cabinet.

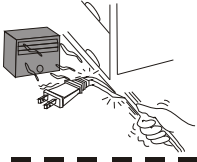

Do not use the broken power cord or the power plug.

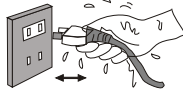

Do not plug or unplug the power when the hand is wet.

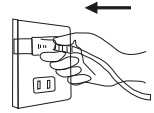

Plug in completely.



Clean the power plug periodically.

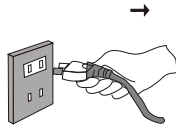

Turn off this unit and unplug it while lines wear out.

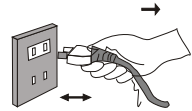

Should shut down this unit and unplug it if liquid has spilled, or objects have fallen into the cabinet.

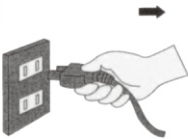

Should shut down this unit and unplug it if the player smoke or sound unusual.

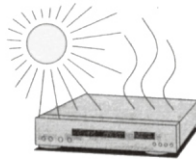

Do not expose this unit to direct sunlight or in abnormal hot place.

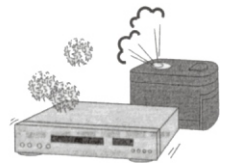

Do not situate this unit in the dusty or moist place.

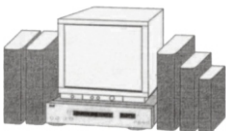

Do not situate this unit under any heavy object or in unventilated place.



Do not put this unit in a shaky slope or a vibrating place.

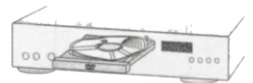

Do not use disc with scratches or deformation.

Accessories

Open the package of this DVD player,make sure the following accessories attached with the product:

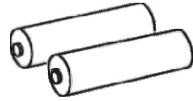
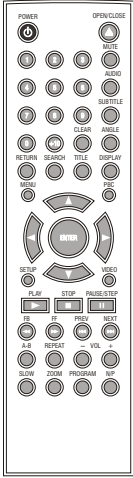

Remote Control

Battery x2



SCART Cord

I Introduction

◇ Features of 2008 DVD player	1
◇ Safety Precautions	2
◇ Important Safety Instructions	2-3
◇ Accessories	4

II Connections

◇ Front Panel/Rear Panel	6
DVD VFD	7
Remote Control	8
Preparations/Operation of the Remote Control	9
◇ Connecting to a TV	10-11
◇ Connecting to an Audio System	12-14
◇ The Amplifier System	12
Connecting to an Amplifier with Digital Input Port	13
Connecting to the Amplifier with 5.1 Channel Surround Input	14

III Playback

◇ Playback a Disc	15-18
Basic Playback	15
Playback Control	16-17
Set Hot Button	17
PBC Play	17
DVD Functions	17
Volume Control	18
MP3 Playback	18
JPEG Picture Display	18
Screen Saver Function	18
Playback DIVX VIDEO	18-19

IV Function Setup

◇ Function Setup	20-22
------------------------	-------

V Others

◇ Notes on Discs	23
◇ Notes on Service	24
◇ Specifications	25

Front Panel/Rear Panel

100100100100
00100 00100
0100100100

Front Panel

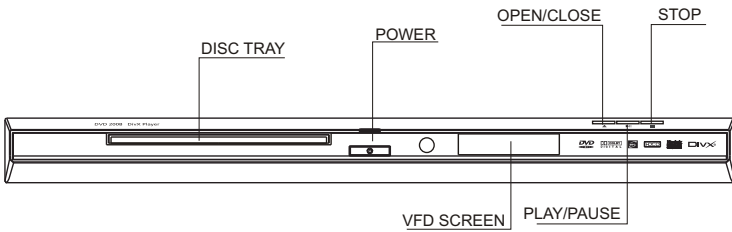

Rear Panel

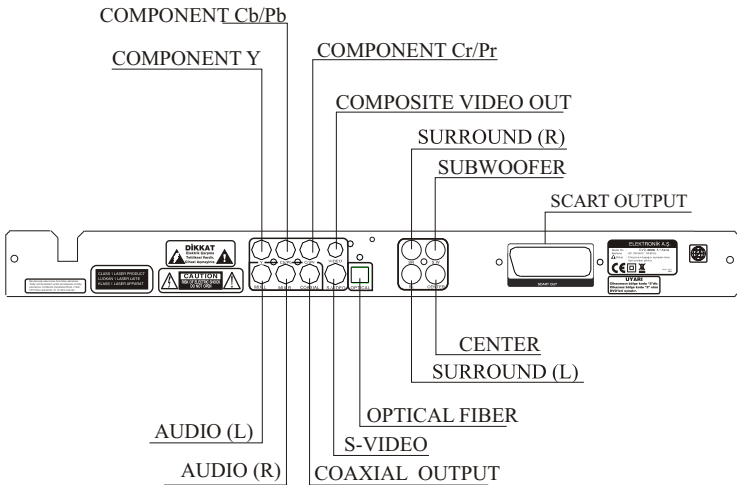

DVD VFD

11011001001100
00100100100
10100100100

DVD VFD

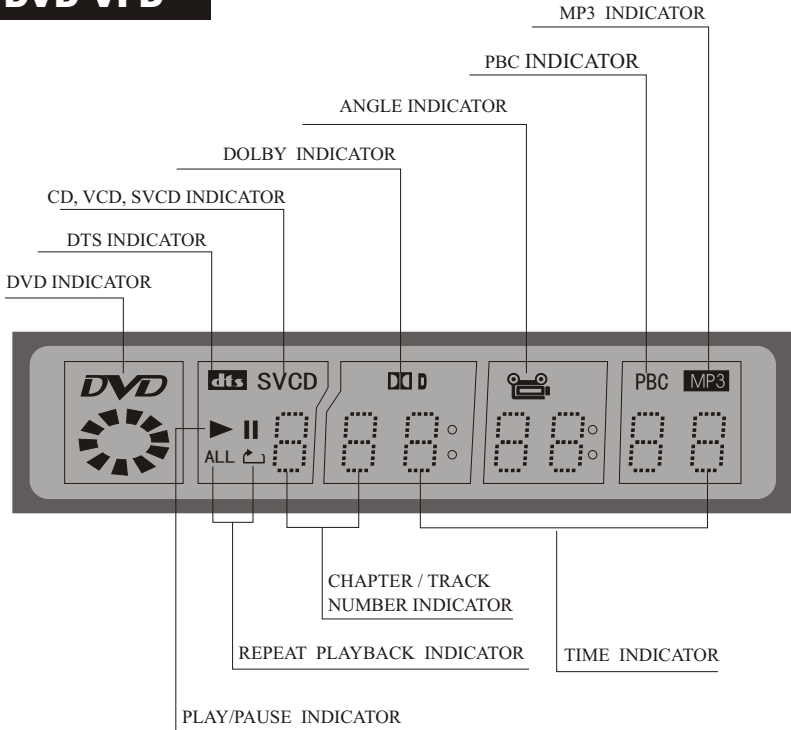

Notes:

- It is normal if some VFD indicators disappear in playing procedure without harm.

Remote Control

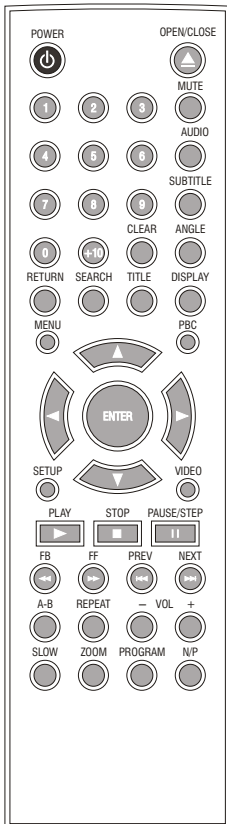

- 1.POWER: switch DVD player on or go to standby mode
- 2.PROGRAM: program playback
- 3.AUDIO:audio language selector
- 4.ANGLE: select DVD camera angle
- 5.SUBTITLE:subtitle language selector
- 6.PBC:open or close the PBC(VCD2.0)
- 7.ZOOM: enlarge video image
- 8.DIRECTION BUTTONS: select an item
- 9.ENTER: acknowledge selection
- 10.MUTE: mute sound
- 11.STOP: stop playback
- 12.PLAY: start playback
- 13.FB: fast reverse playback
- 14.FF: fast forward playback
- 15.REPEAT: repeat chapter, track, title or disc
- 16.A-B: repeat a specific segment
- 17.VOL: volume up +; volume down -
- 18.SLOW: slowly playback
- 19.PAUSE/STEP:pause and step playback
- 20.PREV: go to a previous chapter or track
- 21.NEXT: go to a next chapter or track
- 22.MENU: access menu of a disc
- 23.SEARCH: go to a specific scene
- 24.TITLE: title of a DVD disc
- 25.DISPLAY: to display information of a disc
- 26.SETUP: setup function
- 27.VIDEO: switch video output
- 28.CLEAR: clear input
- 29.0-9,+10,numerical key: select numbered items
- 30.N/P:switch the TV type
- 31.OPEN/CLOSE: open or close tray
- 32.RETURN

Preparations for the Remote Control

Insert the batteries into the remote control, and you can use it to operate DVD player.

1

Open the cover

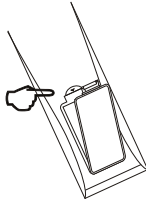

2

Insert batteries

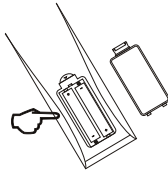

Make sure to match the + and - to the mark inside the battery compartment.

3

Close the cover.

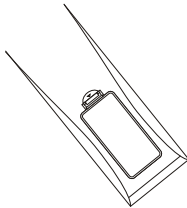

Notes on the Remote Control

- * Direct the remote control at the remote sensor of the DVD player.
- * Do not drop or give the remote control a shock.
- * Do not leave the remote control near an extremely hot or humid place.
- * Do not spill water or put anything wet on the remote control.
- * Do not open the remote control.

Operating with the Remote Control

This section shows you how to use the remote control.

Point the remote control at the remote sensor and press the buttons.

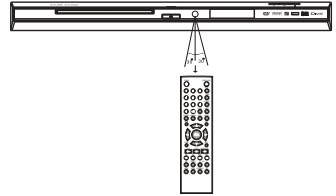

Distance: Within 6m from the front of the remote sensor

Angle: About 30° in each direction of the remote sensor.

- * Do not expose the remote sensor of the DVD player to a strong light source such as direct sunlight or illumination. If you do so, you may not be able to operate the DVD player with the remote control.

Notes on Batteries

Improper use of batteries may cause battery leakage and corrosion. To operate the remote control correctly, follow the instructions below.

- ★ Do not insert the batteries into the remote control in the wrong direction.
- ★ Do not leave the discarded or exhausted batteries in the remote control.
- ★ Do not use different types of batteries together, or mix old and new batteries.
- ★ If you do not use the remote control for a long period of time, remove the batteries to avoid possible damage from battery corrosion.
- ★ If the remote control does not function correctly or if the operating range becomes reduced, replace all batteries with new ones.
- ★ If battery leakage occurs, wipe the battery liquid from the battery compartment, then insert new batteries.
- ★ The battery can last for about 1 year when normally used.

Connecting to a TV

Connect the DVD player to a TV.

Connecting to an Interlaced Scanning TV

100100100100
00100100100
0100100100

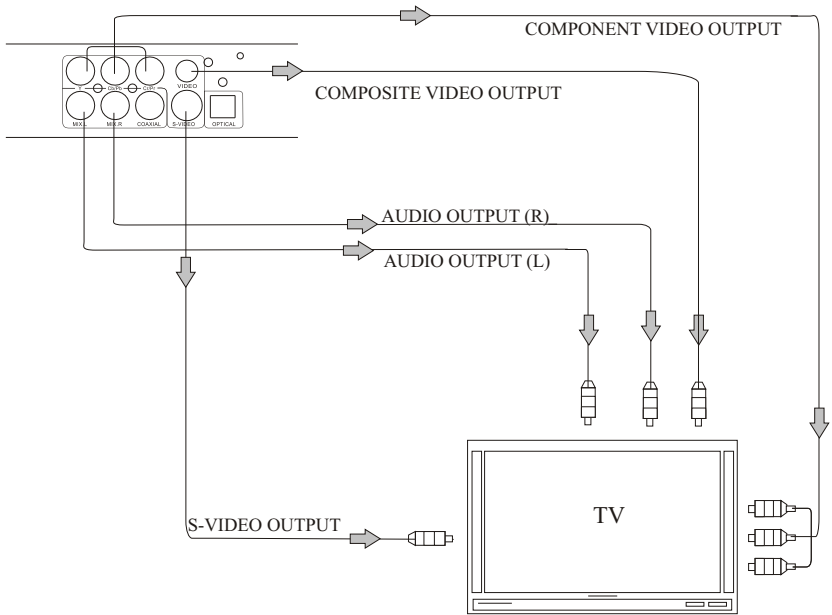

Notes:

- (1) If the TV has component video input (YcbCr/YPbPr) jacks, you can connect them to the YcbCr/YPbPr jacks of the DVD player to get a clearer picture, and use these jacks rather than the S-VIDEO OUTPUT jack.
- (2) DVD player setup: (Setup the DVD player according to the connected TV.)
 - * If the TV system is PAL, select PAL output.
 - * If the TV system is NTSC, select NTSC output.
 - * Connect the DVD player to the wide screen TV, set the "TV TYPE" as "16:9" in FUNCTION SETUP.
 - * If the DVD player is connected to an ordinary TV, set the "TV TYPE" to "4: 3 PS" or "4: 3 LB" in FUNCTION SETUP.

Connecting to a TV Connect the DVD player to a TV.

Connecting to a Progressive Scanning TV

0100100100
0100100100
00100100

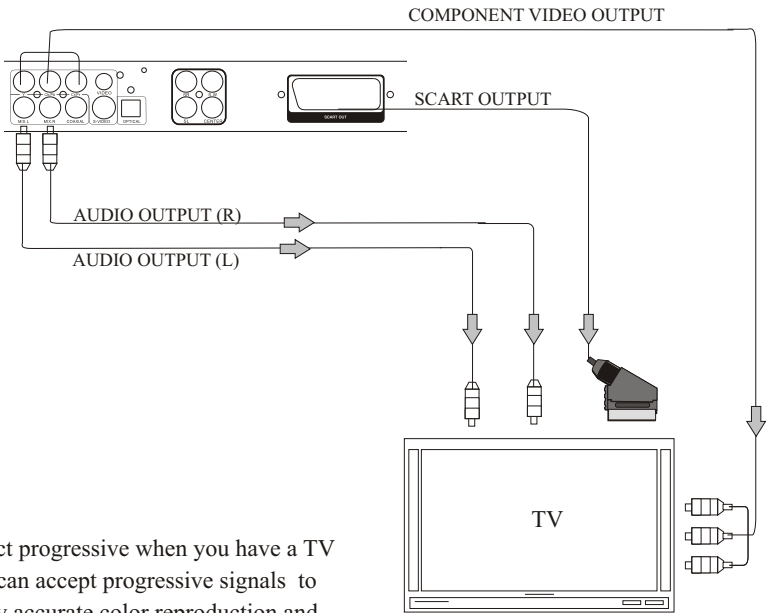

Notes:

1. Select progressive when you have a TV that can accept progressive signals to enjoy accurate color reproduction and high quality images.
2. If your TV has a component video (YPbPr) input connector, connect the YPbPr video out jacks on the DVD player to corresponding input on the TV.
3. If your TV has a SCART input connector, connect the SCART out jacks on the DVD player to the corresponding input on the TV.

Connecting to an Audio System

You can enjoy the sound of discs in stereo.

Connecting to the Amplifier System

0100100100
1100100100
00100100

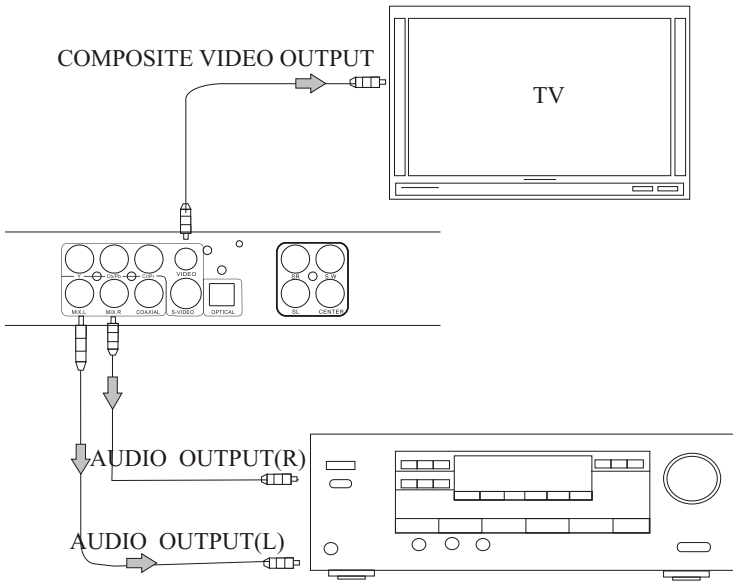

Notes:

Refer to the user's manual of the connected equipment as well.

When you connect the DVD player to other equipment, be sure to turn off the power and unplug all the equipment from the wall outlet before making any connections.

If you place the DVD player near a tuner or radio, the radio broadcast sound might be distorted. In this case, place the DVD player away from the tuner or radio.

The output sound of the DVD player has a wide dynamic range. Be sure to adjust the receiver's volume to a moderate listening level. Otherwise, a sudden high volume may damage the speakers.

Turn off the audio system before you connect or disconnect the DVD player's power cord. Otherwise, the speaker may be damaged.

Connecting to an Audio System

Connecting to the Amplifier with Digital Input Port

00100100100
0100100100
100100100

Dolby Digital

Dolby Digital is the surround sound technology used in theatres showing the latest movies, and is now available to reproduce this realistic effect at home. You can enjoy motion picture and live concert DVD video discs with this dynamic realistic sound by connecting the DVD player to a 5.1-channel amplifier with a Dolby Digital decoder or Dolby Surround decoder, you will obtain the full benefit from the DVD movies that provide full 5.1-channel Dolby Digital sound tracks, as well as from those with the Dolby Surround mark.

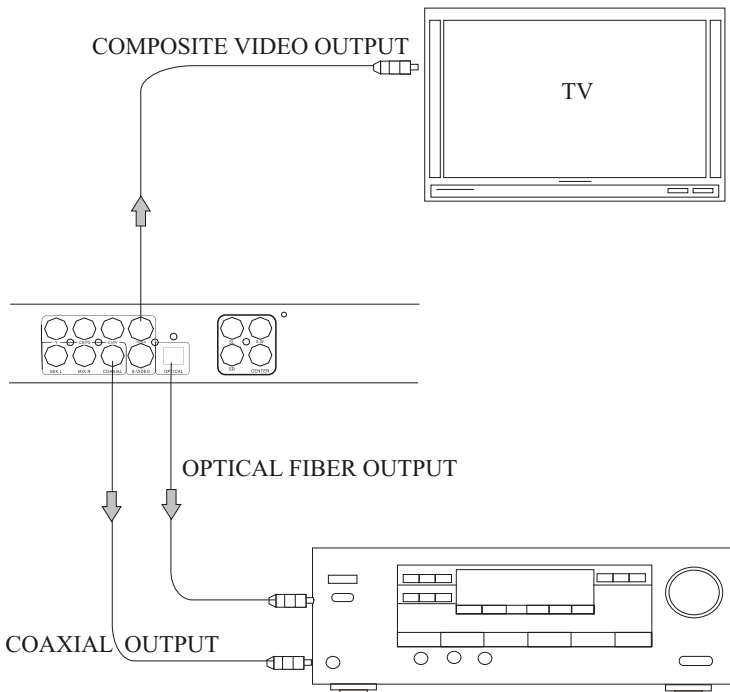

Connecting to the Amplifier with 5.1-channel Surround Input

00100100100
0100100100
100100100

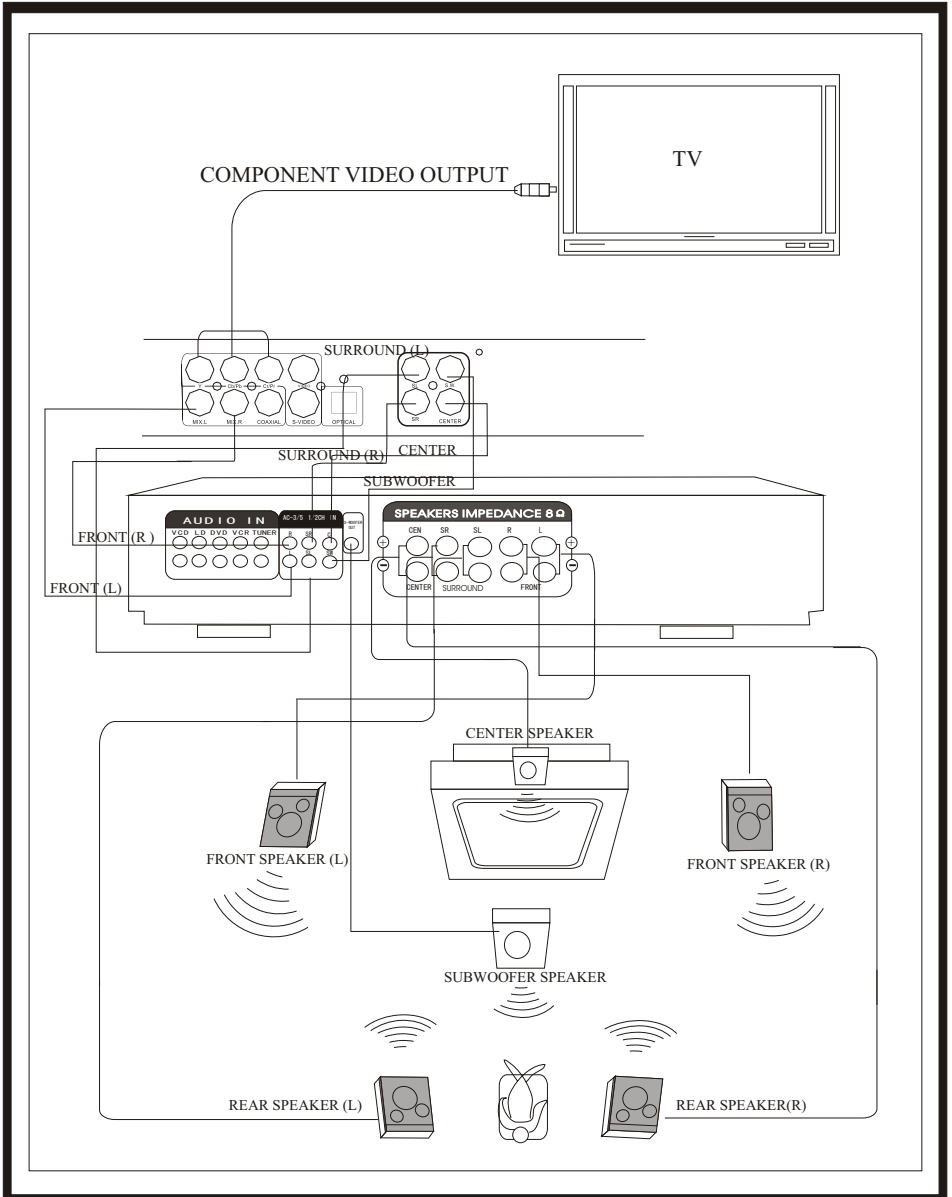

Basic Playback

00100100100
0100100100
100100100

Preparations

- If you want to play a DVD, VCD or CD-DA disc, turn on the TV and select the video input source which is connected to the DVD player.
- If you want to enjoy the sound of disc from the audio system, turn on the audio system and select the input source which is connected to the DVD player.
- For connection details, see 'Connections' .

<p>1. Turn on the DVD player Press the POWER button on the front panel, And then press the PLAY button to wakeup the DVD.</p>	<p>When the Player is not used for a long period, please pull off the power plug.</p>
<p>2. Open the tray Press the OPEN/CLOSE button to open the disc tray.</p>	
<p>3. Place the disc When the disc tray is open, place the disc on the disc tray, with the playback side down..</p>	<p>Notes: There are two different disc sizes. Place the disc in the correct guide on the disc tray. If the disc is out of the guide, it may damage the disc and cause the DVD player to malfunction. Do not place anything except the DVD, VCD, CD and MP3 discs on the disc tray.</p>
<p>4. Play Press the PLAY button, the disc tray closes and playback starts. When playing a DVD disc with the title menu recorded or VIDEO CD with the playback control (PBC), a menu screen will appear.</p>	<p>Notes: For the playback control (PBC) of the VCD2.0 and SVCD, please refer to PBC Playback. When not using the menu screen (with PBC) of the VCD2.0 or SVCD, you can press the PBC button to turn off the "PBC" .</p>

Notes

- Do not move the DVD player during playback. Doing so may damage the disc.
- Use the OPEN/CLOSE button on the remote control or DVD player to open or close the disc tray. Do not push or touch the disc tray while moving. Doing so may cause the DVD player to malfunction.
- Do not push up on the disc tray or put any objects other than discs on the disc tray. Doing so may cause the DVD player to malfunction.

● Enjoy pictures of higher quality

Sometimes when playing DVD discs, on the TV screen there is unusual interference that are not common in ordinary television broadcast. This is because the high-resolution pictures of DVD discs contain a wide range of information. The extent of the interference depends on the TV set connected with the DVD player, and it is recommended that you set the TV set to a low contrast ratio when watch a DVD disc.

Playback Control

0000000000
010000100
100100100

1.Direction Buttons

Press the direction buttons to move the cursor to the selected item, then press the ENTER button to confirm it.

2.Play

Press this button to play the disc.

3. Pause/Step

Press this button once to pause the playback. and press this button twice to step the playback

4.Clear

Press this button to clear the input digits (displays on the screen) when programming tracks or in searching operation.

5.Number Buttons

When playing a VCD disc, press the number buttons directly to play your favorite track in PBC off status. If the track number is from 1 to 9, you can directly press the number. If the track number is more than 9, you should use button 10+ and the other number buttons together to select the track, eg.: for track 25, first, press the +10 button twice, then press button 5.

6.STOP

When playing a DVD disc, press this button the first time during playback, the DVD player memorizes the location where you stopped (press PLAY to resume playback from the memorized point). Press this button again to stop the disc (then press PLAY to start playing from the beginning of the disc).

7.FF / FB

You may speed up a DVD , CD, VCD or Mp3 disc by pressing the FF / FB buttons on the Remote control . You can fast reverse at 2X,4X,8X and 20X.

8.SLOW

The DVD player allows for Slow Motion playback . Press this button to select :1/2-1/3-1/4-1/5-1/6-1/7

Press PLAY button to resume normal playback.

9.NEXT /P REV

Press skip to select the next (previous) chapter (for DVD) or track (for VCD/CD/MP3).

10.ZOOM

This feature allows you to enlarge the picture on screen 2X , 3X, 4X,1/2X,1/3X, and 1/4X the original size . Press the ZOOM button to cyclically scroll through the available strengths

11.A-B

You can replay a specific portion of a disc repeatedly using this function

Press the A-B button on the Remote control to select the starting point for the section to be repeated.

Press the A-B button on the Remote control again to select the ending point This section will now continue to repeat until; A-B is pressed for a third time to resume normal playback

12. REPEAT

This function can be used to repeatedly play a Title Chapter , Track or other part of a disc. DVD-Press REPEAT on the Remote Control to cyclically select CHAPTER REPEAT-TITLE REPEAT -REPEAT ALL-REPEAT OFF . CD/VCD - When PBC is off , Press REPEAT on the Remote Control to cyclically select REPEAT ONE-REPEAT ALL-REPEAT OFF.

13. PROGRAM

You can program the player to play a customised order of specific tracks , title or chapters . To program a DVD follow the instructions below.

- 1)Press the PROGRAM button to initiate the program function
- 2)Press LEFT or RIGHT to highlight either T for title or C for CHAPTER
- 3)Press the Numeric button of the desired title and chapter
- 4)Highlight PLAY on the screen using the direction button and press ENTER. Your programmed list will now be set
- 5)Press the PLAY button after programming to begin playback of the memorised play-list . The memory is erased if the disc tray is opened . The unit is powered OFF or the STOP button is pressed twice. For CD programming follow the above steps 1-5.For steps 2-3, enter the track number instead of the title and chapter numbers

Playback Control

00100100100
0100100100
100100100

14. SEARCH

Press this button to search the playback point by chapter number or title time (for DVD discs), disc time or track time or track number (for SVCD/VCD/CD discs)

15.N/P

Press this button to swith the TV type ,NTSC-PAL-AUTO

19. OPEN/CLOSE

Press this button to open or close the disc tray.

20. POWER

When this button is pressed, the DVD player will enter standby status. Press this button again to resume the player.

Note: When the Player is not used for a long period, please pull off the power plug.

21. VIDEO

The user can adjust the output mode of the pictures among INTERLACE-YUV , TV-RGB P-SCAN YPBPR or S-Video output.

This button is a hot button, it has the same function as the VIDEO SETUP item in the SETUP menu. As for details of connection with the TV set, please refer to the CONNECTIONS chapter.

22. AUDIO

This button allows the user to select a preferred audio language from those included on the disc.

Set Hot Button

00100100100
0100100100
100100100

16. DISPLAY

Press this key to display on TV the time information of current playback. For different discs, different choices are available.

17. MENU

For DVD discs, press this button to enter DVD menu (if supported by the discs).

18. PBC

For SVCD or VCD2.0 discs, press this button to open/close the PBC functions.

- a. In the PBC display of the SVCD or VCD2.0, if the PLAY button is pressed, the player will enter PBC playback status. If the PBC is turned off, the disc will be played as VCD1.0/1.1.
- b. When PBC is set to ON, menu of the disc appears on the screen, press the number buttons to select and play the track you want.
- c. Press this button to return to the interface of selecting tracks.

DVD Function

00100100100
0100100100
100100100

23. TITLE

For DVD discs, press this button to enter the title menu, then press the direction buttons and PLAY button to select and play. (If it is supported by the discs.)

24. ANGLE

Press this button to change the camera angle of the scene you are watching if the scene was recorded from multiple angles. (It needs support of the discs.)

25. SUBTITLE

For those DVD discs that have multiple languages of caption recorded, press this button to change the caption to different languages.

Volume Control

26. VOLUME

With an analog Audio connection . The volume can be adjusted using the VOL+ and VOL- buttons . The volume can be muted by pressing the MUTE button on the remote control.

27. MUTE

Press this button to set the play mute, press this button again to cancel the mute state.

Screen Saver Function

In the stop status and when no discs in the player, the player will enter screen saving status automatically 3 minutes later. Press the PLAY button or OPEN/CLOSE button to resume the player.

Mp3 Playback

When Mp3 disc is being played,the playback menu will appear on the screen,as shown in the following figure.

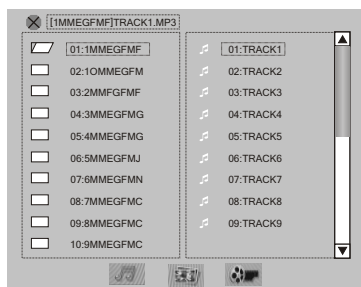

You can either into the directory that you want to play by using the directional button, and then the first song will be played. The directional button can also be used to choose any file you would like to play in the file area. When the cursor is in left film column, Press number key to select file. When in right one it can select document.

JPEG Picture Display

The playback menu of the JPG picture is similar to MP3 playback menu. Please refer to MP3 playback.

When playing the JPG pictures, press STOP button to enter the picture previewing mode. After entering this mode, operate with the direction buttons and play button. Press PLAY or ENTER button to return to the playback mode.

Playback Divx® VIDEO

DivX Video is an encoder/decoder, based on the MPEG-4 compression system, which is used to encrypt and display compressed video data. This enables the DVD player to play back videos compressed in the DivX® format. This results in playback quality with less artefacts and higher compression. DivX® video files have the suffix .AVI. DivX® Video data are packed into the AVI file along with audio data which is compressed as MP3 data, this means:

DivX® Video and MP3 audio form the AVI file.

Further information on DivX® Video and how to create AVI files can be found under [www.DivX Networks.de](http://www.DivXNetworks.de).

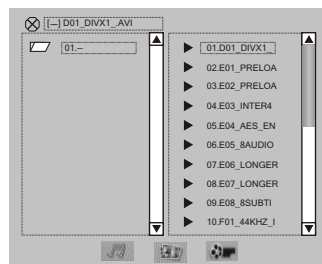

- 1 After the disc compartment shuts and the DivX® Video CD is scanned, the file browser (the table of contents) of the DivX® Video CD is displayed.
- 2 Select the folder or track required with >>▲<< or >>▼<<.
– A list of sub-directories appears.

Playback Divx® VIDEO

00100100100
0100100100
100100100

- 3 Open the folder with $\boxed{\text{F5}}$ OK<< or >>▶<<.

Note:

Press >>RETURN<< $\boxed{\text{F5}}$ go back one level.

- 4 Press >>▶<< $\boxed{\text{F5}}$ start playback of the track.
– The playing time appears in the display on the DVD player.

Notes:

Information about the DivX® Video track selected can be called up with >>ENTER<<.

The contents of the DivX® Video CD (file browser) can be called up with >>RETURN<<.

- 5 Press >>||<< $\boxed{\text{F5}}$ interrupt playback (pause).
- 6 Press >>▶<< $\boxed{\text{F5}}$ resume playback.
- 7 End playback by pressing >>■<< . $\boxed{\text{F5}}$

Selecting specific tracks using the number keys

- 1 During playback select the desired track with >>1...0<<
– Playback begins with the selected track. $\boxed{\text{F5}}$

Selecting a track in steps (SKIP)

- 1 Select the next track by pressing >>▶▶<< during playback.
- 2 Select the previous track by pressing >>◀◀<< .
– Playback begins with the selected track.

- 2 Move the freeze frame step by step forwards with >>||<< .
- 3 Press >>▶<< $\boxed{\text{F5}}$ resume normal playback.

Enlarging the picture—zoom (DivX® Video CD only) This function allows you to enlarge various picture sections.

- 1 During playback or pause, press >>ZOOM<< $\boxed{\text{F5}}$
– Display: for example >>ZOOM 2<< , the DVD player enlarges a picture section.
- 2 Move the picture section around the screen with >>▲<< or >>▼<<, >>◀<< or >>▶<<.
- 3 Switch back to " normal " picture size with >>ZOOM<< .

Removing a DivX® Video CD

- 1 Press >>▲<< $\boxed{\text{F5}}$ the DVD player
– Display: >>▲<< the disc tray opens.

Frame search(DivX® Video CD only)

00100100100
0100100100
100100100

You can select different speeds (2-fold, 4-fold, 8-fold and 20-fold forwards and backwards).

- 1 Select the desired playback speed during playback with >>▶▶<< or >>◀◀<< .
- 2 Press >>▶<< $\boxed{\text{F5}}$ resume normal playback.

Switching freeze frames forwards step-by-step (DivX® Video CD only)

- 1 During playback, press >>||<< .

Function Setup

00/100/00/100
0100/00100
100/00100

Press the SETUP button, the following graphic will display on the screen.

SYSTEM SETUP
TV SYSTEM
SCREEN SAVER
VIDEO
TV TYPE
PASSWORD
RATING
DEFAULT
EXIT SETUP

1. Press the SETUP menu to enter the setup menu.
2. Use the ↑/↓ button to choose the menu item you want to change, then press ENTER to confirm it.
3. Use the → button to move the high light icon to the right side item.
4. Use the up/down button to change the current setup, then press the ENTER button to confirm it.
5. Use the ← button to move the high light icon to the left side item.
6. Select the EXIT SETUP item or press the SETUP button to quit the setup menu.

SYSTEM SETUP

SYSTEM SETUP	
TV SYSTEM >>	NTSC
	PAL
	AUTO
SCREEN SAVER >>	ON
	OFF
VIDEO >>	INTERLACE - YUV
	P-SCAN YPBPR
	TV-RGB
	S-VIDEO
TV TYPE >>	4:3 PS
	4:3 LB
	16:9
PASSWORD >>	----- 🔒
RATING >>	NO ADULT
	KID SAFE
	VIEW ALL
DEFAULT >>	RESTORE
EXIT SETUP	

TV SYSTEM

the TV output mode can be : NTSC , PAL or AUTO . Set up the system of your DVD player to match the system of your TV .

SCREEN SAVER

When in ON mode , if you do not make any operation or are in stop mode for 3 minutes , the screen saver picture will appear.

VIDEO

Video setup has four options . If using INTERLACE-YUV output to TV , choose INTERLACE-YUV mode. If using P-SCAN YPBPR output to TV , choose P-SCANYPBPR mode

TV TYPE

- 16:9-To view broad mode picture with the broad screen TV set
- 4:3(LB)-To view the standard 4:3 picture or the cut standard 4:3 picture.
- 4:3(PS)- 4:3 subtitle block to view the full width of the broad mode

PASSWORD

The default mode is set at LOCK , you cannot change the RATING , and cannot change the password in this state. Factory setup(password 0000)
If you want to change the RATING grade or the password, please input the initial password 0000 to unlock , and press the ENTER button first . Thereafter input your new password and enter the ENTER button. If later on you want to make a new setting for the RATING. And you want to change the password , please input the new password as set above . If you input 0000,it will also work.

Important:

Please remember to write down the new password and keep it in a safe place(Ex.behind the remote control battery cover).

The parent lock function will only work on DVD discs with parental control marks

RATING

There are three grade ratings . The performance of this function will depend on the discs

DEFAULT

The default is to change your setup state to the factory default setup

LANGUAGE SETUP

LANGUAGE SETUP	
OSD LANGUAGE >>	ENGLISH
	GERMAN
	SPANISH
	FRENCH
	TURKISH
AUDIO LANG >>	CHINESE
	ENGLISH
	TURKISH
	FRENCH
	SPANISH
	PORTUGUESE
	LATIN
	GERMAN
SUBTITLE LANG >>	CHINESE
	ENGLISH
	TURKISH
	FRENCH
	SPANISH
	PORTUGUESE
	GERMAN
	OFF
MENU LANG >>	CHINESE
	ENGLISH
	TURKISH
	FRENCH
	SPANISH
	PORTUGUESE
	GERMAN
LATIN	
EXIT SETUP	

OSD LANGUAGE

OSD has five languages :English, German,Spanish,French, Turkish.

AUDIO LANG

To choose the audio language , the disc must be equipped with different languages . It is possible that the disc may have more audio languages than shown above . Use the AUDIO button on the remote control to change to the desired language

SUBTITLE LANG

To choose a subtitle language , the disc must be equipped with different subtitle languages . It is possible that the disc may have more subtitle languages than shown above . Use the SUBTITLE button on the remote control to change to the desired subtitle language

MENU LANG

The Menu can be in different languages :Chinese , English , Turkish ,French , Spanish , Portuguese , German Latin etc. To choose a menu language , the disc must be equipped with multi-language menus .

AUDIO SETUP

AUDIO SETUP	
AUDIO OUT >>	SPDIF/OFF
	SPDIF/RAW
EXIT SETUP	SPDIF/PCM

AUDIO OUT

Audio output includes three different types : for common AV output , please choose SPDIF/OFF , for coaxial or optical please choose SPDIF/RAW or SPDIF/PCM.

Function Setup

00/100/100/100
0100/00100
100/00100

VIDEO SETUP

VIDEO SETUP	
BRIGHTNESS>>	-- 12 -- 10 -- 8 -- 6 -- 4 -- 2 -- 0
CONTRAST>>	-- 12 -- 10 -- 8 -- 6 -- 4 -- 2 -- 0
HUE>>	-- +6 -- +4 -- +2 -- 0 -- -2 -- -4 -- -6
SATURATION>>	-- 12 -- 10 -- 8 -- 6 -- 4 -- 2 -- 0
EXIT SETUP	

BRIGHTNESS

Use Up/Down directional buttons to adjust the brightness

CONTRAST

Use Up/Down directional buttons to adjust the colour contrast

HUE

Use Up/Down directional buttons to adjust the hue setup

SATURATION

Use Up/Down directional buttons to adjust the colour saturation

SPEAKER SETUP

SPEAKER SETUP	
DOWNMIX>>	LT/RT
	STEREO
	VSS
	OFF
SUBWOOFER>>	OFF
	ON
BASS MODE>>	ALL LG SPK
	ALL SM SPK
	MIXED SPK
CENTER DELAY>>	-- 4MS
	-- 2MS
	-- 0MS
REAR DELAY>>	-- 4
	-- 12MS
	-- 6MS
EXIT SETUP	

DOWNMIX

LT/RT is recommended if the discs support PROLOGIC DOLBY STEREO , you can enjoy clear and superior sound effect as in the cinema. If the discs support 5.1 channel output , STEREO is recommended . If you choose VSS mode , you will enjoy virtual surround effect

SUBWOOFER

The subwoofer could open or close ,choose this option to open or close

BASS MODE

There are three BASS mode you could choose ALL LG SPK , ALL SM SPK, MIXED SPK

CENTER DELAY

Use Up/Down directional buttons to adjust the center delay

REAR DELAY

Use Up/Down directional buttons to adjust the rear delay

DIGITAL SETUP

DIGITAL SETUP	
DYNAMIC RANGE>>	-- FULL
	-- 6/8
	-- 4/8
	-- 2/8
	-- OFF
EXIT SETUP	

DYNAMIC RANGE

Use the directional buttons choose and adjust this setting

On Handling Discs

- Do not touch the playback side of the disc.



- Do not attach paper or tape to discs.



On Cleaning discs



- Fingerprints and dust on the disc may cause picture and sound deterioration. Wipe the disc from the center outwards with a soft cloth. Always keep the disc clean.
- If you cannot wipe off the dust with a soft cloth, wipe the disc lightly with a slightly moistened soft cloth and finish with a dry cloth. Do not use any type of solvent such as thinner, benzene, commercially available cleaners or antistatic spray for vinyl LPs. They may damage the disc.

On Storing Discs

- Do not store discs in a place subject to direct sunlight or near heat sources.
 - Do not store discs in places subject to moisture and dust such as a bathroom or near a humidifier.
- Store discs vertically in a case. Stacking discs or placing objects on the case may warp the discs.

About this User's Manual

- This user's manual explains the basic instruction of this DVD player. Some DVD video discs are produced in a manner that allows specific or limited operation during playback. As such, the DVD player may not respond to all operating commands. Refer to instruction notes of discs.

On Discs

	Disc mark	Contents	Disc size	Maximum playback time
DVD video discs		Audio+video (motion picture)	12cm	Approx. 2 hours (single sided single layer disc)
				Approx. 4 hours (single sided double layer disc)
				Approx. 4 hours (double sided single layer disc)
				Approx. 8 hours (double sided double layer disc)
VCD		Audio+video (motion picture)	12cm	Approx. .74 minutes
Audio CD-DA		Audio	12cm	Approx. .74 minutes
MP3		Audio	12cm	

This DVD player adopts NTSC/PAL color system, so it can not respond to discs that are produced in other color systems (such as SECAM).

Notes on Copyright

It is forbidden by law to copy, broadcast, show on cable, play in public, and rent copyrighted material without permission. DVD video discs are copy protected, and any recordings made from these discs will be distorted.

Type of TV System

Please connect this DVD player to a TV compatible with PAL/NTSC system .

Notes on Service

Check the following guide for the possible cause of a problem before contacting service.

Symptom	Cause	Measure
No power	The power plug is disconnected	Connect the power plug into the wall outlet securely
No picture	The TV is not set to receive DVD signal output	Select the appropriate video input mode on the TV so the picture from the DVD player appears on the TV screen.
	The video cable is not connected securely	Connect the video cable into the jacks securely.
No sound	The audio cable is not connected securely	Connect the audio cable into the jacks securely
	The power of the equipment connected with the audio cable is turned off.	Turn on the equipment connected with the audio
	The setting of output sound type is not correct.	Set the audio setting correctly
The playback picture has occasional distortion	The disc is dirty	Eject the discs and clean it
	It is in fast forward or fast reverse playback	Sometimes a small amount of picture distortion may appear. This is not malfunction.
Brightness is unstable or noises are produced on playback pictures	The copy protection effect.	Connect the DVD player to the TV directly
The DVD player does not start playback	No disc is inserted	Insert a disc
	An unplayback disc is inserted	Insert a disc(Check the disc type and color system.)
	The disc is placed upside down.	Place the disc on the disc tray correctly inside the guide
	The disc is not placed within the guide.	Place the disc on the disc tray correctly inside the guide.
	The disc is dirty	Clean the disc
	A menu is on the TV screen.	Press the SETUP button to turn off the menu screen
	The parental lock function is set.	Cancel the parental lock function or change the parental lock level.
Buttons do not work.	Power supply fluctuations or other abnormalities such as static electricity may interrupt correct operations.	Turn the power on or off with the POWER button. Or disconnect the power plug and insert it into the wall outlet again.
The remote control does not work properly.	The remote control is not pointed at the remote sensor of the DVD player.	Point the remote control at the remote sensor of the DVD player.
	The remote control is too far from the DVD player.	Operate the remote control within about 7m
	The batteries in the remote control are exhausted.	Replace the batteries with new ones.

Specifications

DVD Player/Outputs/Supplied Accessories

DVD Player

Power Supply	~110V~240V AC,50/60HZ
Power Consumption	≤15W (Normal Playback State)
Mass	2.5Kg±0.25
Size	430x255x38mm(W/H/D)
Signal system	PAL/NTSC
Laser	Semiconductor Laser (wavelength 650nm,780nm)
Frequency Response	±3db(20HZ-20KHZ)
Signal-to-noise ratio	≥90db
Audio dynamic range	≥80db
Operating conditions	Temperature:-5°C ~40°C, Operation status: Horizontal

Outputs

Composite Video Output	1. 0 ± 0.2 V _{p-p} , 75 Ω
Audio Output (analog audio)	2. $0^{+0.2}_{-1.0}$

Supplied Accessories

Scart Cord	-----1
Remote Control	-----1
Batteries	-----2
User's Manual/Maintenance Card	-----1

Free Manuals Download Website

<http://myh66.com>

<http://usermanuals.us>

<http://www.somanuals.com>

<http://www.4manuals.cc>

<http://www.manual-lib.com>

<http://www.404manual.com>

<http://www.luxmanual.com>

<http://aubethermostatmanual.com>

Golf course search by state

<http://golfingnear.com>

Email search by domain

<http://emailbydomain.com>

Auto manuals search

<http://auto.somanuals.com>

TV manuals search

<http://tv.somanuals.com>