

BEKO

INTEGRATED DIGITAL HD READY COLOUR TELEVISIONS

26WLZ530HID

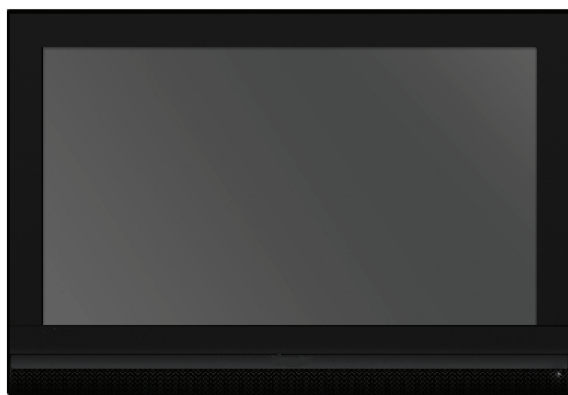

HD
ready



digital 

Operating Instructions

TABLE OF CONTENTS

1-Important Information.....	1
1.1-Cleaning the screen and cabinet.....	1
1.2-Disposing of your TV at the end of service life.....	1
1.3-Superior features of your integrated digital television.....	1
1.4-Receiving digital broadcasting channels.....	1
1.5-Changing the plug.....	2
2-Features of your new television	3
2.1-Special Features.....	3
3-Important Safety Instructions	4
4-Start	7
4.1-Aerial connection.....	7
4.2-Powering on your TV and the initial use.....	7
4.3-Performing initial start and settings	7
4.4-Batteries.....	7
5-Your new television.....	8
5.1-TV Control Panel	8
5.2-Rear and Side External Connections.....	8
5.3-Remote Control.....	9
6-Performing the initial power-on settings	10
6.1-TV controls.....	10
6.2-Turning on your television for the first time and tuning.....	11
6.3-Performing Digital channel settings.....	11
6.4-Performing Analogue channel settings.....	12
6.5-Electronic TV Guide (EPG)	13
6.6-Program table.....	14
6.7-Signal Information.....	16
6.8-CA Module (Conditional Access).....	16
6.9-Active Antenna Power	16
7-The settings on your new television.....	17
7.1-Performing the Sound settings.....	17
7.2-Performing the Picture settings.....	18
7.3-Performing the timer settings.....	20
7.4-Options menu settings.....	21
7.5-Parental Control.....	22
7.6-Other picture features.....	23
8-Teletext	24
9-External Equipment Connections	26
9.1-Headphone Connection.....	26
9.2-Connecting an external device via Scart connection	26
9.3-Connecting external equipment via AV connection.....	27
9.4-Connecting an external device via S-Video connection	27
9.5-Connecting an external device via YPBPR connection.....	27
9.6-Connecting an external device via HDMI connection.....	28
9.7-PC connection.....	28
9.8- Inserting the CI (Common Interface) card.....	29
10-Help and tips.....	30
11-Technical Specifications Chart.....	31
12-Main UK Transmitter Stations.....	32
13-Guarantee and Service	33-34

1 Important Information

LCD panels are produced with state-of-the-art technology. However, there may be missing or lit spots on the screen under certain circumstances. That does not mean that the product is faulty.

1.1-Cleaning the screen and cabinet...

After powering off, wipe the screen and the cabinet clean with a soft and dry cloth. We recommend that you do not use patented polishes or solvents on the screen or cabinet since they may cause damage.

1.2-Disposing of your TV at the end of service life...

The cold cathode fluorescent lamp found in your LCD screen contains a very small amount of mercury. Once your TV reaches the end of its useful life, please dispose of it in accordance with local government regulations or leave it at a recycling centre.

1.3-Superior features of your integrated digital television

This television can receive and process all analogue and digital broadcasts. This television set has an integrated digital and analogue receiver. The digital receiver unit processes the signals coming from digital transmitters and converts them into superior sound and image quality. TV Guide (valid for digital broadcasts only) informs you about changes in the program list briefly and provides program lists of all digital broadcasts for a number of forthcoming days. You can display detailed information about each program by pressing a single button if this feature is supported by the broadcaster. This television has a comprehensive and user friendly menu configuration.

1.4-Receiving digital broadcasting channels

You will need an outdoor aerial to receive digital broadcasts. Contrary to the analogue broadcasts, all digital broadcasts may not have their own transmission frequency. Instead, various digital broadcasts channels are gathered in regional or national groups called bouquets. You can find current transmission data from teletexts of various broadcasters or from TV guide or from the internet.

NOTE:

- HD signals must be connected to the HDMI input or component (YPbPr) inputs. See page 8 for external connections.
- You should check your postcode to make sure that you are in freeview coverage area (www.freeview.co.uk).

1.5-Changing the plug

The supplied mains cable already has a mains plug fitted, however should you need to replace it at any time please refer to the appropriate wiring information below for your particular cable.

IMPORTANT

The wires in the mains lead are coloured in accordance with the following code:
Blue - Neutral
Brown - Live

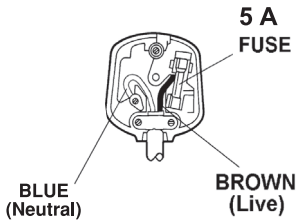

As the colours in the mains lead of this appliance may not correspond with the coloured markings identifying the terminals in your plug, proceed as follows:

The wire which is coloured blue or black must be connected to the terminal which is marked with the letter N or coloured black.

The wire which is coloured brown or red must be connected to the terminal which is marked with the letter L or coloured Red.

No connection is to be made to the Earth terminal of the plug.

If a 13 Amp (BS1363) Plug is used, fit an ASTA approved 5 A fuse

If your product is fitted with a moulded plug which requires replacement please cut off and dispose of it safely, then rewire as shown.

IMPORTANT

The wires in the mains lead are coloured in accordance with the following code:
Blue - Neutral
Brown - Live
Yellow/Green - Earth

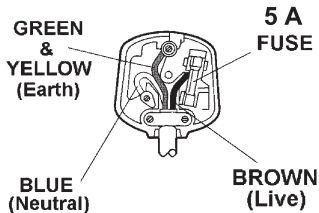

As the colours in the mains lead of this appliance may not correspond with the coloured markings identifying the terminals in your plug, proceed as follows:

The wire which is coloured green and yellow must be connected to the terminal which is marked with the letter E, or by the earth symbol, or coloured green or green and yellow.

The wire which is coloured blue or black must be connected to the terminal which is marked with the letter N or coloured Black.

The wire which is coloured brown or red must be connected to the terminal which is marked with the letter L or coloured Red.

If a 13 Amp (BS1363) Plug is used fit an ASTA approved 5 Amp fuse.

If your product is fitted with a moulded plug which requires replacement please cut off and dispose of it safely, then rewire as shown.

2 Features of your new television

We would like this product, which has been manufactured in modern facilities in accordance with total quality principles, to offer you the best performance. Therefore, we would like you to read this entire manual carefully before you use your product and keep it for future reference.

2.1-Special Features

- HD-Ready feature.
- HDCP feature.
- 2-HDMI connection input.
- High image and sound performance.
- CI slot input.
- 8-day EPG (Electronic Program Guide)
- Favourite channel list in digital mode (maximum 4 lists)
- Performing Digital and Analogue processes by a single menu.
- Updating feature for all system software through on-air broadcasting.
- Dynamic bass
- Wide angle of vision.
- Scart / S-Video / Phono connection inputs.
- PC connection.
- Low energy consumption.
- AVL (Automatic Volume Limiting) feature.
- Programmable power on/off feature.
- 1000-page Teletext.
- Graphic equalizer.
- Clearer pictures with the Digital Comb Filter.
- Sharpness feature in Colour Transitions (CTI)
- Sharpness feature and picture resolution (LTI) in black-white transitions
- Fine Tuning.
- Memory capacity up to 100 analogue channels.
- Memory capacity up to 400 digital channels.
- Infrared remote control equipped with all functions.
- Child Lock
- Panel Lock
- Pausing and Zooming the picture
- Ability to watch NTSC broadcasts via Scart input.
- 4:3, 16:9, 14:9 Letterbox, Subtitle and Panorama picture formats.

HDMI[™] HDMI, the HDMI logo and High-Definition Multimedia Interface are trademarks or registered trademarks of HDMI Licensing LLC.

Manufactured under license from Dolby Laboratories.

3 Important Safety Instructions



This symbol is used to warn the user about the “dangerous voltage” contained inside the housing of the product that may create a risk of electrical shock.



This symbol is used to remind the user important usage and service instructions supplied with the TV.

- 1) Please **READ** the operating instructions before using your TV for the first time.
- 2) Please observe the instructions contained in the Operating Instructions.
- 3) Please consider all warnings.



- 4) **MAKE SURE** that all power connections (extension cables and the connections between the TV components) have been made properly and in accordance with the manufacturer’s instructions. Before making or changing the connections, power off the TV and unplug the mains connection plug.

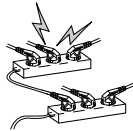

- 5) If you have any doubts regarding the installation, operation or safety of the device, please **REFER** to the retailer.
- 6) **BE CAREFUL** with glass panels and covers on the TV. The screen glass may break and cause serious injuries if something hits it.

- 7) To ensure adequate ventilation, please leave a clearance area of at least 10 cm around the television. This clearance prevents the TV from overheating and consequently causing damage.
 - Using the TV in dusty environments should also be avoided.
 - Never block the slots and openings by placing the TV on a bed, sofa, pillow or other similar surfaces.

- Never install the TV into closed places such as bookcases or cabinets unless adequate ventilation is provided.

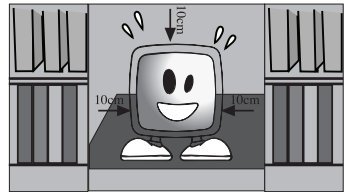

- 8) **DO NOT COVER** the ventilation openings of the TV with items such as newspapers, tablecloth, curtain, etc. Overheating causes damage and shortens the service life of the TV.



- 9) Your TV may be damaged if you place it under direct sunshine or close to a heater. Please abstain from using the product in very hot or humid locations or in places where the temperature is likely to decrease below 5°C (41°F). **DO NOT PLACE** on or near the TV any hot objects or items with open flame such as candles or any night lamps. The high temperature can melt plastic parts and cause a fire.

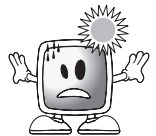

- 10) Never operate your TV close to water. Operating your TV, for example, near a bathtub, washbasin, kitchen washbasin, washing basin, wet basement and swimming pool can cause fire or electric shock.

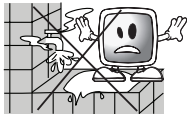

- Do not allow your TV to get wet. Never pour any liquids onto the TV. Do not operate your TV if any solid or liquid substance enters into it. This can cause electric shock and your TV may be damaged. Have it checked immediately by qualified personnel.



- Keep flammable materials and open flame sources (such as candles) away from TV in order to avoid risk of fire.

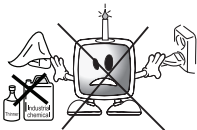

11) DO NOT USE

headphones at extremely high volume levels since this may cause permanent loss of hearing.



- 12) Operate your TV only in the 230 V 50Hz voltage range. Use the AC power cable supplied with the product. If your TV is a grounded (Class I) product, then it must be connected to a grounded socket.

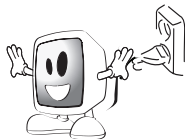

- The socket into which you plug in the AC power cable must be within easy reach.**
- Unplug the TV in order to disconnect it from mains power.**

Note: Do not use defective sockets. Make sure that the plug is firmly inserted into the socket. If the plug remains loose, then it can cause fire due to arcing. Refer to an electrician to have your socket replaced.

- 13) Make sure that the power cable is not stepped on and that there is no bending at the plug sections, plug heads and device output point.



- 14) Use only the add-ons/accessories specified by the manufacturer.

- 15) Use only stands specified by the manufacturer or sold along with the product. Place your device on a level surface.



- 16) Unplug the power cable during thunderstorms or when you will not use your TV for a long period of time.



- 17) Consult authorised service personnel for service requirements. Never attempt to repair the TV yourself. Opening the cabinet can expose you to dangerous voltages or other hazardous situations. Service is required in situations such as damage to the power cable of the device or its plug, water spills or substances falling into the TV, the TV is subjected to rain or moisture, it does not operate normally or it is dropped.



18) Wipe the TV cabinet clean with a soft and dry cloth. Wipe dust from the screen gently with a soft cloth. Stubborn stains can be cleaned with a cloth slightly moistened with soap and lukewarm water. Never use solvents such as thinner or gasoline for cleaning. Unplug the AC power cable from the socket when cleaning the TV. Otherwise, there is the risk of electric shock.

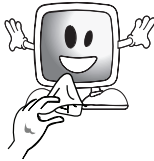

19) Do not dispose of the batteries in fire.

- **Do not short circuit, dismantle or overheat the batteries. There is the risk of explosion if the batteries are not replaced correctly. Replace only with the same or equivalent type batteries.**

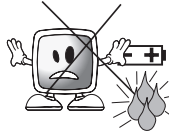

20) Disposing of the exhausted batteries:

- Dispose of the exhausted batteries in accordance with the local laws and regulations in order to protect our environment.



21) Do not dispose of your TV with regular household waste. Observe local laws and regulations for disposal.



22) For stand fitting and removal please refer to loose leaf sheet inside TV carton.

Note 1: This is a Class A product. During operation, the device can cause radio interference. In this case the user may have to remedy this. Please contact your specialist dealer.

Note 2: Electromagnetic fields can cause temporary performance degradation. This can be distinguished as noise in the image.

4 Start

Remove your television carefully from its box. You can keep the packaging of your television to use in future.

Contents of the box

Power cable
Remote control
2 batteries

Note: Scart, HDMI, VGA and PHONO cables are not supplied with the device.

4.1-Aerial connection

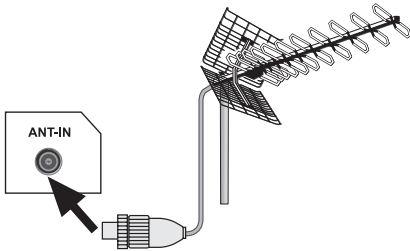

4.2-Powering on your device and the initial use

1. Insert the power cable into the power supply input located on the back panel of the LCD TV.
2. Insert the power cable plug supplied with the tv into the mains socket.

Note: Your TV is equipped to operate with TV buttons in case your R/C is broken or the batteries are exhausted.

3. Press the Standby on/off button located on the LCD TV , or
4. Press **PR+** or **PR-** keys on the remote control. For this process, you can also use the buttons on your TV. The picture will appear on the screen after a short while.

Note: If you are not going to use



your television for a long time, unplug its power cable from the socket.

4.3-Performing initial start and settings

To set up your television, read the sections on the TV controls and making the channel settings.

4.4-Batteries

Open the lid of the battery compartment and make sure that you have placed the batteries in the correct direction. For this remote control, UM-4, IEC R03 or AAA 1.5 V batteries are suitable.

Do not throw your old batteries into the fire, discard them in a dedicated waste area for this purpose.

Do not mix used batteries with new ones or different types of batteries together.

The performance of the remote control will be reduced at a distance of 8 meters from or at an angle of 30 degrees beyond the centre of the TV.

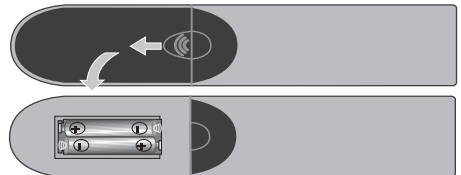

5 Your new television

5.1-TV Control Panel

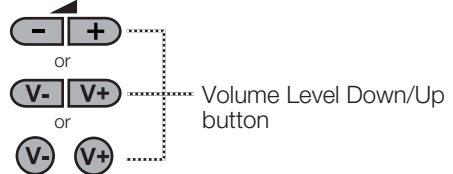

Menu button/Source selection button

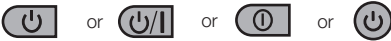

Power/Standby button

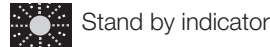

Bright light: TV is in Stand-by
Dimmed light: TV is On
No light: Power Cable is not connected.

5.2-Rear and Side External Connections

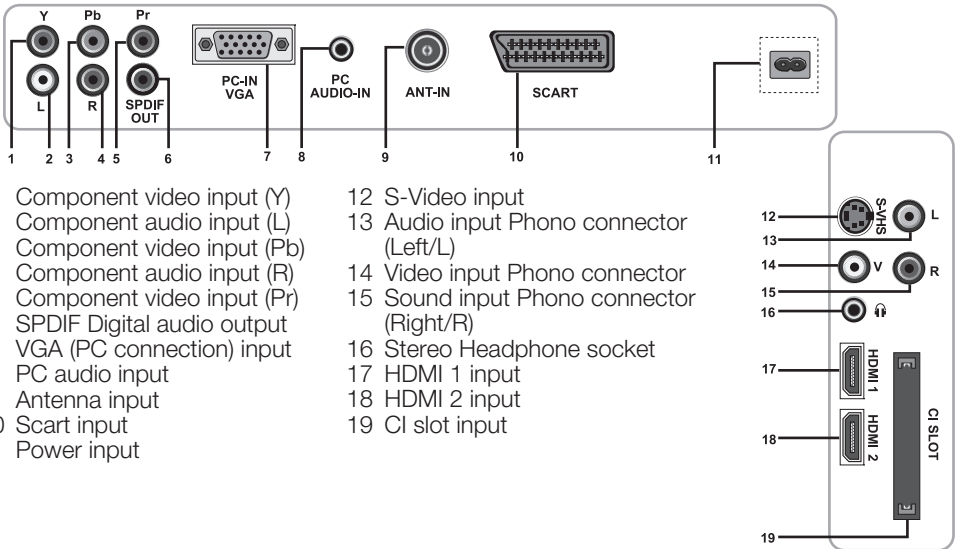

- | | |
|------------------------------|--|
| 1 Component video input (Y) | 12 S-Video input |
| 2 Component audio input (L) | 13 Audio input Phono connector (Left/L) |
| 3 Component video input (Pb) | 14 Video input Phono connector (Right/R) |
| 4 Component audio input (R) | 15 Sound input Phono connector (Right/R) |
| 5 Component video input (Pr) | 16 Stereo Headphone socket |
| 6 SPDIF Digital audio output | 17 HDMI 1 input |
| 7 VGA (PC connection) input | 18 HDMI 2 input |
| 8 PC audio input | 19 CI slot input |
| 9 Antenna input | |
| 10 Scart input | |
| 11 Power input | |

- Above drawing for external connections is representational. Their order and places on your TV may be different.
- Please see Technical Specifications Table on page 31 for the available external connections on your television.
- Please do not use the video Phono and S-Video connection simultaneously, otherwise these two devices might influence the picture quality of one another.

5.3-Remote Control



Standby	Temporary off button
AV	Source Menu button
	Temporary sound mute button
16:9	Picture format selection button
Zoom	Picture and Teletext (PAT) button
SUBT	Zoom mode selection button
	Subtitle selection button (D)
	Teletext sub page button (Sub)
AUDIO	Audio language selection button (D)
FAV	Favorites channel list selection button (D)
	Teletext page stop button (Stop)
EPG	EPG menu button (D)
	Teletext Question/Answer button (Reveal)
INFO	Information display button
	Teletext mode index page button
MENU	Enter menu button
1...0	Numeric buttons
BACK	Return to previous menu button
EXIT	Menu exit button
	Up/Down movement buttons
	Right/Left movement buttons
OK	Confirmation button
	Channel List button outside the menu
Vol-/Vol+	Volume down/up buttons
PR+ / PR-	Program forward/backward buttons
	Red Teletext button
	Green Teletext button
	Yellow Teletext button
	Blue Teletext button
TXT	TV/Teletext/MIX selection button
	Sound mode selection button
	Teletext page enlarge button (Double)
	Picture mode selection button
	Teletext Update button
SWAP	Switching back to the last viewed channel button
FREEZE	Picture pause button
SIZE	Time display button
PIP/POS	These buttons have no function

(D): Digital Mode Only.

Note: When there is no menu open on the screen, up/down movement buttons have the same function with the PR+/PR- buttons and left/right movement buttons have the same function with the Vol+/Vol- buttons.

6 Performing the initial power-on settings

6.1-TV controls

6.1.1-Temporary on/off (STAND-BY)

 When you press the red **STANDBY** button located on your remote control while your television is switched on, the sound and the picture will go off. In the stand-by mode, the power indicator of your television will glow brighter. To switch your television back on, either press any numeric button or **P+/P-** buttons.

Caution! If you are not going to use your television for a long time, unplug its power cable from the socket.

6.1.2-Digital TV, Analogue TV and AV Mode selection

Press the **Source** button on your remote control. **SOURCE** menu will be displayed. Select **DTV**(Digital TV), **ATV** (Analogue TV) or desired **AV** mode from the Source menu with **up/down** movement buttons and confirm with **OK** button so that your television will switch to the source you have selected.

6.1.3-Channel Selection

You may select program number you would like by pressing the **P+/P-** buttons on your television and on your remote control. To select the programs that are above 9, you can use the Numerical buttons. You may enter the number of the program you would like to select using the numerical buttons. For example, to switch to the program number 12, press the numeric buttons 1 and 2 on your remote control. You can perform the program selection also from the Program Table and Channel List menus.

6.1.4-Temporary sound mute (MUTE)

 To temporarily mute the sound of your television, press the **MUTE** button on your remote control. The **MUTE** symbol will appear on the screen. When you press the same button a second time, the sound will be restored. If you press the **VOL+** button while in the Mute mode, the sound level is increased and the Mute function is aborted.

6.1.5-Returning to the Last Viewed Program (SWAP)

 Allows you to switch between the current program you are watching and the source, or the last selected program and the source. For example, if you change the channel to Program 11 while you were watching Program 1, press **SWAP** button to switch back to Program 1. Press **SWAP** button to switch back to Program 11 again.

PR01 → PR11 →  PR01 →  PR11

HDMI1 → SCART1 →  HDMI1 →  SCART

6.1.6-Main Menu

Press the **MENU** button. The Menu including all the setting menus will appear on the screen. Navigate through the Menu titles with the **Right/Left** movement buttons and press the **OK** button to select the desired menu. If you want to exit the menu in any step, just press the **EXIT** button. Press **BACK** or **MENU** buttons to return to the previous Menu while you are in a sub menu.

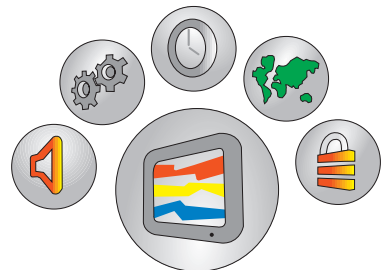

6.2-Turning on your television for the first time and tuning

Installation Guide menu will be displayed on the screen when you turn on your television for the first time.

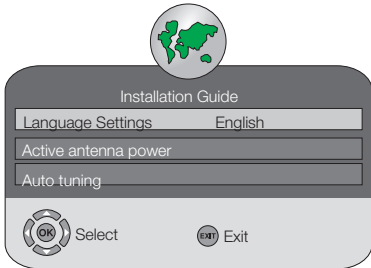

Press **Right/Left** movement buttons to select the desired menu language from the **Language** tab. If you are using an active antenna, (See page 16) set the active antenna power feature to **On. Select Auto Search** by pressing the down movement button and confirm your selection with **OK** button or the **right** movement button. Country Selection menu will be displayed. Make the Country and Scan Type selections by pressing the **Up/Down, Left/Right** movement buttons. Time Zone will be set automatically according to the country selected. If the antenna connections are correct, press **OK** button to start Auto Search.

Press **EXIT** button to cancel the Auto Tuning.

6.3-Performing Digital channel settings

You can tune the Digital programs automatically or manually and store them in your television.

6.3.1-Automatic tuning of digital channels and storing in the memory



Press the **MENU** button on your remote control. Select **CHANNEL SETUP** by pressing the **Right/Left** movement button and confirm your selection with **OK** button. Select **Auto Tuning** tab by pressing the **Up/Down** movement buttons and press **Right** movement button or **OK** button to confirm. Country Selection menu will be displayed.

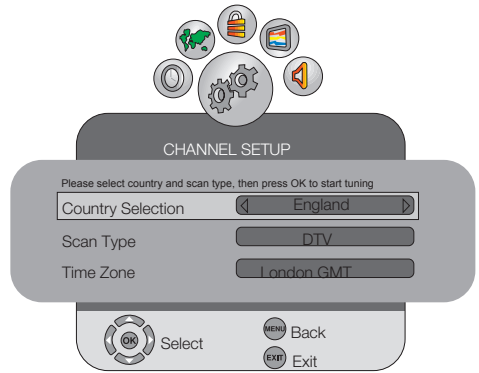

Scroll to the **Country Selection** tab by pressing the **Up/Down** movement buttons and press **Right/Left** movement buttons to select your country. Then, scroll to the **Scan Type** tab by pressing the **Down** movement button and select **DTV** option by pressing the **Right/Left** movement buttons. Press **OK** button to confirm your selections. Digital channels are searched and stored automatically. At the same moment, the progress of auto tuning and the channels stored in the memory are displayed in the menu.

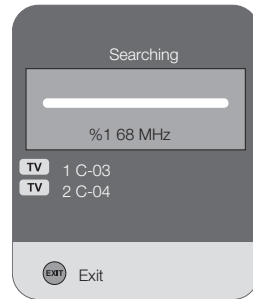

Program Table menu is displayed at the end of the Auto Tuning.

Note: If you wish to search the Digital and Analogue channels concurrently, choose **Scan Type** as **Digital and Analogue** from the **Auto Tuning** menu.

ADDITIONAL INFORMATION

Please note that Encrypted channels may not be stored after scanning in the Digital TV channels. If this is the case then you will need to rescan the channels again but this time change the **LIST SCRAMBLED CHANNELS** from **AUTO** to **ON**:

- 1 Press Menu.
- 2 Select Features.
- 3 Select Digital Features.
- 4 Select User Interface Options.
- 5 List Scrambled Channels will show. Change "Auto" setting to "ON"
- 6 Press Exit button to exit the Menu.

You will need to rescan the digital TV channels:

- 1 Press Menu.
- 2 Select Setup.
- 3 Select Auto Tuning and press the OK button to start the channel scan and this time store the Scrambled channels.

6.3.2-Manual tuning of digital channels and storing in the memory

Press the **MENU** button on your remote control. Select **CHANNEL SETUP** by pressing the **Right/Left** movement button and confirm your selection with **OK** button. Select **Digital Manual Tuning** tab by pressing the **Up/Down** movement buttons and press **Right** movement button or **OK** button to confirm. **Digital Manual Tuning** menu will be displayed.

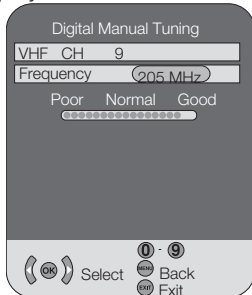

Enter the channel number from the Manual search menu using the numeric keys if you know the channel number; if you don't know the channel number, you can perform search by using **right/left** direction buttons.

Channel will appear in the list and be stored in the memory when it is found. Press **MENU** button to return to the previous menu from the manual search menu or press **EXIT** button to exit the menu.

6.4-Performing Analogue channel settings

6.4.1-Automatic tuning of analogue channels and storing in the memory

Press the **MENU** button on your remote control. Select **CHANNEL SETUP** by pressing the **Right/Left** movement button and confirm your selection with **OK** button. Select **Auto Tuning** tab by pressing the **Up/Down** movement buttons and press **Right** movement button or **OK** button to confirm. **Country Selection** menu will be displayed.

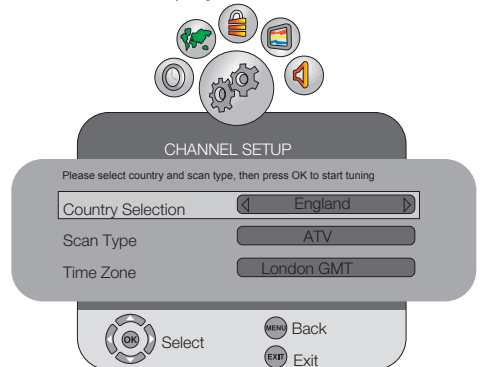

Scroll to the **Country Selection** tab by pressing the **Up/Down** movement buttons and press **Right/Left** movement buttons to select your country. Then, scroll to the **Scan Type** tab by pressing the **Down** movement button and select **ATV** option by pressing the **Right/Left** movement buttons. Press **OK** button to confirm your selections. Analogue channels are searched and stored automatically. At the same moment, the progress of auto tuning and the channels stored in the memory are displayed in the menu. **Program Table** menu is displayed at the end of the Auto Tuning.



6.4.2-Manual tuning of analogue channels and storing in the memory

6.4.2.1-If you already know the channel number



Select **Analogue Manual Tuning** by pressing the **Up/Down** movement buttons in the **CHANNEL SETUP** menu and confirm by pressing the **OK** button. **Analogue Manual Tuning** menu will be displayed.

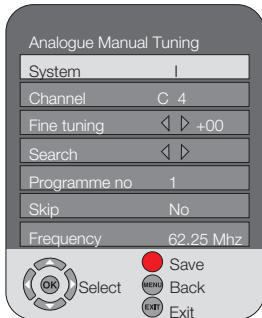

Select the system in which you would like to make the search from the **System** tab by pressing the **Right/Left** movement buttons and move to the **Channel** tab by pressing the **down** movement button. Press **OK** on your remote control to select “**S**” band cable input or “**C**” band aerial input and enter the channel number with numeric buttons. Move onto the **Program No** tab and enter the channel number in which you would like to have the channel stored. If the broadcast viewed on the screen is of your desired quality, press the **Red** button on your remote control to store the action into memory. The channel will be stored according to the program number of your choice. You can tune and store in memory other channels the same way. In the event that you wish to exit the menu for any reason, simply press the **EXIT** button.

6.4.2.2-If you do not know the channel number

Select **Analogue Manual Tuning** by pressing the **Up/Down** movement buttons in the **CHANNEL SETUP** menu and confirm by pressing the **OK** button. **Analogue Manual Tuning** menu will be displayed.

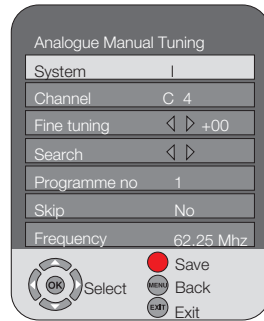

In the **Program no** tab, enter the channel number where you would like to store the searched channel. Select the system in which you would like to make the search from the **System** tab by pressing the **Right/Left** movement buttons and move to the **Channel** tab by pressing the down movement button. Press **OK** on your remote control to select “**S**” band or “**C**” band, scroll to the **Search** tab by pressing the **down** movement button and press **Right/Left** movement buttons to start the search. Press the **Red** button on your remote control to store the channel you found. The channel will be stored to the channel number of your choice.

6.4.2.3-Fine Tuning

If the channel you found is not of the desired quality and requires Fine Tuning, then select the **Fine tuning** tab by pressing the **Down** movement button in the **Analogue Manual Tuning** menu. Using the **Left/Right** movement buttons on your remote control, adjust the broadcast displayed on the screen to your desired quality. Under normal circumstances, you will not require to use the Fine Tune function. The AFC values of your television will automatically adjust and lock themselves to the channel. However, you might need it in case the television transmitters do not operate according to the standards. Press the **Red** button on your remote control to store the settings you made.

6.5-Electronic TV Guide (EPG)

EPG

Electronic TV Guide is for Digital broadcasts only. If it is supported by the broadcasting enterprise, the Electronic TV Guide gives general information about all of the programs of the next 8 days. To display the Electronic TV Guide, press **EPG** button on the remote control and EPG will be displayed.

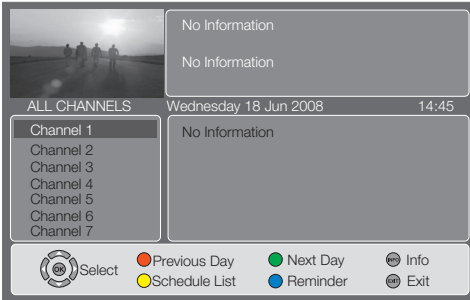

Important Note: Not all broadcasting enterprises supply a detailed TV guide. Most of the broadcasting enterprises provide daily program information, but they do not give detailed explanations. Some broadcasting enterprises, on the other hand, do not give any program information at all.

You may navigate through the channels by **P+/P-**, or **up/down** movement buttons and the broadcast stream of the channel you select will be displayed on the right side. To get further information about the program press Info button and detailed information about the selected program will be displayed. To display the program information of the next day press the right movement button followed by the **GREEN** button and press **RED** button to display the program information of the previous day. You may add timer for any program you like in the broadcast stream. When the time of the relevant program comes, a warning screen appears. To add a timer to any broadcast you wish, select the broadcast you want to add timer from the EPG menu with the movement buttons and press the **BLUE** button on your remote control. **Reminder** menu will be displayed.

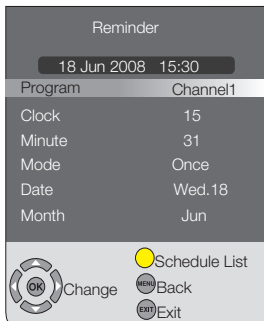

You can add Timer by entering the reminder information and pressing the **OK** button. You can display the Timer you have added or delete a previously added timer in the **Schedule List** menu.

6.6-Program table

With the program table, you may list the television channels, delete channels, create favorites list, lock any channel you wish or change the names of the analogue channels according to your personal choice. Select the **Program Table** tab by pressing the **Down** movement button in **CHANNEL SETUP** menu and confirm with the **OK** button. **Program Table** menu will be displayed.

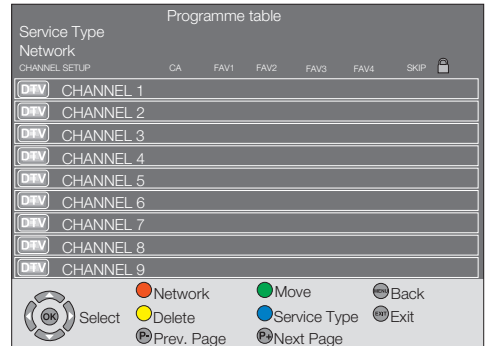

6.6.1-Selecting the Service Type

You may select the service type by pressing the **“BLUE”** button on your remote control in the Program table menu. The service type you have selected appears on the upper left corner of the menu. Service types are in the form of **“ALL TYPE”** (all channels), **“DTV** (only Digital channels), **ATV** (only Analogue channels) and **Radio** (only radio channels). Only those channels in the service type you select shall be displayed on the Program table menu.

6.6.2-Creating and selecting favorites list

In your television you can create 4 favorite channel lists based on your personal preferences. To do this, select the channel you would like to add in the favorite list by using the **Up/Down** movement buttons while you are in the Program Table menu, then select the favorite list into which you would like to add the channel by using the **Right/Left** movement buttons and press the **OK** button.

A **“Heart”** symbol will be displayed under the favorite list to which you have added the channel. You can add the channel you have selected into more than one favorite list. You can directly select the favorite channel list you

created. To do this, press the **FAV** button on your remote control. **Favourite List** menu will be displayed.



Select one of the **ALL CHANNELS**, **FAV1**, **FAV2**, **FAV3**, **FAV4** lists by pressing the **Up/Down** movement buttons and press **OK** button to confirm.

6.6.3- Relocating a stored channel

Select the channel you want to relocate from the Program Table menu with **Up/Down** buttons and press the **GREEN** button on your remote control. Select the new channel number to which you would like to move the channel by pressing the **Up/Down** movement buttons and press the **OK** button. Your channel will be moved to its new location. You may perform this procedure for more than one channel. Press **EXIT** button to finish the setting process.

6.6.4- Deleting a stored channel

Select the channel you want to delete from the Program Table menu with **Up/Down** buttons and press the **YELLOW** button on your remote control. The tab of the channel to be deleted will become yellow. Press **GREEN** button to delete the selected channel or press **RED** button to delete the whole channel list. Once you press the Green button, the selected program is deleted and the following channels are transferred to previous program number. After setting is complete, press the **EXIT** button to exit the menu.

6.6.5- Locking a stored channel

For this feature, please see page. 21-22

7.5-Parental Control

6.6.6-Skipping a stored channel

In the event that you do not wish to see certain programs while navigating through the channels using the **P+/P-** buttons, then you can use this function. Select the program that will be hidden by pressing the **Up/Down** or **Right/Left** movement buttons, scroll to the **Skip** option and press **OK** button to confirm. **SKIP** will appear on the program to be skipped. You may perform this procedure for more than one program. To view the skipped program, directly enter the program number using the numeric buttons or select it from the Channel List menu. To cancel the program skipping process, select the **SKIP** option again. After setting is complete, press the **EXIT** button to exit the menu.

6.6.7- Renaming a stored analogue channel

You can assign an analogue program or programs of choice the names that have a maximum of eight characters. To do this, select the analogue channel you want to rename from the **Program Table** menu with **Up/Down** movement buttons and press the **RED** button on your remote control. The colour of the tab where the channel name exist will change and a green box will appear around the initial letter of the channel name; choose the desired letter, number or sign using the **Up/Down** movement buttons. For the next character, press the **Right** movement button and then select the desired letter, number or sign again with the **Up/Down** movement buttons. After entering all the characters, store the name you have written in the memory by pressing the **OK** button. To write names for any of the other programs, simply repeat the above procedure. Press **MENU** button to return to the previous menu or press **EXIT** button to exit the menu after the setting is complete.

6.6.8-Channel List

If you press **OK** button when no menu is open, **Channel List** menu will be displayed on the screen.



You can see all the channels of the current mode while you are in the **Channel List** menu, you can select the desired channel with **Up/Down** buttons and view it by pressing the **OK** button.

6.7-Signal Information

This menu gives information about Channel, Network, Modulation, Signal level and quality. Press **MENU** button to enter this menu. Select **Channel Setup** menu by pressing the **Right/Left** movement buttons. Select **Signal Information** tab by pressing the **Down** movement button and confirm with **Right** movement button or **OK** button. Signal Information menu will be displayed.

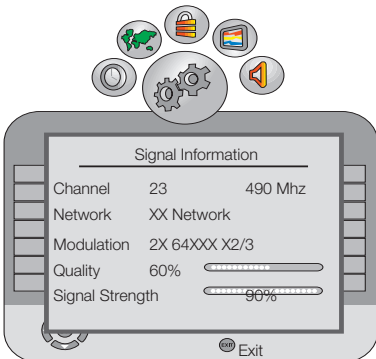

Note: Signal Information menu will be active only for Digital broadcasts.

6.8-CA Module (Conditional Access)

In this menu, you can check the CA Module settings. If a CI module is inserted for a channel that has a scrambled broadcast, then a submenu for that module is opened and the information for that module is updated.

6.9-Active Antenna Power

When this feature is set to On, you can connect an external antenna to your television without needing any external source. Scroll to the **Active Antenna Power** tab by pressing the **down** movement button in the **Channel Setup** menu and select **On** by pressing the **Right/Left** movement buttons.

7 The settings on your new television

7.1-Performing the Sound settings

You may perform Volume settings by using the **V+** or **V-** buttons on your television or the **VOL+**/**VOL-** buttons on your remote control. You can perform other Sound settings by entering the Sound menu. To do this, press the **MENU** button on your remote control, select **SOUND** menu by pressing the **Right/Left** movement buttons and press the **OK** button. In this menu, you can select one of the titles for which you would like to perform an operation.

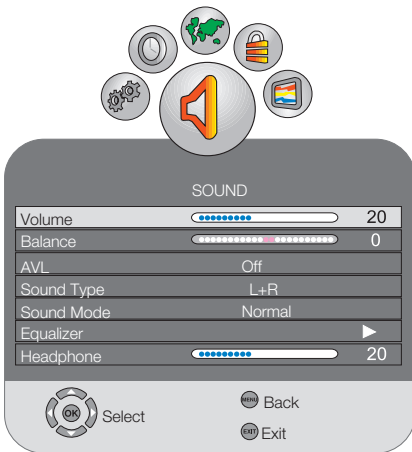

7.1.1-Balance

To adjust the sound balance between the right and left loudspeakers to the desired level, select the Balance tab in the volume menu by using the **Down** movement button. Using the **Left/Right** movement buttons adjust this option to the desired level.

7.1.2-AVL (Automatic Volume Limiting)

Television transmitters have different sound levels. This can be noticed from the different volume levels that can be heard while switching from one program to another. Using the **Right/Left** movement buttons, select **ON**. The AVL (Automatic Volume Limiting) function maintains the same sound level as you switch from program to program. Select **Off** to cancel it.

7.1.3-Sound Type

The program you watch may be broadcast in stereo or in two different languages. Using the **Right/Left** movement buttons in this menu, you can select Mono/Stereo or Dual-1/ Dual-2.

7.1.4-Sound Mode

If you would like to add some depth to the sound of the program you are watching, press **Right/Left** movement buttons to select **Normal** or **Spatial** feature.

7.1.5-Equalizer

Select the **EQUALIZER** tab in the Sound menu and confirm with the **OK** button. The Equalizer menu is displayed.

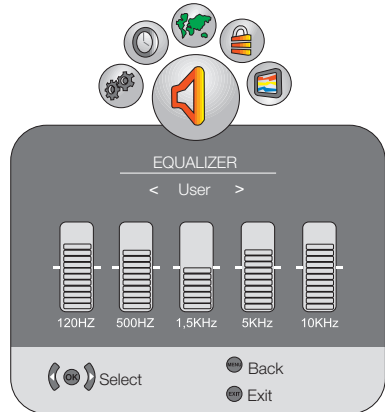

Using the **Right/Left** movement buttons, you may select either one of the preset **Music**, **Sports**, **Cinema** and **Speech** options which enhance the sound effect depending on the feature of the program you are watching or the **User** option which you can adjust as you desire. To adjust the User option, select **User** and press the **OK** button. You can adjust the frequency levels with the **Up/Down** movement buttons. You can select one of the **120Hz**, **500Hz**, **1.5kHz**, **5kHz** and **10kHz** frequency bands with **Right** and **Left** movement buttons. Press the **MENU** button to store the settings and exit the user option.

Note: You can select the equalizer options directly by pressing the () button on your remote control.

7.1.6-Headphone

By connecting headphones to your television you can listen to the program sounds independently from your television. To turn up and down the headphone volume level, select Headphone tab from the Sound menu and adjust the volume level by using the Right/Left movement buttons.

Note 1: The settings you have made in the Sound menu will be stored in the memory without requiring any other operations.

Note 2: When you want to hear the sound from the headphone only, just press the **MUTE** button on your remote control.

7.2-Performing the Picture settings

7.2.1-Picture Menu

You can perform Picture settings by entering the Picture menu. To do this, press the **MENU** button on your remote control, select **PICTURE** menu by pressing the **Right/Left** movement buttons and press the **OK** button. In this menu, you can select one of the titles for which you would like to perform an operation.

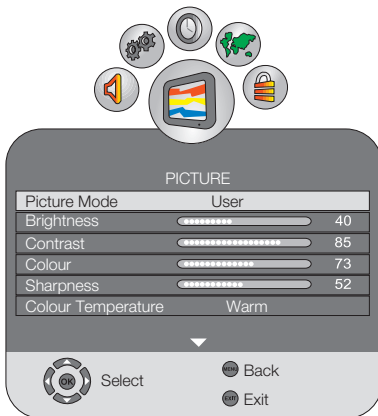

You can select the desired setting by pressing the **Up/Down** movement buttons and adjust their levels with **Right/Left** movement buttons. You can adjust **Picture Mode, Brightness, Contrast, Colour, Sharpness and Colour Temperature** levels as you desire. You can adjust the **DNR, MPEG NR, Vibrant Colour, Perfect Clear, Dynamic Contrast, Dynamic Backlight** and **Backlight** options as you desire from

the **Advanced Picture Settings** menu. The changes you have made in the **PICTURE** menu will be stored in the memory without requiring any other operation.

7.2.2-Picture Mode

You can select either one of the four non-adjustable settings in the memory or one of the user options by pressing the () button on your remote control. **Vivid, Natural, Cinema** and **Sports** are default values; **USER** represents the values you stored in memory.

7.2.3-Colour Temperature

Colour intensity of the picture can be adjusted with this feature. Select **Colour Temperature** tab from the picture menu by pressing the **Up/Down** buttons to activate this feature and then select one of the **Cool, Normal** or **Warm** options by pressing the **Right/Left** buttons.

7.2.4-Tint

When NTSC video is input via Scart, you may make Hue settings. The tint option is not seen in the menu when you have not input this type of a video. When a NTSC video is connected via the Scart, this option becomes active and it is available in the menu.

7.2.5-Advanced Picture Features

You can adjust advanced picture features of your television from the Advanced Picture Settings menu under Picture menu.

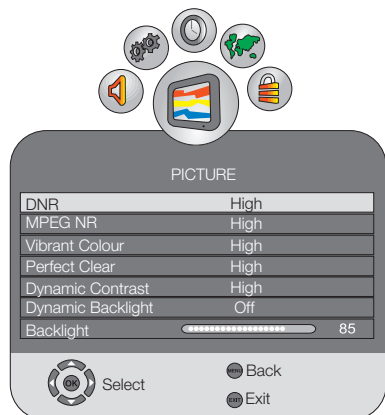

7.2.5.1-DNR (Noise reduction)

You may reduce interference and noise formed in the picture by using this feature. Select **DNR** tab with the **Up/Down** movement buttons to activate this feature and select one of the **Off, Low, Normal, High** or **Auto** options with **Right/Left** movement buttons.

Note: Noise reduction function is only effective in weak broadcasts.

7.2.5.2-MPEG NR

You can remove the artifacts that appear in the picture as square shaped blocks by using this feature. Select **Mpeg NR** tab with the **Up/Down** movement buttons to activate this feature and select one of the **Off, Low, Mid** or **High** options with **Right/Left** movement buttons.

7.2.5.3- Vibrant Colour

With this feature you can automatically adjust colour saturation according to the scene. To do this, select **Vibrant Colour** tab with the **Up/Down** movement buttons and select one of the **Off, Low, Mid** or **High** options with **Right/Left** movement buttons. With the 'High' option you can obtain the most saturated colours.

7.2.5.4- Perfect Clear

With this feature you can automatically adjust black level of the picture according to the scene. To do this, select **Perfect Clear** tab with the **Up/Down** movement buttons and select one of the **Off, Low, Mid** or **High** options with the **Right/Left** movement buttons.

7.2.5.5-Dynamic Contrast

This feature allows making brightness settings according to the picture. A brighter or dimmer picture can be sent to the screen according to the brightness level of the picture. Thus, a wider effect is obtained in terms of contrast. Select **Dynamic Contrast** tab with the **Up/Down** movement buttons to activate this feature and select one of the **Off, Low, Mid** or **High** options with **Right/Left** movement buttons.

7.2.5.6-Dynamic Backlight

With this feature you can automatically adjust backlight strength according to the average brightness in the scene. To do this, select **Dynamic Backlight** tab with the **Up/Down**

movement buttons and select one of the **Auto, Daylight, Night** or **Off** options with **Right/Left** movement buttons. When the Dynamic Backlight is set to Off, Backlight option becomes active. Backlight option is not accessible when other options are selected.

7.2.5.7-Backlight

With this feature, you can adjust the intensity of light reflected to the LCD Panel. To do this, select **Back Light** tab with the **Up/Down** movement buttons and adjust the level as you desire with **Right/Left** movement buttons.

7.2.6-Picture Format

With this option, you can view the broadcast you watch in a format of your choice. You can view the broadcasts in Auto, 16:9, 4:3, Subtitle, Letterbox, Panorama or 14:9 formats. 16:9 or 4:3 formats can be selected in PC modes. In that case, the name of the selected picture format will be displayed in the centre of the screen.

7.2.6.1- Auto

Some movie channels may broadcast in the 16:9 format. If you would like to see this format automatically, then select Auto. In that case, Auto appears on your screen.



7.2.6.2-16:9

Please use this setting for watching wide screen DVDs, wide screen video cassette or 16:9 formatted broadcasts. Since various screen formats such as 16:9, 14:9 and etc. are used, black stripes might be formed on the lower and upper parts of the screen.



7.2.6.3-14:9

This is a movie format.



7.2.6.4-4:3

Use this setting to watch the broadcasts in the 4:3 format.



7.2.6.5-Subtitle

If the subtitles are transmitted in the "16:9 formatted" broadcast, then this setting will push the picture upwards in order to ensure the entire written text to be seen.



7.2.6.6-Letterbox

While watching a "16:9 or Cinemascope formatted" film or video cassette, this setting will eliminate or minimize the black stripes on the background by zooming in the picture without diffusing it.



7.2.6.7-Panorama

This setting will enlarge the image to fit the screen by stretching the image horizontally while holding the correct proportions at the centre of the image. Some distortion may occur.



Note: Since the use of certain functions in order to change the picture sizes for collective projection or commercial purposes (modifying the height and width etc.) will be deemed an infringement of the picture's copyright, legal proceedings can be carried out as required under relevant laws.

7.2.6.8-Overscan: Off

When this mode is selected, high defined picture from the HDMI is not cropped and it is displayed in its original size. This is only active in HDMI mode and for resolutions at or above 720p.

7.3-Performing the timer settings

Your television is equipped with the feature of being able to be turned off and on at periods that you specify. Press the **MENU** button. Select **TIMER** menu by pressing the **Right/Left** movement buttons and press **OK** button. In this menu, you can select one of the titles for which you would like to perform an operation.



7.3.1-Clock

Current time and date information must be entered from the clock tab. To do this, select the **CLOCK** tab and confirm with the **OK** button. The Clock menu is displayed. Select **Day**, **Month**, **Year**, **Hour** and **Minute** by pressing the **Up/Down** movement buttons and enter the required information for each of them using **Left/Right** movement buttons. Press **MENU** button to return to the previous menu or press **EXIT** button to exit the menu.

7.3.2-Off Time

Select the **Off Time** tab by pressing the **Up/Down** movement button in **TIMER** menu and confirm your selection with the **Right** movement button or **OK** button. In this menu, you can set the off time for your television with weekly or daily periods.

7.3.3-On Time

Select the **On Time** tab by pressing the **Up/Down** movement button in **TIMER** menu and confirm your selection with the **Right** movement button or **OK** button. In the On Time menu, you can set the on time for your television with weekly or daily periods. In this menu, you select one of the TV, DTV or Radio modes, a specific channel and the volume that would become active when the TV is turned on.

7.3.4-Sleep Timer

Sleep Timer switches your television automatically to Standby Mode after the preset time has elapsed. You can adjust this time between 10 and 240 minutes with certain intervals. To do this, select the **Off Time** tab and press **Right/Left** movement buttons to select the desired time.

7.3.5-Auto Sleep

Auto Sleep option can be set to on or off. When the Auto Sleep function is set to **Off**, **NO SIGNAL** will appear on the screen when the TV does not receive any signal from any source and your television will not be turned off. When the Auto Sleep function is set to **On**, **NO SIGNAL** will appear on the screen if the TV does not receive any signal from any source and the countdown OSD of 5 minutes will appear. Television is turned off at the end of the time.

7.3.6-Time Zone

Select the **Time Zone** tab by pressing the Up/Down movement buttons in Timer menu and select your current time zone with the Right/Left movement buttons.

7.4-Options menu settings

Press the **MENU** button on your remote control. Select **OPTIONS** by pressing the **Up/Down** movement buttons and press the **OK** button. You can select the titles for which you would like to perform an operation in this menu by using the **Up/Down** movement buttons.

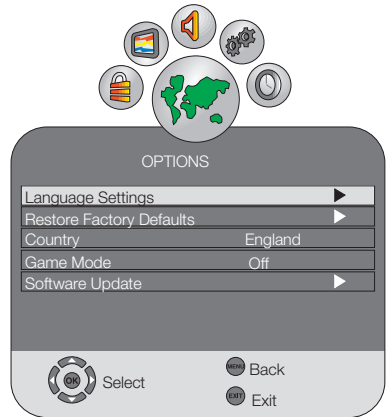

7.4.1-Language Settings

Select **Language Settings** from the Options menu and press the **OK** button. The Language Settings menu is displayed. You can adjust the Menu language, Audio language and Subtitle language from this menu. Audio and Subtitle languages can only be selected when they are supported by the broadcaster. Unless you make any selection, the language supported by the broadcaster will be selected automatically. You can select the **Language Settings**, **Audio Languages**, **Subtitle Languages** and **Hearing Aid** tabs and set the desired values by pressing the **Right/Left** buttons. When the Hearing Aid option is set to On, the Subtitles will appear in the language transmitted by the broadcaster if the Broadcasting company transmits Subtitles specifically. If the Hearing Aid is set to Off, the language selected in the subtitle languages option in the menu will be active.

7.4.2-Restore Factory Defaults

You can switch your television back to factory settings with this feature. Select **Restore Factory Defaults** tab and press the **OK** button. Confirmation screen will be displayed. In this screen, you can restore the factory settings of your television by selecting the **Yes** option with **Right/Left** buttons or cancel this action by selecting the **No** option.

7.4.3- Country

You can not access the **Country** option from the Options menu. The country selected during the initial use will automatically displayed in the menu.

7.4.4- Game Mode

In the Options menu, you can set the **Game Mode** tab to **On/Off** by pressing the **Right/Left** buttons. When the Game Mode is set to On, display settings will return to the default values.

Game Mode becomes active only for PC, HDMI and YPBPR sources. When the Game Mode is set to ON for these sources, picture mode in the Picture menu will switch to the Game Mode. Only colour temperature and backlight settings can be changed in this mode. Game Mode provides a considerable increase in the picture quality when the TV is used as a monitor for game consoles and for displaying the text files. It is advised to turn this mode off when you would like to watch a movie from the above mentioned sources.

7.4.5-Software Update

When a new software is found through OAD (On Air Download) from this menu, it will be installed automatically. Select Software Update tab and press the OK button. Your television will start to search for a new software and perform the software install process if a new software exists.

Note: Software Update tab is not displayed in the Analogue mode.

7.4.6-Decoder Setting

You can set the Decoder Setting tab to **On/Off** by pressing the **Right/Left** movement buttons. When it is set to **ON**, RF signal will be output from the SCART output. This option must be set to ON when a Decoder is connected to SCART. When this option is set to **OFF**, RF signal will not be output from the SCART output. This option appears in the menu when the Signal Source is set to SCART. It is not displayed in the menu in other options.

7.5-Parental Control

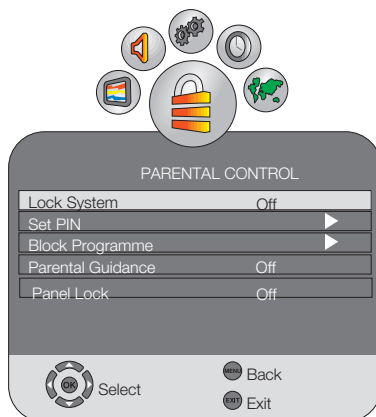

In the Parental Control menu, you can preclude channels that are not appropriate for children and set age restriction for programs being broadcasted. Password screen will be displayed when entering this menu. The menu will open only when the correct password is entered. The default password is set as **0000**. You can change the password from the Set PIN menu as you wish.

7.5.1-Lock System

When the Lock System feature is set to **On**, a password is prompted if you want to enter in the **Auto Tuning**, **Digital Manual Tuning**, **Analogue Manual Tuning** submenus in the **Channel Setup** menu and the **Program Table** menu. These menus are not accessible unless the correct password is entered.

7.5.2-Set PIN

You can change your Parental Control password from this menu as you wish. To do this, select **Set PIN** tab and press **OK** button. Set PIN menu will be displayed. Once you enter your new password two consecutive times, your password will be changed.

7.5.3-Block Programme

With the Block Program feature, you can lock the desired channel and prevent it from being viewed unless the correct password is entered. To do this, select **Block Programme** tab from the Parental Control menu by pressing the **UP/Down** movement buttons and confirm your selection with **OK** button. Block Programme menu will be displayed. Select the channel you want

to block from the Block Programme menu with **Up/Down** buttons and confirm with the **GREEN** button on your remote control. A lock symbol will appear next to the channel name. When a blocked channel is selected, the password screen will be displayed and the channel will not appear until the correct password is entered. If you do not enter the password, **CH BLOCKED** will be displayed on the screen. There will also be a lock symbol next to the blocked channel in the Program Table. Repeat the same steps to remove the blocking.

7.5.4-Parental Guidance

If it is supported by the broadcaster, this feature allows you to enter an age restriction between 4 and 18 for the programs broadcasted. If the program to be broadcasted is over the age restriction you entered, the channel will not be displayed and a password screen will appear. To view the program, correct password must be entered. Enter an age limit between 8 and 18 from the Parental Guidance tab in order to activate this feature.

7.5.5-Panel Lock

If this feature is turned On, the control buttons on your LCD Television will be locked and will not function. When it is set to off, control buttons will become active.

7.6-Other picture features

7.6.1-Zoom

 Press the **ZOOM** button on your remote control while watching a channel to activate this feature. The image is zoomed in 3 stages oriented to the centre.

Note: Zoom feature is aborted when the channel is changed.

7.6.2-Freeze (Freeze picture)

 You may freeze the program picture you are watching with this feature. For this, press the **Timeshift** button on your remote control. The program picture will freeze until the same button is pressed a second time. **Freeze: On, Freeze: Off** OSD will appear each time you press the **Timeshift** button.

7.6.3-Picture and Teletext (PAT)

 With this feature, you can follow the teletext broadcasts simultaneously with the current program, provided that the current program contains teletext broadcast. For this purpose, when you press **TXT** and then **16:9** buttons in a channel with teletext broadcasting, the screen will be split into two with the left pane showing the currently watched program and the right pane will show the Teletext at the same time. In the event that you wish to exit the **PAT** mode for any reason, simply press the **TXT** button.

8 Teletext

Being one of the most prominent services of broadcasting today, Teletext renders the TV more fruitful. Teletext means in short the transmission of various updated information along with the TV broadcast signal in the form of text and graphics. To be able to receive a quality teletext broadcast, a good antenna system and a broadcast signal that is not weak, with no reflections and interference from other channels are required. Even in a very clear reception, it is normal for some characters or tabs to be lost. Such conditions will automatically be improved in a short time under normal circumstances.

8.1-Entering the Teletext Mode

In order to switch your television to the teletext broadcast, please press the **TXT** button in a program that has a teletext broadcast. To switch back to the television broadcast, press the **TXT** button for two consecutive times. Once you have switched to the teletext broadcast, the initial page that appears will be the index page. P100 In this page, the titles of the topics in the teletext broadcast and the initial page numbers will appear.

8.2-Page Selection

 To be able to view the page you would like on the screen, type in the number of that page using the numerical keys. You can see the number you have entered on the left side of the upper title tab. When you would like to turn the pages one by one, you can go to the next page pressing the **Up/P+** button and to the previous page pressing the **Down/P-** button. Press the **INFO** button to return to the Index page.

8.3-Teletext image in the TV picture (MIX)

 With this feature, you can watch the teletext information and the TV broadcast together. Thus, you can follow the teletext broadcast of the channel while you watch the TV broadcast. To do this, press **TXT** button two times consecutively in a channel with Teletext broadcast.

8.4-Page enlarge button (DOUBLE)

 You can view the upper half of the teletext page in an enlarged format by pressing the **DOUBLE** button on your remote control. To be able to view the bottom half of the enlarged page, press the same button for the second time. Once you press the same button the third time, the page will be restored to its normal size.

8.5-Page Stop (STOP)

 Some information is laid out by the broadcasting agency in multiple pages and it is broadcast in an automatic cycle mode. For example, on a text of four pages, the pages are indicated with the figures 01, 02, 03 and 04 on the bottom of the page. To view one of these pages for a longer time, press the **STOP** button. When you press the same button again, the cycle continues.

8.6-Subpage selection (SUB)

 If the page of text you are viewing contains sub pages the page numbers starting from 01 appear on the screen. You can switch to the sub pages with the **SUB** button. In this case, subpage selection will appear next to the page number in the upper left corner in 0001 format; you can either directly enter the number of the subpage you want to display with number keys or select the subpages one by one by pressing the **RED/GREEN** buttons. You can exit the sub page by pressing the **SUB** button again.

8.7-Temporary TV Picture (UPDATE)



This button allows you to switch to the television picture while the page you want is being searched in the teletext broadcast eliminating the need to wait during the search. You may switch to the television picture by pressing the **UPDATE** button while Teletext is searching for your desired page. Once the page you want is found, the number of that page appears on the screen.

8.8-Question - Answer Button (REVEAL)



Sometimes, a teletext page contains a hidden answer such as a game or a riddle. Press the **REVEAL** button to disclose the hidden answer.

8.9-Clock



The Clock function of the **SIZE** button; press the **SIZE** button when you want to learn the time while watching any television channel. In that case, a clock will appear on the lower right corner of the screen. You can remove the time information from the screen by pressing the same button.

8.10-Fastext

The coloured buttons on the remote control are for the fastext feature. When you select any page, the titles on various subjects may appear on the screen in four different colours or inside coloured frames (red, green, yellow and blue). By pressing the button pertaining to the relevant colour on the remote control, you can access the subject of your choice without waiting.

Note: The fastext feature is not available for all teletext broadcasts. It is determined by the broadcasting agency whether it is to be broadcast or not.

9 External Equipment Connections

Your TV is equipped with 9 inputs including antenna input, which allows for the external device connection. These inputs are:

- 1-Aerial input
- 2-SCART input
- 3-AV input
- 4-S-Video input
- 5-PC input
- 6-HDMI1 input
- 7-HDMI2 input
- 8-YPbPr Component input
- 9-CI slot input

You can connect your external device supporting the suitable inputs to your TV via these inputs. By pressing the SOURCE button on your remote control, select the external source input to which you connected your device.

9.1-Headphone Connection

Side view of the TV

The headphones must have impedance between 8 and 32 ohms and have a 3.5 mm stereo jack plug. Plug the headphone jack into the headphone socket of the TV.

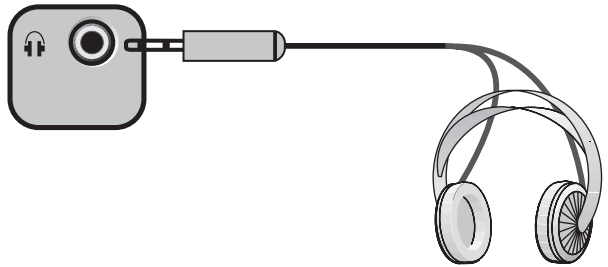

9.2-Connecting an external device via Scart connection

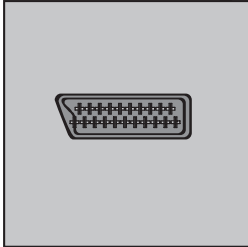

Rear or side view of the TV

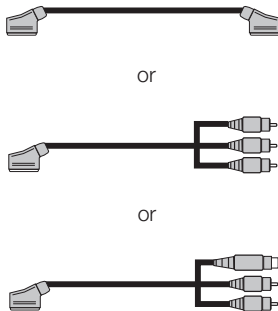

or

or

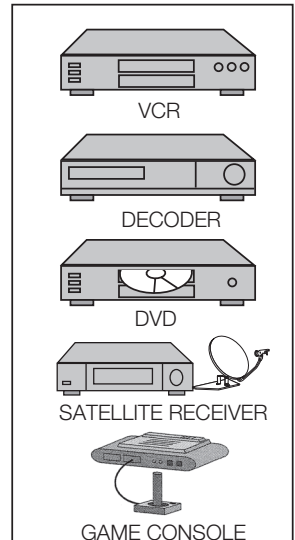

SCART : To watch the picture of the broadcast device connected to SCART, select Scart from the Source menu and press OK button. (You can watch via this Scart if the connected device has a RGB output).

9.3-Connecting external equipment via AV connection

Side view of the TV

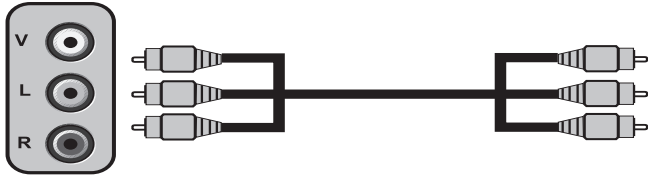

AV : To watch the picture of the broadcast device connected using the RCA (Phono) input, select AV option from the Source menu and press OK button. Your TV will switch to the selected source.

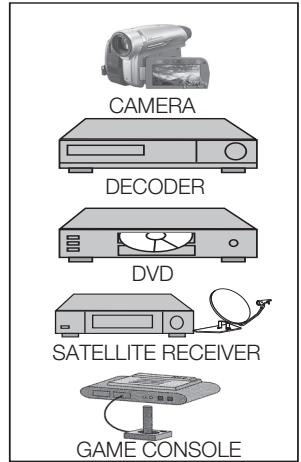

9.4-Connecting an external device via S-Video connection

Side view of the TV

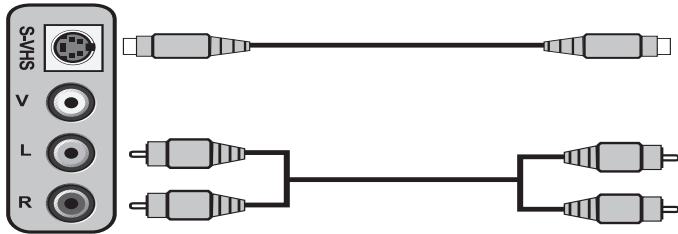

S-Video: To watch the picture of the broadcast device connected using the SVHS input, select S-Video option from the Source menu and press OK button. Your TV will switch to the selected source.

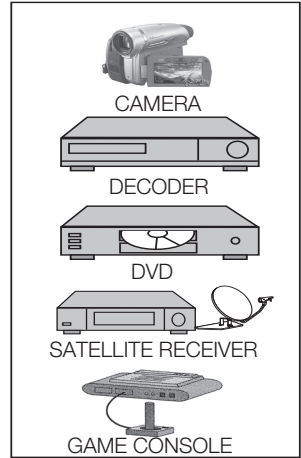

9.5-Connecting an external device via YPBPR connection

Rear view of the TV

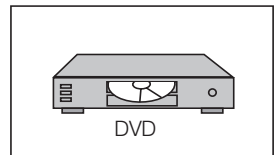
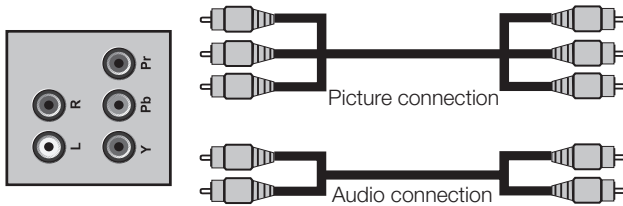

YPBPR (Component Input): When a connection is made via YPBPR socket, select YPBPR option from the Source menu and press the OK button. Your TV will switch to the selected source.

9.6-Connecting an external device via HDMI connection

Rear or side view of the TV



HDMI: When a connection is made via HDMI socket, select the HDMI input through which you have made the connection from the Source menu and press the OK button. Your TV will switch to the selected source.

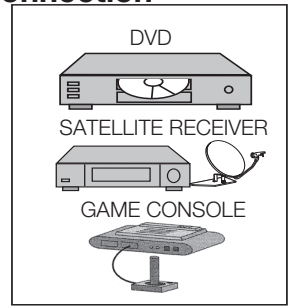

Connect to the HDMI input at the back of your TV by using the connector located on your PC or your digital video-transmission device with a suitable cable (not supplied with the TV).

Note1: To be able to watch an image in the HDMI mode, your computer must be equipped with a HDMI graphic card.

Note2: Please adjust the video card settings of your PC if the PICTURE does not fit to the screen when you transfer the picture to your television from a PC with a DVI to HDMI or HDMI to HDMI cable.

You may display the resolution information by pressing the **INFO** button.

9.6.1-HDCP

Your TV supports HDCP feature. To use this feature, you must set up a connection to your TV set's HDMI video port and select HDMI by pressing the SOURCE button on your remote control.

NOTE:In HDMI mode; some resolutions are supported when a DVI to HDMI converter cable from a PC is used. Only 16:9, 4:3, 14:9 (some definitions) are supported as picture format.

9.6.2-High Definition - HD-READY



Your television can receive high-definition signals (HDTV). You can connect the input sources (HDTV set-top box or HDTV DVD player) to the (HDMI) socket (digital HDTV signal). This ensures that you can view digital HDTV programs, even if they are copy-protected (HDCP High-Definition Copy Protection).

9.7-PC connection

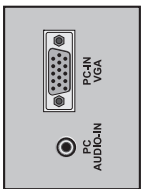

Rear view of the TV



9.7.1-PC Connection:

Connect the D-Sub15 connector to the **PC-IN** socket at the back of your television by using an appropriate cable (not supplied with your television). Again, by using an appropriate cable, connect the audio output of your PC to the **PC AUDIO-IN** at the back of your television to listen to sounds from your PC and you can adjust the volume level of your source by using **VOL+/VOL-** buttons.

9.7.2-Switching to the PC mode

For your LCD-TV to switch to the monitor (PC) mode, press the **SOURCE** button on your remote control. **SOURCE** menu will be displayed. Select **PC** by pressing the **Up/Down** movement buttons and press the **OK** button.

9.7.3-PC Access Setting

Enter into the **SETUP** menu from the Main Menu by pressing the **MENU** button in the PC mode. In order to make the necessary settings in this menu, you can select the headings with the **Up/Down** buttons on your remote control to perform the following monitor-related settings.

9.7.4-Auto Position

The most suitable geometric settings in accordance with the entry mode are configured by this function. For this operation, just select the **Autoposition** tab and press **OK** button.

9.7.5-Horizontal Position: Horizontal position setting.

9.7.6-Vertical Position: Vertical position setting.

9.7.7-Size: This is the pixel clock frequency. User can narrow down or enlarge the display by selecting a desired value.

9.7.8-Phase: Using the **Right/Left** movement buttons, you can ensure that the colours and shapes are exactly consolidated on the PC image.

9.7.9-PICTURE FORMAT

You can select the PC image to be displayed in 16:9 or 4:3 formats.

9.8- Inserting the CI (Common Interface) card

CI module and Smart card allows you to view some scrambled (paid) channels in Digital TV mode. When no CI module is inserted in your television, you can only view the current unscrambled digital/analogue channels.

9.8.1-Inserting the CI Module and Smart card

You can not use the smart card in your television independently. You will need a CAM module to use the smart card. Insert your smart card into the CAM module and then insert the CAM Module into the CI slot on your television. When you insert the module correctly, **CA Module Inserted** appears on the screen and the menu for this module is displayed.

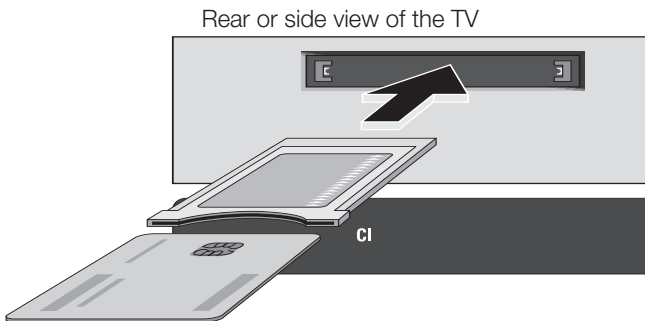

9.8.2-Removing the CI Module and Smart card

When removing the Smart card, make sure that you pull the CAM module out completely with the card inserted. **CA Module Inserted** will appear on the screen.

10 Help and tips

Failure	Possible cause	Solution
The television does not function	Is the power cord connected to the mains supply?	Check the power cord.
	Is the Power On/Off button on?	Check if the On/Off button is on.
Poor picture quality	Is the antenna cable connected?	Check the antenna cable.
	If you are using a satellite antenna, is it well adjusted?	Have the antenna adjusted.
	Antenna may be affected by two connected external devices.	Try disconnecting one of the devices.
	It may need fine tuning.	Perform fine tuning.
	Picture settings are not correct.	Adjust Brightness, Contrast and Colour.
Shadow and reflection in the picture.	Channel setting	Perform automatic, manual channel setting or fine tuning.
	Antenna	Check antenna cable and system
No picture	Is there any damage to the antenna cable?	Check the antenna cable.
	Are you sure you pressed the correct button on your remote control?	Press the PR+ or PR- button to turn on the TV.
No colour.	Colour intensity level is at the lowest setting.	Lighten the colour.
	Broadcast system setting (if setting choice is available)	Select the broadcast system.
	Problem in channel broadcasting.	Test with another channel.
No or defective teletext	Television channel (no teletext) or antenna system.	Test another channel for fine tuning and shadowy pictures
	Very weak signal	Check the antenna system.
No sound	Temporary sound mute may be on	Try pressing the mute button
	Is the sound turned down?	Turn on the volume with Vol + button.
Remote control does not work	Are the batteries correctly placed?	Place the batteries correctly.
	Are batteries exhausted?	Replace the batteries with new ones.
	Is there any obstacle between the remote control and television?	If yes, remove it.
Picture is not visible after turning on the TV	Child lock is active.	Disable the child lock.

If your television does not work properly even though you tried the above mentioned solutions, try turning it on and off again. If you cannot start your television even though you have applied all noted methods, refer to the dealer or authorised service from where you purchased the product. Never attempt to repair a faulty device yourself.

11 Technical Specifications Chart

SCREEN SIZE	26"
Panel type	26", 16:9 Active matrix TFT
Sound output	2x7 W
Power consumption	110 W
Stand by power value	<1 W
SCART input	Standard
Audio/Video Phono input	Standard
S-Video socket	Standard
HDMI input 1/2	Standard
YPBPR input	Standard
VGA input	Standard
PC Audio input	Standard
CI Slot Input	Standard
Dimensions (WxDxH)	490x665x178
Weight (Kg)	9,5

General technical specifications

Power supply AC:	230V 50 Hz
Program memory:	100
RF Aerial input:	75 Ohm (Co-axial)
Loudspeaker impedance:	8 Ohm
Sound systems:	Mono / Stereo
Batteries:	2xUM - 4, IEC R03 or AAA 1.5V
Channels received:	VHF (Band I Channel 2-4) VHF (Band III Channel 5-12) UHF (Channel 21-69) Cable TV (S1-S20/S21-S41)

Design and specifications may be changed without prior notification.

12 MAIN UK TRANSMITTER STATIONS

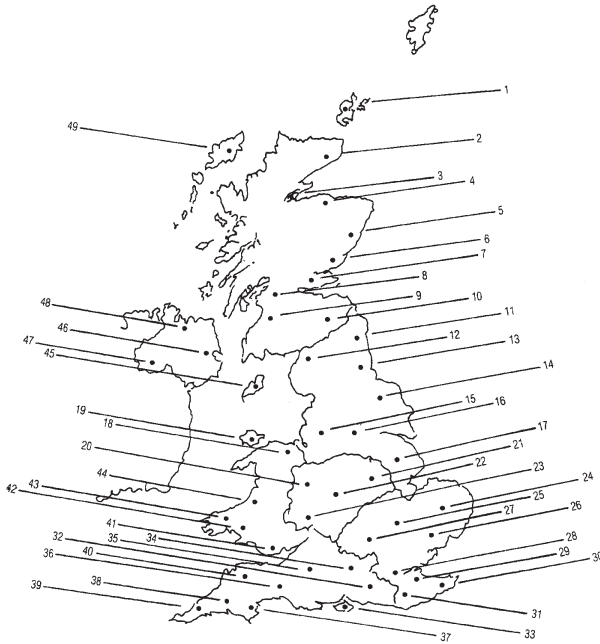

UHF CHANNELS

Regional Main stations

	BBC1	BBC2	ITV	CH4	CH5	Map
North West						
Caldbeck	30	34	28	32	56	12
Winter Hill	55	62	59	65	48	15
Douglas (IOM)	68	66	48	56	56	45
North						
Belmont	22	28	25	32	56	17
Emley Moor	44	51	47	41	37	16
North East						
Blissdale West Moor	33	26	29	23	35	14
Chatton	39	45	49	42		11
Pontop Pike	58	64	61	54	56/58	13
Midlands (West)						
Ridge Hill	22	28	25	32	35	23
Sutton Coldfield	46	40	43	50	37	22
The Wreackin	26	33	23	29	25	20
Midlands (East)						
Waltham	58	64	61	54	35	21
South West						
Beacon Hill	57	63	60	53		37
Caradon Hill	22	28	25	32		38
Huntsshaw Cross	55	62	59	65	67	40
Redruth	51	44	41	47	37	39
Stockland Hill	33	26	23	29		36
Channel Islands						
Fremont Point	51	44	41	47		
West						
Mendip	58	64	61	54	37	35
South						
Hannington	39	45	42	66	35	34
Midhurst	61	55	58	68		32
Rowbridge	31	24	27	21		33

STATIONS CT D

	BBC1	BBC2	ITV	CH4	CH5	Map
Bluebell Hill	40	46	43	65		29
Crystal Palace	26	33	23	30	37	28
Dover	50	56	66	53		30
Oxford	49	52	64	67		31
East						
Sandy Heath	31	27	24	21	39	25
Sudbury	51	44	41	47	35	26
Tacolneston	62	55	59	65	52	24
Scotland						
Angus	57	63	60	53	37	6
Black Hill	40	46	43	50	37	8
Cragkelly	31	27	24	21	48	7
Darvel	33	26	23	29	35	9
Durris	22	28	25	32	67	5
Eitshal (Lewis)	33	26	23	29		49
Keeslang Hill	40	46	43	50		1
Knock More	33	26	23	29		4
Rosemarkie	39	45	49	42	3	3
Rumster Forest	31	27	24	21		2
Selkirk	55	62	59	65	52	10
Wales						
Blaenplwyf	31	27	24	21	56	44
Carmel	57	63	60	53		42
Llanddona	57	63	60	53		19
Moel-y-Parc	52	45	49	42		18
Presely	46	40	43	50	37	43
Wenvoe	44	51	41	47		41
N.IRELAND						
Brougher Mountain	22	28	25	32	37	47
Divis	31	27	24	21	31	46
Limavady	55	62	59	65		48

BEKO

13 Guarantee - Television

Your new television is guaranteed against the cost of breakdown repairs for twelve months from the date of the original purchase.

What is covered?

- All repairs necessary as a result of faulty materials, defective components or manufacturing defect.
- The cost of all functional replacement parts, excluding remote control batteries
- The labour costs of a Beko approved repairer to carry out the repair
- You may be offered a replacement instead of repair under guarantee.

Your dealer will advise you.

What is not covered?

- Transit or delivery damage
- Accidental damage
- Misuse, or abuse.
- Cabinet or appearance parts, including knobs and flaps
- Remote control batteries.
- Repairs or replacements required as a result of unauthorised repairs or inexperienced installation that fails to meet the requirements contained in the user instruction book.
- Repairs or replacements to product installed or used on commercial or non-household premises.

Important notes.

- The product is guaranteed for domestic household use only.
- The guarantee will be void if the product is installed or used in commercial or non-household premises.
- The product must be correctly installed and operated in accordance with the instructions contained within the Operating Instructions Booklet provided with the product.
- The guarantee is given only within the boundaries of the United Kingdom and the Republic of Ireland.
- The guarantee is not transferable if the product is resold.
- Beko Plc disclaims any liability for incidental or consequential damages.
- The guarantee does not in anyway diminish your statutory or legal rights.

Beko House, Caxton Way, Watford, Herts, WD18 8UF, Tel: 0845 600 4911
Website: www.beko.co.uk

BEKO

HOW TO OBTAIN SERVICE

Congratulations on your choice of a Beko colour television. Your new television has been designed and manufactured to the highest quality standards to give you many years of use. To get the best out of it, please take a few moments to read the instruction book.

Your television is supplied with a full 12 months guarantee, covering parts and labour. Should you require service under guarantee, simply call the number below (**see note for small screen sets)

0845 600 4911

Our service receptionist will ask you for your product model number, your retailer's name, and the date of purchase when you call. It will assist you if you complete the box at the bottom of this page when you take delivery of your television so that the information is readily available should you need it. If it is necessary for an engineer to visit your home he will normally be there within 48hrs of receipt of your call (excluding Bank Holidays) or at your earliest convenience.

Before telephoning for service please check the trouble shooting guide in the instruction book as often minor problems are easily identified and resolved by following the instructions contained there in. Service visits where there is no fault with the product could incur a charge even though the product is under guarantee.

Service is also available on the above number after the guarantee period has expired. The cost of any repairs outside of the guarantee period is payable to the engineer at the time of visit.

Please complete the box below for ease of reference later.

Model Number	Serial Number
Date of Purchase	Please of Purchase
Please keep your purchase receipt. The engineer will see it should you require service under the 12-month Guarantee.	

In home repair service is not available on models with a screen size of 21" or under. You should contact your retailer for advice and assistance on these models.

V8K.801

Free Manuals Download Website

<http://myh66.com>

<http://usermanuals.us>

<http://www.somanuals.com>

<http://www.4manuals.cc>

<http://www.manual-lib.com>

<http://www.404manual.com>

<http://www.luxmanual.com>

<http://aubethermostatmanual.com>

Golf course search by state

<http://golfingnear.com>

Email search by domain

<http://emailbydomain.com>

Auto manuals search

<http://auto.somanuals.com>

TV manuals search

<http://tv.somanuals.com>