

4200 SA

4700 TAA

4710 TBA

Oven

Operating Instructions

BEKO

English version of the 285.4305.10
booklet (12.11.2004)



**This product ,
is produced in modern facilities which
are respectful to environment,without
giving harm to the nature**

Dear Customer,

It is our ultimate desire that you achieve the best performance from our product, which has been passed through meticulous quality control checks and is manufactured in modern facilities.

To this effect, we recommend that you read the entire guide carefully before operating the product and keep it as a reference.

BEKO

www.beko.com.tr



This product has 10 years life span.
It means that said period is time interval to stock its spare parts to keep this product functional.

Contents

1	Technical specifications	Page 2	5	Process that you must do before calling services	Page 23
2	Safety precaution and important items	Page 3	6	Important do's and don't's	Page 24
3	Superior properties of product, practical and useful informations	Page 4			
	Superior features.....	4			
	Introducing the control panel.....	5			
	Using of oven part.....	6-10			
	Operating the grill.....	11			
	Operating the timer.....	12-16			
	Transport.....	17			
4	Maintenance and cleaning	Page 18			
	Lamp changing.....	19			
	Oven installing.....	20_22			

1 Technical specifications

(Classic model) (Multifunction)

	4200 SA	4700TBA/4700TAA
Outer width	594 mm	594 mm
Outer depth	550 mm	550 mm
Outer height	595 mm	595 mm
Inner width	450mm	445 mm
Inner depth	428 mm	410 mm
Inner height	337 mm	332 mm
Dimensions of installation setting		
Width	600 mm	600 mm
Depth	560 mm	560 mm
Height	600 mm	600 mm
Oven volume	65 lt.	61 lt.
Supply voltage	220 V ~ 50 Hz	220 V ~ 50 Hz
Grill output	1100/2300 W	1100/2300 W
Turbo heating element output		1800 W
Oven output	2400 W	2400 W
Ventilation motor (if available)	15 W (H type)	15 W (H type)
Lamp (if available)	15 W/25W	15/25 W
Cooking (In models with timer)	Electrical dijital programmable timer	

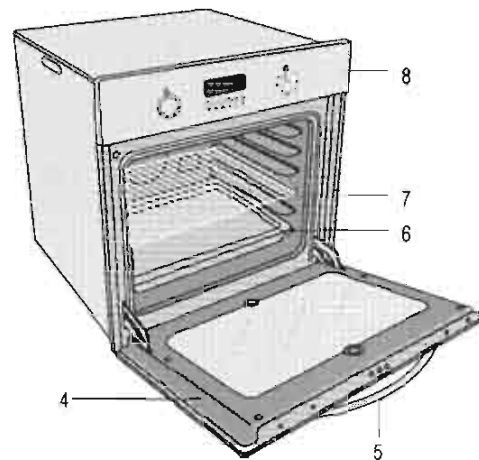

- 1. Upper heating element
- 2. Shelf positions
- 3. Turbo heater (behind steel plate)
- 4. Front door
- 5. Handle
- 6. Tray
- 7. Grill shelf
- 8. Control panel
- 9. Bottom heater (behind steel plate)
- 10. Air exit holes
- 11 Turbo motor (behind steel plate)
- 12. Lamp



The datas and values about this product are obtained in laboratory test conditions therefore these values can be changed according to the

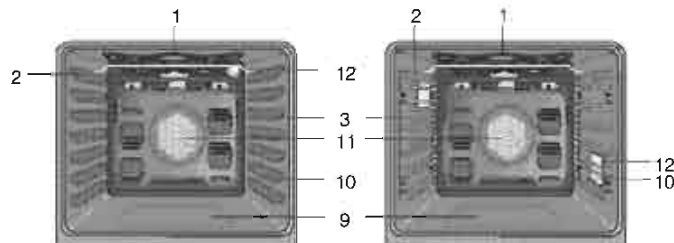

2 Safety precautions and important items

- * The current value of the fuse in your home shall be suitable to the current drawn by your cooker.
- * Before your appliance is connected to the mains electricity supply, check to ensure that the voltage and the frequency shown in the rating label corresponds with your power supply.
- * Before applying to authorized service, have the electrical wiring of your home ready for connection.
- * If the current value is less than 16 Amperes please have 16 A fuse with electrician.
- * The ground cable should always be performed by the manufacturer or its authorized service agent or a similarly qualified person. Our company shall not held responsible for any damage caused by the utilisation of the oven without ground cabling.
- * While locating your oven; do not squeeze the supply cord under the oven body or inside the oven door, because the cable isolation can be damaged.
- * If the supply cord is damaged, it must be replaced by the manufacturer or its service agent or a similarly qualified person in order to avoid a hazard.
- * In models with the timer:
Always adjust the timer during the first operation or after any interruptions of the electric supply. Otherwise, your oven will not operate.
- * Do not attempt to move the appliance by pulling the door and/or handles.
- * While the front door is open do not put any heavy object on it, and do not allow children to sit on it.
- * Accessible parts of the appliance will become very hot whilst the appliance is in use and until the appliance has cooled. Children should be kept away to avoid burns and scalds.
- * The packaging materials can cause danger for the children.
- * Do not forget to remove the packaging material near the tray and wire grill, and the polysthrene stuck to the front door glass.
- * Whilst the appliance is in use; avoid touching heating elements inside the oven as the accessible parts of the appliance will become very hot.
- * The appliance is not intended for use by young children or infirm persons without supervision.
- * The cooling fan will continue for a while after switching the oven off.
- * Always switch off the appliance from the mains when the appliance is not in use before cleaning or in the unlikely event of any probable product failure.
- * Ensure the appliance is switched off before replacing the lamp, to avoid the possibility of electric shock.
- * Immediately switch off the appliance from the mains if a crack is detected on the ceramic glass surface, in available models.
- * In models with Grill;
*Always use oven gloves when removing the grill rack and dishes from inside the oven when in use.
- *If, whilst cooking, steam produced comes into contact with cool surfaces on the outside of the appliance, it will condense and produce water droplets. This is quite normal and is not a fault. Wipe it with a dry cloth.

3 The superior features of your oven

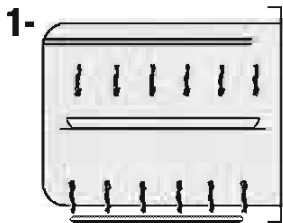

Conventional oven:

- In this position you can perform by operating the lower and upper heating elements.
- * The lower and upper heating elements ensures even cooking of both sides of your food.
- * You can sterilize your food (in preserved position) in your oven (refer to on how to sterilize/to make canned food).

In this position use 1 tray for cooking.

- ☒ In this position you can grill.

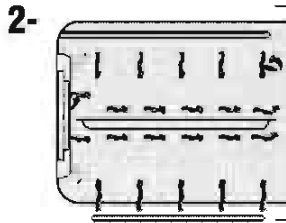

Fan assisted oven:

- ☒ Fan-assisted oven position
Your oven facilitates multi-functional utilization through its bottom heating element, top heating element and turbo fan. This system ensures that your food is cooked in the best possible manner by using the functions of your oven in a most efficient manner.

- ☒ In this position you can cook by operating the bottom resistance and turbo fan according to the characteristics of the meal you cook.

- ☒ You can use this position to fry to top of your meal better.

In these positions cook will one tray.

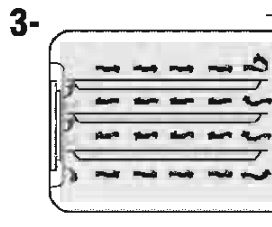

☒ Turbo oven:

In this position, you can perform the functions listed below by operating the turbo-heating element and turbo-fan.

- * In timer equipped models; timer and heater are connected serially. Therefore, to run heater, your timer must be adjusted (please refer timer guide).

- * For food that is cooked at the same temperature but has different cooking times, you should set the oven program according to food which has shortest cooking period Set the additional duration for the remaining foods after taking out the food that has first been cooked.

- * Energy conservation can be achieved with your oven by cooking two or three different foods at the same time, without mixing their odours.

- * Pierce the dough to prevent the space between the trays from becoming blocked through swelling while cooking pastries in the turbo position using three trays.

Introduction of control panel

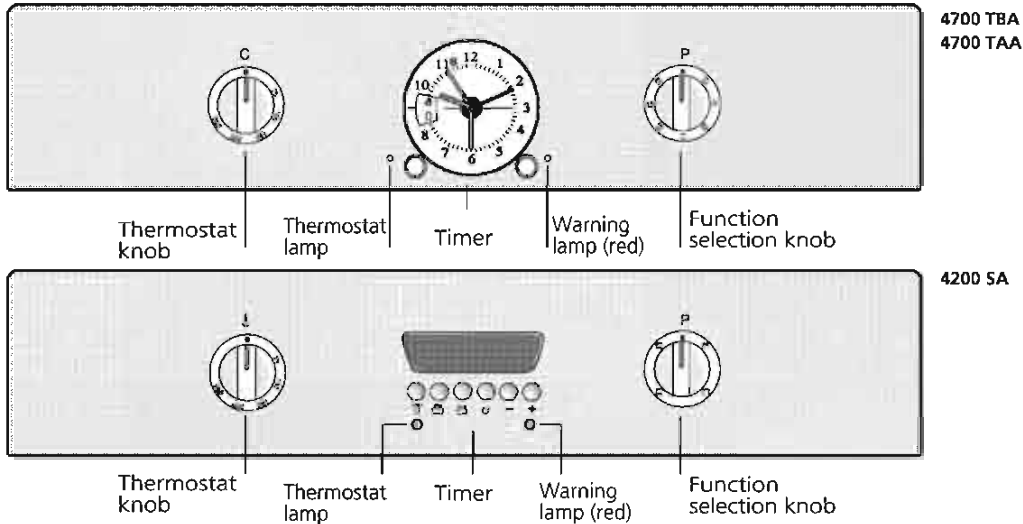

Warning lamp (red)

Indicates hob operation.

Thermostat lamp (yellow): If oven inner temperature exceeds your setted temperature, thermostat cuts off your appliance circuit and turn off lamp.

Operating the oven

Oven heating control knob

This knob is used together with the "function selection" knob. Select the desired stage with the "function selection" knob. Then rotate the "oven heating control" knob clockwise. The lamp and the heating elements in conjunction with the stage you have selected, or the fan will come on line. The temperature in the oven shall be sensed by the thermostat. The thermostat switches off the heating element and the thermostat light when the set temperature level is reached inside the oven. When the temperature falls below thermostat comes back on line and the thermostat light illuminates. This way, the set temperature level is maintained throughout the cooking period.

Function selection knob

This knob allows you to select functions and carry out checks. The functions and their stages are explained below. In order to operate the stages, you need to bring the "function selection" knob together with the "oven heating control" knob to the desired temperature degree and adjust the timer if there is. If your cooker has timer; refer to the

description of timer usage.

Using the oven's timer ; If your oven has a timer; You can do full automatic, semi automatic and manual cooking.

You should adjust the electronic timer prior to using oven.

The electrical current to the heating elements flows through the electronic timer. The timer must be set in order for the heating elements to go into operation. In automatic cooking; do not leave spoilable foods in the oven up to cooking start time.

- * The kinds of food you want to cook, Thermostat positions, Shelf positions and recommended cooking times are given at the cooking table.
- * Bring the thermostat knob to the position you want and function knob to the "☐" position.
- * Preheat the oven for 10 minutes with oven door closed.
- * Locate the meal you want to cook into the oven after preheating.
- * After cooking, bring the knobs to the "0" position.

The stages of the static oven function selection knob



Top and bottom heaters are on.



Bottom heater is on.





Top heater is on.



Means only the grill heater is on. You must bring to the heating control knob to the maximum temperature.

Cooking table

Foods	COOKING PAN	SHELF POSITIONS	THERMOSTAT POSITION	COOKING TIME (min)
		 Top and bottom	 Top and bottom	 Top and bottom
Short bread (Serves 8)	24-26 cm bread mould	2-3	170-180	25-35
Cake in mould (Serves 5)	18-22 cm cake mould	2-3	170-180	25-35
Cookie (Serves 12)	Cooking sheet	2-3	170-190	25-35
Flaky pastry (Serves 12)	Cooking sheet	2-3	180-190	25-35
Brioche	Cooking sheet	2-3	160-180	25-35
Pastry (Serves 8)	Big tray	2-3	190-200	40-50
Yeast dough (Serves 18)	Big tray	2-3	200-220	35-45
Biscuits (Serves 10)	Cooking sheet	2-3	170-180	20-30
Cake (Serves 20)	Big tray	2-3	170-180	25-35
Millefeuille pastry (Serves 8)	Big tray	2-3	200-210	25-35
Lasagne (Serves 8)	Lasagne dish	2-3	170-180	40-50
Pizza (Serves 8)	Big tray	2-3	200-220	30-35
Roast beef (Serves 8)	Roasting dish	2-3	250 (15min)*	110-120
Lamb shoulder (Serves 8)	Roasting dish	2-3	250 (15min)*	70-90
Roasted chicken	Roasting dish	2-3	250 (15min)*	60-70
Roasted turkey (5,5 kg)	Big tray	2-3	220 (25min)*	180-240
Fish	Roasting dish	2-3	200	15-25

*For roasted meats, the thermostat starts with the highest level and decreases to 150°C after 15 minutes.

Note: The values on the cooking table are the results we got in our laboratory.

The cooking table may be changed according to the quantity of products. You can find different tastes suitable for your harmony according to your cooking and using habits.

* If you want use the oven tray and want to make a cooking in another pot, prefer the right cooking adjusment because of your experiences.

* Don't use the pots that have heat perfecting or bad conduction and glass pots for making cooking pastry. The oven tray is the convenient off all.

* To use mold makes a better result for cooking cakes

* The cooking time may be changed according to the quantity of products.

* When putting the trays into the oven, be careful to put the trays on a level with others.

* Before cooking, make a first heating for 10 minutes , then put your food into oven.

* 5 minutes prior to the finishing time you can close the system for providing energy savings with non- opening the door.

After closing your oven; the ventilate goes on to work for a little to cool the electrical heaters on your oven.

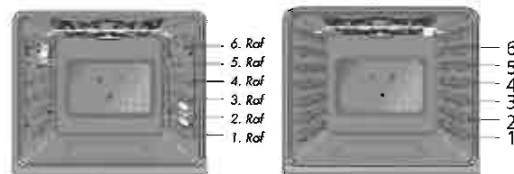

Operating the oven

Multi-function ovens

Oven heating control knob

This knob is used together with the "function selection" knob. Select the desired stage with the "function selection" knob. Then rotate the "oven heating control" knob clockwise. The lamp and the heating elements in conjunction with the stage you have selected, or the fan will come on line. The temperature in the oven shall be sensed by the thermostat. The thermostat switches off the heating element and the thermostat light when the set temperature level is reached inside the oven. When the temperature falls below thermostat comes back on line and the thermostat light illuminates. This way, the set temperature level is maintained throughout the cooking period.

Function selection knob

This knob allows you to select functions and carry out checks. The functions and their stages are explained below. In order to operate the stages, you need to bring the "function selection" knob together with the "oven heating control" knob to the desired temperature degree and adjust the timer if there is. If your cooker has timer; refer to the description of timer usage.

- * The kinds of food you want to cook, Thermostat positions, Shelf positions and recommended cooking times are given at the cooking table.
- * Bring the knobs to the position you want.
- * Preheat the oven for 10 minutes with oven door closed.
- * Locate the meal you want to cook into the oven after preheating.
- * After cooking, bring the knobs to the "0" position.

The stages of the multi- function oven function selection knob



Fan and oven lamp are on.



Fan and turbo heater are on.



Fan and bottom heater are on.



Top and bottom heaters are on.



Fan, top and bottom heaters are on.









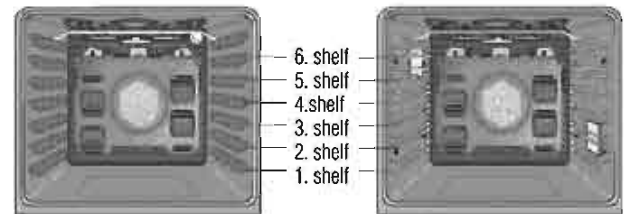







Fan and top heater are on.



Means only the grill heater is on. You must bring to the heating control knob to the maximum temperature.



Cooking table

Foods	COOKING PAN	SHELF POSITIONS			THERMOSTAT POSITION	COOKING TIME (min)		
		 Fan with ring heater	 Top and bottom	 Fan with Top and bottom		 Fan with ring heater	 Top and bottom	 Fan with Top and bottom
Short bread (Serves 8)	24-26 cm bread mould	3	2-3	3	170-180	15-25	25-35	20-25
Cake in mould (Serves 5)	18-22 cm cake mould	3	2-3	3	170-180	20-30	25-35	20-25
Cookie (Serves 12)	Cooking sheet	4	2-3	3	170-190	20-30	25-35	20-25
Flaky pastry (Serves 12)	Cooking sheet	4	2-3	3	180-190	20-30	25-35	20-25
Brioche	Cooking sheet	4	2-3	3	160-180	20-30	25-35	20-25
Pastry (Serves 8)	Big tray	4	2-3	3	 /  :180-190  /  :190-200	35-45	40-50	30-40
Yeast dough (Serves 18)	Big tray	4	2-3	3	 /  :190-200  /  :200-220	25-35	35-45	25-35
Biscuits (Serves 10)	Cooking sheet	4	2-3	3	170-180	15-25	20-30	18-22
Cake (Serves 20)	Big tray	4	2-3	3	170-180	20-30	25-35	20-25
Millefeuille pastry (Serves 8)	Big tray	4	2-3	3	200-210	20-30	25-35	20-25
Lasagne (Serves 8)	Lasagne dish	4	2-3	3	170-180	35-45	40-50	30-40
Pizza (Serves 8)	Big tray	4	2-3	3	200-220	20-30	30-35	25-30
Roast beef (Serves 8)	Roasting dish	4	2-3	3	250 (15min)*	90-120	110-120	100-110
Lamb shoulder (Serves 8)	Roasting dish	4	2-3	3	250 (15min)*	65-80	70-90	60-75
Roasted chicken	Roasting dish	4	2-3	3	250 (15min)*	55-65	60-70	50-60
Roasted turkey (5,5 kg)	Big tray	4	2-3	3	220 (25min)*	170-220	180-240	150-210
Fish	Roasting dish	4	2-3	3	200	15-20	15-25	15-20

*For roasted meats, the thermostat starts with the highest level and decreases to 150°C after 15 minutes.

- The values listed in the table are the results obtained from laboratory testing.
- You may find different flavours of the food according to your own cooking and usage practices.
- If you wish, you can add the time it takes to pre-heat the oven to the values listed in the table.

Shelf position (In fan with ring heater model)

For 3 trays : 2 - 4 - 6

For 2 trays : 4 - 6

For 1 trays : 4



Fan with ring heater



Top and bottom heater



Fan with Top and bottom heater

(IF AVAILABLE)

Note: The values on the cooking table are the results we got in our laboratory. The cooking table may be changed according to the quantity of products. You can find different tastes suitable for your harmony according to your cooking and using habits.

- * If you want use the oven tray and want to make a cooking in another pot, prefer the right cooking adjustment because of your experiences.
- * Don't use the pots that have heat perfecting or bad conduction and glass pots for making cooking pastry. The oven tray is the convenient off all.
- * To use mold makes a better result for cooking cakes
- * The cooking time may be changed according to the quantity of products.
- * When putting the trays into the oven, be careful to put the trays on a level with others.
- * Before cooking, make a first heating for 10 minutes , then put your food into oven.
- * 5 minutes prior to the finishing time you can close the system for providing energy savings with non- opening the door.
- After closing your oven; the ventilate goes on to work for a little to cool the electrical heaters on your oven.

The accessories on product (according to different models)

- * Grill; For grilling or putting saucepan when using another pot in oven.
- * Oven tray (grand); For cooking pastries.
- * Grill in tray; For grilling
- * Deep tray; For cooking the watery foods, recommending
- * Glass tray; For cooking the watery foods, recommending

Warning about glass tray

- * After cooking, don't put the glass tray that you out of the oven on wet and cold surface. Wait for it's cooling on a dry cloth.
- * Don't put the glass tray, that you take out of the refrigerator, into the hot oven.
- * Don't cut the metarial in glass tray with knife.
- * Don't clean the trays of the oven with metarials such as hard brush, dish fiber or knife. During cleaning, don't use metarials with sharp edge.
- * Do the cleanings of glass surface with special glass cleaning materials.

Sterilizing (canned)

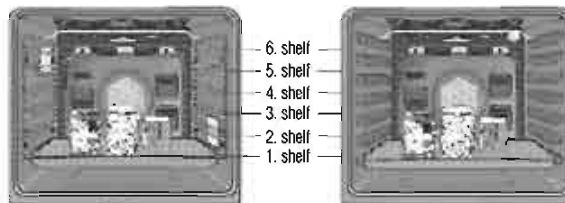

For this process firstly;

Put the tray to first shelf. Put 1/2 liter water at approximately 80°C into tray. Pay attention to the jars for being not contacted each other. Close the lid of your oven. Bring the "function selector" knob to "□" position. Then;

To sterilize fruits;

Turn "Oven heating remote-control device" knob between 150-200 °C (approximately 180 °C). After 45 minutes, bring "function selector" knob to "O" position. Take out of the oven after 30 minutes.

To sterilize vegetables;

Turn "Oven heating remote-control device" knob between 100-150°C. After 80-90 minutes, bring "function selector" knob to "O" position. Take out of the oven after 30 minutes.

Operating the grill

- Preheat the grill at  (grill setting) for approximately 5 minutes. For this period the heat control knob shall be at the **max** setting and the door must be closed.
- The indicator light will illuminate to show that the grill is switched on.
- Apply oil on the grill shelf to prevent meat from sticking on the bars.
- Put a tray on one of the bottom shelves in order to collect oil and for easy cleaning put some water in it.
- Use 4 or 5. shelf position for grilling.

➤ **Do not allow children to sit or stand on the oven door when the door is open.**

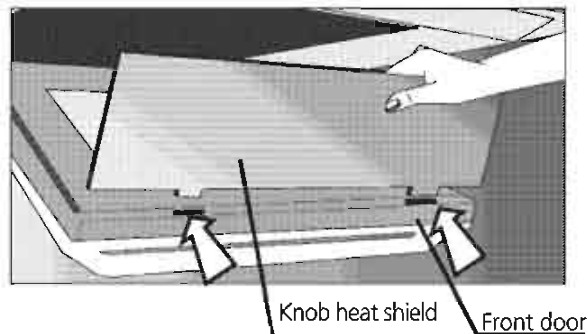

Using the Knob Heat Shield housing into Oven Door (for suitable models)

*** WARNING!** Do not grill when the front door is closed. Otherwise, oven parts may be damaged. After preheating, keep the front door half-open during grilling. In order to prevent the knobs of the control panel from heating up, center the knob shield plate between the front cover and the oven housing without leaving any gap.

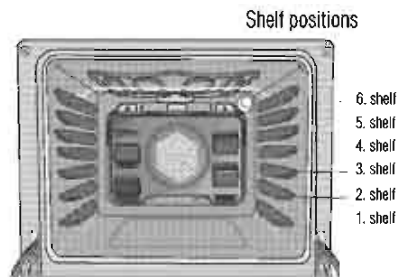

➤ Accessible part may become hot when the grill is in use. Don't allow children to be close.

If tray and thread grill are given with oven; use these when making grill.

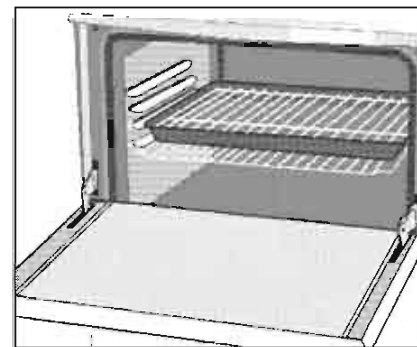

	Grill 	
	Shelf position	Cooking duration (min.) ¹
Lamb	4 - 5	12-15
Lamb chops	4 - 5	12-15
Beef		
Veal chops	4 - 5	15-25 (1)
Mutton chop	4 - 5	15-25 (1)

(1) Depending on the thickness

Operating the timer

(If your cooker has a timer)

Setting the electronic timer





You should adjust the electronic timer prior to using the oven. Otherwise your oven will not operate.

Your oven's electronic timer is operated similar to a normal timer. Your oven's electronic timer will be reset if the electrical power is cutoff. The electronic timer will run slow if the frequency of your supply power is not appropriate (This malfunction is not due to your timer itself. In such cases, you must re-adjust your timer).

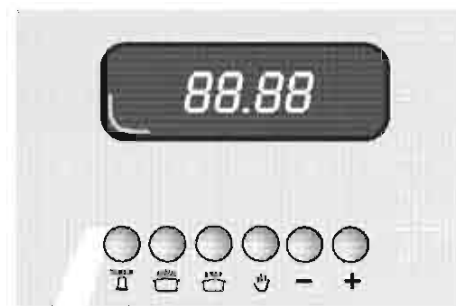
The following functions are available on your programmable timer.

1. You can adjust cooking durations between 00.00 - 24.00 hours.
2. You can use it as a chiming alarm between 00.00 - 24.00 hours.
3. You can run a cooking program for fully-automatic, semi-automatic and non-programmed (manual) cooking. (The heating elements inside the oven are tied into the electronic timer and are programmable.



-  : Programming button for warnings
-  : Cooking period adjustment button
-  : Cooking terminating time adjustment button
-  : Manual adjustment button (non-programmed cooking)
- +** : Time adjustment buttons

Please note

- * The timer controls the oven heating element only and the current time of day must be set before the oven will function.
- * If the timer has been set to an automatic or semi automatic programme, the daily time cannot be readjusted, the semi or auto programme, must be cancelled. See **“How to cancel automatic programme”**.

How to set the current time of day

The clock display uses a 24 hour configuration
8:30 pm = 20:30

- * Press and hold **“^{TIMER} 🔔 🍲”** buttons at the same time.
- * Press **“+”** button to increase or **“-”** to decrease, the time.
- * Adjust using the **“+”** or **“-”** buttons to set the current time. If **“Auto”** flashes, See **“How to cancel automatic programme”**.
- * Release the buttons, the clock will now start.

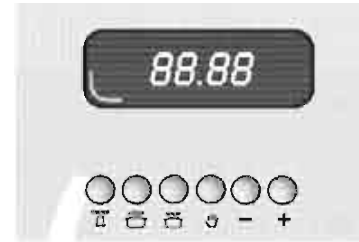

Manual cooking (or to cancel a programme)





- * Press **“🍲”** button, press the **“-”** button, until 0:00 is displayed.
 - * Press the **“👉”** button.
- The **“auto”** and **“🍲”** sign will disappear.
- * Set the oven knob to the required cooking temperature and function selection knob to the desired position.
 - * The oven will switch on. The Amber oven indicator will light.
 - * At the end of cooking, switch off by resetting the oven thermostat knob to the **“●”** (off) mark.

Note:

The timer will not switch off the oven. To switch off the oven turn the oven thermostat and selection knob to the **“●”** (off) mark.

Semi-automatic programming

This mode allows a manual start time but an automatic switch off time, which is very useful to prevent the over cooking of food.



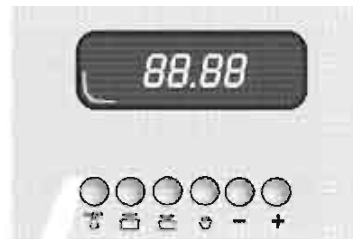



- * Press "  " button. Press the "+" (or "-") buttons, to set the cooking time duration (Auto and "  " will be displayed) in minutes.
- * Set the oven thermostat knob to the required temperature and function selection knob to the desired position.
- * The oven will switch on and cooking will commence.
- * The programmer will switch the oven off at the end of the preset cooking time. "Auto" will flash and the timer alarm will beep. To turn off the alarm press the "  " button.
- * Set the oven thermostat knob to the "●" (off) mark.
- * Press "  " button to cancel "Auto".



Automatic programming

The programmer will switch the oven on and off at the required times.

Ensure the oven thermostat is in "●" (off) position, and the correct time has been set.

- * Press the "  " button to cancel any program stored. (Auto and "  " symbol will not be displayed)
- * Press the "  " button and press "+" (or "-") buttons, to set the stop time required. ( and auto will be displayed)
- * Press the "  " button and press "- " button to set the cooking time (duration) required.
- * Set the oven knob to the required cooking temperature and place your food in the oven.
- * The oven will switch on at the required time, cook the food and switch off at the predetermined time.
- * At the end of cooking the alarm will beep and "Auto" will flash. To turn off the alarm press the "  " button.

Press “” button to cancel “Auto”.

* Set the oven thermostat and function selection knob to the “” (off) mark.

Note: Make sure you follow food manufacturer’s instructions.

* Press the “” button to view the remaining cooking time during cooking.

Timer alarm

The timer alarm can be adjusted to beep between 0 and 23 hours 59 minutes. i.e. as a minute minder to remind you to switch off a hob heating zone.

* Press the “” button, press the “+” or “-” buttons to set the desired alarm time.

* The timer alarm will beep at the end of the time period.

* To turn off the alarm press the “” button.

How to cancel automatic programme

* Press “” button, press “-” button until the clock display shows 0:00

* Press “” button, the programme has now been cancelled.

* The current time can then be reset.



(If Available)



Activating the Demo mode/Key lock

The Demo mode is conditionally applicable as key lock. If it is activated, the relays remain open all the time.



Thus timer can be operated as usual but the connected appliance or appliance module remains unaffected. This means that your child can select the cook program but the program will not be activated and thus the connected appliance or appliance module will not be switched on.

To activate the demo mode/key lock:

1. Make sure that the clock is in manual mode and cancel any active programs.



2. Hold the “” button and the “” button down simultaneously for approx. 8 seconds. The display will read “ON”.

3. Press the “+” button.

The display reads “OFF” and the “” symbol appears. After approx. 5 seconds the time reappears next to the “” symbol. The key lock is now activated.

To deactivate the demo mode/key lock:

1. Make sure that the clock is in manual mode and cancel any active programs.

2. Hold the “” button and the “” button down simultaneously for approx. 8 seconds. The display will read “OFF”.

3. Press the “+” button.

The display reads “ON” and the “” symbol disappears. After approx. 5 seconds the time reappears on the display. The key lock is now deactivated.

Using the mechanical timer

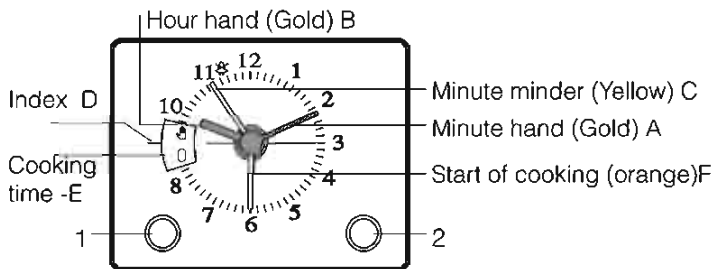

- 1: To set minute minder (Time of day pull)
- 2: To set cooking time (start of cooking pull)

Clock : Shaft ① Hands ① & ②

To set the time of day pull and then turn the shaft ① clockwise. Set the hands ① & ② in the right position of the time of day.

Minute minder: Shaft ① Hands ③

➔ Mechanical bell after a maximum duration of 55 minutes. To set the minute minder turn the shaft ① clockwise and anticlockwise and put the hand ③ in front of the selected duration.

➤ At the end of the timing, the bell rings and stops automatically after around 3 minutes. The bell can be stopped manually by turning the shaft ① to put the hand ③ on the position STOP ⌘ .

Cooking Time : Shaft ② Disk ④

➔ Immediate start of cooking and automatic stop of cooking.

➤ Maximum duration: 180 minutes (3 hours).

➤ To set the cooking time, turn the shaft ② clockwise and put the graduation of the disk ④ in front of the ④ index ④ of the dial.

➤ The end of cooking is indicated by a bell which stops automatically after 3 minutes. The disk ② indicates "0" (off position). This bell can be stopped manually by turning the shaft ② in order to put the "0" of the disk in front of the index .

Cooking Start Time : Shaft ② Hand ⑤

➔ Cooking completely automatic with delayed start and automatic stop of cooking.

➤ Maximum delayed start : 12 hours.

➤ Before setting the cooking start time, ensure that the "0" of the disk ④ is positioned in front of the index ④ of the dial.

➤ To set the cooking start time, pull and turn the shaft ② in both directions (clockwise and anticlockwise) and put the hand ⑤ in front of the cooking start time. When this operation is over set the cooking time as above mentioned.

Future transportation

*** Transporting the oven;**

Store the oven's original box. Transport the oven in its original carton. Follow the guidance marks that are printed on the carton.

To prevent the wire grill and tray inside the oven from damaging the oven door, place a strip of cardboard or paper 1 to 1.5 cm in thickness onto the inside of the oven door that lines up with the position of the trays. Tape the oven door to the side walls.

*** If you do not have the original carton;**

Take the necessary precautions in order to prevent the exterior panels, and the glass surfaces of the oven from being damaged.

Pack the oven in bubble wrap or thick cardboard and tape it securely in order to prevent damage during transportation.

The oven must be transported upright. Do not place other items on the top of the cooker.

4 Maintenance and cleaning

Turn off the mains switch before cleaning.

* Before switching on again ensure that all controls are in the OFF position.

* Never clean the cooker surface by using materials such as hard brushes, steel pads or knives, which can easily scratch the enamelled and stainless steel surfaces.

Control panel

Wipe over the control panel with a damp cloth and polish with a dry cloth. Do not use oven cleaners or aerosols, scouring pads or abrasive powder for cleaning the plastic knobs as damage will occur. Do not attempt to remove any of the control knobs from the panel as this may cause damage and is a safety hazard.

* Special cleaners that are commercially available may be used after carefully reading the warning labels written on them. Do not use cleaning agents containing acid or chlorine. Cleaning can be accomplished using a soft piece of cloth wetted with soapy water or with commercially available special surface cleaners and a soft piece of cloth. Especially use liquid paste or cream type cleaners.

Warning!

Never clean the inside of the oven and trays with hard brushes, steel pads or knives.

Do not use cleaning agents containing acid or chlorine on **stainless steel surfaces and the handle**. Cleaning can be accomplished using a soft piece of cloth wetted with soapy water or with commercially available special surface cleaners and a soft piece of cloth.

Oven interior

Before switching on again ensure that all controls are in the OFF position. Take out all trays and the grill out of the oven. Clean out the interior with a piece of moist, soapy cloth. Then, clean it once more with a wet piece of cloth and let it to dry.

Do not use dry powder agents for cleaning.

Special cleaners that are commercially available may be used after carefully reading the warning that are written on the labels.

* **Catalytic-enamelled models;** The oven interior of this model is coated with catalytic enamel since the catalytic enamel cleans itself, you do not have to perform an extra cleaning after the cooking operation.

If your oven obtains steel rack; To clean the steel rack, unscrew the 4 screws. After cleaning operation, assemble the steel rack to the oven body again.

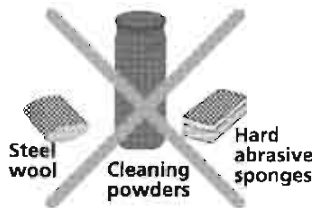

Do not use these materials for cleaning

Lowering the heating element

Warning!

Make sure that the heating element is sufficiently cool before you start cleaning.

Warning!

Never switch on the heating element or place any weight on it when the heating element is in the lowered position.



1. Unlock the heating element by turning the screw at the ceiling of the oven cavity.

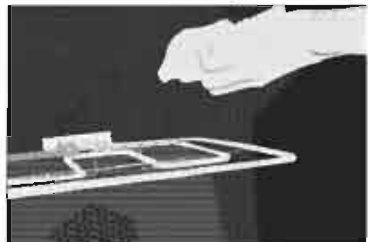

2. After cleaning, move the heating element upward and screw it to the ceiling of the oven cavity.

Replacing the oven lamp:

1. Unplug the power cable.
2. Then, remove the protective glass cover of the lamp inside your oven by turning it counterclockwise.
3. Then, remove the bulb by turning it counter-clockwise.
4. After installing the correct bulb obtained from an Authorized Service, reinstall the protective glass of the lamp.

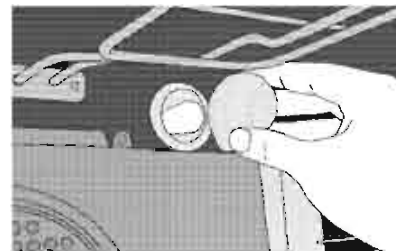

For the square-shaped lamp models:

There are 2 square-shaped lamps at right and left side of the oven inside. Both lamps are on and off at the same time.

Replacing the Oven Lamp

Disconnect the appliance from the supply. Take out screws on the side shelf. Take out Lens of the oven lamp by means of the flat screwdriver. Replace defective lamp with the new one.

Reinstall lens and side shelf. Lamp type is 220-230V, 15/25W E14, T300°C

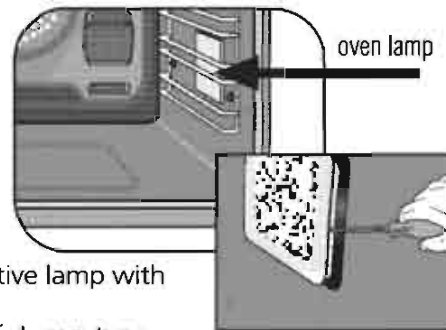

Oven-Mounting and Warnings

Things to Pay Special Attention to Regarding the Electrical Connection

- Have the device's electricity connected by a certified electrician.
- This device belongs to the primary protection class and must be operated only via a grounded electrical connection.
- The device must be installed in such a way as to prevent contact with the electrical connections.
- If, together with the product, a main cord is not provided, or if a main cord is provided without a plug: a circuit breaker must be used with the product such that a 3 mm gap stands between all contacts capable of severing the electricity among all of the poles on the product.
- During product installation, ensure that no more than one of its side surfaces, if necessary, stands close to a high wall or cupboard. In wall ovens that come with the pyrolytic cleaning function, a minimum distance of 30 mm must be left between the oven's front panel and furniture or wall of the building.
- For the safe and reliable operation of the device, it is recommended that the back wall of the compartment into which it is installed be open.
- The constituent materials of the installation cavity must be able to withstand a temperature of 100°C. This is especially applicable to and important for wooden materials, coverings that adhere to edges, plastic surfaces, applied adhesives, paints and polishes. Furniture in the device's immediate vicinity must be able to withstand a temperature of at least 70°C.

Matters to Pay Special Attention to Regarding the Oven's Installation Cavity!

- Prior to installing the device, the cutting of furniture and countertops or renovation activities need to have been completed. Sawdust and debris on the surfaces of furniture near which the product is to be installed must be cleaned. Otherwise the device's cord and electrical connection could become damaged.
- For the furniture cavity dimensions and the placement of the

device, see the diagram.

- If a drawer is to be located underneath the device, a separator panel must be placed between the device and the drawer.
- Because the device is installed flush with the back wall, the electrical socket, except for the device's mounting area, must be located in an easily accessible place.
- For integrated ovens, the electrical connections and installation of the stove control buttons must take into account that the stove control buttons will be on the front panel of the oven.
- Ensure that the furniture cabinet of the kitchen countertop has been stabilized/immobilized.
- For the oven's proper ventilation, there must be a distance of up to 35 mm between intervening furniture surfaces and the back wall.

Matters to Pay Special Attention to Regarding the Positioning of the Oven

- By pushing the device, insert it fully into the furniture compartment.

Attention! During insertion, ensure that the electrical cable is not broken or pinched.

- For air circulation, some empty space must remain between the walls and the compartment into which the device is installed. For this reason, prior to stabilizing/immobilizing the device, try to center it within the cabinet.
- After positioning the device, stabilize/immobilize it with screws as shown in the diagram.
- The space between the upper surface and the device must not be blocked/occupied by any object.

When removing the oven from the furniture cavity,

- Disconnect the device's electricity.
- Unscrew the stabilization/immobilization screws.
- Remove the device by slowly lifting and pulling out.

Installing your oven

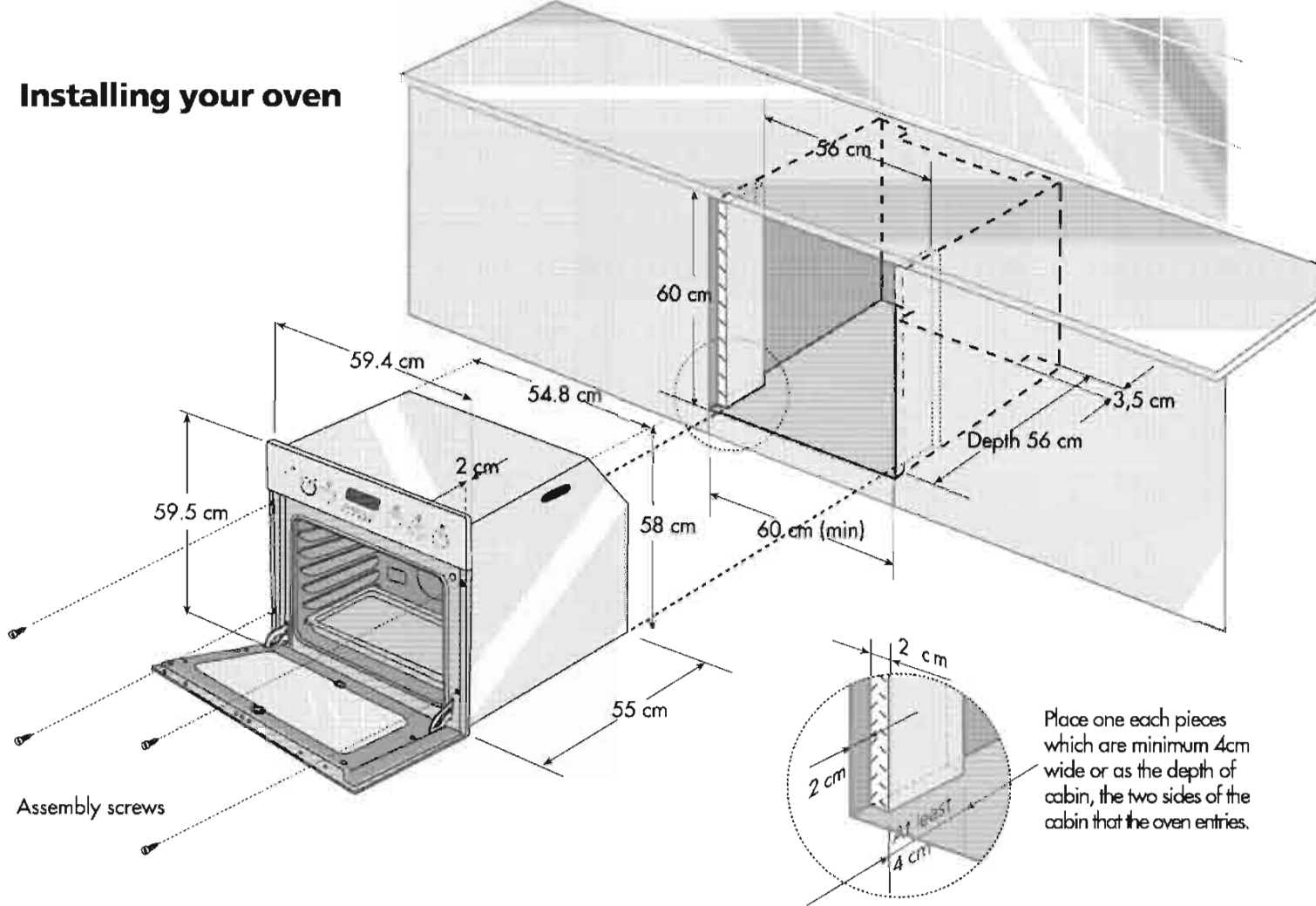

Positioning of the Oven

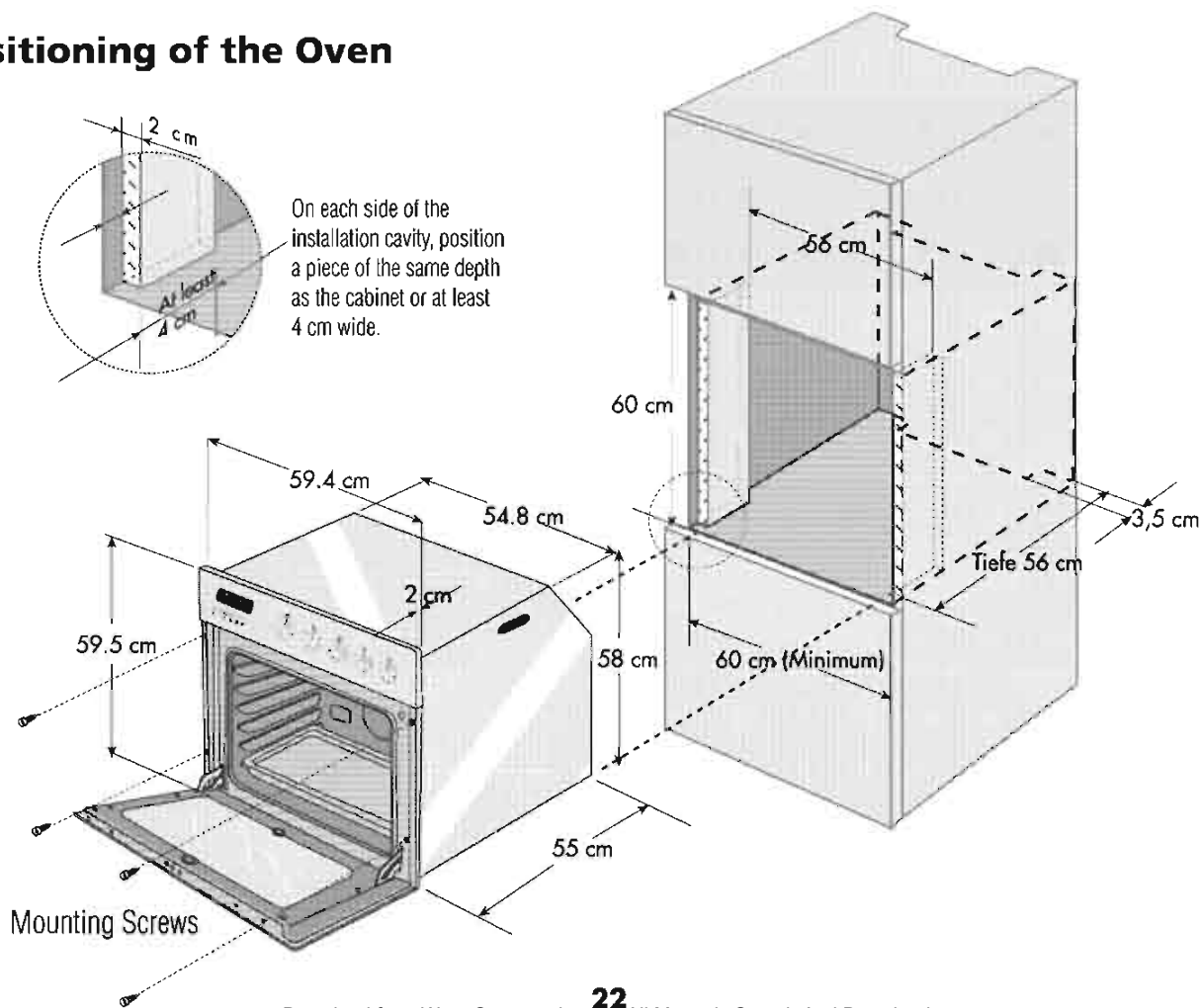

5 Process that you must do before calling service

Before calling service, please do the controls below



If the oven is not heating;

Your product's plug can be not connected to grounded socket. Fuse can be off. In the models with clock, clock can be not set up.



Is temperature device mode with oven heating remote-control device knob?



Is the fuse of socket that the oven's connected or main fuse off?



If your oven is not working;

In multi -system oven, is function selector knob set up to necessary functions?



If internal illumination lamp is off;

Is there electricity? Can the lamp be out of order? If its out of order, change it by looking guide.



Cooking (if top and bottom part is not cooking equal);

Control the temperature value, time of cooking and shelf positions according to using guide.



If there is still problem in the product; please call authorized service.

6 Important do's and don'ts

Don'ts

- * Don't leave children unsupervised where the cooker is installed and in use as all surfaces will get hot.
- * Don't allow children to sit or stand on the oven door when open in its down position or allow any person to sit or stand on part of the appliance.
- * Don't use large preserving pans or fish kettles across two hotplates as this will damage the hob.
- * Don't store items above the cooker that children may attempt to reach.
- * Don't use water to extinguish oil or fat fires.
- * Don't use the cooker as space heater, dryer.
- * Don't heat up unopened food containers as pressure can build up causing the container to burst.
- * Don't place flammable or plastic items on or near the hob, and never place wet cloths etc. on the hob to dry.
- * Don't use biological washing powder or harsh abrasives or chemical cleaners for cleaning the oven inner panels.
- * Don't leave a hotplate on for long periods when not covered by a pan. Spillage should be dealt with as soon as it occurs, taking due care as the hob surface

may be hot. Any spillage left on the surface after cooking should be cleaned off before the hob is switched on again to prevent baking on.

- * Don't store flammable materials, aerosol etc. In adjacent cabinets.
- * Don't cover ventilation slots in any way.
- * Don't use the handles to hang towels, dishcloths etc.
- * Don't use round-bottomed (traditional) woks. Use flat-bottomed types.
- * Don't place dishes, pans, trays directly onto the oven compartment base.
- * Don't cover oven shelves with aluminium foil as the air circulation in the oven will be disrupted.
- * Don't line the grill pan with aluminium foil.
- * Don't attempt to grill with the door closed.
- * Don't use the grill to warm plates.

Do's

- * Have your appliance installed by a qualified engineer or a technician.
- * Make sure you understand the controls prior to using your appliance.
- * Ensure that no flammable materials are adjacent to the appliance as the sides of the appliance become hot during

operation.

- * Keep children away from the cooker at all times when in use as surfaces will get extremely hot.
- * Always turn off the electricity supply at the wall switch before cleaning.
- * Check all controls on the appliance are switched off after cooking.
- * Keep all ventilation slots clear of obstructions.
- * Remember that the oven and the utensil will be very hot when in use.
- * Note that times and temperatures in this book are for guidance only.
- * Ensure meat and poultry is thoroughly defrosted before cooking.
- * Take care when removing utensils from the grill as they may be hot.
- * Take care when opening the door. Let steam and hot air escape before removing the food.
- * Use quality oven gloves for removing hot food utensils from the oven/grill.
- * Select the correct shelf position before turning the oven or grill on.
- * Clean your cooker regularly, ideally after each use.
- * Allow the appliance to cool before cleaning.
- * Always refer servicing to a qualified appliance service engineer.

Free Manuals Download Website

<http://myh66.com>

<http://usermanuals.us>

<http://www.somanuals.com>

<http://www.4manuals.cc>

<http://www.manual-lib.com>

<http://www.404manual.com>

<http://www.luxmanual.com>

<http://aubethermostatmanual.com>

Golf course search by state

<http://golfingnear.com>

Email search by domain

<http://emailbydomain.com>

Auto manuals search

<http://auto.somanuals.com>

TV manuals search

<http://tv.somanuals.com>