

**BUILT-IN OVEN**

**OIM 22500 P**

**BEKO**



## **Please read these instructions before installation or using your appliance!**

Dear Customer,

By purchasing this product you have chosen an appliance of advanced technology and high quality.

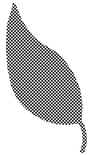

The appliance was produced in modern facilities which meet all environmental standards.

The instructions will help you to operate the appliance quickly and safely.

- Upon delivery, please check that the appliance is not damaged. If you note any transport damage, please contact your point of sale immediately and do not connect and operate the appliance!
- Before you connect and start using the appliance, please read this manual and all enclosed documents. Please note in particular the safety instructions.
- Keep all documents so that you can refer to the information again later on. Please keep your receipt for any repairs which may be required under warranty.
- When you pass on the appliance to another person, please provide all documents with it.



# Table of Contents

---

<b>1</b>	<b>General information</b>	<b>4</b>	Initial heating .....	15		
	Overview .....	4	<b>5</b>	<b>How to Operate the Oven</b>	<b>16</b>	
	Technical Data .....	5		General information on baking, roasting and grilling .....	16	
	Accessories supplied with the unit .....	5		How to use the electric oven .....	16	
<b>2</b>	<b>Safety Instructions</b>	<b>7</b>		Operating modes .....	18	
	Explanation of safety instructions .....	7		How to operate the oven control unit	21	
	Basic safety instructions .....	7		How to use the program lock .....	23	
	Safety for children .....	8		Cooking times table .....	23	
	Safety when working with electricity .	8		How to operate the grill .....	26	
	Intended use .....	9		Cooking times table for grilling .....	26	
	Disposal .....	9		How to use the alarm clock .....	27	
	Packaging material .....	9	<b>6</b>	<b>Maintenance and Care</b>	<b>28</b>	
	Old equipment .....	9		General information .....	28	
	Future transportation .....	9		Cleaning the control panel .....	28	
<b>3</b>	<b>Installation</b>	<b>10</b>		Cleaning the oven .....	28	
	Before installation .....	10		Removal of oven door .....	29	
	Installation and connection .....	12		Taking off the door inner glass .....	30	
<b>4</b>	<b>Preparation</b>	<b>14</b>		Replacing the oven lamp .....	31	
	Tips for saving energy .....	14	<b>7</b>	<b>Troubleshooting</b>	<b>32</b>	
	Initial operation .....	14		<b>8</b>	<b>Guarantee and Service</b>	<b>33</b>
	Setting the time .....	14				
	First cleaning of the appliance .....	15				

# 1 General information

## Overview

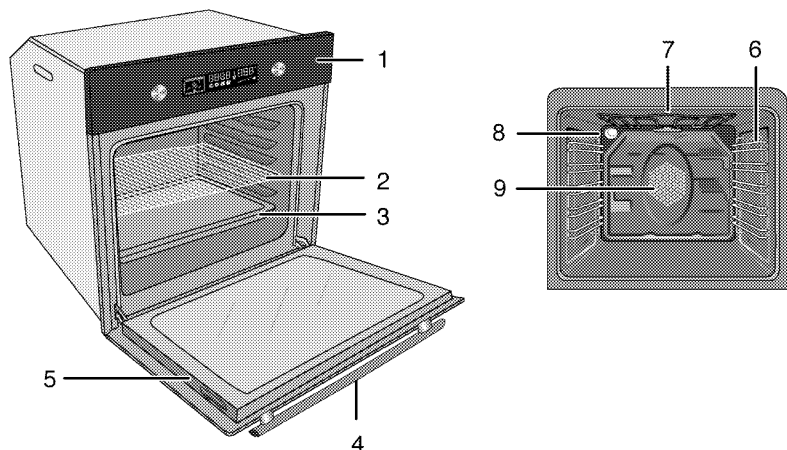

- |   |               |   |                                |
|---|---------------|---|--------------------------------|
| 1 | Control panel | 6 | Shelf positions                |
| 2 | Wire shelf    | 7 | Top heating element            |
| 3 | Tray          | 8 | Lamp                           |
| 4 | Handle        | 9 | Fan motor (behind steel plate) |
| 5 | Door          |   |                                |

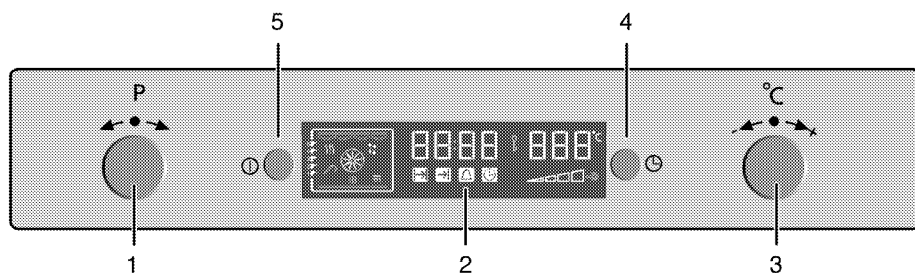

- |   |   |   |               |
|---|---|---|---------------|
| 1 | Program selection knob                    | 4 | Menu button   |
| 2 | Digital timer                             | 5 | ON/OFF button |
| 3 | Temperature-time increase/decrease button |   |               |

## Technical Data

Voltage/frequency	220-240 V ~ 50 Hz
Total electric consumption	3.1 kW
Fuse protection	min. 13 A
Cable type / cross section	H05VV-FG 3 x 1,5 mm <sup>2</sup> or equivalent
Cable length	max. 2 m
Outer dimensions (height/width/depth)	595 mm/594 mm/567 mm
Installation dimensions (height/width/depth)	**590 or 600 mm/560 mm/min. 550 mm
Main oven	<b>Multifunction oven</b>
Energy efficiency class <sup>#</sup>	A
Inside illumination	15/25 W
Grill power consumption	2.2 kW

<sup>#</sup> Basis: In electrical ovens, the data on energy labels are in conformity with EN 50304. Values were determined under standard load and convection/hot air (if available). Heating mode with an energy efficiency rating specified by EN 50304 is determined in accordance with below priority order depending on functions (modes) availability on the product. 1- Eco fan heating, 2-Slow cooking, 3-Fan heating (hot air), 4-Top and bottom heat with convection air, 5-Top and bottom heating.

\*\* See *Installation*, page 10.

## Accessories supplied with the unit



### Important

Accessories supplied can vary depending on the product model. All the accessories described in the user manual may not exist on your product.

### Baking tray

Can be used for pastries, frozen foods and big roasts.

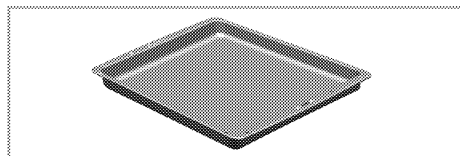

### Deep roasting tray

Can be used for pastries, big roasts, foods with liquid content and during grilling as dripping pan.

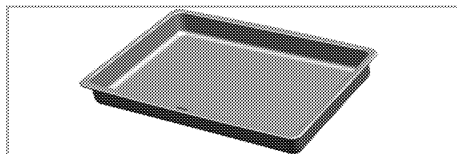

### Pastry tray

It is recommended for pastries such as cookies and biscuits.

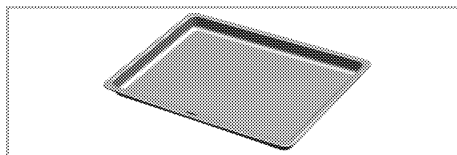

### **Small baking tray**

Can be used for small portions. This baking tray is placed onto the wire shelf.

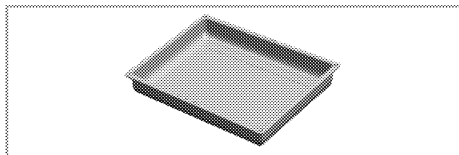

### **Wire shelf**

Can be used for roasting and as deposit for baking, roasting and casserole dishes.

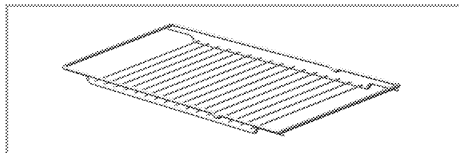
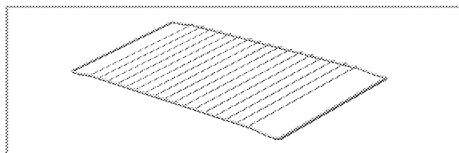

### **Small wire shelf (for use with supplied tray)**

Can be used for grilling and fat collection within tray to prevent the oven from getting dirty.

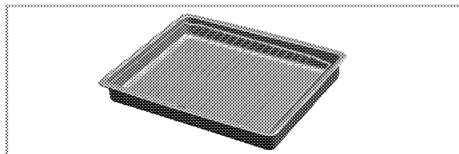

### **Proper positioning of the wire shelf and tray on sliding shelves**

It is important to position the grill and/or dripping pan on the wire shelves correctly. Slide the grill or the dripping pan completely between the 2 rails and make sure it is stable before putting a dish on it (Please see the following figure).

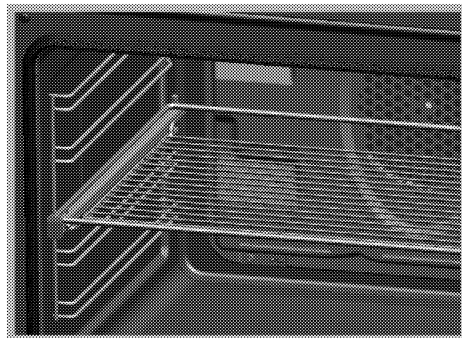
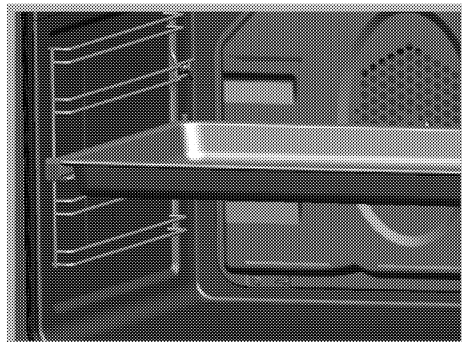

## 2 Safety Instructions

---

### Explanation of safety instructions

The following types of safety instructions and information are used in this manual. They can be distinguished by the symbol and the initial signal word.

---



#### **DANGER**

##### **High risk of personal injury.**

Non-observance may or will cause serious injuries or death.

---



#### **CAUTION**

##### **Risk of personal injury.**

Non-observance may or will cause minor or medium injuries.

---



#### **NOTICE**

##### **Risk of material damage.**

Non-observance may or will cause damage on the appliance or other objects.

---



#### **Important**

##### **Tip for the user.**

Useful information on how to use the appliance. No injury risk information.

---

### Basic safety instructions

- The manufacturer reserves its right to make changes in the technical specifications in order to improve the appliance quality without any prior notice. Figures included in this manual are for schematic

purpose only and may not match exactly with your appliance. Values stated on the markings of the appliance or in other printed documents supplied with the appliance are obtained under laboratory conditions as per relevant standards. These values may vary according to the usage of the appliance and ambient conditions.

- This appliance is not intended for use by persons (including children) with reduced physical, sensory or mental capabilities, or lack of experience and knowledge, unless they have been given supervision or instruction concerning use of appliance by a person responsible for their safety.

Children should be supervised to ensure that they do not play with the appliance.

- "An additional protective means to avoid contact with the oven door is available. This part should be fitted when young children are likely to be present."
- Never use when judgement or coordination is impaired by the use of alcohol and/or drugs.
- Do not operate the appliance if it is defective or shows any visible damage.
- Do not carry out any repairs or modifications on the appliance. However, you may remedy some malfunctions; see *Troubleshooting, page 32*.



- Be careful when using alcoholic drinks in your dishes. Alcohol evaporates in high temperatures and may cause fire since it will catch fire when it gets in contact with hot surfaces.
- Do not heat closed food containers and glass jars. Pressure that may build-up in the jar can cause it to burst.
- Ensure that no flammable materials are adjacent to the appliance as the sides become hot during use.
- Do not place baking trays, dishes or aluminium foil directly onto the bottom of the oven. The heat accumulation might damage the bottom of the oven.  
Keep all ventilation slots clear of obstructions.
- Appliance may be hot when it is in use. Never touch the hot burners, inner sections of the oven, heating elements etc. Keep children away!
- Always use heat-resistant gloves when putting or removing the dishes into/from your oven.
- Don't use the cooker with front door glass removed.
- Rear surface of the oven gets hot when it is in use. Gas / Electric connection should not touch the rear surface, otherwise the mains cable may get damaged. Do not trap the mains cable between the hot oven door and frame. Do not route the mains cable over the hot cooking section. Otherwise, cable insulation may melt and cause fire as a result of short circuit.

- Check all controls on the appliance are switched off after use.



### Important

For the warranty to be valid, the appliance must be installed by a qualified person in accordance with current regulations.

---

## Safety for children

- Accessible parts of the appliance will become hot whilst the appliance is in use and until the appliance has cooled, children should be kept away.
- Accessible parts may be hot when the grill is in use. Young children should be kept away.
- The packaging materials will be dangerous for children. Keep the packaging materials away from children. Please dispose of all parts of the packaging according to environmental standards.
- When the door is open, do **not** load any heavy object on it and do **not** allow children to sit on it. It may overturn or door hinges may get damaged.

## Safety when working with electricity

- Any work on electric equipment and systems may only be carried out by authorized qualified persons.
- Even if the oven is off, the cooling fan continues working for a while after turning off the oven.
- In case of any damage, switch off the appliance and disconnect it

from the mains supply by removing the fuse or switching off the circuit breaker.

- Ensure that the fuse rating is correct.

## Intended use

The appliance is designed for domestic use only. Commercial use is not admissible.

This appliance should not be used for warming the plates under the grill, hanging towels and dish cloths etc. on the handles, drying and the heating purposes.

The manufacturer shall not be liable for any damage caused by improper use or handling errors.

## Disposal

### Packaging material



#### **DANGER**

#### **Risk of suffocation by the packaging materials!**

Keep children away from the packaging materials.

The packaging material and transport locks are made from materials that are not harmful to the environment. Please dispose of all parts of the packaging according to environmental standards. This is beneficial to the environment.

### Old equipment



This appliance bears the selective sorting symbol for waste electrical and electronic equipment (WEEE). This

means that this appliance must be handled pursuant to European Directive 2002/96/EC in order to be recycled or dismantled to minimize its impact on the environment. For further information, please contact your local or regional authorities.

Electronic appliances not included in the selective sorting process are potentially dangerous for the environment and human health due to the presence of hazardous substances.

### Future transportation



#### **NOTICE**

Do not place other items on the top of the appliance. The appliance must be transported upright.

Store the appliance's original box and transport the appliance in its original carton. Follow the guidance marks that are printed on the carton.



#### **Important**

Verify the general appearance of your equipment by identifying possible damage during the transportation.

To prevent the wire shelf and tray inside the oven from damaging the oven door, place a strip of cardboard onto the inside of the oven door that lines up with the position of the trays. Tape the oven door to the side walls.

### **If you do not have the original carton**

Pack the appliance in bubble wrap or thick cardboard and tape it securely in order to prevent damage during transportation.

## 3 Installation

### Before installation

The appliance is intended for installation in commercially available kitchen cabinets. A safety distance must be left between the appliance and the kitchen walls and furniture. See figure (values in mm).

- Surfaces, synthetic laminates and adhesives used must be heat resistant (100 °C minimum).

- Kitchen cabinets must be set level and fixed.
- If there is a drawer beneath the oven, a shelf must be installed between oven and drawer.
- The following installation drawings are representational and may not match exactly with your appliance.
- A minimum distance of 30 mm must be provided to the side cabinets in case of self-cleaning ovens (pyrolysis).

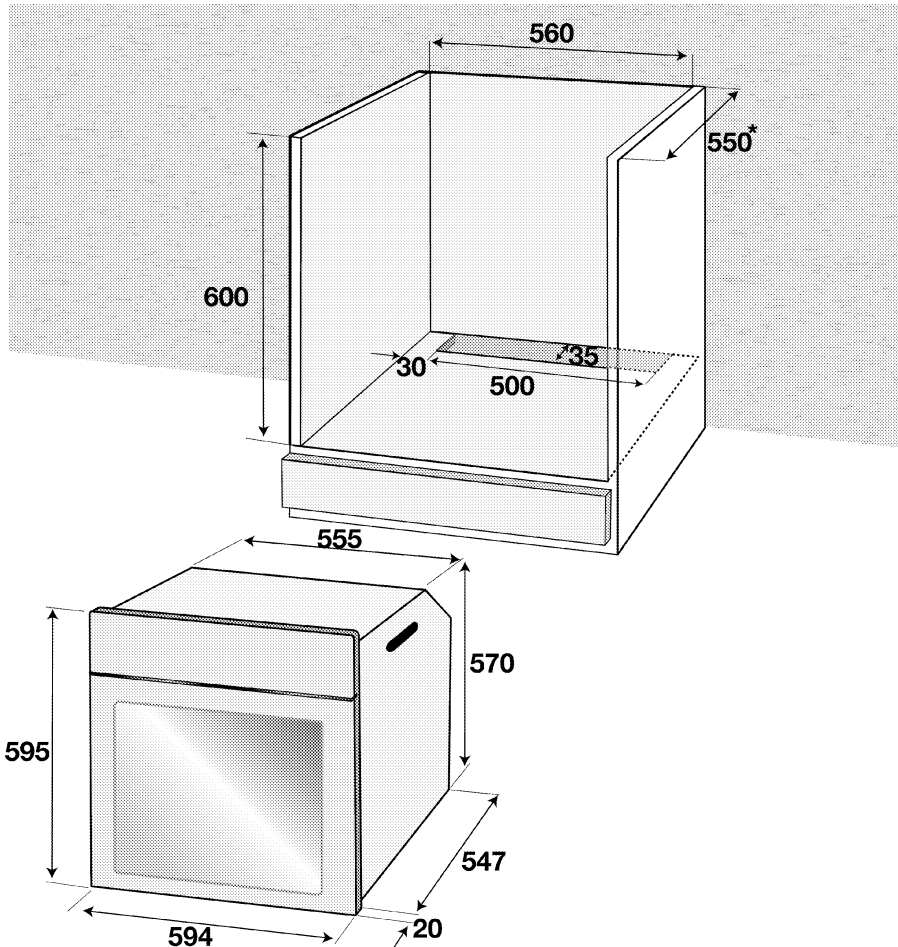

\* min.

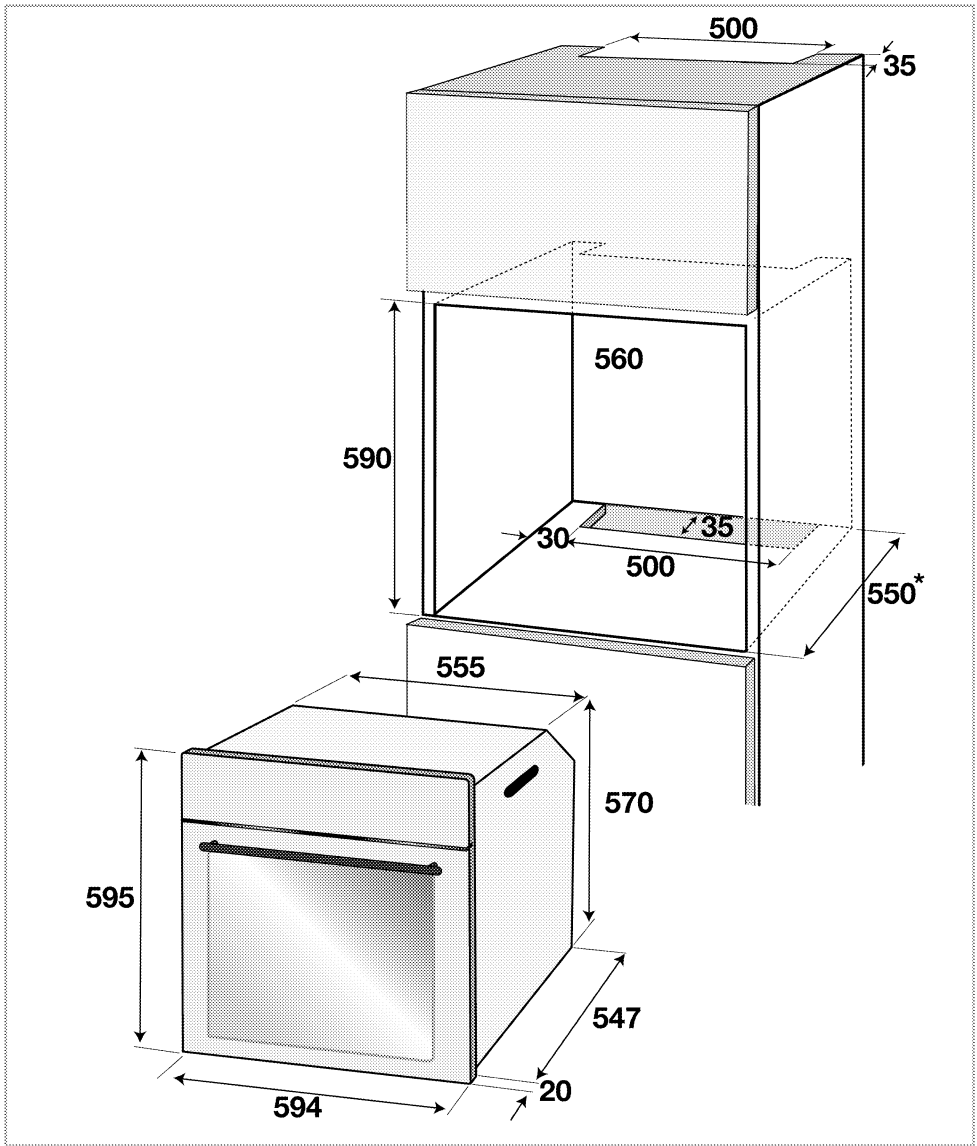

\* min.

## Installation and connection

---



### NOTICE

Material damage!

The door and/or handle must not be used for lifting or moving the appliance.

---

- For installation the appliance must be connected in accordance with all local gas and/or electrical regulations.
  - Carry the appliance with at least two persons.
  - Use the slots or wire handles located at both sides to move the appliance.
- 



### NOTICE

If the appliance has wire handles, push the handles back into the side walls after moving the appliance.

---

## Connection to the mains supply

---



### Important

**This appliance must be earthed!**

Our company shall not held responsible for any damage caused by using the appliance without an earthed socket.

---



### DANGER

**Risk of electric shock, short circuit or fire by unprofessional installation!**

The appliance may be connected to the mains supply only by an authorized qualified person and the appliance is only guaranteed after correct installation.

---



### DANGER

**Risk of electric shock, short circuit or fire by damage of the mains lead!**

The mains lead must not be clamped, bent or trapped or come into contact with hot parts of the appliance.

If the mains lead is damaged, it must be replaced by a qualified electrician.

---

- The mains supply must correspond to the data specified on the rating plate of the appliance. The rating plate can be seen when the front door is opened.
  - The appliance mains cable must correspond to the specifications and the power consumption; see *Technical Data, page 5*.
- 



### DANGER

**Risk of electric shock!**

Before starting any work on the electrical installation, please disconnect the appliance from the mains supply.

---

1. This appliance must only be installed by a qualified electrician, eg local electricity company or a NICEIC registered contractor, to a suitable double-pole control unit with a minimum contact clearance of 3 mm in all poles, after appliance has been installed in accordance with IEE regulations. Failure to observe this instruction may result in operational problems and invalidation of the appliance warranty.

Additional protection by a residual current circuit breaker is recommended.

- Open the terminal block cover with screwdriver.
- Pass the mains lead through the cable clamp under the terminal and fix the mains lead to main body with supplied screw via cable tightener.
- Connect the cables according to the supplied diagram.

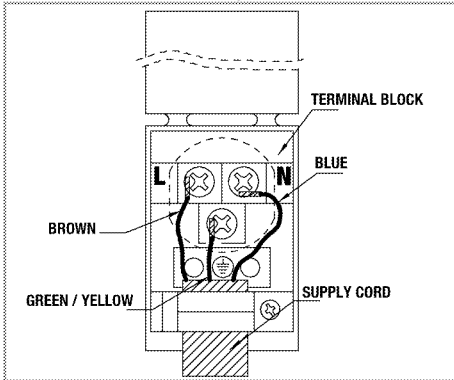

- Close the cover of the terminal block once the wiring is complete.



**NOTICE**

Mains cable must not be longer than 2 meters for safety reasons.

- The mains lead should be routed away from the appliance and not be trapped between the appliance and the wall.

**Installation**

- Slide the oven through the cabinet aperture, align and secure.

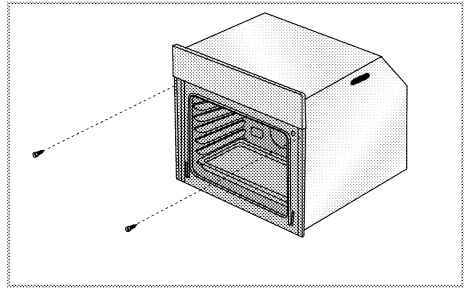

Fix your oven with the 2 screws and washers as indicated in the figure.

**Final check**

- Connect the appliance to the mains supply and switch on the mains supply.
- Check function.

**For equipment with a cooling fan**

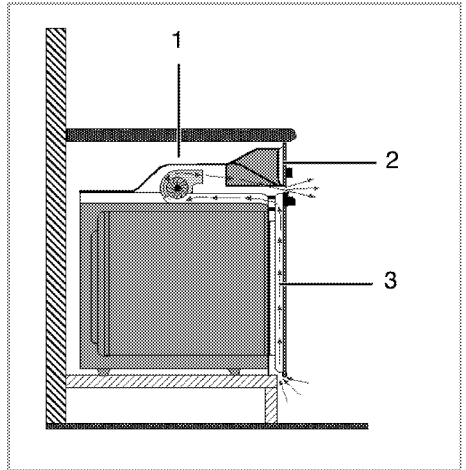

- Fan
- Control panel
- Door

The Built-in cooling fan cools both the built-in cabinet and the front of the appliance.



**NOTICE**

Cooling fan continues to run for up to 20-30 minutes (approx.) even after the oven is turned off.

## 4 Preparation

### Tips for saving energy

The following tips will help you to use your appliance in an ecological way and to save energy:

- Use dark coloured and enamel coated trays, since the heat transmission will be better.
- While cooking your meals, perform a preheating operation if it is advised in the user manual or cooking instructions.
- During cooking, do not open the oven door frequently.
- Try to cook more than one type of meal within the oven at the same time (You can cook two different meals at the same time by locating

cooking bowls on the same shelf). It will be suitable to cook more than one meal after each other. The oven will already be hot.

- Defrost frozen meals before cooking them.
- You can save energy by switching off your oven a few minutes before the end of the cooking time (The oven door should not be opened).

### Initial operation

Before first usage of your appliance, don't forget to remove the sticker on the digital timer screen

### Setting the time

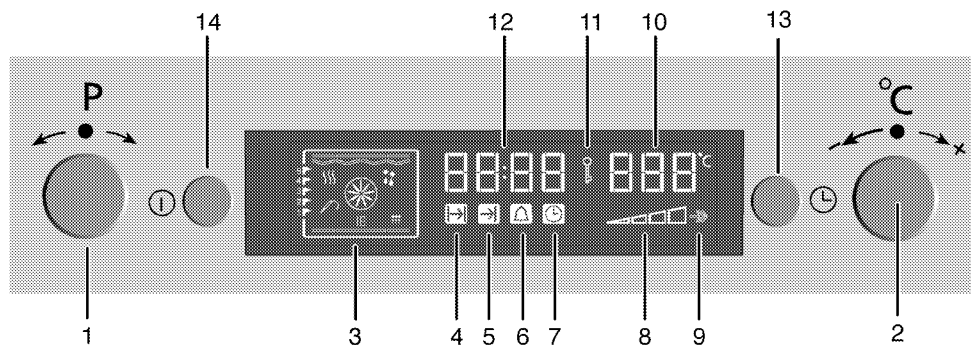

- 1 Program selection knob
- 2 Temperature-time increasing/decreasing knob
- 3 Function display
- 4 Cooking time symbol
- 5 Cooking end time symbol
- 6 Alarm period symbol
- 7 Current time symbol
- 8 Inner oven temperature symbol
- 9 Booster position
- 10 Temperature display

- 11 Keylock symbol
- 12 Current time display
- 13 Menu button
- 14 ON/OFF button

1. After switching on the oven for the first time, adjust the time of the day by slightly twisting the button **2** towards + or -.



### Important

If the current time is not set, time setting will start increasing up from **12:00**. Clock icon '7' will remain lit to indicate that the current time has not been set. This icon will disappear once the time is set.

## Adjust the existing time

1. Activate the time of the day symbol '7' by pressing the button **13** twice for the time of the day.
2. Adjust the time of the day by slightly twisting the button **2** towards + or -.



### Important

Current time settings are cancelled in case of power failure. It needs to be readjusted. Time of the day can not be changed if the oven is operating in a function.

## First cleaning of the appliance



### NOTICE

The surface might get damaged by some detergents or cleaning materials.

Do not use aggressive detergents, cleaning powder/cream or any sharp objects.

1. Remove all packaging materials.
2. Wipe the surfaces of the appliance with a damp cloth or sponge and dry with a cloth.

## Initial heating



### WARNING

#### Hot surfaces may cause burns!

Do not touch the hot surfaces of the appliance. Use oven gloves. Keep children away from the appliance.



### Important

Smell and smoke may emit during first heating. Ensure that the room is well ventilated.

Any production residues or conservation layers must be burnt off before the first use. Heat up the appliance for about 30 minutes and then switch it off.

### Electric oven

1. Take all baking trays and racks from the oven.
2. Close oven door.
3. Select top and bottom heat with the function knob.
4. Select the highest temperature with the thermostat knob; see *How to use the electric oven, page 16*.
5. Heat approximately 30 minutes.
6. Switch off oven; see *How to use the electric oven, page 16*

### Grill oven

1. Take all baking trays and wire shelf from the oven.
2. Close oven door.
3. Select highest power of the grill; see *How to operate the grill, page 26*.
4. Heat approximately 30 minutes.
5. Switch off grill; see *How to operate the grill, page 26*



## 5 How to Operate the Oven

### General information on baking, roasting and grilling



#### **DANGER**

#### **Risk of scalding by hot steam!**

Take care when opening the oven door as steam may escape.

#### Tips for baking

- Use non-stick coated appropriate metal plates or aluminum containers or heat-resistant silicone moulds.
- Make best use of the space on the rack.
- It is recommended to place the baking mould in the middle of the rack.
- Select the correct shelf position before turning the oven or grill on - don't move oven shelves when hot.
- Keep the oven door closed..

#### Tips for roasting

- Seasoning with lemon juice and black pepper will improve the cooking performance when cooking a whole chicken, turkey or a large piece of meat.
- Meat with bones takes about 15 to 30 minutes longer before it is cooked than a roast of the same size without bones.
- You should calculate about 4 to 5 minutes cooking time per centimeter height of the meat.
- Let meat rest in the oven for about 10 minutes after the cooking time. The juice is better distributed all

over the roast and does not run out when the meat is cut.

- Fish in a fire-resistant dish should be placed on the rack at the medium or lower level.

#### Tips for grilling

Grilling is ideal for cooking meat, fish and poultry and will achieve a nice brown surface without it drying out too much. Flat pieces, meat skewers and sausages are particularly suited for grilling as are vegetables with a high water content such as tomatoes and onions.

- Distribute the pieces to be grilled on the wire shelf.
- If the grilling is on the wire shelf, locate a dripping pan under it in order to collect the fat.
- Add some water in dripping pan for easy cleaning.

### How to use the electric oven

#### Turning the oven on

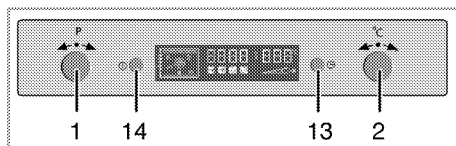

- 1 Program selection knob
- 2 Temperature-time increase/decrease button
- 13 Menu button
- 14 ON/OFF button

1. Press button **14** for about 1 second to turn the oven on.

## Select temperature and operating mode

After turning the oven on; nothing appears at the function display.



### NOTICE

Oven will switch off automatically within 10 seconds if no oven setting is made on this screen.

Temperature, cooking time, cooking end time and booster can be set in this position.

1. Slightly turn the button no. 1 to left or right so that the desired function;
2. You can adjust the desired temperature by slightly twisting the button 2 towards + and –.

» Your oven will readily start operating in the desired function and will increase the inner temperature to the set temperature.

» Active heaters and suggested tray position appear on the function display.

» If no temperature setting is made previously, then the suggested temperature for the selected function is indicated on the temperature display.

Function table contains the functions that can be used as well as minimum and maximum temperatures that can be selected in the oven.

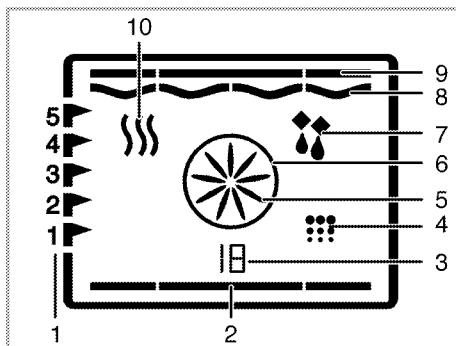

- 1 Shelf position
  - 2 Bottom heater
  - 3 Function number
  - 4 Cleaning position
  - 5 Turbo fan
  - 6 Turbo heater
  - 7 Defrost position
  - 8 Grill heater
  - 9 Upper heater
  - 10 Warm keeping
- \* Functions can vary depending on the product model!

### Function table :

Function	Suggested temperature (°C)	Temperature range (°C)
Static	200	40-280
Static + fan	175	40-280
Fan heating	180	40-280
3 D	205	40-280
Pizza	210	40-280
Grill	280	40-280
Low grill	280	40-280
Slow cooking	180	160-220
Bottom heater	180	40-220
Warm keeping	60	40-100



### Important

Maximum time that can be set for cooking period is limited with 6 hours at positions apart from keeping warm due to safety reasons. In case of power cut, program will be canceled. Reprogram is needed.



### Important

While making any adjustment, related symbols on the clock will flash.



### Important

Time of the day can not be adjusted when the oven is operating in any function or the clock is set to a semi-automatic or full automatic program.



### NOTICE

Even if the oven is off, oven lamp lights up when the oven door is opened.

### Switch off electric oven

Press button **14** for about 2 seconds to turn the oven off.

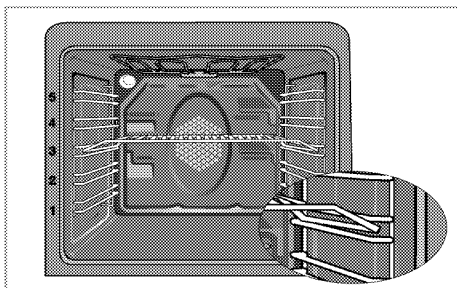

### Shelf positions (model dependant)

It is important to position the wire grill on wire shelf correctly. The wire grill must be placed so that it will fit into

the opening of the wire shelf as illustrated in the figure.

### Operating modes

The order of operating modes shown here might deviate from the arrangement on your appliance.

#### 1. Top and bottom heat

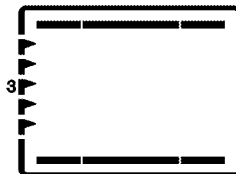

The foodstuffs are heated simultaneously from the upper and lower part. Suitable e.g. for cakes, cookies or cakes and casseroles in baking moulds. Cook with one tray only.

#### 2. Top and bottom heat with convection air



Warm air heated by the lower and upper heaters is evenly distributed throughout the oven very fast by means of the fan. Cook with one tray only.

#### 3. Hot air

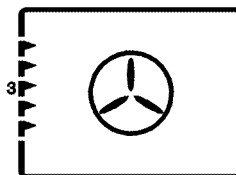

Warm air heated by the rear heater is evenly distributed throughout

the oven very fast by means of the fan. It is suitable for cooking your meals in different shelf levels and preheating is not required in most cases. Suitable for cooking with multi trays.

4. **"3D" function**

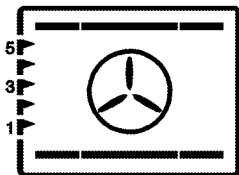

Top heat, bottom heat plus ring heat with fan (in the rear wall) are on. The appliance to be cooked is evenly and quickly cooked all around. Cook with one tray only.

5. **Pizza function**

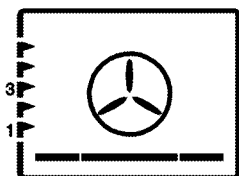

The bottom heat and the heating ring with fan (in the rear wall) are in operation. Suitable for baking pizza.

6. **Strong grill with convection air**

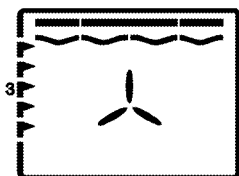

Warm air heated by the large grill is distributed very fast in the oven by means of the fan. It is suitable for grilling large amount of meat.

- Put big or medium-sized portions in correct shelf

position under the grill heater for grilling.

- Set the temperature to maximum level.
- Turn the food after half of the grilling time.

7. **Surface grill**

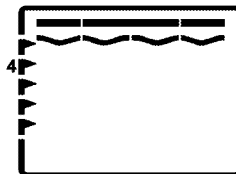

The large grill (under the oven roof) is in operation. Suitable for grilling larger quantities.

- Put big or medium-sized portions in correct shelf position under the grill heater for grilling.
- Set the temperature to maximum level.
- Turn the food after half of the grilling time.

8. **Grill-small**

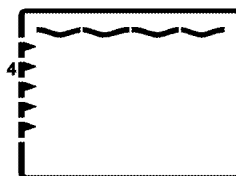

The grill (under the oven roof) is in operation. Suitable for grilling.

- Put small or medium-sized portions in correct shelf position under the grill heater for grilling.
- Set the temperature to maximum level.
- Turn the food after half of the grilling time.

### 9. Slow cooking

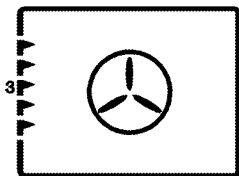

To save power, you can use this function instead of the cooking operations that you would perform by using turbo cooking at 160-220°C temperature range. But, the cooking time will increase a little bit.

Cooking times for this mode is given 'Slow cooking' table.

### 10. Bottom heat



Only bottom heat is on. Is particularly suitable for dishes, such as pizza, which are required to be baked from bottom.

### 11. Warm keeping

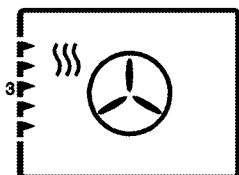

Can be used for keeping food warm at low temperature and over a longer period of time.

### 12. Operating with fan



The oven is not heated. Only the fan (in the rear wall) is in operation. Frozen granular food is thawed slowly at room temperature and cooked food is cooled down.

### 13. Pyrolytic cleaning - eco mode



This function allows the oven to clean itself at a high temperature. It is recommended for lightly soiled ovens.

### 14. Pyrolytic cleaning



This function allows the oven to clean itself at a high temperature. Read the description in the cleaning section to use this function.



#### NOTICE

When the oven door is opened, the fan motor will not run to keep the hot air inside.

## How to operate the oven control unit

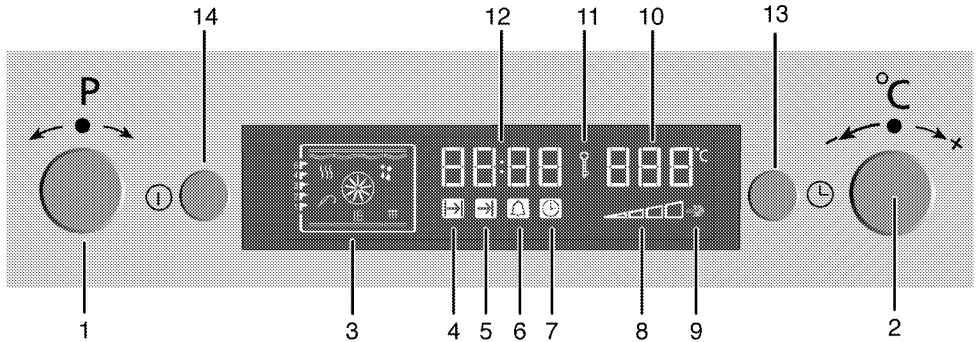

- 1 Program selection knob
  - 2 Temperature-time increasing/decreasing knob
  - 3 Function display
  - 4 Cooking time symbol
  - 5 Cooking end time symbol
  - 6 Alarm period symbol
  - 7 Current time symbol
  - 8 Inner oven temperature symbol
  - 9 Booster position
  - 10 Temperature display
  - 11 Keylock symbol
  - 12 Current time display
  - 13 Menu button
  - 14 ON/OFF button
4. Adjust the cooking time by slightly twisting the button **2** towards "+" or "-".
    - » Cooking time symbol '4' remains lit after adjusting the cooking time.
  5. Place your dish in the oven.
  6. Adjust the cooking temperature by slightly twisting the button **2** towards "+" or "-".
    - » The oven will be heated up to the preset temperature and will maintain this temperature until the end of the cooking time you selected.

### Switch on semi-automatic operation

In this operation mode, you may adjust the time period during which the oven will operate (cooking time). Oven starts to operate after the settings are made and runs at the set temperature throughout the cooking time. Oven turns off at the end of the cooking time.

1. Turn on the oven by pressing and holding button '**14**'.
2. Adjust the desired operation mode (function) by slightly twisting the button '**1**' towards right or left hand.
3. Activate the cooking time symbol '**4**' by pressing the button '**13**' with while the oven is operating.



### NOTICE

All segments of the inner oven temperature symbol (**8**) will turn on when your oven reaches the set temperature.

7. After the cooking process is completed, "**End**" will be displayed and the alarm signal will sound.
  8. To stop the alarm signal, press button no. '**13**' or '**14**'.
    - » Alarm will be silenced, oven will be turned off automatically and current time will be displayed on the screen.
- Switch on automatic operation**  
In this operation mode you may adjust how long the oven will be operate

(cooking time) and when it will be turned off (cooking end time).

1. Turn on the oven by pressing and holding button '**14**'.
2. Adjust the desired operation mode (function) by slightly twisting the button '**1**' towards right or left hand.
3. Activate the cooking time symbol '**4**' by pressing the button '**13**' with while the oven is operating.
4. Adjust the cooking time by slightly twisting the button **2** towards "+" or "-".
  - » Cooking time symbol **4** remains lit after adjusting the cooking time.
5. Activate the cooking end time symbol (**5**) by pressing the button **13** with short intervals.
6. Adjust the cooking end time by slightly twisting the button '**2**' towards "+" or "-".
  - » Cooking end time symbol (**5**) remains lit after adjusting the cooking end time.
7. Place your dish in the oven.
8. Adjust the cooking temperature by slightly twisting the button '**2**' towards "+" or "-".
  - » Oven timer automatically calculates the startup time for cooking by using the end of cooking time you have set and the cooking period. Selected operation mode is activated when the startup time of cooking has come and the oven is heated up to the set temperature. It maintains this temperature until the end of the cooking time. Oven lamp lights up during cooking.



#### NOTICE

All segments of the inner oven temperature symbol (**8**) will turn on when your oven reaches the set temperature.

9. After the cooking process is completed, "**End**" will be displayed and the alarm signal will sound.
10. To stop the alarm signal, press button no. '**13**' or '**14**'.
  - » Alarm will be silenced, oven will be turned off automatically and current time will be displayed on the screen. Oven lamp will also switch off.



#### NOTICE

If you want to cancel the semi-automatic or automatic programming after you have set them, you need to reset the cooking time.

### Setting the Booster (Quick Preheating)

It can be used to reach to the desired inner oven temperature more quickly by operating the oven heaters in a combination different than the selected function.



#### Important

Booster function can only be set while the oven is operating. Booster function can not be selected in defrosting and cleaning modes. Booster setting is cancelled in case of power failure.

1. For booster function, press button **13** with short intervals until the booster symbol (**9**) becomes active.
  - » "**OFF**" will be displayed.
2. Activate the booster by slightly twisting the button **2** towards "+".

» After the booster is adjusted, "On" will be displayed and the booster symbol will remain lit.

» Booster symbol turns off after the desired inner oven temperature is attained and oven resumes its operation with the function selected before the booster.

3. To cancel the booster function, press button '13' to activate the booster symbol (9).

» "On" will be displayed.

4. Deactivate the booster by slightly twisting the button 2 towards "-".

» "OFF" will be displayed.

## How to use the program lock

### Activate the program lock

You can prevent using of oven by activating the keylock feature.



#### Important

Keylock can be used either the oven is operating or not operating. Oven can still be turned off by keeping the button 14 pressed for 2 seconds even the key lock is activated while the oven is operating.

1. For keylock; press button 13 with short intervals until the keylock symbol "11" becomes active.

» "OFF" will be displayed.

2. Activate the keylock by slightly twisting the button '2' towards "+".

» After the keylock is adjusted, "On" will be displayed and the keylock symbol will remain lit.

### Deactivate the program lock

1. To deactivate the keylock, press button "13" with short intervals until the keylock symbol "11" becomes active.

» "On" will be displayed.

2. Deactivate the keylock by slightly twisting the button '2' towards "-".

» After the keylock is turned off, "OFF" is displayed and the keylock symbol '11' disappears.



#### Important

Oven buttons can not be used while the keylock function is active. Keylock function is not cancelled in a power failure.

## Cooking times table



#### Important

The values indicated in the table below are data indicative. They may vary according to the type of food as well as your preferences of cooking.

## Baking and roasting

























#### Important

Level 1 is the **bottom** level in the oven.









Food	Cooking level number		Rack position	Temperature (°C)	Cooking time (min.) (approx.)
Cake in tray	One level		3	175	25 ... 30
Cake in mould	One level		2	180	40 ... 50
Cakes in paper	One level		3	175	25 ... 30
	2 levels		1 - 5	175	30 ... 40
	3 levels		1 - 3 - 5	180	45 ... 55
Sponge cake	One level		3	200	5 ... 10
	2 levels		1 - 5	175	20 ... 30





Food	Cooking level number		Rack position	Temperature (°C)	Cooking time (min.) (approx.)
Cookies	One level		3	175	25 ... 30
	2 levels		1 - 5	170 ... 190	30 ... 40
	3 levels		1 - 3 - 5	175	35 ... 45
Dough pastry	One level		2	200	30 ... 40
	2 levels		1 - 5	200	45 ... 55
	3 levels		1 - 3 - 5	200	55 ... 65
Filled savory pastry	One level		2	200	25 ... 35
	2 levels		1 - 5	200	35 ... 45
	3 levels		1 - 3 - 5	190	45 ... 55
Leaven	One level		2	200	35 ... 45
	2 levels		1 - 3	190	35 ... 45
Lasagna	One level		2 - 3	200	30 ... 40
Pizza	One level		2	200 ... 220	15 ... 20
	One level		3	200	10 ... 15
Beefsteak (whole)/ Roast	One level		3	25 min. 250 after 180 ... 190	100 ... 120
Lamb haunch (casserole) Roast chicken	One level		3	25 min. 250 after 190	70 ... 90
	One level		2	15 min. 250 after 180 ... 190	55 ... 65
	One level		2	15 min. 250 after 180 ... 190	55 ... 65
Turkey (5.5 kg)	One level		1	25 min. 250 after 180 ... 190	150 ... 210
	One level		1	25 min. 250 after 180 ... 190	150 ... 210
Fish	One level		3	200	20 ... 30
	One level		3	200	20 ... 30

While cooking with 2 trays at the same time, place the deep tray to the upper shelf and shallow tray to the lower shelf.  
It is suggested to perform preheating for all foods.

## Slow cooking

Food	Cooking level number		Rack position	Temperature (°C)	Cooking time (min.) (approx.)
Meat-Casserole	One level		3	160	100 ... 120
Chicken-Casserole	One level		3	160	70 ... 100
Haricot Bean	One level		3	160	130 ... 150
Eggplant-Casserole	One level		3	160	130 ... 150
Steak – Whole	One level		3	160	110 ... 130
Steak – Sliced	One level		3	160	100 ... 120
Cakes in paper	One level		3	185	35 ... 40

Food	Cooking level number		Rack position	Temperature (°C)	Cooking time (min.) (approx.)
Cookies	One level		3	185	30 ... 35
Dough pastry	One level		3	200	40 ... 45
Filled savory pastry	One level		3	200	40 ... 45

(\*\*) In a cooking that requires preheating, preheat at the beginning of cooking until the temperature symbol **(8)** of the oven rises up to the highest level.

### Tips for baking cakes

1. If pastry is too dry,
  - » Increase the temperature by 10°C and reduce the cooking time.
2. If pastry dropped,
  - » Use less liquid or lower the temperature by 10°C.
3. If pastry is too dark on top,
  - » Place it on a lower rack, lower temperature, and increase the cooking time.
4. If cooked well on the inside but sticky on the outside,
  - » Use less liquid, lower the temperature, and increase the cooking time.

### Tips for baking pastry

1. If the pastry is too dry,
  - » Increase the temperature some 10°C and decrease the cooking time.
  - » Dampen the layers of dough with a sauce composed of milk, oil, egg and yoghurt.
2. If the pastry takes too long to bake,
  - » Pay care that the thickness of the pastry you have prepared does not exceed the depth of the tray and remain level with it.

3. If the upper side of the pastry gets browned, but the lower part is not cooked,
  - » Make sure that the amount of sauce you have used for the pastry is not too much at the bottom of the pastry. Try to scatter the sauce equally between and on the dough layers for an even browning.
  - » Cook the pastry in accordance with the mode and temperature given in the cooking table. If the bottom part is still not browned enough, place it on one-layer-lower shelf next time.

### Tips for cooking vegetables

1. If the vegetable dish runs out of juice and gets to dry,
  - » Since using a lid during cooking will keep the juice of the dish in the pan, cook your vegetable dishes in a pan with a lid instead of a tray.
2. If a vegetable dish does not get cooked,
  - » Boil the vegetables beforehand or prepare them like canned food and put in the oven.

## How to operate the grill



### WARNING

Hot surfaces may cause burns!  
Close oven door during grilling.

### Switch on grill

1. Press button **14** for about 1 second to turn the oven on.
2. Adjust the grill function by slightly twisting the button '1' towards right or left hand.

## Cooking times table for grilling

### Grilling with electric grill

Food	Insertion level	Grilling time (approx.)
Fish	4...5	20...25 min. #
Sliced chicken	4...5	25...35 min.
Lamb chops	4...5	20...25 min.
Roast beef	4...5	25...30 min. #
Veal chops	4...5	25...30 min. #
Toast bread	4	1...2 min.
# depending on thickness		

3. You can adjust the desired temperature by slightly twisting the button **2** towards + and -.

### Switch off grill

1. Press button **14** for about 2 seconds to turn the oven off.

### Shelf positions

For optimum grill coverage, position the wire shelf towards the front of the oven just out of contact with the glass door. Placing the wire shelf fully to the rear of the oven will reduce the grill coverage.

## How to use the alarm clock

In addition to using the timer for cooking, it can be also used as a reminder or an alarm clock.

As soon as the defined period of time has expired, the alarm clock will emit a signal. The alarm clock has no influence on the functions of the oven.

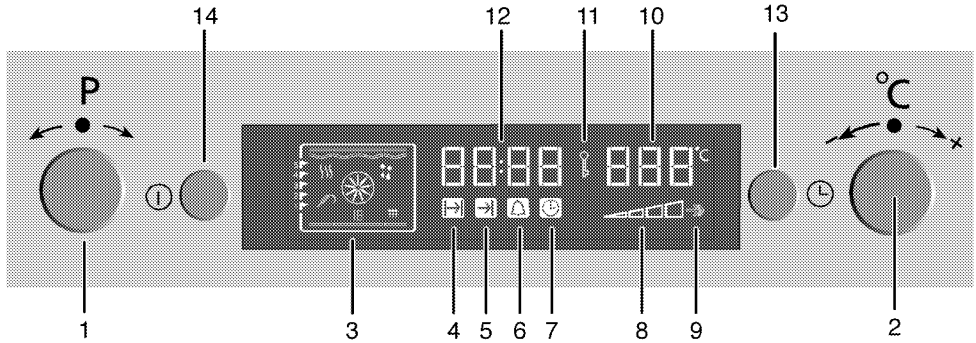

- 1 Program selection knob
- 2 Temperature-time increasing/decreasing knob
- 3 Function display
- 4 Cooking time symbol
- 5 Cooking end time symbol
- 6 Alarm period symbol
- 7 Current time symbol
- 8 Inner oven temperature symbol
- 9 Booster position
- 10 Temperature display
- 11 Keylock symbol
- 12 Current time display
- 13 Menu button
- 14 ON/OFF button

### Using the clock as an alarm

Alarm clock does not have any effect on the oven functions. It is used as a warning.

For example, you can use alarm clock to warn you for turning the dish in the oven round in a certain time.



#### Important

The maximum alarm time can be 23 hours and 59 minutes.



#### Important

Alarm clock can be used either the oven is operating or not operating.

### Setting the alarm clock

1. Press button '13' with short intervals until the alarm symbol '6' becomes active.
2. Adjust it by slightly twisting the button 2 towards "+" or "-".
  - » Alarm symbol remains lit after adjusting the alarm time.
3. After the alarm time is finished, alarm symbol will start flashing and an alarm signal is heard.
4. You can stop the alarm by pressing any button.

### In order to cancel set alarm time;

1. To reset the alarm time, press button '13' to activate the alarm symbol (6).
2. Adjust it by slightly twisting the button '2' towards "-" until "00:00" is displayed.

## 6 Maintenance and Care

### General information



#### **DANGER**

##### **Risk of electric shock!**

Switch off the electricity before cleaning appliance to avoid an electric shock.



#### **DANGER**

##### **Hot surfaces may cause burns!**

Allow the appliance to cool down before you clean it.



#### **NOTICE**

The surface might get damaged by some detergents or cleaning materials.

Do not use aggressive detergents, cleaning powder/cream or any sharp objects.

Clean the appliance thoroughly after each use; in this way it will be possible to remove cooking residues more easily, thus avoiding these from burning the next time the appliance is used.

No special cleaning agents are required for cleaning the appliance. It is recommended to use warm water with washing liquid, a soft cloth or sponge and use a dry cloth for drying.

**Do not use any abrasive cleaning materials!**



#### **Important**

Do not use steam cleaners for cleaning.

### Cleaning the control panel



#### **NOTICE**

Damage of the control panel!  
Do not remove the control knobs for control panel cleaning.

Clean control panel and control knobs.

### Cleaning the oven

No oven cleaner or any other special cleaning agent is required for cleaning the oven. It is recommended to wipe the oven with a damp cloth while it is still warm.

To clean the side wall,

1. Remove the front section of the side rack by pulling it in the opposite direction of the side wall.
2. Remove the side rack completely by pulling it towards you.

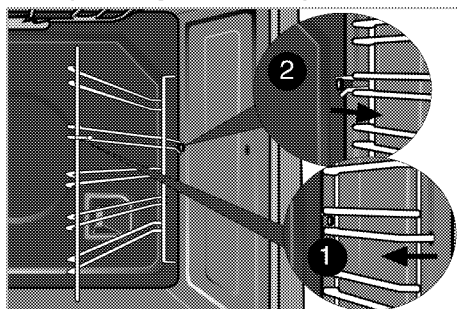

### Pyrolytic self-cleaning



#### **DANGER**

##### **Hot surfaces may cause burns!**

Do not touch the equipment and keep children away from the equipment during self-cleaning. Wait at least 30 minutes before removing residues.

The oven is equipped with pyrolytic self-cleaning. The oven is heated to approx. 480 °C and existing dirt is burned to ashes. A strong smoke development may arise. Provide for good ventilation. The pyrolysis should be used after approx. every 10th oven usage.

1. Remove all accessories from the oven. In models with side rack; do not forget to take out the side racks.
2. Before the cleaning cycle, remove dirt from exterior surfaces and oven interior with a damp cloth.



#### NOTICE

Do not clean the door sealing. The fibre glass sealing is very sensitive and can be damaged easily.



In case of a damage on the oven door gasket, replace with the new one from the authorized service.

1. "Pyrolysis"  Select the pyrolytic function (self-cleaning).
  - » The self-cleaning time appears in the display. This duration can not be adjusted.
  - » The end of self cleaning cycle can be adjusted.



#### NOTICE

The health of some birds is extremely sensitive to the fumes given off during the Self-Cleaning cycle. Always move birds to another closed and well ventilated room. Keep the kitchen well-ventilated during the Self-Cleaning cycle.

1. Oven door cannot be opened and lock symbol  appears on the time display during self cleaning. It remains locked for a while after the pyrolysis function ends. Do not force the door lock with handle until lock symbol  disappears.
2. After a clean cycle, remove soil deposits with vinegar water.

#### Clean oven door

Don't use any harsh abrasive cleaners or sharp metal scrapers for cleaning the oven door. They could scratch the surface and destroy the glass.

#### Removal of oven door

1. Open the front door.
2. Open the clips at the hinge housing on the right and left hand sides of the front door by pressing them down as illustrated in the figure.

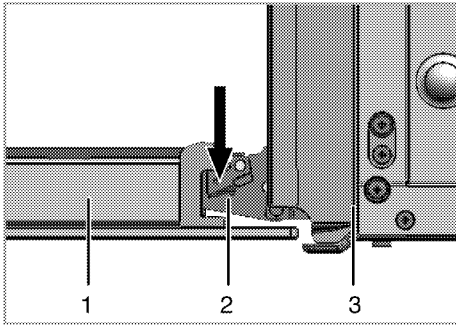

- 1 Front door
- 2 Hinge
- 3 Oven

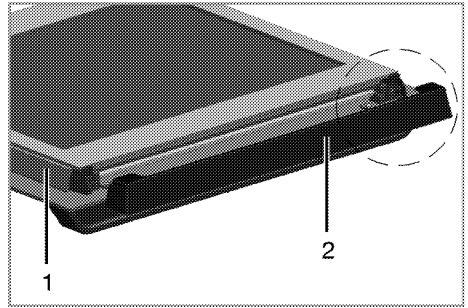

- 1 Frame
- 2 Plastic part

Remove the plastic part mounted upper side of the door by pulling towards yourself.

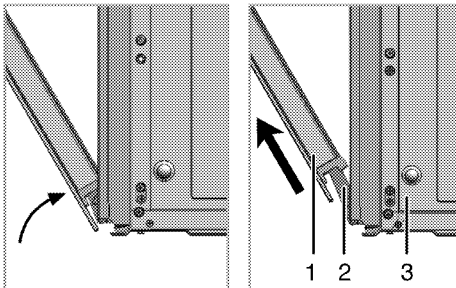

- 3. Move the front door to half-way.
- 4. Remove the front door by pulling it upwards to release it from the right and left hinges.



**NOTICE**

Steps carried out during removing process should be performed in reverse order (steps 4, 3, 2 and 1) to reattach the door. Do not forget to close the clips at the hinge housing when reinstalling the door.

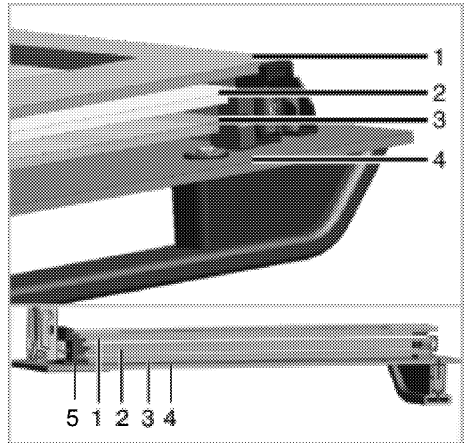

- 1 Inmost glass
- 2 Second inner glass
- 3 Third inner glass
- 4 Outer glass
- 5 Plastic housing for glass-bottom

**Taking off the door inner glass**

The inner glass panel of the oven door can be removed for cleaning.

- 1. Open oven door.

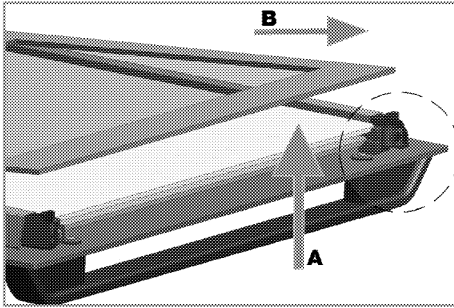

As shown in the figure, lift the inmost glass slightly in 'A' direction. Then remove the glass by pulling in 'B' direction.

Repeat this operation to remove the second and third inner glass.

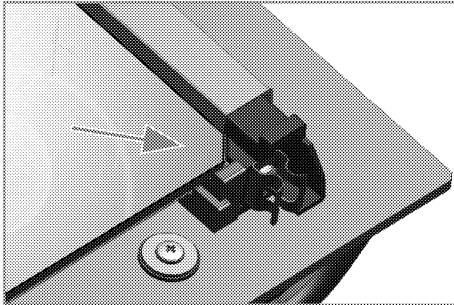

First step of reassembling the door is to mount the second and third inner glasses.

Chamfered corner of the glasses should overlap the chamfer on the plastic housing as shown.

Mounting order of the second and third glasses is not important since they are interchangeable.

While mounting the inmost glass, take great care that the printed surface faces the second glass.

It is important in mounting all inner glasses to position the bottom corners of glasses into bottom plastic housings properly.

Push the plastic part against to the frame until you hear the “click” noise.



### Important

All glass must be reassembled after cleaning.

## Replacing the oven lamp



### DANGER

**Hot surfaces may cause burns!**

Make sure that the appliance is switched off and cooled down in order to avoid the risk of an electrical shock.

The oven lamp is a special heat-resisting (T 300 °C) electric light bulb; see *Technical Data, page 5*. Oven lamps can be obtained from a good local electrical store.



### NOTICE

Position of lamp might vary from diagram.

1. Switch off the appliance at the mains.
2. Unscrew glass cover by turning anti-clockwise.

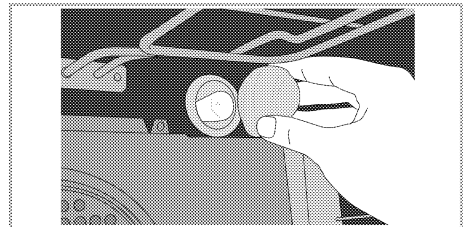

3. Unscrew oven lamp by turning anti-clockwise and replace it with new one.
4. Refit the glass cover.



## 7 Troubleshooting



### DANGER

**Risk of electric shock, short circuit or fire by unprofessional repairs!**

Repairs on the appliance must be carried out by an approved service centre.

- It is normal that steam escapes during operation.
- When the metal parts are heated, they may expand and cause noise.

**Before you call the service, please check the following points.**

### Normal operating conditions

- Smoke and smell may emit for a couple of hours during the first operation.

### Electrical equipment

Malfunction/problem	Possible cause	Advice/remedy
The appliance does not work.	The mains fuse is defective or has tripped.	Check fuses in the fuse box. If necessary, replace or reset them.
	Timer buttons do not work.	Keylock may be enabled. Please disable it(See; <i>How to use the program lock, page 23</i> ).
Oven light does not work	Oven lamp is defective.	Replace oven lamp.
	No current.	Check fuses in the fuse box. If necessary, replace or reset them.
Oven does not heat.	Function knob and/thermostat knob are not set.	Set function knob and thermostat knob.
	If the appliance has a timer, the timer may not be set.	Set the time.
	No power.	Check mains supply and fuse box.

If the problem has not been solved:

1. Separate unit from the mains supply (deactivate or unscrew fuse).
2. Call the appropriate telephone number for your area as shown in the

Guarantee and Service section of this user manual.



### Important

Do not attempt to repair the appliance yourself. There are no customer service items inside the appliance.

## 8 Guarantee and Service

Your Beko product is guaranteed against the cost of breakdown repairs for twelve months from the date of the original purchase.

### What is covered?

- All repairs necessary as a result of faulty materials, defective components or manufacturing defect.
- The cost of all functional replacement parts.
- The labour costs of a Beko approved repairer to carry out the repair.

### What is not covered?

- Transit or delivery damage
- Accidental damage
- Misuse, or abuse.
- Cabinet or appearance parts, including knobs and flaps
- Accessory items, including ice trays, scrapers, cutlery baskets,
- Repairs required as a result of unauthorised repairs or inexpert installation that fails to meet the requirements contained in the user instruction book.

Repairs to products used on commercial or non-residential household premises.

### Important notes.

- The product is guaranteed for domestic household use only.
- The guarantee will be void if the product is installed or used in commercial or non-residential household premises.
- The product must be correctly installed, located and operated in accordance with the instructions contained in the User Instructions Booklet provided.
- Professional Installation by a qualified plumber/electrical appliance installer is recommended for all Washing & Dishwashing Machines and Electric Cookers
- Gas appliances must only be installed by a Gas Safe (or BORD GAS) registered Gas Installer.
- The guarantee is given only within the boundaries of the United Kingdom.
- The guarantee is not transferable if the product is resold.
- Beko plc disclaims any liability for incidental or consequential damages.
- The guarantee does not in anyway diminish your statutory or legal rights.

## HOW TO OBTAIN SERVICE UNDER THE MANUFACTURERS WARRANTY

Please keep your purchase receipt or other proof of purchase in a safe place; you will need to have it should the product require attention in the guarantee period

You should also complete the details below; it will help us assist you quicker when requesting service. (The model number is printed on the Instruction Booklet)

Model Number: \_\_\_\_\_ Purchased From: \_\_\_\_\_ Date of purchase: \_\_\_\_\_

For service under guarantee simply telephone the appropriate number below  
UK Mainland & Northern Ireland

Fridges & Freezers	0845 600 4903
Electric Cookers	0845 600 4902
Gas & Dual Fuel Cookers	0845 600 4905
Washing Machines & Dishwashers	0845 600 4906

Republic of Ireland	
All Refrigeration, Cooking, Washing & Dishwashing Machines	01 862 3411

Before requesting service please check the trouble-shooting guide in the Operating Instructions as a charge may be levied where no fault is found even though your product may still be under guarantee.

If you have purchased an extended guarantee please refer to the instructions contained within the extended guarantee agreement document. Otherwise please call the above numbers where service can be obtained at a charge.

Service once the manufacturers guarantee has expired.

Should you experience any difficulty in obtaining service please call the

**Beko Customer Help-Line on 0845 600 4911**

**Beko House, Caxton Way, Watford, Herts, WD18 8UF, Tel: 0845 600 4911**



**285.4408.05/R.AB/15.04.2010**

## Free Manuals Download Website

<http://myh66.com>

<http://usermanuals.us>

<http://www.somanuals.com>

<http://www.4manuals.cc>

<http://www.manual-lib.com>

<http://www.404manual.com>

<http://www.luxmanual.com>

<http://aubethermostatmanual.com>

Golf course search by state

<http://golfingnear.com>

Email search by domain

<http://emailbydomain.com>

Auto manuals search

<http://auto.somanuals.com>

TV manuals search

<http://tv.somanuals.com>