



**Refrigerator**

**冰箱**

CNE34220GW

CNE34220GS

CNE34220GR

CNE34220GRD

CNE34220X

CNE34220T

**BEKO**

## Please read this manual first!

Dear Customer,

We hope that your product, which has been produced in modern plants and checked under the most meticulous quality control procedures, will provide you an effective service.

For this, we recommend you to carefully read the entire manual of your product before using it and keep it at hand for future references.



### This manual

- Will help you use your appliance in a fast and safe way.
- Read the manual before installing and operating your product.
- Follow the instructions, especially those for safety.
- Keep the manual in an easily accessible place as you may need it later.
- Besides, read also the other documents provided with your product.

Please note that this manual may be valid for other models as well.

### Symbols and their descriptions

This instruction manual contains the following symbols:

-  Important information or useful tips.
-  Warning against dangerous conditions for life and property.
-  Warning against electric voltage.



This product is supplied with the selective sorting symbol for waste electrical and electronic equipment (WEEE).

This means that this product must be handled pursuant to European Directive 2002/96/EC in order to be recycled or dismantled to minimise its impact on the environment. For further information, please contact your local or regional authorities.

Electronic products not included in the selective sorting process are potentially dangerous for the environment and human health due to the presence of hazardous substances.



This product was manufactured using the latest technology in environmentally friendly conditions.

## CONTENTS

---

<b>1 Refrigerator</b>	<b>3</b>	<b>5 Using your refrigerator</b>	<b>11</b>
<b>2 Important Safety Warnings</b>	<b>4</b>	Indicator Panel.....	11
Intended use .....	4	Door Open Warning.....	14
For products with a water dispenser; ..	6	Dual cooling system: .....	14
Child safety.....	6	Freezing fresh food .....	14
HCA Warning .....	6	Recommendations for preservation of frozen food .....	15
Things to be done for energy saving ..	7	Reccomendations for freshfood compartment.....	16
<b>3 Installation</b>	<b>8</b>	Placing the food .....	17
Points to be considered when re-transporting your refrigerator .....	8	Deep-freeze information .....	17
Before operating your refrigerator .....	8	Egg holder.....	17
Electric connection .....	9	Blue light .....	17
Disposing of the packaging .....	9	Multi Zone Storage Compartment ..	18
Disposing of your old refrigerator .....	9	Description and cleaning of odor filter: .....	18
Placing and Installation .....	9	<b>6 Maintenance and cleaning</b>	<b>19</b>
Adjusting the legs .....	9	Protection of plastic surfaces .....	19
<b>4 Preparation</b>	<b>10</b>	<b>7 Recommended solutions for the problems</b>	<b>20</b>

# 1 Refrigerator

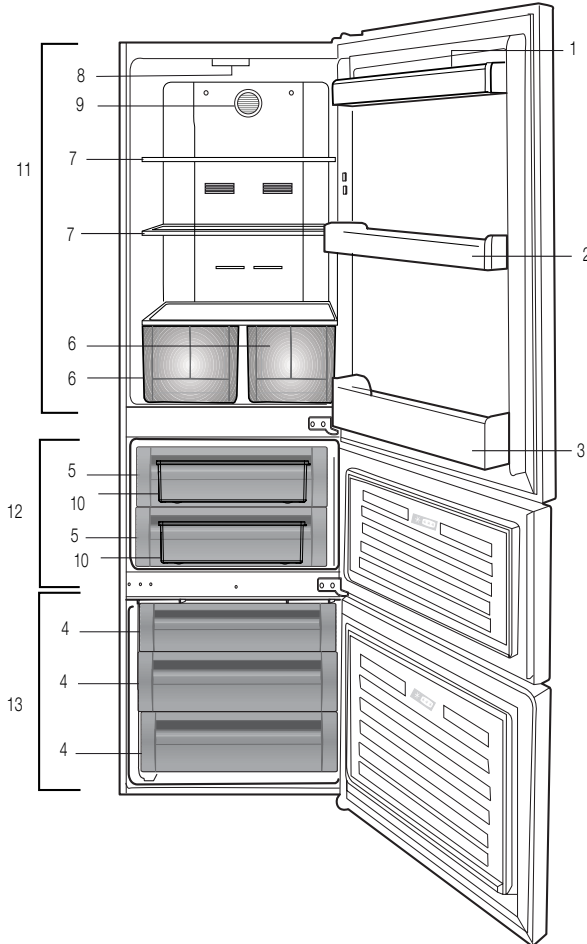

- |                                   |                           |
|-----------------------------------|---------------------------|
| 1. Egg holder                     | 8. Illumination           |
| 2. Fridge compartment shelf       | 9. Fan                    |
| 3. Bottle shelf                   | 10. Rice storage box      |
| 4. Freezer compartment drawers    | 11. Fridge compartment    |
| 5. Multizone compartment's drawer | 12. Multizone compartment |
| 6. Crisper (Snack Compartment)    | 13. Freezer compartment   |
| 7. Glass shelves                  |                           |

ⓘ Figures that take place in this instruction manual are schematic and may not correspond exactly with your product. If the subject parts are not included in the product you have purchased, then it is valid for other models.

## 2 Important Safety Warnings

---

Please review the following information. Failure to observe this information may cause injuries or material damage. Otherwise, all warranty and reliability commitments will become invalid.

The usage life of the unit you purchased is 10 years. This is the period for keeping the spare parts required for the unit to operate as described.

### Intended use

This product is intended to be used

- indoors and in closed areas such as homes;
- in closed working environments such as stores and offices;
- in closed accommodation areas such as farm houses, hotels, pensions.
  - This product should not be used outdoors.

### General safety

- When you want to dispose/scrap the product, we recommend you to consult the authorized service in order to learn the required information and authorized bodies.
- Consult your authorized service for all your questions and problems related to the refrigerator. Do not intervene or let someone intervene to the refrigerator without notifying the authorised services.
- For products with a freezer compartment; Do not eat cone ice cream and ice cubes immediately after you take them out of the freezer compartment! (This may cause frostbite in your mouth.)
- For products with a freezer compartment; Do not put bottled and canned liquid beverages in the freezer compartment. Otherwise, these may burst.
- Do not touch frozen food by hand; they may stick to your hand.
- Unplug your refrigerator before cleaning or defrosting.
- Vapor and vaporized cleaning materials should never be used in cleaning and defrosting processes of your refrigerator. In such cases, the vapor may get in contact with the electrical parts and cause short circuit or electric shock.
- Never use the parts on your refrigerator such as the door as a means of support or step.
- Do not use electrical devices inside the refrigerator.
- Do not damage the parts, where the refrigerant is circulating, with drilling or cutting tools. The refrigerant that might blow out when the gas channels of the evaporator, pipe extensions or surface coatings are punctured causes skin irritations and eye injuries.
- Do not cover or block the ventilation holes on your refrigerator with any material.
- Electrical devices must be repaired by only authorised persons. Repairs performed by incompetent persons create a risk for the user.
- In case of any failure or during a maintenance or repair work, disconnect your refrigerator's mains supply by either turning off the relevant fuse or unplugging your appliance.
- Do not pull by the cable when pulling off the plug.

- Place the beverage with higher proofs tightly closed and vertically.
- Never store spray cans containing flammable and explosive substances in the refrigerator.
- Do not use mechanical devices or other means to accelerate the defrosting process, other than those recommended by the manufacturer.
- This product is not intended to be used by persons with physical, sensory or mental disorders or unlearned or inexperienced people (including children) unless they are attended by a person who will be responsible for their safety or who will instruct them accordingly for use of the product
- Do not operate a damaged refrigerator. Consult with the service agent if you have any concerns.

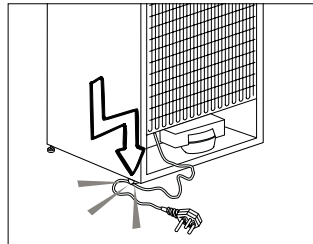

- Electrical safety of your refrigerator shall be guaranteed only if the earth system in your house complies with standards.
- Exposing the product to rain, snow, sun and wind is dangerous with respect to electrical safety.
- Contact authorized service when there is a power cable damage to avoid danger.
- Never plug the refrigerator into the wall outlet during installation. Otherwise, risk of death or serious injury may arise.
- This refrigerator is intended for only storing food items. It must not be used for any other purpose.
- Label of technical specifications is located on the left wall inside the refrigerator.
- Never connect your refrigerator to electricity-saving systems; they may damage the refrigerator.
- If there is a blue light on the refrigerator, do not look at the blue light with optical tools.
- For manually controlled refrigerators, wait for at least 5 minutes to start the refrigerator after power failure.
- This operation manual should be handed in to the new owner of the product when it is given to others.
- Avoid causing damage on power cable when transporting the refrigerator. Bending cable may cause fire. Never place heavy objects on power cable. Do not touch the plug with wet hands when plugging the product.
- Do not plug the refrigerator if the wall outlet is loose.
- Water should not be sprayed directly on inner or outer parts of the product for safety purposes.
- Do not spray substances containing inflammable gases such as propane gas near the refrigerator to avoid fire and explosion risk.
- Never place containers filled with water on top of the refrigerator, otherwise this may cause electric shock or fire.
- Do not overload your refrigerator with excessive amounts of food. If overloaded, the food items may fall down and hurt you and damage refrigerator when you open the door. Never place objects on top of the refrigerator; otherwise, these objects may fall down when you open or close the refrigerator's door.
- As they require a precise temperature, vaccines, heat-sensitive medicine and

scientific materials and etc. should not be kept in the refrigerator.

- If not to be used for a long time, refrigerator should be unplugged. A possible problem in power cable may cause fire.
- The plug's tip should be regularly cleaned; otherwise, it may cause fire.
- The plug's tip should be cleaned regularly with a dry cloth; otherwise, it may cause fire.
- Refrigerator may move if adjustable legs are not properly secured on the floor. Properly securing adjustable legs on the floor can prevent the refrigerator to move.
- When carrying the refrigerator, do not hold it from door handle. Otherwise, it may be snapped.
- When you have to place your product next to another refrigerator or freezer, the distance between devices should be at least 8cm. Otherwise, adjacent side walls may be humidified.

## For products with a water dispenser;

Pressure of water mains should be minimum 1 bar. Pressure of water mains should be maximum 8 bars.

- Use only potable water.

## Child safety

- If the door has a lock, the key should be kept away from reach of children.
- Children must be supervised to prevent them from tampering with the product.

## HCA Warning

### If your product's cooling system contains R600a:

This gas is flammable. Therefore, pay attention to not damaging the cooling system and piping during usage and transportation. In the event of damage, keep your product away from potential fire sources that can cause the product catch a fire and ventilate the room in which the unit is placed.

### Ignore this warning if your product's cooling system contains R134a.

Type of gas used in the product is stated in the type plate which is on the left wall inside the refrigerator.

Never throw the product in fire for disposal.

## Things to be done for energy saving

- Do not leave the doors of your refrigerator open for a long time.
- Do not put hot food or drinks in your refrigerator.
- Do not overload your refrigerator so that the air circulation inside of it is not prevented.
- Do not install your refrigerator under direct sunlight or near heat emitting appliances such as ovens, dishwashers or radiators.
- Pay attention to keep your food in closed containers.
- For products with a freezer compartment; You can store maximum amount of food items in the freezer when you remove the shelf or drawer of the freezer. Energy consumption value stated for your refrigerator has been determined by removing freezer shelf or drawer and under maximum load. There is no harm to use a shelf or drawer according to the shapes and size of food to be frozen.
- For energy saving purposes, there must be left min. 8 cm between the rear panel of the appliance and the wall where it is located. Energy consumption and energy label of the appliance was declared accordingly.
- Do not place foodstuffs in front of air outlets and do not obstruct air flow channels when loading.
- Thawing frozen food in fridge compartment will both provide energy saving and preserve the food quality.



### 3 Installation

⚠ Please remember that the manufacturer shall not be held liable if the information given in the instruction manual is not observed.

#### Points to be considered when re-transporting your refrigerator

1. Your refrigerator must be emptied and cleaned prior to any transportation.
2. Shelves, accessories, crisper and etc. in your refrigerator must be fastened securely by adhesive tape against any jolt before repackaging.
3. Packaging must be tied with thick tapes and strong ropes and the rules of transportation printed on the package must be followed.

#### Please do not forget...

Every recycled material is an indispensable source for the nature and for our national resources.

If you wish to contribute to recycling the packaging materials, you can get further information from the environmental bodies or local authorities.

#### Before operating your refrigerator

Before starting to use your refrigerator check the following:

1. Is the interior of the refrigerator dry and can the air circulate freely in the rear of it?

2. Please install the 2 plastic wedges as illustrated in the figure. Plastic wedges will provide the required distance between your refrigerator and the wall in order to allow the air circulation. (The illustrated figure is only an example and does not match exactly with your product.)

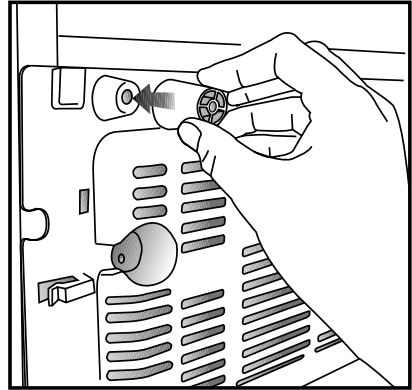

3. Clean the interior of the refrigerator as recommended in the "Maintenance and cleaning" section.
4. Plug the refrigerator into the wall outlet. When the fridge door is open, the fridge compartment interior light will come on.
5. You will hear a noise as the compressor starts up. The liquid and gases sealed within the refrigeration system may also give rise to noise, even if the compressor is not running and this is quite normal.
6. Front edges of the refrigerator may feel warm. This is normal. These areas are designed to be warm to avoid condensation.

## Electric connection

Connect your product to a grounded socket which is being protected by a fuse with the appropriate capacity.

Important:

- The connection must be in compliance with national regulations.
- The power cable plug must be easily accessible after installation.
- The specified voltage must be equal to your mains voltage.
- Extension cables and multiway plugs must not be used for connection.

⚠ A damaged power cable must be replaced by a qualified electrician.

⚠ Product must not be operated before it is repaired! There is danger of electric shock!

## Disposing of the packaging

The packing materials may be dangerous for children. Keep the packing materials out of the reach of children or dispose of them by classifying them in accordance with the waste instructions. Do not dispose of them along with the normal household waste.

The packing of your refrigerator is produced from recyclable materials.

## Disposing of your old refrigerator

Dispose of your old refrigerator without giving any harm to the environment.

- You may consult your authorised dealer or waste collection center of your municipality about the disposal of your refrigerator.

Before disposing of your refrigerator, cut out the electric plug and, if there are any locks on the door, make them inoperable in order to protect children against any danger.

## Placing and Installation

⚠ If the entrance door of the room where the refrigerator will be installed is not wide enough for the refrigerator to pass through, then call the authorised service to have them remove the doors of your refrigerator and pass it sideways through the door.

1. Install your refrigerator to a place that allows ease of use.

2. Keep your refrigerator away from heat sources, humid places and direct sunlight.

3. There must be appropriate air ventilation around your refrigerator in order to achieve an efficient operation. If the refrigerator is to be placed in a recess in the wall, there must be at least 5 cm distance with the ceiling and at least 5 cm with the wall. If the floor is covered with a carpet, your product must be elevated 2.5 cm from the floor.

4. Place your refrigerator on an even floor surface to prevent jolts.

5. Do not keep your refrigerator in ambient temperatures under 10°C.

## Adjusting the legs

If your refrigerator is unbalanced;

You can balance your refrigerator by turning its front legs as illustrated in the figure. The corner where the leg exists is lowered when you turn in the direction of black arrow and raised when you turn in the opposite direction. Taking help from someone to slightly lift the refrigerator will facilitate this process.

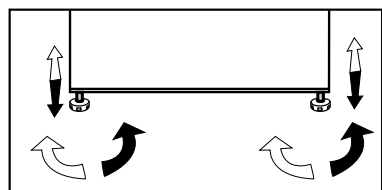

## 4 Preparation

---

- i** Your refrigerator should be installed at least 30 cm away from heat sources such as hobs, ovens, central heater and stoves and at least 5 cm away from electrical ovens and should not be located under direct sunlight.
- i** The ambient temperature of the room where you install your refrigerator should at least be 10°C. Operating your refrigerator under cooler conditions is not recommended with regard to its efficiency.
- i** Please make sure that the interior of your refrigerator is cleaned thoroughly.
- i** If two refrigerators are to be installed side by side, there should be at least 2 cm distance between them.
- i** When you operate your refrigerator for the first time, please observe the following instructions during the initial six hours.
  - The door should not be opened frequently.
  - It must be operated empty without any food in it.
  - Do not unplug your refrigerator. If a power failure occurs out of your control, please see the warnings in the “Recommended solutions for the problems” section.
- i** Original packaging and foam materials should be kept for future transportations or moving.

## 5 Using your refrigerator

### Indicator Panel

Indicator panel aids in using your refrigerator with its audio and visual functions.

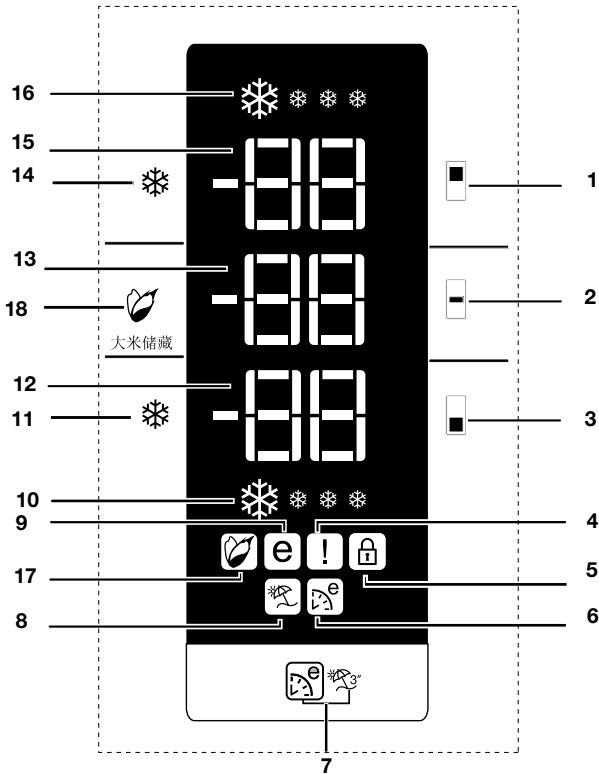

1. Fridge compartment temperature setting button
2. Multizone compartment temperature setting button
3. Freezer compartment temperature setting button
4. Error status indicator
5. Key lock function indicator
6. Eco Extra function indicator
7. Eco Extra / Vacation function Button
8. Vacation function indicator
9. Economic usage indicator
10. Quick fridge function indicator
11. Quick fridge function button
12. Freezer compartment temperature setting indicator
13. Multizone compartment temperature setting indicator
14. Fast freeze function button
15. Fridge compartment temperature setting indicator
16. Fast Freeze Function Indicator
17. Rice function indicator
18. Rice function button

## **1. Fridge Compartment**

### **Temperature Setting Button**

This button allows you to set the freezer compartment temperature. Press this button to set the temperature of the freezer compartment to -18,-19, -20,-21,-22,-23 and -24, respectively.

## **2. Multi Zone Storage**

### **Compartment Temperature Setting Button**

You can set the Multi Zone Storage Compartment either as a Freezer or a Cooler. Press and hold this button for 3 seconds to set the Multi Zone Storage Compartment either as a Freezer or a Cooler. This compartment is set as a Freezer Compartment at factory.

If the Multi Zone Storage Compartment is set as a Freezer, then the temperature of the Multi Zone Storage Compartment will change as -18,-19,-20,-21,-22,-23 -24, -18... respectively each time you press this button. If the Multi Zone Compartment is set as a Fridge, then the temperature of the Multi Zone Compartment will change as 10, 8, 6, 4, 2, 0, -6, ... respectively each time you press this button.

## **3. Freezer Compartment**

### **Temperature Setting Button**

This button allows you to make the fridge compartment temperature setting. Press this button to set the temperature of the fridge compartment to 8,7,6,5,4,3, 2,respectively.

## **4. Error Status Indicator**

If your refrigerator does not cool adequately or if there is a sensor failure, this indicator will be activated. When this indicator is active, Freezer Compartment Temperature indicator will display "E" and Fridge Compartment Temperature Indicator will display numbers such as "1,2,3...". These numbers on the indicator provide information about the error to the service personnel.

When you place hot food into the freezer compartment or if you leave the door open for a long time, exclamation mark can illuminate for some time. This is not a failure; this warning will disappear when the food cools down.

## **5. Key Lock Function Indicator**

Use this function if you do not want your refrigerator temperature setting changed.

To activate this function, you should press and hold Fast Freeze and Quick Fridge buttons together for 3 seconds.

## **6. Eco Extra Function Indicator**

It indicates that the Eco-Extra function is active.

If this function is active, your refrigerator will automatically detect the least usage periods and energy-efficient cooling will be performed during those times. Economy indicator will be active while energy-efficient cooling is performed.

Press the relevant button again to deactivate this function.

## **7. Eco Extra / Vacation Function Button**

Press this button briefly to activate the Eco Extra function. Press and hold this button for 3 sec. to activate the Vacation function. Press this button again to deactivate the selected function.

## **8. Vacation Function Indicator**

Indicates that the vacation function is active.

If this function is active, "- -" appears on the temperature indicator of the fridge compartment and no cooling is performed in the fridge compartment. Other compartments will be cooled in accordance with the temperature set for them.

Press the relevant button again to deactivate this function.

## **9. Economy Mode Indicator**

Indicates that the refrigerator is running in energy-efficient mode. Freezer Compartment temperature

This indicator will be active if the function is set to -18 or the energy efficient cooling is being performed due to Eco-Extra function.

#### **10. Quick Fridge Function Indicator**

This icon flashes in an animated style when the Quick Fridge function is active.

#### **11. Quick Fridge Function Button**

When you press the Quick Fridge button, the temperature of the compartment will be colder than the adjusted values.

This function can be used for food placed in the fridge compartment and required to be cooled down rapidly.

If you want to cool large amounts of fresh food, it is recommended to activate this feature before putting the food into the fridge.

Quick Fridge indicator turns on when the Quick Fridge function is on. To cancel this function, press Quick Fridge button again.

If you do not cancel it, Quick Fridge will cancel itself automatically after 2 hours or when the fridge compartment reaches to the required temperature.

This function is not recalled when power restores after a power failure.

#### **12. Freezer Compartment Temperature Setting Indicator**

Indicates the temperature set for the Freezer Compartment.

#### **13. Multizone Compartment Temperature Setting Indicator**

Indicates the temperature set for Multi Zone storage compartment.

#### **14. Fast Freeze Function Button**

Fast Freeze indicator turns on when the Fast Freeze function is active. To cancel this function, press Fast Freeze button again. Fast Freeze indicator will turn off and return to its normal settings. If you do not cancel it, Fast Freeze will cancel itself automatically after 8 hours or when the freezer compartment reaches to the

required temperature.

If you want to freeze large amounts of fresh food, press the Fast Freeze button before putting the food into the freezer compartment.

If you press the Fast Freeze button repeatedly with short intervals, the electronic circuit protection will be activated and the compressor will not start up immediately.

This function is not recalled when power restores after a power failure.

#### **15. Fridge Compartment Temperature Setting Indicator**

Indicates the temperature set for the Fridge Compartment.

#### **16. Fast Freeze Function Indicator**

This icon flashes in an animated style when the Fast Freeze function is active.

#### **17. Rice Function Indicator**

This icon flashes in an animated style when the rice function is active.

#### **18. Rice Function Button**

When you press the Rice function button, the temperature of the multizone section will be set automatically to the appropriate temperature setting for keeping rice fresh for a long time.

To cancel this function press Rice Button again.

## Door Open Warning

**(This feature may vary depending on the door of the product and may not exist in some models.)**

An audio warning signal will be given when the door of your product is left open for at least 1 minute. This warning will be muted when the door is closed or any of the display buttons (if any) are pressed.

## Dual cooling system:

Your refrigerator is equipped with two separate cooling systems to cool the fresh food compartment and freezer compartment. Thus, air in the fresh food compartment and freezer compartment do not get mixed. Thanks to these two separate cooling systems, cooling speed is much higher than other refrigerators. Odours in the compartments do not get mixed. Also additional power saving is provided since the defrosting is performed individually.

## Freezing fresh food

- Wrap or cover the food before placing them in the refrigerator.
- Hot food must cool down to the room temperature before putting them in the refrigerator.
- The foodstuff that you want to freeze must be fresh and in good quality.
- Foodstuff must be divided into portions according to the family's daily or meal based consumption needs.
- The foodstuff must be packaged in an airtight manner to prevent them from drying even if they are going to be kept for a short time.
- Materials to be used for packaging must be tear-proof and resistant to cold, humidity, odor, oils and acids and they must also be airtight. Moreover, they must be well closed and they must be made from easy-to-use materials that are suitable for deep freeze usage.
- Frozen food must be used immediately after they are thawed and they should never be re-frozen.
- Please observe the following instructions to obtain the best results.
  1. Do not freeze too large quantities of food at one time. The quality of the food is best preserved when it is frozen right through to the core as quickly as possible.
  2. Placing warm food into the freezer compartment causes the cooling system to operate continuously until the food is frozen solid.
  3. Take special care not to mix already frozen food and fresh food.

Freezer Compartment Setting	Fridge Compartment Setting	Explanations
-18°C	4°C	This is the normal recommended setting.
-20,-22 or -24°C	4°C	These settings are recommended when the ambient temperature exceeds 30°C.
Quick Freeze	4°C	Use when you wish to freeze your food in a short time. Your refrigerator will return to its previous mode when the process is over.
-18°C or colder	2°C	If you think that your fridge compartment is not cold enough because of the hot conditions or frequent opening and closing of the door.
-18°C or colder	Quick Fridge	You can use it when your fridge compartment is overloaded or if you wish to cool down your food rapidly. It is recommended that you activate quick fridge function 4-8 hours before placing the food.

## Recommendations for preservation of frozen food

- Prepacked commercially frozen food should be stored in accordance with the frozen food manufacturer's instructions for a  ( 4 star) frozen food storage compartment.
- To ensure that the high quality achieved by the frozen food manufacturer and the food retailer is maintained, the following should be remembered:
  1. Put packages in the freezer as quickly as possible after purchase.
  2. Ensure that contents are labeled and dated.
  3. Do not exceed "Use By", "Best Before" dates on the packaging.

### Defrosting

The freezer compartment defrosts automatically.



## Reccomendations for freshfood compartment

- Please do not let any foodstuff to come to contact with the temperature sensor in freshfood compartment. In order to maintain freshfood compartment at ideal storage temperature, the sensor must not be blocked by fodstuffs.
- Do not place hot foodstuff in your appliance.

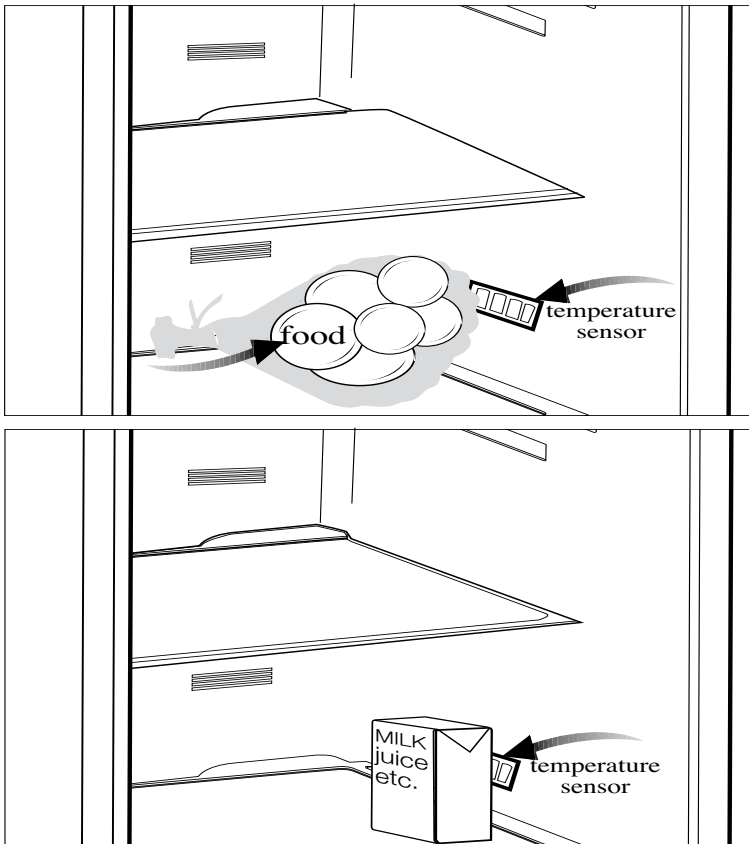

## Egg holder

You can install the egg holder to the desired door or body shelf.

Never store the egg holder in the freezer compartment

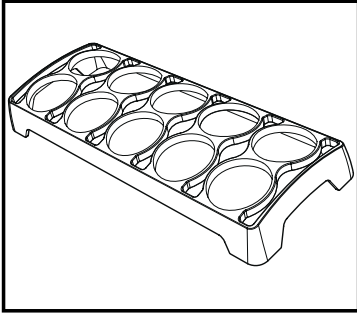

## Blue light

(in some models)

Foodstuff stored in the crispers that are enlightened with a blue light continue their photosynthesis by means of the wavelength effect of blue light and thus, preserve their freshness and increase their vitamin content.



## Placing the food

Freezer compartment shelves	Various frozen food such as meat, fish, ice cream, vegetables and etc.
Egg holder	Egg
Fridge compartment shelves	Food in pans, covered plates and closed containers
Fridge compartment door shelves	Small and packaged food or drinks (such as milk, fruit juice and beer)
Crisper	Vegetables and fruits
Freshzone compartment	Delicatessen products (cheese, butter, salami and etc.)

## Deep-freeze information

Food must be frozen as rapidly as possible when they are put in a refrigerator in order to keep them in good quality.

The TSE norm requires (according to certain measurement conditions) the refrigerator to freeze at least 4.5 kg of foodstuff at 32°C ambient temperature to -18°C or lower within 24 hours for every 100-liters of freezer volume.

It is possible to keep the food for a long time only at -18°C or lower temperatures.

You can keep the freshness of food for many months (at -18°C or lower temperatures in the deep freeze).

### ⚠ **WARNING!**

- Foodstuff must be divided into portions according to the family's daily or meal based consumption needs.
- Foodstuff must be packaged in an airtight manner to prevent them from

drying even if they are going to be kept for a short time.

Materials necessary for packaging:

- Cold resistant adhesive tape
- Self adhesive label
- Rubber rings
- Pen

Materials to be used for packaging the foodstuff must be tear-proof and resistant to cold, humidity, odor, oils and acids.

Foodstuff to be frozen should not be allowed to come in contact with the previously frozen items to prevent their partial thawing.

Frozen food must be used immediately after they are thawed and they should never be re-frozen.

## Multi Zone Storage Compartment

The Multi Zone Storage Compartment of your refrigerator may be used in any desired mode by adjusting it to fridge (2/4/6/8 °C) or freezer (-18/-19/-20/-21/-22/-23/-24) temperatures. You can keep the compartment in the desired temperature with the Multi Zone Storage Compartment Temperature Setting Button. The temperature of Multi Zone Storage Compartment can be adjusted to -6, -2, 0 and 10 in addition to fridge compartment temperatures. "0" degree is used to store the deli products longer, and -6 degrees is used to keep the meats up to 2 weeks in an easily cuttable condition.

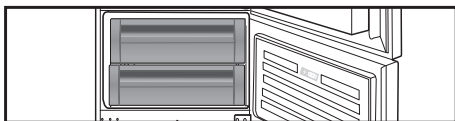

## Description and cleaning of odor filter:

Odor filter prevents unpleasant odor build-up in your refrigerator.

Pull the cover, into which the odor filter is installed, downwards and remove as illustrated. Leave the filter under sunlight for one day. Filter will be cleaned during this time. Install the filter back to its place.

Odor filter must be cleaned once in a year.

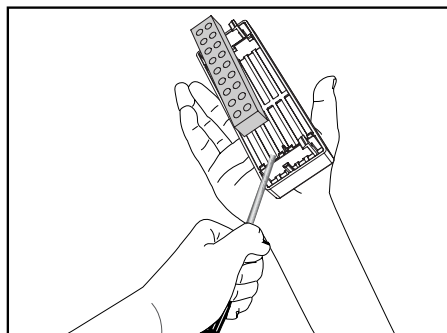
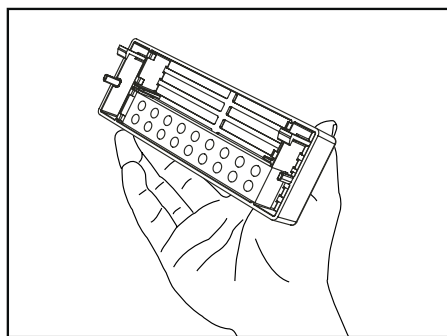
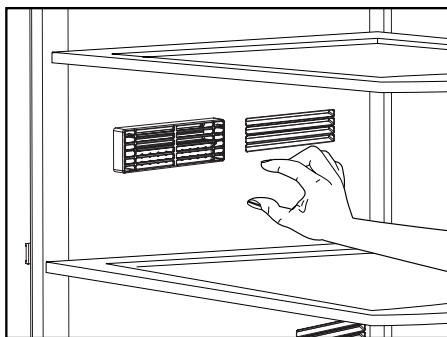

## 6 Maintenance and cleaning

---

- ⚠ Never use gasoline, benzene or similar substances for cleaning purposes.
- ⚠ We recommend that you unplug the appliance before cleaning.
- ⚠ Never use any sharp abrasive instrument, soap, household cleaner, detergent and wax polish for cleaning.
- ℹ Use lukewarm water to clean the cabinet of your refrigerator and wipe it dry.
- ℹ Use a damp cloth wrung out in a solution of one teaspoon of bicarbonate of soda to one pint of water to clean the interior and wipe it dry.
- ⚠ Make sure that no water enters the lamp housing and other electrical items.
- ⚠ If your refrigerator is not going to be used for a long period of time, unplug the power cable, remove all food, clean it and leave the door ajar.
- ℹ Check door seals regularly to ensure they are clean and free from food particles.
- ⚠ To remove door racks, remove all the contents and then simply push the door rack upwards from the base.

### Protection of plastic surfaces

- ℹ Do not put the liquid oils or oil-cooked meals in your refrigerator in unsealed containers as they damage the plastic surfaces of your refrigerator. In case of spilling or smearing oil on the plastic surfaces, clean and rinse the relevant part of the surface at once with warm water.

## 7 Recommended solutions for the problems

Please review this list before calling the service. It might save you time and money. This list includes frequent complaints that are not arising from defective workmanship or material usage. Some of the features described here may not exist in your product.

The refrigerator does not operate.
<ul style="list-style-type: none"><li>• Is the refrigerator properly plugged in? Insert the plug to the wall socket.</li><li>• Is the fuse of the socket which your refrigerator is connected to or the main fuse blown out? Check the fuse.</li></ul>
Condensation on the side wall of the fridge compartment (MULTIZONE, COOL CONTROL and FLEXI ZONE).
<ul style="list-style-type: none"><li>• Very cold ambient conditions. Frequent opening and closing of the door. Highly humid ambient conditions. Storage of food containing liquid in open containers. Leaving the door ajar. Switching the thermostat to a colder degree.</li><li>• Decreasing the time the door left open or using it less frequently.</li><li>• Covering the food stored in open containers with a suitable material.</li><li>• Wipe the condensation using a dry cloth and check if it persists.</li></ul>
Compressor is not running
<ul style="list-style-type: none"><li>• Protective thermic of the compressor will blow out during sudden power failures or plug-out plug-ins as the refrigerant pressure in the cooling system of the refrigerator has not been balanced yet. Your refrigerator will start running approximately after 6 minutes. Please call the service if the refrigerator does not startup at the end of this period.</li><li>• The fridge is in defrost cycle. This is normal for a full-automatically defrosting refrigerator. Defrosting cycle occurs periodically.</li><li>• Your refrigerator is not plugged into the socket. Make sure that the plug is properly fit into the socket.</li><li>• Are the temperature adjustments correctly made?</li><li>• Power might be cut off.</li></ul>

The fridge is running frequently or for a long time.

- Your new product may be wider than the previous one. This is quite normal. Large refrigerators operate for a longer period of time.
- The ambient room temperature may be high. This is quite normal.
- The refrigerator might have been plugged in recently or might have been loaded with food. Cooling down of the refrigerator completely may last for a couple of hours longer.
- Large amounts of hot food might have been put in the refrigerator recently. Hot food causes longer running of the refrigerator until they reach the safe storage temperature.
- Doors might have been opened frequently or left ajar for a long time. The warm air that has entered into the refrigerator causes the refrigerator to run for longer periods. Open the doors less frequently.
- Freezer or fridge compartment door might have been left ajar. Check if the doors are tightly closed.
- The refrigerator is adjusted to a very low temperature. Adjust the refrigerator temperature to a warmer degree and wait until the temperature is achieved.
- Door seal of the fridge or freezer may be soiled, worn out, broken or not properly seated. Clean or replace the seal. Damaged/broken seal causes the refrigerator to run for a longer period of time in order to maintain the current temperature.

Freezer temperature is very low while the fridge temperature is sufficient.

- The freezer temperature is adjusted to a very low temperature. Adjust the freezer temperature to a warmer degree and check.

Fridge temperature is very low while the freezer temperature is sufficient.

- The fridge temperature might have been adjusted to a very low temperature. Adjust the fridge temperature to a warmer degree and check.

Food kept in the fridge compartment drawers are freezing.

- The fridge temperature might have been adjusted to a very low temperature. Adjust the fridge temperature to a warmer degree and check.

Temperature in the fridge or freezer is very high.

- The fridge temperature might have been adjusted to a very high degree. Fridge adjustment has an effect on the temperature of the freezer. Change the temperature of the fridge or freezer until the fridge or freezer temperature reaches to a sufficient level.
- Doors might have been opened frequently or left ajar for a long time; open them less frequently.
- Door might have been left ajar; close the door completely.
- Large amount of hot food might have been put in the refrigerator recently. Wait until the fridge or freezer reaches the desired temperature.
- The refrigerator might have been plugged in recently. Cooling down of the refrigerator completely takes time.

The operation noise increases when the refrigerator is running.
<ul style="list-style-type: none"> <li>The operating performance of the refrigerator may change due to the changes in the ambient temperature. It is normal and not a fault.</li> </ul>
Vibrations or noise.
<ul style="list-style-type: none"> <li>The floor is not even or it is weak. The refrigerator rocks when moved slowly. Make sure that the floor is strong enough to carry the refrigerator, and level.</li> <li>The noise may be caused by the items put onto the refrigerator. Items on top of the refrigerator should be removed.</li> </ul>
There are noises coming from the refrigerator like liquid spilling or spraying.
<ul style="list-style-type: none"> <li>Liquid and gas flows happen in accordance with the operating principles of your refrigerator. It is normal and not a fault.</li> </ul>
There is a noise like wind blowing.
<ul style="list-style-type: none"> <li>Fans are used in order to cool the refrigerator. It is normal and not a fault.</li> </ul>
Condensation on the inner walls of refrigerator.
<ul style="list-style-type: none"> <li>Hot and humid weather increases icing and condensation. It is normal and not a fault.</li> <li>Doors might have been left ajar; make sure that the doors are closed fully.</li> <li>Doors might have been opened frequently or left ajar for a long time; open them less frequently.</li> </ul>
Humidity occurs on the outside of the refrigerator or between the doors.
<ul style="list-style-type: none"> <li>There might be humidity in the air; this is quite normal in humid weather. When the humidity is less, condensation will disappear.</li> </ul>
Bad odour inside the refrigerator.
<ul style="list-style-type: none"> <li>Inside of the refrigerator must be cleaned. Clean the inside of the refrigerator with a sponge, lukewarm water or carbonated water.</li> <li>Some containers or package materials might cause the smell. Use a different container or different brand packaging material.</li> </ul>
The door is not closing.
<ul style="list-style-type: none"> <li>Food packages may prevent the door's closing. Replace the packages that are obstructing the door.</li> <li>The refrigerator is not completely upright on the floor and rocking when slightly moved. Adjust the elevation screws.</li> <li>The floor is not level or strong. Make sure that the floor is level and capable to carry the refrigerator.</li> </ul>
Crispers are stuck.
<ul style="list-style-type: none"> <li>The food might be touching the ceiling of the drawer. Rearrange food in the drawer.</li> </ul>

## 请首先阅读本手册！

亲爱的顾客，  
我们的产品使用先进设备生产，并通过严格的质量控制步骤检测，希望为您提供高效的服务。

因此，建议您在使用本产品前仔细阅读本手册，并妥善保管，以备日后参考。



## 本手册

- 帮助您快速、安全地使用本装置。
- 安装和操作本产品前，阅读本手册。
- 遵循说明，尤其是安全方面。
- 将手册置于触手可及之处，以便随时参考。
- 此外，也请阅读本产品附带的其它文件。

请注意，本手册可能也适用于其它型号。

## 符号及其说明

本手册包含下列符号：

-  重要信息或者有用的使用提示。
-  防止生命和财产危险的警告。
-  电压警告。

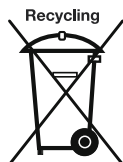

本产品带有报废电子电气设备（WEEE）的选择性分类符号。

这意味着，本产品必须根据欧洲指令 2002/96/EC 进行处置，以便进行回收或拆解，使其对环境的影响降到最低。欲获取详细信息，请与当地或地区的权利机构联系。

没有包含在选择分类过程中的电子产品由于危险物质的存在，可能对环境 and 人类健康带来威胁。



## 目录

---

<b>1 冰箱</b>	<b>3</b>	<b>5 使用冰箱</b>	<b>11</b>
<b>2 重要安全警告</b>	<b>4</b>	指示灯面板 .....	11
指定使用 .....	4	冰箱门未关警告 .....	14
对于配备饮水机的产品: .....	6	双冷却系统: .....	14
儿童安全 .....	6	冷冻新鲜食物 .....	14
HCA 警告 .....	6	冷冻食物储藏建议 .....	15
节能措施 .....	7	新鲜食物区的建议 .....	16
<b>3 安装</b>	<b>8</b>	放置食物 .....	17
再次运输冰箱时考虑的事项 .....	8	深度冷冻信息 .....	17
操作冰箱前 .....	8	蛋托 .....	17
电气连接 .....	9	蓝色光 .....	17
处置包装 .....	9	变温储藏室 .....	18
处置旧冰箱 .....	9	异味过滤器说明和清洁: .....	18
放置和安装 .....	9	<b>6 维护和清洁</b>	<b>19</b>
调整支腿 .....	9	保护塑料表面 .....	19
<b>4 准备</b>	<b>10</b>	<b>7 问题解决建议</b>	<b>20</b>

# 1 冰箱

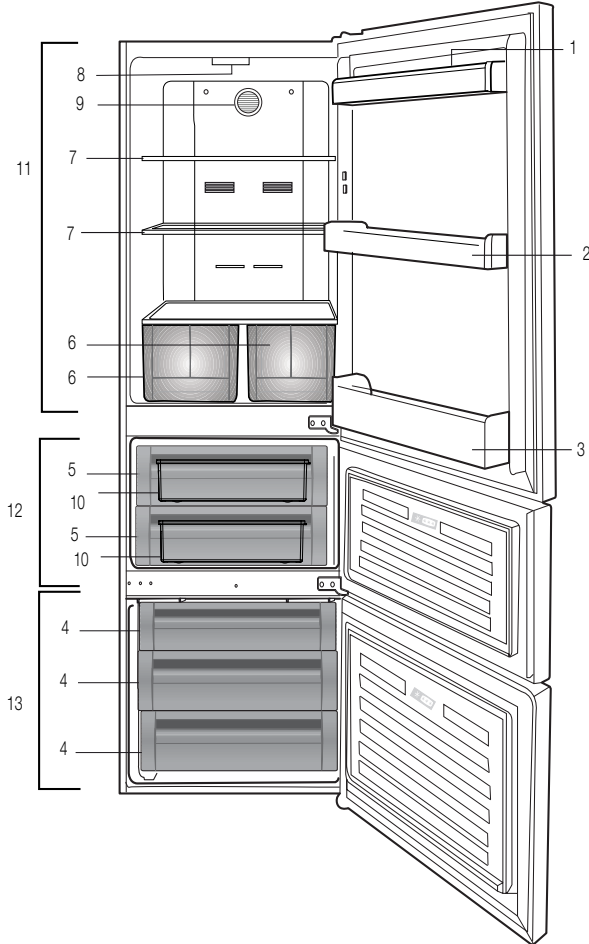

- |               |         |
|---------------|---------|
| 1. 蛋托         | 8. 照明   |
| 2. 冷藏室搁架      | 9. 风扇   |
| 3. 瓶架         | 10. 储米盒 |
| 4. 冷冻室抽屉      | 11. 冷藏室 |
| 5. 多功能区抽屉     | 12. 变温室 |
| 6. 果蔬盒 (点心隔间) | 13. 冷冻室 |
| 7. 玻璃架        |         |

**ⓘ** 本手册中的图片仅为示意性质，可能与您的产品不完全相符。如果主体零件没有包含在您购买的产品当中，表明其适用于其它型号。

## 2 重要安全警告

请遵循下列信息。否则，可能导致受伤或重大损坏。且所有的保修和可靠性承诺将失效。

本装置的使用寿命为 10 年。这是保留本装置正常操作所需备件的期限。

### 指定使用

本产品拟用于

- 室内和封闭的区域，例如，家庭环境；
- 在封闭的工作环境，例如，店铺和办公室；
- 在封闭的膳宿设施内，例如，农场，宾馆和膳宿公寓。
- 本产品不得在户外使用。

### 一般安全性

- 您想要处置/废弃本产品时，我们建议您咨询授权服务机构，以便了解必要的信息和授权机构。
- 对于与冰箱有关的所有问题和疑问，请咨询授权服务机构。在没有通知授权服务机构前，请勿自行干预或者让他人干预冰箱。
- 请勿立即食用从冷冻室中取出的锥形冰淇淋和方块冰。（这可能导致您的口腔冻伤。）
- 对于配备冷冻室的产品：请勿将瓶装和灌装液体饮料放在冷冻室内。否则，其可能爆裂。
- 请勿用手接触冷冻食物；其可能粘到您的手上。
- 清洁或除霜前，请拔下冰箱插头。
- 切勿在冰箱清洁和除霜过程中使用蒸汽和气化清洁材料。此类情况下，蒸汽可能与电气零件接触，导致短路或触电。
- 请勿使用冰箱上的零件，例如，将冰箱门作为支撑或梯子。
- 请勿使用冰箱内的电气装置。
- 请勿使用钻孔或切割工具损坏零件，制冷剂在这里循环。在蒸发器的气体通道、管道扩充件或者表面涂层被刺穿后，制冷剂可能流出，导致皮肤受到刺激和眼睛受伤。
- 请勿使用任何材料，覆盖或堵塞冰箱的通风孔。
- 电气设施必须由经授权的人员维修。无资质人员实施的维修会给用户带来危险。
- 如果发生任何故障，或者在实施维护或维修作业的过程中，应当通过关闭相关保险丝或者拔下插头，断开冰箱的电源。
- 拔下插头时，请勿拉拔电缆。

- 放置饮料时，注意盖牢瓶盖，且垂直放置。
- 切勿在冰箱内存放含有易燃和易爆物质的喷雾罐。
- 请勿使用机械装置或者其它手段，加速除霜过程，除非制造商建议这样做。
- 本装置并非设计供体力、感知力或脑力下降或经验和知识缺乏的人士（包括孩子）使用，除非有负责他们安全的人员给出有关装置之使用的监督或指导。
- 请勿操作受损的冰箱。如果有任何问题，请咨询维修代理。
- 只有您家中的接地系统符合标准时，才能担保冰箱的电气安全。
- 本产品淋雨、落雪、受到阳光照射和风吹在电气安全方面是危险的。
- 在电源线损坏时，请致电授权服务中心，以免发生任何危险。
- 安装过程中，切勿将冰箱的插头插入壁式插座。否则，可能出现严重的人身伤亡。
- 冰箱仅用于存放食物。其不得用于任何其它目的。
- 技术规范标签位于冰箱内左壁。
- 请勿将冰箱连接至节能系统，否则，可能导致冰箱受损。
- 如果冰箱配备有蓝色灯，请勿通过光学装置查看蓝光。

- 对于手动控制的冰箱，在发生电力故障后，请至少等待 5 分钟，才可以重新启动冰箱。
- 如果转让本产品，应当连同该操作手册一同移交给新用户。
- 运输冰箱时，避免导致电源线损坏。弯曲电缆可能导致起火。切勿在电源线上放置重物。为本产品插入插头时，请勿用潮湿的手接触插头。

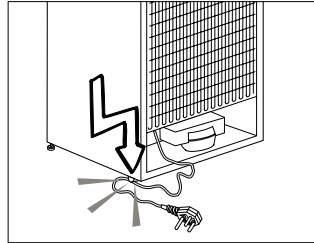

- 如果壁式插座松脱，请勿连接冰箱插头。
- 出于安全的原因，请勿将水直接喷到本产品内部或外部的零件上。
- 请勿在冰箱附近喷洒含有易燃气体的物质，例如，丙烷气，以免发生起火或爆炸之危险。
- 切勿将充满水的容器放在冰箱顶部，否则，可能导致触电或起火。
- 冰箱不可装入过多的食物。如果过度装满，在您打开冰箱门时，食物可能掉落，导致您受伤和冰箱受损。请勿在冰箱顶部放置物体，在打开或关闭冰箱门时，其容易掉落下来。

- 请勿在冰箱内存放要求精确温度的物品（疫苗、对温度敏感的药品，科学材料等）。
- 如果长时间不使用冰箱，应当拔下插头。电源线可能存在的问题会导致起火。
- 应定期清洁插头尖；否则，可能导致起火。
- 应定期使用干抹布清洁插头尖；否则，可能导致起火。
- 如果可调支腿没有适当固定在地面上，冰箱可能移动。在地面上适当固定可调支腿可以防止冰箱移动。
- 移动冰箱时，请勿在门把手上用力。否则，其可能折断。
- 必须将该产品与其它冰箱或制冷器并排放置时，这些装置之间的距离至少应为 8cm。否则，相邻的侧壁可能会出现冷凝水。

## 对于配备饮水机的产品：

水源的压力应至少为 1 巴。水源的压力最高为 8 巴。

- 只能使用饮用水。

## 儿童安全

- 如果门上有锁，钥匙应置于儿童不可及之处。
- 必须看管儿童，以免其摆弄本产品。

## HCA 警告

如果本产品的制冷系统含有 R600a：

此气体易燃。因此，在使用和运输过程中，注意不要损坏制冷系统和管道。如果发生损坏，本产品应远离可能导致着火的潜在火源，并给其所在的房间通风。

如果本产品的制冷系统含有 R134a，可以忽略该警告。

本产品中使用的气体类型在位于冰箱内部左壁上的铭牌上注明。

废弃该产品时，请勿将其投入火中。

## 节能措施

- 请勿长时间敞开冰箱门。
- 请勿在冰箱内放置灼热的食物或饮料。
- 冰箱不可过载，以致妨碍内部的空气循环。
- 请勿在受到阳光直射或者靠近发热装置（例如，烤箱、洗碗机或暖气）的位置安装冰箱。
- 注意在封闭的容器内保存食品。
- 对于配备冷冻室的产品；在拆下冷冻室的搁架或抽屉后，可以在冰箱的冷冻室放置最大数量的食物。声明的冰箱能耗值是在拆卸了冷冻室搁架或抽屉，并在放入最大数量的食物后确定的。根据要冷冻的食物形状和大小使用搁架或抽屉是安全的。
- 出于节能之目的，在装置后面板和其所在墙壁位置之间，必须至少留有 8 cm 的间隙。装置能源消耗和能量标签已相应声明。
- 请勿在空气出口前部放置食物，放置食物时，亦不得阻碍气流通道。
- 在冷藏室为冷冻的食物解冻具有节能的效果，并可以有效保持食品质量。

### 3 安装

⚠ 请注意，如果没有遵循本手册中的信息，制造商对于发生的损害不承担任何责任。

#### 再次运输冰箱时考虑的事项

1. 在任何运输前，冰箱必须清空和保持清洁。
2. 重新包装前，冰箱内的搁板、附件、果蔬盒等必须用胶带牢牢固定，防止摇晃。
3. 包装必须使用厚胶带和粗大的绳子扎紧，并遵循包装上印刷的运输规则。

#### 请牢记.....

每种回收材料对于大自然和我们国家的资源而言都是不可缺少的。

如果您希望对回收包装材料有所作为，可以从环境机构或者当地权力部门获取详细信息。

#### 操作冰箱前

开始使用冰箱前，检查下列内容：

1. 冰箱内部是否干燥，和空气能否在冰箱后面自由流通？

2. 安装 2 个塑料楔子，如图所示。塑料楔子将在冰箱与墙壁之间提供必要的距离，以允许空气流通。（插图仅为示例性质，可能不与您的产品完全相符。）

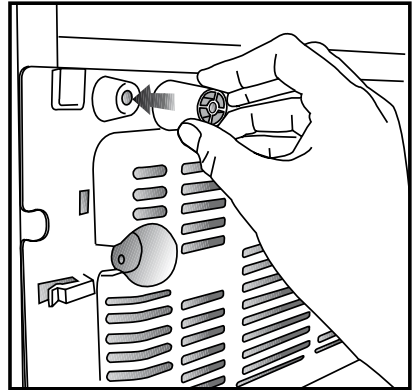

3. 按照“维护和清洁”章节中的建议，清洁冰箱内部。
4. 将冰箱插头插入壁式插座。冷藏室门打开时，内部相关的灯会亮起。
5. 在压缩机启动时，您将听到一个声音。即使压缩机没有运转，制冷系统中密封的液体和气体也可能产生噪声，这是正常的。
6. 可能感觉到冰箱的前边温度升高。这是正常的。这些区域设计保持温暖，以免发生冷凝。

## 电气连接

将本品连接至由适当容量之保险丝保护的接地插座。

重要信息：

- 连接必须符合国家规定。
- 安装后，电源线插头必须触手可及。
- 指定的电压必须等于电源电压。
- 连接时，请勿使用扩充电缆和多路插头。

⚠ 受损的电源线必须由具备资格的电工更换。

⚠ 本品在维修妥当前，切勿操作！有触电的危险！

## 处置包装

包装材料可能给儿童带来危险。将包装材料置于儿童不可及之处，或者根据垃圾说明进行分类和处置。请勿随日常生活垃圾一起处置。

冰箱的包装使用可回收材料制成。

## 处置旧冰箱

处置旧冰箱时，请不要给环境带来任何危害。

- 有关冰箱的处置，您可以咨询授权经销商或者市政部门的垃圾收集中心。

处置冰箱前，请切断电源插头，而且，如果门上有锁的话，请务必使之不可用，以免儿童有任何危险。

## 放置和安装

⚠ 如果安装冰箱之房间的房门不够宽，以致冰箱无法通过，可以致电授权服务机构，请他们拆下冰箱门，并侧着穿过房门。

1. 将冰箱安装在方便使用的位置。
2. 冰箱应远离热源和潮湿的场所并避免受到阳光直射。
3. 在冰箱周围必须有适当的通风，以便获得高效的操作。如果冰箱放置在墙壁内的凹口，距离天花板和墙壁必须至少 5 cm。如果地板上覆盖有地毯，本产品必须从地面升高 2.5 cm。
4. 将冰箱放置在平坦的地板表面，防止晃动。
5. 请勿将冰箱置于低于 10° C 的环境温度。

## 调整支腿

如果冰箱失衡：

您可以如图所示，转动其前部的支腿，使冰箱平衡。在黑色箭头的方向转动时，支腿所在的一角降低，在相反的方向转动时，其升高。由他人协助您轻微抬高冰箱将方便这一过程的实施。

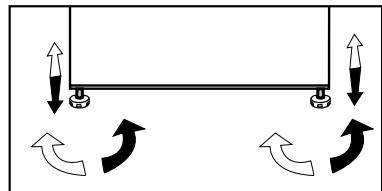



## 4 准备

---

- i** 冰箱的安装位置距离热源（例如，炉圈、烤箱、中央加热器和炉灶）至少 30 cm，距离电烤箱至少 5 cm，且不得受到阳光直射。
- i** 安装冰箱的房间温度至少为 10° C。考虑到冰箱的效率，不建议在低于该温度的条件下操作冰箱。
- i** 请务必彻底清洁冰箱的内部。
- i** 如果并排安装两台冰箱，必须至少间隔 2 cm。
- i** 初次操作冰箱时，在最初的六个小时内，请遵循下列说明。
  - 不应经常打开冰箱门。
  - 必须在里面没有任何食物时空置操作。
  - 请勿拔下冰箱的插头。如果发生的电力故障不在您控制范围内，请参见“问题解决建议”章节中的警告。
- i** 应当妥善保管原始包装和泡沫材料，以备日后运输或移动。

## 5 使用冰箱

### 指示灯面板

指示灯面板帮助您使用冰箱的音频和可视功能。

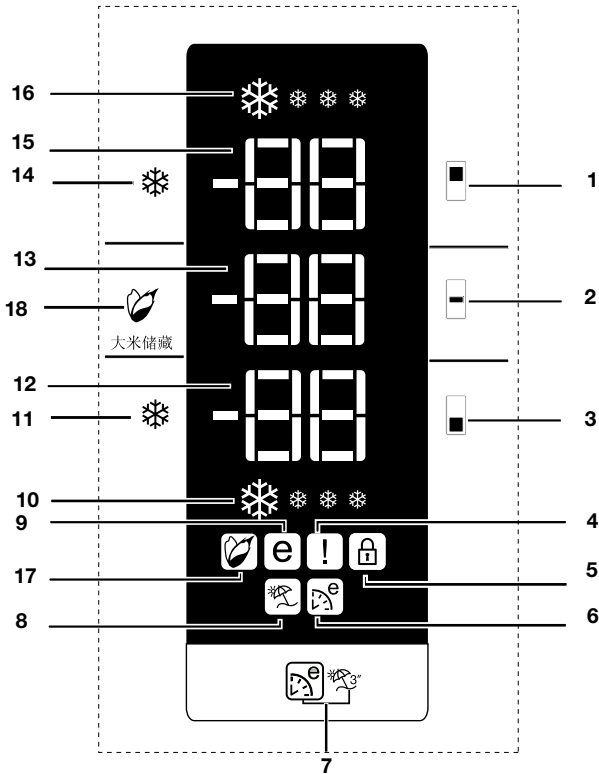

1. 冷藏室温度设置按钮
2. 变温室温度设置按钮
3. 冷冻室温度设置按钮
4. 错误状态指示灯
5. 键锁功能指示灯
6. 经济辅助功能指示灯
7. 经济辅助/空置功能按钮
8. 闲置功能指示灯
9. 经济模式指示灯
10. 快速冷藏功能指示灯
11. 快速冷藏功能按钮
12. 冷冻室温度设置指示灯
13. 多功能区温度设置指示灯
14. 快速冷冻功能按钮
15. 冷藏室温度设置指示灯
16. 快速冷冻功能指示灯
17. 米饭功能指示灯
18. 米饭功能按钮

### 1. 冷藏室温度设置按钮

使用该按钮可以设置冷冻室的温度。按下此按钮，将冷冻室的温度分别设置为 -18、-19、-20、-21、-22、-23 和 -24。

### 2. 变温室温度设置按钮

您可以将多功能储藏室设置为冷冻室或冷藏室。按住此按钮 3 秒钟，将变温室设置为冷冻室或冷藏室。出厂时，这里设置为冷冻室。

如果变温室设置为冷冻室，那么，每次您按下此按钮时，变温室的温度将分别变化为 -18、-19、-20、-21、-22、-23、-24、-18... 如果变温室设置为冷藏室，那么，每次您按下此按钮时，变温室的温度将分别变化为 10、8、6、4、2、0、-6.....。

### 3. 冷冻室温度设置按钮

使用该按钮可以设置冷藏室的温度。按下此按钮，将冷藏室的温度分别设置为 8、7、6、5、4、3、2。

### 4. 错误状态指示灯

如果冰箱没有充分制冷，或者传感器有故障，该指示灯将激活。该指示灯活动时，冷冻室指示灯将显示“E”，且冷藏室温度指示灯将显示诸如“1、2、3.....”等数字。指示灯上的这些数字向服务人员提供有关错误的信息。

将热食物放入冷冻室，或者冰箱门长时间常开时，感叹号会亮起一段时间。这并非故障；食物冷却后，该警告将消失。

### 5. 键锁功能指示灯

如果您不希望变更冰箱的温度设置，可以使用此功能。

若要启动该功能，您应当同时按下快速冷冻和快速冷藏按钮 3 秒钟。

### 6. 经济辅助功能指示灯

显示“经济辅助”功能活动。

如果此功能活动，冰箱将自动检测最少使用的时间，并在该时间内，执行高能源效率的制冷。在执行高能源效率的制冷时，经济指示灯将活动。

再次按下相关按钮，解除此功能。

### 7. 经济辅助/空置功能按钮

快速按下此按钮，激活“经济辅助”功能。按住此按钮 3 秒钟，激活“控制”功能。再次按下此按钮，解除所选功能。

### 8. 闲置功能指示灯

显示控制功能活动。

如果此功能活动，冷藏室的温度指示器上出现“- -”，且冷藏室不执行制冷。其它隔间将根据各自设置的温度制冷。

再次按下相关按钮，解除此功能。

### 9. 经济模式指示灯

显示冰箱在高能源效率运转。冷冻室温度

如果功能设置为 -18，或者由于“经济辅助”功能执行高能源效率的制冷，该指示灯活动。

#### 10. 快速冷藏功能指示灯

在“快速冷藏”功能活动时，该图标以动画的形式闪烁。

#### 11. 快速冷藏功能按钮

在您按下“快速冷藏”按钮时，冷藏室的温度比调整的数值低。

该功能可以用于放置在冷藏室中的食物，并根据需要快速制冷。

如果您想要冷却大量新鲜食物，建议将食物放入冷藏室前，启动该功能。

快速冷藏功能启动时，快速冷藏指示灯亮起。若要取消该功能，可再次按下“快速冷藏”按钮。

如果您没有取消，“快速冷藏”功能将在 2 小时之后或者在冷藏室达到要求的温度后自行取消。

断电后，在电源恢复时，该功能不会解除。

#### 12. 冷冻室温度设置指示灯

显示冷冻室的温度设置。

#### 13. 多功能区温度设置指示灯

显示变温室的温度设置。

#### 14. 快速冷冻功能按钮

快速冷冻功能活动时，快速冷冻指示灯亮起。若要取消该功能，可再次按下“快速冷冻”按钮。“快速冷冻”指示灯将熄灭，并恢复正常设置。如果您没有取消，“快速冷冻”功能将在 8 小时之后或者在冷冻室达到要求的温度后自行取消。

如果您想冷冻大量的新鲜食物，将食物放入冷冻室前 24 小时，请按下“快速冷冻”按钮。

如果您快速多次按下“快速冷冻”按钮，由于电路电子保护系统将启动，所以，压缩机将不会立即启动。

断电后，在电源恢复时，该功能不会解除。

#### 15. 冷藏室温度设置指示灯

显示冷藏室的温度设置。

#### 16. 快速冷冻功能指示灯

在“快速冷冻”功能活动时，该图标以动画的形式闪烁。

#### 17. 米饭功能指示灯

在“大米饭功能活动时，该图标以动画的形式闪烁。

#### 18. 米饭功能按钮

您按下“米饭”功能按钮时，变温室的温度自动设置为适当温度，令米饭长时间保鲜。

若要取消该功能，可再次按下“米饭”按钮。

## 冰箱门未关警告

(该功能可能视冰箱门之不同而异, 某些型号上可能不存在该功能。)

在冰箱门打开超过至少 1 分钟时, 会发出声音警报。关闭冰箱门或按下任何显示按钮 (如果有) 时, 警报将静音。

## 双冷却系统:

冰箱配备有两套独立的冷却系统, 分别冷却新鲜食物储藏室和冷冻室。这样, 新鲜食物储藏室和冷冻室中的空气不会混合。由于具备这两套独立的冷却系统, 冷却速度远高于其它冰箱。冷藏室中的气味不会混合。此外, 由于单独执行除霜, 所以, 可以额外节约能源。

## 冷冻新鲜食物

- 放入冰箱前, 捆扎或覆盖食物。
- 炽热的食物放入冰箱前, 必须冷却至室温。
- 您想要冷冻的食物必须新鲜, 且品质良好。
- 食物必须根据家庭每日用量或者每一餐的使用需求分成小份。
- 如果食物将存放较短时间, 必须采用不透气的包装, 以防止脱水。
- 包装食物时使用的材料必须耐磨, 并且耐低温、潮湿、异味、耐油和耐酸, 也必须不透气。此外, 包装容器必须盖好, 且必须采用适合深度冷冻、且容易使用的材料制成。
- 冷冻的食物在解冻后必须立即使用, 且不得再次冷冻。
- 为了获得最佳冷冻效果, 请遵循下列说明。
  1. 一次请勿冷冻大量食物。如果食物能够尽快冻透的话, 可以保持最佳品质。
  2. 将温热的食物放入冷冻室会促使制冷系统连续工作, 直至食物冷冻好。
  3. 特别小心不要将已经冷冻和新鲜食物相混合。

冷冻室设置	冷藏室设置	解释
-18° C	4° C	这是建议的正常设置。
-20、-22 或 -24°C	4° C	在环境温度超过 30° C 时，建议使用这些设置。
快速冷冻	4° C	在短时间内冷冻食物时使用。在这一过程结束后，冰箱将恢复之前的模式。
-18°C 或更低温度	2° C	如果您认为，由于高温条件或者经常打开和关闭冰箱门，导致冷藏室不够冷，可以调整这些数值。
-18°C 或更低温度	快速冷藏	在冷藏室过载，或者您希望快速冷却食物时，可以使用之。建议您在放入食物的 4-8 小时前，启动快速冷藏功能。

## 冷冻食物储藏建议

- 从市面上购得的包装好的冷冻食物应当根据冷冻食物制造商的说明在冷冻室储藏 **★☆☆☆**（4 星）。
- 为了保持冷冻食物制造商和食品零售商获得的高品质，应该牢记下列事项：
  1. 在购买后，尽快将食物放入冷冻室。
  2. 确保贴上食物标签，并注明日期。
  3. 请勿超出包装上的“使用截止”和“最佳食用”日期。

### 除霜

冷冻室自动除霜。

## 新鲜食物区的建议

- 注意任何食物均不得接触新鲜食物区的温度传感器。为了新鲜食物区保持理想的贮存温度，食物不可遮挡传感器。
- 请勿在冰箱内放置灼热的食物。

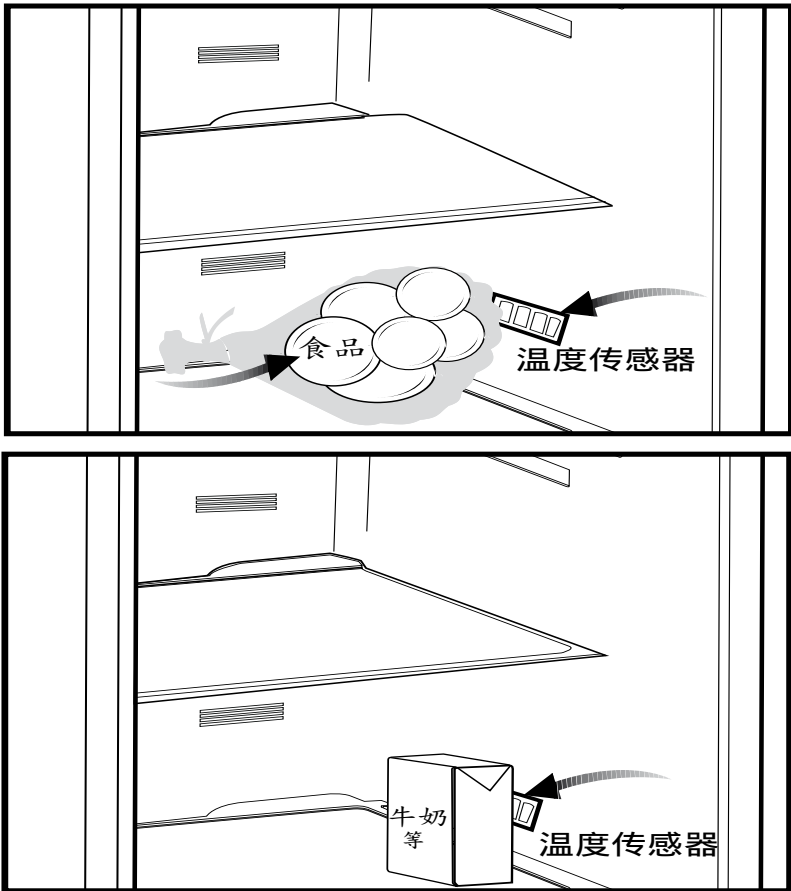

## 蛋托

您可以在冰箱门或者支架上安装蛋托。  
切勿将蛋托置于低温室

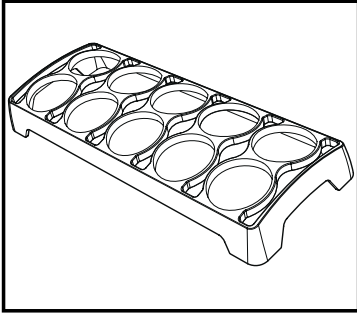

## 蓝色光

(仅限某些型号)

在果蔬盒中储存的食物使用蓝色光照射，通过蓝色光的波长效应，继续它们的光合作用，从而保持其新鲜度和增加维生素含量。

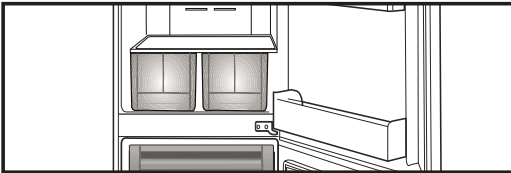

## 放置食物

冷冻室搁架	各种冷冻食物，例如，肉、鱼、冰淇淋，蔬菜等。
蛋托	鸡蛋
冷藏室搁架	放在盘子、盖板和封闭容器内的食物
冷藏室门搁架	小型和包装好的食物或饮料（例如，牛奶、果汁和啤酒）
果蔬盒	蔬菜和水果
保鲜区	熟食制品（干酪、黄油、意大利腊肠等）

## 深度冷冻信息

食物放入冰箱后，必须尽快冷冻，以保持良好的品质。

TSE 标准要求（根据某些测量条件），对于每 100 升的冷冻容量，冰箱在 32° C 的环境温度，在 24 小时内将至少 4.5 kg 食物冷冻至 -18° 或以下。

只有在 -18° C 或更低的温度，才能将食物保存较长时间。

您可以在数个月的时间内使食物保持新鲜（深度冷冻后在 -18° C 或更低的温度）。

### ⚠ 警告：

- 食物必须根据家庭每日用量或者每一餐的使用需求分成小份。
- 如果食物将存放较短时间，必须采用不透气的包装，以防止脱水。



包装所需的材料:

- 耐低温的胶带
- 自粘标签
- 橡皮环
- 笔

包装食物时使用的材料必须耐磨, 并且耐低温、潮湿、异味、耐油和耐酸。

即将冷冻的食物不得与之前冷冻的食物相接触, 以免部分解冻。

冷冻的食物在解冻后必须立即使用, 且不得再次冷冻。

## 变温储藏室

冰箱的变温室可以通过将其调整为冷藏室 (2/4/6/8 ° C) 或冷冻室 (-18/-19/-20/-21/-22/-23/-24) 温度, 在任何所需的模式使用。 您可以使用“变温室温度设置按钮”, 使这里保持所需的温度。 除了冷藏室温度, 多功能区的温度可以调整为 -6、-2, 0 和 10 度。 “0” 度用于将熟食保存更长的时间, -6 度以容易切割的状态, 使肉类最多保存 2 星期。

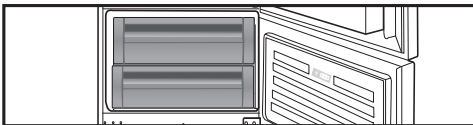

## 异味过滤器说明和清洁:

异味过滤器可防止冰箱内蓄积异味。

向下拉动安装有异味过滤器的盖子, 并拆卸下来, 如图所示。 令过滤器接受阳光照射一天。 在这段时间内, 过滤器将得以净化。 将过滤器安装回原位。

异味过滤器每年必须清洁一次。

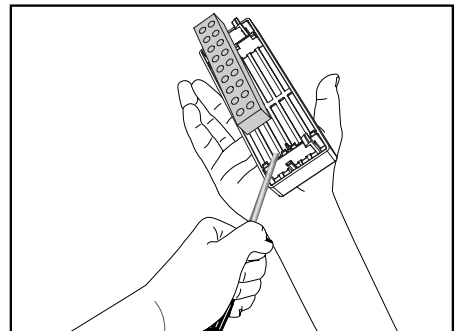
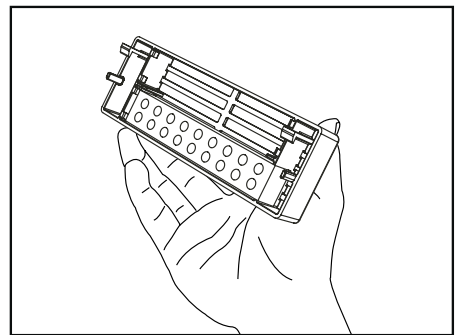
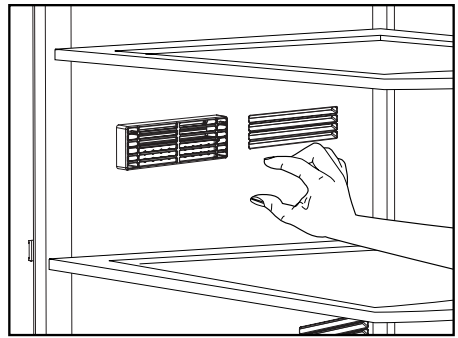

## 6 维护和清洁

- ⚠ 清洁时，切勿使用汽油、苯或类似物质。
- ⚠ 我们建议您在清洁前，拔下本装置的插头。
- ⚠ 清洁时，切勿使用任何锋利的研磨器具，肥皂、家用清洁剂、洗涤剂 and 蜡光剂。
- ℹ 使用温水清洁冰箱的外壳，并擦干。
- ℹ 在一品脱水中放入一茶匙小苏打，使用这一溶液清洗抹布，用绞干的抹布清洁冰箱内部，并擦干。
- ⚠ 确保没有水进入灯罩和其它电气零件。
- ⚠ 如果长时间不使用冰箱，拔下电源线，取出所有食物，清洁之，并使冰箱门微开。
- ℹ 定期检查门密封情况，确保其清洁，和没有食品颗粒。
- ⚠ 若要拆卸门架，取出所有内容物，然后简单地从底部向上推门架即可。

### 保护塑料表面

- ℹ 请勿将非密封容器中盛放的液体油或者用油烹饪的食物放入冰箱，这类食物可能损坏冰箱的塑料表面。如果食用油飞溅或者涂抹在塑料表面上，立即用温水，清洁和洗涤表面的相关部分。

## 7 问题解决建议

致电服务机构前，请审核该清单。其可以节约您的时间和资金。该清单包含经常出现的、并非工艺和材料使用缺陷导致之投诉。这里描述的某些特点可能不会在您的产品中出现。

### 冰箱不工作。

- 冰箱插头是否适当插入？在壁式插座插入插头。
- 冰箱连接的插座之保险丝或者主保险丝是否熔断？检查保险丝。

### 冷藏室的侧壁出现冷凝水（多功能区、制冷控制和变温区）。

- 环境条件很冷。经常打开和关闭冰箱门。环境条件高度潮湿。在敞开的容器中存放含有液体的食物。冰箱门未关严。将自动调温器切换为更冷的程度。
- 减少冰箱门打开的时间，或者减少使用频率。
- 使用合适的材料，覆盖保存在开口容器中的食物。
- 使用干抹布擦拭冷凝水，请检查冷凝水是否再次出现。

### 压缩机不工作

- 在突然断电或者拔下和插入接头时，由于冰箱制冷系统中的冷媒压力尚未平衡，所以，压缩机的保护热将会吹出。冰箱大约在 6 分钟后开始运行。在该时间结束后，如果冰箱仍未启动，请致电服务机构。
- 冰箱处于除霜循环。对于全自动除霜冰箱而言，这是正常的。定期执行除霜循环。
- 冰箱插头没有插入插座。确保插头适当插入插座。
- 是否正确调整了温度？
- 可能发生了断电。

### 冰箱经常运行或者运行较长时间。

- 您的冰箱可能比之前的冰箱宽。这是很正常的。较大的冰箱需要工作较长的时间。
- 环境温度可能很高。这是很正常的。
- 冰箱插头可能插入不久，或者新近装入了食物。冰箱完全制冷可能需要多花费数小时时间。
- 最近可能在冰箱中放入了大量灼热食物。灼热的食物导致冰箱运行较长时间，直至达到安全的储存温度。
- 冰箱门可能经常打开，或者长时间未关严。进入冰箱的热空气导致冰箱运行较长时间。减少打开冰箱门的次数。
- 冷冻室或者冷藏室的门可能没有关严。检查门是否牢牢关闭。
- 冰箱调整为很低的温度。调高冰箱的温度，并等待直至达到这一温度。
- 冷藏室或冷冻室的门密封可能脏污、磨损，断裂或者没有适当固定好。清洁或更换密封。损坏/断裂的密封导致冰箱运行较长的时间，才能保持当前的温度。

### 冷冻室温度很低，而冷藏室温度足够。

- 冷冻室调整为很低的温度。调高冷冻室的温度，并检查。

### 冷藏室温度很低，而冷冻室温度足够。

- 冷藏室可能被调整为很低的温度。调高冷藏室的温度，并检查。

### 在冷藏室保存的食物上冻。

- 冷藏室可能被调整为很低的温度。调高冷藏室的温度，并检查。

### 冷藏室或者冷冻室的温度很高。

- 冷藏室可能被调整为很高的温度。冷藏室调整对冷冻室的温度有影响。变更冷藏室或冷冻室的温度，直至冷藏室或冷冻室的温度达到充分的水平。
- 冰箱门可能经常打开，或者长时间未关严；请减少打开冰箱门的次数。
- 冰箱门未关严；完全关闭冰箱门。
- 最近可能在冰箱中放入了大量灼热食物。等待直至冷藏室或冷冻室达到必要的温度。
- 冰箱可能插入插头不久。冰箱完全冷却需要些时间。

### 冰箱工作时，噪声增加。

- 冰箱的操作性能可能会视环境温度的变化而有所不同。这是正常的，并非故障。

### 振动或噪声。

- 地面不平坦或者不牢固。冰箱在缓慢移动时，会摇晃。确保地面足够坚固，能够承载冰箱，且水平。
- 噪声可能是由于放在冰箱上的物品导致的。应当取下冰箱顶部的物品。

冰箱发出类似液体飞溅或者喷射的噪音。
<ul style="list-style-type: none"> <li>• 根据冰箱的操作原理，发生了液体和气体流动。这是正常的，并非故障。</li> </ul>
有类似风吹的噪声。
<ul style="list-style-type: none"> <li>• 为了使冰箱冷却，使用了风扇。这是正常的，并非故障。</li> </ul>
冰箱内壁出现冷凝水。
<ul style="list-style-type: none"> <li>• 炎热和潮湿的天气增加了结冰和冷凝情况。这是正常的，并非故障。</li> <li>• 门可能未关严；确保完全关闭冰箱门。</li> <li>• 冰箱门可能经常打开，或者长时间未关严；请减少打开冰箱门的次数。</li> </ul>
冰箱外面或者冰箱门之间有湿气。
<ul style="list-style-type: none"> <li>• 空气可能过于潮湿；在潮湿的天气里，这是完全正常的。在湿度下降时，冷凝水会消失。</li> </ul>
冰箱内出现异味。
<ul style="list-style-type: none"> <li>• 必须清洁冰箱内部。用海绵蘸取温水或者苏打水，清洁冰箱内部。</li> <li>• 某些容器或者包装材料可能导致出现异味。使用不同的容器或者不同品牌的包装材料。</li> </ul>
冰箱门未关。
<ul style="list-style-type: none"> <li>• 食品包装可能妨碍关闭冰箱门。更换妨碍关闭冰箱门的包装。</li> <li>• 冰箱没有在地面上完全直立，在略微移动时会摇动。调整升降螺丝。</li> <li>• 地面不水平或者不够牢固。确保地面水平，并能够承载冰箱。</li> </ul>
果蔬盒卡住
<ul style="list-style-type: none"> <li>• 食物可能接触到了抽屉顶板。重新摆放抽屉中的食物。</li> </ul>

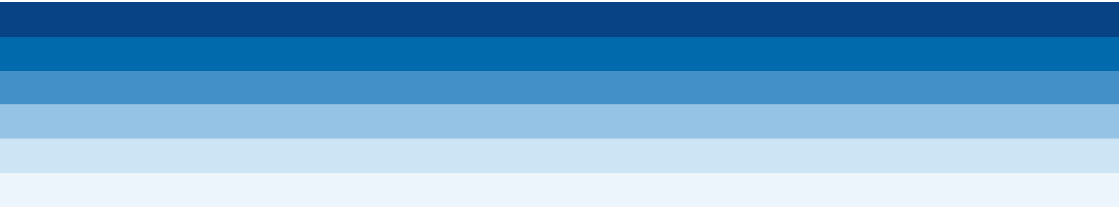

57 0883 0000/AF  
EN - ZH

## Free Manuals Download Website

<http://myh66.com>

<http://usermanuals.us>

<http://www.somanuals.com>

<http://www.4manuals.cc>

<http://www.manual-lib.com>

<http://www.404manual.com>

<http://www.luxmanual.com>

<http://aubethermostatmanual.com>

Golf course search by state

<http://golfingnear.com>

Email search by domain

<http://emailbydomain.com>

Auto manuals search

<http://auto.somanuals.com>

TV manuals search

<http://tv.somanuals.com>