

**Wet & Dry Hand-Held  
Vacuum Cleaner**

**BKK 1180 P**

**BEKO**

### **Please read this manual first!**

Dear Customer,

We hope you to get the best result from your product that was manufactured in our state-of-the-art facilities and passed the most careful quality controls.

We recommend you to read the entire manual carefully before operating your product and keep it for future reference.

### **This operation manual...**

Will help you to use your vacuum cleaner fast and safely. Please read the operation manual before using and operating your appliance.

Particularly follow the instructions related to safety.

As you may also need it in the future, keep your operation manual ready to hand.

Also, please read other documents that were additionally supplied with your appliance. Remember that this operation manual may also apply for other models. Differences between the models are explicitly highlighted in the manual.



This product has been manufactured at environment-friendly plants without causing any harm to the nature.



Conforms to EEE Directive

Does not contain PCB

## Contents

<b>1 Safety Warnings</b>	<b>&gt;2-3</b>
<b>2 Technical Specifications of Your Appliance</b>	<b>&gt;4</b>
<b>3 Operating Your Appliance</b>	<b>&gt;5</b>
<b>4 Maintenance and Cleaning</b>	<b>&gt;6</b>

## 1 Safety Warnings

- Make sure that the supply voltage is 220/240 Volts before plugging in the recharging adaptor.
- Do not recharge your vacuum cleaner with another adaptor other than its own.
- While mounting the vacuum cleaner on to the wall hanger unit or when attaching or removing it, pay attention not to damage the power cable.
- Never immerse the motor block into water. Wipe only the plastic parts with a damp cloth when cleaning.
- When using, keep the vacuum cleaner away from your face and eyes and keep it away from reach of children.
- Keep the vacuum cleaner away from hot sources and do not vacuum hot substances.
- Slightly warming of the adaptor while recharging the battery is normal. Since there is no risk of excessive charging, the vacuum cleaner may always be left plugged-in.
- Never use the vacuum cleaner without a filter.
- Do not hold the vacuum cleaner directly towards fire even if the batteries are completely out of use. This may cause fire or explosion.
- Ensure that the level of the absorbed liquid in the container never exceeds the Max. line while vacuum cleaning wet surfaces.

**Warnings about charging batteries**  
Life of the batteries depends greatly on how the first charging was made and if the following charges were made

on time. Batteries must have been charged for 16 hours before they are used for the first time; discharging the batteries by continuously operating the vacuum cleaner during first usage (decreasing of motor's speed and the operation sound) and recharging it after this process will extend the life of the batteries. Batteries will reach full performance after fully charging and fully discharging them for a couple of times. Decreasing of motor speed as well as suction power during operation indicates that the batteries need charging. The vacuum cleaner must be connected to charging. If you do not charge the batteries for a long time, they may be damaged in a way that it is not possible to charge them again. Therefore, the vacuum cleaner must always be connected to charging.

### Caution!

In case of any failure of the charging adaptor, replace it at an authorised service only.

### Caution!

If the batteries cannot be recharged because their service life has come to an end or because they were not charged continuously, you can replace them only at the services included in the attached list of authorised services. Also, with regard to environmental health, replace the batteries at authorised services. Charge and discharge the newly attached batteries too as explained above. Charging LED on the adaptor will be permanently on as long as it is plugged in. This light does not indicate the amount of charging.

- Do not operate your vacuum cleaner if it is damaged or does not operate properly. Have it repaired by authorised services.

- Do not vacuum flammable or explosive (gas, liquid or solid) substances.
- Do not vacuum cutters or items with sharp edges.
- Do not vacuum very hot or burning substances.
- Adaptor assembly and supply cable must only be replaced by authorised services.
- Physically (audio, visual) impaired and mentally retarded persons and those without proper experience and knowledge as well as children may not use the product without supervision of a person in charge of their safety.
- Children must be kept under supervision when the product is in use and it must be made sure that children do not tamper with the product.

#### Caution!

Read the operation manual of the appliance including the warranty section thoroughly and carefully before operating your vacuum cleaner. Keep the original or a copy of the invoice for any future need that may arise with respect to the warranty.

**This appliance has been manufactured for domestic use.**

## 2 Technical Specifications of Your Appliance

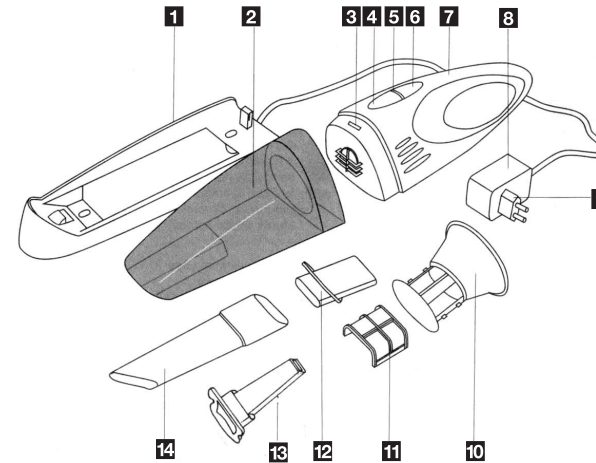

<b>1</b> Wall hanger unit	Weight (Gross)	: 1340 g
<b>2</b> Dust and liquid container	Electrical values	: 220-230 V~ 50 Hz
<b>3</b> Dust and liquid container holder tab	Adaptor isolation class	: <input type="checkbox"/>
<b>4</b> Dust and liquid container unlock button	Dimensions (Box)	: 445 x 138 x 127 mm.
<b>5</b> Charging adaptor light	Battery group voltage	: 3x1.2 V
<b>6</b> ON button	Battery group capacity	: 1300 mAh
<b>7</b> Vacuum cleaner body		
<b>8</b> Charging adaptor		
<b>9</b> Charging plug		
<b>10</b> Filter body		
<b>11</b> Dust filter		
<b>12</b> Short suction tube		
<b>13</b> Suction nozzle for wet surfaces		
<b>14</b> Long suction tube		

- Values stated on the markings of the product or in the printed documents accompanying the product are obtained in the laboratory on basis of the relevant standards. These values may change according to the usage and ambient conditions of the product.

### 3 Operating Your Appliance

#### Caution!

**Since the batteries of the vacuum cleaner are not charged, charge it continuously for 16 hours before first operation.**

Fix the wall hanger unit onto the wall by using the inserts and screws (Picture 1). Attach the vacuum cleaner on the wall hanger unit so that its suction nozzle will face downward (Picture 2).

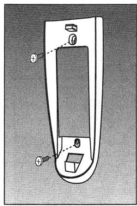

(Picture 1)

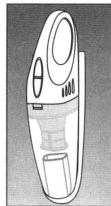

(Picture 2)

The LED on the charging adaptor will light when you plug in the charging adaptor. If the adaptor is not plugged in properly or if the vacuum cleaner is not fully attached on to the wall hanger unit, this charging adaptor LED will not light. Check this. After completion of charging of the vacuum cleaner, take it off the hanger and operate by pressing the ON button on the vacuum cleaner. The vacuum cleaner will run as long as you keep your finger pressed on the ON button. To stop the appliance when you are done with cleaning, simply release the ON button by lifting your finger.

#### Cleaning wet surfaces:

While cleaning wet surfaces with the vacuum cleaner, use the suction nozzle supplied specially for wet surfaces. Particularly during wet surface cleanings, the suction nozzle of the appliance should be fully parallel to and touch the surface for the best efficiency (Picture 3).

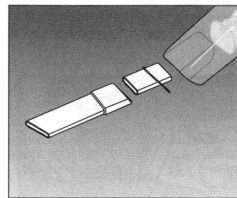

(Picture 3)

Use the two suction tubes with different lengths to clean places that are difficult to reach such as between the radiator cores or armchairs. As the longer suction tube can only be attached to the short one, attach the shorter suction tube first to be able to use the long suction tube (Picture 4).

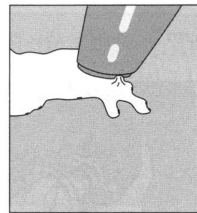

(Picture 4)

### 4 Maintenance and cleaning

To clean the appliance, remove the dust and liquid container by pressing the dust container unlock button after each use (Picture 5) and take out the dust filter by slightly turning it to left (Picture 6).

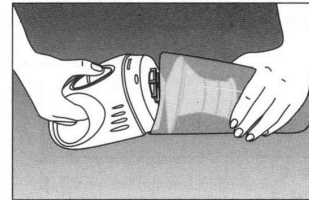

(Picture 5)



(Picture 6)

After cleaning both parts thoroughly, install them in reverse order you have followed for removal. When attaching the dust and liquid container on to its seat, make sure that the lower tab is seated first and then close the upper side and ensure that the lock is firmly seated in its place. If you leave the vacuum cleaner discharged for one or more days after using it, batteries will

be damaged irreparably.

Therefore, the vacuum cleaner must always be connected to charging after every use. For an efficient operation of the vacuum cleaner the filter must always be clean. You may clean the dust filter by a soft brush or by washing it. To do this, release the dust filter from the tabs on the filter body by pulling one side of it towards yourself (Picture 7). Wash the dust filter with warm water to clean it. Make sure that the filter and the container are completely dry before installing them after cleaning. You may obtain spare filters from authorised s

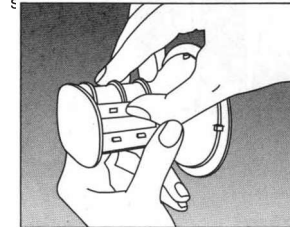

(Picture 7)

#### Caution!

You may replace Nickel-Cadmium batteries of the vacuum cleaner at "Arçelik Authorised Services" only. Never dispose of the batteries.

**Unplug the wall hanger unit and the charging adaptor before starting cleaning. Clean only with a wet cloth and plug in only after making sure that they are dry.**

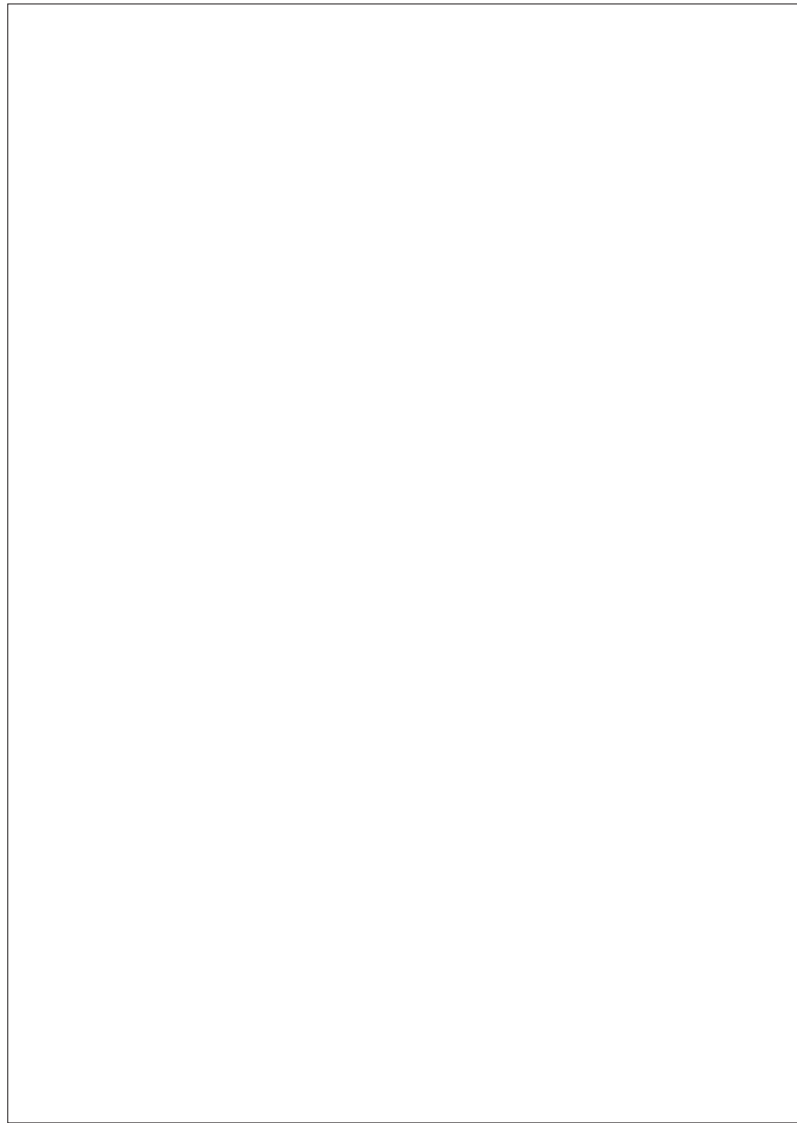
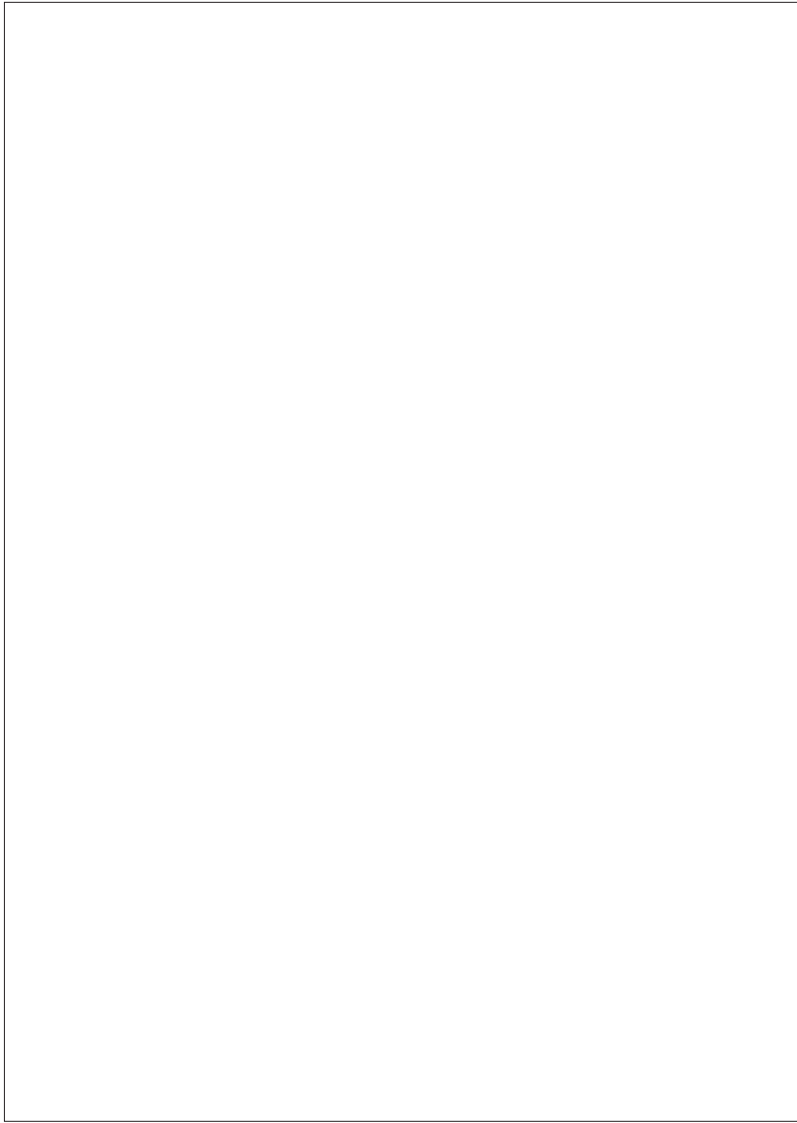

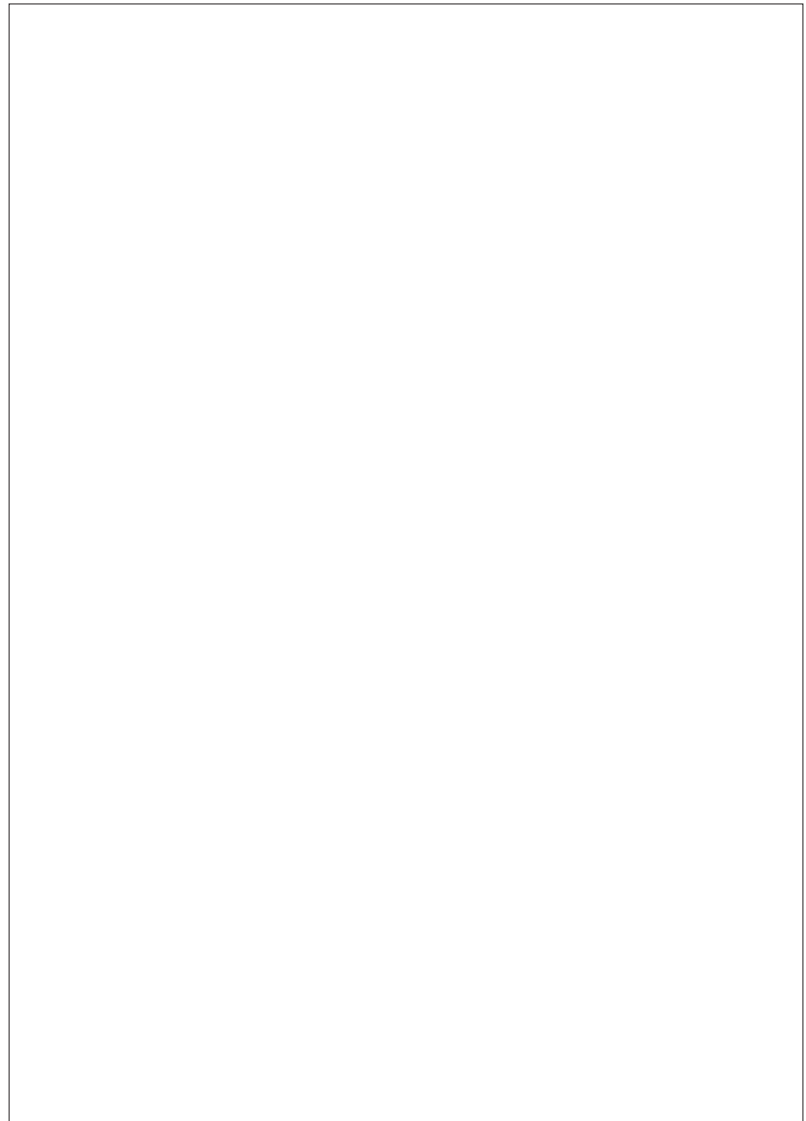
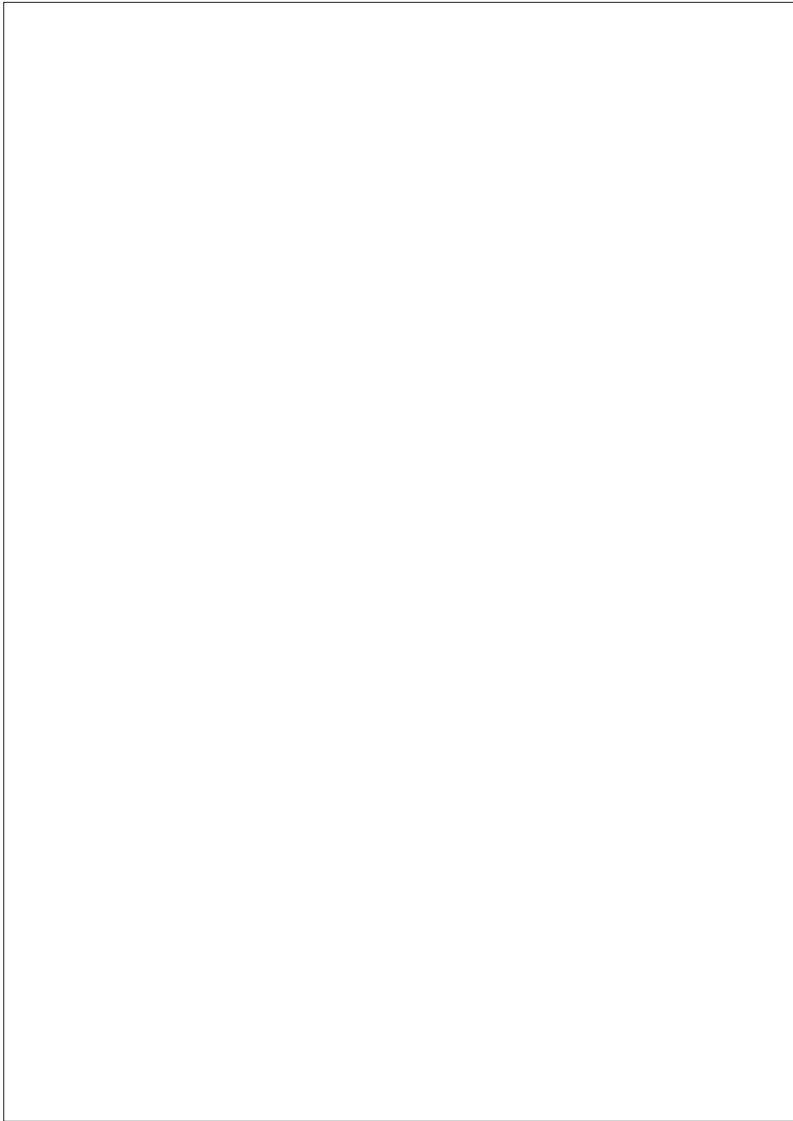

## Free Manuals Download Website

<http://myh66.com>

<http://usermanuals.us>

<http://www.somanuals.com>

<http://www.4manuals.cc>

<http://www.manual-lib.com>

<http://www.404manual.com>

<http://www.luxmanual.com>

<http://aubethermostatmanual.com>

Golf course search by state

<http://golfingnear.com>

Email search by domain

<http://emailbydomain.com>

Auto manuals search

<http://auto.somanuals.com>

TV manuals search

<http://tv.somanuals.com>