

BEKO

*installation & operating
instructions and washing guidance*

Automatic
washing machine

WMB71231B

WMB71231S

WMB71231W



get the **best** from your new washer

Please read this user manual first!

Dear Customer,

We hope that you get the best results from the product which has been manufactured in state-of-the-art plants and passed through a strict quality control procedure.

Therefore, please read the entire user manual carefully before using the product and keep it as a reference for future use. In case of transferring the product to someone else, give the manual as well.

The user manual will help you use your machine in a fast and safe way.

- Read the user manual before installing and starting your product.
- Always follow the safety instructions.
- Keep this user manual within easy reach for future reference.
- Read also the other documents supplied with the product.

Remember that this user manual is also applicable for several other models. Differences between models will be identified in the manual.

Explanation of symbols

Throughout this user manual the following symbols are used:

 Important information or useful hints about usage.

 Warning for hazardous situations with regard to life and property.

 Warning for electric shock.

2820521859/070211.1601



This appliance's packaging material is recyclable. Help recycle it and protect the environment by dropping it off in the municipal receptacles provided for this purpose. Your appliance also contains a great amount of recyclable material. It is marked with this label to indicate the used appliances that should not be mixed with other waste. This way, the appliance recycling organised by your manufacturer will be done under the best possible conditions, in compliance with European Directive 2002/96/EC on Waste Electrical and Electronic Equipment. Contact your town hall or your retailer for the used appliance collection points closest to your home. We thank you doing your part to protect the environment.

TABLE OF CONTENTS

1 Your washing machine 4

Overview	4
Technical specifications	5

2 Important safety instructions 6

General safety	6
Intended use	6
Children's safety	7

3 Installation 8

Appropriate installation location	8
Removing packaging reinforcement.	8
Removing the transportation locks.	8
Connecting water supply	9
Connecting to the drain	10
Adjusting the feet.	10
Electrical connection	10
First use	12
Disposing of packaging material	12
Transportation of the product.	12
Disposing of the old product	12

4 Preparation 13

Things to be done for energy saving	13
Sorting the laundry	13
Preparing laundry for washing	13
Correct load capacity	14
Loading the laundry.	14
Using detergent and softener	15
Tips for efficient washing	18

5 Operating the product 19

Control panel	19
Preparing the machine.	19
Programme selection.	19
Main programmes	20

Additional programmes	20
Special programmes	21
Temperature selection	21
Spin speed selection	21
Programme and consumption table.	22
Auxiliary function selection.	24
Starting the programme.	25
Child Lock	25
Progress of programme.	26
Loading door lock	26
Changing the selections after programme has started	26
Canceling the programme	26
End of programme	27

6 Maintenance and cleaning 28

Cleaning the detergent drawer.	28
Cleaning the loading door and the drum	28
Cleaning the body and control panel	28
Cleaning the water intake filters	28
Draining remaining water and cleaning the pump filter	29

7 Troubleshooting 31

8 Guarantee 37

9 Service 38

1 Your washing machine

Overview

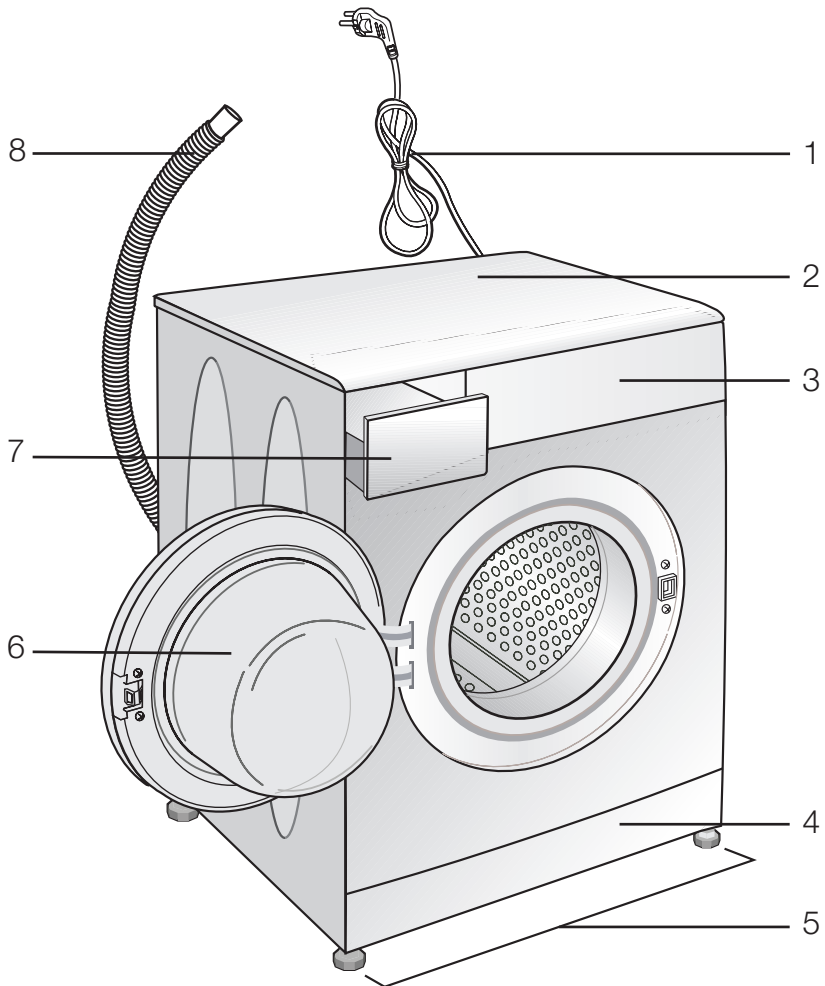



- 1- Power cable
- 2- Top panel
- 3- Control panel
- 4- Filter cap

- 5- Adjustable feet
- 6- Loading door
- 7- Detergent drawer
- 8- Drain hose

Technical specifications

Models	WMB71231B	WMB71231S	WMB71231W
Maximum dry laundry capacity (kg)	7	7	7
Height (cm)	84	84	84
Width (cm)	60	60	60
Depth (cm)	54	54	54
Net weight (± 4 kg.)	71	71	71
Electrical input (V/Hz)	230 V / 50Hz		
Total current (A)	10	10	10
Total power (W)	2200		
Spin speed (rpm max.)	1200	1200	1200
Stand-by mode power (W)	1.00	1.00	1.00
Off-mode power (W)	0.25	0.25	0.25

-  Technical specifications may be changed without prior notice to improve the quality of the product.
-  Figures in this manual are schematic and may not match the product exactly.
-  Values stated on the product labels or in the documentation accompanying it are obtained in laboratory conditions in accordance with the relevant standards. Depending on operational and environmental conditions of the product, these values may vary.

2 Important safety instructions

This section contains safety instructions that will help protect from risk of personal injury or property damage. Failure to follow these instructions shall void any warranty.

General safety

- This product should not be used by persons with physical, sensory or mental disorders or unlearned or inexperienced people (including children) unless they are attended by a person who will be responsible for their safety or who will instruct them accordingly for use of the product.
- Never place the product on a carpet-covered floor; otherwise, lack of airflow beneath the machine will cause electrical parts to overheat. This will cause problems with your product.
- Do not operate the product if the power cable / plug is damaged. Call the Authorized Service Agent.
- Have a qualified electrician connect a 16-Ampere fuse to the installation location of the product.
- If the product has a failure, it should not be operated unless it is repaired by the Authorized Service Agent.
There is the risk of electric shock!
- This product is designed to resume operating in the event of powering on after a power interruption. If you wish to cancel the programme, see "Cancelling the programme" section.
- Connect the product to a grounded outlet protected by a fuse complying with the values in the "Technical specifications" table. Do not neglect to have the grounding installation made by a qualified electrician. Our company shall not be liable for any damages that will arise when the product is used without grounding in accordance with the local regulations.
- The water supply and draining hoses must be securely fastened and remain undamaged. Otherwise, there is the risk of water leakage.

- Never open the loading door or remove the filter while there is still water in the drum. Otherwise, risk of flooding and injury from hot water will occur.
- Do not force open the locked loading door. The loading door will be ready to open just a few minutes after the washing cycle comes to an end. In case of forcing the loading door to open, the door and the lock mechanism may get damaged.
- Unplug the product when not in use.
- Never wash the product by spreading or pouring water onto it! There is the risk of electric shock!
- Never touch the plug with wet hands! Never unplug by pulling on the cable, always pull out by grabbing the plug.
- Use detergents, softeners and supplements suitable for washing machines only.
- Follow the instructions on the textile tags and on the detergent package.
- The product must be unplugged during installation, maintenance, cleaning and repairing procedures.
- Always have the installation and repairing procedures carried out by the Authorized Service Agent. Manufacturer shall not be held liable for damages that may arise from procedures carried out by unauthorized persons.

Intended use

- This product has been designed for domestic use. It is not suitable for commercial use and it must not be used out of its intended use.
- The product must only be used for washing and rinsing of laundry that are marked accordingly.
- The manufacturer waives any responsibility arisen from incorrect usage or transportation.
- The service life of your product is 10 years. During this period, original spare parts will be available to operate the appliance properly.

Children's safety

- Electrical products are dangerous for the children. Keep children away from the product when it is in use. Do not let them to tamper with the product. Use child lock to prevent children from intervening with the product.
- Do not forget to close the loading door when leaving the room where the product is located.
- Store all detergents and additives in a safe place away from the reach of the children.

3 Installation

Refer to the nearest Authorised Service Agent for installation of the product. To make the product ready for use, review the information in the user manual and make sure that the electricity, tap water supply and water drainage systems are appropriate before calling the Authorized Service Agent. If they are not, call a qualified technician and plumber to have any necessary arrangements carried out.

i Preparation of the location and electrical, tap water and waste water installations at the place of installation is under customer's responsibility.

⚠ Installation and electrical connections of the product must be carried out by the Authorized Service Agent. Manufacturer shall not be held liable for damages that may arise from procedures carried out by unauthorized persons.

⚠ Prior to installation, visually check if the product has any defects on it. If so, do not have it installed. Damaged products cause risks for your safety.

i Make sure that the water inlet and discharge hoses as well as the power cable are not folded, pinched or crushed while pushing the product into its place after installation or cleaning procedures.

Appropriate installation location

- Place the machine on a rigid floor. Do not place it on a long pile rug or similar surfaces.
- Total weight of the washing machine and the dryer -with full load- when they are placed on top of each other reaches to approx. 180 kilograms. Place the product on a solid and flat floor that has sufficient load carrying capacity!
- Do not place the product on the power cable.
- Do not install the product at places where temperature may fall below 0°C.
- Place the product at least 1 cm away from the edges of other furniture.

Removing packaging reinforcement

Tilt the machine backwards to remove the packaging reinforcement. Remove the packaging reinforcement by pulling the ribbon.

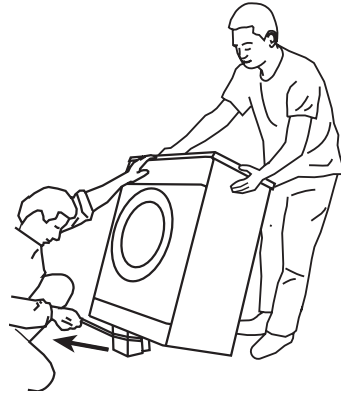

Removing the transportation locks

⚠ Do not remove the transportation locks before taking out the packaging reinforcement.

⚠ Remove the transportation safety bolts before operating the washing machine, otherwise, the product will be damaged.

1. Loosen all the bolts with a spanner until they rotate freely (C).

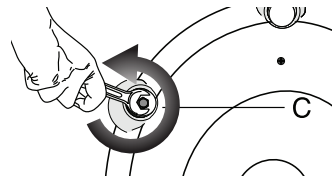

2. Remove transportation safety bolts by turning them gently.

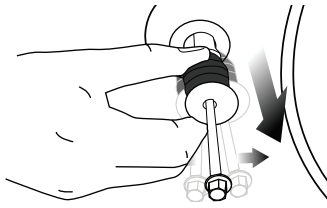

3. Attach the plastic covers supplied in the User Manual bag into the holes on the rear panel. (P)

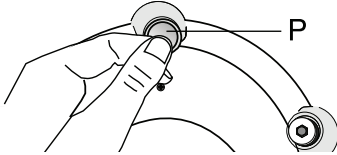

- i** Keep the transportation safety bolts in a safe place to reuse when the washing machine needs to be moved again in the future.
- i** Never move the product without the transportation safety bolts properly fixed in place!

Connecting water supply

- i** The water supply pressure required to run the product is between 1 to 10 bars (0.1 – 10 MPa). It is necessary to have 10 – 80 liters of water flowing from the fully open tap in one minute to have your machine run smoothly. Attach a pressure reducing valve if water pressure is higher.
 - i** If you are going to use the double water-inlet product as a single (cold) water-inlet unit, you must install the supplied stopper to the hot water valve before operating the product. (Applies for the products supplied with a blind stopper group.)
 - i** If you want to use both water inlets of the product, connect the hot water hose after removing the stopper and gasket group from the hot water valve. (Applies for the products supplied with a blind stopper group.)
- !** Models with a single water inlet should not be connected to the hot water tap. In such a case the laundry

will get damaged or the product will switch to protection mode and will not operate.

- !** Do not use old or used water inlet hoses on the new product. It may cause stains on your laundry.
1. Connect the special hoses supplied with the product to the water inlets on the product. Red hose (left) (max. 90 °C) is for hot water inlet, blue hose (right) (max. 25 °C) is for cold water inlet.

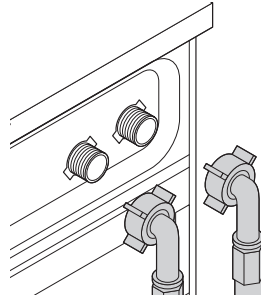

- !** Ensure that the cold and hot water connections are made correctly when installing the product. Otherwise, your laundry will come out hot at the end of the washing process and wear out.
2. Tighten all hose nuts by hand. Never use a wrench when tightening the nuts.

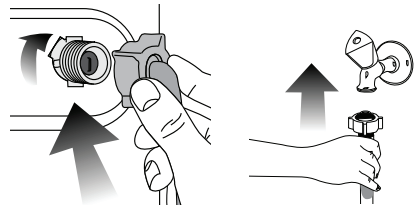

3. Open the taps completely after making the hose connection to check for water leaks at the connection points. If any leaks occur, turn off the tap and remove the nut. Retighten the nut carefully after checking the seal. To prevent water leakages and damages caused by them, keep the taps closed when the machine is not in use.

Connecting to the drain

- The end of the drain hose must be directly connected to the wastewater drain or to the washbasin.

! Your house will be flooded if the hose comes out of its housing during water discharge. Moreover, there is risk of scalding due to high washing temperatures! To prevent such situations and to ensure smooth water intake and discharge of the machine, fix the end of the discharge hose tightly so that it cannot come out.

- The hose should be attached to a height of at least 40 cm, and 100 cm at most.
- In case the hose is elevated after laying it on the floor level or close to the ground (less than 40 cm above the ground), water discharge becomes more difficult and the laundry may come out excessively wet. Therefore, follow the heights described in the figure.

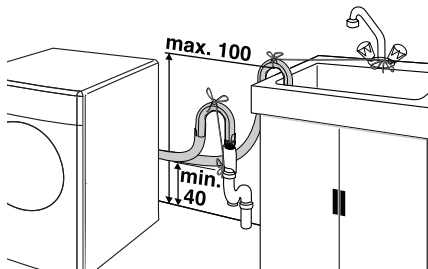

- To prevent flowing of dirty water back into the machine and to allow for easy discharge, do not immerse the hose end into the dirty water or drive it in the drain more than 15 cm. If it is too long, cut it short.
- The end of the hose should not be bent, it should not be stepped on and the hose must not be pinched between the drain and the machine.
- If the length of the hose is too short, use it by adding an original extension hose. Length of the hose may not be longer than 3.2 m. To avoid water leak failures, the connection between the extension hose and the drain hose of the product must be fitted well with

an appropriate clamp as not to come off and leak.

Adjusting the feet

! In order to ensure that the product operates more silent and vibration-free, it must stand level and balanced on its feet. Balance the machine by adjusting the feet. Otherwise, the product may move from its place and cause crushing and vibration problems.

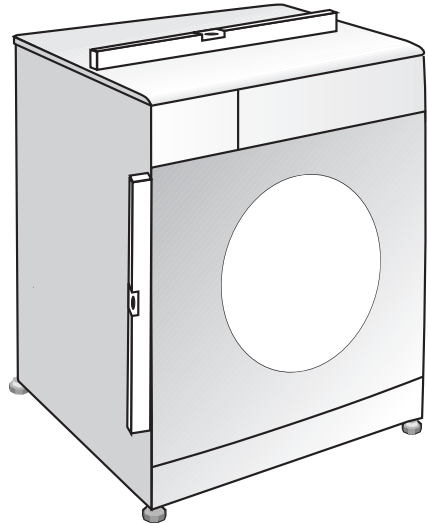

1. Loosen the lock nuts on the feet by hand.
2. Adjust the feet until the product stands level and balanced.
3. Tighten all lock nuts again by hand.

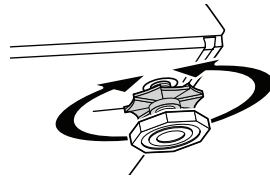

! Do not use any tools to loosen the lock nuts. Otherwise, they will get damaged.

Electrical connection

Connect the product to a grounded outlet protected by a fuse complying with the values in the "Technical specifications" table. Our company shall not be liable

for any damages that will arise when the product is used without grounding in accordance with the local regulations.

- Connection must comply with national regulations.
- Power cable plug must be within easy reach after installation.
- The voltage and allowed fuse or breaker protection are specified in the "Technical specifications" section. If the current value of the fuse or breaker in the house is less than 13 Amps, have a qualified electrician install a 13 Amp fuse.
- The specified voltage must be equal to your mains voltage.
- Do not make connections via extension cables or multi-plugs.

 Damaged power cables must be replaced by the Authorized Service Agents.

Electrical requirements

Before you insert the plug into the wall socket make sure that the voltage and the frequency shown in the rating label corresponds to your electricity supply. We recommend that this appliance be connected to the mains supply via a suitable switched and fused socket in a readily accessible position.

Should the mains lead of the appliance become damaged or need replacing at any time, it must be replaced by a special purpose made mains lead which can only be obtained from a Authorised Service Agent.

 This appliance must be earthed

If the fitted moulded plug is not suitable for your socket, then the plug should be cut off and an appropriate plug fitted. Destroy the old plug, which is cut off as a plug with a bared cord could cause a shock hazard if inserted into a socket elsewhere in the house.

The moulded plug on this appliance incorporates a 13A fuse. Should the fuse need to be replaced an ASTA approved BS1362 fuse of the same rating must be used. Do not forget to refit the fuse cover. In the event of losing the fuse cover, the plug must not be used until a replacement

fuse cover has been fitted. Colour of the replacement fuse cover must be the same colour as that visible on the pin face of the plug. Fuse covers are available from any good electrical store.

Important

Fitting a different plug

As the colours of the wires in the mains lead of this appliance may not correspond with the coloured markings identifying the terminals on your plug, proceed as follows:

- 1 Connect the green - yellow or green (earth) wire to the terminal in the plug marked 'E' or with the symbol \perp or coloured green and yellow or green.
- 2 Connect the blue (neutral) wire to the terminal in the plug marked 'N' or coloured black.
- 3 Connect the brown (live) wire to the terminal in the plug marked 'L' or coloured red.

With the alternative plugs a 13A fuse must be fitted either in the plug or adaptor or in the main fuse box. If in doubt contact a qualified electrician.

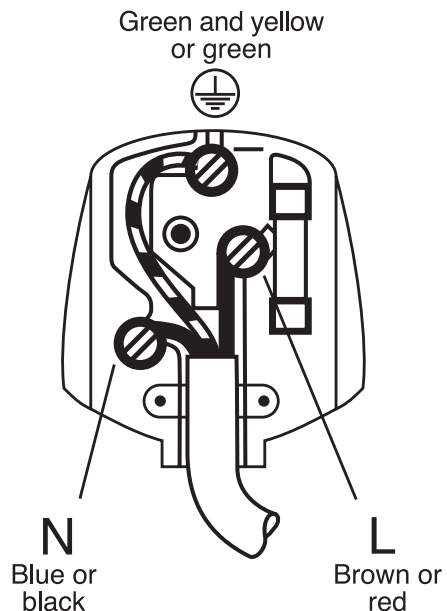

First use

Before starting to use the product, make sure that all preparations are made in accordance with the instructions in sections "Important safety instructions" and "Installation".

To prepare the product for washing laundry, perform first operation in Drum Cleaning programme. If your machine is not featured with Drum Cleaning programme, use Cottons-90 programme and select Additional Water or Extra Rinse auxiliary functions as well. Before starting the programme, put max. 100 g of powder anti-limescale into the main wash detergent compartment (compartment nr. II). If the anti-limescale is in tablet form, put only one tablet into compartment nr. II. Dry the inside of the bellow with a clean piece of cloth after the programme has come to an end.

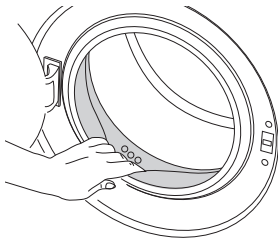

- i** Use an anti-limescale suitable for the washing machines.
- i** Some water might have remained in the product due to the quality control processes in the production. It is not harmful for the product.

Disposing of packaging material

Packaging materials are dangerous to children. Keep packaging materials in a safe place away from reach of the children.

Packaging materials of the product are manufactured from recyclable materials. Dispose of them properly and sort in accordance with recycled waste instructions. Do not dispose of them with normal domestic waste.

Transportation of the product

1. Unplug the product before transporting it.

2. Remove water drain and water supply connections.
 3. Drain the remaining water in the product completely; see, "Draining remaining water and cleaning the pump filter".
 4. Install transportation safety bolts in the reverse order of removal procedure; see, "Removing the transportation locks".
- i** Never move the product without the transportation safety bolts properly fixed in place!

Disposing of the old product

Dispose of the old product in an environmentally friendly manner. Refer to your local dealer or solid waste collection centre in your area to learn how to dispose of your product. For children's safety, cut the power cable and break the locking mechanism of the loading door so that it will be nonfunctional before disposing of the product.

4 Preparation

Things to be done for energy saving

Following information will help you use the product in an ecological and energy-efficient manner.

- Operate the product in the highest capacity allowed by the programme you have selected, but do not overload; see, "Programme and consumption table".
- Always follow the instructions on the detergent packaging.
- Wash slightly soiled laundry at low temperatures.
- Use faster programmes for small quantities of lightly soiled laundry.
- Do not use prewash and high temperatures for laundry that is not heavily soiled or stained.
- If you plan to dry your laundry in a dryer, select the highest spin speed recommended during washing process.
- Do not use detergent in excess of the amount recommended on the detergent package.

Sorting the laundry

- Sort laundry according to type of fabric, colour, and degree of soiling and allowable water temperature.
- Always obey the instructions given on the garment tags.

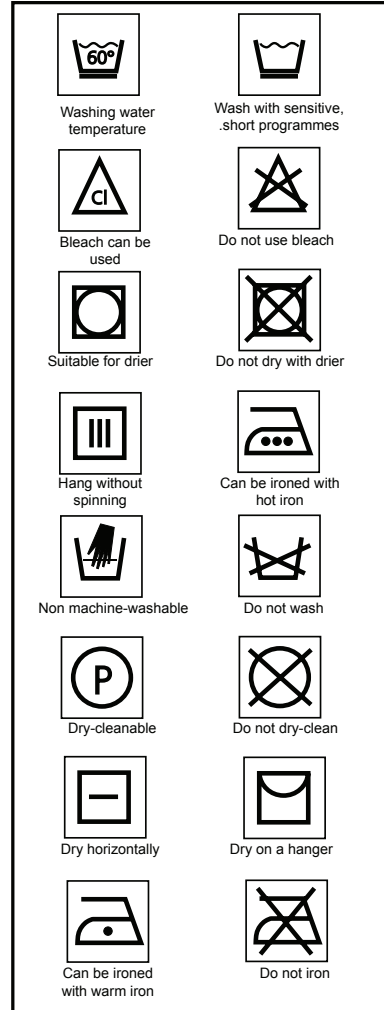

Preparing laundry for washing

- Laundry items with metal attachments such as, underwired bras, belt buckles or metal buttons will damage the machine. Remove the metal pieces or wash the clothes by putting them in a laundry bag or pillow case.



- Take out all substances in the pockets such as coins, pens and paper clips, and turn pockets inside out and brush. Such objects may damage the product or cause noise problem.
- Put small size clothes such as infant's socks and nylon stockings in a laundry bag or pillow case.
- Place curtains in without compressing them. Remove curtain attachment items.
- Fasten zippers, sew loose buttons and mend rips and tears.
- Wash "machine washable" or "hand washable" labeled products only with an appropriate programme.
- Do not wash colours and whites together. New, dark coloured cottons release a lot of dye. Wash them separately.
- Tough stains must be treated properly before washing. If unsure, check with a dry cleaner.
- Use only dyes/colour changers and limescale removers suitable for machine wash. Always follow the instructions on the package.
- Wash trousers and delicate laundry turned inside out.
- Keep laundry items made of Angora wool in the freezer for a few hours before washing. This will reduce pilling.
- Laundry that are subjected to materials such as flour, lime dust, milk powder, etc. intensely must be shaken off before placing into the machine. Such dusts and powders on the laundry may build up on the inner parts of the machine in time and can cause damage.

Correct load capacity

The maximum load capacity depends on the type of laundry, the degree of soiling and the washing programme desired. The machine automatically adjusts the amount of water according to the weight of the loaded laundry.

- ⚠ Follow the information in the "Programme and consumption table". When overloaded, machine's washing performance will drop. Moreover, noise and vibration problems may occur.

Laundry types and their average weights in the following table are given as examples.

Laundry type	Weight (g)
Bathrobe	1200
Napkin	100
Duvet cover	700
Bed Sheet	500
Pillowcase	200
Tablecloth	250
Towel	200
Hand towel	100
Evening gown	200
Underclothing	100
Men's overalls	600
Men's shirt	200
Men's pajamas	500
Blouses	100

Loading the laundry

- Open the loading door.
- Place laundry items loosely into the machine.
- Push the loading door to close until you hear a locking sound. Ensure that no items are caught in the door.
- ⓘ The loading door is locked while a programme is running. The door can only be opened a while after the programme comes to an end.
- ⚠ In case of misplacing the laundry, noise and vibration problems may occur in the machine.

Using detergent and softener

Detergent Drawer

The detergent drawer is composed of three compartments:

- (I) for prewash
- (II) for main wash
- (III) for softener
- (*) in addition, there is siphon piece in the softener compartment.

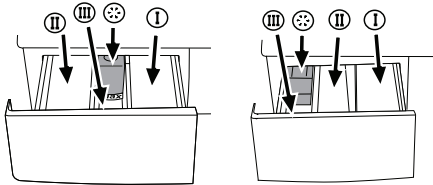

i The detergent dispenser may be in two different types according to the model of your machine as seen above.

Detergent, softener and other cleaning agents

- Add detergent and softener before starting the washing programme.
- Never open the detergent drawer while the washing programme is running!
- When using a programme without prewash, do not put any detergent into the prewash compartment (compartment nr. I).
- In a programme with prewash, do not put liquid detergent into the prewash compartment (compartment nr. I).
- Do not select a programme with prewash if you are using a detergent bag or dispensing ball. Place the detergent bag or the dispensing ball directly among the laundry in the machine.
- If you are using liquid detergent, do not forget to place the liquid detergent cup into the main wash compartment (compartment nr. II).

Choosing the detergent type

The type of detergent to be used depends on the type and colour of the fabric.

- Use different detergents for coloured and white laundry.

- Wash your delicate clothes only with special detergents (liquid detergent, wool shampoo, etc.) used solely for delicate clothes.
- When washing dark coloured clothes and quilts, it is recommended to use liquid detergent.
- Wash woolens with special detergent made specifically for woolens.

! Use only detergents manufactured specifically for washing machines.

! Do not use soap powder.

Adjusting detergent amount

The amount of washing detergent to be used depends on the amount of laundry, the degree of soiling and water hardness. Read the manufacturer's instructions on the detergent package carefully and follow the dosage values.

- Do not use amounts exceeding the dosage quantities recommended on the detergent package to avoid problems of excessive foam, poor rinsing, financial savings and finally, environmental protection.
- Use lesser detergent for small amounts or lightly soiled clothes.
- Use concentrated detergents in the recommended dosage.

Using softeners

Pour the softener into the softener compartment of the detergent drawer.

- Use the dosages recommended on the package.
- Do not exceed the (>max<) level marking in the softener compartment.
- If the softener has lost its fluidity, dilute it with water before putting it in the detergent drawer.

Using liquid detergents

If the product contains a liquid detergent cup:

- Make sure that you have placed the liquid detergent cup in compartment nr. "II".
- Use the detergent manufacturer's measuring cup and follow the instructions on the package.
- Use the dosages recommended on the package.
- If the liquid detergent has lost its fluidity, dilute it with water before

putting in the detergent cup.

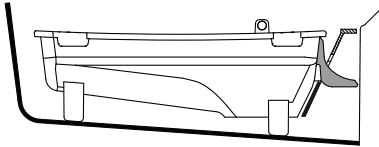
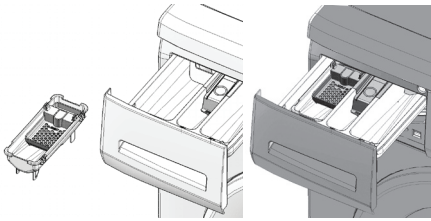

If the product does not contain a liquid detergent cup:

- Do not use liquid detergent for the prewash in a programme with prewash.
- Use the detergent manufacturer's measuring cup and follow the instructions on the package.
- Liquid detergent stains your clothes when used with Delayed Start function. If you are going to use the Delayed Start function, do not use liquid detergent.

Using gel and tablet detergent

When using tablet, gel, etc. detergents, read the manufacturer's instructions on the detergent package carefully and follow the dosage values. If there is not any instruction on the package, apply the following.

- If the gel detergent thickness is fluidal and your machine does not contain a special liquid detergent cup, put the gel detergent into the main wash detergent compartment during first water intake. If your machine contains a liquid detergent cup, fill the detergent into this cup before starting the programme.
- If the gel detergent thickness is not fluidal or in the shape of capsule liquid tablet, put it directly into the drum before washing.
- Put tablet detergents into the main wash compartment (compartment nr. II) or directly into the drum before washing.

i Tablet detergents may leave residues in the detergent compartment. If you encounter such a case, place the tablet detergent between the laundry, close to the lower part of the drum in future washings.

i Use the tablet or gel detergent without selecting the prewash function.

Using starch

- Add liquid starch, powder starch or the dyestuff into the softener compartment as instructed on the package.
- Do not use softener and starch together in a washing cycle.
- Wipe the inside of the machine with a damp and clean cloth after using starch.

Using bleaches

- Select a programme with prewash and add the bleaching agent at the beginning of the prewash. Do not put detergent in the prewash compartment. As an alternative application, select a programme with extra rinse and add the bleaching agent while the machine is taking water from the detergent compartment during first rinsing step.
- Do not use bleaching agent and detergent by mixing them.
- Use just a little amount (approx. 50 ml) of bleaching agent and rinse the clothes very well as it causes skin irritation. Do not pour the bleaching agent onto the clothes and do not use it for coloured clothes.
- When using oxygen based bleaches, follow the instructions on the package and select a programme that washes at a lower temperature.

- Oxygen based bleaches can be used together with detergents; however, if its thickness is not the same with the detergent, put the detergent first into the compartment nr. "II" in the detergent drawer and wait until the detergent flows while the machine is taking in water. Add the bleaching agent from the same compartment while the machine is still taking in water.

Using limescale remover

- When required, use limescale removers manufactured specifically for washing machines only.
- Always follow instructions on the package.

Tips for efficient washing

		Clothes			
		Light colours and whites	Colors	Dark colors	Delicates/Woolens/Silks
		(Recommended temperature range based on soiling level: 40-90C)	(Recommended temperature range based on soiling level: cold-40C)	(Recommended temperature range based on soiling level: cold-40C)	(Recommended temperature range based on soiling level: cold-30C)
Soiling Level	Heavily Soiled (difficult stains such as grass, coffee, fruits and blood.)	It may be necessary to pre-treat the stains of perform prewash. Powder and liquid detergents recommended for whites can be used at dosages recommended for heavily soiled clothes. It is recommended to use powder detergents to clean clay and soil stains and the stains that are sensitive to bleaches.	Powder and liquid detergents recommended for colours can be used at dosages recommended for heavily soiled clothes. It is recommended to use powder detergents to clean clay and soil stains and the stains that are sensitive to bleaches. Use detergents without bleach.	Liquid detergents suitable for colours and dark colours can be used at dosages recommended for heavily soiled clothes.	Prefer liquid detergents produced for delicate clothes. Woollen and silk clothes must be washed with special woollen detergents.
	Normally Soiled (For example, stains caused by body on collars and cuffs)	Powder and liquid detergents recommended for whites can be used at dosages recommended for normally soiled clothes.	Powder and liquid detergents recommended for colours can be used at dosages recommended for normally soiled clothes. Use detergents without bleach.	Liquid detergents suitable for colours and dark colours can be used at dosages recommended for normally soiled clothes.	Prefer liquid detergents produced for delicate clothes. Woollen and silk clothes must be washed with special woollen detergents.
	Lightly Soiled (No visible stains exist.)	Powder and liquid detergents recommended for whites can be used at dosages recommended for lightly soiled clothes.	Powder and liquid detergents recommended for colours can be used at dosages recommended for lightly soiled clothes. Use detergents without bleach.	Liquid detergents suitable for colours and dark colours can be used at dosages recommended for lightly soiled clothes.	Prefer liquid detergents produced for delicate clothes. Woollen and silk clothes must be washed with special woollen detergents.

5 Operating the product

Control panel

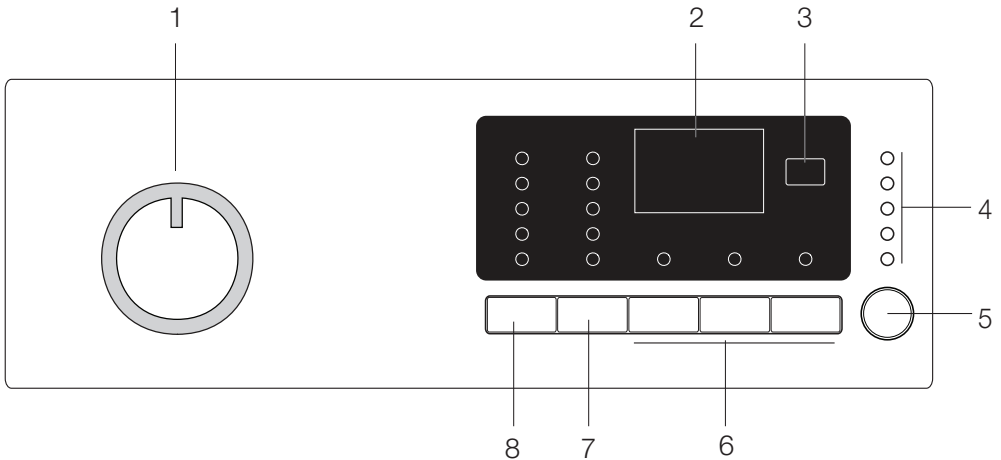

- 1 - Programme Selection knob (Uppermost position On / Off)
- 2 - Display
- 3 - Delayed Start button
- 4 - Programme Follow-up indicator
- 5 - Start / Pause button
- 6 - Auxiliary Function buttons
- 7 - Spin Speed Adjustment button
- 8 - Temperature Adjustment button

Preparing the machine

1. Make sure that the hoses are connected tightly.
2. Plug in your machine.
3. Turn the tap on completely.
4. Place the laundry in the machine.
5. Add detergent and fabric softener.

Programme selection

1. Select the programme suitable for the type, quantity and soiling degree of the laundry in accordance with the "Programme and consumption table" and the temperature table below.

90°C	Heavily soiled white cottons and linens. (coffee table covers, tableclothes, towels, bed sheets, etc.)
60°C	Normally soiled, coloured, fade proof cottons or synthetic clothes (shirt, nightgown, pajamas, etc.) and lightly soiled white linens (underwear, etc.)
40°C- 30°C- Cold	Blended laundry including delicate textile (veil curtains, etc.), synthetics and woolens.

2. Select the desired programme with the Programme Selection button.

- i** Programmes are limited with the highest spin speed appropriate for that particular type of fabric.
- i** When selecting a programme, always consider the type of fabric, colour, degree of soiling and permissible water temperature.
- i** Always select the lowest required temperature. Higher temperature means higher power consumption.
- i** For further programme details, see "Programme and consumption table".

Main programmes

Depending on the type of fabric, use the following main programmes.

• Cottons

Use this programme for your cotton laundry (such as bed sheets, duvet and pillowcase sets, towels, bathrobes, underwear, etc.). Your laundry will be washed with vigorous washing action for a longer washing cycle.

• Synthetics

Use this programme to wash your synthetic clothes (shirts, blouses, synthetic/cotton blends, etc.). It washes with a gentle action and has a shorter washing cycle compared to the Cottons programme.

For curtains and tulle, use the Synthetic 40°C programme with prewash and anti-creasing functions selected. As their meshed texture causes excessive foaming, wash the veils/tulle by putting little amount of detergent into the main wash compartment. Do not put detergent in the prewash compartment.

• Woollens

Use this programme to wash your woolen clothes. Select the appropriate temperature complying with the tags of your clothes. Use appropriate detergents

for woollens.

Additional programmes

For special cases, additional programmes are available in the machine.

- i** Additional programmes may differ according to the model of the machine.

• Cottons Eco

You may wash your normally soiled durable cotton and linen laundry in this programme with the highest energy and water saving compared to all other wash programmes suitable for cottons. Actual water temperature may differ from the declared cycle temperature. Programme duration may automatically be shortened during later stages of the programme if you wash less amount (e.g. ½ capacity or less) of laundry. In this case energy and water consumption will be further decreased giving you the opportunity for a more economical wash. This feature is available for certain models having remaining time display.

• Baby+Toddler Clothing

Use this programme to wash baby laundry, and the laundry that belongs to allergic persons. Longer heating time and an additional rinsing step provide a higher level of hygiene.

• Hand Wash

Use this programme to wash your woolen/delicate clothes that bear "not machine- washable" tags and for which hand wash is recommended. It washes laundry with a very gentle washing action to not to damage clothes.

• Daily Quick

Use this programme to wash your lightly soiled cotton clothes in a short time.

• Dark Care

Use this programme to wash your dark coloured laundry or the laundry that you do not want it get faded. Washing is performed with little mechanic action and at low temperatures. It is recommended to use liquid detergent or woolen shampoo for dark coloured laundry.

• Mixed Fabrics

Use this programme to wash your cotton and synthetic clothes together without

sorting them.

Special programmes

For specific applications, select any of the following programmes.

• Rinse

Use this programme when you want to rinse or starch separately.

• Spin+Drain

Use this programme to apply an additional spin cycle for your laundry or to drain the water in the machine.

Before selecting this programme, select the desired spin speed and press Start / Pause button. First, the machine will drain the water inside of it. Then, it will spin the laundry with the set spin speed and drain the water coming out of them.

If you wish to drain only the water without spinning your laundry, select the Pump+Spin programme and then select the No Spin function with the help of Spin Speed Adjustment button. Press Start / Pause button.

i Use a lower spin speed for delicate laundries.

Temperature selection

Whenever a new programme is selected, the maximum temperature for the selected programme appears on the temperature indicator.

To decrease the temperature, press the Temperature Adjustment button. Temperature will decrease gradually.

i If the programme has not reached the heating step, you can change the temperature without switching the machine to Pause mode.

Spin speed selection

Whenever a new programme is selected, the recommended spin speed of the selected programme is displayed on the spin speed indicator.

To decrease the spin speed, press the Spin Speed Adjustment button. Spin speed decreases gradually.



Then, depending on the model of the product, "Rinse Hold" and "No Spin" options appear on the display. See "Auxiliary function selection" section for

explanations of these options.

i If the programme has not reached the spinning step, you can change the speed without switching the machine to Pause mode.

Programme and consumption table

EN						Auxiliary functions						Selectable temperature range °C
Programme		Max. Load (kg)	Water Consumption (l)	Energy Consumption (kWh)	Max. Speed***	Prewash	Quick Wash	Extra Rinse	Anti-Creasing	Rinse Hold	Soaking	
Cottons	90	7	74	2.30	1600	•	•	•	•	•	•	Cold-90
Cottons	60	7	70	1.54	1600	•	•	•	•	•	•	Cold-90
Cottons	40	7	69	0.85	1600	•	•	•	•	•	•	Cold-90
Cottons Eco	60**	7	44	1.10	1600					•		40-60
Cottons Eco	60**	3.5	38	0.88	1600					•		40-60
Cottons Eco	40**	3.5	38	0.70	1600					•		40-60
Daily Quick	90	7	60	1.90	1200			•		•		Cold-90
Daily Quick	60	7	60	1.00	1200			•		•		Cold-90
Daily Quick	30	7	60	0.25	1200			•		•		Cold-90
Dark Care	40	3.5	66	0.55	800			*		•		Cold-40
Mixed Fabrics	40	3.5	55	0.60	800	•	•	•	•	•	•	Cold-40
Hand Wash	30	1	34	0.20	600							Cold-30
Woollens	40	1.5	47	0.34	600			•		•		Cold-40
Baby&Toddler Clothing	90	7	90	2.40	1600	•		*		•	•	30-90
Synthetics	60	3	55	1.00	800	•	•	•	•	•	•	Cold-60
Synthetics	40	3	55	0.55	800	•	•	•	•	•	•	Cold-60

- : Selectable
- * : Automatically selected, no canceling.
- ** : Energy Label programme (EN 60456 Ed.3)
- *** : If maximum spin speed of the machine is lower then this value, you can only select up to the maximum spin speed.
- : See the programme description for maximum load.
-  Water and power consumption may vary subject to the changes in water pressure, water hardness and temperature, ambient temperature, type and amount of laundry, selection of auxiliary functions and spin speed, and changes in electric voltage.
-  You can see the washing time of the programme you have selected on the display of the machine. It is normal that small differences may occur between the time shown on the display and the real washing time.

i The auxiliary functions in the table may vary according to the model of your machine.

Auxiliary function selection

Select the desired auxiliary functions before starting the programme.

Furthermore, you may also select or cancel auxiliary functions that are suitable to the running programme without pressing the Start / Pause button when the machine is operating. For this, the machine must be in a step before the auxiliary function you are going to select or cancel.

If the auxiliary function cannot be selected or canceled, light of the relevant auxiliary function will blink 3 times to warn the user.

i Some functions cannot be selected together. If a second auxiliary function conflicting with the first one is selected before starting the machine, the function selected first will be canceled and the second auxiliary function selection will remain active. For example, if you want to select Quick Wash after you have selected the Prewash, Prewash will be canceled and Quick Wash will remain active.

i An auxiliary function that is not compatible with the programme cannot be selected. (See "Programme and consumption table")

i Auxiliary Function buttons may vary according to the model of the machine.

• Prewash

A Prewash is only worthwhile for heavily soiled laundry. Not using the Prewash will save energy, water, detergent and time.

i Prewash without detergent is recommended for tulle and curtains.

• Quick Wash

This function can be used in Cottons and Synthetics programmes. It decreases the washing times and also the number of rinsing steps for lightly soiled laundry.

i When you select this function, load your machine with half of the maximum laundry specified in the programme table.

• Extra Rinse

This function enables the machine to make another rinsing in addition to the one already made after the main wash. Thus, the risk for sensitive skins (babies, allergic skins, etc.) to be effected by the minimal detergent remnants on the laundry can be reduced.

• Anti-Creasing

This function creases the clothes lesser when they are being washed. Drum movement is reduced and spinning speed is limited to prevent creasing. In addition, washing is done with a higher water level.

• Rinse Hold

If you are not going to unload your clothes immediately after the programme completes, you may use rinse hold function to keep your laundry in the final rinsing water in order to prevent them from getting wrinkled when there is no water in the machine. Press Start / Pause button after this process if you want to drain the water without spinning your laundry. Programme will resume and complete after draining the water. If you want to spin the laundry held in water, adjust the Spin Speed and press Start / Pause button.

The programme resumes. Water is drained, laundry is spun and the programme is completed.

• Soaking

The Soaking auxiliary function ensures better removal of stains ingrained into the clothes by holding them in the detergent water prior to startup of the programme.

• Pet hair removal

This function helps to remove pet hair that remain on your garments more effectively. When you select this function, Prewash and Extra Rinse steps are added to the normal programme. Thus, washing is performed with more water (30%) and the pet hair is removed more effectively.

⚠ Never wash your pets in the washing machine.

Delayed Start

With the Delayed Start function the startup of the programme may be delayed up to 19 hours. Delayed start time can be increased by increments of 1 hour.

i Do not use liquid detergents when you set Delayed Start! There is the risk of staining of the clothes.

1. Open the loading door, place the laundry and put detergent, etc.
2. Select the washing programme, temperature, spin speed and, if required, the auxiliary functions.
3. Set the desired time by pressing the Delayed Start button.
4. Press Start / Pause button. The delayed start time you have set is displayed. Delayed start countdown starts. “_” symbol next to the delayed start time moves up and down on the display.

i Additional laundry may be loaded during the delayed start period.

5. At the end of the countdown, duration of the selected programme will be displayed. “_” symbol will disappear and the selected programme will start.

Changing the Delayed Start period

If you want to change the time during countdown:

1. Press Delayed Start button. Time will increase by 1 hour each time you press the button.
2. If you want to decrease the delayed start time, press Delayed Start button repeatedly until the desired delayed start time appears on the display.

Canceling the Delayed Start function

If you want to cancel the delayed start countdown and start the programme immediately:

1. Set the Delayed Start period to zero or turn the Programme Selection knob to any programme. Thus, Delayed Start function will be canceled. The End/Cancel light flashes continuously.
2. Then, select the programme you want to run again.
3. Press Start / Pause button to start the programme.

Starting the programme

1. Press Start / Pause button to start the programme.
2. Programme follow-up light showing the startup of the programme will turn

on.

i If no programme is started or no key is pressed within 1 minute during programme selection process, the machine will switch to Pause mode and the illumination level of the temperature, speed and loading door indicator lights will decrease. Other indicator lights and indicators will turn off. Once the Programme Selection knob is rotated or any button is pressed, indicator lights and indicators will turn on again.

Child Lock

Use Child Lock function to prevent children from tampering with the machine. Thus you can avoid any changes in a running programme.

i If the Programme Selection knob is turned when the Child Lock is active, "Con" appears on the display. The Child Lock does not allow any change in the programmes and the selected temperature, speed and auxiliary functions.

i Even if another programme is selected with the Programme Selection knob while the Child Lock is active, previously selected programme will continue running.

To activate the Child Lock:

Press and hold 1st and 2nd Auxiliary Function buttons for 3 seconds.

The lights on the 1st and 2nd Auxiliary Function buttons will flash, and "C03", "C02", "C01" will appear on the display respectively while you keep the buttons pressed for 3 seconds. Then, "Con" will appear on the display indicating that the Child Lock is activated. If you press any button or turn the Programme Selection knob when the Child Lock is active, same phrase will appear on the display. The lights on the 1st and 2nd auxiliary function buttons that are used to deactivate the Child Lock will blink 3 times.

To deactivate the Child Lock:

Press and hold 1st and 2nd auxiliary function buttons for 3 seconds while any programme is running. The lights on the 1st and 2nd Auxiliary Function buttons will flash, and "C03", "C02", "C01" will

appear on the display respectively while you keep the buttons pressed for 3 seconds. Then, "COFF" will appear on the display indicating that the Child Lock is deactivated.

i In addition to the method above, to deactivate the Child Lock, switch the Programme Selection knob to On / Off position when no programme is running, and select another programme.

i Child Lock is not deactivated after power failures or when the machine is unplugged.

Progress of programme

Progress of a running programme can be followed from the Programme Follow-up indicator. At the beginning of every programme step, the relevant indicator light will turn on and light of the completed step will turn off.

You can change the auxiliary functions, speed and temperature settings without stopping the programme flow while the programme is running. To do this, the change you are going to make must be in a step after the running programme step. If the change is not compatible, relevant lights will flash for 3 times.

i If the machine does not pass to the spinning step, Rinse Hold function might be active or the automatic unbalanced load detection system might be activated due to the unbalanced distribution of the laundry in the machine.

Loading door lock

There is a locking system on the loading door of the machine that prevents opening of the door in cases when the water level is unsuitable.

Loading door light will start flashing when the machine is switched to Pause mode. Machine checks the level of the water inside. If the level is suitable, Loading Door light illuminates steadily within 1-2 minutes and the loading door can be opened.

If the level is unsuitable, Loading Door light turns off and the loading door cannot be opened. If you are obliged to open the Loading Door while the Loading Door light is off, you have to cancel the

current programme; see "Canceling the programme".

Changing the selections after programme has started

Switching the machine to pause mode

Press the Start / Pause button to switch the machine to pause mode while a programme is running. The light of the step which the machine is in starts flashing in the Programme Follow-up indicator to show that the machine has been switched to the pause mode.

Also, when the loading door is ready to be opened, Loading Door light will also illuminate continuously in addition to the programme step light.

Changing the speed and temperature settings for auxiliary functions

Depending on the step the programme has reached, you may cancel or activate the auxiliary functions; see, "Auxiliary function selection".

You may also change the speed and temperature settings; see, "Spin speed selection" and "Temperature selection".

i If no change is allowed, the relevant light will flash for 3 times.

Adding or taking out laundry

1. Press the Start / Pause button to switch the machine to pause mode. The programme follow-up light of the relevant step during which the machine was switched into the pause mode will flash.
2. Wait until the Loading Door can be opened.
3. Open the Loading Door and add or take out the laundry.
4. Close the Loading Door.
5. Make changes in auxiliary functions, temperature and speed settings if necessary.
6. Press Start / Pause button to start the machine.

Canceling the programme

To cancel the programme, turn the Programme Selection knob to select another programme. Previous programme will be canceled. End / Cancel light will flash continuously to notify that the

programme has been canceled.
Pump function is activated for 1-2 minutes regardless of the programme step, and whether there is water in the machine or not. After this period, your machine will be ready to start with the first step of the new programme.

i Depending on the step where the programme was canceled in, you may have to put detergent and softener again for the programme you have selected anew.

End of programme

“End” appears on the display at the end of the programme.

1. Wait until the loading door light illuminates steadily.
2. Press On / Off button to switch off the machine.
3. Take out your laundry and close the loading door. Your machine is ready for the next washing cycle.

6 Maintenance and cleaning

Service life of the product extends and frequently faced problems decrease if cleaned at regular intervals.

Cleaning the detergent drawer

Clean the detergent drawer at regular intervals (every 4-5 washing cycles) as shown below in order to prevent accumulation of powder detergent in time.

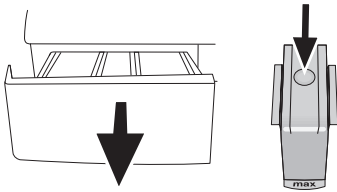

1. Press the dotted point on the siphon in the softener compartment and pull towards you until the compartment is removed from the machine.
 - i** If more than normal amount of water and softener mixture starts to gather in the softener compartment, the siphon must be cleaned.
2. Wash the detergent drawer and the siphon with plenty of lukewarm water in a washbasin. Wear protective gloves or use an appropriate brush to avoid touching of the residues in the drawer with your skin when cleaning.
3. Insert the drawer back into its place after cleaning and make sure that it is seated well.

Cleaning the loading door and the drum

Residues of softener, detergent and dirt may accumulate in your machine in time and may cause unpleasant odours and washing complaints. To avoid this, use the Drum Cleaning programme. If your machine is not featured with Drum Cleaning programme, use Cottons-90 programme and select Additional Water or Extra Rinse auxiliary functions as well. Before starting the programme, put max. 100 g of powder anti-limescale into the main wash detergent compartment

(compartment nr. II). If the anti-limescale is in tablet form, put only one tablet into compartment nr. II. Dry the inside of the bellow with a clean piece of cloth after the programme has come to an end.

- i** Repeat Drum Cleaning process in every 2 months.
- i** Use an anti-limescale suitable for the washing machines.

After every washing make sure that no foreign substance is left in the drum.

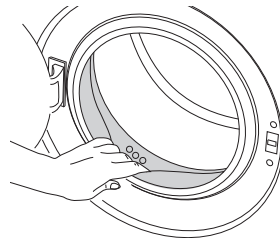

If the holes on the bellow shown in the figure is blocked, open the holes using a toothpick.

- i** Foreign metal substances in your machine will cause rust stains. Clean the stains on the drum surface by using cleaning agents for stainless steel. Never use steel wool or wire wool.

Cleaning the body and control panel

Wipe the body of the machine with soapy water or non-corrosive mild gel detergents as necessary, and dry with a soft cloth.

Use only a soft and damp cloth to clean the control panel.

- ⚠** Never use sponge or scrub materials. These will damage the painted and plastic surfaces.

Cleaning the water intake filters

There is a filter at the end of each water intake valve at the rear of the machine and also at the end of each water intake hose where they are connected to the tap. These filters prevent foreign substances and dirt in the water to enter the washing machine. Filters should be

cleaned as they do get dirty.

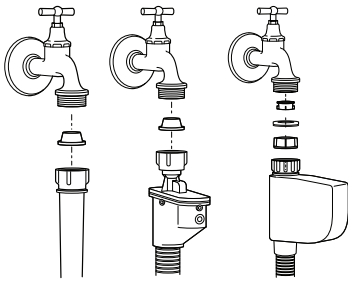

1. Close the taps.
2. Remove the nuts of the water intake hoses to access the filters on the water intake valves. Clean them with an appropriate brush. If the filters are too dirty, take them out by means of pliers and clean them.
3. Take out the filters on the flat ends of the water intake hoses together with the gaskets and clean thoroughly under running water.
4. Replace the gaskets and filters carefully in their places and tighten the hose nuts by hand.

Draining remaining water and cleaning the pump filter

The filter system in your machine prevents solid items such as buttons, coins and fabric fibers clogging the pump impeller during discharge of washing water. Thus, the water will be discharged without any problem and the service life of the pump will extend.

If the machine fails to drain water, the pump filter is clogged. Filter must be cleaned whenever it is clogged or in every 3 months. Water must be drained off first to clean the pump filter.

In addition, prior to transporting the machine (eg., when moving to another house) and in case of freezing of the water, water may have to be drained completely.

⚠ Foreign substances left in the pump filter may damage your machine or may cause noise problem.

In order to clean the dirty filter and discharge the water:

1. Unplug the machine to cut off the supply power.

⚠ Temperature of the water inside the machine may rise up to 90 °C. To avoid burning risk, filter must be cleaned after the water in the machine cools down.

2. Open the filter cap.
If the filter cap is composed of two pieces, press the tab on the filter cap downwards and pull the piece out towards yourself.

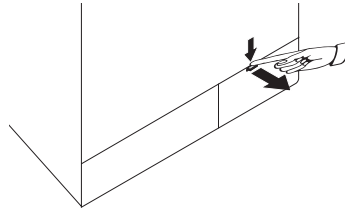

If the filter cap is one piece, pull the cap from both sides at the top to open.

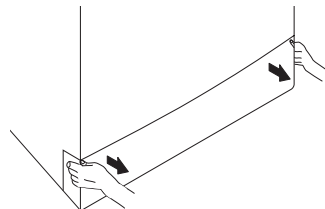

i You can remove the filter cover by slightly pushing downwards with a thin plastic tipped tool, through the gap above the filter cover. Do not use metal tipped tools to remove the cover.

3. Some of our products have emergency draining hose and some does not have. Follow the steps below to discharge the water.

Discharging the water when the product has an emergency draining hose:

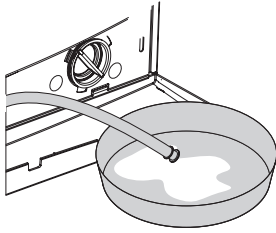

- a. Pull the emergency draining hose out from its seat
- b. Place a large container at the end of the hose. Drain the water into the container by pulling out the plug at the end of the hose. When the container is full, block the inlet of the hose by replacing the plug. After the container is emptied, repeat the above procedure to drain the water in the machine completely.
- c. When draining of water is finished, close the end by the plug again and fix the hose in its place.
- d. Turn the pump filter to take it out. Discharging the water when the product does not have an emergency draining hose:

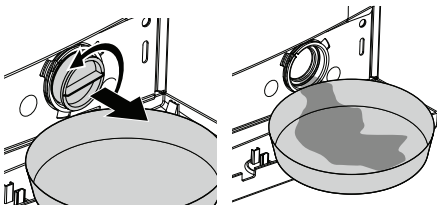

- a. Place a large container in front of the filter to catch water from the filter.
 - b. Loosen pump filter (anticlockwise) until water starts to flow. Fill the flowing water into the container you have placed in front of the filter. Always keep a piece of cloth handy to absorb any spilled water.
 - c. When the water inside the machine is finished, take out the filter completely by turning it.
 4. Clean any residues inside the filter as well as fibers, if any, around the pump impeller region.
 5. Install the filter.
- !** If your product has a water jet feature, be sure to fit the filter into its housing in the pump. Never force the filter

while installing it into its housing. Seat the filter into its place completely. Otherwise, water may leak from the filter cap.

6. If the filter cap is composed of two pieces, close the filter cap by pressing on the tab. If it is one piece, seat the tabs in the lower part into their places first, and then press the upper part to close.

7 Troubleshooting

Programme cannot be started or selected.

- Washing machine has switched to self protection mode due to a supply problem (line voltage, water pressure, etc.). >>> *Press and hold Start / Pause / Cancel button for 3 seconds to reset the machine to factory settings. (See "Canceling the programme")*

Water in the machine.

- Some water might have remained in the product due to the quality control processes in the production. >>> *This is not a failure; water is not harmful to the machine.*

There is water leaking from the bottom of the washing machine.

- Likely problems with hoses or the pump filter. >>> *Be sure the seals of the water inlet hoses are securely fitted. Attach the hose to the tap tightly.*
- Pump filter might not be closed fully. >>> *Make sure that the pump filter is completely closed.*

Machine does not fill with water.

- Tap is turned off. >>> *Open the inlet water taps fully.*
- Water inlet hose is bent. >>> *Flatten the water inlet hose.*
- Water inlet filter is clogged. >>> *Clean the water inlet filter.*
- The loading door is ajar. >>> *Close the Loading Door.*

Machine does not drain water.

- Water drain hose might be clogged or twisted. >>> *Clean or flatten the hose.*
- Pump filter is clogged. >>> *Clean the pump filter.*

Machine vibrates or makes noise.

- Machine might be standing unbalanced. >>> *Adjust the feet to level the machine.*
- A hard substance might have entered into the pump filter. >>> *Clean the pump filter.*
- Transportation safety bolts are not removed. >>> *Remove the transportation safety bolts.*
- Laundry quantity in the machine might be too little. >>> *Add more laundry to the machine.*
- Machine might be overloaded with laundry. >>> *Take out some of the laundry from the machine or distribute the load by hand to balance it homogeneously in the machine.*
- Machine might be leaning on a rigid item. >>> *Make sure that the machine is not leaning on anything.*

Machine stopped shortly after the programme started.

- Machine might have stopped temporarily due to low voltage. >>> *It will resume running when the voltage restores to the normal level.*

Machine directly discharges the water it takes in.

- Draining hose might not be at adequate height. >>> *Connect the water draining hose as described in the operation manual.*

No water can be seen in the machine during washing.

- i** The water level is not visible from outside of the washing machine. This is not a failure.

Loading door cannot be opened.

- Door lock is activated because of the water level in the machine. >>> *Drain the water by running the Pump or Spin programme.*
- Machine is heating up the water or it is at the spinning cycle. >>> *Wait until the programme completes.*
- Child lock is engaged. Door lock will be deactivated a couple of minutes after the programme has come to an end. >>> *Wait for a couple of minutes for deactivation of the door lock.*

Washing takes longer time than the one specified in the manual.

- Water pressure is low. >>> *Machine waits until taking in adequate amount of water to prevent poor washing quality due to the decreased amount of water. Therefore, the washing time extends.*
 - Voltage might be low. >>> *Washing time is prolonged to avoid poor washing results when the supply voltage is low.*
 - Input temperature of water might be low. >>> *Required time to heat up the water extends in cold seasons. Also, washing time can be lengthened to avoid poor washing results.*
 - Number of rinses and/or amount of rinse water might have increased. >>> *Machine increases the amount of rinse water when good rinsing is needed and adds an extra rinsing step if necessary.*
 - Excessive foam might have occurred and automatic foam absorption system might have been activated due to too much detergent usage. >>> *Use recommended amount of detergent.*
- i** Machine does not switch to spinning step when the laundry is not evenly distributed in the drum to prevent any damage to the machine and to its surrounding environment. Laundry should be rearranged and re-spun.

Programme time does not countdown. (On models with display)

- Timer may stop during water intake. >>> *Timer indicator will not countdown until the machine takes in adequate amount of water. The machine will wait until there is sufficient amount of water to avoid poor washing results due to lack of water. Timer indicator will resume countdown after this.*
 - Timer may stop during heating step. >>> *Timer indicator will not countdown until the machine reaches the selected temperature.*
 - Timer may stop during spinning step. >>> *Automatic unbalanced load detection system might be activated due to the unbalanced distribution of the laundry in the drum.*
- i** Machine does not switch to spinning step when the laundry is not evenly distributed in the drum to prevent any damage to the machine and to its surrounding environment. Laundry should be rearranged and re-spun.

Programme time does not countdown.

- There might be an imbalance of laundry in the machine. >>> *Automatic unbalanced load detection system might be activated due to the unbalanced distribution of the laundry in the drum.*
- i** Machine does not switch to spinning step when the laundry is not evenly distributed in the drum to prevent any damage to the machine and to its surrounding environment. Laundry should be rearranged and re-spun.

Machine does not switch to spinning step.

- There might be an imbalance of laundry in the machine. >>> *Automatic unbalanced load detection system might be activated due to the unbalanced distribution of the laundry in the drum.*
- ❗ Machine does not switch to spinning step when the laundry is not evenly distributed in the drum to prevent any damage to the machine and to its surrounding environment. Laundry should be rearranged and re-spun.
- The machine will not spin if water is not drained completely. >>> *Check the filter and the draining hose.*
- Excessive foam might have occurred and automatic foam absorption system might have been activated due to too much detergent usage. >>> *Use recommended amount of detergent.*

Washing performance is poor: Laundry turns gray.

- Insufficient amount of detergent was used over a long period of time. >>> *Use the recommended amount of detergent appropriate for water hardness and the laundry.*
- Washing was made at low temperatures for a long time over a long period of time. >>> *Select the proper temperature for the laundry to be washed.*
- Insufficient amount of detergent is used with hard waters. >>> *Using insufficient amount of detergent with hard water causes the soil to stick on the cloth and this turns the cloth into gray in time. It is difficult to eliminate graying once it happens. Use the recommended amount of detergent appropriate for water hardness and the laundry.*
- Too much detergent is used. >>> *Use the recommended amount of detergent appropriate for water hardness and the laundry.*
- Regular drum cleaning is not applied. >>> *Clean the drum regularly. For this, please see "Cleaning the loading door and the drum".*

Washing performance is poor: Stains persist or the laundry is not whitened.

- Insufficient amount of detergent is used. >>> *Use recommended amount of detergent appropriate for the laundry.*
- Excessive laundry was loaded in. >>> *Do not load the machine in excess. Load with amounts recommended in the "Programme and consumption table".*
- Wrong programme and temperature were selected. >>> *Select the proper programme and temperature for the laundry to be washed.*
- Wrong type of detergent is used. >>> *Use original detergent appropriate for the machine.*
- Detergent is put in the wrong compartment. >>> *Put the detergent in the correct compartment. Do not mix the bleaching agent and the detergent with each other.*
- Regular drum cleaning is not applied. >>> *Clean the drum regularly. For this, please see "Cleaning the loading door and the drum".*

Washing performance is poor: Oily stains appeared on the laundry.

- Regular drum cleaning is not applied. >>> *Clean the drum regularly. For this, please see "Cleaning the loading door and the drum".*

Washing performance is poor: Clothes smell unpleasantly.

- Odours and bacteria layers are formed on the drum as a result of continuous washing at lower temperatures and/or in short programmes. >>> *Leave the detergent drawer as well as the loading door of the machine ajar after each washing. Thus, a humid environment favorable for bacteria cannot occur in the machine.*
- Regular drum cleaning is not applied. >>> *Clean the drum regularly. For this, please see "Cleaning the loading door and the drum".*

Colour of the clothes faded.

- Excessive laundry was loaded in. >>> *Do not load the machine in excess.*
- Detergent in use is damp. >>> *Keep detergents closed in an environment free of humidity and do not expose them to excessive temperatures.*
- A higher temperature is selected. >>> *Select the proper programme and temperature according to the type and soiling degree of the laundry.*
- Regular drum cleaning is not applied. >>> *Clean the drum regularly. For this, please see "Cleaning the loading door and the drum".*

It does not rinse well.

- The amount, brand and storage conditions of the detergent used are inappropriate. >>> *Use a detergent appropriate for the washing machine and your laundry. Keep detergents closed in an environment free of humidity and do not expose them to excessive temperatures.*
- Detergent is put in the wrong compartment. >>> *If detergent is put in the prewash compartment although prewash cycle is not selected, machine can take this detergent during rinsing or softener step. Put the detergent in the correct compartment.*
- Pump filter is clogged. >>> *Check the filter.*
- Drain hose is folded. >>> *Check the drain hose.*

Laundry became stiff after washing.

- Insufficient amount of detergent is used. >>> *Using insufficient amount of detergent for the water hardness can cause the laundry to become stiff in time. Use appropriate amount of detergent according to the water hardness.*
- Detergent is put in the wrong compartment. >>> *If detergent is put in the prewash compartment although prewash cycle is not selected, machine can take this detergent during rinsing or softener step. Put the detergent in the correct compartment.*
- Detergent might be mixed with the softener. >>> *Do not mix the softener with detergent. Wash and clean the dispenser with hot water.*
- Regular drum cleaning is not applied. >>> *Clean the drum regularly. For this, please see "Cleaning the loading door and the drum".*

Laundry does not smell like the softener.

- Detergent is put in the wrong compartment. >>> *If detergent is put in the prewash compartment although prewash cycle is not selected, machine can take this detergent during rinsing or softener step. Wash and clean the dispenser with hot water. Put the detergent in the correct compartment.*
- Detergent might be mixed with the softener. >>> *Do not mix the softener with detergent. Wash and clean the dispenser with hot water.*
- Regular drum cleaning is not applied. >>> *Clean the drum regularly. For this, please see "Cleaning the loading door and the drum".*

Detergent residue in the detergent drawer.

- Detergent is put in wet drawer. >>> *Dry the detergent drawer before putting in detergent.*
- Detergent has gotten damp. >>> *Keep detergents closed in an environment free of humidity and do not expose them to excessive temperatures.*
- Water pressure is low. >>> *Check the water pressure.*
- The detergent in the main wash compartment got wet while taking in the prewash water. Holes of the detergent compartment are blocked. >>> *Check the holes and clean if they are clogged.*
- There is a problem with the detergent drawer valves. >>> *Call the Authorized Service Agent.*
- Detergent might be mixed with the softener. >>> *Do not mix the softener with detergent. Wash and clean the dispenser with hot water.*
- Regular drum cleaning is not applied. >>> *Clean the drum regularly. For this, please see "Cleaning the loading door and the drum".*

There is detergent left on the laundry.

- Excessive laundry was loaded in. >>> *Do not load the machine in excess.*
- Wrong programme and temperature were selected. >>> *Select the proper programme and temperature for the laundry to be washed.*
- Wrong detergent was used. >>> *Select the proper detergent for the laundry to be washed.*
- Regular drum cleaning is not applied. >>> *Clean the drum regularly. For this, please see "Cleaning the loading door and the drum".*

Too much foam forms in the machine.

- Improper detergents for the washing machine are being used. >>> *Use detergents appropriate for the washing machine.*
- Excessive amount of detergent is used. >>> *Use only sufficient amount of detergent.*
- Detergent was stored under improper conditions. >>> *Store detergent in a closed and dry location. Do not store in excessively hot places.*
- Some meshed laundry such as tulle may foam too much because of their texture. >>> *Use smaller amounts of detergent for this type of item.*
- Detergent is put in the wrong compartment. >>> *Put the detergent in the correct compartment.*
- Softener is being taken early. >>> *There may be problem in the valves or in the detergent dispenser. Call the Authorized Service Agent.*
- Regular drum cleaning is not applied. >>> *Clean the drum regularly. For this, please see "Cleaning the loading door and the drum".*

Foam is overflowing from the detergent drawer.

- Too much detergent is used. >>> *Mix 1 tablespoonful softener and ½ l water and pour into the main wash compartment of the detergent drawer.*
- i** Put detergent into the machine suitable for the programmes and maximum loads indicated in the “Programme and consumption table”. When you use additional chemicals (stain removers, bleaches and etc), reduce the amount of detergent.

Laundry remains wet at the end of the programme

- Excessive foam might have occurred and automatic foam absorption system might have been activated due to too much detergent usage. >>> *Use recommended amount of detergent.*
- i** Machine does not switch to spinning step when the laundry is not evenly distributed in the drum to prevent any damage to the machine and to its surrounding environment. Laundry should be rearranged and re-spun.

! If you cannot eliminate the problem although you follow the instructions in this section, consult your dealer or the Authorized Service Agent. Never try to repair a nonfunctional product yourself.

Your new Beko product is guaranteed against the cost of breakdown repairs for twelve months from the date of the original purchase.

What is covered?

- Repairs necessary as a result of faulty materials, defective components or manufacturing defect.
- The cost of functional replacement parts, but excluding consumable items.
- The labour costs of a Beko approved repairer to carry out the repair.

What is not covered?

- Transit, delivery or accidental damage or misuse and abuse.
- Cabinet or appearance parts, including knobs, flaps, handles or container lids.
- Accessories or consumable items including but not limited to, ice trays, scrapers, cutlery baskets, filters and light bulbs.
- Repairs required as a result of unauthorised repair or inexpert installation that fails to meet the requirements contained in the user instruction book.
- Repairs to products used on commercial or non-residential household premises.
- Loss of frozen food in freezers or fridge/freezers. (Food loss insurance is often included within your household contents insurance policy, or may be available separately from your retailer).

Important notes.

- Your Beko product is designed and built for domestic household use only.
- The guarantee will be void if the product is installed or used in commercial or non-residential domestic household premises.
- The product must be correctly installed, located and operated in accordance with the instructions contained in the User Instructions

Booklet provided.

- Professional installation by a qualified Electrical Domestic Appliance Installer is recommended for all Washing Machines, Dishwashers and Electric Cookers
- Gas Cookers must only be installed by a CORGI (or BORD GAIS) registered Gas Installer.
- The guarantee is given only within the boundaries of the United Kingdom and the Republic of Ireland.
- The guarantee is applicable only to new products and is not transferable if the product is resold.
- Beko disclaims any liability for incidental or consequential damages.
- The guarantee does not in anyway diminish your statutory or legal rights.

Should you experience any difficulty in obtaining service please contact the Beko Customer Help-Line.

Tel: 0845 600 4911

e-mail:service@beko.co.uk

9 Service

Please keep your purchase receipt or other proof of purchase in a safe place; you will need to have it should the product require attention under guarantee.

You should also complete the details below; it will help us assist you when requesting service. (The model number is printed on the Instruction Booklet and the serial number is printed on the Rating Label affixed to the appliance)

Model No:

Serial No:

Retailer:

Date of purchase:

For service under guarantee simply telephone the appropriate number below

UK Mainland & Northern Ireland

Fridges & Freezers 0845 600 4903

Electric Cookers 0845 600 4902

Gas & 0845 600 4905

Dual Fuel Cookers

Washing Machines & 0845 600 4906
Dishwashers

Republic of Ireland

All Refrigeration, 01 862 3411

All Cookers

Washing Machines & Dishwashers

Before requesting service please check the trouble-shooting guide in the Operating Instructions as a charge may be levied where no fault is found even though your product may still be under guarantee.

Service once the manufacturers guarantee has expired.

If you have purchased an extended guarantee please refer to the instructions contained within the extended guarantee agreement document. Otherwise please call the appropriate number above where

service can be obtained at a charge.

Should you experience any difficulty in obtaining service please contact the Beko Customer Help-Line.

Tel: 0845 600 4911

e-mail:service@beko.co.uk

BEKO



**Beko plc Beko House, Caxton Way, Watford
Hertfordshire, WD18 8UF**

Tel: 0845 6004911

Fax: 0845 6004922

Email: service@beko.co.uk

www.beko.co.uk

Downloaded from www.Somanuals.com. All Manuals Search And Download.

Free Manuals Download Website

<http://myh66.com>

<http://usermanuals.us>

<http://www.somanuals.com>

<http://www.4manuals.cc>

<http://www.manual-lib.com>

<http://www.404manual.com>

<http://www.luxmanual.com>

<http://aubethermostatmanual.com>

Golf course search by state

<http://golfingnear.com>

Email search by domain

<http://emailbydomain.com>

Auto manuals search

<http://auto.somanuals.com>

TV manuals search

<http://tv.somanuals.com>