

BEKO

*installation & operating
instructions and washing guidance*

Automatic
washing machine

WME 8227 W



get the best from your new washer

Please read this manual first!

Dear Customer,

We hope that your product which has been manufactured in modern facilities and passed through a strict quality control procedure will give you the best results. Therefore, we advise you to read through this manual carefully before using your product and keep it for future reference.

This operation manual will...

...help you use your machine in a fast and safe way.

- Please read the Operation Manual before installing and starting your machine.
- Particularly follow the instructions related to safety.
- Keep this Operating Manual within easy reach. You may need it in the future.
- Please read all additional documents supplied with this machine.

Please note that this Operating Manual may be applicable for several other models. Differences between models will be identified in the manual.

Explanation of symbols

Throughout this Operation Manual the following symbols are used:

- ⓘ Important information or useful hints about usage.
- ⚠ Warning for hazardous situations with regard to life and property.
- ⚡ Warning for supply voltage.

2820520948_EN/200409.1114



This appliance's packaging material is recyclable. Help recycle it and protect the environment by dropping it off in the municipal receptacles provided for this purpose. Your appliance also contains a great amount of recyclable material. It is marked with this label to indicate the used appliances that should not be mixed with other waste. This way, the appliance recycling organised by your manufacturer will be done under the best possible conditions, in compliance with European Directive 2002/96/EC on Waste Electrical and Electronic Equipment. Contact your town hall or your retailer for the used appliance collection points closest to your home. We thank you doing your part to protect the environment.

TABLE OF CONTENTS

1 Your Washing Machine	4	Spin Speed selection 18
Overview	4	Programme selection and consumption table 19
Specifications	5	Auxiliary functions 20
2 Warnings	6	Time screen. 20
General Safety	6	Starting the programme. 21
First Use	6	Progress of programme. 21
Intended use	6	Changing the selections after the programme has started 22
Safety instructions	6	Child/key lock 22
If there are children in your house.	7	Ending the programme through cancelling 23
Electrical connection	7	Programme in rinse hold mode 23
3 Installation	9	End of programme 23
Removing packaging reinforcement.	9	6 Quick instructions for daily use
Opening the transportation locks.	9	24
Appropriate installation location	9	<hr/>
Adjusting the feet.	9	7 Cleaning and care
Connecting to the water supply.	10	26
Connecting to the drain	10	Detergent drawer. 26
Electrical connection	11	The door and the drum 26
Destroying the packaging material.	11	Outer cabinet and control panel. . . . 26
Disposing of the old machine.	11	Inlet water filters. 26
4 Initial preparations for washing	12	Draining any remaining water and cleaning the pump filter 27
Sorting the laundry	12	8 Solution suggestions for problems
Preparing clothes for washing	12	29
Correct load capacity	12	<hr/>
Loading door.	13	9 Guarantee
Detergents and softeners	13	35
5 Selecting a programme and operating your machine	15	<hr/>
Control panel.	15	10 Service
Display symbols.	16	36
Turning the machine on.	16	<hr/>
Programme selection.	16	
Additional programmes	17	
Special programs	17	
Temperature selection.	18	

1 Your Washing Machine

Overview

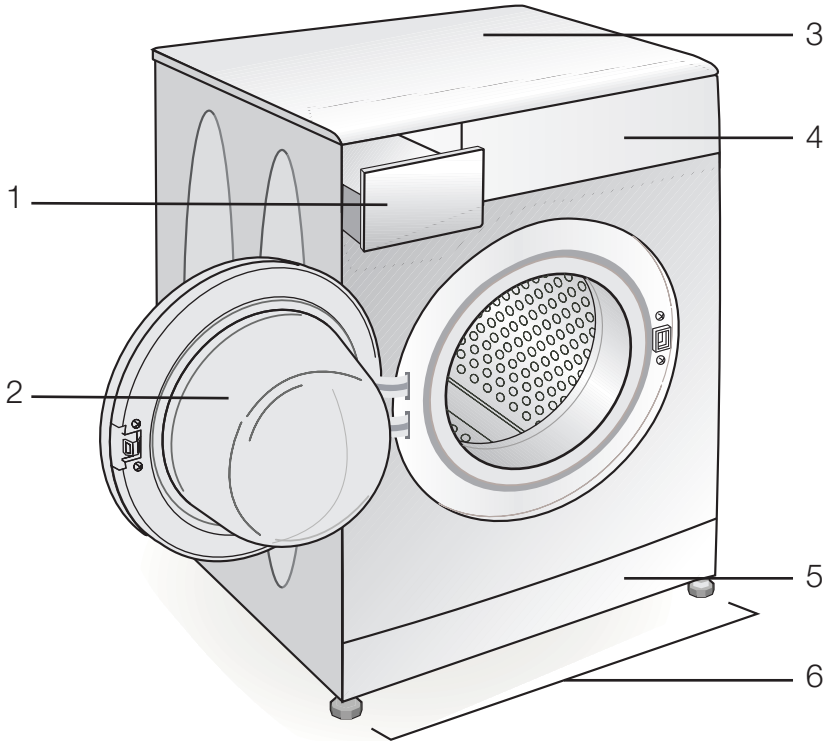

1 - Detergent Drawer

4 - Control Panel

2 - Door

5 - Filter Cap

3 - Top Lid

6 - Height-adjustable feet

Specifications

Models	WME8227W
Maximum dry laundry capacity (kg)	8
Height (cm)	84
Width (cm)	60
Depth (cm)	59
Net Weight (kg)	75
Electricity (V/Hz.)	230 V / 50Hz
Total Current (A)	10
Total Power (W)	2200
Spinning cycle (rpm max.)	1200

Specifications of this appliance may change without notice to improve the quality of the product. Figures in this manual are schematic and may not match your product exactly.

Values stated on the machine labels or in the documentation accompanying it are obtained in laboratory in accordance with the relevant standards. Depending on operational and environmental conditions of the appliance, values may vary.

2 Warnings

Please read the following information. Otherwise, there may be the risk of personal injury or material damage. Moreover, any warranty and reliability commitment will become void.

General Safety

- Never place your machine on a carpet covered floor. Otherwise, lack of airflow from below your machine may cause electrical parts to overheat. This may cause problems with your washing machine.
- If the power cable or mains plug is damaged you must call Authorized Service for repair.
- Check water hoses for wear. Do not use old/used water inlet hoses. These may cause stains on your laundry.
- Fit the drain hose into the waste water system securely to prevent any water leakage and to allow machine to take in and discharge water as required. It is very important that the water intake and drain hoses are not folded, squeezed, or broken when the appliance is pushed into place after it is installed or cleaned.
- Your washing machine is designed to continue operating when the power restores after a power interruption. You cannot cancel any program by pressing the “On/Off button.” The machine will resume its program when the power restores. Press the “Start/Pause/Cancel” button for 3 seconds to cancel the program (See, Cancelling a Program)
- There may be some water in your machine when you receive it. This is from the quality control process and is normal. It is not harmful to your machine.
- Some problems you may encounter

may be caused by the software. Press “Start/Pause/Cancel” button for 3 seconds to cancel the program set in your machine before calling the authorized service.

First Use

- To prepare your machine for washing, carry out your first washing process without loading your machine and with detergent under “Cottons 90°C” program.
- Ensure that the cold water connections has been made correctly when installing your machine.
- If the current fuse or circuit breaker is less than 15 Amperes, please have a qualified electrician install a 15 Ampere fuse or circuit breaker.
- To make your machine ready for use, please be sure that the tap water supply and water drainage systems are appropriate before calling the authorized service. If they are not, call a qualified plumber to have any necessary arrangements carried out.

Intended use

- This product has been designed for home use.
- The appliance may only be used for washing and rinsing of textiles that are marked accordingly.
- Only detergents, softeners and supplements suitable for washing machines may be used.
- Observe the care instructions labelled on textile products and any other instructions given by companies that produce detergents for your machine.

Safety instructions

- This appliance must be connected to an earthed outlet protected by a fuse of suitable capacity.

- The supply and draining hoses must always be securely fastened and remain in an undamaged state.
- Fit the draining hose to a washbasin or waste system securely before starting up your machine. There may be a risk of being scalded due to high washing temperatures!
- Never open the door or remove the filter while there is still water in the drum. Otherwise, there may be the risk of flooding and possible injury due to the hot water.
- Never force open the locked door! The door will be ready to open just a few minutes after the washing cycle comes to an end.
- Unplug the machine when it is not in use.
- Never wash down the appliance with a water hose! There is the risk of electric shock! Always disconnect from the mains by unplugging before cleaning.
- Never touch the plug with wet hands. Never unplug by pulling on the cable, always pull out from the plug only. Do not operate the machine if the power cord or plug is damaged.
- Never attempt to repair the machine yourself. Otherwise, you may be putting yours and other's lives in danger.
- For malfunctions that cannot be solved by information in the operating manual: Turn off the machine, unplug it, turn off the water tap and contact an authorized service agent.

If there are children in your house...

- Electrical appliances may be dangerous for the children. Keep children away from the machine when it is operating. Do not let them tamper with the machine.
- Close the door when you leave the area where the machine is located.

- Store all detergents in a safe place out of reach of the children.
- Use Child/Keylock to prevent children altering the settings

Electrical connection

Make sure that you have an earthed power outlet socket rated at 13 amps (minimum).

Attention!

If you place your machine under a worktop, the socket must be reachable after installation, or a separate switch (which can disconnect the two poles) must be used in the installation.

Connect the power cord to the appropriate electrical socket with an equivalent current rating indicated on the rating plate at the front of the machine behind the kick plate.

After removing the plug from its transit position, please insert the plug seal to prevent water spillage entering the machine.

Electrical requirements

Before you insert the plug into the wall socket make sure that the voltage and the frequency shown in the rating label corresponds to your electricity supply.

We recommend that this appliance be connected to the mains supply via a suitable switched and fused socket in a readily accessible position.

Should the mains lead of the appliance become damaged or need replacing at any time, it must be replaced by a special purpose made mains lead which can only be obtained from a Authorised Service Agent.

 This appliance must be earthed

If the fitted moulded plug is not suitable for your socket, then the plug should be cut off and an appropriate plug fitted.

Destroy the old plug, which is cut off as a plug with a bared cord could cause a shock hazard if inserted into a socket elsewhere in the house.

The moulded plug on this appliance incorporates a 13A fuse. Should the fuse need to be replaced an ASTA approved BS1362 fuse of the same rating must be used. Do not forget to refit the fuse cover. In the event of losing the fuse cover, the plug must not be used until a replacement fuse cover has been fitted. Colour of the replacement fuse cover must be the same colour as that visible on the pin face of the plug. Fuse covers are available from any good electrical store.

Important

Fitting a different plug

As the colours of the wires in the mains lead of this appliance may not correspond with the coloured markings identifying the terminals on your plug, proceed as follows:

- 1 Connect the green - yellow or green (earth) wire to the terminal in the plug marked 'E' or with the symbol  or coloured green and yellow or green.
- 2 Connect the blue (neutral) wire to the terminal in the plug marked 'N' or coloured black.
- 3 Connect the brown (live) wire to the terminal in the plug marked 'L' or coloured red.

With the alternative plugs a 13A fuse must be fitted either in the plug or adaptor or in the main fuse box. If in doubt contact a qualified electrician.

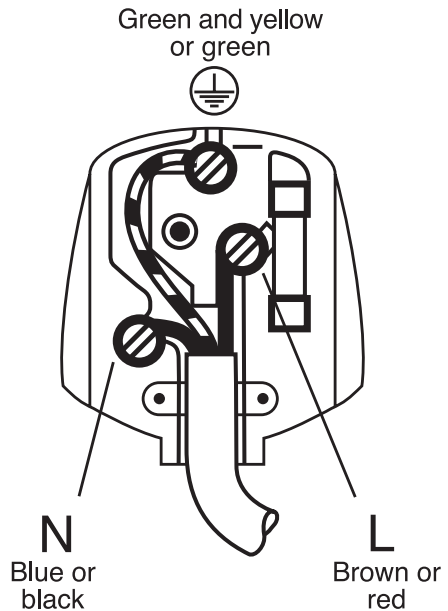

3 Installation

Removing packaging reinforcement

Tilt the machine to remove the packaging reinforcement. Remove the packaging reinforcement by pulling the ribbon.



Opening the transportation locks

❗ Transportation safety bolts must be removed before operating the washing machine! Otherwise, the machine will be damaged!

1. Loosen all the bolts with a spanner until they rotate freely ("C")

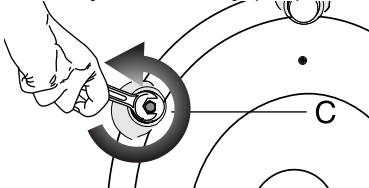

2. Remove transportation safety bolts by turning them gently.



3. Fit the covers (supplied in the bag with the Operation Manual) into the holes on the rear panel. ("P")

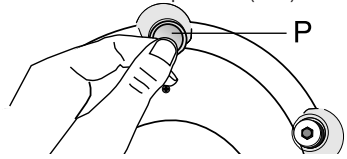

- ❗ Keep the transportation safety bolts in a safe place to reuse when the washing machine needs to be moved again in the future.
- ❗ Never move the appliance without the transportation safety bolts properly fixed in place!

Appropriate installation location

Install the appliance in environments which have no risk of freezing, in a stable and level position.

- ❗ The floor must be capable of carrying the load on it!
- ❗ If the washing machine and a drier are placed on top of each other, their approximate weight together may reach 180 kg when they are full.

Important:

- Do not place the appliance on top of the power cable.
- Keep at least 1cm distance from the edges of other furniture.
- Place the machine on a firm surface; do not position it on a long pile rug or such like surfaces.

Adjusting the feet

❗ Do not use any tools to loosen the lock nuts. Otherwise, they can be damaged.

1. Manually (by hand) loosen the lock nuts on the feet.
2. Adjust them until the machine stands level and firm.
3. Important: Tighten all lock nuts up again.

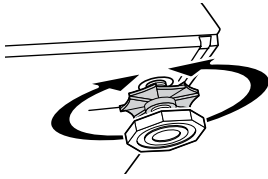

Connecting to the water supply.

Important:

- The water supply pressure required to run the machine must be 1-10 bar (0,1 – 1 MPa). (Practically, it is necessary to have 10 – 80 liters of water flowing from the tap in one minute to have your machine run smoothly.) Attach a pressure-reducing valve if the water pressure is higher.
- Connect the special hose supplied with the machine to the water intake valves on the machine.

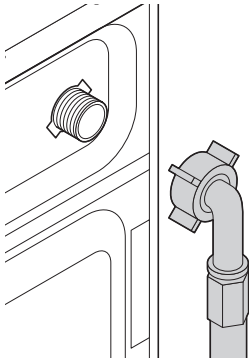

- In order to prevent water leakage that may occur at the connection points, there are rubber seals (4 seals for the models with double water inlet and 2 seals for other models) attached to the hoses. These seals should be used at the tap and machine connection ends of the hoses. The plain end of the hose fitted with a filter must be attached to the tap and the elbowed end must be attached to the machine. Tighten the nuts of the hose well by hand; never use wrenches to tighten the nuts.

- Open the taps completely after making the hose connection to check if there is any water leakage at the connection points. Turn off the tap and remove the nut in case of any leakage. Retighten the nut carefully after checking the seal. To prevent any water leakage and any other damage to be caused by it, keep the taps closed when the machine is not in use.

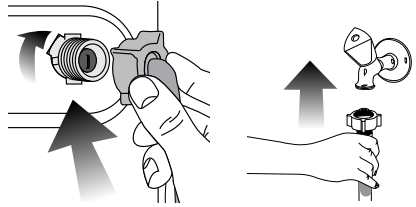

- Models with a single water inlet should not be connected to the hot water tap. Laundry may be damaged or the appliance may switch to protection mode and not work.

When returning the appliance to its place after maintenance or cleaning, care should be taken not to fold, squeeze or block the hoses.

Connecting to the drain

The water discharge hose can be attached to the edge of a washbasin or waste water system. The drain hose should be firmly fitted into the drain as to not loosen in its housing.

Important:

- The end of the drain hose can be directly connected to the wastewater drain or to the washbasin. The fitting must be secured in all types of connections. Your house may be flooded if the hose falls out of its housing during water discharging.
- The hose should be attached to a height of at least 40 cm, and 100 cm at most.

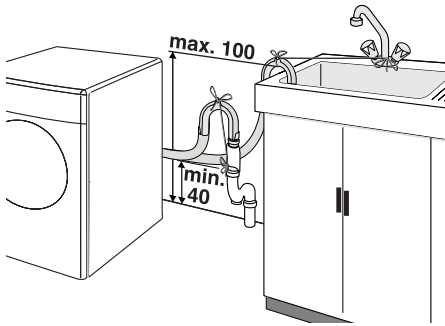

- In case the hose is elevated after laying it on the floor level or close to the ground (less than 40 cm above the ground), water discharge becomes more difficult and the laundry may come out wet. Therefore, the heights described in the figure should be followed.
- To prevent dirty water refilling the machine, and to allow for easy discharge, the end of the hose must not be submerged in the drain water. The end of the hose must be able to take in air. The hose should be pushed into the drainage for more than 15 cm. If it is too long you may have it shortened.
- The end of the hose should not be bent, it should not be stepped on and it must not be folded between the drain and the machine.
- The length of the hose is too short, you may add an extension hose to the original section. The length of the hose must not be longer than 3.2 m after coming out of the machine. To avoid water leakage failures, the connection between the extension hose and the drain hose of the product must be fitted well with an appropriate clamp as not to come off and leak.

Electrical connection

Connect the machine to an earthed outlet protected by a fuse of suitable capacity.

Important:

- Connection should comply with

national regulations.

- Power cord plug must be within easy reach after installation.
- The voltage and the allowed fuse protection are specified in the section “Technical Specifications”.
- The specified voltage must be equal to your mains voltage.
- Connection via extension cords or multi-plugs should not be made.
- ⚠ A damaged power cable must be replaced by a qualified electrician.
- ⚠ A faulty appliance must not be operated whilst faulty until it has been repaired! There is the risk of electric shock!

Destroying the packaging material

Packaging material can be dangerous to children. Keep the packaging materials out of reach of children or dispose them by classifying according to waste directives. Do not dispose of them together with normal domestic waste. Packaging materials of your machine are manufactured from recyclable materials.

Disposing of the old machine

Dispose of your old appliance in an environmental friendly manner.

- You may refer to your local agent or solid waste collection center in your municipality to learn how to dispose of your machine.

Before disposing of your old washing machine, cut off the mains plug and make the door lock unusable.

4 Initial preparations for washing

Sorting the laundry

- Sort the laundry according to type of fabric, color, and degree of soiling and permissible water temperature. Always follow the advice on the garment labels.

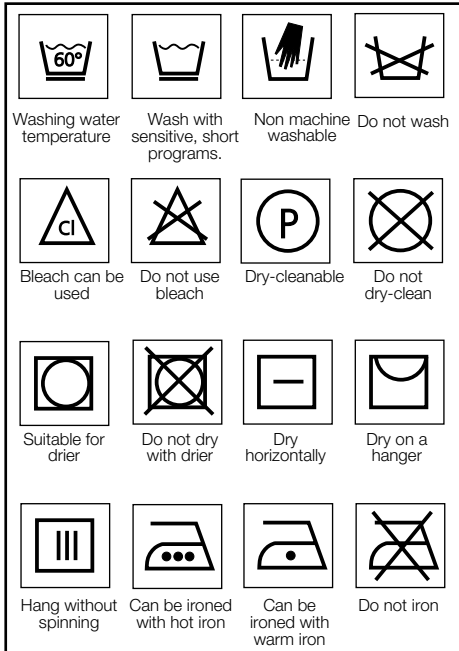

Preparing clothes for washing

Laundry items with metal attachments such as, bras, belt buckles and metal buttons will damage the machine. Remove metal attachments or place the items in a clothing bag, pillow case, or something similar.

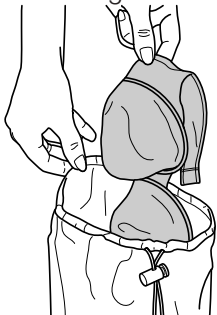

- Empty pockets and remove all foreign objects such as coins, pens and paper clips. If possible, turn pockets out and brush.
- Place small items like infants' socks and nylon stockings, etc. in a laundry bag, pillow case or something similar. This will also save your laundry from getting lost.
- Place curtains in the machine with care. Remove curtain rails and pullers.
- Fasten zippers, sew loose buttons and mend rips and tears.
- Wash "machine washable" or "hand washable" labelled products only with an appropriate program.
- Do not wash colours and whites together. New, dark coloured cottons may release a lot of dye. Wash them separately.
- Tough stains must be treated properly before washing. If you are not sure, check with a dry cleaner.
- Use only dyes/colour changers and lime removers suitable for machine wash. Always follow the instructions on the packaging.
- Wash trousers and delicate clothes turned inside out.
- Keep laundry items made of Angora wool in the freezer for a few hours before washing. This will reduce pilling.

Correct load capacity

- The maximum load capacity depends on the type of laundry, the degree of soiling and the washing program you wish to use.
- i** The machine adjusts the amount of water according to the amount of laundry placed inside.
- i** Please follow the information in the "Program Selection Table". Washing results will degrade when the machine is overloaded.

Following weights are given as examples.

Laundry type	Weight (gr.)
Bathrobe	1200
Napkin	100
Duvet cover	700
Bed Sheet	500
Pillowcase	200
Tablecloth	250
Towel	200
Evening gown	200
Underclothing	100
Men's overalls	600
Men's shirt	200
Men's pyjamas	500
Blouse	100

Loading door

The door is locked during program operation. The door can be opened after some time following the program end.

- Open the door.
- Place laundry items loosely in the machine.
- Push the door until it clicks into place tightly. Ensure that no items are caught in the door.

Detergents and softeners

Detergent drawer

The detergent drawer is composed of three compartments:

The detergent dispenser may be in two different types according to the model of your machine.

- (I) for prewash
- (II) for main wash
- (III) siphon
- (☼) for softener

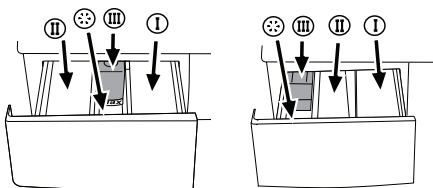

Detergent, softener and other cleaning agents

Add detergent and softener before starting the washing program.

Never open the detergent dispenser drawer while the washing program is running!

When using a program without pre-wash, no detergent should be put into the pre-wash compartment (Compartment no. I).

A program without pre-wash should be selected if a detergent bag or a dispensing ball is going to be used.

You can place the detergent bag or the dispensing ball directly among the laundry in your machine.

Choosing the detergent type

The type of detergent to be used depends on the type and colour of fabric.

- Use different detergents for coloured and white clothes.
- Wash woolens with a special detergent specifically for woolens.
- Use only detergents manufactured specifically for automatic washing machines.

Detergent quantity

The amount of washing detergent to be used depends on the amount of laundry, the degree of soiling and water hardness.

- Do not use amounts exceeding the quantities recommended on the package to avoid problems of excessive foam, poor rinsing, financial savings and finally, environmental protection.
- Use small amounts of detergent at a suitable measure for small amounts of laundry or for only slightly soiled laundry.
- Use exact measures for highly concentrated detergents.

	Detergent quantity
for prewashing	1/2 measure
for main washing	1 measure
with hard water	an additional 1/2 measure

follow the instructions on the package.

Softener

Put the softener into the softener compartment of the detergent dispenser.

- Use the proportions recommended on the packet.
- Never exceed the (> max <) level marking; otherwise, the softener will be wasted without being used.
- If the softener has lost its fluidity, dilute dense softener with water before placing it in the detergent drawer.

Liquid detergent

When using liquid or gel washing detergents, please note the following:

- The liquid detergent may leave stains on your laundry if time delay feature is selected.
- Do not use liquid detergent if you want to wash using the time delay feature.
- Do not use liquid detergent for the main wash in a cycle with pre-wash.
- Use the detergent manufacturer's measuring cup and follow the instructions on the package.

Starch

- Add liquid starch, powder starch or the fabric dye into the softener compartment as instructed on the package.
- Never use fabric softener and starch together in the same washing cycle.
- Wipe the inside of the drum after using starch.

Eliminating lime formation

- When required, use only appropriate lime removers developed specifically for washing machines and always

5 Selecting a programme and operating your machine

Control panel

Figure 1

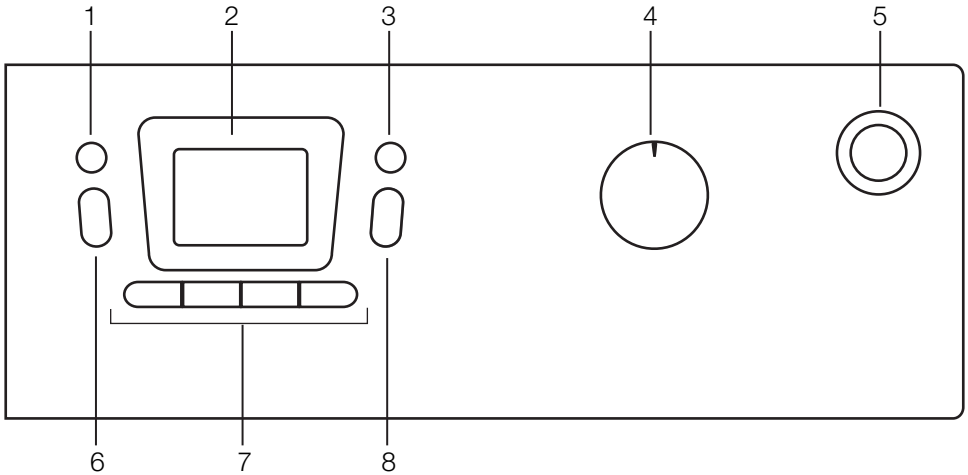

- 1 - Spin Speed Adjustment Button
- 2 - Display
- 3 - Temperature Adjustment Button
- 4 - Programme Selection Knob
- 5 - On / Off Button
- 6 - Time Delaying Button (+/-)
- 7 - Auxiliary Function Buttons
- 8 - Start/Pause/Cancel Button

Display symbols

Figure 2

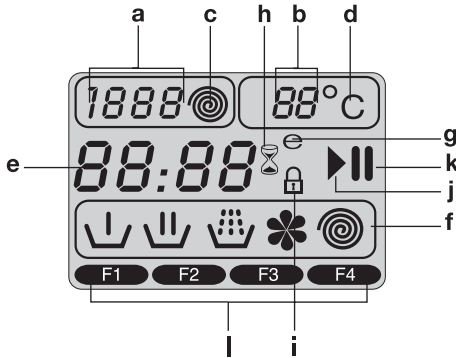

- 2.a - Spin Speed Indicator
- 2.b - Temperature Indicator
- 2.c - Spinning Symbol
- 2.d - Temperature Symbol
- 2.e - Remaining Time and Delaying Time Indicator
- 2.f - Programme Indicator Symbols (prewash/mainwash/rinsing/softener/spinning)
- 2.g - Economy Symbol
- 2.h - Time Delaying Symbol
- 2.i - Door Locked Symbol
- 2.j - Start Symbol
- 2.k - Pause Symbol
- 2.l - Auxiliary Function Symbols

Turning the machine on

Plug in your machine. Turn the tap on completely. Check if the hoses are connected tightly. Place the laundry in the machine. Put in detergent and softener. Press the "On/Off" button (Figure 1-5).

Programme selection

Select the appropriate programme from the programme table according to type, amount and soiling degree of the laundry and washing temperatures.

Bring the Programme Selection Knob (Figure 1-4) to the programme mode that you wish to wash your laundry at. The recommended temperature and spin speed for the selected programme appear. Press "Start/Pause/Cancel"

button (Figure 1-8) to start the programme.

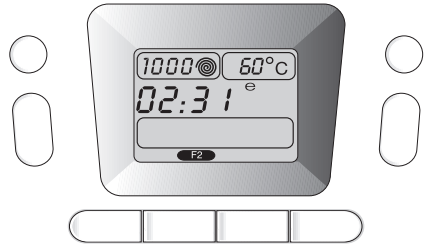

Main programmes

Depending on the type of textile, the following main programmes are available: Each of these main programmes comprise of a complete washing process, including washing, rinsing and, if required, spin cycles.

- i** Sort the laundry according to type of fabric, color, degree of soiling and permissible water temperature while choosing a programme.
- i** Always select the lowest required temperature. Higher temperature means higher power consumption.
- i** For further programme details, see "Programme Selection Table"

• Cottons

You can wash your durable clothes at this programme. Your laundry shall be washed with intense washing movements during a longer washing cycle. It is recommended for your cotton clothes (such as bed sheets, duvet and pillowcase sets, bathrobes, underclothing, etc.).

• Synthetics

You can wash your less durable clothes at this programme. Lighter washing movements and shorter washing cycle is used compared to "Cottons" programme. It is recommended for your synthetic clothes (such as shirts, blouses, synthetic/cotton blended garments, etc.). For curtains and veils, it is recommended to use "Synthetic 40°C" programme with prewash and anti-creasing functions selected. Detergent should not be put in the prewash compart-

ment. Less detergent should be put in the main wash compartment as the veil foams too much because of its meshed structure.

• **Woolens**

You can wash your machine-washable woollen garments at this programme. Wash by selecting the proper temperature according to the labels of your clothes. It is recommended to use appropriate detergents for woolens.

Additional programmes

For special cases, there are also extra programs available:

① Additional programs may differ according to the model of your machine.

• **Baby+Toddler Clothing**

Increased hygiene is provided by a longer heating period and an additional rinse cycle. It is recommended for baby clothes and clothes worn by allergic people.

• **Hand Wash**

You can wash your woollen/delicate clothes that bear “not machine-washable” labels for which hand wash is recommended at this programme. It washes the laundry with very tender washing movements without wearing your clothes out.

• **Daily Quick**

This programme is used to quickly wash a small number of lightly soiled cotton garments. E.g.: bathrobes, duvet covers, sport wears, daily clothes and etc. used only once.

• **A Class 40**

This programme washes for a longer period at 40°C and gives the same result as the “Cottons 60°C” programme, thus it saves energy. It is suitable for clothes for which you cannot use the “Cotton 60°C” programme.

• **Darkcare**

Use this programme to wash your dark coloured laundry, or the coloured laundry that you do not want them get faded. This programme washes your laundry with low mechanical movements and at low temperature. We recommend

you to use liquid detergent or woollen shampoo for dark coloured laundry.

• **Mixed Fabrics**

You can use this program to wash cottons and synthetics together without needing to sort them.

• **Duvet**

You can also wash your machine-washable fiber duvets with this program.

① You must not load more than 1 piece of fiber duvet for two persons.

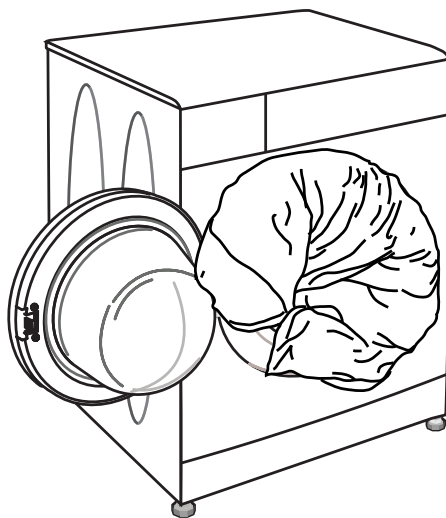

Economy symbol

Shows energy saving programs and temperature selections.

As “Intensive” and “Baby” programs are long programs with higher temperature selections to ensure hygiene, “Economy” Symbol (Figure 2-2g) will not light up.

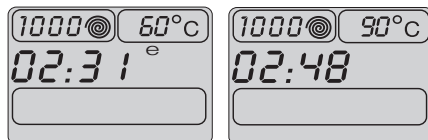

Special programs

For specific applications, you can select any of the following programs:

• **Rinse**

This programme is used when you want to rinse or starch separately.

• Spin+Drain

This program is used to apply an additional spin cycle for the laundry or to drain the water in the machine.

Before starting this program, select the desired spin speed and press “Start/Pause/Cancel” button. Your machine drains the water after spinning at the set spin speed.

If you only want to drain the water without spinning your laundry, select “Spin and drain” program, and then select no spin function with spin speed selection button. Press “Start/Pause/Cancel” button.

⚠ You should use a lower spin speed for delicate laundries.

Temperature selection

Whenever a new programme is selected, the temperature anticipated for that programme appears on the temperature indicator (2b).

To change the temperature, press the temperature button (Figure 1-3).



Temperature falls with 10° decrements. Cold selection is shown with “-” symbol. When the “Temperature” button is pressed after coming to the Cold selection, the maximum temperature of the programme you have selected will be displayed.

To decrease the temperature, press the “Temperature” button again.

90°C	Normally soiled, white cottons and linens. (Ex.: coffee table covers, tablecloths, towels, bed sheets)
------	--

60°C	Normally soiled, fade proof colored linens, cottons or synthetic clothes (Ex.: shirts, nightgowns, pajamas) and lightly soiled white linen clothes (Ex.: underwear)
40°C 30°C Cold	For delicate clothes (Ex.: veil curtains), blended clothes including synthetics and woolsens.

Spin Speed selection

Whenever a new programme is selected, the maximum spin speed of the selected programme is displayed on the spin speed indicator (Figure 2-2a).

To decrease the spin speed, press the “Spin” button (Figure 1-1). Spin speed decreases gradually. Then, rinse hold and no spin options are shown respectively.

Rinse hold is shown with “LJ” and no spin is shown with “--” symbols.

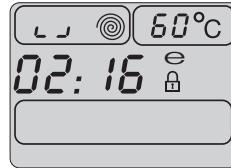

If you do not want to unload your clothes immediately after the programme, you may use the rinse hold function in order to prevent your clothes become wrinkled in an anhydrous condition. With this function, your laundry is kept in the final rinsing water. If you want to spin your laundry after the rinse hold function:

- Adjust the spin speed.
- Press Start/Pause/Cancel Button. Programme resumes. Your machines drains the water and spins your laundry.

You can use no spin function in order to drain the water without spinning at the end of the programme.

Programme selection and consumption table

EN						Auxiliary functions						
Programme	Temperature	Max. Load (kg)	Water Consumption (l)	Energy Consumption (kWh)	Spin speed (rpm)	Prewash	Quick Wash	Extra Rinse	Anti- Crease	Plus water	Rinse Hold	Selectable temperature range °C
Cottons	90	8	61	2.70	max.	•	•	•	•	•	•	90-Cold
Cottons	60**	8	59	1.36	max.	•	•	•	•	•	•	90-Cold
Cottons	40	8	72	0.75	max.	•	•	•	•	•	•	90-Cold
Duvet	40	-	60	0.60	800							60-40
Baby&Toddler Clothing	90	8	73	2.70	max.			*			•	90-30
A Class 40	40	8	60	1.20	max.						•	40
Synthetics	60	4	55	1.00	1000	•	•	•	•	•	•	60-Cold
Synthetics	40	4	55	0.52	1000	•	•	•	•	•	•	60-Cold
Mixed Fabrics	40	4	55	0.62	1000	•	•	•	•	•	•	40-Cold
Darkcare	40	4	95	0.60	800			*			•	40-Cold
Woolens	40	2	56	0.30	600			•		•	•	40-Cold
Hand Wash	30	1.5	40	0.25	600							30-Cold
Daily Quick	90	8	70	2.00	max. ***			•			•	90-Cold
Daily Quick	60	8	70	1.15	max. ***			•			•	90-Cold
Daily Quick	30	8	80	0.20	max. ***			•			•	90-Cold

• Selectable

* Automatically selected, not cancellable.

** Energy Label programme (EN 60456)

*** : Refers to 1400 rpm in machines with a highest spin speed above 1400 rpm.

Refers to the highest spin speed in machines with a highest spin speed below 1400 rpm.

Water and power consumption and programme duration may differ from the table shown, subject to changes in water pressure, water hardness and temperature, ambient temperature, type and amount of laundry, selection of auxiliary functions, and fluctuations in the supply voltage.

“A Class 40” programme may be selected instead of “Cotton 60” programme during winter in areas where the input water temperature is low and/or in areas with low supply voltage.

- ❗ The auxiliary functions in the table may differ according to the model of your machine.
- ❗ Programme duration will be displayed on the screen of your machine according to your selection.

Auxiliary functions

Auxiliary function selection keys

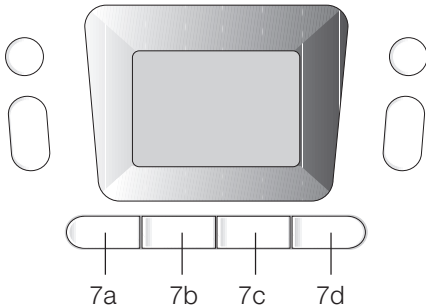

- Depending on the programme, you can select the desired auxiliary function by pressing the buttons.
- Select the required auxiliary functions before starting the programme.
- Some combinations cannot be selected together. (Ex.: Prewash and Quick Wash).
- Symbol of the selected auxiliary function (Figure 2-2l) will light up.

Auxiliary function selection

If an auxiliary function that should not be selected together with a previously selected function is chosen, the first selected function will be cancelled and the last auxiliary function selection will remain active.

(Ex.: If you want to select prewash first and then quick wash, prewash will be cancelled and quick wash will remain active).

Auxiliary function that is not compatible with the programme cannot be selected. (see, "Programme Selection Table")

• Prewash

When you select this function, the display will indicate "F1" symbol.

- A prewash is only required with heavily soiled laundry. Without prewash you save energy, water, detergent and time.
- Prewash without detergent is recommended for veils and curtains.

• Quick Wash

With this programme, the wash time is

shortened. "F2" symbol will light up on the display.

- Use this function for smaller amounts or slightly soiled laundries.

• Extra Rinse

This function allows your machine to perform an extra rinsing in addition to the rinsing cycles performed by your machine after main washing cycle.

Thus, the risk for sensitive skins (babies, allergic skins and etc.) to be effected by the minimal detergent remnants on the laundry is reduced. "F3" symbol will light up on the display.

• Anti-Crease

With this function, boiler movement will be lessened to prevent creasing and spinning speed is limited. In addition, washing is carried out at a higher water level. "F4" symbol will light up on the display.

- Use this function for delicate laundries that crease easily.
- ⓘ Whenever you select this auxiliary function, load your machine with half of the maximum laundry amount specified in the programme table.

Time screen

The display shows the time remaining for the programme to complete while a programme is running. Time is displayed in hours and minutes as "01:30".

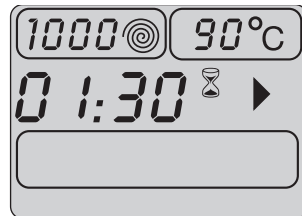

Time delay

With the "Time delay" function you can delay the programme start up to 24 hours. Setting can be made in intervals of 30 minutes.

1. Open the loading door, place the laundry inside and fill with detergent.
2. Set the washing programme, temperature, spin speed and,

if required, select the auxiliary functions.

3. Press "Time delaying" buttons "+" and "-" (Figure 1-6) to set your desired time delay. Time delaying symbol (Figure 2-2h) will flash.
4. Press "Start/Pause/Cancel" button (Figure 1-8). Then the time delay starts to count down. Time delaying symbol (Figure 2-2h) will light up. Start symbol (Figure 2-2j) will light up.

The ":" in the middle of the displayed time delay will start flashing.

- More laundry may be loaded or taken out during the time delay period. At the end of the time delay countdown process, time delaying symbol (Figure 2-2h) fades and the washing starts as the programme duration is displayed.

Changing the delay time

If you want to change the time during the countdown:

1. Press "Start/Pause/Cancel" button (Figure 1-8). ":" in the middle of the screen will stop flashing. Standby symbol (Figure 2-2k) will light up. Time delaying symbol (Figure 2-2h) will flash. Start Symbol (Figure 2-2j) will fade.
2. Press "Time delaying" buttons "+" and "-" (Figure 1-6) to set your desired time delay.
3. Press "Start/Pause/Cancel" button. Time delaying symbol (Figure 2-2h) will light up. Standby symbol (Figure 2-2k) will fade. Start symbol (Figure 2-2j) will light up.
4. The ":" in the middle of the displayed time delay will start flashing.

Cancelling the time delay

If you want to cancel the time delay countdown and start the programme immediately:

1. Press "Start/Pause/Cancel" button (Figure 1-8). The ":" in the middle of the displayed time delay will stop flashing.

2. Start symbol (Figure 2-2j) will fade. The standby symbol (Figure 2-2k) and the time delaying symbol (Figure 2-2h) will flash.
3. Press time delaying button "-" (Figure 1-6) to decrease the desired time delay. Programme duration after 30 minutes shall be displayed.
4. Press "Start/Pause/Cancel Button" to start the programme.

Starting the programme

1. Press "Start/Pause/Cancel" button (Figure 1-8) to start the programme.
2. The start symbol (Figure 2-2j) which indicates that the programme has started will light up.
3. The door locks and the door locked symbol (Figure 2-2i) will light up.
4. Symbol of the relevant step (prewash, main wash, rinse, softener and spin) that the programme has started from will light up (Figure 2-2f).

Progress of programme.

The progress of a running programme is shown through a number of symbols on the screen.

- At the beginning of each programme step, the relevant symbol in the series of symbols will light up and thus, at the end of the programme, all symbols will remain lit up. The symbol that is lit up at the far right of the series of symbols indicates the step that is being carried out.

Prewash

When "Prewash" auxiliary function is selected, prewash symbol will light up to indicate the beginning of prewash step.

Main wash

Main wash symbol will light up to indicate that the main wash cycle has started.

Rinse

Rinse symbol lights up at the beginning of the rinse step.

Softener

Softener symbol lights up at the beginning of softener step.

Spin

Spin symbol will light up at the beginning of the final spin, during “Spin” and “Pump” special programs.

- If the machine is not spinning, the programme may be in rinse hold mode or the automatic spin correction system has been activated because of the excessive unbalanced distribution of the laundry in the machine.

Changing the selections after the programme has started

The selected spin speed and programme temperature fade out. An empty frame appears.

When the “Programme selection” button is brought to the appropriate position, rpm and temperature data reappear.

Switching the machine to standby mode

Machine is switched to standby mode by pressing “Start/Pause/Cancel” button (Figure 1-8) for a short time. Standby symbol (Figure 2-2k) which indicates that the machine is in standby mode lights up and the start symbol (Figure 2-2j) that shows the programme has started and is still continuing fades out.



Selecting or cancelling an auxiliary function in standby mode

Auxiliary functions can be cancelled or selected in accordance with the step the programme is at.

Adding/taking out laundry in standby mode

The door can be opened if the water level is suitable. The door locked symbol (Figure 2-2i) will light up until the door is suitable for opening. This symbol will fade out as soon as the door is allowed to open. Laundry may be added / taken out by opening the door.

Door lock

Door Locked Symbol (Figure 2-2i) lights up when the loading door is locked. This symbol will flash until the door is allowed to open. Do not force the door at this stage. This symbol will fade out as soon as the door is allowed to open. You may open the door after the symbol fades out.

Child/key lock

You can protect the appliance from being tampered or by accidental operation by children of this lock. In this case, no change can be made in the running programme.

- ❑ Your machine can be turned on and off with On/Off button while the child-proof lock is activated. In this case, your machine will resume its programme with child-proof lock activated.

The machine is switched to child-lock by pressing the 2nd and 4th auxiliary functions for 3 sec. “C:on” (Child lock is activated) label appears on the screen.

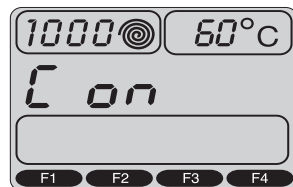

The same symbol will also be displayed on the screen whenever any button is pressed while the machine is child-locked.

To deactivate the child-proof lock, press the 2nd and 4th auxiliary function buttons for 3 sec.

“C:OFF” (Child lock is deactivated) label appears on the screen.

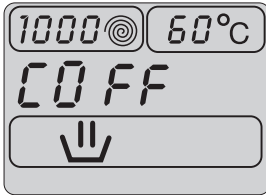

Ending the programme through cancelling

“Start/Pause/Cancel” button (Figure 1-8) is pressed for 3 seconds to cancel the programme. Start symbol (Figure 2-2j) will flash during cancellation. After cancellation, the symbol of the corresponding step at which the cancellation was made will remain lit and “End” label will appear on the screen.

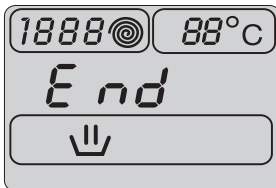

Programme in rinse hold mode

- This process is shown with the flashing Spin Symbol (Figure 2-2c) and the lit up Standby Symbol (Figure 2-2k).

If you wish to spin when the machine is in this mode:

Adjust the spin speed. Press “Start/Pause/Cancel” button (Figure 1-8).

The programme continues, pumps out the water and spins. Standby Symbol (Figure 2-2k) fades out and Start Symbol (Figure 2-2j) lights up.

If you want to discharge the water only without spinning:

Press “Start/Pause/Cancel” button

(Figure 1-8). Standby symbol (Figure 2-2k) will fade. Start symbol (Figure 2-2j) will light up. The programme continues and only pumps out the water.

End of programme

When the programme is finished, the symbols of the relevant steps will remain lit up and the auxiliary function, spin and temperature data selected at the start-up of the programme will remain selected. “End” label will appear on the screen.

6 Quick instructions for daily use

Preparation

1. Turn the tap on completely. Check that the hose is connected tightly.
2. Place the laundry in the machine.
3. Add detergent and softener.

Starting

1. Press the "On/Off" button.
2. Select the programme and the temperature.
3. If desired (according to your machine's model):
 - select any auxiliary function,
 - adjust the spin speed,
 - set the time delay,
4. Close the loading door.
5. Press "Start/Pause/Cancel" button.

The display shows the time remaining for the programme to complete if time delay is not set.

The display shows the time remaining for the programme to start if the time delay is set.

6. Check if the Door Locked Symbol lights up on the screen.

The Door Locked Symbol (Figure 3-2i) will light up if time delay is not set.

The Door Locked Symbol (Figure 3-2i) will fade if time delay is set.

Cancelling a programme

1. Press and hold the "Start/Pause/Cancel" button for about 3 seconds; the Start symbol will start flashing.
2. The machine can discharge all the water or can take in water for 3 times at most to cool down the clothes and complete discharging process.

Adding more laundry

- This is only possible under the following conditions:
 - during time delay,
- ❗ You may add or remove laundry during the time delay (until the

programme starts). At the beginning of a washing cycle (machine allows adding more laundry during a future step only if the water level is low enough to open the loading door or if the temperature in the machine is low).

In order to add laundry after the start-up of the programme:

1. Press "Start/Pause/Cancel" button.
2. Open the loading door and put in more laundry.
3. Close the loading door.
4. Press "Start/Pause/Cancel" button.

Programme is in rinse hold mode

❗ This process is shown with the flashing spin symbol and the standby symbol which is lit up.

If you wish to spin when the machine is in this mode:

1. Adjust the spin speed.
2. Press "Start/Pause/Cancel" button. The programme continues, pumps out the water and spins.
3. The standby symbol fades out and the start symbol lights up.

If you want to discharge the water without spinning:

1. Press "Start/Pause/Cancel" button.
2. The standby symbol fades out and the start symbol lights up.
3. The programme continues and only pumps out the water.

Re-spinning the laundry

The control system for an unbalanced load can pause the spinning in cases when the distribution of the laundry in the drum is not balanced.

If you want to re-spin the clothes:

1. Distribute the laundry in your machine for a balanced load.
2. Select the spin programme.
3. Adjust the spin speed.

After the programme is finished

Programme indicator symbols on the screen will remain lit after the programme is finished. "End" will appear on the screen.

1. Open the loading door and take out the laundry when the door locked symbol on the display fades out.
2. Press the "On/Off" button.
3. Turn the water tap off.
4. Remove any folds in the rubber seal on the loading door and check for debris.
5. Leave the loading door and detergent drawer open to dry.

7 Cleaning and care

Detergent drawer

Remove any powder residue buildup in the drawer. To do this;

1. Press the dotted point on the siphon in the softener compartment and pull towards you until the compartment is removed from the machine.

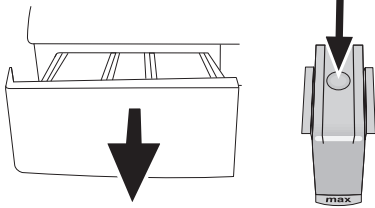

2. If more than a normal amount of water and softener mixture starts to gather in the softener compartment, the siphon must be cleaned.
3. Wash the dispenser drawer and the siphon with plenty of lukewarm water in a washbasin. Wear protective gloves or use an appropriate brush to avoid touching the residues in the drawer when cleaning.
4. Replace the drawer into its housing after cleaning. Check if the siphon is in its original location.

The door and the drum

After each wash:

- Check if there are any foreign substances in the drum.
- Open the hole in the bellow with the aid of a toothpick if it is clogged.

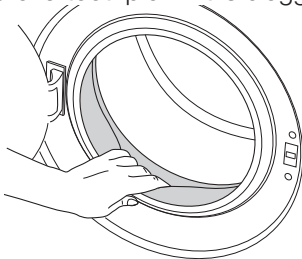

1. Foreign metal substances in your machine can cause rust stains. In such cases:
Clean the drum with a stainless steel cleaning agent. Never use steel wool or wire wool.

Outer cabinet and control panel

When necessary:

- Wipe the exterior panels of your machine with soapy water or mild detergent. Dry it with a soft cloth.
- Use only a soft and damp cloth to clean the control panel.
- 1. Never use a sponge or scrubbing material. These will damage the painted and plastic parts.

Inlet water filters

There is a filter at the end of each water intake valve at the back side of the machine and also at the end of each water intake hose where they are connected to the tap. These filters prevent the foreign substances and dirt in the water to enter into the machine. Filters should be cleaned as they get dirty.

- Close the taps.

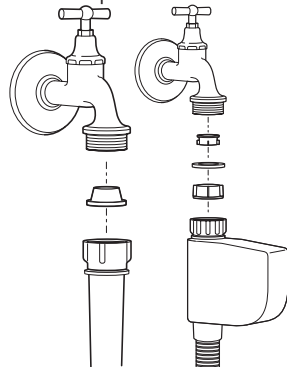

- Remove the nuts of the water intake hoses to clean the surfaces of the filters on the water intake valves with an appropriate brush.

- If the filters are very dirty, you can pull them out by means of pliers and clean them.
- Take out the filters on the flat ends of the water intake hoses together with the gaskets and clean thoroughly under streaming water.
- Replace the gaskets and filters carefully and tighten the hose nuts by hand.

Draining any remaining water and cleaning the pump filter

Filter system in your machine prevents solid items such as buttons, coins and fabric fibers clogging the pump propeller during discharging of the washing water.

- If your machine fails to drain the water, the pump filter may be clogged. You may have to clean it every 2 years or whenever it is blocked plugged. Water must be drained off to clean the pump filter.

In addition, water may have to be drained off completely in the following cases:

- before transporting the machine (e.g. when moving house)
- when there is the danger of frost

In order to clean the dirty filter and discharge the water;

1- Disconnect or unplug the machine from the power supply.

⚠ There may be water at 90°C in the machine. Therefore, the filter must be cleaned only after the inside water is cooled down to avoid hazard of scalding.

2- Open the filter cap. The filter cap is composed of one piece, hold it from both sides and open it by pulling out.

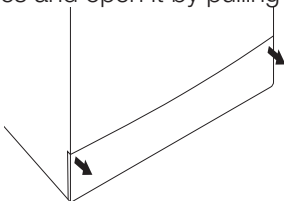

3- An emergency drain hose is supplied with some of our models. Others are not supplied with this item.

If your product is supplied with an emergency drain hose, do the following as shown in the figure below:

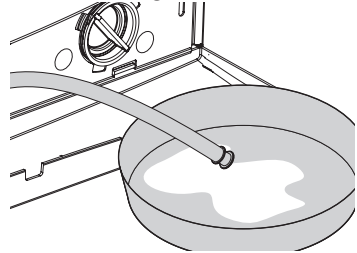

- Pull out the pump outlet hose from its housing.
- Place a large container at the end of the hose. Drain the water off into the container by pulling out the plug at the end of the hose. If the amount of water to be drained off is greater than the volume of the container, replace the plug, pour the water out, then resume the draining process.
- After draining process is completed, replace the plug into the end of the hose and fit the hose back into its place.

If your product is not supplied with an emergency drain hose, do the following as shown in the figure below:

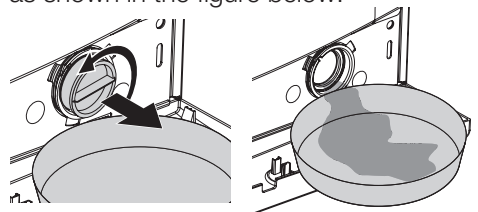

- Place a large container in front of the filter to receive water flowing from the filter.
- Loosen pump filter (anticlockwise) until water starts to flow out of it. Direct the flowing water into the container you have placed in front of the filter. You can use a piece of cloth to absorb any spilled water.

- When there is no water left, turn the pump filter until it is completely loose and remove it.
- Clean any residues inside the filter as well as fibers, if any, around the propeller region.
- If your product has a water jet feature, be sure to fit the filter into its housing in the pump. Never force the filter while replacing it into its housing. Fit the filter fully into its housing; otherwise, water may leak from the filter cap.

4- Close the filter cap of your product by fitting the tabs on the bottom into their positions and pushing the upper part of it.

8 Solution suggestions for problems

Cause	Explanation / Suggestion
Program cannot be started or selected.	
Machine may have switched to self protection mode due to an infrastructure problem (such as line voltage, water pressure, etc.).	Bring your machine to factory settings by turning the program selection knob. (see, Ending the program through canceling)
Water in the machine.	
There may be some water in your machine when you receive it. This is from the quality control process and is normal.	It is not harmful to your machine.
There is water coming from the bottom of the machine.	
There might be problems with hoses or the pump filter.	<ul style="list-style-type: none"> - Make sure that the seals of the water inlet hoses are securely fitted. - Tightly attach the drain hose to the tap. - Make sure that the pump filter is completely closed.
Machine does not fill with water	
<ul style="list-style-type: none"> - Tap may be turned off. - Water inlet hose might be bent. - Water inlet filter might be clogged. - The loading door may be ajar. 	<ul style="list-style-type: none"> - Open the inlet water taps fully. - Flatten the water intake hose. - Clean the water intake filter. - Close the loading door.
Machine does not discharge water.	
<ul style="list-style-type: none"> - Water outlet hose might be clogged or twisted. - Pump filter may be clogged. 	<ul style="list-style-type: none"> - Clean or flatten the hose. - Clean the pump filter.
Machine vibrates or shakes.	
<ul style="list-style-type: none"> - Machine feet might not be adjusted. - Transportation safety bolts might have not been removed. - There may be a small amount of laundry in the machine. - The machine may be overloaded or the clothes may be distributed unevenly. - There machine might be touching a solid surface. 	<ul style="list-style-type: none"> - Adjust the machine feet. - Remove the transportation safety bolts. - Add more laundry to the machine. - Reduce the amount of laundry in the machine or balance the load by hand. - Ensure that nothing touches the machine.
Machine stops shortly after the program starts.	
Machine can stop temporarily due to low voltage.	It will resume operating when the voltage is back to the normal level.
The water being taken in is directly discharged.	
Improper position of the drain hose.	Connect the water draining hose as described in the operation manual.
No water can be seen in the machine during washing.	
This is not a problem. The water level is not visible from the outside of the machine.	

The door is jammed.	
<ul style="list-style-type: none"> - Water level might be above the lower level of the door. - Machine might be heating up the water or it may be at the spinning cycle. - Due to an electrical mechanism, the door can only be opened a few minutes after the program has stopped. 	<ul style="list-style-type: none"> - Run either the "Pump" or "Spin" program. - Wait until the process is over. - Wait until the process is over.
Machine fills with water when a process is cancelled.	
Inside of machine may be hot.	For safety reasons, water should be cycled in and out a couple times.
It continuously spins. Remaining time does not count down. (On models with display)	
There may be an imbalance of laundry in the machine.	<ul style="list-style-type: none"> - The automatic spin correction system might have been activated due to the unbalanced distribution of the laundry in the drum. - The laundry in the drum may be clustered (bundled laundry in a bag). Laundry should be rearranged and re-spun. - No spinning is performed when the laundry is not evenly distributed in the drum to prevent any damage to the machine and to its environment.
Washing time takes longer than the time specified in the manual	
<ul style="list-style-type: none"> - Water pressure may be low. - Supply voltage may be low. - Input temperature of water may be low. - There may be an imbalance of laundry in the machine. - Number of rinses and/or amount of rinse water might have increased. 	<ul style="list-style-type: none"> - The machine will wait until there is sufficient amount of water, which will lengthen the washing time to avoid poor washing results due to insufficient water. - Washing time is extended to avoid poor washing results when the supply voltage is low. - Cycle time is extended to heat up the water when the input water is cold. Also, washing time can be lengthened to avoid poor washing results. - The automatic spin correction system might have been activated due to the unbalanced distribution of the laundry in the drum. - The laundry in the drum may be clustered (bundled laundry in a bag). - Laundry should be rearranged and re-spun. - No spinning is performed when the laundry is not evenly distributed in the drum to prevent any damage to the machine and to its environment. - Water amount is increased to obtain a better rinse and a rinse cycle is added when necessary.

It continuously washes. Remaining time does not count down.	
<p>In the case of a paused countdown while taking in water:</p> <ul style="list-style-type: none"> - Timer will not countdown until the machine is filled with the correct amount of water. (On models with display) - Time might have gotten stuck during heating step. (On models with display) <p>In the case of a paused countdown at the spinning step: There may be an imbalance of laundry in the machine. (On models with display)</p>	<ul style="list-style-type: none"> - The machine will wait until there is sufficient amount of water to avoid poor washing results due to lack of water. Then the timer will start to count down. - Time will not count down until the selected temperature for the program is attained. - The automatic spin correction system might have been activated due to the unbalanced distribution of the laundry in the drum. - The laundry in the drum may be clustered (bundled laundry in a bag). Laundry should be rearranged and re-spun. - No spinning is performed when the laundry is not evenly distributed in the drum to prevent any damage to the machine and to its environment.
It did not spin.	
<ul style="list-style-type: none"> - There may be an imbalance of laundry in the machine. Therefore, the program might have been completed without spinning. - The machine will not spin if the water has not completely drained. 	<ul style="list-style-type: none"> - The automatic spin correction system might have been activated due to the unbalanced distribution of the laundry in the drum. - The laundry in the drum may be clustered (bundled laundry in a bag). Laundry should be rearranged and re-spun. - No spinning is performed when the laundry is not evenly distributed in the drum to prevent any damage to the machine and to its environment. - Check the filter. - Check the drain hose.
Washing performance is poor: Laundry turns grey	
<ul style="list-style-type: none"> - Using insufficient amount of detergent for a long time, - Washing at low temperatures for a long time, - Using insufficient amount of detergent for hard waters (soil can stick to the laundry), - Using excessive amount of detergent (detergent can stick to the laundry). 	<ul style="list-style-type: none"> - Use the recommended amount of detergent appropriate for water hardness and the laundry. - Select the proper temperature for the laundry to be washed. - If the water hardness is high, using an insufficient amount of detergent can cause laundry to turn grey over time. - It is difficult to eliminate such greyness once it occurs.
Washing performance is poor: Stain could not be removed, not cleaned. Laundry could not be whitened.	
<ul style="list-style-type: none"> - Insufficient amount of detergent used. - Excessive laundry loaded into machine - Wrong program and temperature might have been selected. - Improper detergent may have been used. - Wrong type of detergent used. 	<ul style="list-style-type: none"> - Use recommended amount of detergent appropriate for the laundry. - Do not load the machine in excess. - Select the proper program and temperature for the laundry to be washed. - Put the detergent in the correct compartment. - Do not mix detergent with bleaching agents.

<ul style="list-style-type: none"> - Washing performance is poor: Oily stains appear on laundry. - Washing performance is poor: Bad odour 	
<ul style="list-style-type: none"> - Oily accumulations on the drum may have stuck to the laundry. - Oily accumulations on the drum may have stuck to the laundry. 	<ul style="list-style-type: none"> - Such odours and bacteria layers are formed on the drum as a result of continuous washing at lower temperatures and/or in short programs. - Leave the detergent dispenser drawer as well as the loading door of the machine ajar after each washing. Thus, a humid environment favorable for bacteria cannot be created inside the machine. - Machine must be operated empty either at 60°C or 90°C program with detergent every 6 months.
Colour of the clothes faded.	
<ul style="list-style-type: none"> - Excessive laundry loaded into machine. - Detergent may have gotten damp. - A higher temperature might have been selected. 	<ul style="list-style-type: none"> - Do not load the machine in excess - Store detergent in a closed and dry location. - Do not keep them under high temperatures. - Select the proper program and temperature according to the type and soiling degree of the laundry.
It does not rinse well.	
<ul style="list-style-type: none"> - The amount, brand and storage conditions of the detergent used might not be appropriate. - Detergent might have been put in the wrong compartment. - Machine filter may be clogged. - Drain hose may be folded. - Intermediate spins may be skipped. 	<ul style="list-style-type: none"> - Store detergent in a closed and dry location. Do not keep them under high temperatures. - If detergent is put in the prewash compartment although prewash cycle is not selected, machine can take this detergent during rinsing or softener step. - Check the filter. - Check the drain hose. - There may be an imbalance of laundry in the machine. - The laundry in the drum may be clustered (bundled laundry in a bag). Laundry should be rearranged and re-spun. - No spinning is performed when the laundry is not evenly distributed in the drum to prevent any damage to the machine and to its environment.
Clothes stiffened.	
<ul style="list-style-type: none"> - Insufficient amount of detergent used. - The detergent may have been placed into the wrong compartment; the detergent may be mixed with the softener. 	<ul style="list-style-type: none"> - If the water hardness is higher, using insufficient amount of detergent can cause the laundry to become stiff in time. Use appropriate amount of detergent according to the water hardness. - If detergent is put in the prewash compartment although prewash cycle is not selected, machine can take this detergent during rinsing or softener step. - Do not mix the softener with detergent when putting in the compartment. - Wash and clean the drawer with hot water.

Clothes do not smell like the softener.	
<ul style="list-style-type: none"> - Insufficient amount of detergent used. - The detergent was placed into the wrong compartment; the detergent was mixed with the softener. 	<ul style="list-style-type: none"> - If the water hardness is higher, using insufficient amount of detergent can cause the laundry to become stiff in time. Use appropriate amount of detergent according to the water hardness. - If detergent is put in the prewash compartment although prewash cycle is not selected, machine can take this detergent during rinsing or softener step. <p>Do not mix the softener with detergent when putting in the compartment. Wash and clean the drawer with hot water.</p>
Detergent residue in the dispensing drawer.	
<ul style="list-style-type: none"> - Detergent may have been put in wet dispenser drawer. - Detergent may have gotten damp. - Water pressure might be low - The detergent in the main wash compartment might have gotten wet while taking in the prewash water.. - Detergent might be mixed with the bleaching agent. 	<ul style="list-style-type: none"> - Dry the detergent drawer before putting in detergent. - Store detergent in a closed and dry location. - Do not keep them under high temperatures. - The detergent dispenser outlet (holes) may have a problem. - There might be problems with the detergent dispenser valves. - Do not mix the softener with detergent when putting in the compartment.
There is detergent left on the laundry.	
<ul style="list-style-type: none"> - Excessive laundry loaded into machine. - Wrong program and temperature might have been selected. - Wrong detergent may have been used. 	<ul style="list-style-type: none"> - Do not load the machine in excess. - Select the proper program and temperature for the laundry to be washed. - Use wool detergents for woolens.
There is too much foam	
<ul style="list-style-type: none"> - You may not be using proper detergent for automatic washing machines. - Excessive amount of detergent may have been used. - Too much detergent may have been used for a small amount of lightly soiled laundry. - Detergent may have been stored improperly. - Type of material being washed (lace items will cause excessive foam due to their meshed structure). - Detergent might have been put in the wrong compartment. - Softener being released early. 	<ul style="list-style-type: none"> - Use only automatic washing machine detergents in your washing machine. - Use only sufficient amount of detergent. - Use only sufficient amount of detergent. - Store detergent in a closed and dry location. - Do not store in excessively hot places. - Use smaller amounts of detergent for lace items. - If you put detergent in the prewash compartment although you have not selected a prewash cycle, the machine can take this detergent during rinsing or softener step. - Too much softener was put in. <p>The detergent dispenser is problematic. Water is siphoned (pulling the softener into the washer early) during the fill or rinse cycles. Valves are problematic.</p>

Machine does work. Nothing is displayed on the screen.	
The plug might not be plugged in the mains outlet. Fuse may have blown. Electricity may be cut off. The "On/Off" button might have not been pressed.	Check the plug. Check the fuse. Check the supply power. Press this button.
The machine did not start after the program was selected and the «Start/Pause/Cancel» button was pressed.	
The front door may be ajar.	
The Rinse Symbol amongst the Program Indicator Symbols is flashing. (Subject to the model of your machine, water cut-off symbol may light up too)	
Water may have been cut off.	You can restart your machine by pressing the «Start/Pause/Cancel» button for a short time after ensuring that the water is not cut off.

9 Guarantee

Your new Beko product is guaranteed against the cost of breakdown repairs for twelve months from the date of the original purchase.

What is covered?

- Repairs necessary as a result of faulty materials, defective components or manufacturing defect.
- The cost of functional replacement parts, but excluding consumable items.
- The labour costs of a Beko approved repairer to carry out the repair.

What is not covered?

- Transit, delivery or accidental damage or misuse and abuse.
- Cabinet or appearance parts, including knobs, flaps, handles or container lids.
- Accessories or consumable items including but not limited to, ice trays, scrapers, cutlery baskets, filters and light bulbs.
- Repairs required as a result of unauthorised repair or inexperienced installation that fails to meet the requirements contained in the user instruction book.
- Repairs to products used on commercial or non-residential household premises.
- Loss of frozen food in freezers or fridge/freezers. (Food loss insurance is often included within your household contents insurance policy, or may be available separately from your retailer).

Important notes.

- Your Beko product is designed and built for domestic household use only.
- The guarantee will be void if the product is installed or used in commercial or non-residential

domestic household premises.

- The product must be correctly installed, located and operated in accordance with the instructions contained in the User Instructions Booklet provided.
- Professional installation by a qualified Electrical Domestic Appliance Installer is recommended for all Washing Machines, Dishwashers and Electric Cookers
- Gas Cookers must only be installed by a CORGI (or BORD GAIS) registered Gas Installer.
- The guarantee is given only within the boundaries of the United Kingdom and the Republic of Ireland.
- The guarantee is applicable only to new products and is not transferable if the product is resold.
- Beko disclaims any liability for incidental or consequential damages.
- The guarantee does not in anyway diminish your statutory or legal rights.

Should you experience any difficulty in obtaining service please contact the Beko Customer Help-Line.
Tel: 0845 600 4911
e-mail: service@beko.co.uk

10 Service

Please keep your purchase receipt or other proof of purchase in a safe place; you will need to have it should the product require attention under guarantee.

You should also complete the details below; it will help us assist you when requesting service. (The model number is printed on the Instruction Booklet and the serial number is printed on the Rating Label affixed to the appliance)

Model No:
Serial No:
Retailer:
Date of purchase:

For service under guarantee simply telephone the appropriate number below

UK Mainland & Northern Ireland

Fridges & Freezers	0845 600 4903
Electric Cookers	0845 600 4902
Gas & Dual Fuel Cookers	0845 600 4905

Washing Machines & Dishwashers	0845 600 4906
-----------------------------------	---------------

Republic of Ireland

All Refrigeration, All Cookers Washing Machines & Dishwashers	01 862 3411
---	-------------

Before requesting service please check the trouble-shooting guide in the Operating Instructions as a charge may be levied where no fault is found even though your product may still be under guarantee.

Service once the manufacturers guarantee has expired.

If you have purchased an extended guarantee please refer to the instructions contained within the extended guarantee

agreement document. Otherwise please call the appropriate number above where service can be obtained at a charge.

Should you experience any difficulty in obtaining service please contact the Beko Customer Help-Line.
Tel: 0845 600 4911
e-mail:service@beko.co.uk

BEKO



**Beko plc Beko House, Caxton Way, Watford
Hertfordshire, WD18 8UF**

Tel: 0845 6004911

Fax: 0845 6004922

Email: service@beko.co.uk

www.beko.co.uk

Download from www.Somanuals.com. All Manuals Search And Download.

Free Manuals Download Website

<http://myh66.com>

<http://usermanuals.us>

<http://www.somanuals.com>

<http://www.4manuals.cc>

<http://www.manual-lib.com>

<http://www.404manual.com>

<http://www.luxmanual.com>

<http://aubethermostatmanual.com>

Golf course search by state

<http://golfingnear.com>

Email search by domain

<http://emailbydomain.com>

Auto manuals search

<http://auto.somanuals.com>

TV manuals search

<http://tv.somanuals.com>