

# Spool Gun & Push-Pull Gun Conversion Kits

## Mig Welding Accessory

Issued Mar. 2008 • Index No. SPEC SGA-1.1

### The Right Tool For The Job.

To improve comfort and minimize downtime, these conversion kits enable the use of long lasting Centerfire Consumables and a wide variety of interchangeable necks for greater flexibility and better weld puddle visibility.

SGA-1 Conversion Kit



SGA conversion kits allow the use of innovative Bernard front-end parts for improved performance and productivity.

**Centerfire™ contact tips, nozzles and diffusers are easy-to-use and high performing** - they provide better arc starts, less spatter and more consistent welds - and also last up to three times longer than competitive brands.

**Centerfire™ consumables fit most competitive brand guns** to enhance performance and allow standardization of one contact tip and nozzle for all gun brands to minimize inventory management costs.

**Necks available in fixed, rotatable, flexible and multiple length options** for optimal weld accessibility and improved operator comfort. Rotatable necks changeover without tools.

**Patented large tapered Stay-Tite™ neck connection improves conductivity** for better weld quality, lessens heat to increase operator comfort.

**Patented Jump Liner** allows quick neck change and replacement of only most commonly worn or clogged liner area, which reduces the amount of time a gun is offline and minimizes inventory.

Made with  
Pride and without  
Compromise in the **USA**

### Bernard®

An Illinois Tool Works Company  
449 West Corning Road, Box 667  
Beecher, Illinois 60401 USA

Phone: 800-946-2281 (US Only) 708-946-2281 (Outside US)  
Fax: 708-946-6726  
For more information, visit us at [BernardWelds.com](http://BernardWelds.com)



# Available Parts

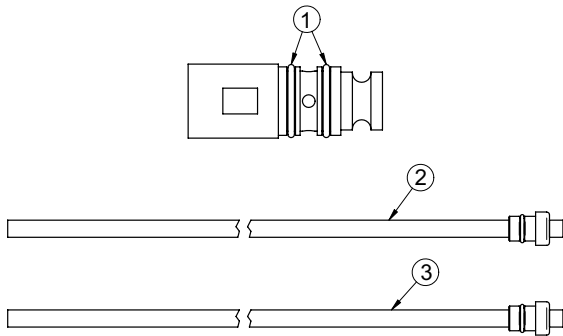

**SGA-1**  
Fits Miller® Spoolmatic 15A,  
Spoolmatic 30A and XR-A

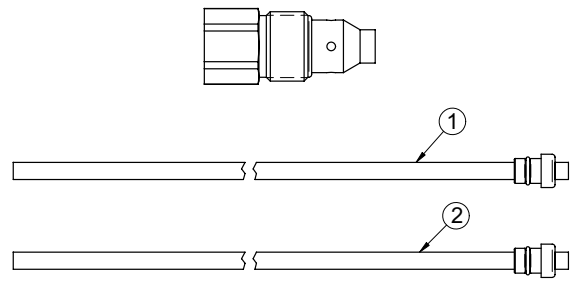

**SGA-2**  
Fits Profax® AEC 200

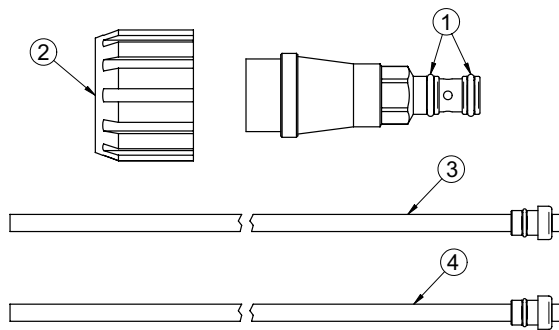

**SGA-3**  
Fits Miller® XR-Aluma-Pro

SGA-1		
ITEM #	PART #	DESCRIPTION
1	4929	O-Ring
2	1910042	.035" - 3/64" (.9 mm - 1.2 mm) Aluminum Jump Liner, SGA Kit
3	1910043	3/64" - 1/16" (1.2 mm - 1.6 mm) Aluminum Jump Liner, SGA Kit
SGA-2		
ITEM #	PART #	DESCRIPTION
1	1910042	.035" - 3/64" (.9 mm - 1.2 mm) Aluminum Jump Liner, SGA Kit
2	1910043	3/64" - 1/16" (1.2 mm - 1.6 mm) Aluminum Jump Liner, SGA Kit
SGA-3		
ITEM #	PART #	DESCRIPTION
1	2040019	O-Ring
2	2030031	Retaining Nut, XR-Aluma-Pro
3	1910042	.035" - 3/64" (.9 mm - 1.2 mm) Aluminum Jump Liner, SGA Kit
4	1910043	3/64" - 1/16" (1.2 mm - 1.6 mm) Aluminum Jump Liner, SGA Kit

SGA-1, SGA-2 and SGA-3 conversion kits are manufactured by Bernard®. Bernard® is the registered trademark of Illinois Tool Works, Inc. Other brands mentioned are for reference only and are the registered trade marks of their respective companies. Illinois Tool Works, Inc. is not affiliated with these other companies.

# Installation Instructions

1. Remove existing barrel assembly per gun manufacturers directions
2. Install plastic liner from kit into neck/adapter assembly as shown below.
- 2a. (Optional) Trim plastic liner flush with end of adapter to use standard Bernard Jump Liner in neck. See Jump Liner spec sheet for additional options.
3. Connect Bernard neck to brass adapter. See back page for available neck options.
4. Install neck/adapter assembly into gun. Secure per gun manufacturers directions.
5. Trim liner beyond neck threads as appropriate for gas diffuser used (3/4" for Centerfire).
6. Attach Bernard Centerfire consumables to neck. See Centerfire spec sheet for available options.

All SGA Kits

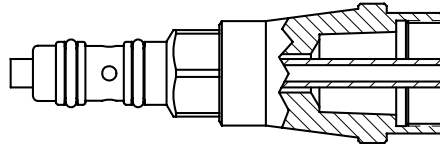

When using optional Jump Liner in neck, trim the plastic liner from SGA kit flush with the front edge of the brass adapter as shown.

SGA-2 Kit Only

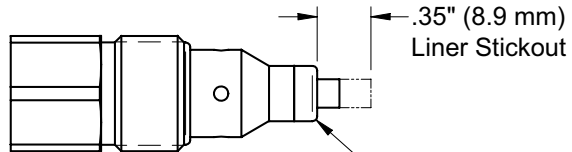

Adjust liner stickout dimension by threading brass liner lock deeper onto plastic material. Turn clockwise for approximately 8 turns.

# Available Necks

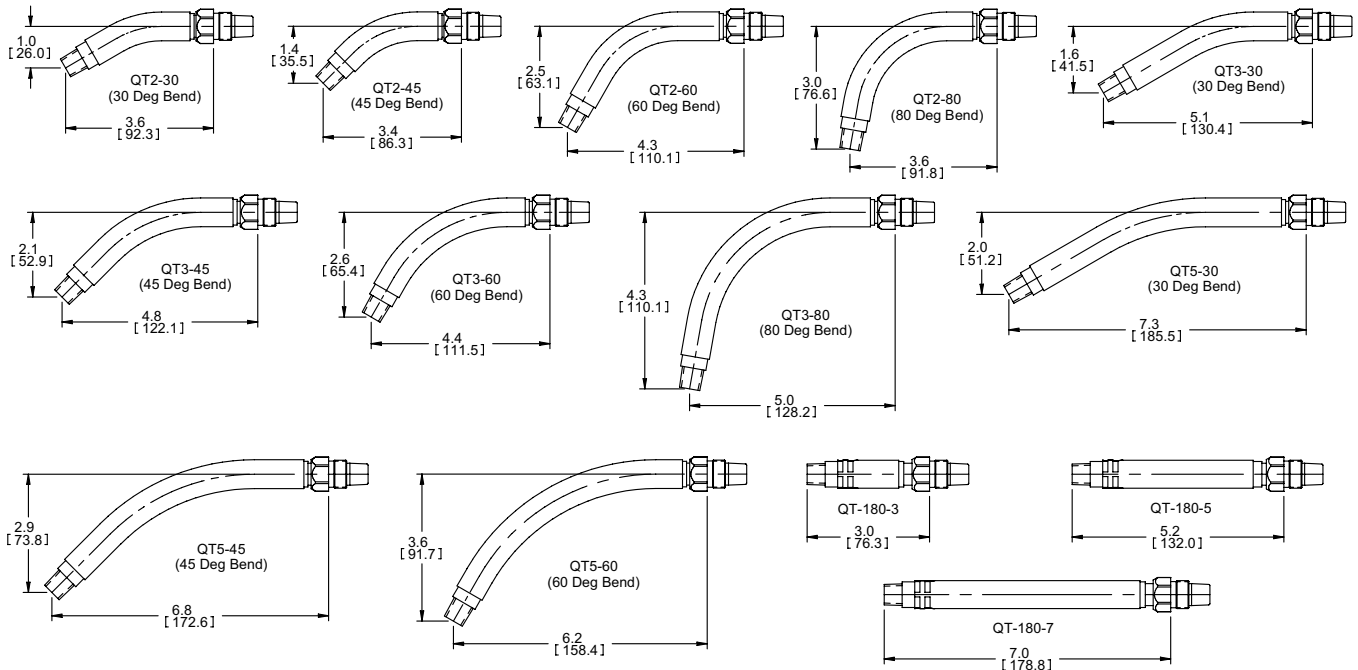

Notes: Dimensions in brackets are in millimeters. Diffuser thread size: 1/4-18 NPT "Bernard Special".

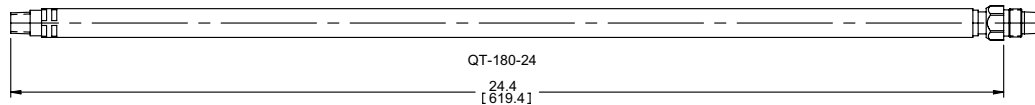
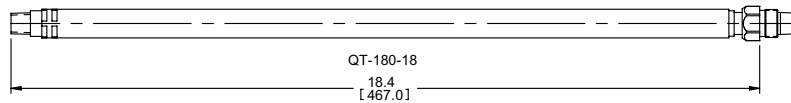
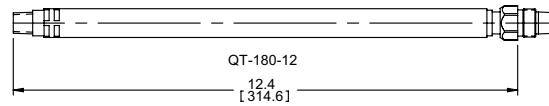

All body tubes (except the QT-F-6 and QT-F-8) include the components required to make the body tube fixed (wrench-tight) or rotatable (hand-tight).  
 Patent Pending

- 1840057
- 1840031
- 4780

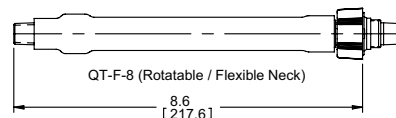
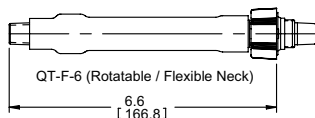
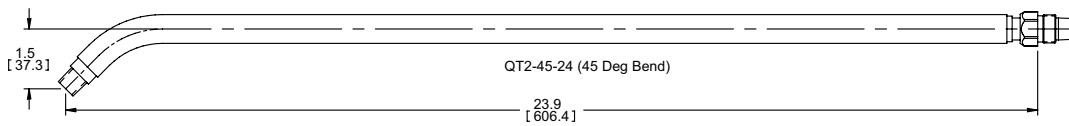
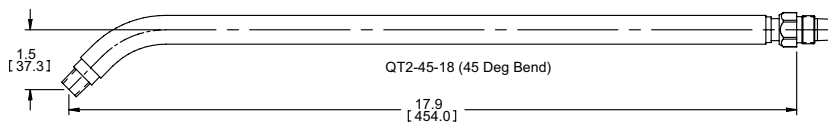
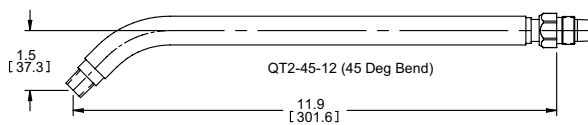

## Free Manuals Download Website

<http://myh66.com>

<http://usermanuals.us>

<http://www.somanuals.com>

<http://www.4manuals.cc>

<http://www.manual-lib.com>

<http://www.404manual.com>

<http://www.luxmanual.com>

<http://aubethermostatmanual.com>

Golf course search by state

<http://golfingnear.com>

Email search by domain

<http://emailbydomain.com>

Auto manuals search

<http://auto.somanuals.com>

TV manuals search

<http://tv.somanuals.com>