

Server Access Modules (SAMs)

Connect one or two servers or peripherals to a ServSwitch CX, ServSwitch CX Uno, or ServSwitch CX with IP.

Work with USB, PS/2 with audio, USB with audio, Sun with audio, dual USB, dual USB and audio, RS-232, DisplayPort, and mini DisplayPort interfaces.



Customer Support Information

Order toll-free in the U.S.: Call 877-877-BBOX (outside U.S. call 724-746-5500)
FREE technical support 24 hours a day, 7 days a week: Call 724-746-5500 or fax 724-746-0746
Mailing address: Black Box Corporation, 1000 Park Drive, Lawrence, PA 15055-1018
Web site: www.blackbox.com • E-mail: info@blackbox.com

Trademarks Used in this Manual

Trademarks Used in this Manual

Black Box and the Double Diamond logo are registered trademarks, and ServSwitch is a trademark, of BB Technologies, Inc.

Mac is a registered trademark of Apple, Inc.

Linux is a registered trademark of Linus Torvalds.

Windows is a registered trademark of Microsoft Corporation.

Sun is a registered trademark of Sun Microsystems, Inc.

Unix is a registered trademark of X/Open Company.

Any other trademarks mentioned in this manual are acknowledged to be the property of the trademark owners.

We're here to help! If you have any questions about your application or our products, contact Black Box Tech Support at **724-746-5500** or go to **blackbox.com** and click on "Talk to Black Box." You'll be live with one of our technical experts in less than 30 seconds.

Federal Communications Commission and Industry Canada Radio Frequency Interference Statements

This equipment generates, uses, and can radiate radio-frequency energy, and if not installed and used properly, that is, in strict accordance with the manufacturer's instructions, may cause interference to radio communication. It has been tested and found to comply with the limits for a Class A computing device in accordance with the specifications in Subpart B of Part 15 of FCC rules, which are designed to provide reasonable protection against such interference when the equipment is operated in a commercial environment. Operation of this equipment in a residential area is likely to cause interference, in which case the user at his own expense will be required to take whatever measures may be necessary to correct the interference.

Changes or modifications not expressly approved by the party responsible for compliance could void the user's authority to operate the equipment.

This digital apparatus does not exceed the Class A limits for radio noise emission from digital apparatus set out in the Radio Interference Regulation of Industry Canada.

Le présent appareil numérique n'émet pas de bruits radioélectriques dépassant les limites applicables aux appareils numériques de la classe A prescrites dans le Règlement sur le brouillage radioélectrique publié par Industrie Canada.

Instrucciones de Seguridad (Normas Oficiales Mexicanas Electrical Safety Statement)

1. Todas las instrucciones de seguridad y operación deberán ser leídas antes de que el aparato eléctrico sea operado.
2. Las instrucciones de seguridad y operación deberán ser guardadas para referencia futura.
3. Todas las advertencias en el aparato eléctrico y en sus instrucciones de operación deben ser respetadas.
4. Todas las instrucciones de operación y uso deben ser seguidas.
5. El aparato eléctrico no deberá ser usado cerca del agua—por ejemplo, cerca de la tina de baño, lavabo, sótano mojado o cerca de una alberca, etc.
6. El aparato eléctrico debe ser usado únicamente con carritos o pedestales que sean recomendados por el fabricante.
7. El aparato eléctrico debe ser montado a la pared o al techo sólo como sea recomendado por el fabricante.
8. Servicio—El usuario no debe intentar dar servicio al equipo eléctrico más allá a lo descrito en las instrucciones de operación. Todo otro servicio deberá ser referido a personal de servicio calificado.
9. El aparato eléctrico debe ser situado de tal manera que su posición no interfiera su uso. La colocación del aparato eléctrico sobre una cama, sofá, alfombra o superficie similar puede bloquea la ventilación, no se debe colocar en libreros o gabinetes que impidan el flujo de aire por los orificios de ventilación.
10. El equipo eléctrico debe ser situado fuera del alcance de fuentes de calor como radiadores, registros de calor, estufas u otros aparatos (incluyendo amplificadores) que producen calor.
11. El aparato eléctrico deberá ser conectado a una fuente de poder sólo del tipo descrito en el instructivo de operación, o como se indique en el aparato.
12. Precaución debe ser tomada de tal manera que la tierra física y la polarización del equipo no sea eliminada.
13. Los cables de la fuente de poder deben ser guiados de tal manera que no sean pisados ni pellizcados por objetos colocados sobre o contra ellos, poniendo particular atención a los contactos y receptáculos donde salen del aparato.
14. El equipo eléctrico debe ser limpiado únicamente de acuerdo a las recomendaciones del fabricante.
15. En caso de existir, una antena externa deberá ser localizada lejos de las líneas de energía.
16. El cable de corriente deberá ser desconectado del cuando el equipo no sea usado por un largo periodo de tiempo.
17. Cuidado debe ser tomado de tal manera que objetos líquidos no sean derramados sobre la cubierta u orificios de ventilación.
18. Servicio por personal calificado deberá ser provisto cuando:
 - A: El cable de poder o el contacto ha sido dañado; u
 - B: Objetos han caído o líquido ha sido derramado dentro del aparato; o
 - C: El aparato ha sido expuesto a la lluvia; o
 - D: El aparato parece no operar normalmente o muestra un cambio en su desempeño; o
 - E: El aparato ha sido tirado o su cubierta ha sido dañada.

Table of Contents

1. Specifications 6

2. Overview 7

 2.1 Introduction..... 7

 2.2 Available Models 7

 2.3 What’s Included 8

 2.4 Hardware Description..... 8

 2.4.1 KV1400A..... 8

 2.4.2 KV1401A 9

 2.4.3 KV1402A..... 9

 2.4.4 KV1403A..... 10

 2.4.5 KV1404A..... 11

 2.4.6 KV1405A..... 12

 2.4.7 KV1406A..... 13

 2.4.8 KV1407A 14

 2.4.9 KV1408A..... 15

 2.4.10 KV1409A..... 16

3. Installation 17

 3.1 Installation Steps..... 17

 3.2 Typical Applications 17

 3.2.1 KV0081A or KV0161A..... 17

 3.2.2 KV0424A-R2 17

 3.2.3 KV1416A-R2..... 18

4. Troubleshooting..... 19

 4.1 Contacting Black Box..... 19

 4.2 Shipping and Packaging 19

Chapter 1: Specifications

1. Specifications

Operating System — Linux®, Unix®, Mac®, Sun®, Windows® 32/64 bit

Interface — KV1400A: PS/2,
KV1401A: USB,
KV1402A: PS/2 with audio,
KV1403A: USB with audio,
KV1404A: Sun with audio,
KV1405A: dual USB,
KV1406A: dual USB and audio,
KV1407A: quad IP RS-232;
KV1408A: DisplayPort, USB and audio;
KV1409A: Mini DisplayPort, USB, and audio

Distance (Maximum) —

Between SAM and ServSwitch CX or CX Uno:

KV1400A–KV1404A: 164 ft. (50 m) with ServSwitch CX 4-User, 32 ft. (10 m) with ServSwitch CX Uno;

KV1405A, KV1406A: 32 ft. (9.8 m) over CATx cable, resolutions are higher at shorter distances;

KV1407A: 32 ft. (9.8 m) over CATx cable;

KV1408A–KV1409A: 164 ft. (50 m) with ServSwitch CX 4-User, 32 ft. (10 m) with ServSwitch CX Uno and CX Uno with IP;

Between SAM and User Station: All: 328 ft. (100 m), 1920 x 1200 @ 60 Hz;

656 ft. (200 m), 1600 x 1200 @ 60 Hz;

984 ft. (300 m), 1280 x 1024 @ 60 Hz

Resolutions — 1920 x 1200 @ 60 Hz (328 ft. [100 m]), 1600 x 1200 @ 60 Hz (656 ft. [200 m]), 1280 x 1024 @ 60 Hz (984 ft. [300 m])

Connectors — KV1400A: (1) RJ-45, (2) 6-pin mini DIN, (1) HD15 M;

KV1401A: (1) RJ-45, (1) USB Type A M, (1) HD15 M;

KV1402A: (1) RJ-45, (2) 6-pin mini DIN, (1) HD15 M, (1) 3.5-mm plug;

KV1403A: (1) RJ-45, (1) USB Type A M, (1) HD15 M, (1) 3.5-mm plug;

KV1404A: (1) RJ-45, (1) 8-pin mini DIN, (1) HD15 M, (1) 3.5-mm plug;

KV1405A: (2) RJ-45 F, (1) USB Type A M, (1) HD15 M;

KV1406A: (2) RJ-45 F, (1) USB Type A M for keyboard and mouse, (1) HD15 M, (2) 3.5-mm plug;

KV1407A: (1) RJ-45, (1) DB9 F;

KV1408A: (1) DisplayPort M, (1) USB Type A M; (1) 3.5-mm plug;

KV1409A: (1) Mini DisplayPort M, (1) USB Type A M, (1) 3.5-mm plug

Indicators — All: (1) Power LED on RJ-45 connector

Power — KV1401A, KV1403A, KV1405A, KV1406A, KV1408A–KV1409A: Input: USB; 500 mA @ 5 VDC;

KV1400A, KV1402A: Input: PS/2: 500 mA @ 5 VDC;

KV1404A: Input: Sun: 500 mA @ 5 VDC;

KV1407A: Input: DB9 interface-powered

Size — KV1400A–KV1404A: 1.1"H x 1.75"W x 3.25"D (2.8 x 4.5 x 8.3 cm);

KV1405A–KV1407A: 1.1"H x 1.9"W x 3.25"D (2.8 x 4.8 x 8.3 cm);

KV1408A–KV1409A: 3.25"H x 1.1"W x 1.9"D (8.9 x 2.8 x 4.8 cm)

2. Overview

2.1 Introduction

The Server Access Modules (SAMs) (part numbers KV1400A–KV1409A) connect servers to the ServSwitch CX, ServSwitch CX Uno, or ServSwitch CX with IP. Modules (part numbers KV1400A–KV1406A and KV1408A–KV1409A) are compatible with the ServSwitch CX and ServSwitch CX Uno. Modules KV1408A–KV1409A also work with the ServSwitch CX with IP. KV1407A module only works with the Quad IP CX Switch (KV4161A).

2.2 Available Models

Table 2-1. Available SAMs.

Product Code	Module Name	Application
KV1400A	ServSwitch CX Server Access Module, PS/2	Connects PS/2 servers to the ServSwitch CX, ServSwitch CX Uno, or ServSwitch CX with IP.
KV1401A	ServSwitch CX Server Access Module, USB	Connects USB servers to the ServSwitch CX, ServSwitch CX Uno, or ServSwitch CX with IP.
KV1402A	ServSwitch CX Server Access Module, PS/2 with audio	Connects PS/2 servers with audio to the ServSwitch CX, ServSwitch CX Uno, or ServSwitch CX with IP.
KV1403A	ServSwitch CX Server Access Module, USB with audio	Connects USB servers with audio to the ServSwitch CX, ServSwitch CX Uno, or ServSwitch CX with IP.
KV1404A	ServSwitch CX Server Access Module, Sun with audio	Connects Sun servers with audio to the ServSwitch CX, ServSwitch CX Uno, or ServSwitch CX with IP.
KV1405A	ServSwitch CX Dual CATx Server Access Module, USB	Dual-access SAM enables you to share a single computer between two switches for redundancy.
KV1406A	ServSwitch CX Dual CATx Server Access Module, USB and audio	Dual-access SAM enables you to share a single computer between two switches for redundancy.
KV1407A	ServSwitch CX Quad IP CATx Server Access Module, Serial	Use this SAM to gain RS-232 connectivity to target machines. This model supports ServSwitch Quad IP CX (KV4161A) only.
KV1408A	ServSwitch CX Server Access Module, DisplayPort, USB, and audio	Connect the ServSwitch CX to DisplayPort targets with USB using this SAM.
KV1409A	ServSwitch CX Server Access Module, Mini DisplayPort, USB, and audio	Connect the ServSwitch CX to Mini DisplayPort targets with USB using this SAM.

2.3 What's Included

Your package should contain the following items. If anything is missing or damaged, contact Black Box Technical Support at 724-746-5500 or info@blackbox.com.

- Server Access Module

2.4 Hardware Description

Figures 2-1 through 2-10 show the server access modules. Tables 2-2 through 2-10 describe their connectors.

2.4.1 ServSwitch CX Server Access Module, PS/2 (KV1400A)

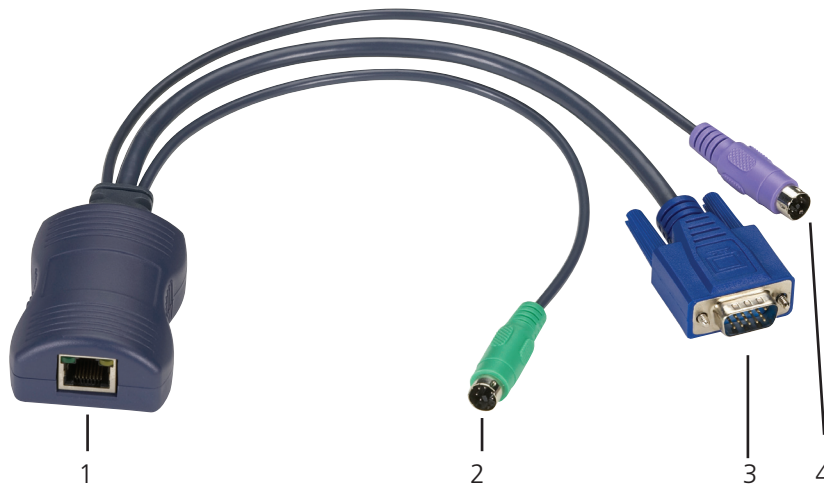

Figure 2-1. KV1400A.

Table 2-2. KV1400A connectors.

Callout Number in Figure 2-1	Connector	Description
1	(1) RJ-45	Connects to ServSwitch CX and CX Uno.
2	(1) 6-pin mini DIN	Connects to keyboard or mouse port on target computer.
3	(1) HD15 M	Connects to video out port on target computer.
4	(1) 6-pin mini DIN	Connects to keyboard or mouse port on target computer.

2.4.2 ServSwitch CX Server Access Module, USB (KV1401A)

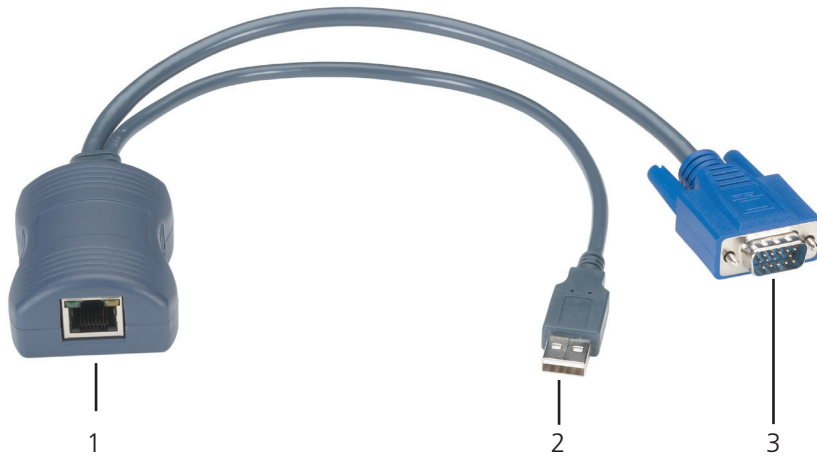

Figure 2-2. KV1401A.

Table 2-3. KV1401A connectors.

Callout Number in Figure 2-2	Connector	Description
1	(1) RJ-45	Connects to ServSwitch CX and CX Uno.
2	(1) USB Type A M	Connects to USB port on target computer.
3	(1) HD15 M	Connects to video out port on target computer.

2.4.3 ServSwitch CX Server Access Module, PS/2 with Audio (KV1402A)

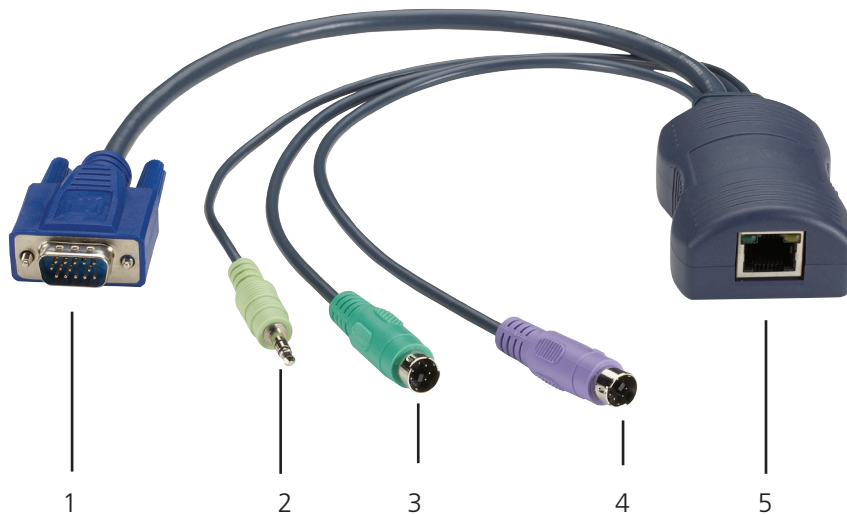

Figure 2-3. KV1402A.

Table 2-4. KV1402A connectors.

Callout Number in Figure 2-3	Connector	Description
1	(1) HD15	Connects to video out on the target computer.
2	(1) 3.5-mm plug	Connects to target computer's audio out.
3	(1) 6-pin mini DIN	Connects to target computer's keyboard/mouse PS/2 port.
4	(1) 6-pin mini DIN	Connects to target computer's keyboard/mouse PS/2 port.
5	(1) RJ-45	Connects to ServSwitch CX and CX Uno.

2.4.4 ServSwitch CX Server Access Module, USB with Audio (KV1403A)

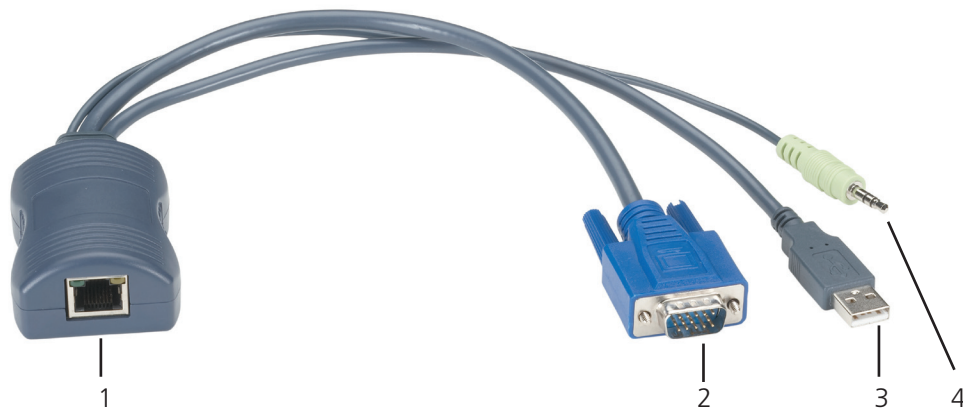

Figure 2-4. KV1403A.

Table 2-5. KV1403A connectors.

Callout Number in Figure 2-4	Connector	Description
1	(1) RJ-45	Connects to ServSwitch CX and CX Uno.
2	(1) HD15 M	Connects to video out on the target computer.
3	(1) USB Type A	Connects to target computer's USB port.
4	(1) 3.5-mm plug	Connects to target computer's audio out port.

2.4.5 ServSwitch CX Server Access Module, Sun with Audio (KV1404A)

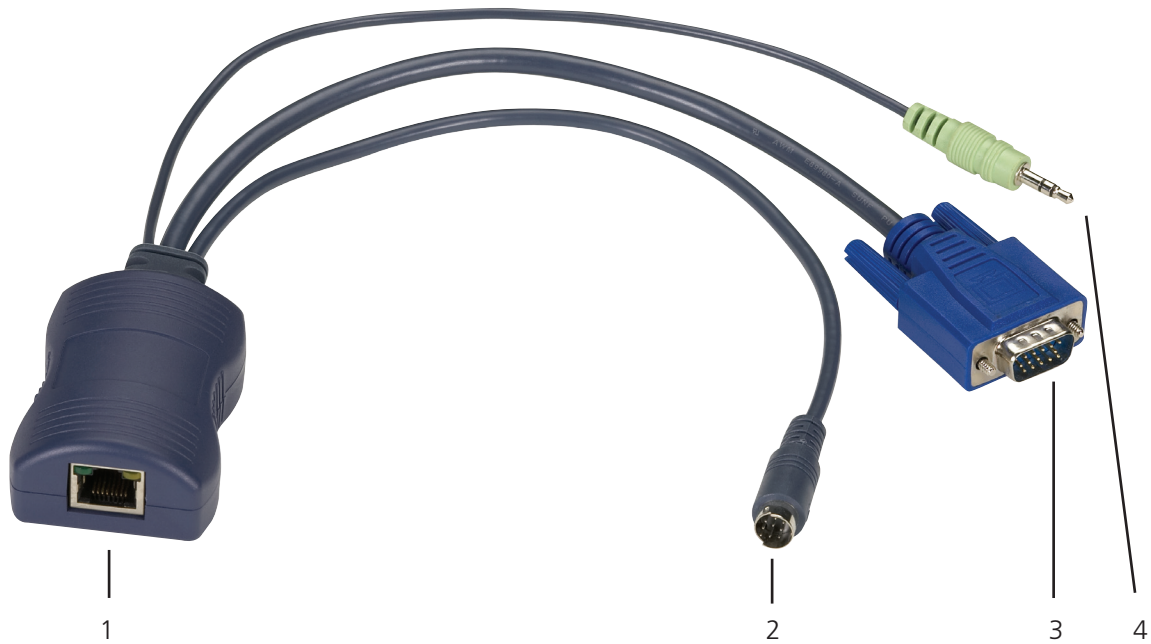

Figure 2-5. KV1404A.

Table 2-6. KV1404A connectors.

Callout Number in Figure 2-5	Connector	Description
1	(1) RJ-45	Connects to ServSwitch CX and CX Uno.
2	(1) 8-pin mini DIN	Connects to target computer's keyboard/mouse port.
3	(1) HD15 M	Connects to target computer's video out port.
4	(1) 3.5-mm plug	Connects to target computer's audio out port.

2.4.6 ServSwitch CX Dual CATx Server Access Module, USB (KV1405A)



Figure 2-6. KV1405A.

Table 2-7. KV1405A connectors.

Callout Number in Figure 2-6	Connector	Description
1	(1) HD15 M	Connects to video out on target computer.
2	(1) USB Type A M	Connects to USB port on target computer.
3	(2) RJ-45 F	Connect to ServSwitch CX or CX Uno units.

2.4.7 ServSwitch CX Dual CATx Server Access Module, USB and Audio (KV1406A)

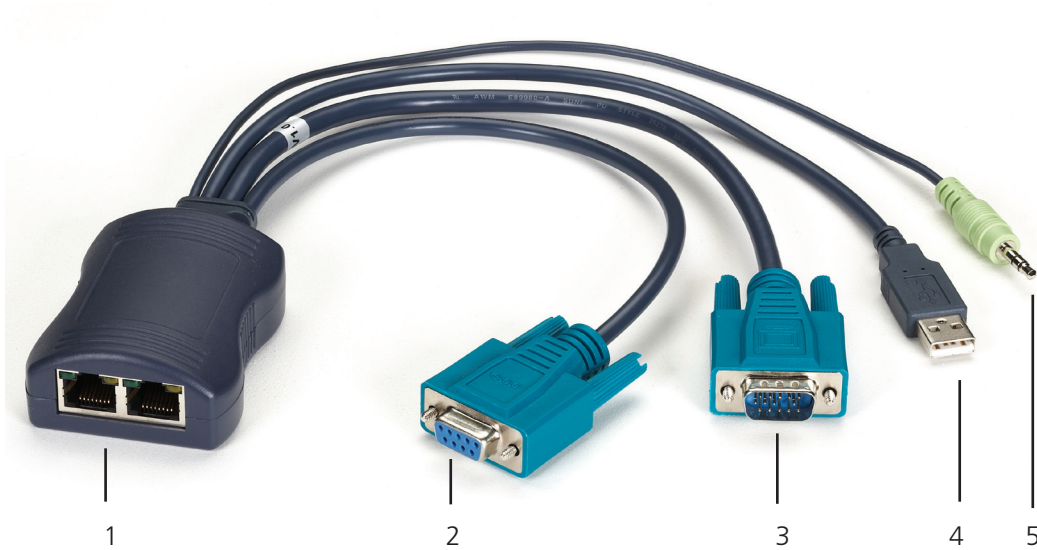

Figure 2-7. KV1406A.

Table 2-8. KV1406A connectors.

Callout Number in Figure 2-7	Connector	Description
1	(2) RJ-45	Connect to ServSwitch CX or CX Uno.
2	(1) DB9 F	Connects to RS-232 serial port on target computer.
3	(1) HD15	Connects to video out on target computer.
4	(1) USB Type A	Connects to keyboard/mouse port on the target computer.
5	(1) 3.5-mm plug	Connects to video out on the target computer.

2.4.8 ServSwitch CX Quad IP CATx Server Access Module, Serial (KV1407A)

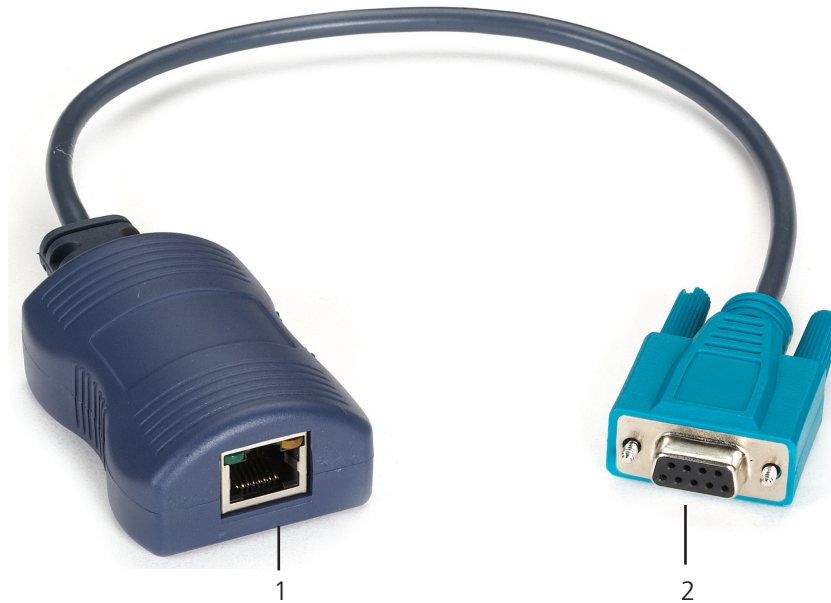

Figure 2-8. KV1407A.

Table 2-9. KV1407A connectors.

Callout Number in Figure 2-8	Connector	Description
1	(1) RJ-45	Connects to ServSwitch CX or CX Uno.
2	(1) DB9 F	Connects to DB9 serial port or RS-232 device.

NOTE: The KV1407A only works with the KV4161A and Quad IP User KVM Switch Module.

2.4.9 ServSwitch CX Server Access Module, DisplayPort, USB and Audio (KV1408A)

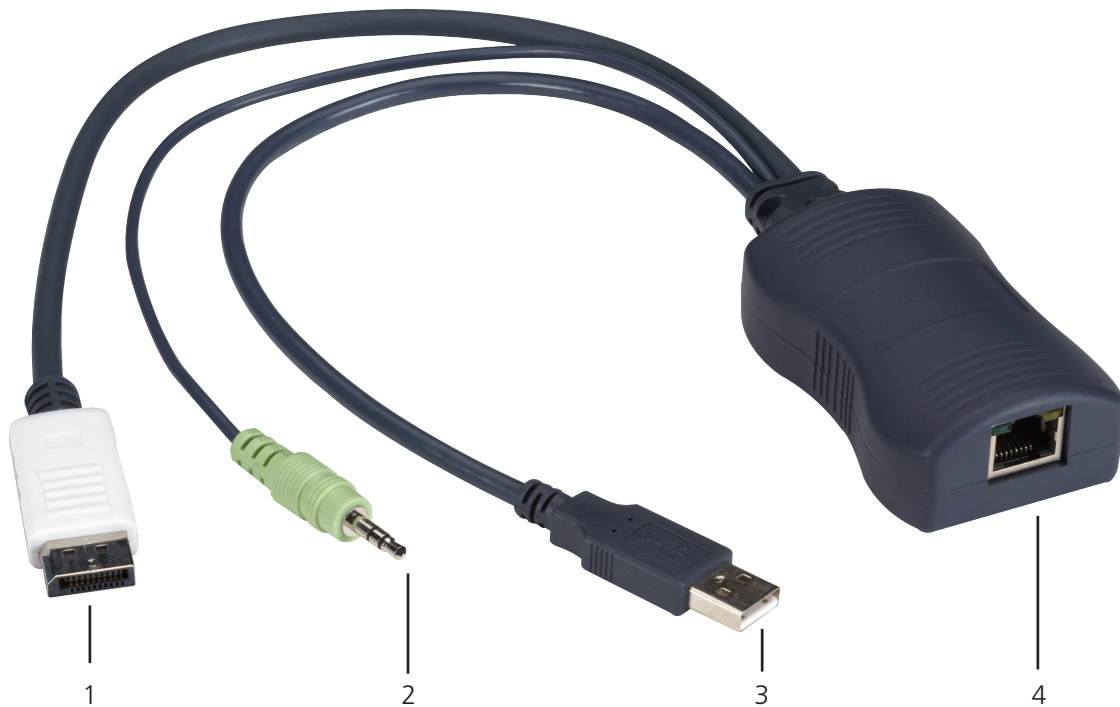

Figure 2-9. KV1408A.

Table 2-10. KV1408A connectors.

Callout Number in Figure 2-9	Connector	Description
1	(1) DisplayPort M	Connects to DisplayPort on target computer.
2	(1) 3.5-mm plug	Connects to video out on the target computer.
3	(1) USB Type A M	Connects to USB port on the target computer.
4	(1) RJ-45	Connects to ServSwitch CX and CX Uno.

2.4.10 ServSwitch CX Server Access Module, Mini DisplayPort, USB and Audio (KV1409A)



Figure 2-10. KV1409A.

Table 2-11. KV1409A connectors.

Callout Number in Figure 2-10	Connector	Description
1	(1) Mini DisplayPort M	Connects to Mini DisplayPort on target computer.
2	(1) 3.5-mm plug	Connects to audio out port on target computer.
3	(1) USB Type A M	Connects to USB port on target computer.
4	(1) RJ-45	Connects to ServSwitch CX or CX Uno.

3. Installation

3.1 Installation Steps

1. Connect the ServSwitch CX or CX Uno to the RJ-45 port on the server access module (SAM).
2. Connect the remaining connectors to a compatible target computer.

3.2 Typical Applications

3.2.1 KV0081A or KV0161A

The SAMs work with the ServSwitch CX Uno, 8-Port (KV0081A), or ServSwitch CX Uno, 16-Port (KV0161A). They provide high-end, multiplatform KVM switching over CATx with remote access. Place the remote console up to 984.3 feet (300 m) away. The ServSwitch supports resolutions up to 1920 x 1200 at 60 Hz (when used at distances less than 328 feet [100 m]), and reads DDC EDID from the display to avoid plug-and-play issues.

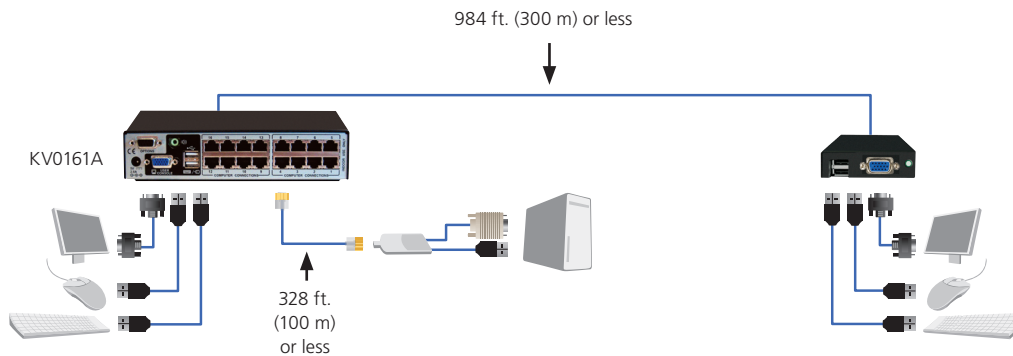

Figure 3-1. Application diagram #1.

3.2.2 KV0424A-R2

The SAMs also work with the ServSwitch CX, (1) Local Console Port + (4) Users, (24) Servers (KV0424A-R2). Up to four users can access and control 24 multiplatform servers via CATx cable. The switch can support up to 1920 x 1200 resolution and can switch via on-screen menus. This ServSwitch is ideal for small and mid-size data centers.

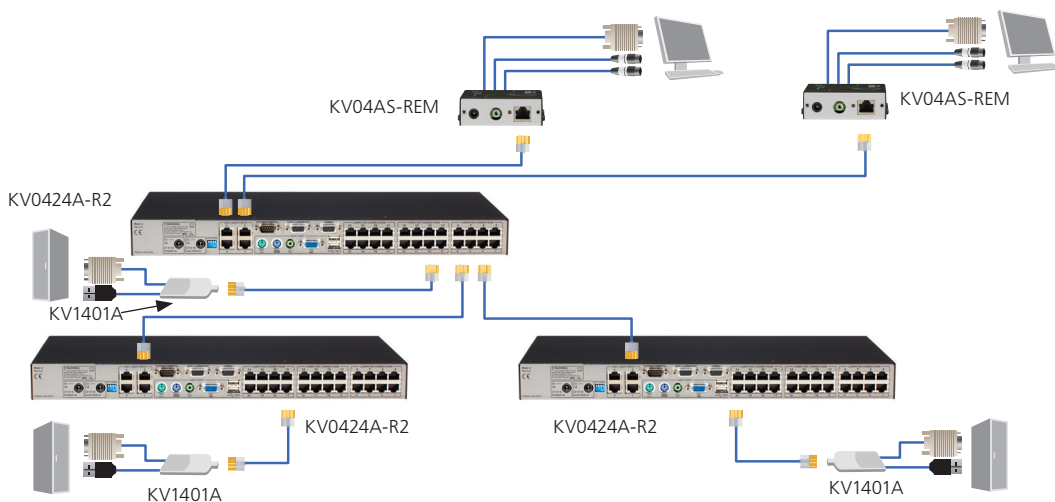

Figure 3-2. Application diagram #2.

3.2.3 KV1416A-R2

And, the SAMs work with the ServSwitch CX KVM Switch with IP, (1) Analog Console Port + (4) Users, (16) Servers (KV1416A-R2). Run this multiplatform switch over CATx cable and access servers over the Internet. Connect one remote user and up to three local users. IP support enables you to access servers remotely. This ServSwitch provides 1600 x 1200 remote resolution with scalable windows.

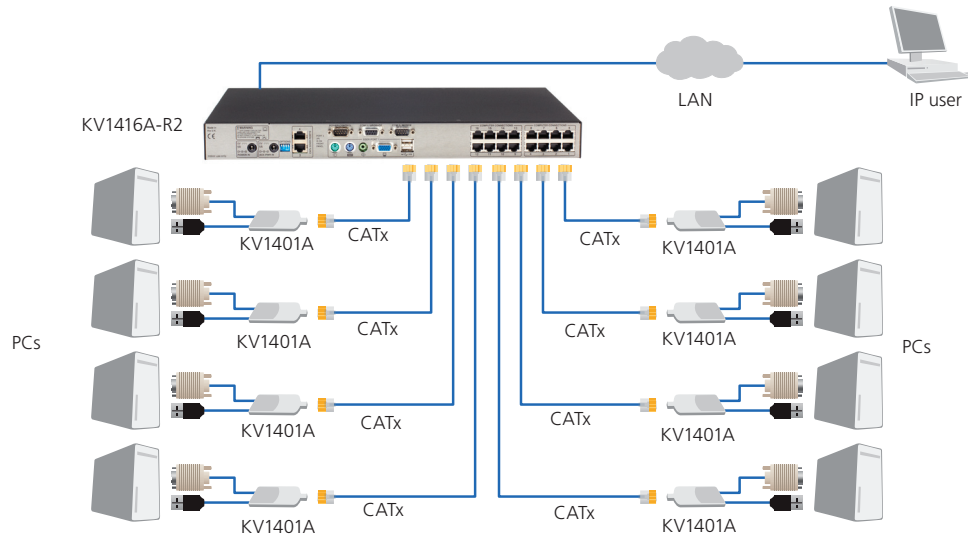

Figure 3-3. Application diagram #3.

NOTE: Refer to the ServSwitch CX or CX Uno user manual for more information.

4. Troubleshooting

4.1 Contacting Black Box

If you determine that your Server Access Module is malfunctioning, do not attempt to alter or repair the unit. It contains no user-serviceable parts. Contact Black Box Technical Support at 724-746-5500 or info@blackbox.com.

Before you do, make a record of the history of the problem. We will be able to provide more efficient and accurate assistance if you have a complete description, including:

- the nature and duration of the problem.
- when the problem occurs.
- the components involved in the problem.
- any particular application that, when used, appears to create the problem or make it worse.

4.2 Shipping and Packaging

If you need to transport or ship your Server Access Module:

- Package it carefully. We recommend that you use the original container.
- If you are returning the unit, make sure you include everything you received with it. Before you ship for return or repair, contact Black Box to get a Return Authorization (RA) number.

Black Box Tech Support: FREE! Live. 24/7.

Tech support the
way it should be.



Great tech support is just 30 seconds away at 724-746-5500 or blackbox.com.



About Black Box

Black Box provides an extensive range of networking and infrastructure products. You'll find everything from cabinets and racks and power and surge protection products to media converters and Ethernet switches all supported by free, live 24/7 Tech support available in 30 seconds or less.

© Copyright 2012. Black Box Corporation. All rights reserved.

KV1400A, version 1

Free Manuals Download Website

<http://myh66.com>

<http://usermanuals.us>

<http://www.somanuals.com>

<http://www.4manuals.cc>

<http://www.manual-lib.com>

<http://www.404manual.com>

<http://www.luxmanual.com>

<http://aubethermostatmanual.com>

Golf course search by state

<http://golfingnear.com>

Email search by domain

<http://emailbydomain.com>

Auto manuals search

<http://auto.somanuals.com>

TV manuals search

<http://tv.somanuals.com>