

PENTAX Corporation 2-36-9, Maeno-cho, Itabashi-ku, Tokyo 174-8639, JAPAN
(<http://www.pentax.co.jp/>)

PENTAX Europe GmbH (European Headquarters)
Julius-Vosseler-Strasse, 104, 22527 Hamburg, GERMANY
(HQ - <http://www.pentaxeurope.com>)
(Germany - <http://www.pentax.de>)

PENTAX U.K. Limited PENTAX House, Heron Drive, Langley, Slough, Berks
SL3 8PN, U.K.
(<http://www.pentax.co.uk>)

PENTAX France S.A.S. 12/14, rue Jean Poulmarch, 95106 Argenteuil Cedex, FRANCE
PENTAX Benelux B.V. (for Netherlands)

Spinveld 25, 4815 HR Breda, NETHERLANDS
(<http://www.pentax.nl>)
(for Belgium & Luxembourg)
Weiveldlaan 3-5, 1930 Zaventem, BELGIUM
(<http://www.pentax.be>)

PENTAX (Schweiz) AG Widenholzstrasse 1 Postfach 367 8305 Dietlikon, SWITZERLAND
(<http://www.pentax.ch>)

PENTAX Scandinavia AB P.O. Box 650, 75127 Uppsala, SWEDEN
(<http://www.pentax.se>)

PENTAX Imaging Company

A Division of PENTAX of America, Inc.

(Headquarters)
600 12th Street, Suite 300
Golden, Colorado 80401, U.S.A.
(Distribution & Service Center)
16163 West 45th Drive, Unit H Golden, Colorado
80403, U.S.A.
(<http://www.pentaximaging.com>)

PENTAX Canada Inc. 1770 Argentia Road Mississauga, Ontario L5N 3S7,
CANADA
(<http://www.pentaxcanada.ca>)



for your
preclous moments

<http://www.pentax.co.jp/english>

- Specifications and external dimensions are subject to change without notice.

57515

Copyright © PENTAX Corporation 2005

01-200505 Printed in Philippines

Download from www.Somanuals.com. All Manuals Search And Download.

PENTAX™

Optio
S5z

Digital Camera

Optio S5z

Operating Manual

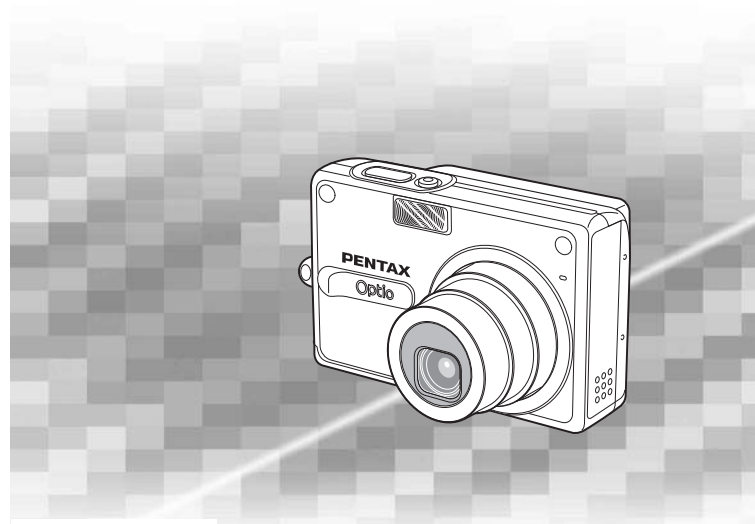

To ensure the best performance from
your camera, please read the Operating
Manual before using the camera.

Thank you for buying the PENTAX Digital Camera.

Please read this manual before using the camera in order to get the most out of all the features and functions. Keep this manual safe, as it can be a valuable tool in helping you to understand all the camera's capabilities.

Regarding copyrights

Images taken using the PENTAX Digital Camera that are for anything other than personal enjoyment cannot be used without permission according to the rights as specified in the Copyright Act. Please take care, as there are even cases where limitations are placed on taking pictures even for personal enjoyment during demonstrations, performance or of items on display. Images taken with the purpose of obtaining copyrights also cannot be used outside the scope of use of the copyright as laid out in the Copyright Act, and care should be taken here also.

To users of this camera

- There is a possibility that recorded data may be erased or that the camera may not function correctly when used in surroundings such as installations generating strong electromagnetic radiation or magnetic fields.
- The liquid crystal panel used in the LCD display is manufactured using extremely high precision technology. Although the level of functioning pixels is 99.99% or better, you should be aware that 0.01% or fewer of the pixels may not illuminate or may illuminate when they should not. However, this has no effect on the recorded image.

Regarding trademarks

- PENTAX, Optio and smc PENTAX are trademarks of PENTAX Corporation.
- The SD logo  is a trademark.
- All other brands or product names are trademarks or registered trademarks of their respective owners.

This product supports PRINT Image Matching III.

PRINT Image Matching enabled digital still cameras, printers and software help photographers to produce images more faithful to their intentions. Some functions are not available on printers that are not PRINT Image Matching III compliant.

Copyright 2001 Seiko Epson Corporation. All Rights Reserved.

PRINT Image Matching is a trademark of Seiko Epson Corporation. The PRINT Image Matching logo is a trademark of Seiko Epson Corporation.

Regarding PictBridge

PictBridge allows the user to connect the printer and digital camera directly, using the unified standard for the direct printout of images. You can print images directly from the camera through a few simple operations.

- There is a possibility that the illustrations and the display screen of the LCD monitor in this manual are different from the actual product.

FOR SAFE USE OF YOUR CAMERA

Sufficient attention has been paid to the safety of this product but please pay particular attention to the warnings indicated by the following symbols during use.



Warning

These symbols indicate that it is possible that the user may experience serious difficulties if the warnings are not heeded.



Caution

These symbols indicate that it is possible that the user may experience minor or middling difficulties or physical difficulties if the warnings are not heeded.

About the Camera



Warning

- Do not attempt to take the camera apart or remodel the camera. High voltages are present within the camera, and there is therefore a danger of electric shocks if the camera is taken apart.
- If the inside of the camera should become exposed as a result of, for example, the camera being dropped, please do not under any circumstances touch such exposed portions, as there is a danger of receiving an electric shock.
- Wrapping the strap of the camera around your neck is also dangerous. Please take care that small children do not hang the strap around their necks.
- To avoid the risk of it being swallowed by mistake, keep the SD Memory Card out of the reach of small children. Seek medical attention immediately if a memory card is accidentally swallowed.
- Use an AC adapter that is of the power and voltage specified for exclusive use with this product. The use of an AC adapter other than that specified exclusively for use with this product may cause fire or electric shocks.
- If the camera emits smoke or a strange smell, or in the event of any other irregularity, stop using the camera immediately, remove the battery or disconnect the AC adapter and contact your nearest PENTAX service center. Continued use of the camera may result in fire or electric shock.

Caution

- Never try to disassemble or short the battery. Also, do not dispose of the battery in fire, as it may explode.
- Do not charge any batteries other than rechargeable lithium-ion battery D-LI8. The battery could explode or catch fire.
- Do not place your finger on the flash when it is discharging as there is a risk of burns.
- Do not discharge the flash while it is touching your clothing as there is a risk of discoloring.
- If any of the battery leakage should come in contact with your eyes, do not rub them. Flush your eyes with clean water and get medical attention immediately.
- If any of the battery leakage should come in contact with skin or clothes, wash the affected areas thoroughly with water.
- Remove the battery from the camera immediately if it becomes hot or begins to smoke. Be careful not to burn yourself during removal.
- Some portions of the camera heat up during use, so please take care, as there is a risk of low temperature burns if such portions are held for long periods of time.
- Should the LCD be damaged, be careful of glass fragments. Also, be careful not to allow the liquid crystal to get on your skin or in your eyes or mouth.

About the Battery Charger and the AC Adapter

Warning

- Do not use the product at a voltage other than the specified voltage. Use with a power source or voltage other than that designed can cause a fire or electrical shock. The specified voltage is 100-240 V AC.
- Do not disassemble or modify the product. This can cause a fire or electrical shock.
- If the generation of smoke or strange odor from the product or other abnormality occurs, immediately discontinue using and consult a PENTAX Service Center. Continuing to use the product can cause a fire or electrical shock.
- If water should happen to get inside the product, consult a PENTAX Service Center. Continuing to use the product can cause a fire or electrical shock.

- If lightning should be present during use of the battery charger or AC adapter, unplug the power cord and discontinue use. Continuing to use the product can cause damage to the equipment, fire or electrical shock.
- Wipe off the plug of the power cord if it should become covered with dust. This can cause a fire.

 **Caution**

- Do not place heavy objects on the AC plug cord, allow heavy objects to drop onto it or allow the AC plug cord to become damaged due to excessive bending. If the AC plug cord becomes damaged, consult a PENTAX Service Center.
- Do not short or touch the output terminals of the product while it is still plugged in.
- Remove the battery and unplug the AC plug cord when not using the battery charger.
- Do not plug in the AC plug cord with wet hands. This can cause an electrical shock.
- Do not subject the product to strong impacts or allow it to drop onto a hard surface. This can cause a malfunction.
- To reduce the risk of hazards, use only CSA/UL Certified power supply cord set, cord is Type SPT-2 or heavier, minimum NO.18 AWG copper, one end with a molded-on male attachment plug cap (with a specified NEMA configuration), and the other is provided with a molded-on female connector body (with a specified IEC nonindustrial type configuration) or the equivalent.
- Do not use the battery charger to charge batteries other than the ones specified. This can cause overheating or malfunctions.

Care to be Taken During Handling

- Take the international warranty card with you when you travel abroad. Also take the Worldwide Service Network that is included in the package. This will be useful if you experience problems abroad.
- When the camera has not been used for a long time, confirm that it is still working properly, particularly prior to taking important pictures (such as at a wedding or during travelling). Contents of a recording such as images and sounds cannot be guaranteed if recording, playback or data transfer from your camera to a computer, etc. is not possible due to a malfunction of your camera or recording medium (SD Memory Card), etc.
- The lens on this camera is not exchangeable. The lens is not removable.
- Do not clean the product with organic solvents such as thinner, alcohol or benzene.
- Places of high temperature and humidity should be avoided. Particular care should be taken regarding vehicles, which can become very hot inside.
- Storing the camera where pesticides and chemicals are handled should be avoided. Remove from case and store in a well-ventilated place to prevent the camera from becoming moldy during storage.
- Do not use the camera where it may come in contact with rain, water or any other liquid, because the camera is not weather, water, or liquid resistant.
- Ensure that the camera is not subjected to substantial vibrations, shocks or pressure. Place the camera on a cushion for protection when the camera is subjected to the vibrations of a motorbike, car, or ship, etc.
- The temperature range in which the camera can be used is 0°C to 40°C (32°F to 104°F).
- The liquid crystal display will become black at high temperature but will return to normal when normal temperatures are returned to.
- The response speed of the liquid crystal display becomes slow at low temperatures. This is due to the properties of the liquid crystal and is not a fault.
- Periodic checks are recommended every 1 to 2 years in order to maintain high-performance.

- If the camera is subjected to rapid temperature changes, condensation may form on the inside and outside of the camera.
Therefore put the camera in a bag or plastic bag, and take the camera out when the difference in temperature has subsided.
- Avoid contact with garbage, dirt, sand, dust, water, toxic gases, salt, etc. as this may cause damage to the camera. If rain or drops of water get onto the camera, please wipe dry.
- Refer to “Precautions When Using an SD Memory Card” (p.22) regarding the SD Memory Card.
- The AC plug cord supplied with the camera is for exclusive use with the Battery charger D-BC8. Do not use it with any other equipment.
- Please do not press forcefully on the LCD monitor. This could cause breakage or malfunction.
- Be careful not to sit down with the camera in your back pocket as this may damage the exterior of the camera or the LCD monitor.
- When using a tripod with the camera, be careful not to overtighten the screw in the tripod socket on the camera.

LED Safety Standard

This device is a digital still camera that conforms to the safety standard (IEC60825-1) for a Class 1 LED product.

Contents

FOR SAFE USE OF YOUR CAMERA	1
Care to be Taken During Handling	4
Contents of the Operating Manual	9
Checking the Contents of the Package	10
Names of Parts	11
Names of Operating Parts	12
Getting Started	13
Attaching the Strap	13
Powering the Camera	14
Installing the Battery	14
Removing the Battery	14
Charging the Battery	15
Charging the Battery Abroad	17
Using the AC Adapter (optional)	19
Installing the SD Memory Card	21
Image Size and Quality	23
Initial Settings (Setting the Display Language and the Date and Time)	25
Setting the Display Language	25
Setting the Date and Time	26
Quick Start	28
Taking Still Pictures	28
Playing Back Still Pictures	30
Playing Back an Image	30
Playing Back the Previous or Next Image	30
Rotating the Displayed Image	31
Common Operations	32
Turning the Camera On and Off	32
Turning the Camera On in Playback Mode	33
Turning the Camera On in Voice Recording Mode	33
Using the Button Functions	34
Capture Mode	34
Playback Mode	35
Voice Recording Mode	37
Setting the Menus	38
How to Set the Menus	38
Menu List	41
Operating the Mode Palette	43
How to operate the Mode Palette	43
Taking Pictures	46
Taking Pictures	46
Changing the Mode	46
Selecting the Capture Mode	46
Displaying Shooting Information in Capture Mode	46

Taking Pictures by the Simplest Procedure (Green Mode)	49
Setting the Functions (Program Mode).....	50
Selecting the Picture Mode According to the Shooting Scene (Picture Mode)	51
Taking Pictures of Dark Scenes (Night Scene Mode)	54
Taking Movies (Movie Mode)	55
Taking Panorama Pictures (Panorama Assist Mode).....	57
Taking Pictures with Special Effect	59
Using Preset Function Settings (User Mode)	63
Using the Self-Timer.....	64
Using the Remote Control Unit (optional).....	65
Continuous Shooting (Continuous Shooting Mode).....	67
Using the Zoom to Change the Subject Size	68
Taking Time-lapse Movies.....	70
Setting the Shooting Functions	72
Selecting the Focus Mode	72
Selecting the Flash Mode	75
Selecting the Recorded Pixels	76
Selecting the Quality Level.....	78
Adjusting the White Balance	80
Changing the Focusing Area.....	82
Setting the Light Metering Mode to Determine the Exposure.....	83
Setting the Sensitivity	85
Setting the Exposure (EV Compensation).....	86
Setting the Auxiliary AF Light	87
Setting the Instant Review Time.....	88
Setting the Color Mode (Color Mode).....	89
Registering Frequently Used Functions (Fn Setting).....	90
Setting the QUICK Button	92
Setting the Image Sharpness	93
Setting the Color Saturation	94
Setting the Image Contrast.....	95
Saving the Settings	96
Saving the Menu Items (Memory)	96
Registering Functions in User Mode	97
Returning the Shooting Functions to the Default Settings	99
Recording and Playback of Sound	100
<hr/>	
Recording Sound (Voice Recording Mode)	100
Playing Back Sound.....	101
Adding a Voice Memo	102
Recording a Voice Memo	102
Playing Back a Voice Memo.....	103
Playback/Deleting/Editing	104
<hr/>	
Playing Back Images	104
Playing Back Still Pictures	104
Zoom Display	104

Playing Back Movies	106
Displaying Shooting Information in Playback Mode	108
Nine-Image Display	109
Slideshow	110
Deleting Images, Movies and Sounds	111
Deleting a Single Image, Movie or Sound	111
Deleting All Images	113
Protecting Images, Movies and Sounds from Deletion (Protect)	114
Viewing Images on a TV	116
Viewing Back an Image Using the Remote Control Unit (optional)	117
Setting the Printing Service (DPOF)	118
Printing Single Images	118
Printing All Images	120
Direct Printing Using PictBridge	121
Connecting the Camera to the Printer	121
Printing Single Images	122
Printing All Images	123
Printing Using the DPOF Settings	124
Disconnecting the Camera from the Printer	124
Editing Images	125
Changing the Image Size and Quality	125
Trimming Images	127
Editing Pictures with Color Filters	128
Editing Pictures with Brightness Filter	129
Editing Movies	131
Copying Files	134
Settings	136
<hr/>	
Camera Settings	136
Setting Up the Start-up Screen	136
Formatting an SD Memory Card or the Built-in Memory	138
Changing the Sound Settings	139
Changing the Date and Time	141
Setting the World Time	143
Changing the Display Language	145
Changing the USB Connection Mode	146
Changing the Video Output Format	146
Adjusting the Brightness of the LCD Monitor	147
Sleep Timeout	148
Setting Auto Power Off	149
Setting the Guide Display	150
Resetting to Default Settings	151
Appendix	152
<hr/>	
List of City	152
Optional Accessories	153
Messages	154
Troubleshooting	156
Main Specifications	158
WARRANTY POLICY	161
Index	165

Contents of the Operating Manual

This operating manual contains the following chapters.

1 Getting Started

This chapter explains what you need to do after purchasing the camera before you start taking pictures. Be sure to read it and follow the instructions.

2 Quick Start

This chapter explains the simplest way to take pictures and play back images. Use it if you want to start taking pictures straightaway.

3 Common Operations

This chapter explains common operations such as the functions of the buttons and how to use the menus. For more details, refer to the respective "Taking Pictures", "Recording and Playback of Sound", "Playback/Deleting/Editing" and "Settings" chapters.

4 Taking Pictures

This chapter explains the various way of capturing images and how to set the relevant functions, including how to use the Capture Mode screen to select the capture mode best suited to the situation.

5 Recording and Playback of Sound

This chapter explains how to record sound only or add a voice memo to an image, and how to play back voice memos.

6 Playback/Deleting/Editing

This chapter explains how to play back images on the camera or on a TV, how to delete, resize and trim images, and how to print images directly to the printer.



7 Settings

This chapter explains how to set the camera-related functions.

8 Appendix

This tells you about the messages displayed on the LCD monitor and what to do in the event of trouble.

The meanings of the symbols used in this operating manual are explained below.

	indicates the reference page number for an explanation of the related operation.
	indicates information that is useful to know.
	indicates precautions to be taken when operating the camera.

Checking the Contents of the Package



Camera
Optio S5z

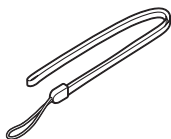

Strap
O-ST20 (*)

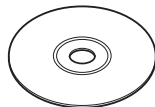

Software (CD-ROM)
S-SW35

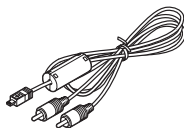

AV cable
I-AVC7 (*)



USB cable
I-USB17 (*)



Rechargeable
lithium-ion battery
D-LI8 (*)

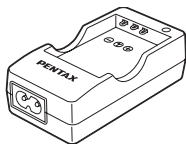

Battery charger
D-BC8 (*)



AC plug cord (*)

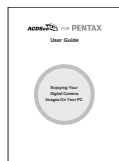

ACDSee for PENTAX
User Guide



Operating Manual
(this manual)

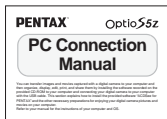

Operating Manual
(PC Connection Manual)

Items marked with an asterisk (*) are also available as optional accessories. For other optional accessories, refer to "Optional Accessories" (p.153).

Type of AC plug cord

D-CO2A Australia/D-CO2E Europe/D-CO2H Hong Kong, United Kingdom/
D-CO2J Japan/D-CO2K Korea/D-CO2U North America, Canada

Names of Parts

Front

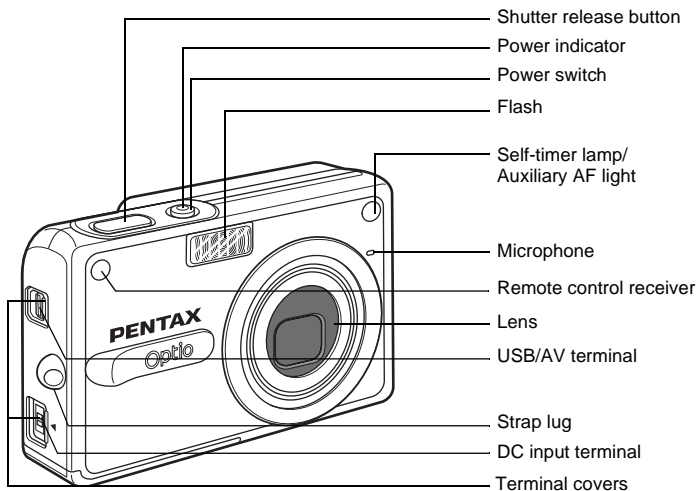

Back

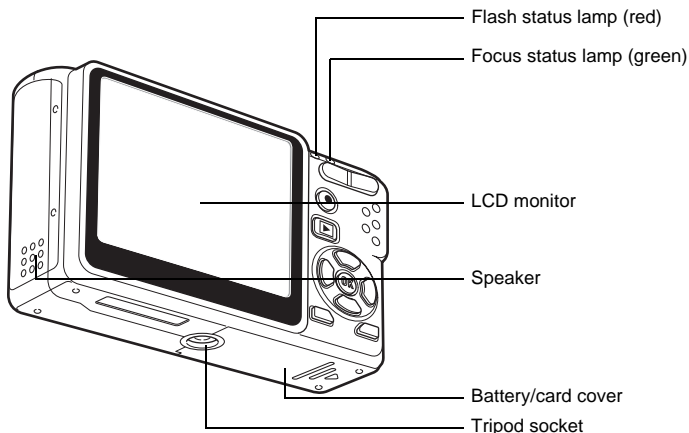

Names of Operating Parts

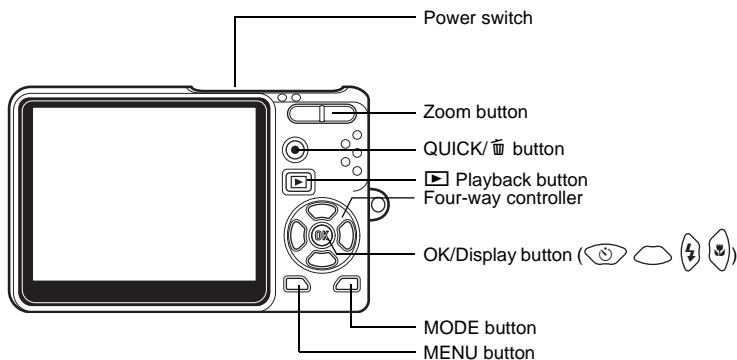

Four-way controller

In this operating manual, the four-way controller is described as shown below.

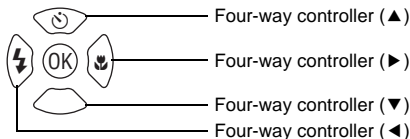

Guide Indications

A guide to available button operations appears on the LCD monitor during operation.

The buttons are indicated as shown below.

Four-way controller (▲)	▲
Four-way controller (▼)	▼
Four-way controller (◀)	◀
Four-way controller (▶)	▶
MENU button	
Shutter release button	
OK button	

Zoom button	
for digital zoom	
for trimming	
QUICK/ button	
for operating as the QUICK button	
for deleting an image	

Attaching the Strap

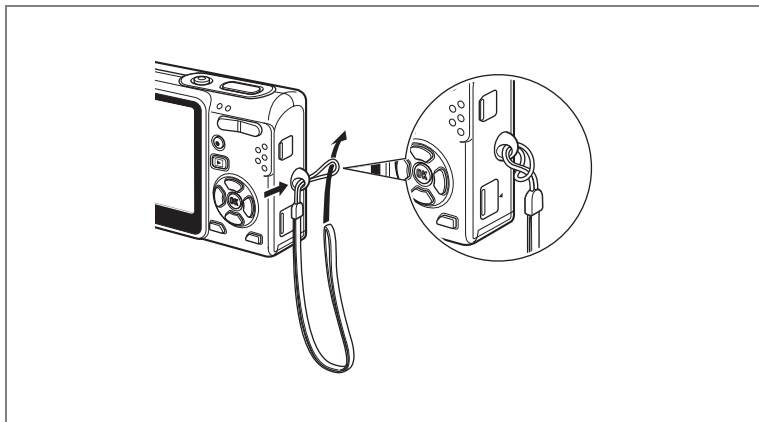

Pass the narrow end of the strap through the strap lug and pass the other end through the loop.

Powering the Camera

1

Getting Started

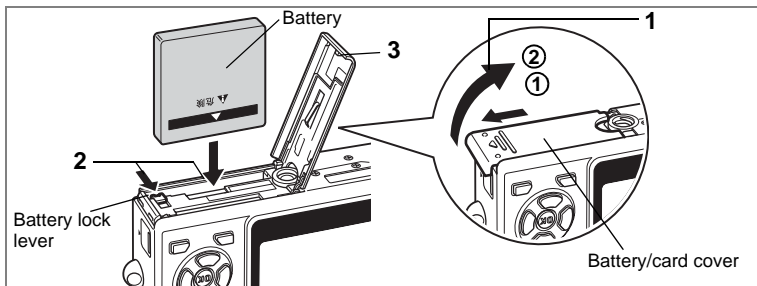

Installing the Battery

Install the battery provided with the camera.

- 1 Open the battery/card cover.**
Slide the battery/card cover in the direction indicated by the arrow ① and flip the cover open ②.
- 2 Insert the battery with the ▲ symbol facing toward the LCD monitor while using the side of the battery to press the battery lock lever in the direction indicated by the arrow.**
- 3 Close the battery/card cover.**

Removing the Battery

- 1 Open the battery/card cover.**
- 2 Release the battery by using your finger to press the battery lock lever in the same direction as when you inserted the battery.**

Pull the battery out.



If you intend to use the camera continuously for a long period, use of the AC adapter D-AC8 (optional) is recommended. (p.19)



- Insert the battery correctly. If the battery is incorrectly oriented, it may cause a malfunction.
- Do not remove the battery when the camera is turned on.
- If you do not intend to use the camera for a long time, remove the battery.
- If the camera is left without the battery for a long time, the date will be reset.

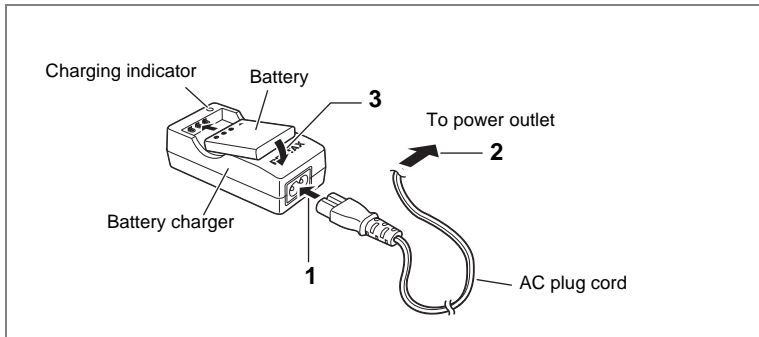

Charging the Battery

Use the battery charger D-BC8 supplied with the camera to charge the battery before using the camera for the first time or when the [Battery depleted] message appears.

- 1 Connect the AC plug cord to the battery charger.**
- 2 Plug the AC plug cord into the power outlet.**
- 3 Place the battery in the battery charger so that the PENTAX name is visible.**

The charging indicator on the charger lights red while the battery is being charged and changes to green when charging is completed.

- 4 Remove the battery from the battery charger when charging is completed.**



- The time required for full charge is about 100 minutes. The appropriate ambient temperature range for charging the battery is 0°C – 40°C (32°F to 104°F).
- The charging time may vary depending on the ambient temperature and charging conditions.
- When the battery reaches the end of its service life, the time that the camera can be operated becomes shorter even when the battery is fully charged. In this event, replace the battery.

Caution

- Always charge the battery before using the camera for the first time or when the battery has not been used for a long time.
- Do not use the battery charger D-BC8 to charge batteries other than D-LI8 rechargeable lithium-ion batteries, as the charger may overheat or be damaged as a result.
- If the battery is inserted correctly but the charging indicator blinks, the battery may be faulty. Replace with a new battery.

• Approximate Operating Time (when the D-LI8 battery is fully charged)

Number of recordable images: Approx. 180 (at 23°C with the LCD monitor on and the flash used for 50% of shots)

Playback time: Approx. 150 min.

Movie recording time: Approx. 70 min.

Sound recording time: Approx. 250 min.

- The number of recordable images are based on CIPA standard measurement and may vary depending on capture mode and shooting conditions.

Caution

- In general, battery performance temporarily deteriorates as the temperature decreases. When using the camera in a cold environment, keep it warm by putting it in your pocket or inside your coat. Battery performance that has deteriorated due to low temperature will be restored when the battery is returned to room temperature.
- Be sure to take a spare battery with you when traveling abroad or to a cold region, or if you intend to take a lot of pictures.

• Battery Level Indicator

You can check the battery level by the  symbol on the LCD monitor.



(lit green) : Adequate power remains.



(lit green) : Battery is running low.



(lit yellow) : Battery is running very low.



(lit red) : Battery is exhausted.



[Battery depleted] : The camera will turn off after the message appears.

• Recycling Batteries



This symbol indicates that the battery is recyclable. Cover the terminals with insulating tape and take the battery to a store displaying this symbol.

Li-ion

Charging the Battery Abroad

The battery charger supplied with the camera is designed to switch automatically to the voltage (100-240V) and frequency (50Hz, 60Hz) of the electricity supply in the country or region where used.

However, electrical socket shapes differ depending on the country or region. Before traveling abroad, you are advised to check the socket shape in your destination (see “Main Socket Types in the Major Countries and Regions of the World” (p.18)) and take an appropriately shaped off-the-shelf adapter plug with you. (Electrical socket shapes may vary depending on every region in the country. Check the socket shape used in the region.)

The socket shape does not affect the charging method.

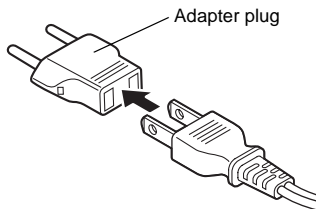

- Use of an off-the-shelf transformer may lead to defective operation.
- Unplug the adapter plug from the power outlet when the battery charger is not in use.

Type	A	B	BF	C	S
Shape					
Adapter plug	—				

Main Socket Types in the Major Countries and Regions of the World

1

Getting Started

		A	B	BF	C	S
North America	U.S.A., Canada	✓				
Europe, Former Soviet Union	Iceland, Ireland, Italy, Ukraine, Austria, Netherlands, Kazakhstan, Greece, Sweden, Denmark, Germany, Norway, Hungary, Finland, France, Belarus, Belgium, Rumania, Russia				✓	
	U.K.		✓	✓		
	Spain	✓			✓	
	Switzerland, Poland, Portugal		✓		✓	
Asia	Taiwan, Japan	✓				
	Sri Lanka, Maldives		✓			
	Nepal, Bangladesh, Mongolia				✓	
	Vietnam	✓			✓	
	India, Indonesia, Pakistan, Macau		✓		✓	
	Thailand	✓		✓	✓	
	Korea	✓	✓		✓	
	Philippines	✓			✓	✓
	Singapore, Hong Kong		✓	✓		
	China	✓	✓	✓	✓	✓
Malaysia		✓	✓	✓		
Oceania	Australia, Tonga, New Zealand, Fiji					✓
	Guam	✓				
	Tahiti				✓	
Central and South America	Colombia, Jamaica, Haiti, Panama, Bahamas, Puerto Rico, Venezuela, Mexico	✓				
	Brazil, Peru	✓			✓	
	Chile		✓		✓	
	Argentina			✓	✓	✓
Middle East	Israel, Iran				✓	
	Kuwait		✓		✓	
	Jordan		✓	✓		
Africa	Canary Islands, Guinea, Mozambique, Morocco				✓	
	Kenya, South Africa		✓		✓	
	Algeria	✓	✓	✓		
	Egypt		✓	✓	✓	
	Zambia, Tanzania		✓	✓		

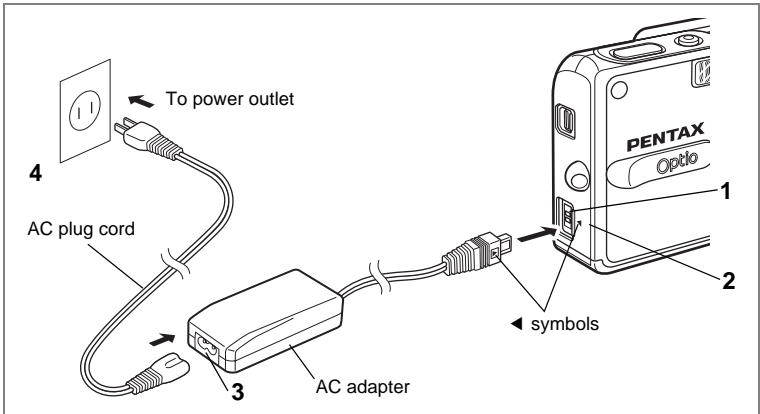

Using the AC Adapter (optional)

If you intend to use the LCD monitor for a long time or connect the camera to a PC, use of the AC adapter D-AC8 (optional) is recommended.

- 1** Make sure that the camera is turned off and open the terminal cover.
- 2** Connect the DC terminal on the AC adapter to the DC input terminal on the camera, being sure to match the ◀ symbols.
- 3** Connect the AC plug cord to the AC adapter.
- 4** Plug the AC plug cord into the power outlet.



- Make sure that the camera is turned off when connecting or disconnecting the AC adapter.
- Make sure that the AC plug cord and connecting cable are inserted securely. The data may be lost if the cable becomes disconnected while you are taking pictures.
- Be sure to read the operating manual accompanying the AC adapter before using the adapter.
- Be sure to match the ◀ symbols when connecting the DC terminals. Inserting the plugs with too much force may damage them.

Precautions When Using the Battery Charger or AC Adapter

To avoid the risk of fire or electric shock when using the battery charger or AC adapter, be sure to read the section on “FOR SAFE USE OF YOUR CAMERA” on page 1. Refer to page 160 for the specifications of the battery charger and AC adapter.

Installing the SD Memory Card

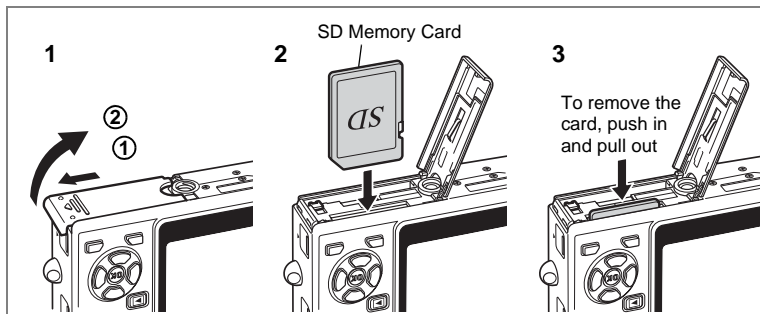

An SD Memory Card can be used with this camera. Captured images are recorded on the SD Memory Card if a card is inserted or in the built-in memory if no card is inserted.



- Make sure that the camera is turned off before inserting or removing the SD Memory Card.
- Be sure to format unused cards or cards that have been used on another camera. Refer to "Formatting an SD Memory Card or the Built-in Memory" (p.138) for instructions on formatting.

1 Open the battery/card cover.

Slide the battery/card cover in the direction indicated by the arrow ① and flip the cover open ②.

2 Insert an SD Memory Card so the label (the side with the ▲ symbol) is facing toward the LCD monitor and push the card in until it clicks.

3 Close the battery/card cover.

To remove the card, eject the card by pressing it in the direction indicated by the arrow and pull it out.



The number of recordable images varies depending on the capacity of the SD Memory Card or built-in memory and the selected image size and quality. (p.23)

Data Backup

Very occasionally, data stored in the built-in memory becomes unreadable. As a backup measure, we recommend that you download important data to a PC or store the data in a medium other than the built-in memory.

Precautions When Using an SD Memory Card

- Make sure that the camera is turned off before opening the battery/card cover.
- The SD Memory Card is equipped with a write-protect switch. Setting the switch to [LOCK] protects the existing data by prohibiting recording of new data, deletion of existing data or formatting of the card.

Write-protect switch



- Care should be taken if you remove the SD Memory Card immediately after using the camera, as the card may be hot.
- Do not remove the SD Memory Card or turn the camera off while data is being recorded on the card, images or sound are being played back, or the camera is connected to a PC with the USB cable as this may cause the data to be lost or the card to be damaged.
- Do not bend the SD Memory Card or subject it to violent impact. Keep it away from water and store away from high temperature.
- Be sure to format unused cards or cards that have been used on another camera. Refer to "Formatting an SD Memory Card or the Built-in Memory" (p.138) for instructions on formatting.
- Do not remove the SD Memory Card during formatting as this may damage the card and render it unusable.
- The data on the SD Memory Card may be deleted in the following circumstances. PENTAX does not accept any liability for data that is deleted
 - (1) when the SD Memory Card is mishandled by the user.
 - (2) when the SD Memory Card is exposed to static electricity or electrical interference.
 - (3) when the card has not been used for a long time.
 - (4) when the card is ejected, the AC adapter is disconnected or the battery is removed while the data on the card is being recorded or accessed.
- The SD Memory Card has a limited service life. If it is not used for a long time, the data on the card may become unreadable. Be sure to make a backup of important data on a PC.
- Avoid using or storing the card where it may be exposed to static electricity or electrical interference.
- Avoid using or storing the card in direct sunlight or where it may be exposed to rapid changes in temperature or to condensation.
- When using an SD Memory Card with a slow recording speed, recording may stop while you are taking movies even when there is adequate space in the memory, or shooting and playback may take a long time.
- When you purchase the SD Memory Card, access the PENTAX website and confirm beforehand if they have compatibility with your camera. Inquiries on the card compatibility can also be answered by your nearest PENTAX service center.

Image Size and Quality

Choose the image size and quality best suited to your purpose. Higher quality levels and numbers of recorded pixels produce clearer images for printing, but the resulting increase in data volume reduces the total number of pictures that can be taken.

When you choose high image quality as well as a large image size, it may take ten seconds or more for the camera to finish recording after shooting.

Choose the appropriate number of recorded pixels and quality level on the [ Rec. Mode] menu.

How to Set the Menus  p.38

Selecting the Recorded Pixels  p.76

Selecting the Quality Level  p.78

● Appropriate Sizes According to Use

5M (2560×1920)	↑ Clear, Fine	Printing images with high-resolution settings in your printer, Printing at A4 size or larger, Editing and processing images
4M (2304×1728)		
3M (2048×1536)		Printing at postcard size For use as images on websites, For attaching images to e-mail
2M (1600×1200)		
1024 (1024×768)		
640 (640×480)		

The default setting is **5M (2560×1920)**.

● Appropriate Quality According to Use

★★★	Best	Lowest compression ratio. Suitable for large A4-size photo prints.
★★	Better	Standard compression ratio. Suitable for photo prints or viewing images on a computer screen.
★	Good	Highest compression ratio. Suitable for attaching to e-mails or creating websites.

The default setting is **★★**.

● Approximate Number of Recordable Images by Size and Quality

Quality Level Recorded Pixels	Best ★★★	Better ★★	Good ★	Movie (640×480)	Sound
5M (2560×1920)	37	73	104	5 min. 30 sec.	3 hr. 12 min. 17 sec.
4M (2304×1728)	44	83	125		
3M (2048×1536)	62	113	166		
2M (1600×1200)	104	178	250		
1024 (1024×768)	227	417	544		
640 (640×480)	500	782	1043		

- The above table indicates the approximate number of images and recording time when using a 128MB SD Memory Card.
- The above table is based on standard shooting conditions specified by PENTAX and may vary depending on the subject, shooting conditions, capture mode, SD Memory Card, etc.

Initial Settings (Setting the Display Language and the Date and Time)

1

Getting Started

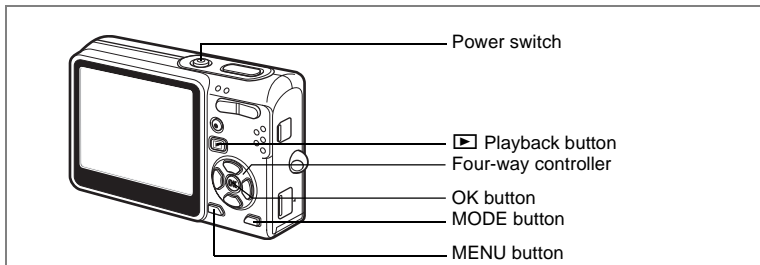

If the Initial Setting screen or Date Adjust screen appears when you turn the camera on, follow the procedure below to set the display language and/or current date and time.

If the Initial Setting screen appears:

☞ p.25 - 27 “Setting the Display Language”, “Setting the Date and Time”

If the Date Adjust screen appears:

☞ p.26 - 27 “Setting the Date and Time”

If you want to change the initial settings, refer to “Changing the Date and Time” (p.141) and “Changing the Display Language” (p.145).

Setting the Display Language

You can choose the language in which the menus, error messages, etc. are displayed from the following: English, French, German, Spanish, Italian, Swedish, Dutch, Russian, Korean, Chinese (traditional and simplified) and Japanese.

1 Press the four-way controller (►).

The Language/言語 screen appears.

2 Use the four-way controller (▲▼◀▶) to choose a language.

The default setting is English.

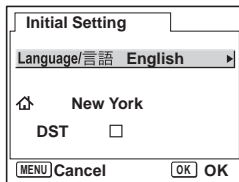

- 3 Press the OK button.**
- 4 Press the four-way controller (▼).**
The frame moves to [↑].
- 5 Use the four-way controller (◀▶) to choose the desired city (Hometown).**
- 6 Press the four-way controller (▼).**
The frame moves to [DST] (Daylight Saving Time).
- 7 Use the four-way controller (◀▶) to select (On) or (Off).**
- 8 Press the OK button.**
The Date Adjust screen appears.

Setting the Date and Time

Set the current date and time and the display style.

- 1 Use the four-way controller (▲▼) to choose the date and time display style.**

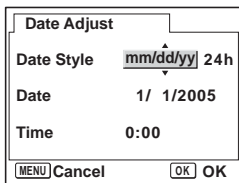

- 2 Press the four-way controller (▶).**
The frame moves to [24h].
- 3 Use the four-way controller (▲▼) to select [24h] (24-hour display) or [12h] (12-hour display).**

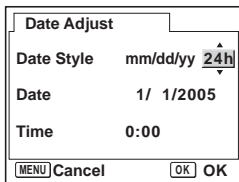

- 4 Press the four-way controller (▶).**
The frame moves to month.

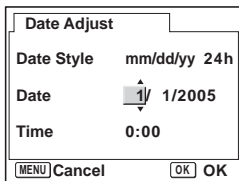

5 Use the four-way controller (▲ ▼) to change the month.

Change the day and year in the same manner.

Next, change the time.

If you select [12h] in Step 3, the setting switches between am and pm corresponding to the time.

6 Press the OK button.

The camera is ready to take pictures.



- When you finish the settings and press the OK button, the camera clock is reset to 00 seconds.
- To set the exact time, press the OK button when the time signal (on the TV, radio, etc.) reaches 00 seconds.



- When the Initial Settings screen is displayed, you can cancel the setting operation and switch to Capture mode by pressing the MENU button. In this case, the Initial Settings or Date Adjust screen will appear next time you turn the camera on.
- You can change the settings on the menu. Refer to the pages below for details.
Language: “Changing the Display Language” (p.145)
City, World Time: “Setting the World Time” (p.143)
Date and Time: “Changing the Date and Time” (p.141)
- The video output format is automatically set in conjunction with the language you have chosen as listed below. If the output format is different from the one used in your country or region, change the format following the steps in “Changing the Video Output Format” (p.146).

Language	Video Output Format
English (English)	NTSC
French (Français)	PAL
German (Deutsch)	PAL
Spanish (Español)	PAL
Italian (Italiano)	PAL
Sweden (Svenska)	PAL
Netherlands (Nederlands)	PAL
Russian (Русский)	PAL
Korean (한국어)	NTSC
Chinese (traditional) (中文繁體)	PAL
Chinese (simplified) (中文简体)	PAL
Japanese	NTSC

Taking Still Pictures

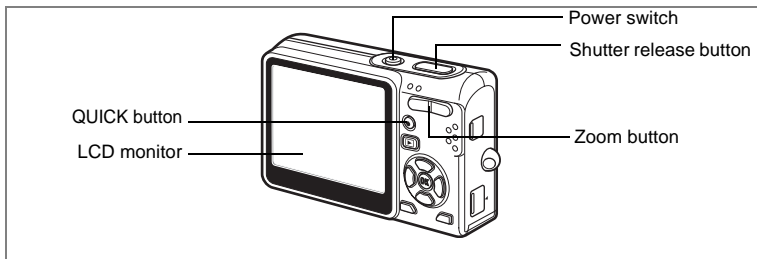

The simplest procedure for taking still pictures is described below. The flash fires automatically depending on the light conditions.

1 Press the power switch.

The camera turns on.

2 Confirm the subject and shooting information on the LCD monitor.

The focus frame in the middle of the LCD monitor indicates the zone of automatic focusing. You can change the size of the subject by pressing the zoom button.

▲ : makes the subject bigger.

◆◆◆ : makes the subject smaller.

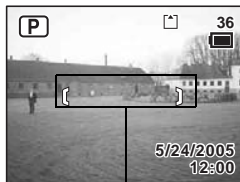

Focus frame



- To switch to the Green mode and let the camera set all the shooting functions automatically, press the QUICK button. Selecting the Green mode is the easiest way to ensure that pictures come out well. "Taking Pictures by the Simplest Procedure" (p.49)

3 Press the shutter release button halfway.

The focus frame on the LCD monitor will light green when the camera is in focus.

4 Press the shutter release button fully.

The image appears on the LCD monitor for one second (Instant Review) and is recorded on the SD Memory Card or in the built-in memory. (The green and red lamps above the zoom button blink alternately while the image is being recorded.)

Using the Shutter Release Button

The shutter release button works in a two-step action as follows.

Press halfway

The focus and exposure are locked when the shutter release button is pressed lightly (halfway). The shutter speed and aperture settings only appear on the LCD monitor when the shutter release button is pressed halfway. The following information is indicated on the LCD monitor and by the focus status and flash status lamps when the shutter release button is pressed halfway.

1. Focus frame

The focus frame turns green if the subject is in focus. The frame does not appear if the subject is out of focus.

2. Status lamps

	Focus status lamp (green)	Flash status lamp (red)
Lights	Subject is in focus	Flash is charged
Blinks	Subject is out of focus	Flash is charging

Pictures cannot be taken while the flash is charging.

Press down fully

Press the shutter release button all the way down (fully) to take a picture.

[Poor focusing conditions]

The camera may not be able to focus under the following conditions. In this case, lock the focus on an object the same distance away as the subject (by pressing the shutter release button halfway), then aim the camera at your subject and press the shutter release button fully.

- Objects that lack contrast such as a blue sky or white wall
- Dark places or objects, or conditions that prevent light being reflected back
- Finely patterned object
- Fast moving objects
- When there is an object in the foreground and an object in the background in the same picture
- Strongly reflected light or strong backlighting (bright background)

Instant Review

The Instant Review default setting is one second. During this time, you can delete the image by pressing the  button, selecting [Delete] when the [Delete] menu appears and pressing the OK button. (p.111) You can also record a voice memo by pressing the OK button during Instant Review. (p.102)

Setting the Instant Review Time p.88

Playing Back Still Pictures

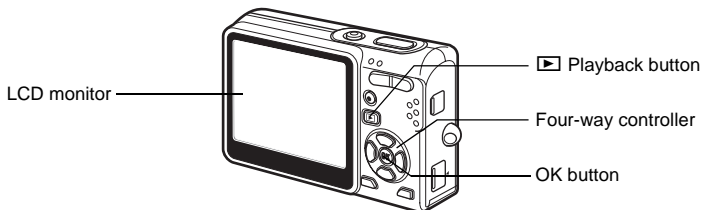

Playing Back an Image

You can display the still picture you have just taken.

- 1 Press the  Playback button after taking a picture.**

The image appears on the LCD monitor.



Zoom Display  p.104

Playing Back the Previous or Next Image

Still pictures can be played back one at a time, proceeding either forward or backward.

- 1 Press the  Playback button after taking a picture.**

The image appears on the LCD monitor.

- 2 Press the four-way controller ( ).**



displays the previous image.



displays the next image.

Rotating the Displayed Image

You can rotate a displayed image on the LCD monitor. The image will remain rotated when displayed during a slideshow.

1 Press the Playback button after taking a picture.

The image appears on the LCD monitor.

2 Press the four-way controller ()

The image is rotated 90° clockwise each time the button is pressed. Press the MENU button to stop rotating the image and return the camera to normal playback.



3 Press the OK button.

The setting for the rotated image will be saved and the camera will return to normal playback.

Deleting the Displayed Image

You can delete the image displayed on the LCD monitor by pressing the QUICK button, using the four-way controller () to select [Delete] and pressing the OK button.

Press the  Playback button again or press the shutter release button halfway to return to the Capture mode.



- The last picture taken appears on the LCD monitor when you switch to the Playback mode.
- You can enlarge the image (except a rotated image) displayed on the LCD monitor by pressing the zoom button.
- If there are no images stored, the [No image and sound] message appears.

Zoom Display  p.104

Deleting a Single Image, Movie or Sound  p.111

Turning the Camera On and Off

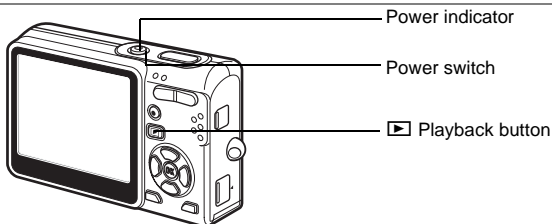



3

1 Press the power switch.

The power indicator is illuminated by a green light. The lens extends and the camera turns on in the Capture mode.

The camera is ready to take pictures by pressing the shutter release button.

- Press the  Playback button to switch to the Playback mode and view pictures while the lens is extended.
- Hold down the  Playback button for more than two seconds to activate the Playback mode with the lens retracted.

2 Press the power switch again.



The camera turns off.

Switching between Capture Mode and Playback Mode
 p.46

Turning the Camera On in Playback Mode

1 Press the power switch while pressing the Playback button.

The power indicator lights green and the camera turns on in the Playback mode with the lens retracted.

- Press the  Playback button to extend the lens and switch to the Capture mode.
- Hold down the  Playback button for more than two seconds in the Capture mode or press the  Playback button in the Voice Recording mode to switch to the Playback mode with the lens retracted.

Playing Back Still Pictures  p.30

Turning the Camera On in Voice Recording Mode

You can use the camera as a voice recorder.

There are two ways to activate the Voice Recording mode.

1 Press the power switch for more than two seconds.

The power indicator lights red, and the camera turns on in the Voice Recording mode.

1 Press the power switch while pressing the OK button.

The power indicator lights red and the camera turns on in the Voice Recording mode.

- Press the  Playback button to switch to the Playback mode.

Recording Sound  p.100

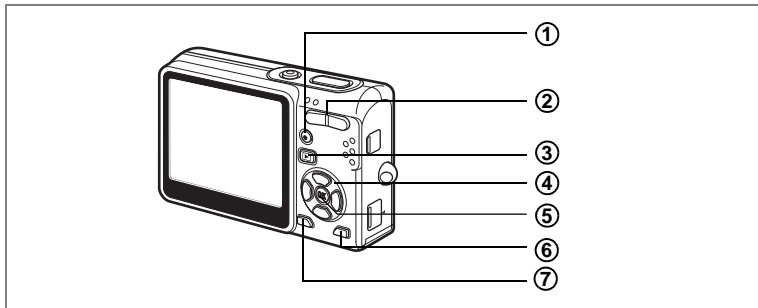

Playback Mode

- ① **QUICK/🗑️ button**
Deletes the image displayed on the LCD monitor. (☞p.111)
- ② **🔍/📏 Zoom button**
Press 🔍/🗑️ in single-image display to switch to nine-image display. Press 📏/🗑️ to return to the previous display. (☞p.109)
Press 📏/🗑️ to enlarge the image in single-image display. Press 🔍/🗑️ to return to the previous display. (☞p.104)
- ③ **▶ Playback button**
Switches to Capture mode. When switched to the Capture mode by pressing the ▶ Playback button in Voice Recording mode, pressing the ▶ Playback button again switches to the Voice Recording mode.
- ④ **Four-way controller**
For playing back still images
(◀▶) : Displays the previous or next image in single-image display. (☞p.30)
(▼) : Rotates the image in single-image display. (☞p.31)
(▲▼◀▶) : Moves the display area of the enlarged image. (☞p.104)
Selects an image in nine-image display. (☞p.109)
For playing back movies
(▲) : Plays back and pauses a movie. (☞p.106)
(◀▶) : Frame forwards, frame reverses, fast forwards and reverses a movie during playback. (☞p.106)
(▼) : Stops a movie during playback. (☞p.106)
For playing back voice recording files
(▲) Starts playback. When pressed again, pauses playback.

(◀▶) Selects a recorded file before playback. Performs the following operations during playback.

If there are no recorded indexes:

When (◀) is pressed during playback, rewinds five seconds.

When (▶) is pressed during playback, advances five seconds.

If there are recorded indexes:

When (◀) is pressed during playback, plays back starting from the previous index.

When (▶) is pressed during playback, plays back starting from the next index.

⑤ **OK/Display button**

Changes the information displayed on the LCD monitor. (☞p.108)

Returns to a single-image display in nine-image display. (☞p.109)

⑥ **MODE button**

Displays the Playback Mode Palette (☞p.45)

⑦ **MENU button**

Displays the [📷 Rec.Mode] and [⚙️ Set-up] menus. (☞p.38)

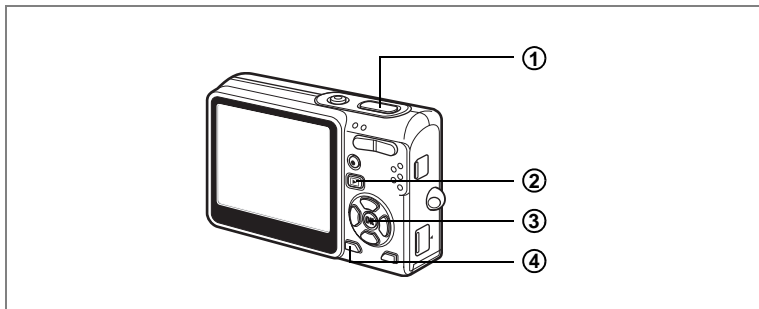

Voice Recording Mode

- ① **Shutter release button**
When pressed, starts recording, and when pressed again, stops recording.
When pressed for more than one second, recording continues for as long as the button is held down and stops when the button is released.
- ② **▶ Playback button**
Switches to Playback mode. (☞p.33) When pressed again, returns to Voice Recording mode.
- ③ **OK/Display button**
Turns the LCD monitor on and off.
- ④ **MENU button**
When pressed during recording, an index can be added.
When pressed during standby, displays the [📷 Rec.Mode] menu.
When pressed before playback, displays the [🔧 Set-up] menu. (☞p.38)

Setting the Menu

When you press the MENU button, the menus appear on the LCD monitor. You can set functions, save the settings and change the camera settings on these menus.

How to Set the Menu

When you are making settings from a menu, a guide to operation appears on the LCD monitor.

1 Press the MENU button.

The [📷 Rec.Mode] menu appears when you display the menu from Capture mode, and the [⏏ Set-up] menu appears when you display the menu from Playback mode.

The selected area is highlighted.

2 Press the four-way controller (◀▶).

Changes the menu screen.

3 Use the four-way controller (▲▼) to choose an item.

Moves the highlight up or down.

4 Press the four-way controller (▶).

A pull-down menu or setting screen appears.

The pull-down menu displays only those items that can be selected with the current camera settings.

5 Use the four-way controller (▲▼) to change the setting.

The setting changes each time the four-way controller (▲▼) is pressed.

To Save the Setting and Start Taking Pictures

6 Press the shutter release button halfway.

The setting is saved and the camera is ready to take pictures.

When the shutter release button is pressed fully, the picture is taken.

To Save the Setting and Begin Playback of Images

6 Press the Playback button.

The setting is saved and the camera returns to playback status.

To Save the Setting and Continue with Menu Operations

6 Press the OK button or the four-way controller (◀).

The setting is saved and the screen returns to Step 3.

To Cancel the Changes and Continue with Menu Operations

6 Press the MENU button.

The changes are canceled and the screen returns to Step 3.

The MENU button functions differ depending on the screen. Refer to the guide indications.

 Exit : Saves the current setting, exit the operation and return to the original screen (Capture or Playback mode).

  : Saves the current setting and return to Step 1.

 Cancel: Cancels the current selection, exit the operation and return to Step 3.



- If you press the MENU button with the pull-down menu displayed, the setting is canceled.
- If you press the OK button, the MENU button or the four-way controller (◀) with the pull-down menu displayed, the menu returns to the screen used for selecting an item.
- The menu is exited automatically one minute after the last operation.

Example of Menu Operation

1 MENU button

[📷 Rec.Mode] Menu

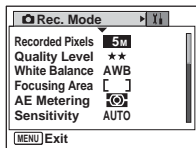

2

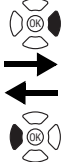

[⚙️ Set-up] Menu

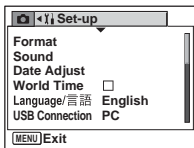

3

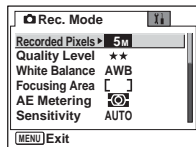

3

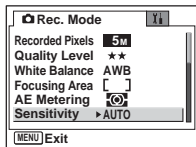

4

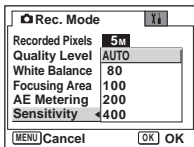
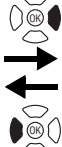

3

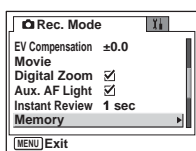

4'

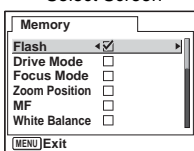
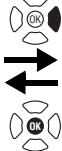

3







To the next screen



Menu List

[Rec.Mode] Menu

Yes ...Adjustable

No ...Any changes made are invalid. You can change the setting on the menu, but any changes you make are invalid in actual operation.

Item	Description	Default Setting	Green mode	Movie Mode	Other Modes	Page	
Recorded Pixels	For selecting the number of pixels	5M	No	640x480	Yes	p.76	
Quality Level	For selecting the image compression ratio	★★	No	No	Yes	p.78	
White Balance	For adjusting the color balance according to lighting	AWB (Auto)	No	Yes	Yes	p.80	
Focusing Area	For changing the area of the autofocus	[] (Multiple)	No	No	Yes	p.82	
AE Metering	For setting the metering method to determine the exposure	 (Multi-segment)	No	Yes	Yes	p.83	
Sensitivity	For setting the sensitivity	AUTO	No	No	Yes	p.85	
EV Compensation	For adjusting the exposure between -2.0 and +2.0	±0.0	No	Yes	Yes	p.86	
Movie	 Time-lapse Movie	For setting the frame rate when recording movies	Off	No	Yes	No	p.70
		For switching to the Movie mode from the Capture mode by pressing the four-way controller (▼)	<input type="checkbox"/> (Off)	No	Yes	Yes	p.56, p.71
Digital Zoom	For taking digital zoom pictures	<input checked="" type="checkbox"/> (On)	No	Yes	Yes	p.68	
Aux. AF Light	For taking pictures with auxiliary AF light	<input checked="" type="checkbox"/> (On)	No	No	Yes	p.87	
Instant Review	For setting the Instant Review time	1 sec.	No	No	Yes	p.88	
Memory	For saving the shooting function settings when the camera is turned off	—	No	Yes	Yes	p.96	
Color Mode	For selecting a color filter	Full color	No	Yes	Yes	p.89	
Fn Setting	For registering functions on the four-way controller (▲▼◀▶)	—	No	Yes	Yes	p.90	
Quick button	For registering a function on the QUICK button	Green mode	No	Yes	Yes	p.92	

Item	Description	Default Setting	Green mode	Movie Mode	Other Modes	Page
Sharpness	For setting the sharpness	 (Normal)	No	Yes	Yes	p.93
Saturation	For setting the saturation	 (Normal)	No	Yes	Yes	p.94
Contrast	For setting the contrast	 (Normal)	No	Yes	Yes	p.95

[Set-up] Menu

Item	Description	Page
Format	For formatting the SD Memory Card or built-in memory	p.138
Sound	For adjusting the playback volume and setting the type and volume of start-up sound, shutter sound, key operation sound, self-timer sound.	p.139
Date Adjust	For adjusting the date, time, and display style	p.141
World Time	For setting the world time	p.143
Language/言語	For changing the language in which menus and messages appear	p.145
USB Connection	For changing the USB connection mode	p.146
Video Out	For setting the video output format	p.146
Brightness Level	For changing the brightness of the LCD monitor	p.147
Quick Zoom	For displaying the image at specified magnification by pressing the zoom button once	p.105
Quick Delete	For displaying the Delete screen with [Delete] highlighted when [On] is selected	p.112
Sleep Timeout	For setting the power saving function	p.148
Auto Power Off	For turning off the power automatically	p.149
Guide Display	For showing the mode selected on the screen in Capture mode, the status of the four-way controller, and assignment of the QUICK button.	p.150
Reset	For returning the camera settings to defaults	p.151

Operating the Mode Palette

Once you press the MODE button, the Mode Palette appears on the LCD monitor. You can edit an image or change the settings of the camera.

How to operate the Mode Palette

The guide display is indicated while using the Mode Palette.

1 Press the MODE button.

In Capture mode, the Capture Mode Palette appears and in Playback mode, the Playback Mode Palette appears.

2 Use the four-way controller (▲▼◀▶) to choose an item.

3 Press the OK button.







The screen for each mode appears.

Mode Palette List

Capture Mode Palette



Icon	Item	Description	Page
	Program mode	The basic picture-taking mode.	p.50
	Night Scene mode	Lets you take dark scenes such as night views.	p.54
	Movie mode	Lets you take movies and sound.	p.55
	Panorama Assist mode	Lets you take a number of images to be joined into a panorama picture using the software supplied with the camera.	p.57
	Picture mode	Landscape mode	p.51
		Flower mode	
		Portrait mode	
		Self-portrait mode	

Icon	Item	Description	Page
	Sunset mode	Lets you reproduce the beautiful colors of the sunrise or sunset.	p.51
	Food mode	Lets you take appetizing pictures sf prepared food.	
	Pet mode	Lets you take clear pictures of pets to fit the hair color.	
	Text mode	Lets you take clear pictures of text or writing. Also lets you turn colored text black/white or reverse color.	
	Sports mode	Lets you take clear pictures of moving subjects with a high shutter speed and prevents blurring of images.	
	Surf & Snow mode	Lets you take photos against dazzling backgrounds like beaches or a snow-covered mountains.	
	Special Effect mode	Lets you take pictures with a posterization filter, a soft filter, a slim filter, or a comment space.	p.59
USER	USER mode	Lets you activate the preset function settings simply by turning the camera on.	p.63

Playback Mode Palette

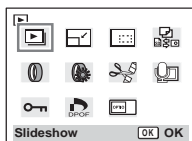



Item	Item	Description	Default setting	Page
	Slideshow	For playing recorded images successively	3 sec	p.110
	Resize	For changing the size and quality level of images	—	p.125
	Trimming	For trimming images and saving them as separate images	—	p.127
	Copy image and sound	For copying files from the built-in memory to the SD Memory Card and vice versa	—	p.134
	Color Filter	For processing images using the color filter	B&W	p.128
	Brightness Filter	For adjusting the brightness of images using a filter	—	p.129
	Movie Edit	For editing movies	—	p.131
	Voice Memo	For adding a voice memo to an image	—	p.102
	Protect	For protecting images and sounds to avoid accidental erasure	—	p.114
	DPOF	For printing images from a DPOF compatible printer or at a printing service	—	p.118
	Start-up screen	For setting the Start-up screen	Optio screen	p.136

Changing the Mode

Capture mode is for taking pictures and Playback mode is for playing back or deleting images.

Switching between Capture Mode and Playback Mode

- To change from Capture mode to Playback mode, press the  Playback button.
- To change from Playback mode to Capture mode, press the  Playback button or press the shutter release button halfway.

Selecting the Capture Mode

Pressing the QUICK button activates the Green mode. Other capture modes are selected from the Mode Palette. (p.43)

Displaying Shooting Information in Capture Mode

You can display shooting information on the LCD monitor when taking pictures. The display mode can be changed by pressing the OK/DISPLAY button.

Normal Display

Shooting information is displayed when the power is turned on.

- | | |
|---|------------------------|
| 1 Capture mode | 2 Flash mode |
| 3 Drive mode | 4 Focus mode |
| 5 Focus frame | 6 Card/Built-in memory |
| 7 Battery indicator | |
| 8 Remaining number of recordable images | |
| 9 Date and time | 10 Aperture |
| 11 Shutter speed | |

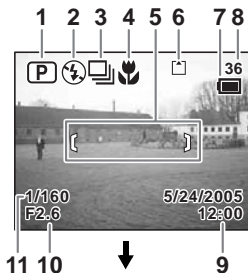

Histogram Display

The brightness distribution of the image is displayed. The horizontal axis shows the brightness (darkest at the left end and brightest at the right end) and the vertical axis shows the number of pixels.

- | | |
|-------------------|-----------------|
| 1 Recorded Pixels | 2 Quality Level |
| 3 White Balance | 4 AE Metering |
| 5 Sensitivity | 6 Histogram |

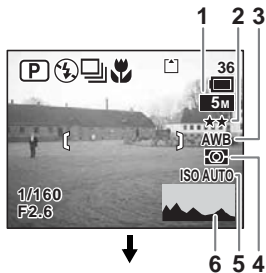

Guide Display

The grids divided into three parts are displayed. These grids will help you to improve composition.

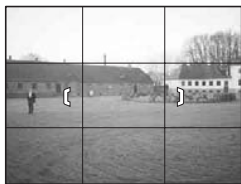

No icons

No shooting information is displayed.

- The focus frame appears in Autofocus mode.
- If any of the modes are changed, such as the flash mode, the mode you have changed appears for a few seconds.



Saving the Display Mode  p.96

Using Histogram

A histogram is a graph showing the brightness of an image on the horizontal axis and the number of pixels on the vertical axis (distribution chart of the brightness). The histogram will help you detect the brightness of the image you have taken. For instance, the graph peak tends to appear on the left side for a darker image, and the graph peak tends to appear on the right side for a brighter image. In general, when the exposure meter of your image is well-balanced, the graph peaks tend to appear in the middle. On the contrary, when the exposure meter gets imbalanced tending dark and bright without showing a neutral brightness, the peaks appear not in the middle but on both sides.

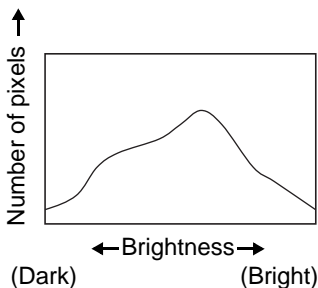

Dark

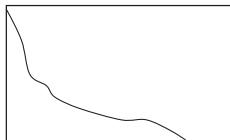

Neutral

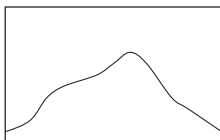

Bright



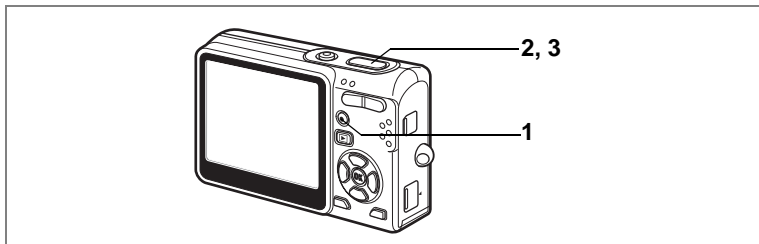

Taking Pictures by the Simplest Procedure (Green Mode)

The Green mode lets you take pictures quickly and easily, simply by pressing the shutter release button. In  (Green) mode, the camera automatically sets all the functions, including the shutter speed and aperture. You can use the zoom button to change the size of the subject.

1 Press the QUICK button in Capture mode.

You can switch to the Green mode at any stage of operation in Capture mode. Press the QUICK button again to return to the mode before the Green mode was activated.





2 Press the shutter release button halfway.

The focus frame on the LCD monitor will light green when the camera is in focus.

3 Press the shutter release button fully.

The picture is taken.



- If the camera is turned off in the Green mode, it will turn on again in the Green mode the next time the power switch is pressed. The Green mode start-up screen will appear.
- When either the MENU button, MODE button, OK/Display button or the four-way controller ( ) is pressed,  will be displayed on the LCD monitor. This icon means that your operation is invalid.

Taking Still Pictures  p.28

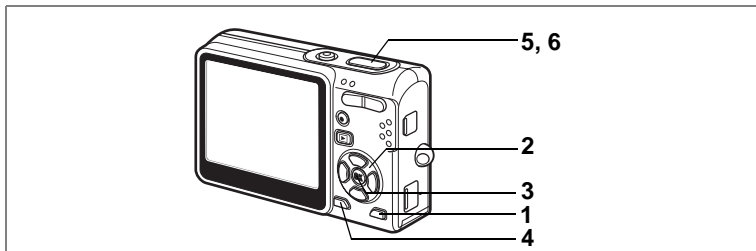

Setting the Functions (Program Mode)

In **P** (Program mode), the camera automatically sets the shutter speed and aperture for taking still pictures. However, you can select other functions such as the Flash mode or Continuous Shooting mode.

1 Press the **MODE** button in Capture mode.

The Mode Palette appears.

2 Use the four-way controller (**▲▼◀▶**) to select **P** (Program mode).

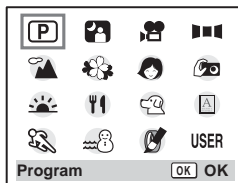

3 Press the **OK** button.

4 Set the functions you want to use.

Refer to “Setting the Shooting Functions” (p.72 - 95) for details of how to set the functions.

5 Press the shutter release button halfway.

The focus frame on the LCD monitor will light green when the camera is in focus.

6 Press the shutter release button fully.

The picture is taken.

Taking Still Pictures p.28

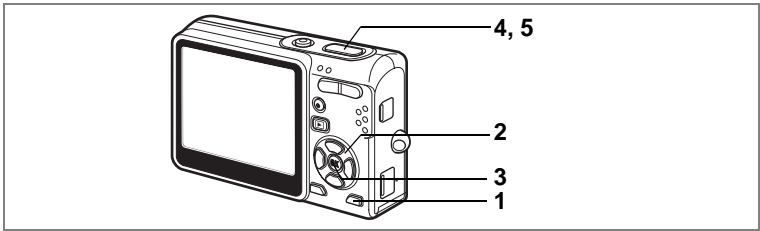

Selecting the Picture Mode According to the Shooting Scene (Picture Mode)

You can select the Picture mode according to the shooting scene. There are 10 available modes in Picture mode.

	Landscape	Lets you capture the natural colors of landscape views.
	Flower	Lets you take brightly colored flower pictures.
	Portrait	Lets you take portraits with spatial effect, by emphasizing the person.
	Self-portrait	Lets you take pictures of yourself or include yourself in pictures.
	Sunset	Lets you reproduce the beautiful colors of the sunrise or sunset.
	Food	Lets you take appetizing pictures of prepared food.
	Pet	Lets you take clear pictures of pets to fit the hair color.
	Text	Lets you take clear pictures of text or writing. Also lets you turn colored text black/white or reverse color.
	Sports	Lets you take clear pictures of moving subjects with a high shutter speed.
	Surf & Snow	Lets you take photos against dazzling backgrounds like beaches or snow-covered mountains.

1 Press the **MODE** button in Capture mode.

The Mode Palette appears.

2 Use the four-way controller (▲▼◀▶) to choose the desired mode.

For example, select (Landscape mode).

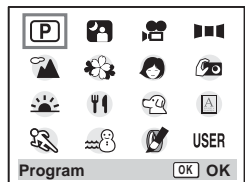

- 3 Press the OK button.**
- 4 Press the shutter release button halfway.**

The focus frame on the LCD monitor will light green when the camera is in focus.

- 5 Press the shutter release button fully.**

The picture is taken.

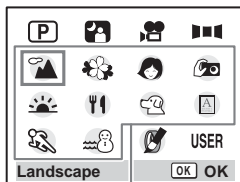

Picture mode



In Picture mode, the EV compensation, saturation, contrast, sharpness and white balance are automatically set to their default settings. You can change the settings.

Taking Pictures of Your Pet (Pet Mode)

4

Taking Pictures

In Pet mode, you can take pictures that shows natural hair color of your pet. Choose the appropriate icon depending on what color your pet is (closer to black or white or in between).

- 1 Press the MODE button in Capture mode.**
The Mode Palette appears.
- 2 Use the four-way controller (▲▼◀▶) to select**
- 3 Press the OK button.**
The screen for selecting the pet mode appears.
- 4 Use the four-way controller (▲▼) to select** **or** .

There are two icons of a cat and a dog. (Choosing either the cat or dog icon does not affect the resulting picture. Choose whichever you prefer.)



- 5 Press the OK button.**
The Pet mode is selected and the camera is ready to take the picture.
- 6 Press the shutter release button halfway.**

The focus frame turns green when the subject is in focus.

- 7 Press the shutter release button fully.**

The picture is taken.



Taking Pictures of Text (Text Mode)

This mode allows you to take clear pictures of written text. This is convenient for capturing a digital copy of an important document or enhancing legibility of small print.

1 Press the **MODE** button in Capture mode.

The Mode Palette appears.



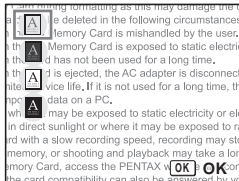

2 Use the four-way controller (▲▼◀▶) to select .

3 Press the **OK** button.

The screen for selecting the text mode appears.



4 Use the four-way controller (▲▼) to select , , , or .

	Color	Maintains original colored text.
	Neg. Color	Reverses colored text.
	B&W	Turns colored text black/white.
	Neg. B&W	Reverses black/white text.

5 Press the **OK** button.

The text mode is selected and the camera is ready to take the picture.

6 Press the shutter release button halfway.

The focus frame turns green when the subject is in focus.

7 Press the shutter release button fully.

The picture is taken.

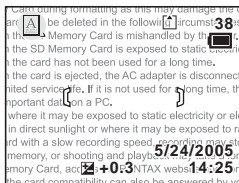

When you select the Neg. Color, B&W, or Neg. B&W, the color you have selected in [Color Mode] on the [📷 Rec.Mode] menu is not reflected in your picture.

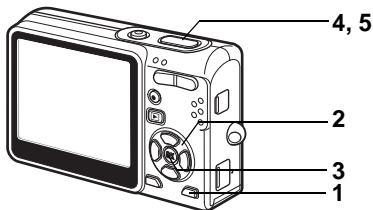

Taking Pictures of Dark Scenes (Night Scene Mode)

You can take pictures of dark scenes, such as nightscapes, with the appropriate settings.

1 Press the **MODE** button in Capture mode.

The Mode Palette appears.

2 Use the four-way controller (▲▼◀▶) to select (Night-Scene mode).

3 Press the **OK** button.

4 Press the shutter release button halfway.

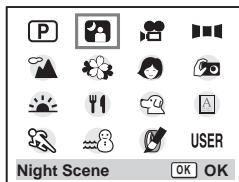

The focus frame on the LCD monitor will light green when the camera is in focus.

5 Press the shutter release button fully.

The picture is taken.



Total recording time will be longer when the picture is taken at slower shutter speed (approximately 1/4 second or slower), because the noise reduction activates to reduce noise.



The shutter speed is slower when taking pictures of dark scenes. To prevent camera shake, secure the camera on a tripod or other surface.

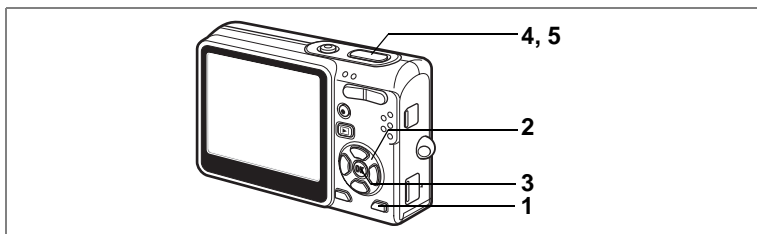



Taking Movies (Movie Mode)

This mode enables you to take movies and sound.

- 1 Press the MODE button in Capture mode.**

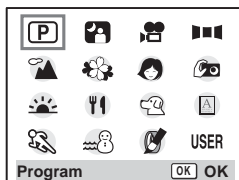
The Mode Palette appears.



- 2 Use the four-way controller (▲▼◀▶) to select  (Movie mode).**

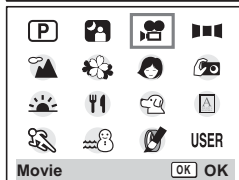

- 3 Press the OK button.**

The following shooting information appears on the LCD monitor and the camera is ready to take movies.

- | | |
|-------------------------------|--------------------------|
| 1 Movie mode icon | 2 Flash Off icon |
| 3 Card/Built-in memory | 4 Recordable time |



- 4 Press the shutter release button.**

Shooting starts. You can change the size of the image using the zoom button.

▲ : makes the subject bigger.

◆◆◆ : makes the subject smaller.

- 5 Press the shutter release button.**

Shooting ends.

Keeping the Shutter Release Button Pressed

If you keep the shutter release button pressed for more than one second, the movie will be taken for as long as you keep the button pressed. Shooting stops when you take your finger off the shutter release button.

Caution

- The flash will not discharge in Movie mode.
- Continuous shooting is not possible in Movie mode.
- Sound cannot be recorded when [Time-lapse Movie] is set to On.
- Only Pan Focus mode (normal setting/no icons), Infinity-Landscape mode and Manual Focus mode can be set in Movie mode.
- The digital zoom and optical zoom can both be used in Movie mode, but only the digital zoom can be used to change the zoom magnification once you start taking movies.

Taking Time-lapse Movies  p.70

Playing Back Movies  p.106

Switching from Capture Mode to Movie Capture Mode Using the Four-way Controller (▼)

You can set the camera so that you can switch between the still image capture mode and the movie capture mode by simply pressing the four-way controller (▼).

- 1 Press the MENU button in Capture mode.**
The [Rec.Mode] menu appears.
- 2 Use the four-way controller (▲▼) to select [Movie].**
- 3 Press the four-way controller (▶).**
The Movie screen appears.
- 4 Press the four-way controller (▲▼) to select [▼,📷].**
- 5 Press the four-way controller (◀▶) to select (On)/ (off).**
- 6 Press the shutter release button halfway.**
The camera is ready to take pictures.

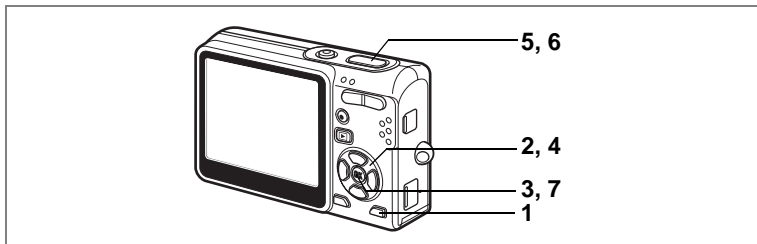

Taking Panorama Pictures (Panorama Assist Mode)

You can take a number of images and join them together to form a panorama picture. The software supplied with the camera (ACDSee for PENTAX) and a computer are necessary for joining the images. The Panorama Assist mode enables you to overlap the edges of the images so that they are easier to join together later into a panorama picture.

1 Press the **MODE** button in Capture mode.

The Mode Palette appears.

2 Use the four-way controller (▲▼◀▶) to select **■■■** (Panorama Assist mode).

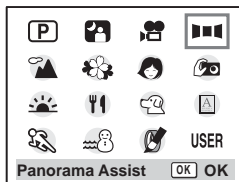

3 Press the **OK** button.

4 Use the four-way controller to choose the direction in which the images will be joined.

- ◀ Joins the images at the left.
- ▶ Joins the images at the right.
- ▲ Joins the images at the top.
- ▼ Joins the images at the bottom.

The example shows the images when ▶ is selected.



5 Take the first image.

Press the shutter release button to take the first image. The right edge of the image appears in half-transparent form on the left of the LCD monitor.



6 Move the camera to the right and take the second image.

Move the camera until the half-transparent image and the actual view overlap and press the shutter release button. Repeat Steps 5 and 6 to take the third and subsequent images.

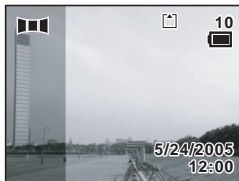

7 Press the OK button.

The screen returns to Step 4.



To cancel Panorama Assist mode, change to another mode.



- The camera cannot join the images. Use the panorama software supplied with the camera (ACDSee for PENTAX, ACD photostitcher). Refer to "ACDSee for PENTAX Users Guide" for instructions on creating panorama pictures.
- Continuous shooting is not possible in Panorama Assist mode.

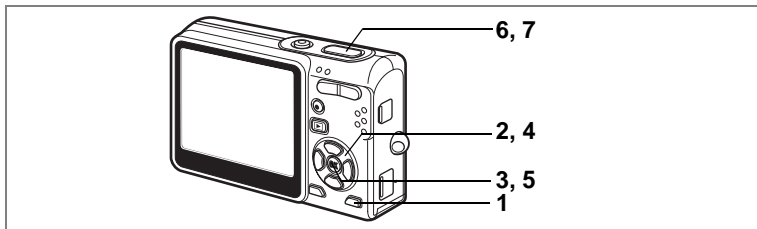

Taking Pictures with Special Effect

The Special Effect consists of a posterization filter that takes posterization-type pictures, a soft filter that produces soft-contoured pictures, a slim filter that produces a slim effect, and a comment space function that creates a small space in a picture as a comment space.



You cannot use the digital zoom in Special Effect mode.

Taking Pictures Using the Posterization filter

Posterization is an effect that uses a limited range of color tones and enables you to take posterization-type pictures.

1 Press the **MODE** button in Capture mode.

The Mode Palette appears.

2 Use the four-way controller (▲▼◀▶) to select (Special Effect).

3 Press the **OK** button.

The Special Effect screen appears.

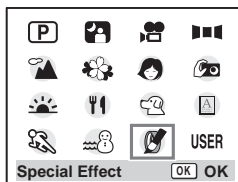

4 Use the four-way controller (▲▼) to select (Posterization).

5 Press the OK button.

6 Press the shutter release button halfway.

The focus frame on the LCD monitor will light green when the camera is in focus.

7 Press the shutter release button fully.

The picture is taken with the Posterization filter.



Taking Pictures using the Soft Filter

You can take pictures with a soft lens effect.

4 Use the four-way controller (▲▼) to select **SOFT (Soft Filter).**



5 Press the OK button.

6 Press the shutter release button halfway.

The focus frame on the LCD monitor will light green when the camera is in focus.

7 Press the shutter release button fully.

The picture is taken in Soft Filter mode.

Taking Pictures with the Slim Filter

The screen for setting the slimness level appears when you select the slim filter in Special Effect mode.

4 Use the four-way controller (▲▼) to select [] (Slim Filter).

Use the four-way controller (◀▶) to set the slimness.

– : Stretches the image up to twice its size horizontally.

+ : Stretches the image up to twice its size vertically.



5 Press the OK button.

6 Press the shutter release button halfway.

The focus frame on the LCD monitor will light green when the camera is in focus.

7 Press the shutter release button fully.

The picture is taken with a slim filter effect.







Taking Pictures with Comment Space

You can take a picture leaving a small space at the right side or at the bottom so that you can comment on it by hand. You can choose a style of the comment space from four types.

4 Use the four-way controller (▲▼) to select .



	leaves 1/8 of a picture at the bottom as a comment space.
	leaves 1/4 of a picture at the bottom as a comment space.
	leaves 1/8 of a picture at the left side as a comment space.
	leaves 1/4 of a picture at the left side as a comment space.

5 Press the OK button.

The comment space is selected and the camera is ready to take the picture.



6 Press the shutter release button halfway.

The focus frame on the LCD monitor will light green when the camera is in focus.

7 Press the shutter release button fully.

The picture is taken with a small space.



When you use the Focusing Area mode with the comment space, make sure that the focus frame and the comment space do not overlap one another. (p.74)

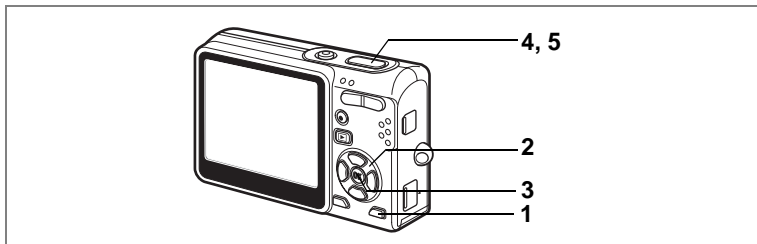

Using Preset Function Settings (User Mode)

In User mode, you can take pictures using the functions and settings registered in advance in User mode.

1 Press the **MODE** button in Capture mode.

The Mode Palette appears.

2 Use the four-way controller (▲▼◀▶) to select **USER (USER mode)**.

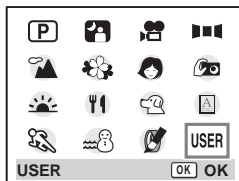

3 Press the **OK** button.

4 Press the shutter release button halfway.

The focus frame on the LCD monitor will light green when the camera is in focus.

5 Press the shutter release button fully.

The picture is taken.



Registering Functions in User Mode p.97

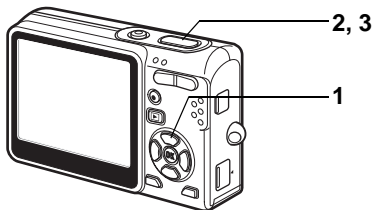

Using the Self-Timer

In self-timer mode, the picture is taken ten seconds or two seconds after the shutter release button is pressed.

4

1 Press the four-way controller (▲) in Capture mode to display  or  on the LCD monitor.

2 Press the shutter release button halfway.

The focus frame on the LCD monitor will light green when the camera is in focus.

3 Press the shutter release button fully.

 The self-timer is engaged and the self-timer lamp lights for about seven seconds. The picture is taken approximately three seconds after the self-timer lamp starts to blink.

 The self-timer is engaged and the picture is taken approximately two seconds after the self-timer lamp starts to blink.



Focusing may be compromised if you move the camera while the self-timer is running.



- The countdown is displayed on the LCD monitor when you press the shutter release button.
- To cancel the self-timer, press the MENU button while the second count is displayed.

Taking Pictures of Yourself  p.51

Troubleshooting "Subject is not in focus"  p.157

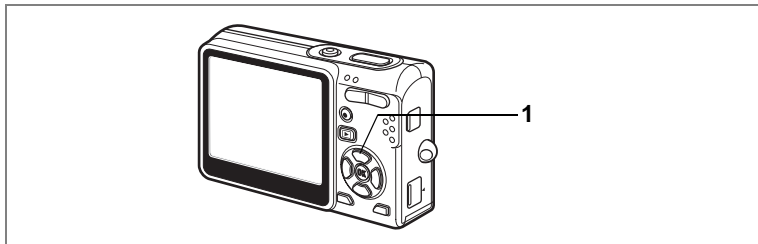

Using the Remote Control Unit (optional)

You can switch the Drive mode to Remote Control mode and take pictures using the remote control unit E or F (optional).

Taking Pictures Using the Remote Control

- 1 Press the four-way controller (▲) in Capture mode to display $\overline{\text{3s}}$ or $\overline{\text{}}$ on the LCD monitor.**

The self-timer lamp blinks slowly and the camera is ready to take the picture.

- 2 Press the shutter release button on the remote control unit.**

$\overline{\text{3s}}$ The self-timer lamp blinks quickly and the picture is taken after approximately three seconds.

$\overline{\text{}}$ The picture is taken immediately.



Focusing may be compromised if you move the camera while the self-timer lamp is blinking.

Changing the Magnification Using the Remote Control Unit

You can not only change the zoom magnification with the zoom button, but also shoot images with the shutter button using the remote control unit E (optional).

1 Press the four-way controller (▲) in Capture mode to display \bar{i}_{ss} or \bar{i} on the LCD monitor.

The function is same either in \bar{i}_{ss} or \bar{i} .

2 Press the zoom button on the remote control unit.

Each time you press the zoom button, the zoom position will change among tele, middle, and wide.



The zoom position will not change in Super Macro mode, even if you press the zoom button.



- The buttons on the camera can be used in the normal way.
- Ensure that the remote control unit is no more than about four meters away from the front of the camera.
- You cannot change the digital zoom range with the remote control unit; you can change only the optical zoom range.

Life of the Battery for the Remote Control Unit

A signal can be sent from the remote control unit to the camera approximately 30,000 times. Contact your nearest PENTAX customer service center if the battery needs changing. (A charge is made for changing the battery.)

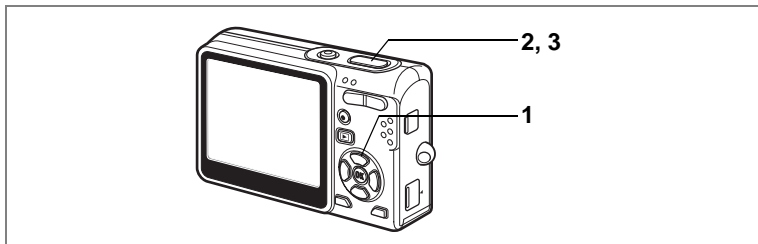

Continuous Shooting (Continuous Shooting Mode)

You can switch the Drive mode to Continuous Shooting mode. Pictures are taken continuously while the shutter release button is pressed.

1 Press the four-way controller (▲) in Capture mode to display  on the LCD monitor.

2 Press the shutter release button halfway.

The focus frame on the LCD monitor will light green when the camera is in focus.

3 Press the shutter release button fully.

Pictures are taken continuously while the shutter release button is pressed.

Shooting stops when you take your finger off the shutter release button.



- You can continue shooting until the SD Memory Card or the built-in memory is full.
- The interval will vary according to the [Recorded Pixels] and [Quality Level] settings.



- The flash will not discharge in Continuous Shooting mode.
- Continuous shooting is not available for Movie or Panorama Assist mode.
- The focus, exposure and white balance are locked with the first image.

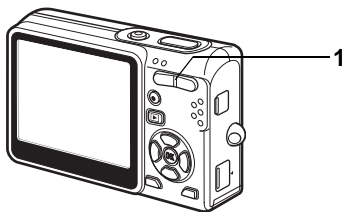

Using the Zoom to Change the Subject Size

You can use the zoom to change the size of the subject and take pictures in Tele or Wide mode.

4

Taking Pictures

1 Press the zoom button in Capture mode.

- ▲ Tele: makes the subject bigger.
- ◆◆ Wide: makes the subject smaller.

When the digital zoom function is disabled, you can take pictures at up to three times magnification using the optical zoom. When the digital zoom function is enabled, you can further enlarge the subject to a maximum magnification equivalent to 12 times.

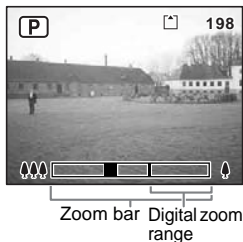

When digital zoom is enabled

Saving the Zoom Position  p.96



You cannot use the optical zoom when taking movies.

Setting the Digital Zoom

The digital zoom is set to (On) in the default settings. To take pictures using only the optical zoom, set the digital zoom to (Off).

1 Press the MENU button in Capture mode.

The [📷 Rec.Mode] menu appears.

2 Use the four-way controller (▲▼) to select [Digital Zoom].

3 Use the four-way controller (◀▶) to select (On)/ (Off).

4 Press the shutter release button halfway.

The camera is ready to take pictures.

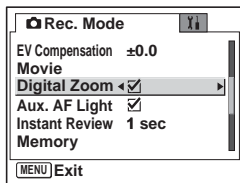

You cannot use the digital zoom in Special Effect mode.

Saving the Digital Zoom Function Setting p.96

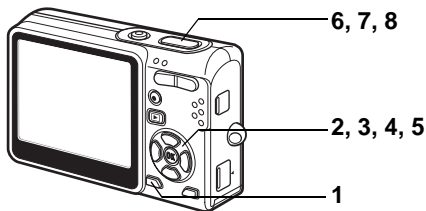

Taking Time-lapse Movies

This mode lets you take movies at a delayed frame rate so that when you play the movie back, the action appears speeded up.

- 1 Press the MENU button in Movie mode.**
The [Rec.Mode] menu appears.
- 2 Use the four-way controller (▲▼) to select [Movie].**
- 3 Press the four-way controller (▶).**
The Movie screen appears.
- 4 Use the four-way controller (▲▼) to select [Time-lapse Movie].**
- 5 Press the four-way controller (▶).**
A pull-down menu appears.
Use the four-way controller (▲▼) to change the time-lapse setting.
You can choose from [Off], [x2], [x5], [x10] and [x20].
- 6 Press the shutter release button halfway.**
The camera is ready to record a time-lapse movie.
- 7 Press the shutter release button fully.**
Recording of a time-lapse movie starts.
The selected time-lapse setting appears on the LCD monitor.

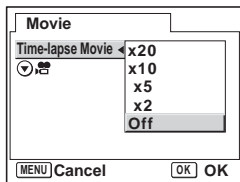

8 Press the shutter release button fully.

Stops recording movie.



- Off (x1) is the normal setting for movies (approximately 30 frames per second). Each time x2 or x5 is selected, the number of frames taken per second is reduced to 1/2 or 1/5.
- As movies are normally played back at the rate of approximately 30 frames per second, movies taken at x2 appear to be played back at twice the normal speed and movies taken at x5 appear to be played back at five times the normal speed.
- Sound cannot be recorded.

Setting to Switch Capture Mode to Movie Capture Mode

You can switch to the movie capture mode from the still image capture mode by simply pressing the four-way controller (▼).

4 Use the four-way controller (▲▼) to select [▼, 📷].

5 Use the four-way controller (◀▶) to select

(On)/ (Off).

6 Press the shutter release button halfway.

The camera is ready to take movies.



- The default setting is set to (Off).

Taking Movies p.55

Setting the Shooting Functions

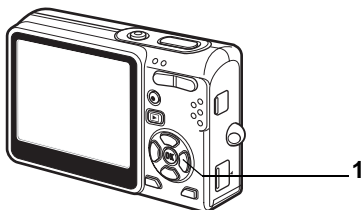





Selecting the Focus Mode

4

Taking Pictures

Focus mode

(No icon)	Autofocus mode	The camera focuses on the object in the autofocus area when the shutter release button is pressed halfway. Use this mode when the distance to the subject is more than 40 cm (16 in.).
	Macro mode	This mode is used when the distance to the subject is approx. 18 cm – 50 cm (7 in. – 20 in.). The camera focuses on the object in the autofocus area when the shutter release button is pressed halfway.
	Super Macro mode	This mode is used when the distance to the subject is approx. 6 cm – 20 cm (2.4 in. – 8 in.). The camera focuses on the object in the autofocus area when the shutter release button is pressed halfway.
PF	Pan Focus mode	This mode is used when the distance to the subject is approx. more than 1.5 m (4.92 ft.) at wide angle and approx. more than 5 m (16.4 ft.) at tele angle. The focus is set from close to infinite range. This mode is used when shooting close and distant subjects together or the subject is hard to focus on.
	Infinity-Landscape mode	This mode is used for taking distant objects.
MF	Manual Focus mode	Adjust the focus manually with the four-way controller.
	Focusing Area mode	The position of the autofocus area is changed.

Saving the Focus Mode  p.96

1 Press the four-way controller (▶) in Capture mode.

The focus mode changes each time the button is pressed and the icon appears on the LCD monitor.

The camera is ready to take pictures in the selected focus mode.



Auxiliary AF light

- The auxiliary AF light may be activated under low lighting in Autofocus mode.
- The auxiliary AF light of this camera conforms to the safety standard (IEC60825-1) for Class 1 LED product. Looking at the light directly will not create safety hazard. However, do not look into the emitter from a very short distance since you may feel dazzlingly.



- The default setting is Autofocus mode.
- The zoom is fixed at the middle position and only the digital zoom can be used in Super Macro mode.
- Only Pan Focus mode (normal setting/no icons), Infinity-Landscape mode and Manual Focus mode can be set in Movie mode. (p.55)

Manual Focus

When the mode is set to **MF** (Manual Focus), the central portion of the picture is enlarged to full screen on the LCD monitor for focus adjustment. Use the four-way controller (**▲▼**) to adjust the focus while watching the indicator on the LCD monitor.



For distant focus



For closer focus

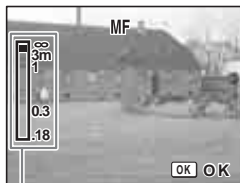

Indicator

After the focus is set, press the OK button to determine the focus position and return to the normal capture screen.

Press the OK button again to change the previously determined focus position.



When focusing, hold down the four-way controller (**▲▼**) to focus quickly.

Changing the Focusing Point

In Focusing Area mode, you can change the focusing point by moving the focus frame.

1 In  (Focusing Area) mode, press the four-way controller (▲▼◀▶).

Moves the focus frame [] (Focusing area).

2 Press the shutter release button halfway.

The focus frame is fixed in its new position. Press the OK button again to change the setting of the focusing area.

Troubleshooting "Subject is not in focus"  p.157

4



When you use the Focusing Area mode with the comment space, make sure that the focus frame and the comment space do not overlap one another. ( p.62)

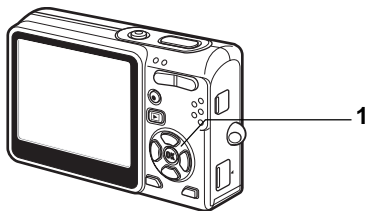

Selecting the Flash Mode

Flash Modes

(No icon)	Auto	The flash discharges automatically depending on the light conditions.
	Flash off	The flash will not discharge, regardless of the brightness. Use this mode to take pictures at dusk or in museums etc. where flash photography is prohibited.
	Flash on	The flash discharges regardless of the brightness.
	Auto + red-eye reduction	This mode reduces the phenomenon of red eyes caused by the light from the flash being reflected in the subject's eyes. The flash discharges automatically.
	Flash On + red-eye reduction	This mode reduces the phenomenon of red eyes caused by the light from the flash being reflected in the subject's eyes. The flash will discharge regardless of lighting conditions.



- The flash is off when the Capture mode is set to (Movie mode), Continuous Shooting, or Infinity-Landscape.
- The flash discharges a total of three times, two pre-flashes (It may look like one flash to your eye) and the third time to take the pictures. (In the red-eye reduction modes, the interval between the pre-flashes and the last flash is longer.)

1 Press the four-way controller (◀) in Capture mode.

The flash mode changes each time the button is pressed and the icon appears on the LCD monitor.

The camera is ready to take pictures in the selected flash mode.

Status of the Focus Status Lamp and Flash Status Lamp p.29

Saving the Flash Mode p.96



- Using the flash in Macro or Super Macro mode may cause the image to be overexposed.
- The shutter speed is slower when taking pictures of dark scenes using a flash in Night Scene mode. To prevent camera shake, secure the camera on a tripod or other surface.

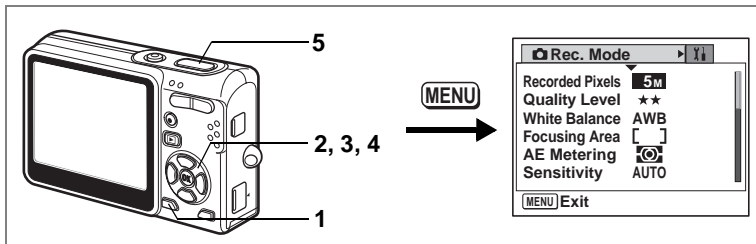

Selecting the Recorded Pixels

You can choose the number of recorded pixels from [5M], [4M], [3M], [2M], [1024] and [640].

The more pixels there are, the larger the picture and the bigger the file size. The data volume also varies depending on the quality level setting (p.78).

Number of Recorded Pixels

5M (2560×1920)	↑ Clear, Fine	Printing images with high-resolution settings in your printer,
4M (2304×1728)		Printing at A4 size or larger, Editing and processing images
3M (2048×1536)		
2M (1600×1200)		
1024 (1024×768)		Printing at postcard size
640 (640×480)		For use as images on websites, For attaching images to e-mail

1 Press the MENU button in Capture mode.

The [Rec.Mode] menu appears.

2 Use the four-way controller (▲▼) to select [Recorded Pixels].

3 Press the four-way controller (▶). The pull-down menu appears.

The pull-down menu appears.

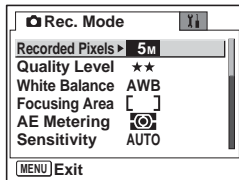

- 4 Use the four-way controller (▲▼) to change the recording pixels.
- 5 Press the shutter release button halfway.

The camera is ready to take the picture.

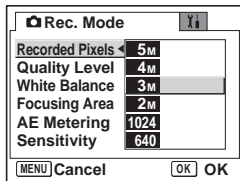

- The number of recorded pixels is fixed at 5M in the Green mode.
- The number of recorded pixels is fixed at 640×480 in the Movie mode.
- Selecting a large size produces a clear picture when it is printed out.
- The Recorded Pixels setting is saved when the camera is turned off.

Image Size and Quality ESP.p.23

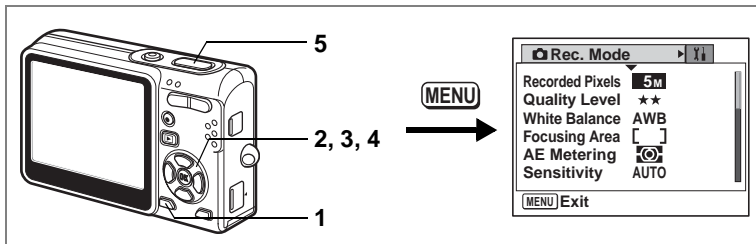

Selecting the Quality Level

You can choose the image compression ratio.

The more stars, the clearer the quality and the larger the volume. The Recorded Pixels setting also changes the picture volume (see p.76).

Quality Levels

★★★	Best	Lowest compression ratio. Suitable for photo prints.
★★	Better	Standard compression ratio. Suitable for viewing the image on a computer screen.
★	Good	Highest compression ratio. Suitable for attaching to e-mails or creating websites.

1 Press the MENU button in Capture mode.

The [Rec.Mode] menu appears.

2 Use the four-way controller (▲▼) to select [Quality Level].

3 Press the four-way controller (▶). The pull-down menu appears.

The pull-down menu appears.

4 Use the four-way controller (▲▼) to change the quality level.

5 Press the shutter release button halfway.

The camera is ready to take the picture.

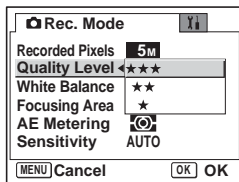
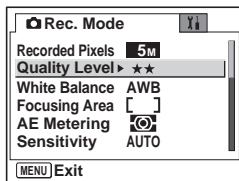



- The Quality Level setting is saved when the camera is turned off.
- The quality level is fixed at ★★ (Better) in the Green mode.

Image Size and Quality ESPp.23

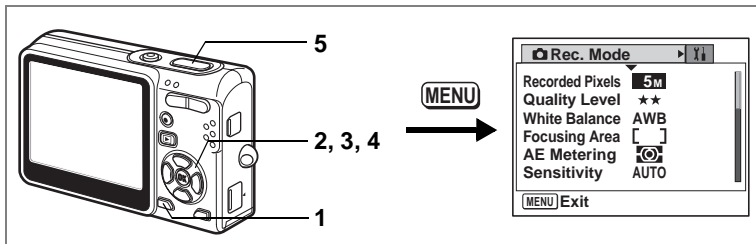

Adjusting the White Balance

You can select a white balance function best suited to the light conditions at the time of shooting. The Auto adjusts a white balance automatically and reproduces natural colors. The Manual allows you to decide a white balance based on the subject you want to make appear white. You can also choose other white balance functions to reproduce colors more accurately depending on the weather or a type of light source.

White Balance

AWB	Auto	The camera adjusts the white balance automatically.
	Daylight	Use this mode when taking pictures outside in sunlight.
	Cloudy	Use this mode when taking pictures under a cloudy sky.
	Shade	Use this mode when taking pictures outside in the shade.
	Tungsten Light	Use this mode when taking pictures under electric or other tungsten light.
	Fluorescent Light (Neutral White and White)	Use this mode when taking pictures under neutral white or white fluorescent light.
	Fluorescent Light (Daylight)	Use this mode when taking pictures under daylight fluorescent light.
	Manual	Use this mode when taking pictures by adjusting the white balance manually.

- 1 Press the MENU button in Capture mode.**
The [📷 Rec.Mode] menu appears.
- 2 Use the four-way controller (▲▼) to select [White Balance].**

3 Press the four-way controller (▶).

The White Balance screen appears.

4 Use the four-way controller (▲▼◀▶) to change the setting.

5 Press the shutter release button halfway.

The camera is ready to take the picture.

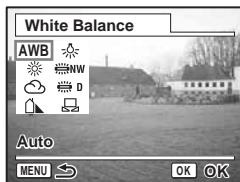

Saving the White Balance p.96

Manual Setting

Place a white material such as a piece of white paper in front of your camera to adjust white balance.

1 Select [Manual] (Manual) on the White Balance screen.

2 Point the camera at the white material so that it fills the screen.

3 Press the shutter release button fully.

The white balance is automatically adjusted. [Complete] appears on the LCD monitor.

4 Press the OK button.

The setting now adjusted is saved and the screen returns to the [Rec.Mode] menu.

5 Press the shutter release button halfway.

The camera is ready to take the picture.

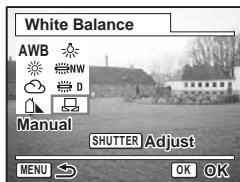

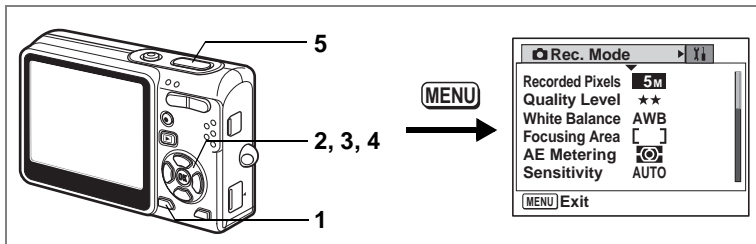

Changing the Focusing Area

You can change the autofocus area (Focusing Area).

Focusing Area

[]	Multiple	The camera measures a wide range in the center of the monitor (within the focusing area) and focuses on the nearest subject.
[]	Spot	The camera narrows a range (the focusing area) to measure and makes it easier for you to focus on a specific subject.

1 Press the MENU button in Capture mode.

The [📷 Rec.Mode] menu appears.

2 Use the four-way controller (▲▼) to select [Focusing Area].

3 Press the four-way controller (▶).

The pull-down menu appears.

4 Use the four-way controller (▲▼) to change the setting.

5 Press the shutter release button halfway.

The camera is ready to take the picture.

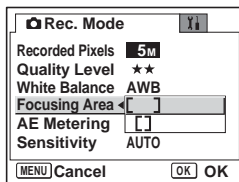

Saving the Focusing Area Setting p.96

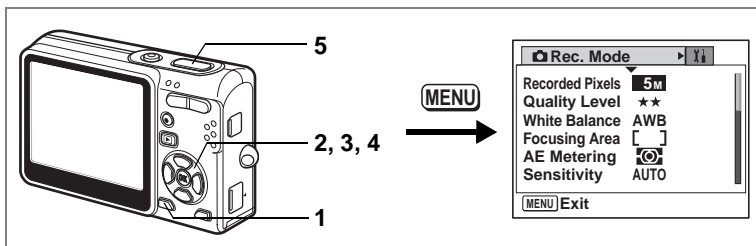

Setting the Light Metering Mode to Determine the Exposure

You can choose which part of the screen to use to measure the brightness and determine the exposure.

AE Metering Modes

	Multi-segment	The exposure is determined by the entire screen.
	Center-weighted	The exposure is determined mainly by the center of the screen.
	Spot	The exposure is determined by the small area in the center of the screen only.

1 Press the MENU button in Capture mode.

The [📷 Rec.Mode] menu appears.

2 Use the four-way controller (▲▼) to select [AE Metering].

3 Press the four-way controller (▶). The pull-down menu appears.

The pull-down menu appears.

4 Use the four-way controller (▲▼) to change the AE metering mode.

5 Press the shutter release button halfway.

The camera is ready to take the picture.

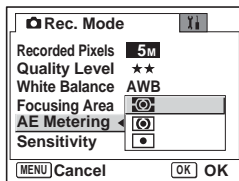
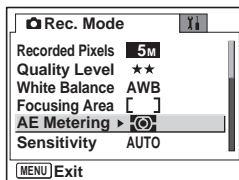



When is selected, the AE metering point moves in correspondence with movement of the focusing area. (p.74)

Saving the AE Metering Mode p.96

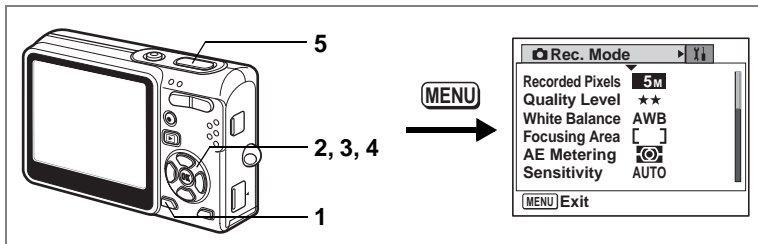

Setting the Sensitivity

You can select the sensitivity to suit the brightness of the surroundings.

Sensitivity

AUTO	The sensitivity is automatically set in the range from 80 to 200.
80	<ul style="list-style-type: none"> The lower the sensitivity (the lower values), the sharper the image and the less noise. The shutter speed will be slower in low light conditions. The higher the sensitivity (the higher values), the faster the shutter speed in low light conditions to reduce camera shake, but the image may be affected by noise.
100	
200	
400	

1 Press the MENU button in Capture mode.

The [Rec.Mode] menu appears.

2 Use the four-way controller (▲▼) to select [Sensitivity].

3 Press the four-way controller (▶).

The pull-down menu appears.

4 Use the four-way controller (▲▼) to change the sensitivity.

5 Press the shutter release button halfway.

The camera is ready to take the picture.

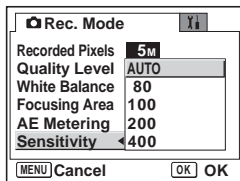
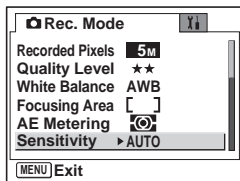

Saving the Sensitivity p.96

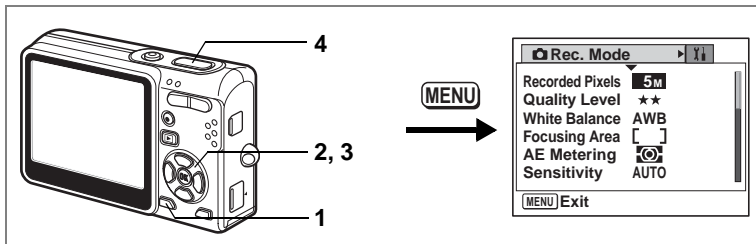

Setting the Exposure (EV Compensation)

You can adjust the overall brightness of the picture.

Use this function to take pictures that are intentionally overexposed or underexposed.

1 Press the MENU button in Capture mode.

The [📷 Rec.Mode] menu appears.

2 Use the four-way controller (▲▼) to select [EV Compensation].

3 Use the four-way controller (◀▶) to change the EV setting.

To brighten, set a positive (+) value. To darken, set a negative (-) value.

You can choose the EV setting in the range of -2.0 EV to +2.0 EV in 1/3 EV steps.

4 Press the shutter release button halfway.

The camera is ready to take the picture.

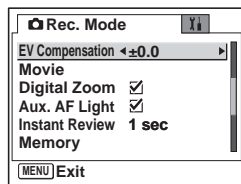

The AE metering mode is either center-weighted or spot when the EV setting is adjusted.

Saving the EV Compensation Value p.96

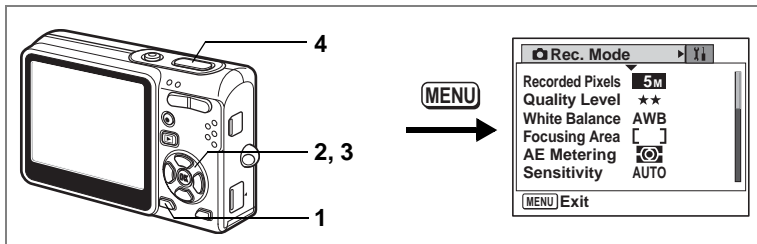

Setting the Auxiliary AF Light

The auxiliary AF light is convenient when you shoot a dark subject. The function helps you to focus on the subject under the conditions that the auto focus does not work properly.

1 Press the MENU button in Capture mode.

The [📷 Rec.Mode] menu appears.

2 Use the four-way controller (▲▼) to select [Aux. AF Light].

3 Use the four-way controller (◀▶) to select (On)/ (Off).

4 Press the shutter release button halfway.

The camera is ready to take the picture.

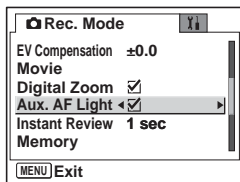

The auxiliary AF light of this camera conforms to the safety standard (IEC60825-1) for Class 1 LED product. Looking at the light directly will not create safety hazard. However, do not look into the emitter from a very short distance since you may feel dazzlingly.



The camera does not emit the auxiliary AF light under the following condition: the recording mode is set to (Movie), (Landscape) or (Sunset), or the focus mode is set to pan focus, infinity-landscape mode, manual focus, or focusing area.

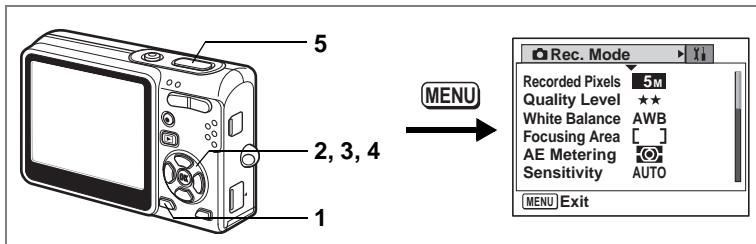

Setting the Instant Review Time

You can choose the Instant Review time from Off (no display), 0.5 sec., 1 sec., 3 sec., and 5 sec.

1 Press the MENU button in Capture mode.

The [Rec.Mode] menu appears.

2 Use the four-way controller (▲▼) to select [Instant Review].

3 Press the four-way controller (▶).

The pull-down menu appears.

4 Use the four-way controller (▲▼) to change the display time.

5 Press the shutter release button halfway.

The camera is ready to take the picture.

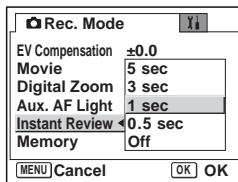
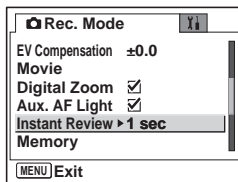

The Instant Review setting is saved when the camera is turned off.

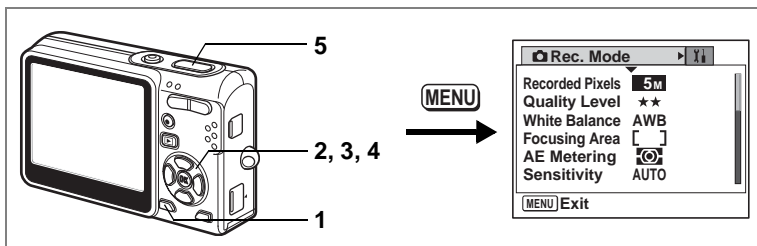

Setting the Color Mode (Color Mode)

You can choose the color from Full color, B & W and Sepia.

1 Press the MENU button in Capture mode.

The [📷 Rec.Mode] menu appears.

2 Use the four-way controller (▲▼) to select [Color Mode].

3 Press the four-way controller (▶). The pull-down menu appears.

The pull-down menu appears.

4 Use the four-way controller (▲▼) to change the Color mode.

5 Press the shutter release button halfway.

The camera is ready to take the picture.

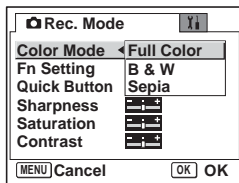
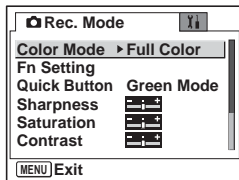

- You can set the Color mode both for still images and movies.
- When selecting the picture mode, the effect of the picture mode is based on the Color mode setting.

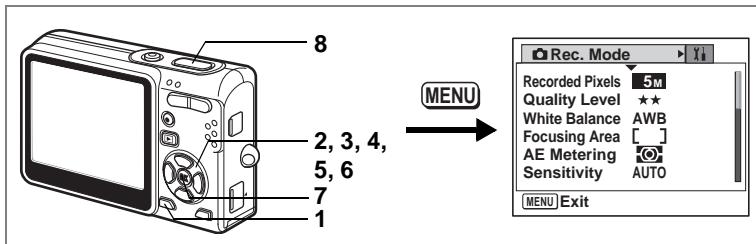

Registering Frequently Used Functions (Fn Setting)

You can register frequently used functions on the four-way controller. Using this function, you can directly set the functions by pressing the four-way controller without displaying the menu in Capture or Playback mode.

1 Press the MENU button in Capture mode.

The [📷 Rec.Mode] menu appears.

2 Use the four-way controller (▲▼) to select [Fn Setting].

3 Press the four-way controller (▶).

The Fn Setting screen appears.

4 Use the four-way controller (▲▼) to select a key you want to assign a function to.

5 Press the four-way controller (▶).

The pull-down menu appears.

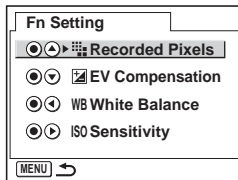
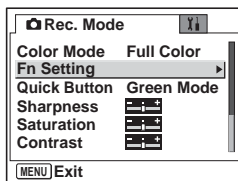

- 6 Use the four-way controller (▲▼) to select a function you want to assign.
- 7 Press the OK button.
- 8 Press the shutter release button halfway.

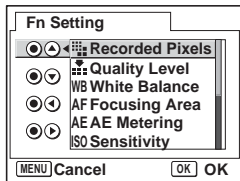

The camera is ready to take the picture.



This function is activated only when assigning the Fn Setting to the QUICK button.



- For the initial setting, the functions registered are as follows:
▲ (Recorded Pixels), ▼ (EV Compensation), ◀ (White Balance), and ▶ (Sensitivity).
- You can assign only one function to each key.
- The functions you can assign are as follows: Recorded Pixels, Quality Level, White Balance, Focusing Area, AE Metering, Sensitivity, EV Compensation, Sharpness, Saturation, Contrast, Off.

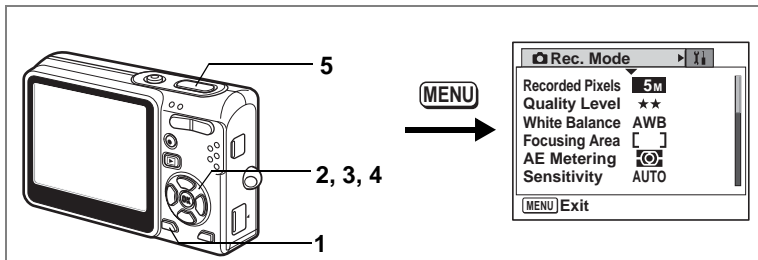

Setting the QUICK Button

You can register a function on the QUICK button. The function can be activated simply by pressing the QUICK button.

4

Taking Pictures

Registering a Function

1 Press the MENU button in Capture mode.

The [📷 Rec.Mode] menu appears.

2 Press the four-way controller (▲▼) to select [Quick Button].

3 Press the four-way controller (▶).

The pull-down menu appears.

4 Use the four-way controller (▲▼) to select the function you want to register.

5 Press the shutter release button halfway.

The camera is ready to take the picture.

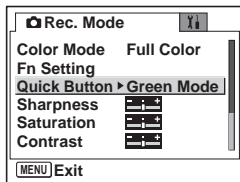

- For the initial setting, the Green Mode – for easy operation - is registered.
- You can assign only one function to the QUICK button. You can choose from the following three functions: Green Mode (p.49), Initialize Rec. Mode (p.99), and Fn Setting (p.90).

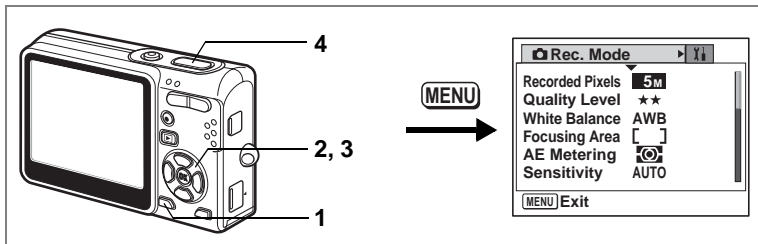

Setting the Image Sharpness

You can choose whether you want the image to have sharp or soft outlines.

1 Press the MENU button in Capture mode.

The [📷 Rec.Mode] menu appears.

2 Use the four-way controller (▲▼) to select [Sharpness].

3 Use the four-way controller (◀▶) to adjust sharpness.

To soften the contours, choose (-) and to sharpen the contours, choose (+).

4 Press the shutter release button halfway.

The camera is ready to take the picture.

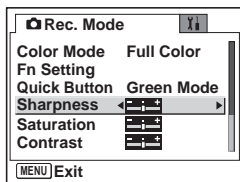

The Sharpness setting is saved when the camera is turned off.

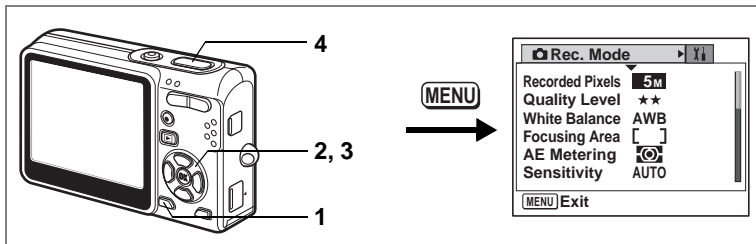

Setting the Color Saturation

You can set the color saturation.

1 Press the MENU button in Capture mode.

The [📷 Rec.Mode] menu appears.

2 Use the four-way controller (▲▼) to select [Saturation].

3 Use the four-way controller (◀▶) to adjust saturation.

To reduce the saturation, choose (-) and to increase the saturation, choose (+).

4 Press the shutter release button halfway.

The camera is ready to take the picture.

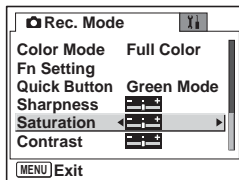

The Saturation setting is saved when the camera is turned off.

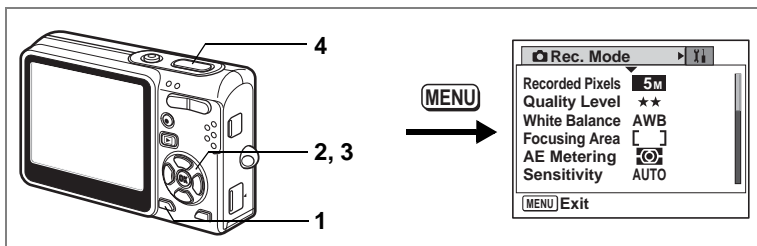

Setting the Image Contrast

You can set the image contrast.

1 Press the MENU button in Capture mode.

The [📷 Rec.Mode] menu appears.

2 Use the four-way controller (▲▼) to select [Contrast].

3 Use the four-way controller (◀▶) to adjust contrast.

To reduce the contrast, choose (-) and to increase the contrast, choose (+).

4 Press the shutter release button halfway.

The camera is ready to take the picture.

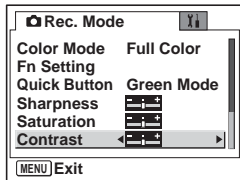











The Contrast setting is saved when the camera is turned off.

Saving the Settings

Saving the Menu Items (Memory)

You can choose whether you want the set values to be saved when the camera is turned off. If you select (On), the settings will be saved in the status they were in immediately before the camera was turned off. If you select (Off), the settings will be reset to the defaults when the camera is turned off.

Item	Description	Default Setting
Flash	The flash mode setting on the  button is saved.	<input checked="" type="checkbox"/>
Drive Mode	The drive mode setting ( , etc.) selected using the four-way controller () is saved.	<input type="checkbox"/>
Focus Mode	The focus mode setting on the  button is saved.	<input type="checkbox"/>
Zoom Position	The optical zoom position setting on the zoom button is saved.	<input type="checkbox"/>
MF Position	The manual focus position is saved.	<input type="checkbox"/>
White Balance	The [White Balance] setting on the [ Rec.Mode] menu is saved.	<input type="checkbox"/>
Focusing Area	The shifting position of [Focusing Area] setting on the [ Rec.Mode] menu is saved.	<input type="checkbox"/>
AE Metering	The [AE Metering] setting on the [ Rec.Mode] menu is saved.	<input type="checkbox"/>
Sensitivity	The [Sensitivity] setting on the [ Rec.Mode] menu is saved.	<input type="checkbox"/>
EV Compensation	The [EV Compensation] setting on the [ Rec.Mode] menu is saved.	<input type="checkbox"/>
Digital Zoom	The [Digital Zoom] setting (On/Off) on the [ Rec.Mode] menu is saved.	<input checked="" type="checkbox"/>
DISPLAY	The LCD monitor display mode is saved.	<input type="checkbox"/>
File #	The file number is saved. If a new SD Memory Card is inserted, file numbers are assigned sequentially.	<input checked="" type="checkbox"/>



- Menu items not included in [Memory] will also be saved in the settings selected on the menus for each function when the camera is turned off.
- The zoom position setting in the digital zoom range will not be saved even if [Zoom Position] is set to (On) in [Memory].

1 Press the MENU button in Capture mode.

The [Rec.Mode] menu appears.

2 Use the four-way controller (▲▼) to select [Memory].

3 Press the four-way controller (▶).

The [Memory] menu appears.

4 Use the four-way controller (▲▼) to choose an item.

5 Use the four-way controller (◀▶) to select (On) or (Off).

6 Press the shutter release button halfway.

The camera is ready to take the picture.

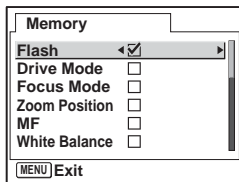
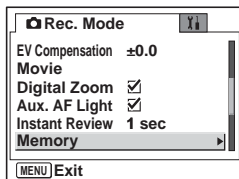





Registering Functions in User Mode

Functions set with the Capture mode on **USER** will be registered in User mode.

Functions Registered in User Mode

Items Registered in User Mode	Default Setting	Page
Flash mode	Auto	p.75
Drive mode	Single image	p.64
Focus mode	Autofocus	p.72
Zoom position	Wide angle	p.68
Manual focus position	Infinity	p.73
Changing the focusing area	Center	p.74
Shooting information display	Normal	p.46
Recorded Pixels	5M	p.76
Quality Level	★★	p.78
White balance	AWB (auto)	p.80
Focusing area	[] (Multiple)	p.82

Items Registered in User Mode	Default Setting	Page
AE metering	 (Multi-segment)	p.83
Sensitivity	AUTO	p.85
Sharpness	 (Normal)	p.93
Saturation	 (Normal)	p.94
Contrast	 (Normal)	p.95
EV compensation	±0.0	p.86
Aux. AF Light	<input checked="" type="checkbox"/> (On)	p.87
Color Mode	Full color	p.89



The settings of these items are memorized separately in User mode and Capture mode.

These settings are retained until [Reset] is selected in the [ Set-up] menu or the setting is cleared using the QUICK button.

Returning the Shooting Functions to the Default Settings

This function lets you return all the shooting function settings to the defaults.

All the items on the [Rec.Mode] menu and the settings for flash, drive, focus, and displayed information are reset.

For details on Rec. Mode menu, refer to “Menu List” (p.41).

1 Press the QUICK button in Capture mode.

The [Initialize Rec. Mode?] message appears.

2 Use the four-way controller (▲▼) to select [Initialize].

3 Press the OK button.

All the shooting function settings return to the defaults and the camera returns to Capture mode.

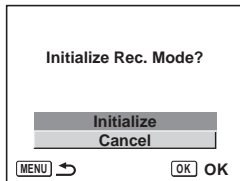

- The settings registered in User mode return to the default.
- This function cannot be used when assigning a function other than Initialize Rec. Mode to the QUICK button. (p.92)

Recording Sound (Voice Recording Mode)

You can record sound. The recordable time appears on the LCD monitor according to how much space is available on the SD Memory Card.

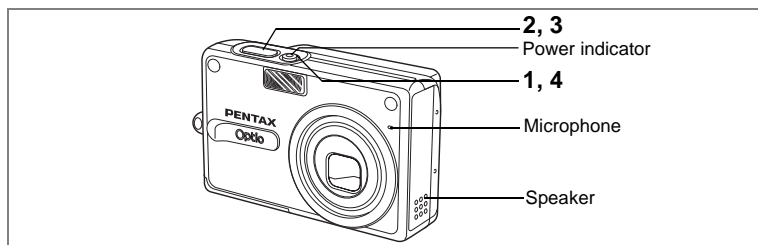

1 Press the power switch for more than two seconds, or press the power switch while pressing the OK button.

The power indicator lights red.

The recordable time appears on the LCD monitor.

1 Remaining recordable time

2 Recording time



2 Press the shutter release button.

Recording starts. The flash status lamp lights during recording.

When the shutter release button is pressed for more than one second, recording continues for as long as the button is held down and stops when the button is released.

3 Press the shutter release button.

Recording stops. The remaining recordable time appears.

4 To exit Voice Recording mode, turn the camera off.





- When you press the power switch, the lens extends, then retracts immediately and the camera enters the Voice Recording mode.
- Sound is saved in WAVE monaural files.
- The microphone is located on the front of the camera. Aim the camera to obtain the best sound.
- An index can be added by pressing the MENU button during recording.

Playing Back Sound

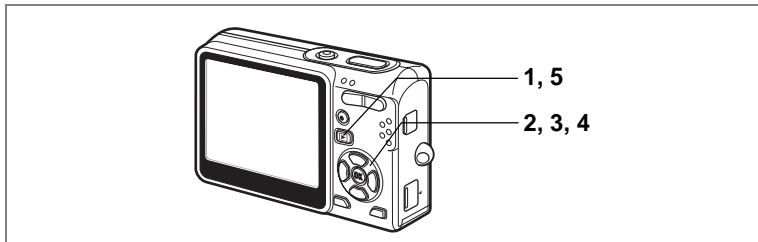
You can play back the recording you made in Voice Recording mode.



1 Press the  **Playback button** in the Voice Recording mode.

2 Use the four-way controller ( ) to choose the recording to play back.

3 Press the four-way controller () . Playback starts.



Length of recording

• **The following operations can be performed during playback.**

Four-way controller () Pauses playback
Press again to resume playback

If there are no recorded indexes:

Four-way controller () Rewinds about five seconds

Four-way controller () Advances about five seconds

If there are recorded indexes:

Four-way controller () Plays back starting from the previous index

Four-way controller () Plays back starting from the next index

Zoom button () Increases the volume

Zoom button () Reduces the volume

4 Press the four-way controller () .

Playback stops.

5 Press the  **Playback button**.

The camera switches to the Voice Recording mode.



If you entered the Playback mode from Capture mode, the camera will switch to Capture mode in Step 5. To continue recording, turn the camera off, then turn it on again in the Voice Recording mode. (p.33)

Adding a Voice Memo

You can add a voice memo to a captured image.

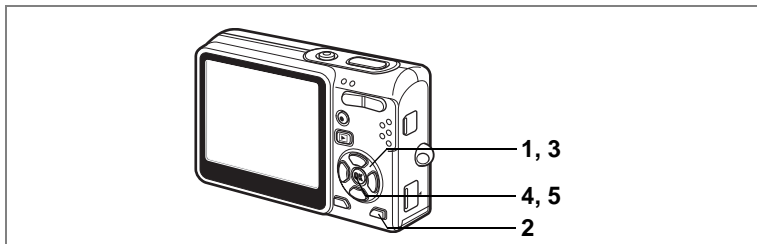

Recording a Voice Memo

1 Enter the Playback mode and use the four-way controller (◀▶) to choose the image to which you want to add a voice memo.

2 Press the MODE button.

The Mode Palette appears.

3 Use the four-way controller (▲▼◀▶) to select  (Voice Memo).

4 Press the OK button.

Recording starts. You can record for up to 30 seconds.

5 Press the OK button.

Recording stops.

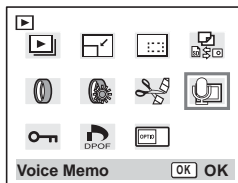

-  appears on the screen when a voice memo is added.
- A voice memo cannot be added to an image which already has a voice memo. Delete the old voice memo and record a new one. (p.112)



A voice memo cannot be added to protected () images.

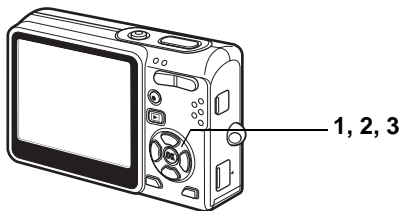

Playing Back a Voice Memo

- 1 Enter the Playback mode and use the four-way controller (◀▶) to choose the still picture with the voice memo that you want to play back.**

If  appears on the displayed image, a voice memo has been recorded.



- 2 Press the four-way controller (▲).**
Playback starts.

The following operations can be performed during playback.

Zoom button (▲) Increases the volume

Zoom button (▼) Reduces the volume

- 3 Press the four-way controller (▼).**
Playback stops.

Deleting Voice Memos Only  p.112

Playing Back Images

You can play back images recorded on the SD Memory Card when a card is inserted in the camera, or in the built-in memory when no card is inserted.

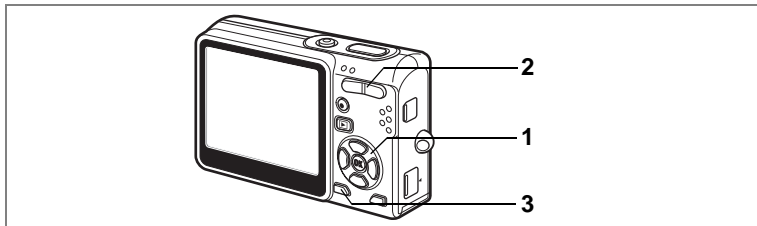

Playing Back Still Pictures

Press the  Playback button.

Refer to “Playing Back an Image” (p.30), or “Playing Back the Previous or Next Image” (p.30) for instructions on playing back images.

6

Playback/Deleting/Editing

Zoom Display

You can display images magnified up to eight times. A guide to operation appears on the LCD monitor during magnification.

1 Enter the Playback mode and use the four-way controller (◀▶) to choose the image to magnify.

2 Press  /  on the zoom button.

Each time you press the button, the zoom scaling changes as follows: 1.3x, 2.0x, 2.6x, 4.0x, 5.3x, 8.0x.

- **The following operations can be performed while the magnified image is displayed.**

Four-way controller (▲▼◀▶) Moves the position to be magnified

Zoom button (▲) Makes the image bigger

Zoom button (▼) Makes the image smaller

OK button Turns the guide marks on/off



3 Press the MENU button.

Zoom playback ends.

Setting the Quick Zoom Function

You can display the image at specified magnification simply by pressing $\blacktriangle/\blacktriangledown$ on the zoom button once during zoom playback.

1 Press the MENU button in Playback mode.

The [Yi Set-up] menu appears.

2 Use the four-way controller ($\blacktriangle/\blacktriangledown$) to select [Quick Zoom].

3 Press the four-way controller (\blacktriangleright).

The pull-down menu appears.

4 Use the four-way controller ($\blacktriangle/\blacktriangledown$) to select the desired zoom scale.

5 Press the shutter release button halfway.

The camera is ready to take the picture.

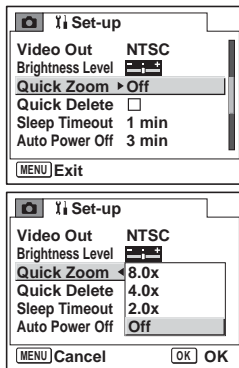

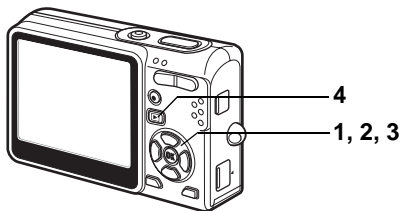

Playing Back Movies

You can play back movies. A guide to operation appears on the LCD monitor during playback. Operations include playback, frame by frame playback (forward or reverse), pause and volume adjustment.

1 Enter the Playback mode and use the four-way controller (◀▶) to choose the movie to play back.

2 Press the four-way controller (▲).

Playback starts.

- **The following operations can be performed during playback.**

Four-way controller (◀) Fast-rewind playback

Four-way controller (▶) Fast-forward playback

Four-way controller (▲) Pause

OK button

Changes the display mode (esp.p.108)

Zoom button ▲▲▲/▲

Adjusts the volume

- **The following operations can be performed while pause is engaged.**

Four-way controller (◀) Frame reverse (fast-rewind by 30 frames)

Four-way controller (▶) Frame forward (fast-forward by 30 frames)

Four-way controller (▲) Releases the pause function

OK button

Changes the display mode (esp.p.108)



3 Press the four-way controller (▼).

Playback stops and the screen returns to the first frame.

4 Press the [▶] Playback button.

The camera returns to Capture mode.



No sound is output during fast-rewind and fast-forward playback.

Magnifying a Paused Movie

You can display a paused movie magnified up to four times.

1 Enter the Playback mode and use the four-way controller (◀▶) to choose the movie to play back.

2 Press the four-way controller (▲).

Playback starts.

3 Press the four-way controller (▲) on the scene you wish to magnify.

The movie is paused.

4 Press ▲/Q on the zoom button.

Each time you press the button, the image is enlarged (up to four times).



- **The following operations can be performed during playback.**
 - Four-way controller (▲▼◀▶) Moves the position to be magnified
 - Zoom button (▲) Makes the image bigger
 - Zoom button (◆◆◆) Makes the image smaller

5 Press the OK button.

6 Press the four-way controller (▲).

You can playback the movie after having it enlarged.

Displaying Shooting Information in Playback Mode

Shooting information can be displayed on the LCD monitor in Playback mode. Pressing the OK button changes the display mode.

Normal Display

Shooting information is displayed.

- 1 Voice Memo icon
- 2 Card/Built-in memory icon
- 3 Folder name
- 4 File name
- 5 Protect icon
- 6 Battery indicator
- 7 Shooting date and time
- 8 Four-way controller operation guide



Histogram Display

The brightness distribution of the image is displayed. The horizontal axis shows the brightness (darkest at the left end and brightest at the right end) and the vertical axis shows the number of pixels.

- 1 Recorded pixels
- 2 Quality level
- 3 White balance
- 4 AE metering
- 5 Sensitivity
- 6 Histogram
- 7 Aperture
- 8 Shutter speed

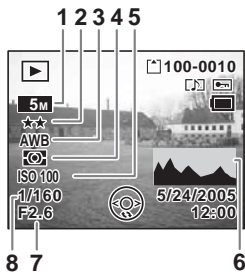

No icons

No shooting information is displayed.



Normal Display

Saving the Display Mode p.96

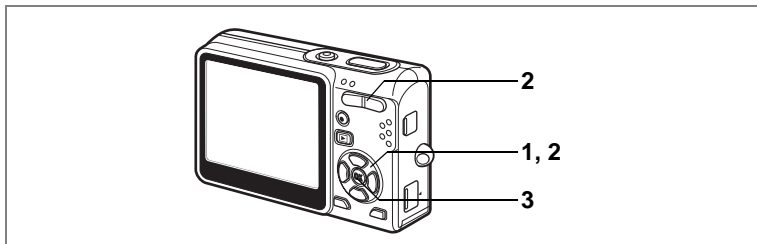

Nine-Image Display

You can display nine images at the same time.

- 1 Enter the Playback mode and use the four-way controller (◀▶) to choose an image.**
- 2 Press ▲▲▲/📷 on the zoom button.**

A page consisting of nine thumbnail images appears. The displayed images change nine at a time page by page.

Use the four-way controller (▲▼◀▶) to move the frame. When ten or more images have been saved, if you choose an upper-left image and press the four-way controller (◀), the previous page appears. Similarly, if you choose a lower-right image and press the four-way controller (▶), the next page appears.

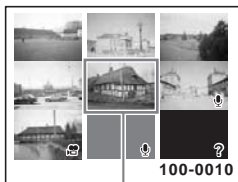

The icons that appear on the images indicate the following:

- No icon : Still picture without voice memo
- 📷 (with image) : Still picture with voice memo
- 🎬 : Movie (first frame appears)
- 🔊 (without image) : Sound file only
- ❓ : Undisplayable image

- 3 Press the OK button.**

The screen returns to full screen display of the selected image.



Pressing the MENU button, OK button or ▲/🔍 on the zoom button returns the screen to full screen display of the selected image.

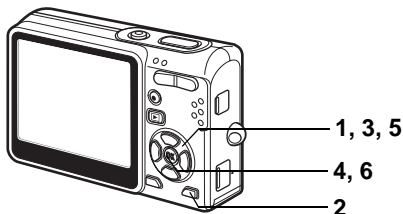

Slideshow

You can play back all the images on the SD Memory Card or in the built-in memory continuously.

1 Enter the Playback mode and use the four-way controller (◀▶) to choose the image with which to start the slideshow.

2 Press the MODE button.

The Mode Palette appears.

3 Use the four-way controller (▲▼◀▶) to select  (Slideshow).

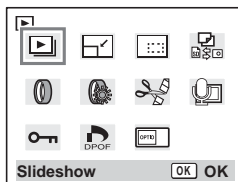

4 Press the OK button.

5 Use the four-way controller (◀▶) to change the playback interval.

Choose from the following: [1 sec], [3 sec], [5 sec], [10 sec], [20 sec], [30 sec].

6 Press the OK button.

[Start] appears on the LCD monitor and playback starts at the set interval. Press any button, such as the OK button or MENU button, to stop the slideshow. [Stop] appears on the LCD monitor.



- The slideshow will continue until you press any button.
- Movies and pictures with a voice memo will be played through to the end before the next picture is played back, regardless of the set playback interval.
- Recordings made in Voice Recording mode are not played back.

Deleting Images, Movies and Sounds

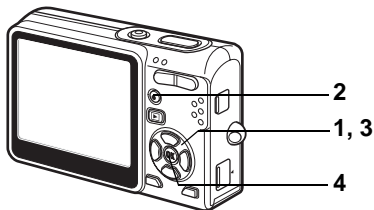

Deleting a Single Image, Movie or Sound

You can delete a single image, movie or sound.



Once deleted, images, movies or sounds cannot be restored.

- 1 Enter the Playback mode and use the four-way controller (◀▶) to choose the image, movie or sound to delete.**
- 2 Press the QUICK button.**
The Delete screen appears.
- 3 Use the four-way controller (▲) to select [Delete].**
- 4 Press the OK button.**
The image, movie or sound is deleted.



- You can also delete images from Instant Review (p.88).
- You cannot delete protected (🔒) images, movies or sounds. (p.114)
- If [Quick Delete] is set to On in the [🔧 Set-up] menu, Step 3 can be omitted. (p.112)

Deleting a Voice Memo only

If an image has a voice memo, you can delete the voice memo without deleting the image.

- 1 Enter the Playback mode and use the four-way controller (◀▶) to choose an image with a voice memo to delete.**
- 2 Press the QUICK button.**
The Delete screen appears.
- 3 Use the four-way controller (▲) to select [Delete sound].**
- 4 Press the OK button.**
The voice memo is deleted.

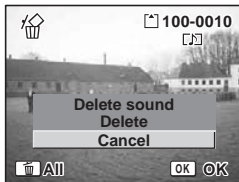

Select [Delete] in Step 3 above to delete both the image and the voice memo.

6 Setting the Quick Delete Function

When the Quick Delete function is set to On, the Delete screen appears with [Delete] already selected.

- 1 Press the MENU button in Playback mode.**
The [⌘] Set-up] menu appears.
- 2 Use the four-way controller (▲▼) to select [Quick Delete].**
- 3 Use the four-way controller (◀▶) to select (On)/ (Off).**
- 4 Press the shutter release button halfway.**
The camera is ready to take pictures.

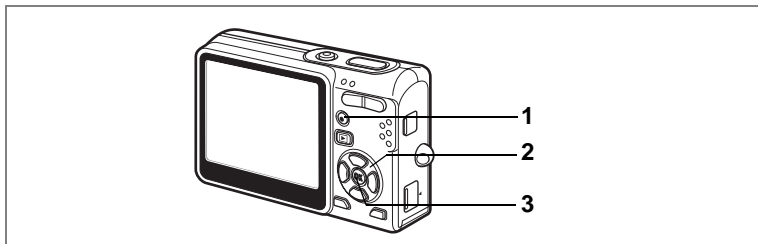

Deleting All Images

You can delete all the images, movies and sounds at once.



Once deleted, images, movies or sounds cannot be restored.

- 1 Enter the Playback mode and press the QUICK button twice.**
The Delete All screen appears.
- 2 Use the four-way controller (▲) to select [Delete all].**
- 3 Press the OK button.**



All the images and sounds will be deleted.



You cannot delete protected (🔒) images, movies or sounds.
(p.114)

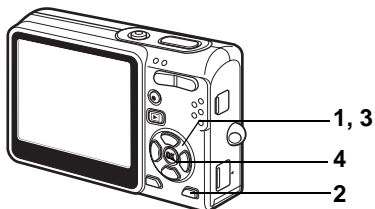

Protecting Images, Movies and Sounds from Deletion (Protect)

You can protect images, movies and sounds from being accidentally deleted.

- 1** Enter the Playback mode and use the four-way controller (◀▶) to choose the image, movie or sound to protect.
- 2** Press the MODE button.
The Mode Palette appears.
- 3** Use the four-way controller (▲▼◀▶) to select  (Protect).
- 4** Press the OK button.
The Protect screen appears.

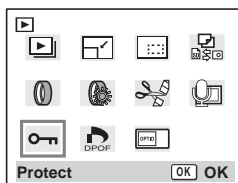

Protecting Images, Movies and Sounds

- 5** Use the four-way controller (▲▼) to select [Select Image and Sound].
- 6** Press the OK button.

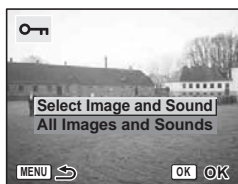

- 7 Use the four-way controller (▲▼) to select [Protect].
- 8 Press the OK button.

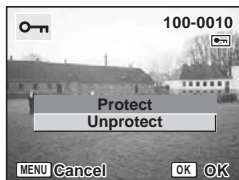

- Select [Unprotect] in Step 7 to cancel the Protect setting.
- If the image is protected, the key icon appears when the image, movie or sound is played back.

Protecting All Images, movies and Sounds

You can protect all the images, movies and sounds.

- 5 Use the four-way controller (▲▼) to select [All Images and Sounds].
- 6 Press the OK button.

The [Protect all images & sounds] message appears.



- 7 Use the four-way controller (▲▼) to select [Protect].
- 8 Press the OK button.



Select [Unprotect] in Step 7 to cancel the Protect setting on all the images, movies and sounds.



Even protected images, movies and sounds will be deleted by formatting the SD Memory Card or built-in memory.

Viewing Images on a TV

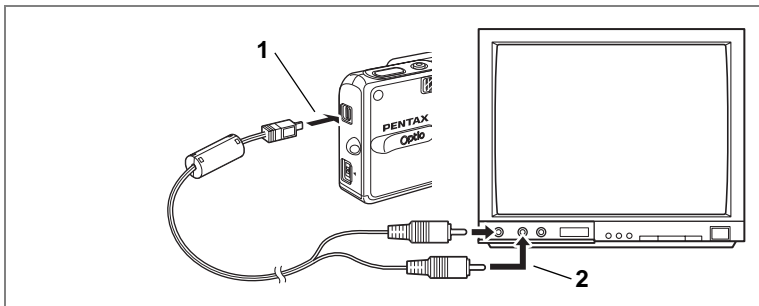

By using the AV cable, you can capture and play back images on a TV or other equipment with a video IN jack. Make sure that both the TV and the camera are turned off before connecting the cable.

- 1 Open the terminal cover and connect the AV cable.**
- 2 Connect the other end of the AV cable to the image input terminal and sound input terminal on the TV.**

When using stereo sound equipment, insert the sound terminal into the L (white) terminal.

- 3 Turn the TV and camera on.**

Changing the Video Output Format  p.146



- If you intend to use the camera for a long time, use of the AC adapter D-AC8 (optional) is recommended. Refer to the operating manual for the TV or equipment to which the camera is connected.
- To view images on a TV with several video inputs, display on it the video input connected to the camera, referring to the operating manual for the TV.
- While the camera is connected to the TV, the LCD monitor of the camera will be turned off.

Playing Back an Image Using the Remote Control Unit (optional)

When the AV cable is connected to the camera, the image can be displayed using the remote control unit E or F (optional).

- 1 Press the  Playback button.**
- 2 Press the Shutter button or the zoom button of the remote control unit.**

Shutter button: displays the next image.

Zoom button: displays the previous image.



- As there is no zoom button on the remote control unit F, only an operation using the shutter button (displaying the next image) is available.
- You cannot play back movies, images with a voice memo, and voice files recorded in Voice Recording mode, using the remote control unit.

Setting the Printing Service (DPOF)

You can print the images on the SD Memory Card using a DPOF (Digital Print Order Format) compatible printer or at a printing service.

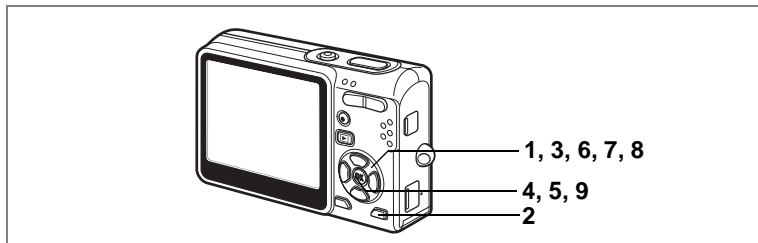

Printing Single Images

Set the following items for each image.

Copies: Choose the number of copies up to a maximum of 99.

Date: Specify whether you want the date imprinted on the print or not.

6

Playback/Deleting/Editing

- 1 Enter the Playback mode and use the four-way controller (◀▶) to choose the image to print.**
- 2 Press the MODE button.**
The Mode Palette appears.
- 3 Use the four-way controller (▲▼◀▶) to select  (DPOF).**
- 4 Press the OK button.**
The DPOF screen appears.
- 5 Press the OK button.**

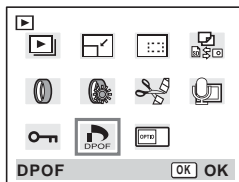

- 6 Use the four-way controller (◀▶) to choose the number of copies.
- 7 Use the four-way controller (▼) to select [Date].



- 8 Use the four-way controller (◀▶) to choose whether to insert the date or not.

- (On): The date will be imprinted.
- (Off): The date will not be imprinted.

- 9 Press the OK button.

Prints can be made according to the settings.

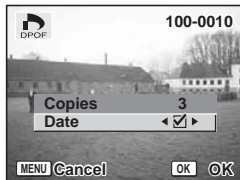

- If DPOF settings have already been made for an image, the previous number of copies and date setting will be displayed.
- To cancel DPOF settings, set the number of copies to 0 and press the OK button.



- You cannot set the printing service for movies or sound-only files.
- Depending on the printer or printing equipment at the photo processing lab., the date may not be imprinted on the pictures even if the DPOF settings were made.

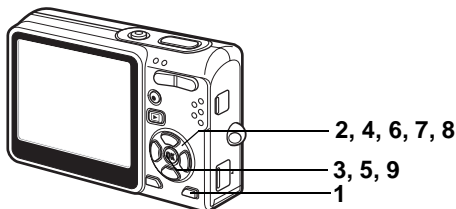

Printing All Images

- 1** Enter the Playback mode and press the MODE button.
The Mode Palette appears.
- 2** Use the four-way controller (▲▼◀▶) to select  (DPOF).
- 3** Press the OK button.
- 4** Use the four-way controller (▼) to select [All Images].
- 5** Press the OK button.
- 6** Use the four-way controller (◀▶) to choose the number of copies.
You can print up to 99 copies.
- 7** Use the four-way controller (▼) to select [Date].
- 8** Use the four-way controller (◀▶) to choose whether to insert the date or not.
 (On): The date will be imprinted.
 (Off): The date will not be imprinted.
- 9** Press the OK button.

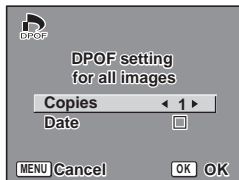

Prints can be made according to the settings.



The number of copies specified in the DPOF settings applies to all the images. Before printing, check that the number is correct.



- Settings for single images are cancelled when settings are made for all images.
- DPOF settings are not possible for movies.

Direct Printing Using PictBridge

By connecting the camera to a printer that supports PictBridge using the USB cable (I-USB17) supplied with the camera, you can print images directly from the camera without using a PC. Select the images you want to print and the number of copies on the camera after it has been connected to the printer.



- You are recommended to use the AC adapter D-AC8 (optional) while the camera is connected to the printer. The printer may not work properly or the image data may be damaged if the battery runs out of power while the camera is connected to the printer.
- The focus status lamp and flash status lamp blink slowly while data is being transferred from the camera to the printer.
- Do not disconnect the USB cable during data transfer.
- Depending on the type of printer, not all the settings made on the camera (such as DPOF settings) may be valid.

Connecting the Camera to the Printer

1 Select **[PictBridge]** for **[USB Connection]** on the **[Setup]** menu.

“Changing the USB Connection Mode” (p.146)

2 Connect the camera to the printer using the USB cable supplied with the camera.

The PictBridge menu appears.

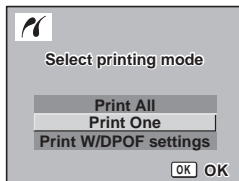

Printing Single Images

1 Use the four-way controller (▲▼) to select [Print One].

2 Press the OK button.

The Print this image screen appears.

3 Use the four-way controller (◀▶) to choose the image to print.

4 Use the four-way controller (▲▼) to choose the number of copies.

You can print up to 99 copies.

5 Use the QUICK button to choose whether to insert the date or not.

(On): The date will be imprinted.

(Off): The date will not be imprinted.

6 Press the OK button.

The print settings confirmation screen appears.

To print the image according to the print settings, press the OK button.

To change the print settings, go to Step 7.

7 Press the QUICK button.

The Change setting screen appears.

8 Use the four-way controller (▲▼) to select [Paper size].

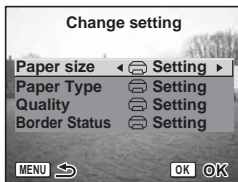
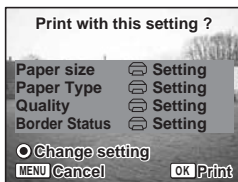
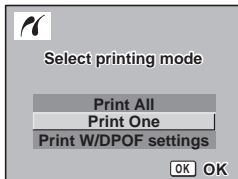

9 Use the four-way controller (◀▶) to choose the paper size.

You can choose the print size from among 12 sizes: [Printer Setting] Setting (printer setting), Card, L, 2L, Postcard, 100×150, 4"×6", 8"×10", Letter, 11"×17", A4, or A3.

You cannot select a size that is not available with the printer you are using.

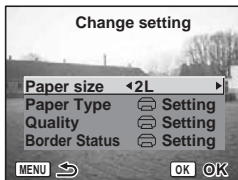

10 Repeat Steps 7 to 8 to set [Paper Type] [Quality] and [Border Status].

When the Paper Size is set to [Printer Setting] Setting, images are printed according to the printer settings.

Paper Type with more ★ support higher quality paper.

Quality with more ★ indicate higher print quality.

11 Press the OK button twice.

The image is printed according to the settings.

Press the MENU button to cancel printing.

Printing All Images

1 Use the four-way controller (▲▼) to select [Print All].

2 Press the OK button.

The Print All screen appears.

Use the four-way controller (◀▶) to check the images and make sure you want to print them all.

3 Set the number of copies, the setting of the date imprint, and confirm the print setting.

To set these items, refer to Steps 4 to 11 on "Printing Single Images" (pages 122 to 123).

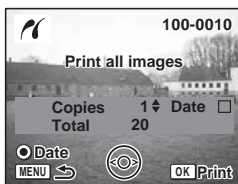

Printing Using the DPOF Settings

1 Use the four-way controller (▲▼) to select [Print W/DPOF settings].

2 Press the OK button.

The Print W/DPOF Settings screen appears.

Use the four-way controller (◀▶) to check the images and the print settings.

3 Set the number of copies, the setting of the date imprint, and confirm the print setting.

To set these items, refer to Steps 4 to 11 on “Printing Single Images” (pages 122 to 123).

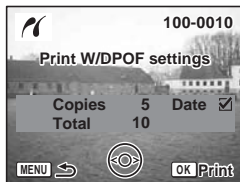

Disconnecting the Camera from the Printer

Disconnect the camera from the printer when you have finished printing.

1 Turn the camera off.

2 Disconnect the USB cable from the camera.

3 Disconnect the USB cable from the printer.



When you disconnect the USB cable from the camera before you turn the camera off, the camera returns to Playback mode.

Editing Images

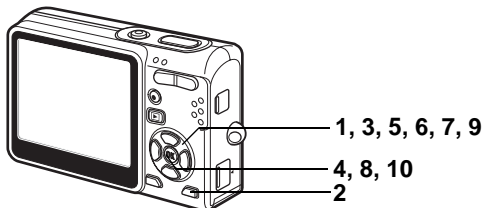

Changing the Image Size and Quality

By changing the size and quality of a selected image, you can make the file smaller than the original. You can use this function to continue taking pictures when the card or memory is full, by making the images smaller and overwriting the original images to make more space available in the memory.

Resizing Single Images

After changing the size and quality, the image can be saved as a new image or written over the original image.

- 1 Use the four-way controller (◀▶) in Playback mode to select an image to resize.**
- 2 Press the MODE button.**
The Mode Palette appears.
- 3 Use the four-way controller (▲▼◀▶) to select  (Resize).**
- 4 Press the OK button.**
The Resize screen appears.

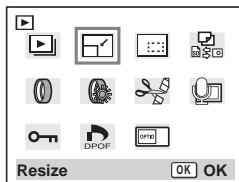

5 Use the four-way controller (◀▶) to change the size.

6 Press the four-way controller (▼).
The frame moves to [Quality Level].

7 Use the four-way controller (◀▶) to change the quality.

8 Press the OK button.

9 Use the four-way controller (▲▼) to select [Overwrite] or [Save as].

10 Press the OK button.

The resized image is saved.

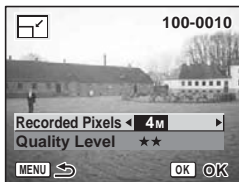

- Movies cannot be resized.
- You cannot select a larger size than that of the original image.
- Protected (🔒) images cannot be overwritten.

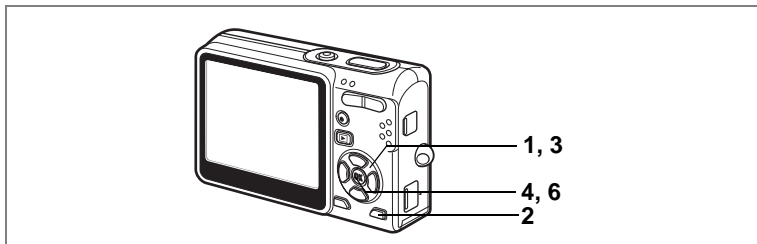

Trimming Images

You can trim a part of a picture and save it as a separate image.

1 Use the four-way controller (◀▶) in Playback mode to select an image to trim.

2 Press the MODE button.

The Mode Palette appears.

3 Use the four-way controller (▲▼◀▶) to select  (Trimming).

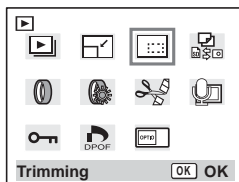

4 Press the OK button.

The Trimming screen appears.

5 Trim the image.

• **Operations that can be performed on the Trimming screen**

Zoom button: Changes the size of the trimming

Four-way controller (▲▼◀▶): Moves the trimming position up, down, left and right

MENU button: Returns to the screen for selecting an image

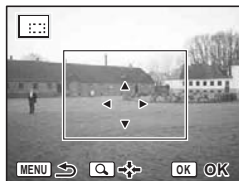

6 Press the OK button.

The trimmed image is saved as a separate image.

• Movies cannot be trimmed.

The image size is changed and saved.



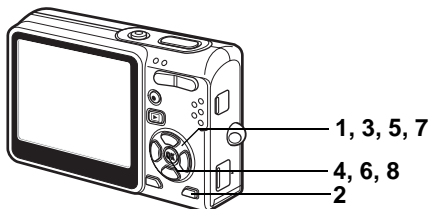

Editing Pictures with Color Filters

This function enables you to edit still pictures with color filters. You can choose from eight filters: B&W, Sepia, Red, Pink, Purple, Blue, Green and Yellow.

- 1 Use the four-way controller (◀▶) in Playback mode to select an image to edit.**
- 2 Press the MODE button.**
The Mode Palette appears.
- 3 Use the four-way controller (▲▼◀▶) to select  (Color Filter).**

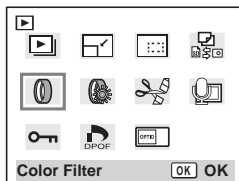

- 4 Press the OK button.**
The color filter screen appears.
- 5 Use the four-way controller (▲▼) to choose a color.**
- 6 Press the OK button.**



- 7 Use the four-way controller (▲▼) to select [Overwrite] or [Save as].**
- 8 Press the OK button.**

The edited image is saved with the same number of recorded pixels and quality level as the original.

Download from [Www.Somanuals.com](http://www.Somanuals.com). All Manuals Search And Download.

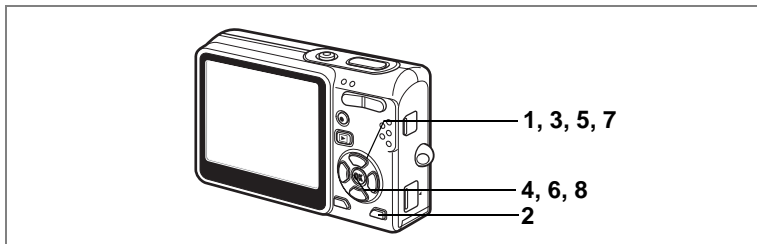

Editing Pictures with Brightness Filter

This function enables you to adjust the brightness of still pictures with the brightness filter.

1 Use the four-way controller (◀▶) in Playback mode to choose an image to edit.

2 Press the MODE button.

The Mode Palette appears.

3 Use the four-way controller (▲▼◀▶) to select  (Brightness Filter).

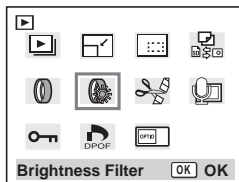

4 Press the OK button.

The brightness filter screen appears.

5 Use the four-way controller (◀▶) to adjust the brightness.

Each time you press the four-way controller (▶), the image becomes brighter step by step and each time you press the four-way controller (◀), the image becomes darker step by step. The brightness is selected between -2.0EV and +2.0EV by 1/3EV step.



6 Press the OK button.

7 Use the four-way controller (▲▼) to select [Overwrite] or [Save as].

8 Press the OK button.

The edited image is saved with the same number of recorded pixels and quality level as the original.

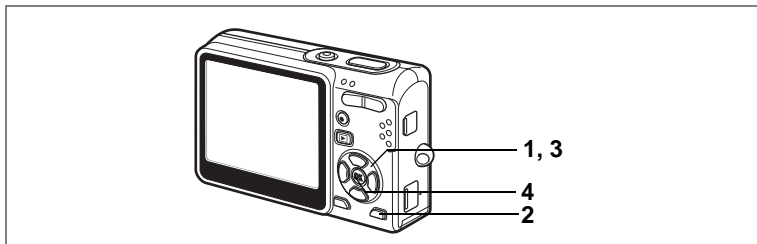

Editing Movies

You can select a frame from a recorded movie to save as a still picture, divide a movie into two or cut-and-stitch movies together.

You cannot edit a movie unless the original movie lasts more than five seconds.

1 Use the four-way controller (◀▶) in Playback mode to select a movie to edit.

2 Press the MODE button.

The Mode Palette appears.

3 Use the four-way controller (▲▼◀▶) to select  (Movie Edit).

4 Press the OK button.

The Movie Edit screen appears. Choose the editing function that you want to use.

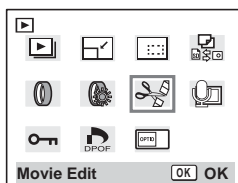

Saving a Frame from a Movie as a Still Picture

5 Use the four-way controller (▲▼) to select [Save as Still image].

6 Press the OK button.

The screen for choosing a frame appears.

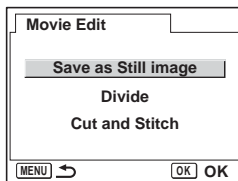

7 Use the four-way controller (◀▶) to choose the frame you want to save.

8 Press the OK button.

The selected frame is saved as a still picture.

9 Press the MENU button.

The screen returns to the Movie Edit screen.



Dividing a Movie

5 Select [Divide] on the Movie Edit screen.

6 Press the OK button.

The screen for choosing the dividing position appears.

7 Use the four-way controller (▲▼◀▶) to determine the dividing position.

▲ :Plays the movie

▼ :Stops the movie

◀ :Reverses the movie frame by frame

▶ :Advances the movie frame by frame

8 Press the OK button.

The confirmation screen appears.

9 Use the four-way controller (▲▼) to select [Divide].

10 Press the OK button.

The movie is divided at the specified position and the two portions are saved as separate files.

11 Press the MENU button.

The screen returns to the Movie Edit screen.

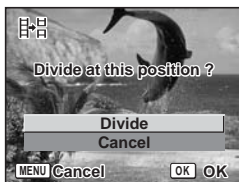

Cutting and Stitching Movies

5 Select [Cut and Stitch] on the Movie Edit screen.

6 Press the OK button.

The screen for choosing a start point to erase appears.

7 Use the four-way controller (◀▶) to choose the start point.

8 Press the OK button.

9 Use the four-way controller (◀▶) to choose the end point.

10 Press the OK button.

11 Use the four-way controller (▲▼) to select [Overwrite] or [Save as].

12 Press the OK button.

The movie cut and stitched is saved.



Copying Files

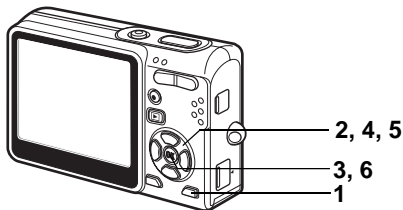

You can copy image and sound files from the built-in memory to the SD Memory Card and vice versa. This function can only be selected when a card has been inserted in the camera.

When files are copied from the built-in memory to the SD Memory Card, all the files are copied at once. When files are copied from the SD Memory Card to the built-in memory, the files are copied one at a time.

1 Press the **MODE** button in Playback mode.

The Mode Palette appears.

2 Use the four-way controller (**▲▼◀▶**) to select (Copy image and sound).

The Copy image and sound screen appears. Choose the copying method you want to use.

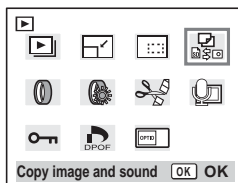

3 Press the **OK** button.



Be sure to turn the camera off before inserting or removing the SD Memory Card.

To Copy Files from the Built-in Memory to the SD Memory Card

- 4** Use the four-way controller (▲▼) to select [📷 → SD] and press the OK button.

All the files are copied to the SD Memory Card.

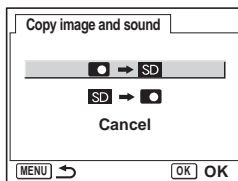

To Copy Files from the SD Memory Card to the Built-in Memory

- 4** Use the four-way controller (▲▼) to select [SD → 📷] and press the OK button.
- 5** Use the four-way controller (◀▶) to select the file to copy.
- 6** Press the OK button.

The selected file is copied to the built-in memory.



- If the image has a voice memo, the sound file will be copied at the same time as the image.
- When a file is copied from the SD Memory Card to the built-in memory, it is assigned a new file name.

Camera Settings

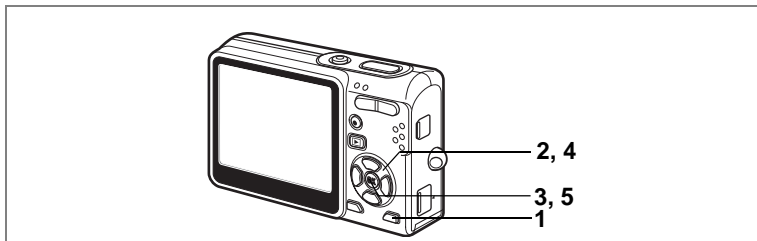

Setting Up the Start-up Screen

You can display an image recorded with the camera as the start-up screen when the camera is turned on.

1 Press the MODE button in Playback mode.

The Mode Palette appears.

2 Press the four-way controller (▲▼◀▶) to choose [Start-up Screen].

3 Press the OK button.

The screen for setting start-up screen appears.

4 Use the four-way controller (◀▶) to choose an image for the start-up screen.

[User] is indicated on the upper-right corner of the screen when the screen is used as a start-up screen.

5 Press the OK button.

The camera is ready to play back images.

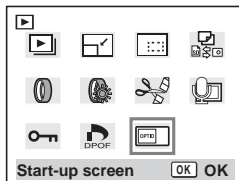



- Once the start-up screen has been set, it will not be deleted even if the original image is deleted or the SD Memory Card or built-in memory is formatted. To delete the start-up screen, display the Image select screen. While the image you have selected as a start-up screen is on the screen ([User] is indicated on the upper-right corner of the screen.), press the QUICK button.
- If the camera is turned off in the Green mode, the Green mode start-up screen will appear next time the camera is turned on. The Green mode start-up screen cannot be changed.

How to recall the [Yi Set-up] menu

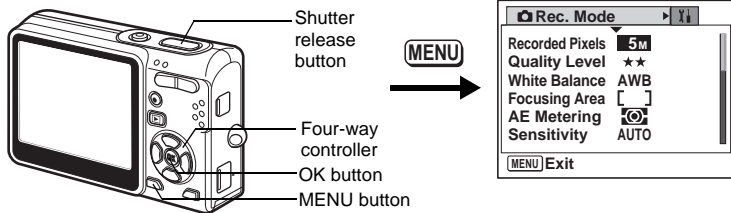

Formatting an SD Memory Card or the Built-in Memory

Formatting will delete all the data on the SD Memory Card if you are using a card, and all the data in the built-in memory if there is no SD Memory Card inserted.



- Do not remove the SD Memory Card while the card is being formatted as this may damage the card and render it unusable.
- SD Memory Cards formatted on a PC or device other than the camera cannot be used. Be sure to format the card with the camera.
- Formatting will delete protected data too. Be careful.

7

Settings

1 Select [Format] on the [Yi Set-up] menu.

2 Press the four-way controller (▶).

The Format screen appears.

3 Use the four-way controller (▲) to select [Format].

4 Press the OK button.

Formatting starts. When formatting is completed, the camera is ready to take pictures.

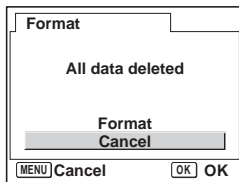

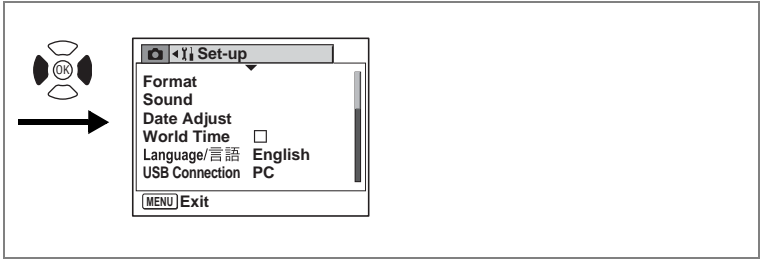

Changing the Sound Settings

You can adjust the playback volume and the volume of operation sounds, such as the start-up sound, shutter sound and operation sound. You can also change the operation sounds.

- 1 Select [Sound] on the [Set-up] menu.**
- 2 Press the four-way controller (▶).**

The Sound screen appears.

Changing the Volume

- 3 Use the four-way controller (◀▶) to change the operation volume.**
- 4 Use the four-way controller (▼) to select [Playback Volume].**
- 5 Use the four-way controller (◀▶) to change the volume of playback sounds.**
- 6 Press the shutter release button halfway.**

The camera is ready to take pictures.

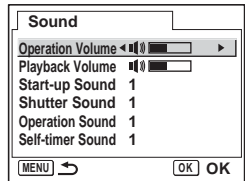

How to recall the [Y/Menu] Set-up] menu

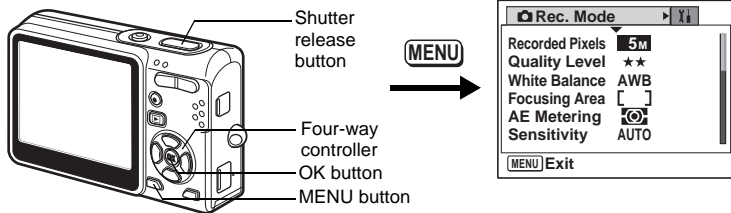

Changing the Sound

3 Use the four-way controller (▲▼) to select [Start-up Sound].

4 Press the four-way controller (▶).
The pull-down menu appears.

5 Use the four-way controller (▲▼) to select [1], [2], [3], [4], [5], or [Off].

6 Change the [Shutter Sound], [Operation Sound], and [Self-timer Sound] in the same way.

7 Press the shutter release button halfway.

The camera is ready to take pictures.

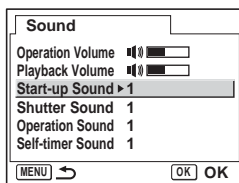

The Sound settings are saved when the camera is turned off.

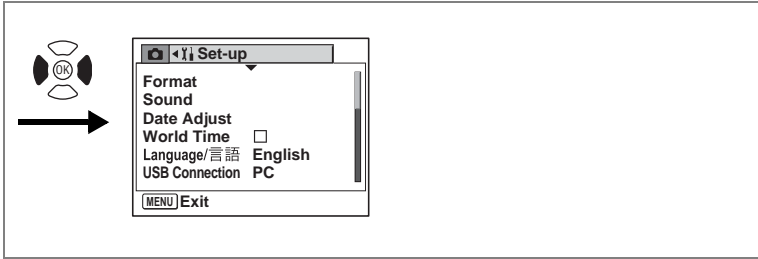

Changing the Date and Time

You can change the initial date and time settings. You can also set the style in which the date appears on the camera. Choose [mm/dd/yy], [dd/mm/yy] or [yy/mm/dd].

1 Select [Date Adjust] on the [Y Set-up] menu.

2 Press the four-way controller (▶).

The Date Adjust screen appears.

3 Use the four-way controller (▲▼) to choose the date and time display style.

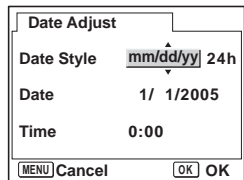

4 Press the four-way controller (▶).

The frame moves to [24h].

5 Use the four-way controller (▲▼) to select [24h] (24-hour display) or [12h] (12-hour display).

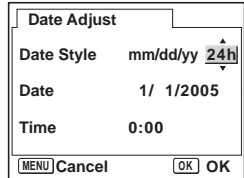

How to recall the [Y] Set-up] menu

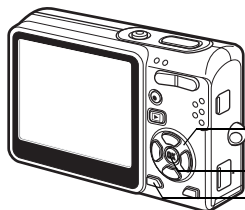

Four-way controller
OK button
MENU button

MENU

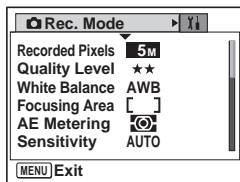

6 Press the four-way controller (▶).

The frame moves to month.

7 Use the four-way controller (▲▼) to change the month.

Change the day and year in the same manner.

Next, change the time.

If you select [12h] in Step 6, the setting switches between am and pm corresponding to the time.

8 Press the shutter release button halfway.

The camera is ready to take pictures.

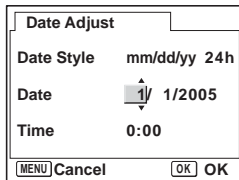

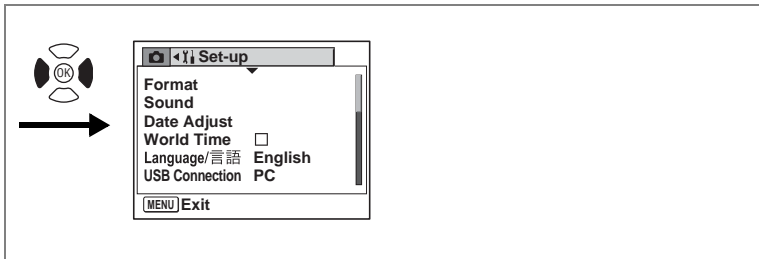

Setting the World Time

The date and time selected in “Initial Settings (Setting the Display Language and the Date and Time)” (p.25) serve as the Home Time setting.

You can display the time in a city other than the Home Time city (World Time). This is useful when taking pictures abroad.

1 Select [World Time] on the [Set-up] menu.

2 Press the four-way controller (▶).

The World Time screen appears.

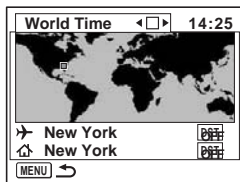

3 Use the four-way controller (◀▶) to select

(On)/ (Off).

:Displays the time in the city selected in ✈ (Destination)

:Displays the time in the city selected in 🏠 (Hometown)

4 Press the four-way controller (▼).

The frame moves to the ✈ (Destination) city. The city that is currently selected lights up on the map.

5 Use the four-way controller (◀▶) to choose a city.

How to recall the [Y] Set-up] menu

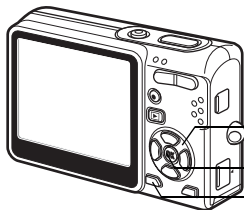

Four-way controller
OK button
MENU button

MENU

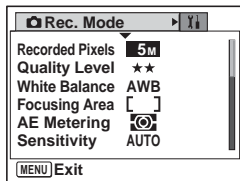

6 Press the four-way controller (▼).

7 Use the four-way controller (◀▶) to set whether daylight saving time is used or not.

Select **DST** if the Destination city uses daylight saving time.

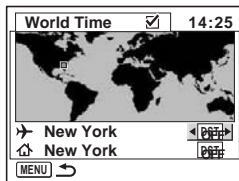

8 Press the four-way controller (▼).

9 Use the four-way controller (◀▶) to set your present location.

10 Press the four-way controller (▼).

11 Use the four-way controller (◀▶) to set whether daylight saving time is used or not.

Select **DST** if the present location uses daylight saving time.

12 Press the shutter release button halfway.

The World Time setting is saved and the camera is ready to take pictures.



Refer to "List of City" (p.152) for the list of cities.

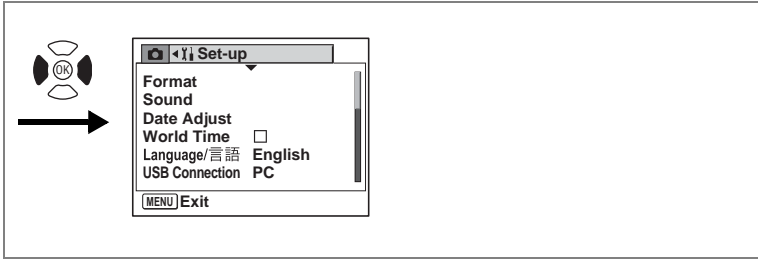

Changing the Display Language

You can change the language in which the menus, error messages, etc. are displayed.

You can choose from English, French, German, Spanish, Italian, Swedish, Dutch, Russian, Korean, Chinese (traditional and simplified), and Japanese.

- 1** Select [Language/言語] on the [Y Set-up] menu.
- 2** Press the four-way controller (▶).
- 3** Use the four-way controller (▲ ▼ ◀ ▶) to choose the language.
- 4** Press the OK button.
- 5** Press the MENU button.

How to recall the [Y/Menu] Set-up menu

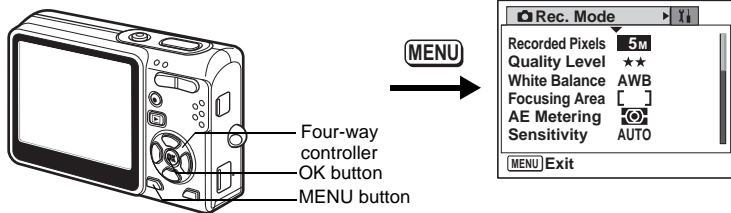

Changing the USB Connection Mode

You can change the USB connection mode depending on whether the USB cable is to be connected to a printer (PictBridge) or a computer.

- 1 Select [USB Connection] on the [Y/Menu] Set-up menu.**
- 2 Press the four-way controller (▶).**
The pull-down menu appears.
- 3 Use the four-way controller (▲▼) to select [PC] or [PictBridge].**
- 4 Press the ▶ Playback button.**
The camera is ready to play back images.

Changing the Video Output Format

You can select the output format (NTSC or PAL) for taking or playing back images on a TV.

- 1 Select [Video Out] on the [Y/Menu] Set-up menu.**
- 2 Press the four-way controller (▶).**
The pull-down menu appears.
- 3 Use the four-way controller (▲▼) to select [NTSC] or [PAL].**
Choose the video output format to match the output format of the TV.
- 4 Press the ▶ Playback button.**
The camera is ready to play back images.

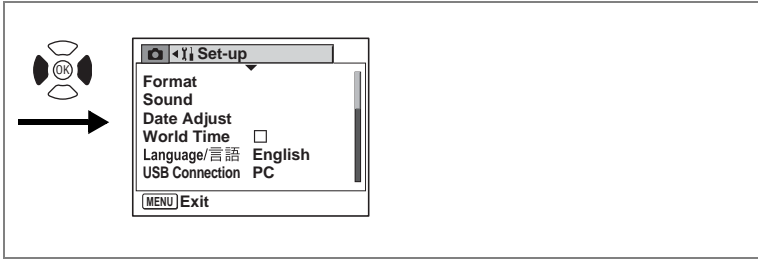

Adjusting the Brightness of the LCD Monitor

You can adjust the brightness of the LCD monitor by five levels.

- 1 Select [Brightness Level] on the [Set-up] menu.**
- 2 Use the four-way controller (◀▶) to adjust the brightness.**

Moving the slider leftwards makes the LCD monitor darker and moving rightwards makes it brighter.

- 3 Press the ▶ Playback button.**

The camera is ready to play back images.

How to recall the [Y] Set-up] menu

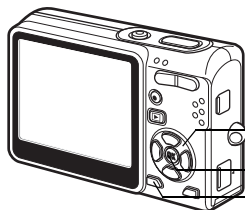

Four-way controller
OK button
MENU button

MENU

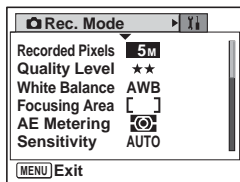

Sleep Timeout

You can set the LCD monitor to turn off automatically when no operation is performed for a fixed time.

- 1 Select [Sleep Timeout] on the [Y] Set-up] menu.**
- 2 Press the four-way controller (▶).**
The pull-down menu appears.
- 3 Use the four-way controller (▲▼) to select [2 min], [1 min], [30 sec] or [Off].**
- 4 Press the [▶] Playback button.**

The camera is ready to play back images.



This function will not work when playing a slideshow, movie, or voice memo, or when the USB cable is connected.

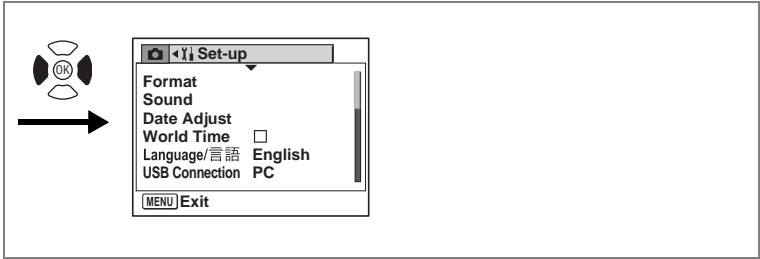

Setting Auto Power Off

You can set the camera to turn off automatically when no operation is performed for a fixed time.

- 1 Select [Auto Power Off] on the [Set-up] menu.**
- 2 Press the four-way controller (▶).**
The pull-down menu appears.
- 3 Use the four-way controller (▲ ▼) to select [5 min], [3 min] or [Off].**
- 4 Press the [▶] Playback button.**
The camera is ready to play back images.



The Auto Power Off function will not work when the USB cable is connected.

How to recall the [Y/| Set-up] menu

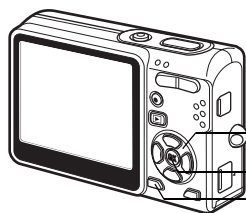

Four-way controller
OK button
MENU button

MENU

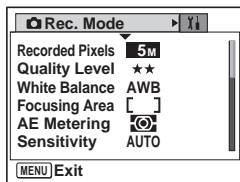

Setting the Guide Display

You can display the information on the mode you are currently using and the functions that are assigned to the QUICK button, etc., right after starting up the camera in Capture mode or switching to the Capture mode from other modes.

- 1 Select [Guide Display] on the [Y/| Set-up] menu.**
- 2 Use the four-way controller (◀▶) to select (On)/ (Off).**
- 3 Press the  Playback button.**

The camera is ready to play back images.

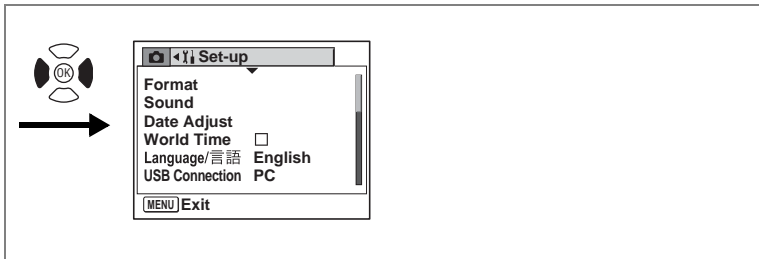

Resetting to Default Settings

You can return all the settings other than the date and time and language/言語 to the default settings.

- 1 Select [Reset] on the [Set-up] menu.**
- 2 Press the four-way controller (▶).**
The Reset screen appears.
- 3 Use the four-way controller (▲) to select [Reset].**
- 4 Press the OK button.**

The settings return to the defaults and the camera is ready to take or play back images.

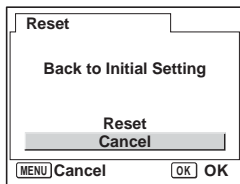

List of City

This is a list of cities which you can choose for the World Time.

Region	City	Region	City	
North America	Honolulu	Africa/West Asia	Nairobi	
	Anchorage		Jeddah	
	Vancouver		Tehran	
	San Francisco		Dubai	
	Los Angeles		Karachi	
	Calgary		Kabul	
	Denver		Male	
	Chicago		Delhi	
	Miami		Colombo	
	Toronto		Kathmandu	
	New York		Dacca	
Central and South America	Halifax	East Asia	Yangon	
	Mexico City		Bangkok	
	Lima		Kuala Lumpur	
	Santiago		Vientiane	
	Caracas		Singapore	
	Buenos Aires		Phnom Penh	
	Sao Paulo		Ho chi Minh	
	Rio de Janeiro		Jakarta	
Europe	Madrid		Hong Kong	
	London		Beijing	
	Paris		Shanghai	
	Amsterdam		Manila	
	Milan		Taipei	
	Rome		Seoul	
	Berlin		Tokyo	
	Stockholm		Guam	
	Athens		Oceania	Perth
	Helsinki			Adelaide
Moscow	Sydney			
Africa/West Asia	Dakar	Noumea		
	Algiers	Wellington		
	Johannesburg	Auckland		
	Istanbul	Pago Pago		
	Cairo			
	Jerusalem			

Optional Accessories

A number of dedicated accessories are available for this camera.

AC adapter D-AC8

USB cable I-USB17 (*)

AV cable I-AVC7 (*)

Camera case O-CC35

Camera case O-CC32

Strap O-ST8

Strap O-ST20 (*)

Leather Strap O-ST24

Sports Strap O-ST30

Remote control unit E (zoom function)

Remote control unit F

Rechargeable lithium-ion battery D-LI8 (*)

Battery charger D-BC8 (*)

AC plug cord D-CO2 (*)

D-CO2A Australia

D-CO2E Europe

D-CO2H Hong Kong, United Kingdom

D-CO2J Japan

D-CO2K Korea

D-CO2U North America, Canada

Products marked with an asterisk (*) are the same as those supplied with the camera.

Messages

Messages such as the following may appear on the LCD monitor during camera operation.

Compression error	Compression of the image you captured has failed. Change the quality/size and try again.
No image and sound	There are no images/sounds on the SD Memory Card or in the built-in memory.
Memory full	The SD Memory Card or the built-in memory is full and no more images can be saved. Insert a new SD Memory Card or delete unwanted images. (p.21, 111) Change the quality/size and try again. (p.125)
Memory card error	Shooting and playback are impossible due to a problem with the SD Memory Card. You may be able to play back an image or sound on a PC.
Card not formatted	The SD Memory Card you have inserted is unformatted or has been formatted on a PC or other device and is not compatible with this camera. (p.138)
Card locked	The SD Memory Card is write-protected. Only menu operation and mode change are possible.
Data being processed	The image is being recorded on the SD Memory Card or in the built-in memory.
	The protect setting or DPOF settings is being changed.
	The movie is being recorded.
	The image is being deleted.
	The image is being processed with digital filter.
	The movie is being edited.
Camera cannot play this image and sound	The SD Memory Card or built-in memory is being formatted.
Battery depleted	You are trying to play back an image or sound in a format not supported by this camera. You may be able to play it back on another brand of camera or PC.
Image folder could not be created	The battery is exhausted. Recharge the battery or replace with charged battery. (p.14)
Image and sound protected	The largest file number has been assigned to an image and no more images can be saved. Insert a new SD Memory Card or format the SD Memory Card or built-in memory. (p. 21, 138)
	The image or sound you are trying to delete is protected.











This file could not be processed	You are trying to resize, trim, protect an image, or you are trying to set an image for DPOF, or you are trying to edit an image with a digital filter or edit a movie while the image or movie cannot be processed with these functions.
There is no file to be processed	There is no file that can be processed with the Playback Mode Palette.

Messages such as the following may appear on the LCD monitor when using the PictBridge function.

No paper in a printer	There is no paper in the printer.
No ink in a printer	There is no ink in the printer.
Printer error	An error message has been sent from the printer.
Data error	A data error message has been sent from the printer.
Paper stuck in a printer	The paper in the printer has jammed.

Troubleshooting

Problem	Cause	Remedy
Camera will not turn on	Battery is not installed	Check battery is installed. If not, install battery.
	Battery is installed incorrectly	Check orientation of battery. Reinsert battery, making sure that the battery matches the label inside the battery compartment. (p.14)
	Battery power is low	Insert a charged battery or use the AC adapter.
No image on the LCD monitor	LCD monitor is set to OFF in Voice Recording mode	Press OK/Display button to turn LCD monitor on.
	Image is displayed but is hard to see	Image on LCD monitor may be hard to see when taking pictures outside in sunlight.
Shutter will not release	Flash is charging	When flash status lamp blinks red, flash is charging and no pictures can be taken. Lamp lights red when charging is completed.
	No available space on SD Memory Card or in built-in memory	Insert SD Memory Card with available space or delete unwanted images. (p.21, 111)
	Recording	Wait until recording is finished.
Picture is dark	Subject is too far away in a dark environment, such as a night scene	Picture becomes dark if subject is too far away. Take picture within range of flash.
	Background is dark	When taking a picture of a person against a dark background, such as a night scene, the background may appear dark if the flash does not reach it, even with the correct exposure. Set to  mode to ensure both person and background are clear. (p.46, 54)

Problem	Cause	Remedy
Subject is not in focus	Subject difficult to focus on	Subjects difficult to focus on using autofocus: objects with little contrast (blue sky, white walls, etc.), dark objects, finely patterned objects, fast-moving objects, scenery through window or net, etc. Lock focus on another object located at same distance (press shutter release button halfway), then aim at target and press shutter release button fully, or use Manual Focus mode.
	Subject is not in focusing area	Position subject in focus frame (focusing area) in middle of LCD monitor. If the subject is outside the focusing area, aim the camera at the subject and lock the focus (press shutter release button halfway), then compose picture and press the shutter release button fully.
	Subject is too close	Set focus mode on  (Macro) or  (Super Macro). (p.72)
	Focus mode is set on  (Macro) or  (Super Macro)	Normal pictures will be out of focus if taken with focus mode set on  (Macro) or  (Super Macro).
Flash does not discharge	Flash mode is set to Off	Set to Auto or  . (p.75)
	The Capture mode is set to  , Continuous Shooting, Infinity-Landscape or  (Sports mode) mode	Flash will not discharge in these modes. You can cancel the non-flash setting for  (Sports mode).

Very occasionally, static electricity may cause malfunction of the camera. In this case, remove the battery and install it again. If the camera works properly, the camera is in its normal condition and you can continue to use it.

Main Specifications

Camera

Type	Fully automatic compact digital still camera with built-in zoom lens	
Effective Pixels	5.0 megapixels	
Sensor	5.25 megapixels (total pixels), 1/2.5-inch interline transfer CCD with a primary color filter	
Recorded Pixels	Still Picture	5M (2560×1920), 4M (2304×1728), 3M (2048×1536), 2M (1600×1200), 1024 (1024×768), 640 (640×480)
	Movie	640×480 pixels
Sensitivity	Auto, manual (80/100/200/400: Standard Output Sensitivity)	
File Format	Still Picture	JPEG (Exif2.2), DCF, DPOF, PRINT Image Matching III
	Movie	AVI (MPEG-4), approx. 30 fps, with sound
	Sound	WAV (ADPCM system), monaural, max. recording time Approx. 3 hours 10 min. (when using a 128 MB SD Memory Card)
Quality Level	"Best", "Better", "Good"	
Storage Medium	Built-in memory (approx. 9.3 MB), SD Memory Card	

Image Storage Capacity and Recording Time (When using a 128MB SD Memory Card)

Quality Level \ Recorded Pixels	Best ★★★	Better ★★	Good ★	Movie (640×480)	Sound
5M	37	73	104	5 min. 30 sec.	3 hr. 12 min. 17 sec.
4M	44	83	125		
3M	62	113	166		
2M	104	178	250		
1024	227	417	544		
640	500	782	1043		

* The above table indicates the approximate number of images and recording time. The number of images and recording time may vary depending on a SD Memory Card and subject.

White Balance	Auto, Daylight, Cloudy, Shade, Tungsten Light, Fluorescent Light (Neutral White and White), Fluorescent Light (Daylight), Manual	
Lens	Focal Length	5.8 mm – 17.4 mm (equivalent to 35.6 mm - 107 mm in 35 mm format)
	Maximum Aperture	f/2.6 – f/4.8
	Lens Composition	6 elements in 5 groups (two aspherical elements)
	Zoom Type	Electrically driven
	Picture Range	38.6 mm × 28.9 mm (screen is filled) (Super Macro mode)
	Lens Cover	Electrically driven
Digital Zoom	Capture/Playback Mode	Max 4x (combines with 3x optical zoom to give zoom magnification equivalent to 12x)
LCD Monitor	2.5-inch TFT color LCD with approx. 110 kilopixels monitor (with backlight), frame coverage approx. 100%	

Playback Functions	Single-frame, 9 frame index, enlargement (max. 8x, scrollable), movie playback, sound playback, histogram display Playback Mode Palette (slideshow, resize, trimming, copy image and sound, color filter, brightness filter, movie edit, voice memo, protect, DPOF, start-up screen)	
Digital Filter	Color filter (B&W, Sepia, Red, Pink, Purple, Blue, Green, Yellow), Brightness filter	
Focusing System	Type	TTL contrast detection system by sensor, 7-point multiple/spot selection, auxiliary AF light, autofocus selection from 49 points
	Focusing Range (from lens front)	Normal: Approx. 0.4 m – ∞ (full zoom range) Macro: Approx. 0.18 m – Approx. 0.5 m (full zoom range) Super Macro: Approx. 0.06 m – Approx. 0.2 m (middle zoom position only) Landscape: ∞ (full zoom range) Pan focus: Approx. 1.5 m – ∞ (wide), Approx. 5 m – ∞ (tele)
	Movie Focusing Range (from lens front)	Normal: Approx. 1.5 m – ∞ (W), Approx. 5 m – ∞ (T) Landscape: ∞ (full zoom range)
	Focus Lock	By half-pressing shutter release button
Manual Focus	Approx. 0.18 m - ∞ (Approx. 0.06 m - ∞ around the focal length midpoint)	
Exposure Mechanism	AE Metering	TTL metering by sensor (multi-segment, center-weighted, spot)
	Capture Modes	Green, Mode Palette (Program, Night Scene, Movie, Panorama Assist, Landscape, Flower, Portrait, Self-portrait, Sunset, Food, Pet, Text, Sports, Surf & Snow, Special Effect (posterization filter, soft filter, slim filter, comment space), USER)
	EV Compensation	±2 EV (can be set in 1/3 EV steps)
	Movie	Recording time approx. 1 sec. until memory card is full
Shutter	Type	Electronic/mechanical shutter
	Speed	Approx. 1/2000 sec. – 4 sec.
Flash	Type	Auto flash with red-eye reduction function
	Flash Modes	Auto, Flash Off, Flash On, Auto + Red-eye Reduction, Flash On + Red-eye Reduction (low-speed synchro in Night Scene mode)
	Effective Range	Wide: Approx. 0.2 m – Approx. 3.5 m (at the standard output sensitivity of Auto) Tele: Approx. 0.2 m – Approx. 2.0 m (at the standard output sensitivity of Auto)
Drive Modes	Single-frame, Continuous, 3-sec. Remote Control, Instant Remote Control, 10-sec. Self-timer. 2-sec. Self-timer	
Self-Timer	Electronic control type, delay time: approx. 10 sec., 2 sec.	
Time Function	World Time setting for 70 cities (28 time zones)	
Power Supply	Rechargeable lithium-ion battery D-Li8, AC adapter (optional)	
Battery Life	Approx. 180 images	(at 23°C with LCD monitor on, flash fired for 50% of shots and using a rechargeable lithium ion battery D-Li8) * The battery life is based on the CIPA standard measurement, but it may vary with the conditions under which the camera is used.
In/Out Port	USB/AV terminal (PC communication type USB 2.0, high-speed-compatible), external power supply terminal	

Video Output Format	NTSC, PAL
Size	83 (W) × 55 (H) × 21.5 (D) mm (excluding operating members and projections)
Weight	105 g (excluding battery and SD Memory Card)
Weight When Shooting	120 g (including battery and SD Memory Card)
Accessories	Rechargeable lithium-ion battery, battery charger, AC plug cord, USB cable, software (CD-ROM), AV cable, strap, operating manual

Power Supply

	Battery Charger D-BC8	AC Adapter D-AC8 (optional)
Rated input	AC100-240V (50Hz/60Hz)	AC100-240V (50Hz/60Hz)
Rated output	DC 4.2 V / 630 mA	DC 4.5 V/2 A
External dimensions	88 × 46 × 26.5 (mm)	90 × 43.5 × 26.5 (mm)
Weight	61 g	122 g

WARRANTY POLICY

All PENTAX cameras purchased through authorized bona fide photographic distribution channels are guaranteed against defects of material or workmanship for a period of twelve months from date of purchase. Service will be rendered, and defective parts will be replaced without cost to you within that period, provided the equipment does not show evidence of impact, sand or liquid damage, mishandling, tampering, battery or chemical corrosion, operation contrary to operating instructions, or modification by an unauthorized repair shop. The manufacturer or its authorized representatives shall not be liable for any repair or alterations except those made with its written consent and shall not be liable for damages from delay or loss of use or from other indirect or consequential damages of any kind, whether caused by defective material or workmanship or otherwise; and it is expressly agreed that the liability of the manufacturer or its representatives under all guarantees or warranties, whether expressed or implied, is strictly limited to the replacement of parts as hereinbefore provided. No refunds will be made on repairs by non-authorized PENTAX service facilities.

Procedure During 12-month Warranty Period

Any PENTAX which proves defective during the 12-month warranty period should be returned to the dealer from whom you purchased the equipment or to the manufacturer. If there is no representative of the manufacturer in your country, send the equipment to the manufacturer, with postage prepaid. In this case, it will take a considerable length of time before the equipment can be returned to you owing to the complicated customs procedures required. If the equipment is covered by warranty, repairs will be made and parts replaced free of charge, and the equipment will be returned to you upon completion of servicing. If the equipment is not covered by warranty, regular charges of the manufacturer or of its representatives will apply. Shipping charges are to be borne by the owner. If your PENTAX was purchased outside of the country where you wish to have it serviced during the warranty period, regular handling and servicing fees may be charged by the manufacturer's representatives in that country. Notwithstanding this, your PENTAX returned to the manufacturer will be serviced free of charge according to this procedure and warranty policy. In any case, however, shipping charges and customs clearance fees to be borne by the sender. To prove the date of your purchase when required, please keep the receipt or bills covering the purchase of your equipment for at least a year. Before sending your equipment for servicing, please make sure that you are sending it to the manufacturer's authorized representatives or their approved repair shops, unless you are sending it directly to the manufacturer. Always obtain a quotation for the service charge, and only after you accept the quoted service charge, instruct the service station to proceed with the servicing.

- This warranty policy does not affect the customer's statutory rights.
- The local warranty policies available from PENTAX distributors in some countries can supersede this warranty policy. Therefore, we recommend that you review the warranty card supplied with your product at the time of purchase, or contact the PENTAX distributor in your country for more information and to receive a copy of the warranty policy.



The CE Mark is a Directive conformity mark of the European Community.

For customers in USA

STATEMENT OF FCC COMPLIANCE

This device complies with Part 15 of the FCC Rules. Operation is subject to the following two conditions: (1) This device may not cause harmful interference, and (2) this device must accept any interference received, including interference that may cause undesired operation.

Changes or modifications not approved by the party responsible for compliance could void the user's authority to operate the equipment.

This equipment has been tested and found to comply with the limits for a Class B digital device, pursuant to part 15 of the FCC Rules.

These limits are designed to provide reasonable protection against harmful interference in a residential installation. This equipment generates, uses and can radiate frequency energy and, if not installed and used in accordance with the instructions, may cause harmful interference to radio communications. However, there is no guarantee that interference will not occur in a particular installation.

If this equipment does cause harmful interference to radio or television reception, which can be determined by turning the equipment off and on, the user is encouraged to try to correct the interference by one or more of the following measures:

- Reorient or relocate the receiving antenna.
 - Increase the separation between the equipment and receiver.
 - Connect the equipment into an outlet on a circuit different from that to which the receiver is connected.
- * Consult the dealer or an experienced radio/TV technician for help.

For customers in Canada

This Class B digital apparatus meets all requirements of the Canadian Interference - Causing Equipment Regulations.

Pour les utilisateurs au Canada

Cet appareil numérique de la classe B respecte toutes les exigences du Règlement sur le matériel brouilleur du Canada.

Declaration of Conformity
According to 47CFR, Parts 2 and 15 for
Class B Personal Computers and Peripherals

We: PENTAX IMAGING COMPANY
A Division of PENTAX of America, Inc.

Located at: 600 12th Street, Suite 300
Golden, Colorado 80401 U.S.A.
Phone: 303-799-8000 FAX: 303-790-1131

Declare under sole responsibility that the product identified herein, complies with 47CFR Parts 2 and 15 of the FCC rules as a Class B digital device. Each product marketed is identical to the representative unit tested and found to be compliant with the standards. Records maintained continue to reflect the equipment being produced can be expected to be within the variation accepted, due to quantity production and testing on the statistical basis as required by 47CFR §2.909. Operation is subject to the following two conditions: (1) This device may not cause harmful interference, and (2) This device must accept any interference received, including interference that may cause undesired operation. The above named party is responsible for ensuring that the equipment complies with the standards of 47CFR §15.101 to §15.109.

Product Name: PENTAX Digital Still Camera

Model Number: Optio S5z

Contact person: Customer Service Manager

Date and Place: June, 2005, Colorado

- A**
- AC Adapter 19
 - Auto Power Off 149
 - Autofocus mode 72
 - Auxiliary AF light 87
 - AV cable 116
- B**
- Battery 14
 - Battery Level Indicator 16
 - Battery/card cover 11, 14
 - Best 23
 - Better 23
 - Brightness Filter 129
- C**
- Capture Mode 34
 - Capture Mode Palette 43
 - Color Filters 128
 - Color Saturation 94
 - Comment Space 62
 - Continuous Shooting 67
- D**
- Date and Time 141
 - DC input terminal 11
 - Default Setting 41
 - Delete All Images 113
 - Delete Images 111
 - DISPLAY button 12
 - Display Language 145
 - DPOF 118
- E**
- Exposure 86
- F**
- Flash 11
 - Flash Mode 75
 - Flash status lamp 11, 29
 - Fn Setting 90
 - Focus frame 29
 - Focus Mode 72
 - Focus status lamp 11, 29
 - Focusing Area 82
 - Format 138
 - Four-way controller 12, 34, 35
- G**
- Good 23
 - Green Mode 49
 - Guide Display 150
- H**
- Home Time 143
- I**
- Image Contrast 95
 - Image quality 23, 78
 - Image Sharpness 93
 - Image Size 23
 - Infinity-Landscape mode 72
 - Initial Settings 25
 - Instant Review 29, 88
- L**
- LCD monitor 11
 - Lens 11
 - Light Metering mode 83
- M**
- Macro mode 72
 - Manual Focus mode 72
 - Memory 96
 - MENU button 12, 34, 36
 - Menu List 41
 - Messages 154
 - Microphone 11
 - MODE button 12, 34, 36
 - Movie Edit 131
- N**
- Night Scene Mode 54
 - Nine-Image Display 109

Number of recordable images . . .	16	Sensitivity	85
O		Set the Menus	38
OK button	12, 34, 36	Set Up the Screen	136
Operating Time	16	Set-up Menu	42
Optional Accessories	153	Shutter release button	11, 28
P		Shutter Sound	140
Pan Focus mode	72	Slideshow	110
Panorama Assist Mode	57	Slim Filter	61
PictBridge	121	Sound Settings	139
Picture Mode	51	Speaker	11
Play back Movies	106	Start-up Screen	136
Play back Sound	101	Start-up Sound	140
Play back Still Pictures	30	Strap	13
Play back the Previous or Next Image	30	Strap lug	11
Playback button	12, 34, 35	Super Macro mode	72
Playback Mode	35	Symbols	9
Playback Mode Palette	45	T	
Posterization	59	Take Movies	55
Power switch	11	Take Still Pictures	28
Press down fully	29	Tele	68
Press halfway	29	Terminal cover	11
Printer	121	Text	53
Program Mode	50	Time-lapse Movies	70
Protect	114	Trimming	127
Q		Tripod socket	11
QUICK button	12, 34, 35, 92	TV	116
Quick Delete	112	U	
Quick Zoom	105	USB Connection	146
R		USB/AV terminal	11
Rec. Mode Menu	41	User Mode	63
Recording Sound	100	V	
Remote Control	65, 117	Video Output Format	146
Reset	151	Voice Memo	102
Resize images	125	Voice Recording Mode	37, 100
Rotate the displayed image	31	W	
S		White Balance	80
SD Memory Card	21, 22	Wide	68
Self-Timer	64	World Time	143
Self-timer lamp	11	Write-protect switch	22

Z

Zoom	68
Zoom button	12, 34, 35
Zoom Display	104

Memo

Memo

Free Manuals Download Website

<http://myh66.com>

<http://usermanuals.us>

<http://www.somanuals.com>

<http://www.4manuals.cc>

<http://www.manual-lib.com>

<http://www.404manual.com>

<http://www.luxmanual.com>

<http://aubethermostatmanual.com>

Golf course search by state

<http://golfingnear.com>

Email search by domain

<http://emailbydomain.com>

Auto manuals search

<http://auto.somanuals.com>

TV manuals search

<http://tv.somanuals.com>