



User's Manual

V5.1



Black Box Networks PICO systems

Table of contents:

1	Characteristics:	8
1.1	Features	9
1.2	Accessories	9
2	Optical free space transmission	10
2.1	Areas with natural or artificial obstacles.....	11
2.2	Urban areas	11
2.3	Industrial areas	11
2.4	ISP connections.....	12
3	Installation procedures	13
3.1	2.1 System set-up overview	13
3.2	Key factors of operation.....	13
4	Site survey	14
4.1	Link path	14
4.2	Installation sites	14
4.3	Distance determination	15
4.4	Direct sunshine.....	15
4.5	Eye safety.....	16
5	Installation procedure	17
5.1	Installation of the link	17
5.2	The connection of the outdoor box	21
5.3	Mounting bracket fixing:	22
5.4	On-the-table test.....	23
6	Warranty conditions	24
7	Twisted pair cabling	27

Safety of the Black Box product

The Black Box is classified as Class 3B laser product.

The Black Box System has been tested and found to comply with the EN 60825-1:1994 +A11:96 (laser safety), EN 60950-1:92+A1:93+A2:93+A3:95+A4:97 (electrical safety), EN 55022:1998 Class 3B (emission) and EN 55024:1998 and EN 50082-2:1995 (immunity) European standards.

The laser radiation is emitted from the transmitter optics through the glass window in the front side of the laser head under less than 10 mrad divergences. Depending on the model, one, two or four of such transmitters may be present inside one head assembly. The optical axes of the transmitters are parallel to each other, each of them emitting laser radiation towards the same direction – onward through the optical window of the head. No other aperture through which laser radiation can occur present in the laser head.

Warning!

Invisible laser radiation! Looking directly into the laser beam can cause permanent damage to the eye! Safe looking distance varies with beam power and divergence. See attached data sheet for exact figures.

The Black Box product should be installed in such a way that nobody can access the optical window or can get in the way of the laser beam accidentally. For detailed instructions please read **Eye Safety** part of chapter 4.5 of the manual (Site Survey).

The Black Box product provided with all the necessary labels specified by the standards. Moreover informative labels should be put on clearly visible places where the laser beam can be accessed. The locations of the warning labels are shown in Chapter 4.5/Eye Safety.

The Indoor Interconnection Unit is assembled with a certified power cord, which must be connected to the mains through a power outlet to make the disconnection possible at any time. Any modification to the above installation is prohibited. If modifications are required by the local standard, please contact the manufacturer.

To ensure the compliance with the EN 60950 safety requirements, only the manufacturer or its certified partners should install the system.

Warning

Operating the Black Box product other than described in this manual can cause undesired laser radiation and can be dangerous to the eye or electrical shock!

Elektrische Sicherheit des Black Box Produkts

D

Das Black Box ist eine Klasse 3B Lasereinrichtung.

Das Black Box Produkt wurde geprüft und entspricht den Anforderungen der Europäischen Standards EN60825-1:1994 + A11:96 (Lasereinrichtungen), EN60950-1:92+A1:93+A3:95+A4:97 (Elektrische Sicherheit), EN55022:1998 Klasse 3B (EMV, Störaussendung) und EN55024:1998 sowie EN50082-2:1995 (EMV, Störfestigkeit)

Der Laserstrahl wird von der Sendeoptik durch die Glasscheibe an der Frontseite des Laserkopf mit einer Divergenz von weniger als 10mrad abgestrahlt. Abhängig vom Modell des Laserkopf können sich ein, zwei oder vier solcher Sender innerhalb des Laserkopf befinden. Die optischen Achsen der einzelnen Sender verlaufen parallel zueinander wobei jeder Sender in die gleiche Richtung strahlt - in Richtung der Optik des Laserkopf. Es sind keine weiteren Blenden vorhanden durch die Laserstrahlen auftreten können.

Warnung!

Unsichtbare Laserstrahlen! Nicht direkt in den Laserstrahl schauen, da dies die Augen permanent schädigen kann. Der Sicherheitsabstand variiert mit der Laserleistung und Divergenz des Laserstrahl. Details hierzu sind im Datenblatt nachzulesen.

Das Black Box Produkt muß so installiert werden, daß niemand Zutritt zu der Optik des Laserkopf hat oder zufällig in den Bereich des Laserstrahl kommen kann. Kapitel 4.5 auf des Handbuchs enthält ausführliche Anweisungen zum Schutz der Augen.

Das Black Box Produkt ist mit allen notwendigen Warnhinweisen versehen die durch die Standards vorgeben werden. Weitergehende Hinweise sollten an gut sichtbaren Stellen angebracht werden wo man sich dem Laserkopf gefahrlos nähern kann. Die Positionen der Warnhinweise sind auf Kapitel 4.5, Schutz der Augen

Die „Indoor Interconnection Unit“, die mit einem zertifizierten Netzkabel ausgeliefert wird, muß mit der Stromversorgung verbunden werden, indem der Netzstecker in eine geeignete Netzsteckdose gesteckt wird, womit die Lasereinrichtung auch jederzeit wieder vom Netz getrennt werden kann. Jegliche Modifikationen an der Installation sind verboten.

Falls aufgrund nationaler Vorschriften dennoch Änderungen an der Installation vorgenommen werden müssen, ist vorher der Hersteller zu befragen.

Um die Konformität bezüglich der Elektrischen Sicherheit nach EN60950 sicherzustellen, sollte das System nur vom Hersteller oder seinen zertifizierten Partnern installiert werden.

Warnung !

Die Inbetriebnahme oder der Betrieb des Black Box Produkts, abweichend von den Vorgaben dieses Handbuchs, kann unerwünschte Laserstrahlung verursachen und gefährlich für die Augen werden oder einen elektrischen Schock verursachen.

Sécurité de produit **Black Box**

F

Le produit **Black Box** est classifié dans la catégorie laser 3B.

Le système de **Black Box** a été testé et correspond aux normes européennes: EN 60825-1:1994+A11:96 (sécurité du laser), EN 60950-1:92 + A1:93 + A2:93 + A3:95 + A4:97 (sécurité électrique), EN 55022:1998 Classe 3B (émission), EN 55024:1998 et EN 50082-2:1995 (immunité).

La radiation laser est émise à partir de l'émetteur optique à travers une fenêtre en verre placée à la tête du laser et a une divergence de moins de 10 mrad. Selon le type de modèle, le nombre d'émetteur placé dans la tête du laser varie entre 1, 2 ou 4. L'axe optique des émetteurs sont parallèles et chacun d'entre eux émettent la radiation laser dans la même direction, à travers la fenêtre de la tête du laser. Aucune autre ouverture dans la tête ne peut laisser passer de radiation laser.

Attention!

La radiation laser est invisible! Interdiction de regarder le rayon laser ! Risques graves de lésions pour les yeux! La distance de sécurité pour la vue est variable et dépend de la puissance du rayon et de sa divergence! Consulter la feuille de données ci-jointe pour calculs exacts.

L'installation de produit **Black Box** doit être faite de sorte que personne ne puisse accéder à la fenêtre optique ou traverser le rayon laser par accident. Pour instructions détaillées, lire la partie **Sécurité de l'œil** dans le chapitre 4.5 du manuel (Site Survey) à la page 17.

Le produit **Black Box** possède la totalité des étiquettes stipulées par les normes. De plus, des avis informatifs sont placés à des endroits clairement visibles où le rayon laser pourrait être accessible. Une liste des endroits où sont placés les avis informatifs est donnée dans le chapitre 4.5 du manuel (Eye Safety) à la page 17.

Le boîtier de connections intérieure (Indoor Interconnection Unit) est fournit avec un fil électrique certifié par lequel l'appareil est connecté à la prise de courant. Grâce à cela, il est possible de débrancher à n'importe quel moment. Il est formellement interdit d'apporter de quelconques modifications à cette installation. Si une modification est cependant nécessaire à cause des normes locales, contacter le fabricant.

Attention!

Tout opération consistant à utiliser le produit **Black Box de façon différente que celle indiquée dans le manuel pourrait engendrer des effets indésirables du rayon laser, être dangereuse pour la vue et provoquer un choc électrique!**

Sicurezza dei prodotti Black Box

Black Box è classificato di essere un Classe 3B prodotto di lazer.

Il sistema Black Box è stato collaudato e trovato conforme con EN 60825-1:1994 +A11:96 (sicurezza sul prodotti lazer), EN 60950-1:92+A1:93+A2:93+A3:95+A4:97 (sicurezza elettrica), EN 55022:1998 Class B (emissione) ed EN 55024:1998 ed EN 50082-2:1995 (immunità), Norme Europee.

La radiazione lazer viene emessa dalla ottica del trasmettitore via la finestra di vetro posizionata sulla fronte della testa di lazer con una divergenza minore di 10 mrad. Secondo il modello si trovano uno, due o quattro trasmettitori in una testa di lazer. Gli assi ottici dei trasmettitori sono paralleli uno con l'altro, tutti quanti emettono il raggio di lazer nella stessa direzione via la finestra ottica della testa lazer. Non esiste nessun'altra apertura attraverso quale radiazione di lazer può presentarsi.

Avvertimento!

Radiazione lazer invisibile! Guardando direttamente nel raggio di lazer può causare danni permanenti degli occhi! La distanza di sicurezza dello sguardo varia secondo la potenza e la divergenza dello raggio di lazer. Distanza di sicurezza viene comunicato sulla pagina tecnica allegata.

Prodotti Black Box devono essere installati in tale maniera, che nessuno possa accedere la finestra ottica o esporsi al raggio di lazer per caso. Per informazioni più dettagliati vedi la parte **Sicurezza Ochi** del capitolo 4.5 nel manuale sulla **pagina 17**.

I prodotti Black Box verranno forniti con tutte segnalazioni previste nelle norme. In addizione segnalazioni informative devono essere posizionate nei posti ben visibili dove il raggio di lazer può essere accesso. Le locazioni delle segnalazioni di sicurezza sono dimostrati sulla **pagina 17** del manuale (Capitolo 4.5/ Sicurezza Ochi)

La Unità Interconnessione Interna viene fornita con un cavo di alimentazione certificato quale deve essere collegato con la rete di potenza tramite una presa per assicurare la separabilità in qualsiasi momento. Qualunque modifica sul questo impianto è proibito. Se modifiche si devono eseguire per rispettare la norma locale, si prega di contattare il produttore.

Per garantire la conformità con la norma EN 60950, il sistema deve essere installato dal produttore o dai partner certificati.

Attenzione!

Qualsiasi operazione di Black Box diversa di quello descritto in questo manuale può causare non desiderata radiazione lazer e può essere pericoloso per gli occhi o causare scossa elettrica!



Safety

3B Class Laser device

This unit complies with the relevant safety regulations. If you have questions please contact Black Box Co. tech support.

- Fragile handle with care.
- Ensure that the local main voltage is within the range of 100VAC to 240VAC
- Ensure that no liquids are dropped inside the unit.
- In the case of emergency (e.g.: damaged casing, elements or cables) disconnect the unit immediately.
- Only qualified technicians should repair the device. Unauthorized opening will result in warranty being void.

This manual will show you how to install and use the *Black Box PICO* systems

1 Characteristics:

Model Number	Pico Ethernet	
Interfaces	Ethernet, Fast-Ethernet	
Distance in meter	75	150
Electrical & Optical Characteristics		
XMT Power mW (max)	65 mW	
Transmitter	Laser Diode	
Wave Length (nm)	780 to 980	
Dynamic range	>25dB	
Power		
Power to Head	110/220 VAC, 50W max.	
Environments		
Operating Temperature	-25 – 60 Centigrade (normal version)	
	-40 – 85 Centigrade (extended version)	
Storage Temperature	-40 – 80 Centigrade (normal version)	
	-55 – 105 Centigrade (extended version)	
Humidity	Up to 95% non condensed	
Physical Characteristic		
Housing	Metal	
Protective Shield	Hardened Aluminium, with white reflective paint and Stainless steel Base	
Weight (kg)	2,5 Kgs	
Dimension (mm)	160X110X350	

1.1 Features

- The newly developed „Pico” used for transmit 100 Mb/s data up to 150 meters.
- Easy to install, and easy to use.

1.2 Accessories

- 2 Pico Units
- 2 Mounting Brackets
- 2 Outdoor Interconnection Unit

The **Black Box-Pico** product range offers cost effective, reliable free space laser transmission for 100Mbps Ethernet data through free space.

The transmission technique used in the **Black Box** devices provides transparent wire speed data transfer with virtually zero latency, because it uses infrared light as a transmission medium, **Black Box** systems do not require frequency licenses and the transmission is not affected by electro-magnetic interference or radio frequency interference. The **Black Box Pico** link *can be considered as a virtual fiber in the air, with standard Cat 5 connection at each end.*

Each product is built using highest quality electronic components for operation in even the most adverse conditions. Metal housing gives a robust, waterproof environment for the electronics, with IP65 isolation rating. The shield protects the device from direct sunlight and provides extra air isolation.

Invisible laser radiation, Class 3B laser product. Looking directly into the laser beam can cause permanent damage to the eye!

2 Optical free space transmission

The principle used in free space laser transmission is very similar to the one is used for fiber optic transmission. The difference is while fiber optic devices use electronics and optics optimised for optical fiber, free space communication equipment deploys electronics and optics optimised for transmission through the air. Also you can observe the similarity in the transmission properties. No galvanic contact, no ground loops, no need for surge protection, noise immunity, high bandwidth.

What makes it unique – and difficult to design – is that it does not require any transmission medium like fiber or copper, but has to cope with the dynamically changing parameters. For instance while the attenuation of an optical fiber is constant, the *attenuation of the atmosphere between the laser units can change dramatically* (depending on the weather conditions).

The **Black Box** heads are usually placed on top of buildings, where clear line of sight is guaranteed and the beam cannot be interrupted.

In the head the incoming signal is amplified, encoded, then drives the laser diode. The transmitter optics assures the proper beam shape. The receiver optics perceives and directs the transmitted signal to the photodiode. The diode converts it back into electrical, then it is decoded, amplified and converted.

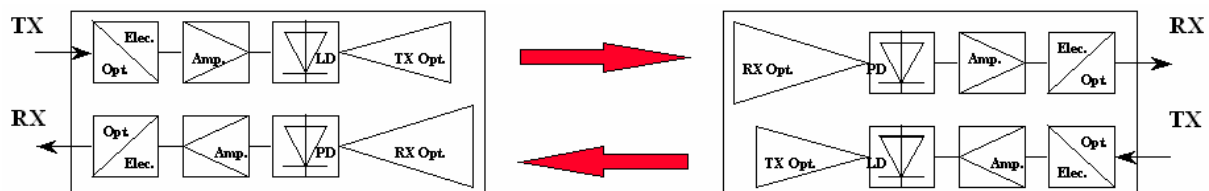

There are several things that can influence the quality of transmission. We can classify those factors into three main groups.

- **System conditions** - transmitting power, transmitters wavelength, beam divergence, receiver optics diameter, receiver sensitivity, parameters of optical system and casing. These parameters determine the system's characteristic at a certain distance and are controlled by system design and factory set up.
- **Weather conditions** - molecular absorption, particle scattering and turbulence. These elements have great effect on the operational conditions of the system. We do not have very much influence on them; proper product selection can eliminate the undesirable effects.
- **Environmental conditions** - building movements, direct sunlight, refractive surfaces. These are also key factors related to the installation sites and can be controlled by appropriate site survey and system installation.

Most typically the **Black Box-Pico** is used to interconnect LAN-s, or computers. The system is protocol transparent, thus other applications also can be taken into consideration. Appropriate interface converters are needed and system bandwidth must be matched for that.

Here we collected some circumstances, where the employment of the **Black Box** is the most adequate and cost effective solution. Those are:

2.1 Areas with natural or artificial obstacles

Where cable is actually not an alternative, like across rivers or railways or in rugged terrain.



2.2 Urban areas

Where only leased lines are available with limited speed and high rental cost. With **Black Box** links you can establish on line LAN-to-LAN connections.



2.3 Industrial areas

Where you have noisy environment with high EMI or RFI. Factory buildings, airport objects can be connected through laser link.



2.4 ISP connections

Where high bandwidth is required. ISP's can offer high-speed links to their customers or trunks can be established between ISP's instead of expensive leased lines.

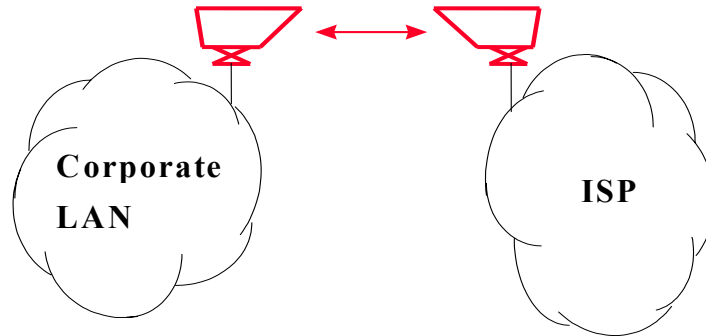

3 Installation procedures

3.1 System set-up overview

The set up of a Black Box link needs careful planning, thorough site preparation, and accurate installation. We have listed the work that is essential for a successful system set up.

1. Site survey
2. System design
3. Site preparation
4. System installation
5. Alignment procedure
6. System test

We deem necessary to emphasize the importance of site survey. It is fundamental to make sure if the laser link is a viable solution at all. Most customers usually are not experts in this field, so they cannot realize the sources of possible difficulties. It is also very important to clarify the position, size and outlook of the support frame with the customer in advance.

3.2 Key factors of operation

There are four key issues that the site survey. The proper system operation cannot be guaranteed without satisfying all the four requirements.

a. Clear line of sight - first of all optical path between the two ends must be free of any obstacles. It not only means that one has to see the other side, but other possible sources of disturbance should also be taken into consideration. For example there might be turbulence above the roofs and other constructions, and this can cause fraction or scattering of the beam or snow accumulation on roofs too close to the beam can influence or even interrupt the communication.

b. Solid mount surface - is the key for long-term operation. Since the diameter of the beam is limited, it is extremely important to mount the unit on a stable structure with the possible smallest movement. This way the receiver of the remote unit cannot get out of the beam due to the movement of the opposite head.

d. East-West orientation - although the receiver optics is equipped with optical filters to protect the receiver diode from the effect of undesired light sources, the direct sunshine can cause saturation of the diode. This prevents the system from working properly for several minutes a day in a certain time of the year. There are some methods to reduce the effect of the sun, but the best way is to avoid the East-West orientation wherever it is possible.

4 Site survey

In order to comply with the requirements of the successful installation - including the discussed four key factors and other criteria - the following matters should be taken into consideration.

4.1 Link path

If the clear line of sight is available, further examination of the sites and optical path is necessary after possible sources of temporary or periodic malfunction. No *chimneys, steam or other smoke sources* may be present under or near to the beam path. They can weaken the strength of the signal or can cause wandering of the beam. Heater vents and air conditioners have similar effect as they can cause air turbulence. Scintillation from rooftops or glass surfaces due to direct sunshine also may interrupt the beam. The closer the source to the transmitter the greater it's effect. Because both sides have transmitter and receiver, the source of such symptoms in the middle has the less effect on the overall system. If there are trees near the transmission path, consideration of growth and the wind blown leaves into the into the transmission path is necessary. Areas under construction can have moving obstacles like construction cranes that can disturb the communication.

4.2 Installation sites

All buildings and constructions have a certain movement of their own. It's determined by the structure and material of the building. Metal structures can shift or twist due to temperature changes. Wooden construction can expand or shrink with the changing of humidity. Give preference to concrete or brick buildings. On the other hand high structures like towers, skyscrapers or poles always subject to great movement. Mount the support frame to basic holders of the building or near corners, as they are the most stable spots. Use appropriate consoles for wall mounting. If a stand is used on the top of a building, secure it directly to the ceiling or to the concrete cornice wherever is possible. Do not fix stands to insulating materials as they can slowly sink under the weight of the unit and with temperature changes. Big chimneys and smokestacks may look stable, but as their inner temperature varies they can also move. Vibration caused by heavy traffic, trains, elevators, etc. may slowly move the system out of its specified direction. Another important consideration is to provide enough space for alignment and to have the potential for future maintenance. Consider that the support frame is usually heavy, so the selected spot should be easily accessible.

It is not only the building that has to be solid, but the support structure too. Antenna poles, security camera holders are not suitable for the Black Box units. A catalogue of more than 80 mounting frames can be ordered from the manufacturer (both available in printed and CD ROM format. Please contact with Black Box Co. tech support for details.

Preferred installation sites	Pay attention to	Avoid ^(*)
<i>Concrete wall</i>	<i>Behind window</i>	<i>Soft materials</i>
<i>Brick wall</i>	<i>Old constructs</i>	<i>Chimneys</i>
	<i>Microwave towers</i>	<i>Wooden constructs</i>
		<i>Metal masts or Frames</i>
		<i>Hidden heat isolations, like Styrofoam</i>

(*)

In cases where installations are listed under "AVOID" cannot be avoided than special mounting accessories to be designed and special installations must be used.

4.3 Distance determination

Try to get as accurate information about the connection distance as you can in order to get the maximum performance out of the system. The easiest way is to obtain a proportional map and calculate the distance. In some cases the distance between sites can be measured directly with distance recorders. There are infrared and laser distance meters that can display the distance between the viewer and the defined point.

4.4 Direct sunshine

To prevent the sun shining directly into the receiver optics, first one has to determine the orientation of the link. Try to avoid East-West orientation wherever it is possible. Examine both sides of the link at sunset and sunrise and find a position where the sun cannot shine directly into the receiver. Be aware that the path of the sun is changing throughout the year

4.5 Eye safety

No two installations sites are the same. The buildings or structures, the available space and the accessibility of the place will be different in each case. Nevertheless, as a general rule it is *very important to select the installation site so, that nobody can look directly into the transmitter*. For this reason place the head either so high (on the side wall of the building) or so close to the edge of the building (on a parapet on the rooftop) that no person can approach it accidentally and can get into the beam path. Set up barriers if necessary and put warning signs at prominent places.

The laser heads are provided with all labels and hazard warnings required by the applicable standards. There are warning labels on both the left and right side of the protective cover next to the optical window and there is a warning and an informative label on the rear side of the laser head. The locations of those signs are shown in the following pictures.

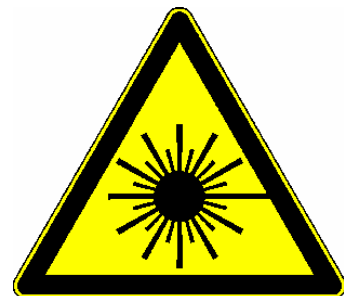
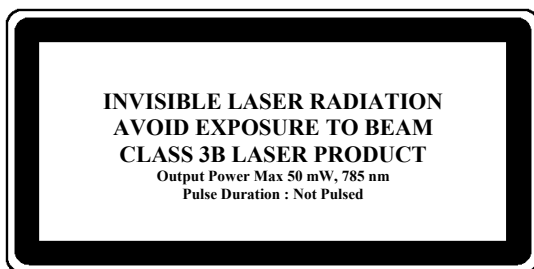
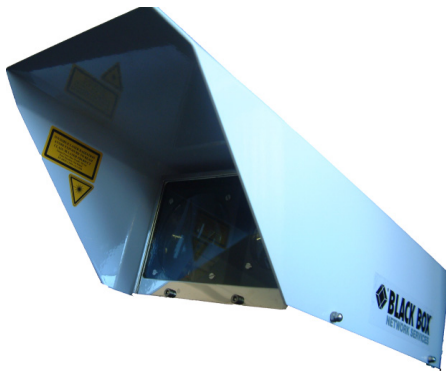

5 Installation procedure

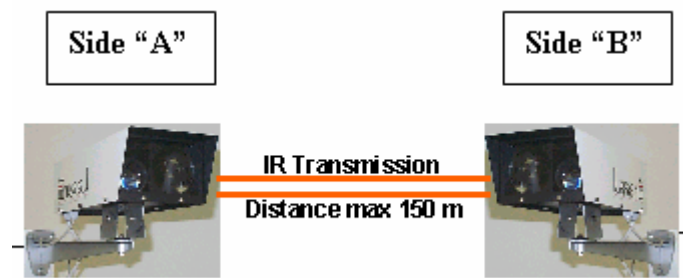

For installation purposes the **PICO** units are factory Pre-Set for 150 meters. If the Pico link distance is less than 50 meters, the beam should be adjusted, with the special tool(see below)

5.1 Installation of the link

For proper installation follow The Steps Listed Below.

1. Direct head "A" to side "B" using the embedded pointing device.(See Diagram 1.1) Align Cross-Hair at unit "B"

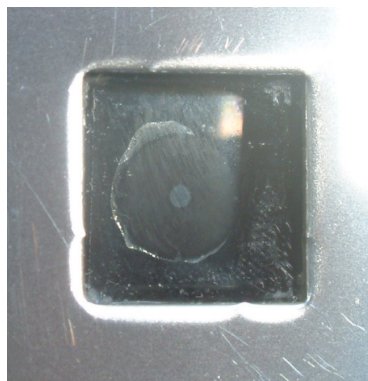
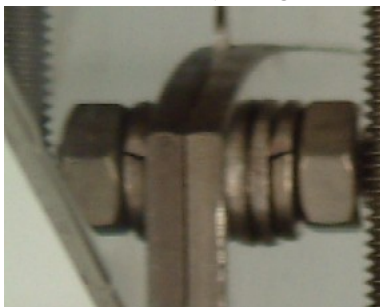
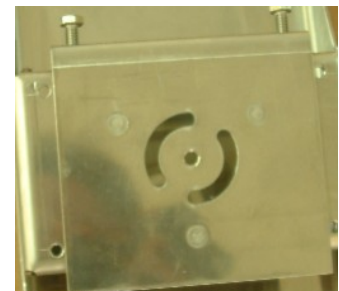

Diagram 5.1

2. Direct head "B" to side "A" using the embedded pointing device.(See Diagram 3.1) Align Cross-Hairs at unit "B".



3. fix the *pico* head on side "A" and on side "B" with the screws to the mounting frame and with the screws on the side of the unit(make sure that the unit is not moved during the tighten process). The screws should be sufficiently tight to hold the unit



for long time.

4. Power Pico units at both ends.

Black Box Networks PICO systems

5. Fine Adjustment is required after the unit has been aligned with the internal pointing device. Fine alignment is applicable for vertical and horizontal orientations. These movements must be done using the fine alignment screws. Adjust first the horizontal then the vertical screw

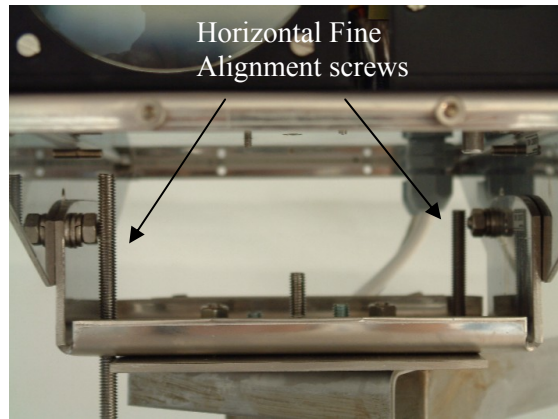
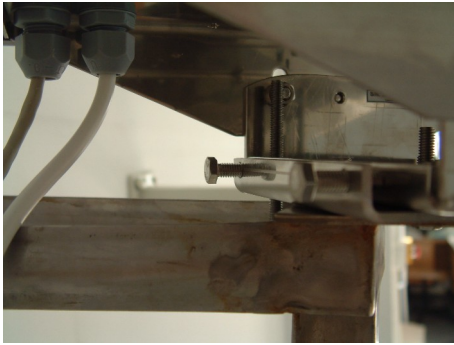

as shown in the photographs on this page. Adjust these screws while watching the rear panel LED lights (see diagram: 3.2). Illuminate as many green LED power indication lights as possible during the fine alignment process, and follow your multimeter display, to find the maximum of the detector voltage.

DON'T TRY TO DO MOVE TWO HEADS AT THE SAME TIME! The result won't be the same

6. During this period described in the fifth step, try to avoid the saturation LED. /Red light/ (See Diagram 5.2)

Diagram 5.2

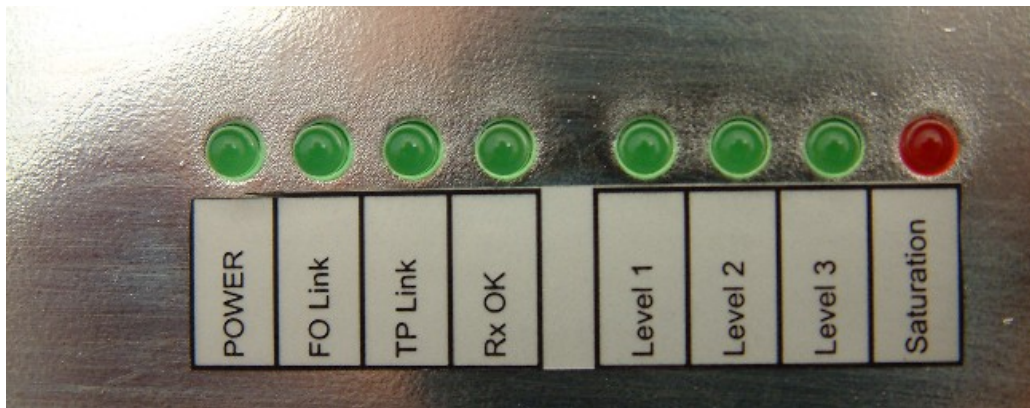

LED Meanings:

Power:

The head is powered up.

FO Link:

Fiber optical link between the two heads.

TP Link

Copper side link between the head and the Network equipment.

RX OK

There is enough light to start communicate through the link.

Level 1

25% of the total (acceptable by the receiver) incoming power

Level 2

50% of the total (acceptable by the receiver) incoming power

Level 3

75% of the total (acceptable by the receiver) incoming power

Saturation

Overload (Overloading can cause stop in the communication, and permanently it can damage the receiver)

- 7. If the installation distance is shorter than 50 meters in that case realignment is required which can be done with the device on the picture.

- 7.1 release the screws

- 7.2 Pull the regulation nut perfectly to the front and fix it with the screws!
Please note that this operation should be done extra carefully because it can move the transmitter out of the alignment. It must be totally on the front!



The required installation tools:

screwdriver

10 mm wrench 2 pcs

13 mm wrench for fixing the bracket

Punch-down tool for the TP cord

Please note:

Fixing of unit to a rigid surface is very important for long-term alignment.

5.2 The Outdoor interconnection unit

The outdoor interconnection unit (OIU) provides the power supply for the head. This unit provides +8VDC, GND, -8VDC and the 30VDC for the head. Ensure that the cables are connected as it seen below. The OIU also has a TP connection module that provides an easy-to-use connection between the head and the local network.

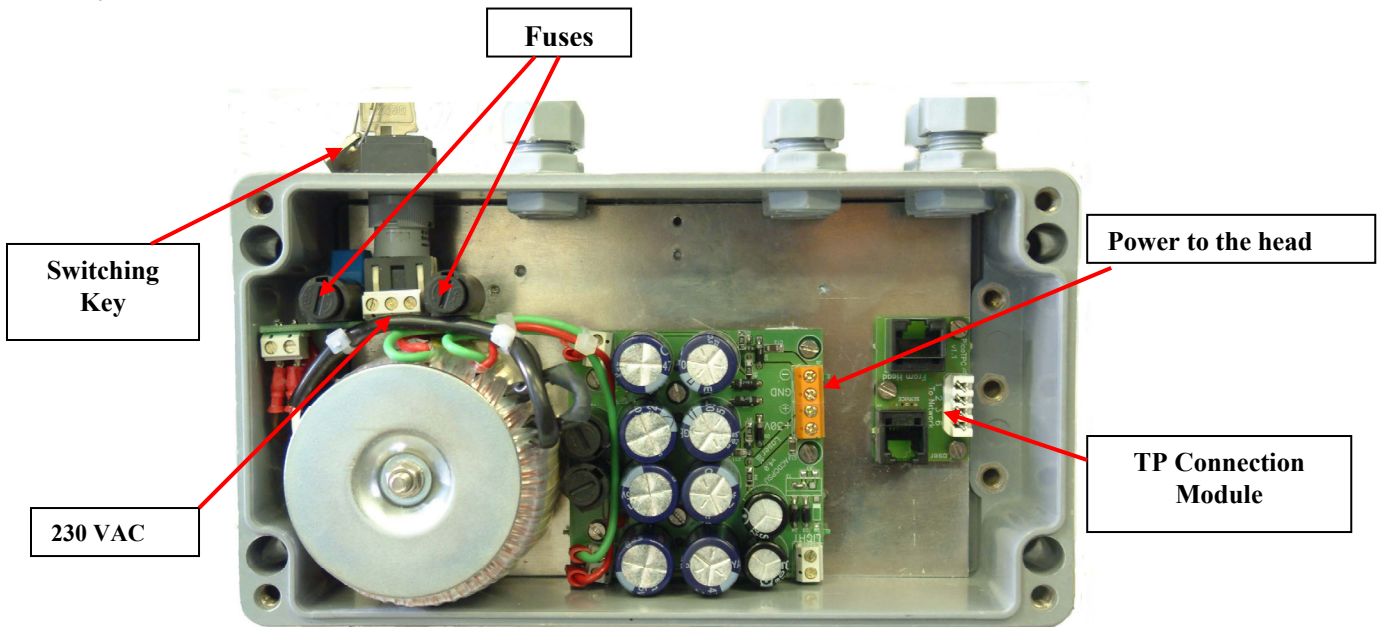

5.2.1 Power Connection to the OIU

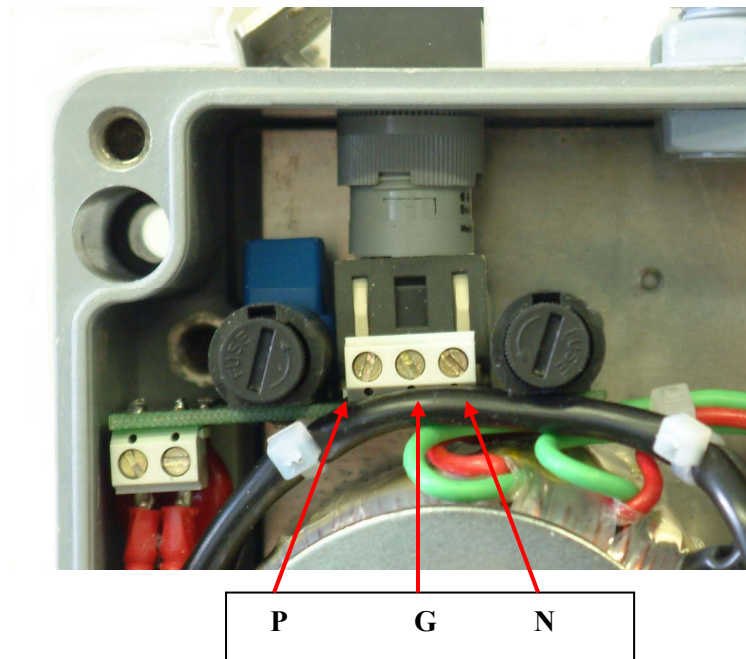

This is the primary side of the OIU and these 3 connectors are used to provide the 230 VAC to the unit.

Please be very careful while connecting the 230 VAC cable! Be sure that the cable is not under power when you connect it!

5.2.2 Power to the Head

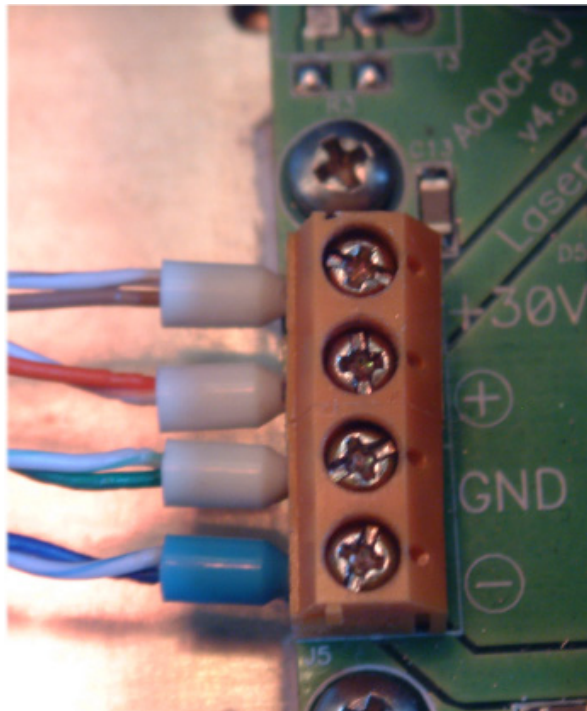

This is where the necessary +8 VDC, Ground, -8 VDC and 30 VDC is connected to the head. Use the power cables embedded into the head and connect them to the 4 pin connector. The colour codes:

Brown-white	+30 VDC
Orange-white	+8 VDC
Green-white	Ground
Blue-white	-8 VDC

Warning! The wrong polarity of the cables can damage the head!

5.2.3 The UTP Connecting Unit

This unit is used to connect the data cable coming from the head to the data cables coming from the local network. You must use straight connection on your local network side. Use the connectors to connect the proper cable. Colour codes can be seen in the figure below:

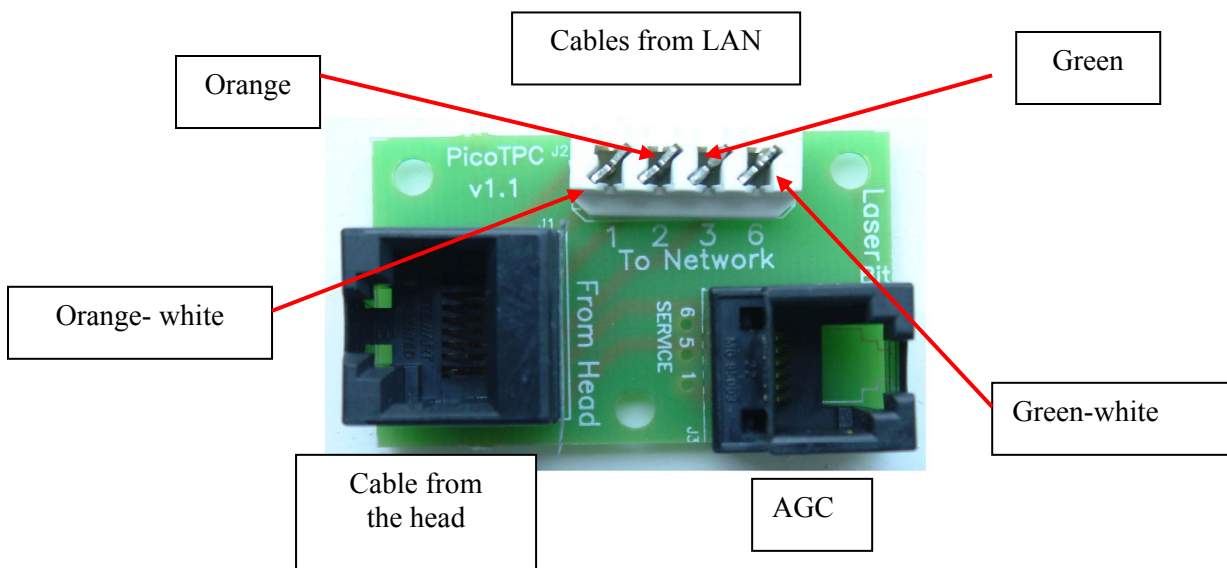

You can measure AGC detector voltage on **pin 1 and 4 of the RJ11 connector**. This connector is used for measurement and installation purpose only.

5.3 Mounting bracket fixing:



Fix the mounting bracket with the provided screws. This must be very tight to hold the bracket, if the provided screw is fixed successfully, in that case the console should hold at around 100 kgs. Optionally extended bracket can be ordered with the pico systems which are longer and stronger than the standard one. For further information please ask your local distributor!

5.4 On-the-table test

All Pico units were preset and pretested before shipping!

Warning! Do not look either into the transmitter or the receiver optics because at this distance even the reflected laser beam can be dangerous to your eyes. Operating the system on much shorter distance than presumed originally can cause saturation or even permanent damage to the receiver. Always use optical attenuators for this kind of test.

The on-the-table test is easy to do. The units should be placed at about 2 m distance from each other with optical windows facing one another. Put an appropriate optical attenuator between the heads. Make all the necessary connection as described earlier to connect your device to the heads and power up the units. Turn ON the Outdoor Interconnection Units and check if the power LED is ON on the head.

You should be able to align the units without any tool and get full received level on the signal strength LED's. Make sure that the "Saturation" indicator is OFF. Adjust your attenuators if necessary to avoid saturation of the receivers. After obtaining the desired received level, check the data connection between devices. If there is a transmission problem check the status of the connecting devices (e.g. link ON) and cables. If there's no LINK signal, connect the network equipments back-to-back omitting the Black Box system to ensure that they work properly. Should they operate well, get in contact with your supplier or call the technical support (a Problem Report Form can be found at the end of this book).

6 Warranty conditions

Black Box Corp. warrants that the Black Box product purchased will free from defects in material and workmanship for a period of one (1) year from the date of purchase. This warranty period will not be extended by virtue of a repair of the product or a replacement of any component of the product during the warranty period.

This warranty covers only normal commercial use. Black Box Corp. is not responsible for warranty service should the Black Box identification marks, serial numbers or original seals be removed, altered, or broken, or should the product fail to be properly maintained or fail to function properly as a result of any modification, misuse, abuse, improper installation, neglect, improper shipping, damage caused by disasters such as fire, flood, earthquake or lightning, improper electrical current, or service other than by Black Box Corp. or its authorised partners.

If the Black Box product fails to operate as warranted at any time during the warranty period, Black Box Corp. will repair, or at its option, replace the defective product at no additional charge.

In no event will Black Box Corp. be liable for any damages including loss of data, lost profits, lost savings, lost business, or other incidental or consequential or indirect damages arising out of the installation, use, maintenance, performance, failure or interruption of the Black Box product, even if Black Box Corp. has been advised of the possibility of such damage.

If you purchased the Black Box product in the United States, some states do not allow the limitation or exclusion of liability for incidental or consequential damages, so the above limitation may not apply to you.

The purchaser or user shall have the responsibility to give Black Box Corp. prompt written notice of any warranty claims. If the product was purchased through an authorised partner of Black Box Corp., notice may be given in writing to that authorised partner in the area in which the product was being used.

The product may be returned to Black Box Corp. only if it has a Return Material Authorisation (RMA) number. The product must be shipped prepaid, insured and in the original shipping package or similar package for safe shipment. The RMA number must be marked on the outside of the shipping package. Any product returned without an RMA number shall be rejected.

Transportation charges for the return of the product will be paid by Black Box Corp. if it is determined by Black Box Corp. that the product was defective within the terms of the warranty; otherwise the purchaser or user shall be responsible for costs of return handling and transportation.

If the Black Box product does not operate as warranted above, the customer's sole remedy shall be repair or replacement. The foregoing warranties and remedies are exclusive and are in lieu of all other warranties, expressed or implied, either in fact or by operation of law, statutory or otherwise, including warranties of

merchantability and fitness for a particular purpose. Black Box Communication Corp. neither assumes nor authorises any other person to assume for it any other liability in connection with the sale, installation, use or maintenance of the product.

5. Schematic for connecting LAN's

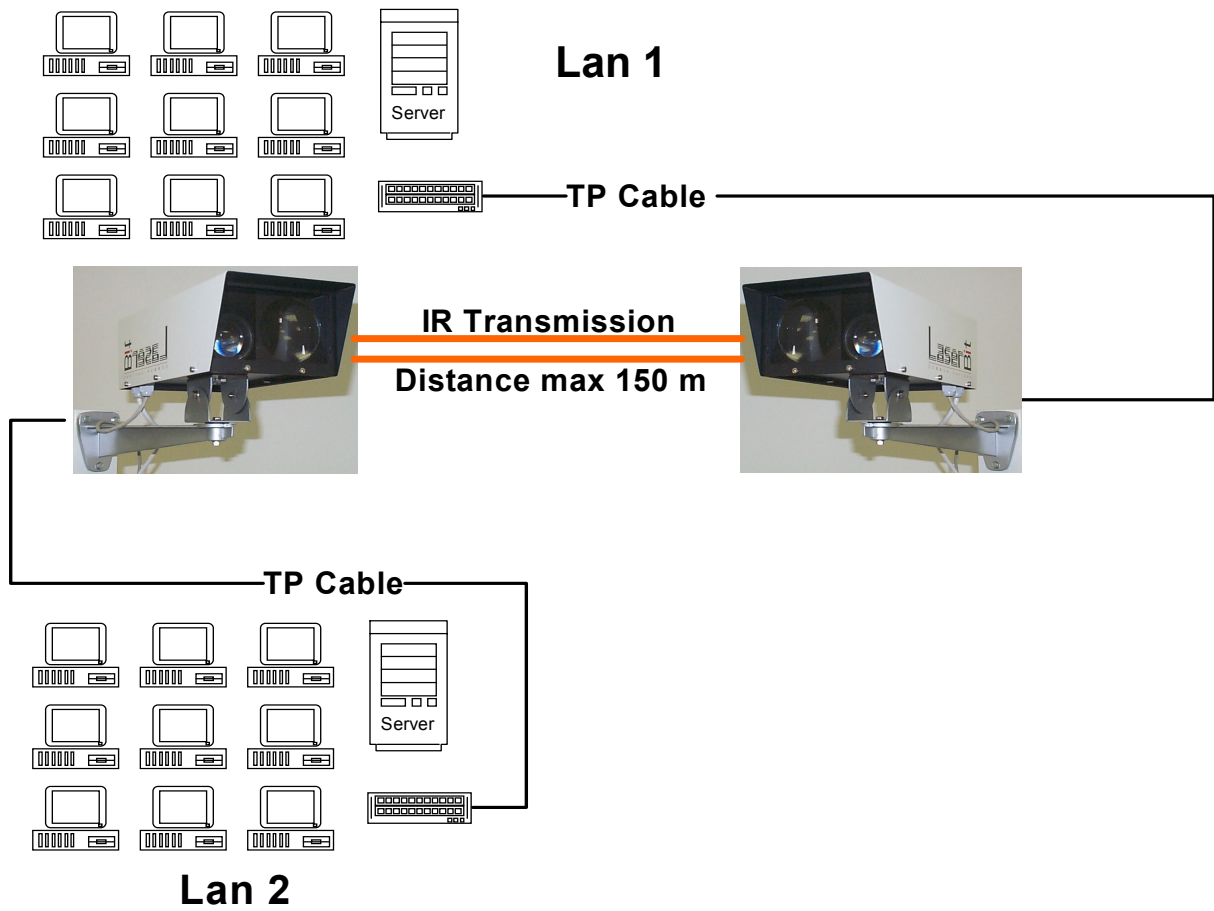

Schematic for Home Networking

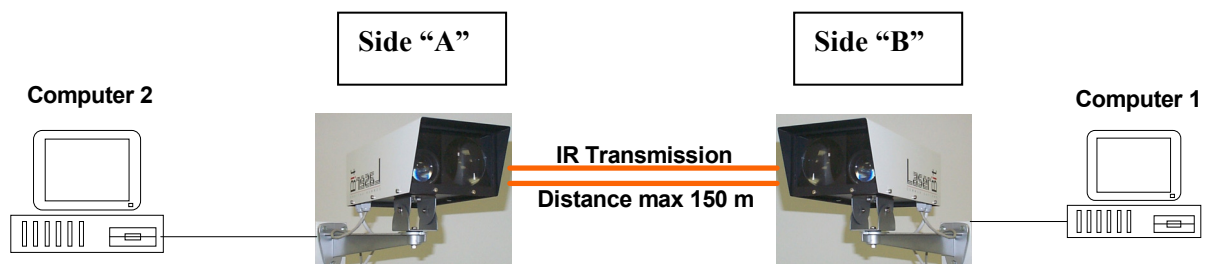

7 Twisted pair cabling

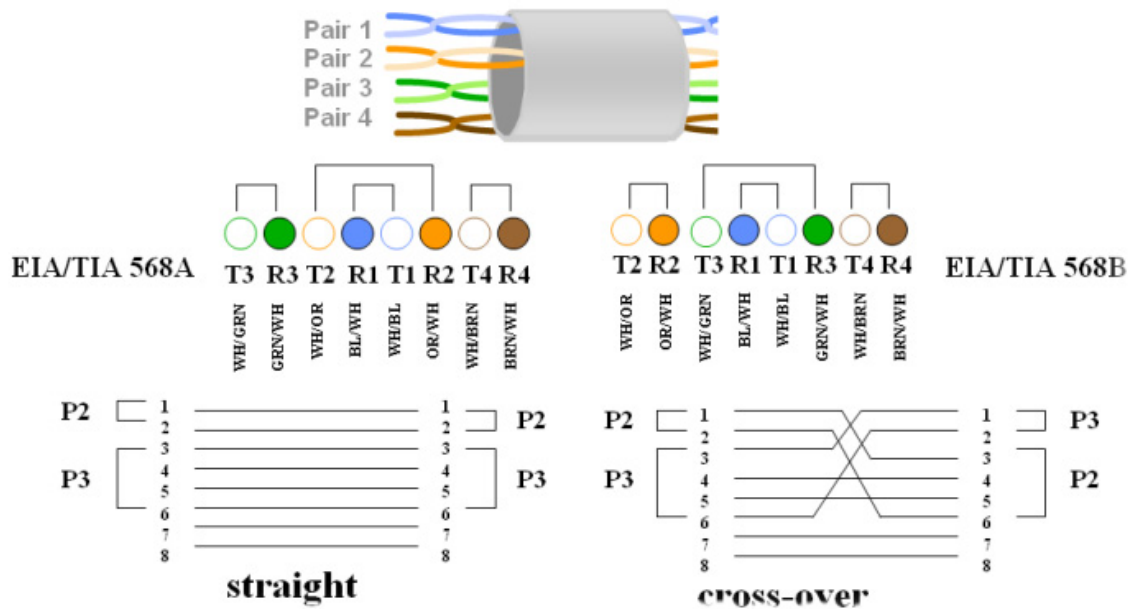

Free Manuals Download Website

<http://myh66.com>

<http://usermanuals.us>

<http://www.somanuals.com>

<http://www.4manuals.cc>

<http://www.manual-lib.com>

<http://www.404manual.com>

<http://www.luxmanual.com>

<http://aubethermostatmanual.com>

Golf course search by state

<http://golfingnear.com>

Email search by domain

<http://emailbydomain.com>

Auto manuals search

<http://auto.somanuals.com>

TV manuals search

<http://tv.somanuals.com>