

# DMX-800 Constellation™

## Snapshot

Ok on Dimmer	⊘
Outdoor OK	⊘
Sound Activated	✓
DMX512	✓
Master/Slave	✓
115V/230V Switch	✓
Replaceable Fuse	✓
User Serviceable	⊘
Duty Cycle	⊘

## USER MANUAL

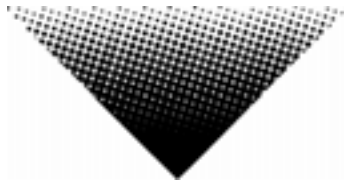

Chauvet, 3000 N 29<sup>th</sup> Ct, Hollywood, FL 33020 U.S.A.  
(800) 762-1084 – (954) 929-1115  
FAX (954) 929-5560  
[www.chauvetlighting.com](http://www.chauvetlighting.com)

# TABLE OF CONTENTS

<b>1. BEFORE YOU BEGIN</b> .....	<b>3</b>
WHAT IS INCLUDED.....	3
UNPACKING INSTRUCTIONS.....	3
AC POWER.....	3
CONTACT US.....	3
SAFETY INSTRUCTIONS.....	4
<b>2. INTRODUCTION</b> .....	<b>5</b>
FEATURES.....	5
DMX CHANNEL SUMMARY.....	5
PRODUCT OVERVIEW.....	6
<b>3. SETUP</b> .....	<b>7</b>
LAMP.....	7
Lamp Installation.....	7
FUSE REPLACEMENT.....	8
FIXTURE LINKING.....	8
Data Cabling.....	8
DMX Data Cable.....	8
Cable Connectors.....	9
3-Pin to 5-Pin Conversion Chart.....	9
SETTING UP A DMX SERIAL DATA LINK.....	9
MASTER/SLAVE FIXTURE LINKING.....	10
MOUNTING.....	10
Orientation.....	10
Rigging.....	10
<b>4. OPERATING INSTRUCTIONS</b> .....	<b>11</b>
NAVIGATING THE CONTROL PANEL.....	11
MENU MAP.....	11
Menu Functions.....	12
OPERATION.....	12
Stand-Alone Mode (Sound-Active, Auto Mode):.....	12
Master/Slave Mode (Master Sound, Master Auto):.....	12
DMX Mode.....	13
DMX CHANNEL VALUES (19-CHANNEL MODE).....	13
DMX CHANNEL VALUES (13-CHANNEL MODE).....	14
Gobo DMX Values.....	14
GENERAL TROUBLESHOOTING.....	15
TECHNICAL SUPPORT.....	16
<b>5. APPENDIX</b> .....	<b>16</b>
DMX PRIMER.....	16
GENERAL MAINTENANCE.....	17
RETURNS PROCEDURE.....	17
CLAIMS.....	17
TECHNICAL SPECIFICATIONS.....	18

# 1. BEFORE YOU BEGIN

## What is included

- 1 x Constellation™
- 1 x HMI 575W Lamp
- Power Cord
- Warranty Card
- User Manual

## Unpacking Instructions

Immediately upon receiving a fixture, carefully unpack the carton, check the contents to ensure that all parts are present, and have been received in good condition. Notify the shipper immediately and retain packing material for inspection if any parts appear damaged from shipping or the carton itself shows signs of mishandling. Save the carton and all packing materials. In the event that a fixture must be returned to the factory, it is important that the fixture be returned in the original factory box and packing.

## AC Power

To determine the power requirements for a particular fixture, see the label affixed to the back plate of the fixture or refer to the fixture's specifications chart. A fixture's listed current rating is its average current draw under normal conditions. All fixtures must be powered directly off a switched circuit and cannot be run off a rheostat (variable resistor) or dimmer circuit, even if the rheostat or dimmer channel is used solely for a 0% to 100% switch. Before applying power to a fixture, check that the source voltage matches the fixture's requirement. Check the fixture or device carefully to make sure that if a voltage selection switch exists that it is set to the correct line voltage you will use.

Figure 1 - AC Voltage Switch



Not all fixtures have a voltage select switch. Please be sure to connect to the proper voltage.

### **Warning!**

**Verify that the voltage select switch on your unit matches the line voltage applied. Damage to your fixture may result if the line voltage applied does not match the voltage indicated on the voltage selector switch. All fixtures must be connected to circuits with a suitable Earth Ground.**

## Contact Us

### World Wide

#### **General Information**

Chauvet Lighting  
3000 North 29<sup>th</sup> Court  
Hollywood, FL 33020  
voice: 954.929.1115  
fax: 954.929.5560  
toll free: 800.762.1084

#### **Technical Support**

Chauvet Lighting  
3000 North 29<sup>th</sup> Court  
Hollywood, FL 33020  
voice: 954.929.1115 **(Press 4)**  
fax: 954.929.5560 **(Attention: Service)**

#### **World Wide Web**

[www.chauvetlighting.com](http://www.chauvetlighting.com)

## Safety Instructions



Please read these instructions carefully, which includes important information about the installation, usage and maintenance of this product.

- Please keep this User Guide for future consultation. If you sell the unit to another user, be sure that they also receive this instruction booklet.
- Always make sure that you are connecting to the proper voltage, and that the line voltage you are connecting to is not higher than that stated on the decal or rear panel of the fixture.
- This product is intended for indoor use only!
- To prevent risk of fire or shock, do not expose fixture to rain or moisture. Make sure there are no flammable materials close to the unit while operating.
- The unit must be installed in a location with adequate ventilation, at least 20in (50cm) from adjacent surfaces. Be sure that no ventilation slots are blocked.
- Always disconnect from power source before servicing or replacing lamp or fuse and be sure to replace with same lamp source.
- Secure fixture to fastening device using a safety chain. Never carry the fixture solely by its head. Use its carrying handles.
- Maximum ambient temperature (Ta) is 95°F (35°C). Do not operate fixture at temperatures higher than this.
- In the event of a serious operating problem, stop using the unit immediately. Never try to repair the unit by yourself. Repairs carried out by unskilled people can lead to damage or malfunction. Please contact the nearest authorized technical assistance center. Always use the same type spare parts.
- Don't connect the device to a dimmer pack.
- Make sure the power cord is never crimped or damaged.
- Never disconnect the power cord by pulling or tugging on the cord.
- Avoid direct eye exposure to the light source while it is on.

### **Caution!**

***There are no user serviceable parts inside the unit. Do not open the housing or attempt any repairs yourself. In the unlikely event your unit may require service, please contact CHAUVET at: 954-929-1115.***

# 2. INTRODUCTION

## Features

- 13 or 19-channel DMX-512 centerpiece
- Pan: 180° / tilt: 90° (each mirror)
- Pan/tilt control of each mirror individually
- Mechanical dimmer/shutter/strobe
- Blackout, reset, sound activation and built-in automatic programs via DMX
- 6 rotating gobo wheels
  - 7 glass, rotating gobos + open on each wheel
  - Rotating gobo wheel spin effect for each wheel
- Remote fixture reset, lamp on/off and vector control channel

### Additional Features

- Built-in automated programs via master/slave or DMX
- Built-in sound activated programs via master/slave or DMX
- Centrally-located lamp holder for easy lamp changes
- Micro-stepping motors
- LED display
- Thermal switch
- Fan cooled

## DMX Channel Summary

CHANNEL	FUNCTION (19 CHANNEL MODE)	CHANNEL	FUNCTION (13 CHANNEL MODE)
1	Pan 1	1	Pan 1 & 4
2	Tilt 1	2	Tilt 1 & 4
3	Pan 2	3	Pan 2 & 5
4	Tilt 2	4	Tilt 2 & 5
5	Pan 3	5	Pan 3 & 6
6	Tilt 3	6	Tilt 3 & 6
7	Pan 4	7	Vector Speed
8	Tilt 4	8	Shutter/Strobe
9	Pan 5	9	Gobo 1 & 4
10	Tilt 5	10	Gobo 2 & 5
11	Pan 6	11	Gobo 3 & 6
12	Tilt 6	12	Gobo Rotate
13	Vector Speed	13	Lamp On/Off, Reset & Auto Modes
14	Shutter/Strobe		
15	Gobo 1 & 4		
16	Gobo 2 & 5		
17	Gobo 3 & 6		
18	Gobo Rotate		
19	Lamp On/Off, Reset & Auto Modes		

# Product Overview

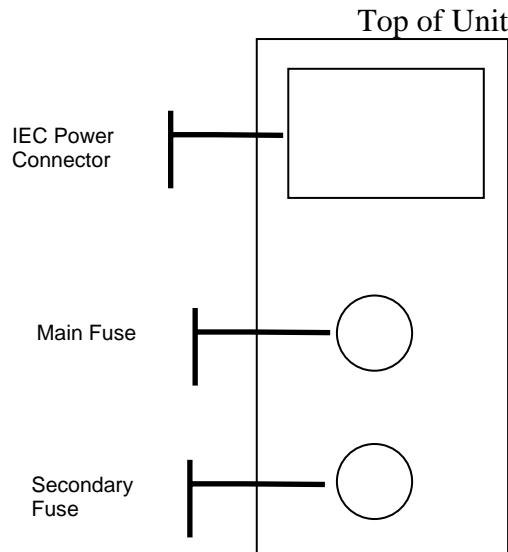
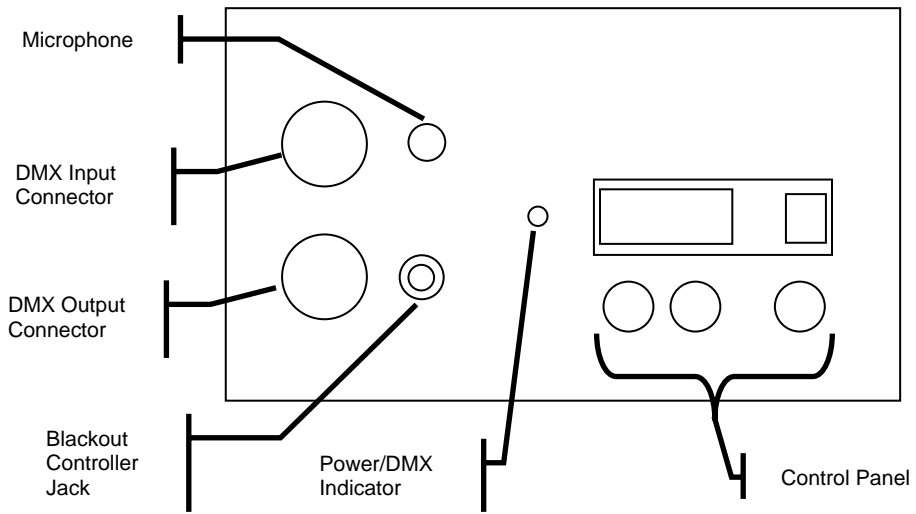

# 3. SETUP

## Lamp

You will need to install a lamp prior to the initial operation of the fixture. A 575W HMI lamp is included.

**Warning!** *When replacing the lamp, please wait 15 minutes after powering down to allow the unit to cool down! Always disconnect from main power prior to lamp replacement.*

Do not touch the envelope (glass area) of the bulb with bare hands. If this happens, clean the lamp with alcohol and wipe it with a lint free cloth before installation.

## Lamp Installation

- 1) Remove the three screws on the lamp cover plate as indicated in figure A.
- 2) Remove the two thumbscrews and the metal strip shown in figure B.
- 3) Unscrew the lamp from the socket by turning it counter-clockwise (figure C).
- 4) While holding the new lamp with a lint-free cloth, screw the lamp into the socket.
- 5) Replace the two thumbscrews and the metal strip.
- 6) Replace the lamp cover plate.

Figure A



Figure B

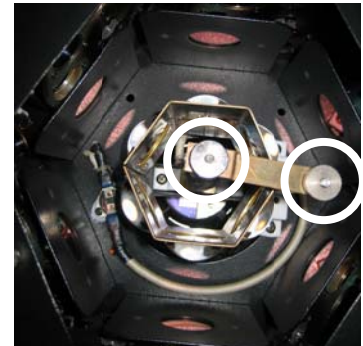
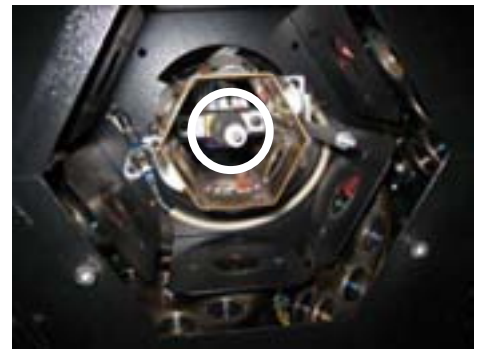

Figure C





Disconnect the power cord before replacing a fuse and always replace with the same type fuse.



## Fuse Replacement

With a flat-head screwdriver, unscrew the fuse holder from its housing. Remove the damaged fuse from its holder and replace with exact same type fuse. Screw the fuse holder back in its place and reconnect power.

The fuse is located inside this compartment. Remove using a flat head screwdriver.



FUSE

## Fixture Linking

You will need a serial data link to run light shows of one or more fixtures using a DMX-512 controller or to run synchronized shows on two or more fixtures set to a master/slave operating mode. The combined number of channels required by all the fixtures on a serial data link determines the number of fixtures the data link can support.

**Important:** Fixtures on a serial data link must be daisy chained in one single line. To comply with the EIA-485 standard no more than 32 devices should be connected on one data link. Connecting more than 32 fixtures on one serial data link without the use of a DMX optically-isolated splitter may result in deterioration of the digital DMX signal.

Maximum recommended serial data link distance: 500 meters (1640 ft.)

Maximum recommended number of fixtures on a serial data link: 32 fixtures

## Data Cabling

To link fixtures together you must obtain data cables. You can purchase CHAUVET-certified DMX cables directly from a dealer/distributor or construct your own cable. If you choose to create your own cable please use data-grade cables that can carry a high quality signal and are less prone to electromagnetic interference.

## DMX DATA CABLE

Use a Belden© 9841 or equivalent cable which meets the specifications for EIA RS-485 applications. Standard microphone cables cannot transmit DMX data reliably over long distances. The cable will have the following characteristics:

*2-conductor twisted pair plus a shield*  
*Maximum capacitance between conductors – 30 pF/ft.*  
*Maximum capacitance between conductor and shield – 55 pF/ft.*  
*Maximum resistance of 20 ohms / 1000 ft.*  
*Nominal impedance: 100 – 140 ohms*



## CABLE CONNECTORS

Cabling must have a male XLR connector on one end and a female XLR connector on the other end.

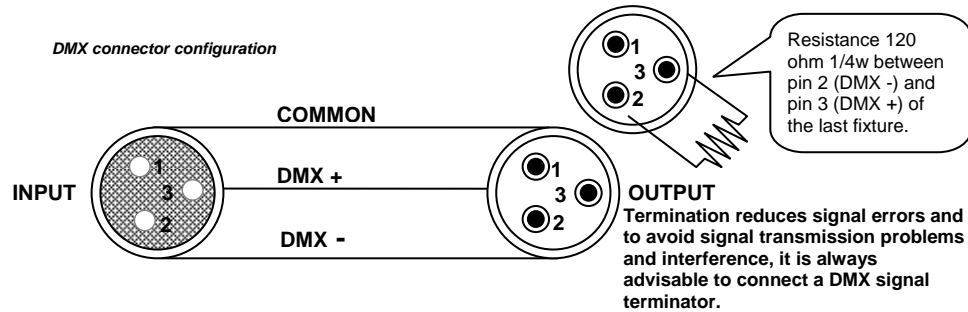

**CAUTION** Do not allow contact between the common and the fixture's chassis ground. Grounding the common can cause a ground loop, and your fixture may perform erratically. Test cables with an ohm meter to verify correct polarity and to make sure the pins are not grounded or shorted to the shield or each other.

## 3-PIN TO 5-PIN CONVERSION CHART

**Note!** If you use a controller with a 5 pin DMX output connector, you will need to use a 5 pin to 3 pin adapter. CHAUVET Model No: DMX5M, or DMX5F. The chart below details a proper cable conversion:

3 PIN TO 5 PIN CONVERSION CHART		
Conductor	3 Pin Female (output)	5 Pin Male (Input)
Ground/Shield	Pin 1	Pin 1
Data ( - ) signal	Pin 2	Pin 2
Data ( + ) signal	Pin 3	Pin 3
Do not use		Do not use
Do not use		Do not use

## Setting up a DMX Serial Data Link

1. Connect the (male) 3 pin connector side of the DMX cable to the output (female) 3 pin connector of the controller.
2. Connect the end of the cable coming from the controller which will have a (female) 3 pin connector to the input connector of the next fixture consisting of a (male) 3 pin connector.
3. Then, proceed to connect from the output as stated above to the input of the following fixture and so on.

### CHAUVET Certified DMX Data Cables

Order Code	Description
DMX1.5	DMX Cable 1.5m/4.9ft
DMX4.5	DMX Cable 4.5m/14.8ft
DMX10	DMX Cable 10m/32.8ft

### Universal DMX Controller

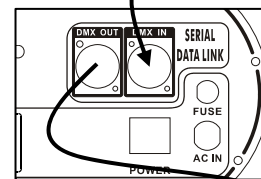
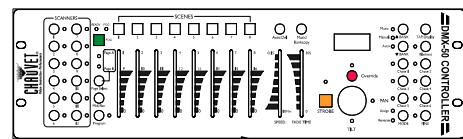

This drawing provides a general illustration of the DMX Input/Output panel of a lighting fixture.

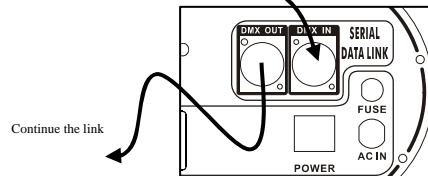

## Master/Slave Fixture Linking

1. Connect the (male) 3 pin connector side of the DMX cable to the output (female) 3 pin connector of the first fixture.
2. Connect the end of the cable coming from the first fixture which will have a (female) 3 pin connector to the input connector of the next fixture consisting of a (male) 3 pin connector. Then, proceed to connect from the output as stated above to the input of the following fixture and so on.

Often, the setup for Master-Slave and Standalone operation requires that the first fixture in the chain be initialized for this purpose via either settings in the control panel or DIP-switches. Secondly, the fixtures that follow may also require a slave setting. Please consult the "Operating Instructions" section in this manual for complete instructions for this type of setup and configuration.

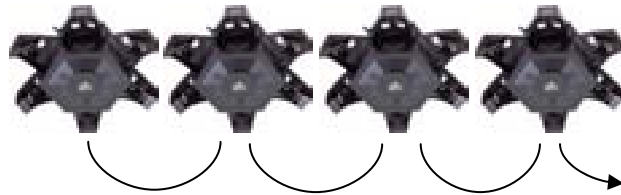

## Mounting

### ORIENTATION

This fixture may be mounted in any position provided there is adequate room for ventilation.

### RIGGING

It is important never to obstruct the fan or vents pathway. Mount the fixture using a suitable "C" or "O" type clamp. Adjust the angle of the fixture by loosening both knobs and tilting the fixture. After finding the desired position, retighten both knobs.

- When selecting installation location, take into consideration lamp replacement access and routine maintenance.
- Safety cables should always be used.
- Never mount in places where the fixture will be exposed to rain, high humidity, extreme temperature changes or restricted ventilation.
- Use only heavy duty clamps for this fixture.



Note!  
Clamp is sold separately.

# 4. OPERATING INSTRUCTIONS

## Navigating the Control Panel

Access control panel functions using the three panel buttons located directly underneath the LCD Display.

Button	Function
<MODE>	Used to access the menu and scroll through top-level menu items.
<UP>	Scrolls through menu options in ascending order
<DOWN>	Scrolls through menu options in descending order

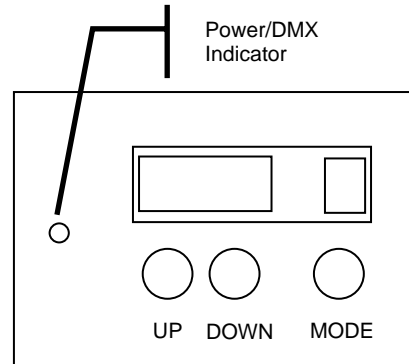

The Control Panel LED Display shows the menu items you select from the menu map below. When a menu function is selected, the display will show immediately the first available option for the selected menu function. **NOTE:** the Power/DMX indicator will blink slowly if a signal is detected on the DMX input connector, and will be solid if no signal is detected.





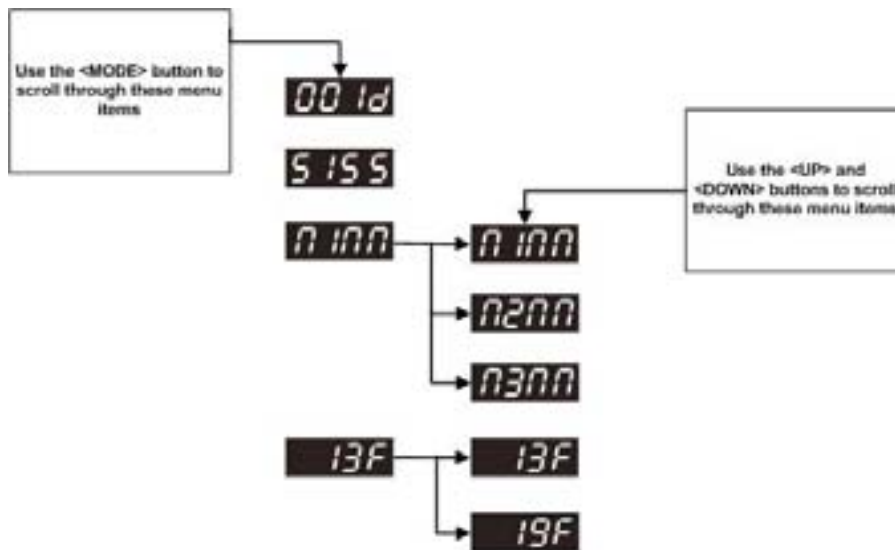

Press the <MODE> button once to activate the control panel. Pressing the <MODE> button again will scroll through the different top-level menu options available. Use the <UP> and <DOWN> buttons to navigate the menu options. To return to the previous option or menu without changing the value, press the <MODE> button.

## Menu Map



**When navigating the menu:**  
 Use the "MODE" button to move left, or to scroll through the left-most items in the menu map.  
 Use the "UP" button to move up.  
 Use the "DOWN" button to move down.





## Menu Functions

MENU OPTION	DESCRIPTION
	<b>DMX:</b> The fixture will be controlled by a DMX signal coming from a DMX controller. The starting address must be selected, and can be set using the up and down buttons.
	<b>Slave Unit:</b> Sets the fixture to run in sync with the Master. You must set the first fixture in the data link to "Master" otherwise nothing will happen.
	<b>Sound Active – Master Unit:</b> Sets the fixture to Master status for Master-Slave operation and the built in programs will be triggered by the sound. No data link is required; all fixtures can be set to this mode for Stand-alone operation.
	<b>Automatic – Master Unit:</b> Sets the fixture to Master status for Master-Slave operation and the built in programs will be triggered automatically to a pre-programmed time interval. No data link is required; all fixtures can be set to this mode for Stand-alone operation.
	<b>Blackout – Master Unit:</b> Sets the fixture to Master status for Master-Slave operation and closes the shutter. No data link is required; all fixtures can be set to this mode for blackout operation.
	<b>13 Channel Mode:</b> Sets the fixture to operate in 13 channel mode.
	<b>19 Channel Mode:</b> Sets the fixture to operate in 19 channel mode.

## Operation







### Stand-Alone Mode (Sound-Active, Auto Mode):

This mode allows a single unit to run to the beat of the music, or the unit will auto change in Auto Mode.

- Press <MODE/ESC> until , , or  is displayed.
- Use the <UP> and <DOWN> buttons to scroll through until the desired mode is displayed.  
 is auto mode;  is sound-active.
- The unit will react to the low frequencies of music via the internal microphone in Sound-Active mode, or the unit will auto change in Auto Mode.

### Master/Slave Mode (Master Sound, Master Auto):

This mode will allow you to link up to 32 units together without a controller.

- Use standard DMX cables to daisy chain your units together via the DMX connector on the rear of the units. For longer cable runs we suggest a terminator at the last fixture. For more information about terminators, see page 9.
- Choose a unit to function as the master. Press <MODE> until , , or  is displayed on the master unit.
- Use the <UP> and <DOWN> buttons to scroll through until the desired mode is displayed.  
 is auto mode;  is sound-active.
- Press <MODE> until,  is displayed on the slave units.

## DMX Mode

This mode allows the unit to be controlled by any universal DMX controller. If you are unfamiliar with DMX, please read the DMX Primer on page 16.

- 1) Press <MODE/ESC> until **00 12** is displayed.
- 2) Use the <UP> and <DOWN> buttons to select the desired address.

## DMX Channel Values (19-channel mode)

CHANNEL	VALUE	FUNCTION (19-CHANNEL MODE)
1	000 ⇔ 255	<b>Pan 1:</b> 128 = halfway point
2	000 ⇔ 255	<b>Tilt 1:</b> 128 = halfway point
3	000 ⇔ 255	<b>Pan 2:</b> 128 = halfway point
4	000 ⇔ 255	<b>Tilt 2:</b> 128 = halfway point
5	000 ⇔ 255	<b>Pan 3:</b> 128 = halfway point
6	000 ⇔ 255	<b>Tilt 3:</b> 128 = halfway point
7	000 ⇔ 255	<b>Pan 4:</b> 128 = halfway point
8	000 ⇔ 255	<b>Tilt 4:</b> 128 = halfway point
9	000 ⇔ 255	<b>Pan 5:</b> 128 = halfway point
10	000 ⇔ 255	<b>Tilt 5:</b> 128 = halfway point
11	000 ⇔ 255	<b>Pan 6:</b> 128 = halfway point
12	000 ⇔ 255	<b>Tilt 6:</b> 128 = halfway point
13	000 ⇔ 255	<b>Vector Speed:</b> (Normal > Slow)
14	000 ⇔ 099	<b>Dimmer/Shutter</b> Dimmer (0 – 100%)
	100 ⇔ 133	Open
	134 ⇔ 243	Strobe (Fast > Slow)
	244 ⇔ 249	No Function
	250 ⇔ 255	Open
15	000 ⇔ 255	<b>Gobo 1 &amp; 4</b>
16	000 ⇔ 255	<b>Gobo 2 &amp; 5</b>
17	000 ⇔ 255	<b>Gobo 3 &amp; 6</b>
18	000 ⇔ 016	<b>Gobo Rotate</b> No Function
	017 ⇔ 135	Counter-clockwise (Slow > Fast)
	136	No Rotate
	137 ⇔ 255	Clockwise Rotate (Slow > Fast)
19	000	<b>Mode</b> No Function
	001 ⇔ 007	Auto 1
	008 ⇔ 015	Auto 2
	016 ⇔ 023	Auto 3
	024 ⇔ 031	Auto 4
	032 ⇔ 039	Auto 5
	040 ⇔ 047	Auto 6
	048 ⇔ 055	Auto 7
	056 ⇔ 063	Auto 8
	064 ⇔ 071	Auto 9
	072 ⇔ 079	Auto 10
	080 ⇔ 087	Auto 11
	088 ⇔ 095	Auto 12
	096 ⇔ 103	Auto 13
	104 ⇔ 111	Auto 14
	112 ⇔ 119	Auto 15
	120 ⇔ 127	Auto 16
	128 ⇔ 160	Sound 1
	161 ⇔ 193	Lamp On (after 5 seconds)
194 ⇔ 226	Lamp off (after 5 seconds)	
227 ⇔ 254	Reset (after 5 seconds)	
255	No Function	

## DMX Channel Values (13-channel mode)

CHANNEL	VALUE	FUNCTION (19-CHANNEL MODE)
1	000 ⇔ 255	<b>Pan 1 &amp; 4:</b> 128 = halfway point
2	000 ⇔ 255	<b>Tilt 1 &amp; 4:</b> 128 = halfway point
3	000 ⇔ 255	<b>Pan 2 &amp; 5:</b> 128 = halfway point
4	000 ⇔ 255	<b>Tilt 2 &amp; 5:</b> 128 = halfway point
5	000 ⇔ 255	<b>Pan 3 &amp; 6:</b> 128 = halfway point
6	000 ⇔ 255	<b>Tilt 3 &amp; 6:</b> 128 = halfway point
7	000 ⇔ 255	<b>Vector Speed:</b> (Normal > Slow)
8	000 ⇔ 099	<b>Dimmer/Shutter</b> Dimmer (0 – 100%)
	100 ⇔ 133	Open
	134 ⇔ 243	Strobe (Fast > Slow)
	244 ⇔ 249	No Function
	250 ⇔ 255	Open
9	000 ⇔ 255	<b>Gobo 1 &amp; 4</b>
10	000 ⇔ 255	<b>Gobo 2 &amp; 5</b>
11	000 ⇔ 255	<b>Gobo 3 &amp; 6</b>
12	000 ⇔ 016	<b>Gobo Rotate</b> No Function
	017 ⇔ 135	Counter-clockwise (Slow > Fast)
	136	No Rotate
	137 ⇔ 255	Clockwise Rotate (Slow > Fast)
13	000	<b>Mode</b> No Function
	001 ⇔ 007	Auto 1
	008 ⇔ 015	Auto 2
	016 ⇔ 023	Auto 3
	024 ⇔ 031	Auto 4
	032 ⇔ 039	Auto 5
	040 ⇔ 047	Auto 6
	048 ⇔ 055	Auto 7
	056 ⇔ 063	Auto 8
	064 ⇔ 071	Auto 9
	072 ⇔ 079	Auto 10
	080 ⇔ 087	Auto 11
	088 ⇔ 095	Auto 12
	096 ⇔ 103	Auto 13
	104 ⇔ 111	Auto 14
	112 ⇔ 119	Auto 15
	120 ⇔ 127	Auto 16
	128 ⇔ 160	Sound 1
	161 ⇔ 193	Lamp On (after 5 seconds)
	194 ⇔ 226	Lamp off (after 5 seconds)
227 ⇔ 254	Reset (after 5 seconds)	
255	No Function	

## Gobo DMX Values

VALUE	GOBO
000 ⇔ 015	Open
016 ⇔ 031	Gobo 1
032 ⇔ 047	Gobo 2
048 ⇔ 063	Gobo 3
064 ⇔ 079	Gobo 4
080 ⇔ 095	Gobo 5
096 ⇔ 111	Gobo 6
112 ⇔ 127	Gobo 7
128 ⇔ 191	Gobo scroll counter-clockwise (Fast > Slow)
192 ⇔ 255	Gobo scroll clockwise (Fast > Slow)

## General Troubleshooting

Symptom	Solution(s)	Applies to			
		Lights	Foggers & Snow	Controllers	Dimmers & Chaser
Auto shut off	Check fan thermal switch reset	✓			
Beam is very dim or not bright	Clean optical system or replace lamp Check 220/110v switch for proper setting	✓			
Breaker/Fuse keeps blowing	Check total load placed on device				✓
Chase is too slow	Check users manual for speed adjustment	✓		✓	✓
Device has no power	Check for power on Mains. Check device's fuse. (internal and/or external)	✓		✓	✓
Fixture is not responding	Check DMX Dip switch settings for correct addressing Check DMX cables Check polarity switch settings	✓			
Fixture is on but there is no movement to the audio	Make sure you have the correct audio mode on the control switches. If audio provided via ¼" jack, make sure a live audio signal exists Adjust sound sensitivity knob	✓		✓	✓
Lamps cuts off sporadically	Possible bad lamp or fixture is overheating. Lamp may be at end of its life.	✓			
Light will not come on after power failure	Some discharge lamps require a cooling off period before the electronics in the fixture can kick start it again, wait 5 to 10 minutes before powering up	✓			
Loss of signal	Use only DMX cables Install terminator Note: Keep DMX cables separated from power cables or black lights.	✓	✓	✓	✓
Moves slow	Check 220/110v switch for proper setting	✓			
No flash	Re-install bulb, may have shifted in shipping	✓			
No laser output	Bounce mirror motor may have shifted during shipping, readjust	✓			
No light output	Check slip ring & brushes for contact Install bulb Call service technician	✓			
Relay will not work	Check reset switch Check cable connections				✓
Remote does not work	Make sure connector is firmly connected to device	✓	✓		
Stand alone mode	All Chauvet lighting fixtures featuring stand-alone functions do not require additional settings, simply power the fixture and it will automatically enter into this mode	✓			

**If you still have a problem after trying the above solutions, please contact CHAUVET Technical Support at the location on the next page.**

## Technical Support

Address: Service Dept.  
3000 N 29th Ct, Hollywood, FL 33020 (U.S.A.)  
Support (Email): [tech@chauvetlighting.com](mailto:tech@chauvetlighting.com)  
Telephone: (954) 929-1115 - (Press 4)  
Fax: (954) 929-5560 - (Attention: Service)  
Website: <http://www.chauvetlighting.com>

# 5. APPENDIX

## DMX Primer

There are 512 channels in a DMX-512 connection. Channels may be assigned in any manner. A fixture capable of receiving DMX 512 will require one or a number of sequential channels. The user must assign a starting address on the fixture that indicates the first channel reserved in the controller. There are many different types of DMX controllable fixtures and they all may vary in the total number of channels required. Choosing a start address should be planned in advance. Channels should never overlap. If they do, this will result in erratic operation of the fixtures whose starting address is set incorrectly. You can however, control multiple fixtures of the same type using the same starting address as long as the intended result is that of unison movement or operation. In other words, the fixtures will be slaved together and all respond exactly the same.

DMX fixtures are designed to receive data through a serial Daisy Chain. A Daisy Chain connection is where the DATA OUT of one fixture connects to the DATA IN of the next fixture. The order in which the fixtures are connected is not important and has no effect on how a controller communicates to each fixture. Use an order that provides for the easiest and most direct cabling. Connect fixtures using shielded two conductor twisted pair cable with three pin XLR male to female connectors. The shield connection is pin 1, while pin 2 is Data Negative (S-) and pin 3 is Data positive (S+). CHAUVET carries 3-pin XLR DMX compliant cables, DMX-10 (33'), DMX-4.5 (15') and DMX-1.5 (5')



## General Maintenance

To maintain optimum performance and minimize wear fixtures should be cleaned frequently. Usage and environment are contributing factors in determining frequency. As a general rule, fixtures should be cleaned at least twice a month. Dust build up reduces light output performance and can cause overheating. This can lead to reduced lamp life and increased mechanical wear. Be sure to power off fixture before conducting maintenance.

Unplug fixture from power. Use a vacuum or air compressor and a soft brush to remove dust collected on external vents and internal components. Clean all glass when the fixture is cold with a mild solution of glass cleaner or Isopropyl Alcohol and a soft lint free cotton cloth or lens tissue. Apply solution to the cloth or tissue and drag dirt and grime to the outside of the lens. Gently polish optical surfaces until they are free of haze and lint.

The cleaning of internal and external optical lenses and/or mirrors must be carried out periodically to optimize light output. Cleaning frequency depends on the environment in which the fixture operates: damp, smoky or particularly dirty surrounding can cause greater accumulation of dirt on the unit's optics. Clean with soft cloth using normal glass cleaning fluid. - Always dry the parts carefully. - Clean the external optics at least every 20 days. Clean the internal optics at least every 30/60 days.

## Returns Procedure

Returned merchandise must be sent prepaid and in the original packing, call tags will not be issued. Package must be clearly labeled with a Return Merchandise Authorization Number (RA #). Products returned without an RA # will be refused. Call CHAUVET and request RA # prior to shipping the fixture. Be prepared to provide the model number, serial number and a brief description of the cause for the return. Be sure to properly pack fixture, any shipping damage resulting from inadequate packaging is the customer's responsibility. CHAUVET reserves the right to use its own discretion to repair or replace product(s). As a suggestion, proper UPS packing or double-boxing is always a safe method to use.

**Note: If you are given an RA #, please include the following information on a piece of paper inside the box:**

- 1) Your name
- 2) Your address
- 3) Your phone number
- 4) The RA #
- 5) A brief description of the symptoms

## Claims

Damage incurred in shipping is the responsibility of the shipper; therefore the damage must be reported to the carrier upon receipt of merchandise. It is the customer's responsibility to notify and submit claims with the shipper in the event that a fixture is damaged due to shipping. Any other claim for items such as missing component/part, damage not related to shipping, and concealed damage, must be made within seven (7) days of receiving merchandise.

# Technical Specifications

## WEIGHT & DIMENSIONS

Length..... 33.5 in (850 mm)  
Width ..... 31.5 in (800 mm)  
Height..... 11.8 in (300 mm)  
Weight ..... 99.2 lbs (45 kg)

## POWER

Switch-selectable power settings ..... 110V 60Hz AC or 230V 50Hz  
Power Consumption ..... 840W Max  
Inrush Power ..... 936W

## LIGHT SOURCE

Lamp..... HMI 575W Lamp

## APPROVED LAMPS

Osram™ HMI575/GS ..... 1000 hr, 6000K, 575W  
Philips™ MSI-575/2..... 1000 hr, 7000K, 575W  
Philips™ MSI-575/HR ..... 1000 hr, 6000K, 575W

## PHOTO OPTIC

Beam Angle (each beam)..... 12°  
Beam Angle (entire unit)..... 73°  
Pan ..... 570°  
Tilt..... 270°  
Illuminance at 1m ..... 9,784 fc (105,276 lux)

## THERMAL

Maximum ambient temperature..... 95°F (35°C)

## FUSE

Main..... 20mm Glass 15A 250V Fast Blow  
Secondary ..... 20mm Glass 3A 250V Fast Blow

## CONTROL & PROGRAMMING

Data input ..... locking 3-pin XLR male socket  
Data output..... locking 3-pin XLR female socket  
Data pin configuration ..... pin 1 shield, pin 2 (-), pin 3 (+)  
Protocols..... DMX-512 USITT  
DMX Channels ..... 13/19

## ORDERING INFORMATION

Constellation..... DMX-800

## WARRANTY INFORMATION

Warranty..... 2-year limited warranty

## Free Manuals Download Website

<http://myh66.com>

<http://usermanuals.us>

<http://www.somanuals.com>

<http://www.4manuals.cc>

<http://www.manual-lib.com>

<http://www.404manual.com>

<http://www.luxmanual.com>

<http://aubethermostatmanual.com>

Golf course search by state

<http://golfingnear.com>

Email search by domain

<http://emailbydomain.com>

Auto manuals search

<http://auto.somanuals.com>

TV manuals search

<http://tv.somanuals.com>