

COLORrail™

User Manual

It's Green Thinking

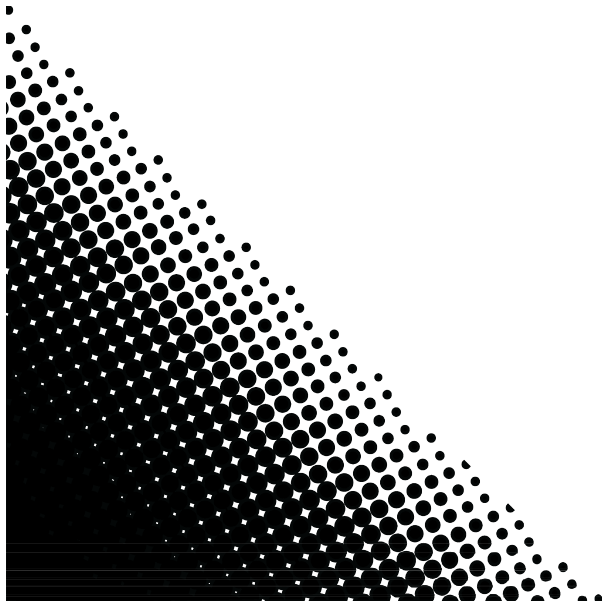
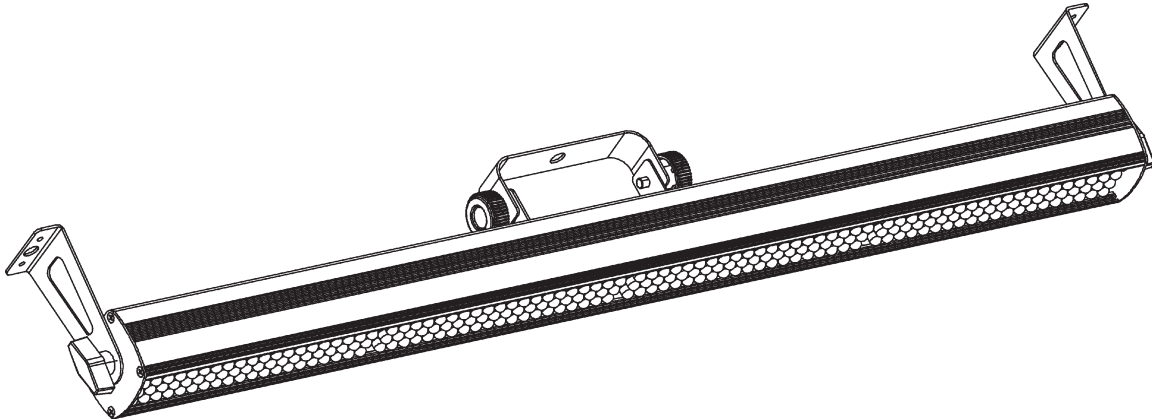

TABLE OF CONTENTS

| | |
|--|-----------|
| 1. BEFORE YOU BEGIN | 3 |
| WHAT IS INCLUDED..... | 3 |
| UNPACKING INSTRUCTIONS..... | 3 |
| MANUAL CONVENTIONS..... | 3 |
| ICONS..... | 3 |
| SAFETY INSTRUCTIONS..... | 4 |
| 2. INTRODUCTION | 5 |
| PHOTOMETRICS..... | 5 |
| PRODUCT OVERVIEW..... | 6 |
| 3. SETUP | 7 |
| AC POWER..... | 7 |
| <i>Power Linking</i> | 7 |
| MOUNTING..... | 8 |
| <i>Orientation</i> | 8 |
| <i>Rigging</i> | 8 |
| 4. OPERATING INSTRUCTIONS | 9 |
| MENU MAP..... | 9 |
| CONFIGURING THE STARTING ADDRESS..... | 10 |
| <i>DMX Operation</i> | 10 |
| <i>Master/Slave Mode (Sound-Active, Auto Mode)</i> | 10 |
| <i>Automatic</i> | 11 |
| <i>Program Selection</i> | 11 |
| <i>Sound-Active</i> | 11 |
| <i>Static Color</i> | 11 |
| DMX CHANNEL VALUES..... | 12 |
| <i>26-CH Mode</i> | 12 |
| <i>14-CH Mode</i> | 13 |
| <i>7-CH Mode</i> | 14 |
| <i>4-CH Mode</i> | 15 |
| <i>3-CH Mode</i> | 15 |
| <i>2-CH Mode</i> | 15 |
| 5. APPENDIX | 16 |
| GENERAL TROUBLESHOOTING..... | 16 |
| DMX PRIMER..... | 17 |
| FIXTURE LINKING (DAISY CHAIN)..... | 17 |
| DATA CABLING..... | 17 |
| <i>DMX Data Cable</i> | 17 |
| CABLE CONNECTORS..... | 18 |
| SETTING THE STARTING ADDRESS..... | 18 |
| <i>3-Pin to 5-Pin Conversion Chart</i> | 19 |
| <i>Setting up a DMX Daisy Chain</i> | 19 |
| GENERAL MAINTENANCE..... | 20 |
| RETURNS PROCEDURE..... | 20 |
| CLAIMS..... | 20 |
| TECHNICAL SPECIFICATIONS | 21 |
| CONTACT US | 22 |

CHAUVET®, 2010, All Rights Reserved

Information and specifications in this User Manual are subject to change without notice.

CHAUVET® assumes no responsibility or liability for any errors or inaccuracies that may appear in this manual.

Author: Anthony Chiappone

Revision: 01b

Release Date: 11-29-2010

1. BEFORE YOU BEGIN

What is included

- 1 x COLORrail™
- 1 x Mounting bracket kit
- 1 x Power Cord
- 1 x Warranty Card
- 1 x User Manual

Unpacking Instructions

Immediately upon receiving a fixture, carefully unpack the carton, check the contents to ensure that all parts are present, and have been received in good condition. Notify the shipper immediately and retain packing material for inspection if any parts appear damaged from shipping or the carton itself shows signs of mishandling. Save the carton and all packing materials. In the event that a fixture must be returned to the factory, it is important that the fixture be returned in the original factory box and packing.



Manual Conventions

CHAUVET® manuals use the following conventions to differentiate certain types of information from the regular text.

| CONVENTION | MEANING |
|-------------------------------|---|
| [10] | A DIP switch to be configured |
| <Menu> | A key to be pressed on the fixture's control panel |
| 1~512 | A range of values |
| 50/60 | A set of values of which only one can be chosen |
| Settings | A menu option not to be modified (for example, showing the operating mode/current status) |
| MENU > Settings | A sequence of menu options to be followed |
| ON | A value to be entered or selected |

Icons

This manual uses the following icons to indicate information that requires special attention on the part of the user.

| ICONS | MEANING |
|---|---|
|  | This paragraph contains critical installation, configuration or operation information. Failure to comply with this information may render the fixture partially or completely inoperative, cause damage to the fixture or cause harm to the user. |
|  | This paragraph contains important installation or configuration information. Failure to comply with this information may prevent the fixture from functioning correctly. |
|  | This paragraph reminds you of useful, although not critical, information. |

Safety Instructions



Please read these instructions carefully. It includes important information about the installation, usage and maintenance of this product.

- Please keep this User Manual for future consultation. If you sell the unit to another user, be sure that they also receive this instruction booklet.
- Always make sure that you are connecting to the proper voltage, and that the line voltage you are connecting to is not higher than that stated on the decal or rear panel of the fixture.
- This product is intended for indoor use only! To prevent risk of fire or shock, do not expose fixture to rain or moisture.
- Make sure there are no flammable materials close to the unit while operating.
- The unit must be installed in a location with adequate ventilation, at least 20 in (50 cm) from adjacent surfaces. Be sure that no ventilation slots are blocked.
- Always disconnect from power source before servicing or replacing fuse and be sure to replace with same fuse source.
- Secure fixture to fastening device using a safety chain.
- Maximum ambient temperature (Ta) is 104° F (40° C). Do not operate fixture at temperatures higher than this.
- In the event of a serious operating problem, stop using the unit immediately. Never try to repair the unit by yourself. Repairs carried out by unskilled people can lead to damage or malfunction. Please contact the nearest authorized technical assistance center.
- Never connect the device to a dimmer pack.
- Make sure the power cord is never crimped or damaged.
- Never disconnect the power cord by pulling or tugging on the cord.
- Never carry the fixture directly from the cord. Always use the hanging/mounting bracket.
- Avoid direct eye exposure to the light source while it is on.

2. INTRODUCTION

Photometrics

The field and beam angles provided refer to a single section of the COLORrail™ fixture. When calculating the coverage of the product for a specific application, consider that the total output of the fixture will not be circular, but rather oval-shaped. This is due to the rectangular design of the fixture.

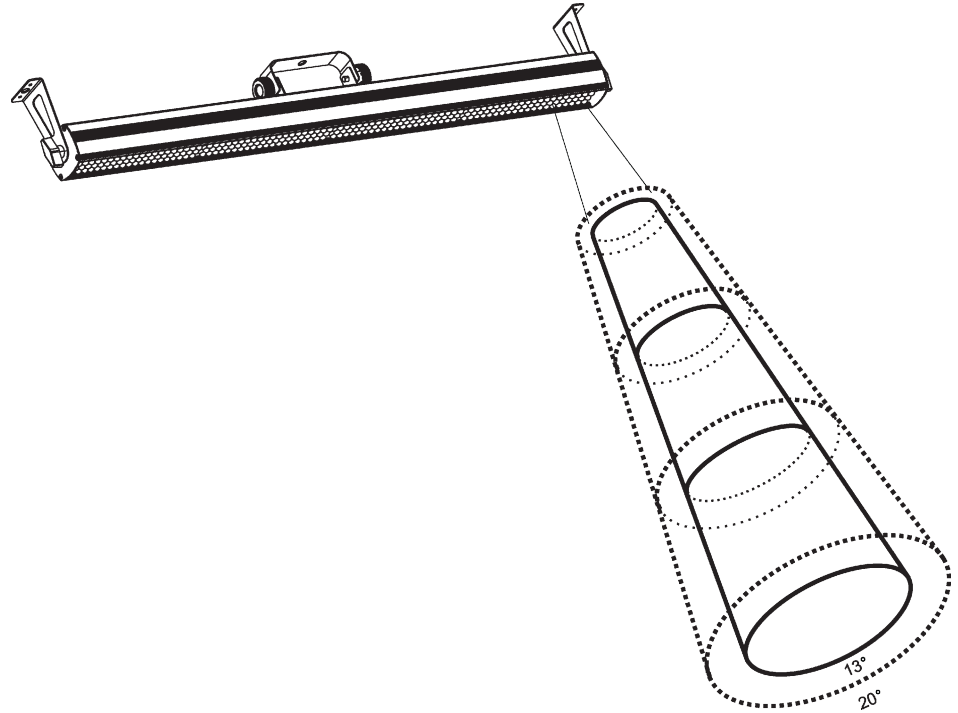

Product Overview

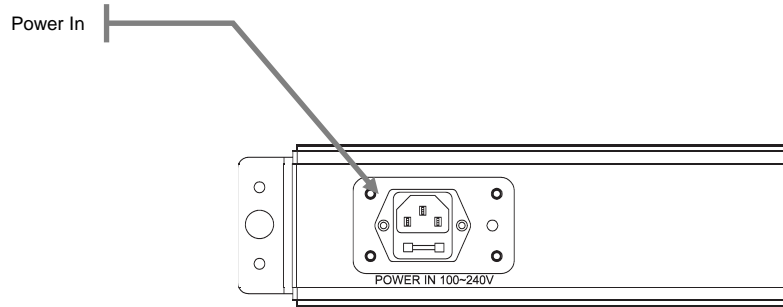
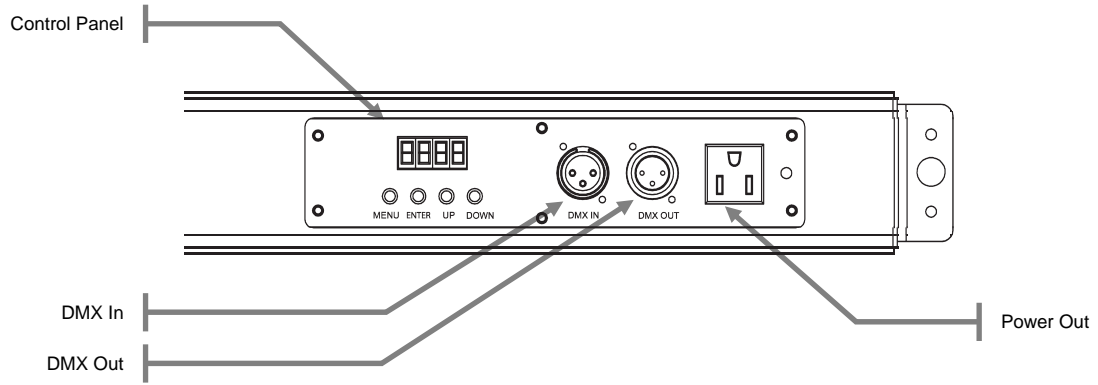

3. SETUP

AC Power

This fixture runs on 100~240 VAC, 50/60 Hz. Before powering on the unit, make sure the line voltage to which you are connecting it is within the range of accepted voltages.

To determine the power requirements for a particular fixture, see the label affixed to the back plate of the fixture or refer to the fixture's specifications chart. A fixture's listed current rating indicates its average current draw under normal conditions.



Always connect the fixture to a switched circuit. Never connect the fixture to a rheostat (variable resistor) or dimmer circuit, even if the rheostat or dimmer channel is used only as a 0 to 100% switch.



Always connect the fixture to a circuit with a suitable electrical ground.

Power Linking

This fixture contains power linking via the Edison outlet located in front of the power input cable. Please see the diagram below for further explanation.



The maximum quantity of COLORrail™ that may be linked is 15.

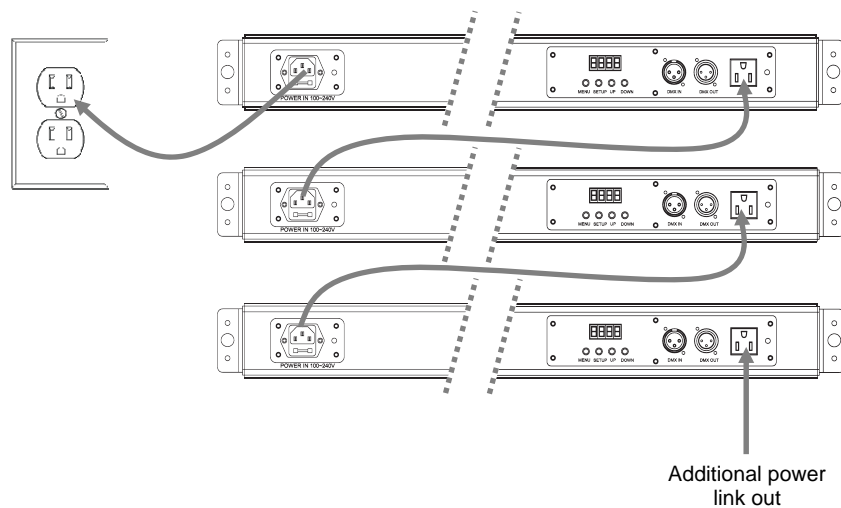

The power linking shown in this document is for the Chauvet® North American version ONLY! Therefore, it is the customer's responsibility to check with the Dealer/Distributor regarding power linking on the local version of the product. Connections and availability may change, depending on the power requirements and/or regulations of each country/region.

Mounting

Orientation

The COLORrail™ may be mounted in any position provided there is adequate room for ventilation.

Rigging

Be sure that the structure can support the weight of the fixture. Please see the "Technical Specifications" section of this manual for a detailed weight listing. Mount the fixture securely. This may be done with a screw, nut and bolt, or a hanging clamp. The hole in each bracket is 13 mm in size. When rigging, consider routine maintenance and control panel access. Please see the following notes on installation.

- If the power link out is intended to be used with multiple fixture, take into account the length of each power cable, and mount the fixtures close enough to one another to accommodate for this.
- When aiming the fixtures, you may use the bracket/yoke adjustment knob(s). Loosen the knob(s), adjust to the desired angle, and then tighten the knob(s) by turning clockwise. Do not use tools for this step, as it may cause damage.
- Safety cables must always be used.

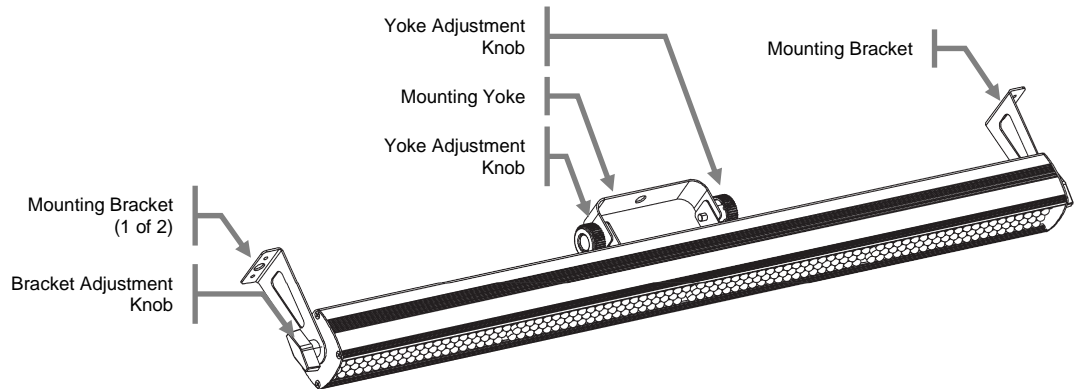

There are two (2) rigging options available for this product. If using the mounting brackets, then you must use both of them. If using the mounting yokes, then it is only necessary to use a single mounting point.

4. OPERATING INSTRUCTIONS

Menu Map

| MENU | SELECTION 1 | SELECTION 2 | DESCRIPTION |
|--|------------------------------------|--------------|--|
| DMX Address/ Personality | DMX Address | d00 1-5 12 | DMX starting address |
| | Personality | CH-2 | 2 channel, automatic program + speed DMX mode |
| | | CH-3 | 3 channel, RGB DMX mode |
| | | CH-4 | 4 channel, RGB+dimmer DMX mode |
| | | CH-7 | 7 channel, single section RGB DMX mode |
| | | CH-14 | 14 channel, 4 section RGB DMX mode |
| CH-26 | 26 channel, 8 section RGB DMX mode | | |
| Slave | SLRW | | Slave receive mode |
| Sound Mode | SU | | Sound mode |
| | | 00-31 | Microphone sensitivity (low~high) |
| Static Color | COLR | r000-255 | Red, green, blue static color mixing mode. Mix each color to create a custom mix |
| | | g000-255 | |
| | | b000-255 | |
| Program Selection (Pr 02-20) | Pr | 02-20 | Program selection |
| | SP | 0 1-99_ FL | Program speed (low~high, full) |
| | Fd | 00-99 | Fade time |
| | FS | 00-99 | Strobe speed |
| Program Selection (Pr 0 1, 2 1, 22) | Pr | 0 1_ 2 1_ 22 | Program selection |
| | SP | 0 1-99_ FL | Program speed (low~high, full) |
| | Fd | 00-99 | Fade time |
| | FS | 00-99 | Strobe speed |
| | I | | Background color |
| | | 10FF | No color |
| | | 1--r | Red |
| | | 1-r9 | Yellow |
| | | 1--9 | Green |
| | | 1-9b | Cyan |
| | | 1--b | Blue |
| | | 1-rb | Magenta |
| | | 1-9b | White |
| | | 2 | Foreground color |
| | | 10FF | No Color |
| | | 2--r | Red |
| | | 2-r9 | Yellow |
| | | 2--9 | Green |
| | | 2-9b | Cyan |
| | | 2--b | Blue |
| | 2-rb | Magenta | |
| | 2-9b | White | |
| Automatic Mode (AUTO) | n | 000- 100 | Number of times to repeat each program until continuing on to the next program |
| | SP | 0 1-99_ FL | Program speed (low~high, full) |
| | Fd | 00-99 | Fade time |
| | FS | 00-99 | Strobe speed |

Configuring the Starting Address

The COLORrail™ fixture uses up to **26** DMX channels. In this DMX configuration/personality, the highest channel that the fixture may be set to in order to function properly is **487**. Any address higher than this will prevent access to all of the channels, while in this mode; however, if you desire to use one of the other DMX channels configurations (personalities), then please consider the total DMX channels when selecting a DMX address.

The COLORrail™ fixture uses **26, 14, 7, 4, 3, or 2** DMX channels, depending on the selected DMX configuration (personality). If this is your first time using DMX, we recommend reading the “DMX Primer” section in the “Appendix”.

DMX Operation

This is the operating mode which will allow for control with an external DMX controller. You must set the starting address for this mode. If this is your first time using DMX, then it is recommended that you refer to the “DMX Primer” section in the “Appendix” of this manual.

1. Press **<MENU>** until **d00 1-5 12** appears on the LED screen.
2. Using **<UP>** and **<DOWN>**, select the starting address.
3. Press **< ENTER >** until one of the DMX personalities appears on the LED screen (**2-CH, 3-CH, 4-CH, 7-CH, 14-CH, 26-CH**).
4. Using **<UP>** and **<DOWN>**, select the desired DMX personality.
5. Press **<ENTER>**.



The text on the screen will flash when there is a no DMX signal present, or if the DMX address is higher than the maximum for the DMX personality.



Only connect 32 fixtures to a single DMX daisy chain!

Master/Slave Mode (Sound-Active, Auto Mode)

This mode allows a single unit, the master, to operate in one of the standalone modes, while one or more fixtures, slaves, synchronize their responses to the master.

Master:

The master fixture may be set in any of the following modes: Program Selection, Automatic Mode, Static Color, or Sound Mode.

Slave:

1. Press **<MENU>** until **SLAU** appears on the LED screen.
2. Press **< ENTER >**.



Only connect 31 slave fixtures when operating in this mode!

Automatic

This fixture has preprogrammed chases. In this mode, the fixture will scroll through each of the different programs. You may determine the number of times a single program will play before moving on to the next program, using **00 1- 100**.

Access this mode via the control panel on the back of the fixture. The speed and fade times may be adjusted, as well. Please see the chart below for further explanation.

1. Press **<MENU>** until **AUTO** appears on the LED screen.
2. Press **<ENTER>** to cycle through the different playback modification. See the "Menu Map" for details on the different selections that are available.
3. Using **<UP>** and **<DOWN>**, modify each setting at a time.

Program Selection

This fixture has 22 preprogrammed chases.

Access these via the control panel on the back of the fixture. The speed and fade times may be adjusted, as well. Please see the chart below for further explanation.

1. Press **<MENU>** until **Pr**** appears on the LED screen.
2. Press **<ENTER>**
3. Using **<UP>** and **<DOWN>**, select the desired program (**0 1-22**).
4. Press **<ENTER>** to cycle through the different playback modifications. See the "Menu Map" for details on the different selections that are available.
5. Using **<UP>** and **<DOWN>**, modify each setting at a time.



Programs 01, 21, and 22 have unique options available. For this reason, they have been listed in a separate section in the "Menu Map". The available options allow you to select one of 7 preset colors for both the background and the foreground.

Sound-Active

This fixture has a preprogrammed, sound triggered chase.

Access this via the control panel on the back of the fixture. Adjust the microphone sensitivity from the control panel. Please see the chart below for further explanation.

1. Press **<MENU>** until **SU**** appears on the LED screen.
2. Press **<ENTER>**.
3. Using **<UP>** and **<DOWN>**, select the microphone sensitivity (**00-3 1**).
4. Press **<ENTER>**.

Static Color

This unit has a standalone mode capable of custom color mixing without using a DMX controller. This is a static mode.

Access this mode via the control panel, which is located on the back of the fixture. Each of the 3 color may be mixed with different intensities. Please see the chart below for further explanation.

1. Press **<MENU>** until **CLR** appears on the LED screen.
2. Press **<ENTER>** to scroll through the three different colors (red, green, blue).
3. Using **<UP>** and **<DOWN>**, modify the intensity of each of the colors, until the desired color has been achieved (**000-255**).
4. Press **<ENTER>**.

DMX Channel Values

26-CH Mode

| CHANNEL | VALUE | FUNCTION | CHANNEL | VALUE | FUNCTION |
|---------|-----------|---|---------|------------------------|---|
| 1 | 000 ⇔ 255 | Master Dimmer 0%~100% | 14 | 000 ⇔ 255 | Red (section 5) Dimmer: 0%~100% |
| 2 | 000 ⇔ 255 | Red (section 1) Dimmer: 0%~100% | 15 | 000 ⇔ 255 | Green (section 5) Dimmer: 0%~100% |
| 3 | 000 ⇔ 255 | Green (section 1) Dimmer: 0%~100% | 16 | 000 ⇔ 255 | Blue (section 5) Dimmer: 0%~100% |
| 4 | 000 ⇔ 255 | Blue (section 1) Dimmer: 0%~100% | 17 | 000 ⇔ 255 | Red (section 6) Dimmer: 0%~100% |
| 5 | 000 ⇔ 255 | Red (section 2) Dimmer: 0%~100% | 18 | 000 ⇔ 255 | Green (section 6) Dimmer: 0%~100% |
| 6 | 000 ⇔ 255 | Green (section 2) Dimmer: 0%~100% | 19 | 000 ⇔ 255 | Blue (section 6) Dimmer: 0%~100% |
| 7 | 000 ⇔ 255 | Blue (section 2) Dimmer: 0%~100% | 20 | 000 ⇔ 255 | Red (section 7) Dimmer: 0%~100% |
| 8 | 000 ⇔ 255 | Red (section 3) Dimmer: 0%~100% | 21 | 000 ⇔ 255 | Green (section 7) Dimmer: 0%~100% |
| 9 | 000 ⇔ 255 | Green (section 3) Dimmer: 0%~100% | 22 | 000 ⇔ 255 | Blue (section 7) Dimmer: 0%~100% |
| 10 | 000 ⇔ 255 | Blue (section 3) Dimmer: 0%~100% | 23 | 000 ⇔ 255 | Red (section 8) Dimmer: 0%~100% |
| 11 | 000 ⇔ 255 | Red (section 4) Dimmer: 0%~100% | 24 | 000 ⇔ 255 | Green (section 8) Dimmer: 0%~100% |
| 12 | 000 ⇔ 255 | Green (section 4) Dimmer: 0%~100% | 25 | 000 ⇔ 255 | Blue (section 8) Dimmer: 0%~100% |
| 13 | 000 ⇔ 255 | Blue (section 4) Dimmer: 0%~100% | 26 | 000 ⇔ 000 001 ⇔ 255 | Strobe No Function Strobe 1~100% |

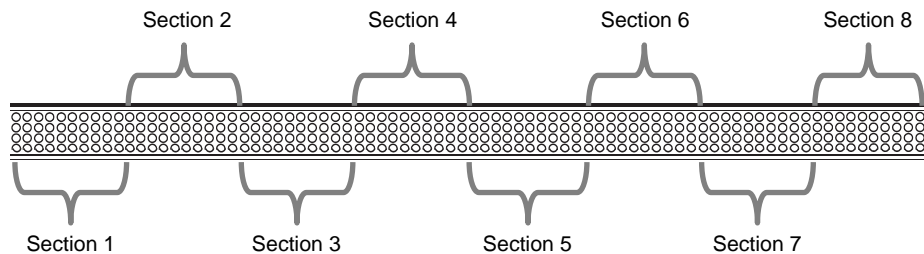

14-CH Mode

| CHANNEL | VALUE | FUNCTION | CHANNEL | VALUE | FUNCTION |
|---------|-----------|---|---------|------------------------|---|
| 1 | 000 ⇔ 255 | Master Dimmer 0%~100% | 8 | 000 ⇔ 255 | Red (section 3) Dimmer: 0%~100% |
| 2 | 000 ⇔ 255 | Red (section 1) Dimmer: 0%~100% | 9 | 000 ⇔ 255 | Green (section 3) Dimmer: 0%~100% |
| 3 | 000 ⇔ 255 | Green (section 1) Dimmer: 0%~100% | 10 | 000 ⇔ 255 | Blue (section 3) Dimmer: 0%~100% |
| 4 | 000 ⇔ 255 | Blue (section 1) Dimmer: 0%~100% | 11 | 000 ⇔ 255 | Red (section 4) Dimmer: 0%~100% |
| 5 | 000 ⇔ 255 | Red (section 2) Dimmer: 0%~100% | 12 | 000 ⇔ 255 | Green (section 4) Dimmer: 0%~100% |
| 6 | 000 ⇔ 255 | Green (section 2) Dimmer: 0%~100% | 13 | 000 ⇔ 255 | Blue (section 4) Dimmer: 0%~100% |
| 7 | 000 ⇔ 255 | Blue (section 2) Dimmer: 0%~100% | 14 | 000 ⇔ 000 001 ⇔ 255 | Strobe No Function Strobe 1~100% |

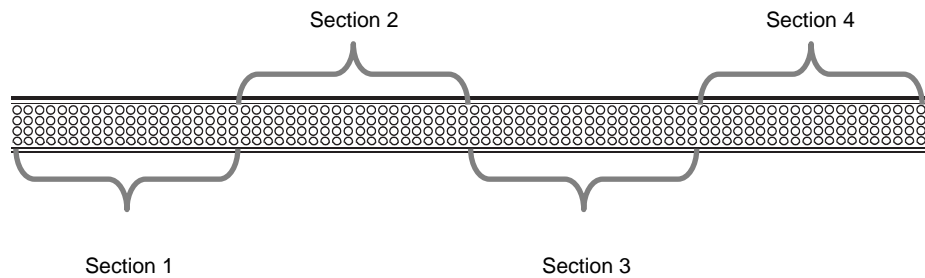

7-CH Mode

| CHANNEL | VALUE | FUNCTION |
|-----------|-----------------|--|
| 1 | 000 ⇔ 255 | Master Dimmer 0%~100% |
| 2 | 000 ⇔ 255 | Red Dimmer: 0%~100% |
| 3 | 000 ⇔ 255 | Green Dimmer: 0%~100% |
| 4 | 000 ⇔ 255 | Blue Dimmer: 0%~100% |
| 5 | 000 ⇔ 007 | Color Macro No Function |
| | 008 ⇔ 015 | Red |
| | 016 ⇔ 023 | Yellow |
| | 024 ⇔ 031 | Green |
| | 032 ⇔ 039 | Cyan |
| | 040 ⇔ 047 | Blue |
| | 048 ⇔ 055 | Purple |
| | 056 ⇔ 063 | White |
| | 064 ⇔ 071 | Auto Program 1 |
| | 072 ⇔ 079 | Auto Program 2 |
| | 080 ⇔ 087 | Auto Program 3 |
| | 088 ⇔ 095 | Auto Program 4 |
| | 096 ⇔ 103 | Auto Program 5 |
| | 104 ⇔ 111 | Auto Program 6 |
| | 112 ⇔ 119 | Auto Program 7 |
| | 120 ⇔ 127 | Auto Program 8 |
| | 128 ⇔ 135 | Auto Program 9 |
| | 136 ⇔ 143 | Auto Program 10 |
| | 144 ⇔ 151 | Auto Program 11 |
| | 152 ⇔ 159 | Auto Program 12 |
| 160 ⇔ 167 | Auto Program 13 | |
| 168 ⇔ 175 | Auto Program 14 | |
| 176 ⇔ 183 | Auto Program 15 | |
| 184 ⇔ 191 | Auto Program 16 | |
| 192 ⇔ 199 | Auto Program 17 | |
| 200 ⇔ 207 | Auto Program 18 | |
| 208 ⇔ 215 | Auto Program 19 | |
| 216 ⇔ 223 | Auto Program 20 | |
| 224 ⇔ 231 | Auto Program 21 | |
| 232 ⇔ 255 | Sound Mode | |
| 6 | 000 ⇔ 255 | Auto Program Speed (When CH.5 is between 64~231) 0%~100% |
| 7 | 000 ⇔ 000 | Strobe No Function |
| | 001 ⇔ 255 | Strobe 1~100% |

4-CH Mode

| CHANNEL | VALUE | FUNCTION |
|---------|-----------|---------------------------------|
| 1 | 000 ⇔ 255 | Master Dimmer 0%~100% |
| 2 | 000 ⇔ 255 | Red Dimmer: 0%~100% |
| 3 | 000 ⇔ 255 | Green Dimmer: 0%~100% |
| 4 | 000 ⇔ 255 | Blue Dimmer: 0%~100% |

3-CH Mode

| CHANNEL | VALUE | FUNCTION |
|---------|-----------|---------------------------------|
| 1 | 000 ⇔ 255 | Red Dimmer: 0%~100% |
| 2 | 000 ⇔ 255 | Green Dimmer: 0%~100% |
| 3 | 000 ⇔ 255 | Blue Dimmer: 0%~100% |

2-CH Mode

| CHANNEL | VALUE | FUNCTION |
|-----------|-----------------|--|
| 1 | 000 ⇔ 007 | Color Macro No Function |
| | 008 ⇔ 015 | Red |
| | 016 ⇔ 023 | Yellow |
| | 024 ⇔ 031 | Green |
| | 032 ⇔ 039 | Cyan |
| | 040 ⇔ 047 | Blue |
| | 048 ⇔ 055 | Purple |
| | 056 ⇔ 063 | White |
| | 064 ⇔ 071 | Auto Program 1 |
| | 072 ⇔ 079 | Auto Program 2 |
| | 080 ⇔ 087 | Auto Program 3 |
| | 088 ⇔ 095 | Auto Program 4 |
| | 096 ⇔ 103 | Auto Program 5 |
| | 104 ⇔ 111 | Auto Program 6 |
| | 112 ⇔ 119 | Auto Program 7 |
| | 120 ⇔ 127 | Auto Program 8 |
| | 128 ⇔ 135 | Auto Program 9 |
| | 136 ⇔ 143 | Auto Program 10 |
| | 144 ⇔ 151 | Auto Program 11 |
| | 152 ⇔ 159 | Auto Program 12 |
| | 160 ⇔ 167 | Auto Program 13 |
| | 168 ⇔ 175 | Auto Program 14 |
| | 176 ⇔ 183 | Auto Program 15 |
| 184 ⇔ 191 | Auto Program 16 | |
| 192 ⇔ 199 | Auto Program 17 | |
| 200 ⇔ 207 | Auto Program 18 | |
| 208 ⇔ 215 | Auto Program 19 | |
| 216 ⇔ 223 | Auto Program 20 | |
| 224 ⇔ 231 | Auto Program 21 | |
| 232 ⇔ 255 | Sound Mode | |
| 2 | 000 ⇔ 255 | Auto Program Speed (When CH.1 is between 64~231) 0%~100% |

5. APPENDIX

General Troubleshooting

| SYMPTOM | POSSIBLE CAUSE(S) | POSSIBLE ACTION(S) |
|----------------------------------|--|--|
| Breaker/Fuse keeps blowing | <ul style="list-style-type: none"> Excessive circuit load Short circuit along the power wires | <ul style="list-style-type: none"> Check total load placed on the electrical circuit. Check for a short in the electrical wiring (internal and/or external). |
| Device does not power up | <ul style="list-style-type: none"> No power Loose power cord | <ul style="list-style-type: none"> Check for power on Mains. Check power cord |
| Fixture is not responding to DMX | <ul style="list-style-type: none"> Wrong DMX addressing Damaged DMX cables Wrong polarity settings on the controller Loose DMX cables Faulty DMX interface Faulty Main PCB | <ul style="list-style-type: none"> Check Control Panel and unit addressing Check DMX cables Check polarity switch settings on the controller Check cable connections Replace DMX input Replace Main PCB |
| Loss of signal | <ul style="list-style-type: none"> Non DMX cables Bouncing signals Long cable / Low level signal Too many fixtures Interference from AC wires | <ul style="list-style-type: none"> Use only DMX compatible cables Install terminator as suggested. Install amplifier right after fixture with strong signal. Install an optically coupled DMX splitter after unit #32. Keep DMX cables separated from power cables or black lights. |



If you still have a problem after trying the above solutions, please contact CHAUVET® Technical Support.

DMX Primer

There are 512 channels in a DMX connection. A fixture capable of receiving DMX will require one or a number of sequential channels. The user must assign a starting address on the fixture that indicates the first channel reserved in the controller. There are many different types of DMX controllable fixtures and they all may vary in the total number of channels required. Choosing a start address should be planned in advance. Channels should never overlap. If they do, this will result in erratic operation of the fixtures whose starting address is set incorrectly. You can however, control multiple fixtures of the same type using the same starting address as long as the intended result is that of unison movement or operation. In other words, the fixtures will all respond exactly the same.

DMX fixtures are designed to receive data through a daisy chain. A daisy chain connection is where the DATA OUT of one fixture connects to the DATA IN of the next fixture. The order in which the fixtures are connected is not important and has no effect on how a controller communicates to each fixture. Use an order that provides for the easiest and most direct cabling. Connect fixtures using shielded two conductor twisted pair DMX data cable with three pin XLR male to female connectors. The shield connection is pin 1, while pin 2 is Data Negative (S-) and pin 3 is Data positive (S+).

Fixture Linking (Daisy Chain)

You will need a daisy chain to run light shows of one or more fixtures using a DMX controller or to run synchronized shows on two or more fixtures set to a master/slave operating mode. The combined number of channels required by all the fixtures on a daisy chain determines the number of fixtures the data link can support.



To comply with the EIA-485 standard, do not connect more than 32 fixtures on one daisy chain. Connecting more than 32 fixtures on one daisy chain without the use of a DMX optically-isolated splitter may result in deterioration of the digital DMX signal.

Maximum recommended cable distance: 500 m (1640 ft)

Maximum recommended number of fixtures on a daisy chain: 32

Data Cabling

To link fixtures together you must obtain data cables. You can purchase CHAUVET® certified DMX cables directly from a dealer/distributor or construct your own cable. If you choose to create your own cable please use data-grade cables that can carry a high quality signal and are less prone to electromagnetic interference.

DMX Data Cable

Use a Belden© 9841 or equivalent cable which meets the specifications for EIA RS-485 applications. Standard microphone cables cannot transmit DMX data reliably over long distances. The cable must have the following characteristics:

| | |
|---|------------------------------------|
| Type: | shielded, 2-conductor twisted pair |
| Maximum capacitance between conductors: | 30 pF/ft |
| Maximum capacitance between conductor and shield: | 55 pF/ft |
| Maximum resistance: | 20 ohms/1000 ft |
| Nominal impedance: | 100 ~ 140 ohms |

Cable Connectors

Cabling must have a male XLR connector on one end and a female XLR connector on the other end.

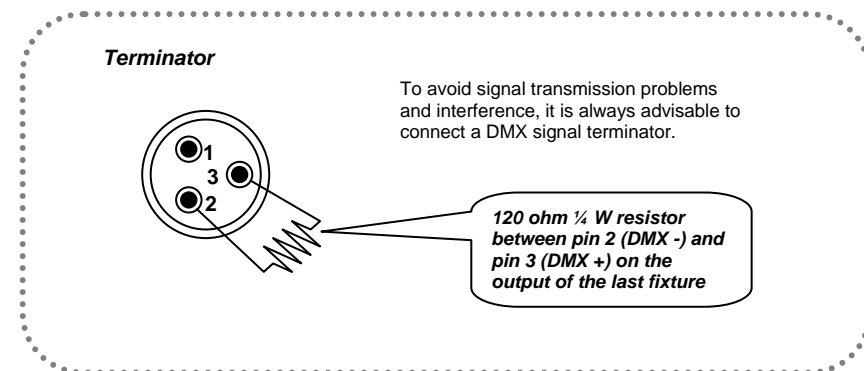
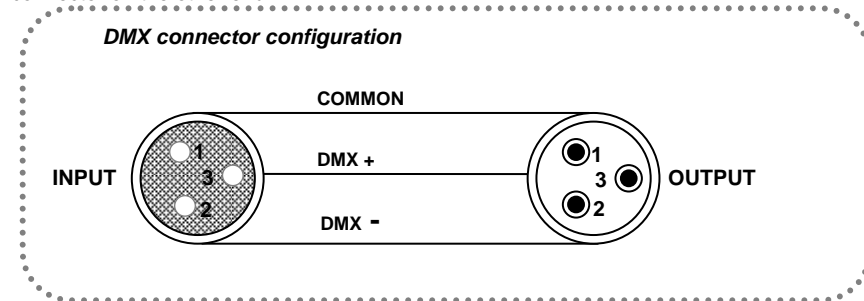

Do not allow contact between the common and the fixture's chassis ground. Grounding the common can cause a ground loop, and your fixture may perform erratically. Test cables with an ohm meter to verify correct polarity and to make sure the pins are not grounded or shorted to the shield or each other.

Setting the Starting Address

This DMX mode enables the use of a universal DMX controller device. Each fixture requires a start address from 1~512. A fixture requiring one or more channels for control begins to read the data on the channel indicated by the start address. For example, a fixture that uses six DMX channels and was addressed to start on DMX channel 100, would read data from channels: 100, 101, 102, 103, 104, and 105. Choose start addresses so that the channels used do not overlap, and note the start address selected for future reference.

If this is your first time addressing a fixture using the DMX control protocol, we suggest jumping to the "Appendix" section and reading the heading "DMX Primer". It contains very useful information that will help you understand its use.

3-Pin to 5-Pin Conversion Chart



If you use a controller with a 5-pin DMX output connector, you will need to use a 5-pin to 3-pin adapter. The chart below details a proper cable conversion:

| 3-PIN TO 5-PIN CONVERSION CHART | | |
|---------------------------------|-----------------------|--------------------|
| Conductor | 3-Pin Female (Output) | 5-Pin Male (Input) |
| Ground/Shield | Pin 1 | Pin 1 |
| Data (-) signal | Pin 2 | Pin 2 |
| Data (+) signal | Pin 3 | Pin 3 |
| Not used | | Pin 4 |
| Not used | | Pin 5 |

Setting up a DMX Daisy Chain

1. Connect the (male) 3-pin connector side of the DMX cable to the output (female) 3-pin connector of the controller.
2. Connect the end of the cable coming from the controller which will have a (female) 3-pin connector to the input connector of the next fixture consisting of a (male) 3-pin connector.
3. Then, proceed to connect from the output as stated above to the input of the following fixture and so on.

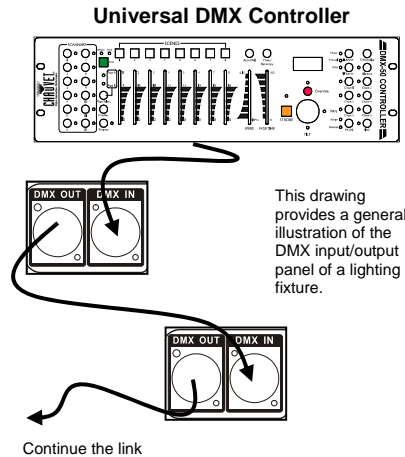

General Maintenance

To maintain optimum performance and minimize wear, fixtures should be cleaned frequently. Usage and environment are contributing factors in determining frequency. As a general rule, fixtures should be cleaned at least twice a month. Dust build up reduces light output performance and can cause overheating. This can lead to reduced lamp life and increased mechanical wear. Be sure to power off fixture before conducting maintenance.

- Unplug fixture from power.
- Use a vacuum or air compressor and a soft brush to remove dust collected on external vents.
- Clean all lenses when the fixture is cool with a mild solution of glass cleaner or Isopropyl Alcohol and a soft lint free cotton cloth or lens tissue.
- Apply solution to the cloth or tissue and drag dirt and grime to the outside of the lens.
- Gently polish optical surfaces until they are free of haze and lint.

The cleaning of external optical lenses and/or mirrors must be carried out periodically to optimize light output. Cleaning frequency depends on the environment in which the fixture operates. Damp, smoky or particularly dirty surroundings can cause greater accumulation of dirt on the unit's optics. Clean with soft cloth using normal glass cleaning fluid. Clean the external optics at least every 20 days. Clean the fixture at least every 30/60 days.



Always dry the parts carefully after cleaning them.



Never spin a fan using compressed air.

Returns Procedure

Returned merchandise must be sent prepaid and in the original packing; call tags will not be issued. Package must be clearly labeled with a Return Merchandize Authorization Number (RMA #). Products returned without the RMA # will be refused. Call CHAUVET® and request an RMA # prior to shipping the fixture. Be prepared to provide the model number, serial number and a brief description of the cause for the return. Be sure to pack fixture properly; any shipping damage resulting from inadequate packaging is the customer's responsibility. As a suggestion, proper UPS packing or double-boxing is always a safe method to use. CHAUVET® reserves the right to use its own discretion to repair or replace product(s).



If you are given an RMA #, please include the following information on a piece of paper inside the box:

- 1) ***Your name***
- 2) ***Your address***
- 3) ***Your phone number***
- 4) ***The RMA #***
- 5) ***A brief description of the symptoms***

Claims

Damage incurred in shipping is the responsibility of the shipper; therefore, the damage must be reported to the carrier upon receipt of merchandise. It is the customer's responsibility to notify and submit claims with the shipper in the event that a fixture is damaged due to shipping. Any other claim for items such as missing component/part, damage not related to shipping, and concealed damage, must be made within seven (7) days of receiving merchandise.

TECHNICAL SPECIFICATIONS

WEIGHT & DIMENSIONS

Length.....3 in (76 mm)
Width.....42.2 in (1,071 mm)
Height.....6 in (152 mm)
Weight.....4.4 lbs (2 kg)

POWER

Auto-ranging power supply 100~240 VAC, 50/60 Hz
Power consumption @ 120 V37 W (0.5 A) max, 0.2 A inrush
Power consumption @ 230 V36 W (0.3 A) max, 0.2 A inrush
Power output.....15 units max

LIGHT SOURCE

Type 10 mm
Quantity.....320 total (128 red, 96 green, 96 blue)
Rating (red, green, blue).....(¼ W) 20 mA, 100,000 hrs

PHOTO OPTIC

Lux 770 @ 1 m
Beam angle.....13°
Field angle20°

INDOOR/OUTDOOR

Rating..... For indoor use only

THERMAL

Maximum ambient temperature 104° F (40° C)

CONTROL & PROGRAMMING

Data input..... locking 3-pin XLR male socket
Data output locking 3-pin XLR female socket
Data pin configuration.....pin 1 shield, pin 2 (-), pin 3 (+)
Protocols DMX-512 USITT
DMX Channels (user-configurable) 2, 3, 4, 7, 14 or 26

ORDERING INFORMATION

COLORrail™ COLORRAIL

WARRANTY INFORMATION

Warranty2-year limited warranty

CONTACT Us

World Wide

General Information

CHAUVET®
5200 NW 108th Ave
Sunrise, FL 33351
voice: 954.929.1115
fax: 954.929.5560
toll free: 800.762.1084

Technical Support

CHAUVET®
5200 NW 108th Ave
Sunrise, FL 33351
voice: 954.929.1115 (**Press 4**)
fax: 954.929.5560 (**Attention: Service**)

World Wide Web

www.chauvetlighting.com

Free Manuals Download Website

<http://myh66.com>

<http://usermanuals.us>

<http://www.somanuals.com>

<http://www.4manuals.cc>

<http://www.manual-lib.com>

<http://www.404manual.com>

<http://www.luxmanual.com>

<http://aubethermostatmanual.com>

Golf course search by state

<http://golfingnear.com>

Email search by domain

<http://emailbydomain.com>

Auto manuals search

<http://auto.somanuals.com>

TV manuals search

<http://tv.somanuals.com>