

Chromalox[®]

Installation Instructions and RENEWAL PARTS IDENTIFICATION

SERVICE REFERENCE

DIVISION 4	SECTION LUH/KUH
SALES REFERENCE (Supersedes PF481-2)	PF481-3
161-303477-002	
DATE	NOVEMBER, 2008

Summer Fan Switch Kit With Relay

Model Number	ESFS-40 ESFS-40A ESFS-41 ESFS-41A ESFS-42 ESFS-42A ESFS-47
--------------	--

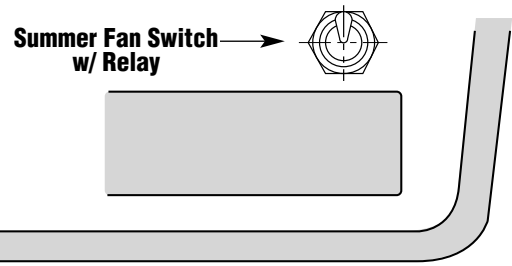

GENERAL

The fan switch and relay kit is used for all 480 Volt LUH/KUH heaters, when summer fan only operation is required. See Model Number versus Kit Model Number on page 3. This kit can also be used where low voltage control wiring is specified.

WARNING: Hazard of Electric Shock. This kit must be installed by a qualified electrician. Before performing any of the following operations, disconnect all power to the heater to prevent possible fatal injury.

INSTALLATION

The kit comes complete with all necessary wiring and mounting screws. A wall box plate is included for remote mounting of the selector switch and can be discarded if the switch is to be mounted on the heater.

To install on the heater, open the wiring access door located on the bottom of the heater by turning the captive latching screw 90 degrees in either direction (Figure 1). The selector switch is to be mounted using the knockout hole on the front of the heater, located right above the Chromalox or Heatflo label (Figure 2). The switch has all of the wiring connected to the correct terminals with the three leads to be wired to other components marked by their respective terminal number, these are wire numbers 2, 8 and 11. (Figure 3, Figure 3A) Before installing the switch, check all the wiring connections to be sure none have become loose during shipping and handling.

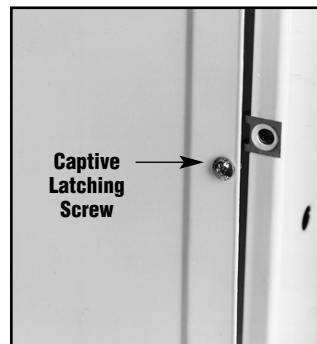

Figure 1



Figure 2

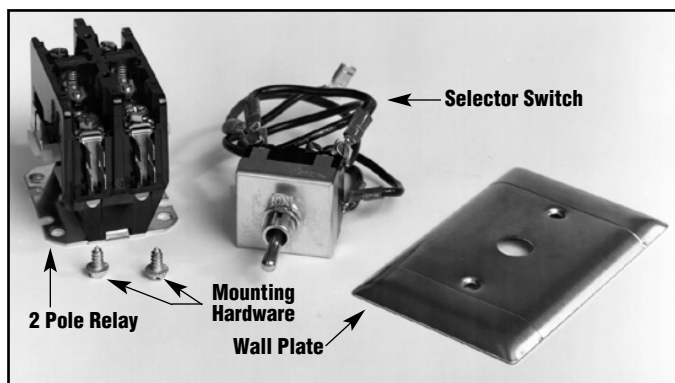

Figure 3

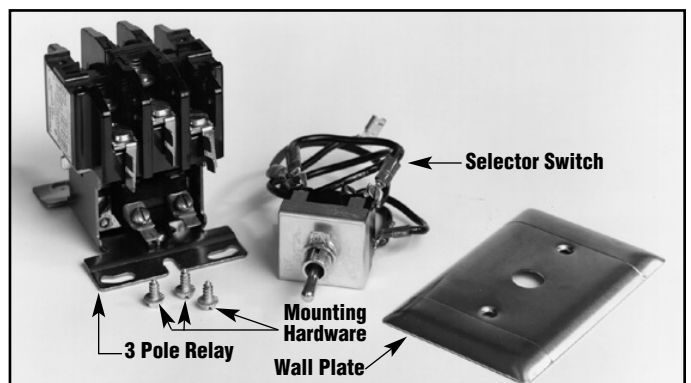

Figure 3A

INSTALLATION

Mount the switch with the toggle through the hole from inside the wiring compartment. Secure the switch using the on/off plate and hex nut (Figure 4).

For all LUH-2/KUH-2 through LUH-15/KUH-15 except 480 Volt, 3 Phase units

Install the 2 pole relay after checking the coil voltage on the nameplate to be sure the control voltage of the relay matches the control voltage of the heater. The relay should be mounted on the control mounting plate located behind the fan switch (Figure 5).

For all 480 Volt, 3 Phase and all LUH-20/KUH-20 through LUH-45/KUH-45 units.

Install the 3 pole relay after checking the coil voltage on the nameplate to be sure the control voltage of the relay matches the control voltage of the heater. The relay should be mounted on the control mounting plate located behind the fan switch (Figure 5).

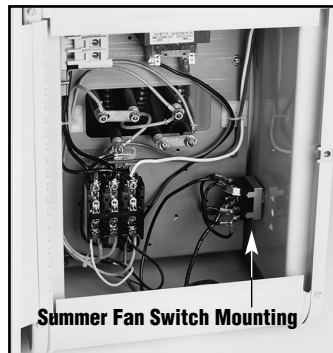

Figure 4

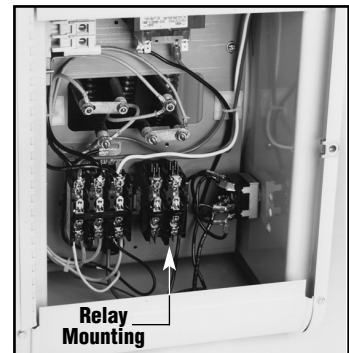

Figure 5

WIRING

The basic stock heater diagram (Figure 6) will be changed to the finished diagram (Figure 7).

1. Remove the red wire connecting the secondary of the control transformer to one side of the holding coil on the heater contactor, and discard. Wire the red wire supplied on the fan switch, (Number 11) to the open connection on the transformer.
2. Connect the black wire (Number 2) on the fan to the relay coil connection on the fan relay.
3. Connect the remaining black wire (Number 8) to the open heater contactor coil terminal.
4. Connect the open fan relay coil terminal to the other heater contactor coil terminal.

HEATERS WITH SINGLE PHASE MOTORS

5. Remove the black and white fan motor lead wires from the terminals T1 and T3 on the heater contactor and wire them to the bottom two relay contact terminals. Wire the two loose jumper wires (supplied) from the top two relay contact terminals to L1 and L3 on the top of the heater contactor.

HEATERS WITH THREE (3) PHASE MOTORS

6. Remove the #1, #2 and #3 motor wires from terminals T1, T2 and T3 on the heater contactor. Connect the #1 wire and #3 wire to the bottom two relay contact terminals. Wire the two loose jumper wires (supplied) from the top two relay contact terminals to L1 and L3 on top of the heater contactor. The #2 motor wire should then be connected to terminal T2 on the heater contactor. After completion of the heater installation, when the fan circuit is first turned on, check the rotation of the fan to be sure air is moving from the back of the heater to the front. If the air is moving in the opposite direction, interchange the motor lead connections on the bottom of the relay which should correct the air flow direction.

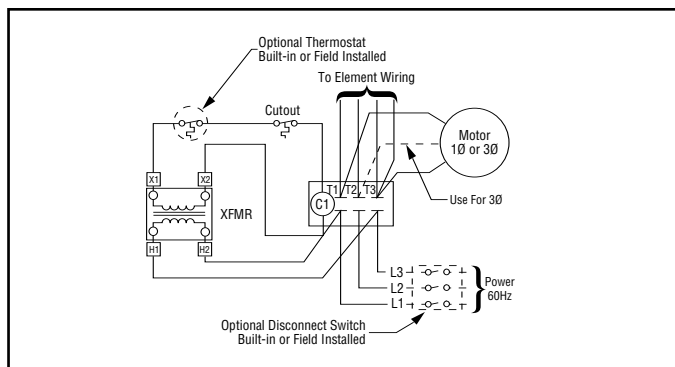

Figure 6

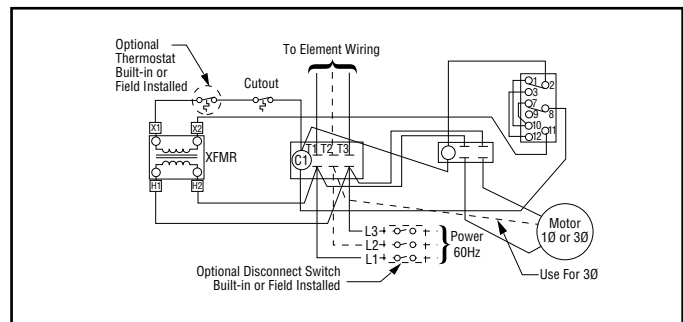

Figure 7

ESFS Kit Model Number vs. Applicable Heater Model Number

MODEL	Kit No.	MODEL	Kit No.	MODEL	Kit No.	MODEL	Kit No.
LUH-D-02-81-34-00	ESFS-42	LUH-D-10-81-34-00	ESFS-42	KUH-C-02-81-00	ESFS-42	KUH-C-10-81-34	ESFS-42
LUH-D-02-21-34-00	ESFS-42	LUH-D-10-83-34-00	ESFS-42	KUH-C-02-21-00	ESFS-42	KUH-C-10-83-34	ESFS-42
LUH-D-02-71-35-00	ESFS-47	LUH-D-10-21-34-00	ESFS-42	KUH-C-02-71-00	ESFS-47	KUH-C-10-21-34	ESFS-42
LUH-D-04-81-34-00	ESFS-42	LUH-D-10-23-34-00	ESFS-42	KUH-C-04-81-00	ESFS-42	KUH-C-10-23-34	ESFS-42
LUH-D-04-83-34-00	ESFS-42	LUH-D-10-43-32-00	ESFS-41A	KUH-C-04-83-34	ESFS-42	KUH-C-10-43-30	ESFS-40A
LUH-D-04-21-34-00	ESFS-42	LUH-D-12-83-34-00	ESFS-42	KUH-C-04-21-00	ESFS-42	KUH-C-12-83-34	ESFS-42
LUH-D-04-23-34-00	ESFS-42	LUH-D-12-23-34-00	ESFS-42	KUH-C-04-23-34	ESFS-42	KUH-C-12-23-34	ESFS-42
LUH-D-04-71-35-00	ESFS-47	LUH-D-12-43-32-00	ESFS-41A	KUH-C-04-71-00	ESFS-47	KUH-C-12-43-30	ESFS-40A
LUH-D-04-43-32-00	ESFS-41	LUH-D-15-83-34-00	ESFS-42	KUH-C-04-43-30	ESFS-40	KUH-C-15-83-34	ESFS-42
LUH-D-05-81-34-00	ESFS-42	LUH-D-15-23-34-00	ESFS-42	KUH-C-05-81-00	ESFS-42	KUH-C-15-23-34	ESFS-42
LUH-D-05-83-34-00	ESFS-42	LUH-D-15-43-32-00	ESFS-41A	KUH-C-05-83-34	ESFS-42	KUH-C-15-43-30	ESFS-40A
LUH-D-05-21-34-00	ESFS-42	LUH-D-20-23-34-00	ESFS-42A	KUH-C-05-21-00	ESFS-42	KUH-C-20-23-34	ESFS-42A
LUH-D-05-23-34-00	ESFS-42	LUH-D-20-43-32-00	ESFS-41A	KUH-C-05-23-34	ESFS-42	KUH-C-20-43-30	ESFS-40A
LUH-D-05-71-35-00	ESFS-47	LUH-D-25-43-32-00	ESFS-41A	KUH-C-05-71-00	ESFS-47	KUH-C-25-43-30	ESFS-40A
LUH-D-05-43-32-00	ESFS-41	LUH-D-30-83-34-00	ESFS-42A	KUH-C-05-43-30	ESFS-40	KUH-C-30-83-34	ESFS-42A
LUH-D-07-81-34-00	ESFS-42	LUH-D-30-23-34-00	ESFS-42A	KUH-C-07-81-34	ESFS-42	KUH-C-30-23-34	ESFS-42A
LUH-D-07-83-34-00	ESFS-42	LUH-D-30-43-32-00	ESFS-41A	KUH-C-07-83-34	ESFS-42	KUH-C-30-43-30	ESFS-40A
LUH-D-07-21-34-00	ESFS-42	LUH-D-35-23-34-00	ESFS-42A	KUH-C-07-21-34	ESFS-42	KUH-C-35-23-34	ESFS-42A
LUH-D-07-23-34-00	ESFS-42	LUH-D-35-43-32-00	ESFS-41A	KUH-C-07-23-34	ESFS-42	KUH-C-35-43-30	ESFS-40A
LUH-D-07-71-35-00	ESFS-47	LUH-D-40-23-34-00	ESFS-42A	KUH-C-07-71-30	ESFS-47	KUH-C-40-23-34	ESFS-42A
LUH-D-07-43-32-00	ESFS-41A	LUH-D-40-43-32-00	ESFS-41A	KUH-C-07-43-30	ESFS-40A	KUH-C-40-43-30	ESFS-40A
		LUH-D-45-43-32-00	ESFS-41A			KUH-C-45-43-30	ESFS-40A

REPLACEMENT PARTS

PCN	Kit Model No.	Description	Relay P/N
305015	ESFS-40	Fan switch & relay 24 Volt control 2 pole relay 2-15 kW	072-306110-003
305058	ESFS-40A	Fan switch & relay 24 Volt control 3 pole relay 20-45 kW	072-306110-001
305023	ESFS-41	Fan switch & relay 120 Volt control 2 pole relay 2-15 kW	072-306110-011
305066	ESFS-41A	Fan switch & relay 120 Volt control 3 pole relay 20-45 kW	072-306110-007
305031	ESFS-42	Fan switch & relay 240 Volt control 2 pole relay 2-15 kW	072-306110-016
305074	ESFS-42A	Fan switch & relay 240 Volt control 3 pole relay 20-45 kW	072-306110-013
305040	ESFS-47	Fan switch & relay 277 Volt control 2 pole relay 2-15 kW	072-306110-021

Fan Switch for all Kits P/N 292-057673-001

Limited Warranty:
Please refer to the Chromalox limited warranty applicable to this product at
<http://www.chromalox.com/customer-service/policies/termsofsale.aspx>.

Chromalox[®]
PRECISION HEAT AND CONTROL

2150 N. RULON WHITE BLVD., OGDEN, UT 84404
Phone: 1-800-368-2493 www.chromalox.com

Download from Www.Somanuals.com. All Manuals Search And Download.

Free Manuals Download Website

<http://myh66.com>

<http://usermanuals.us>

<http://www.somanuals.com>

<http://www.4manuals.cc>

<http://www.manual-lib.com>

<http://www.404manual.com>

<http://www.luxmanual.com>

<http://aubethermostatmanual.com>

Golf course search by state

<http://golfingnear.com>

Email search by domain

<http://emailbydomain.com>

Auto manuals search

<http://auto.somanuals.com>

TV manuals search

<http://tv.somanuals.com>