

# TABLE OF CONTENTS

SECTION		PAGE
<b>1</b>	<b>INTRODUCTION</b> .....	<b>3</b>
<b>2</b>	<b>THINGS TO KNOW BEFORE STARTING YOUR VEHICLE</b> .....	<b>9</b>
<b>3</b>	<b>UNDERSTANDING THE FEATURES OF YOUR VEHICLE</b> .....	<b>63</b>
<b>4</b>	<b>UNDERSTANDING YOUR INSTRUMENT PANEL</b> .....	<b>121</b>
<b>5</b>	<b>STARTING AND OPERATING</b> .....	<b>177</b>
<b>6</b>	<b>WHAT TO DO IN EMERGENCIES</b> .....	<b>227</b>
<b>7</b>	<b>MAINTAINING YOUR VEHICLE</b> .....	<b>243</b>
<b>8</b>	<b>MAINTENANCE SCHEDULES</b> .....	<b>293</b>
<b>9</b>	<b>IF YOU NEED CONSUMER ASSISTANCE</b> .....	<b>315</b>
<b>10</b>	<b>INDEX</b> .....	<b>325</b>



---

# INTRODUCTION

## CONTENTS

---

■ Introduction . . . . .	4	■ Vehicle Identification Number . . . . .	6
■ How To Use This Manual . . . . .	4	■ Vehicle Modifications / Alterations . . . . .	7
■ Warnings And Cautions . . . . .	6		

### INTRODUCTION

This manual has been prepared with the assistance of service and engineering specialists to acquaint you with the operation and maintenance of your new vehicle. It is supplemented by a Warranty Information Booklet and various customer oriented documents. You are urged to read these publications carefully. Following the instructions and recommendations in this manual will help assure safe and enjoyable operation of your vehicle.

**NOTE:** After you read the manual, it should be stored in the vehicle for convenient reference and remain with the vehicle when sold, so that the new owner will be aware of all safety warnings.

When it comes to service, remember that your dealer knows your vehicle best, has the factory-trained technicians and genuine Mopar® parts, and is interested in your satisfaction.

### WARNING!

**Engine exhaust, some of its constituents, and certain vehicle components contain or emit chemicals known to the State of California to cause cancer and birth defects or other reproductive harm. In addition, certain fluids contained in vehicles and certain products of component wear contain or emit chemicals known to the State of California to cause cancer and birth defects or other reproductive harm.**

### HOW TO USE THIS MANUAL

Consult the table of contents to determine which section contains the information you desire.

The detailed index, at the rear of this manual, contains a complete listing of all subjects.

Consult the following table for a description of the symbols that may be used on your vehicle or throughout this owner's manual:



812ccfd5

### WARNINGS AND CAUTIONS

This manual contains **WARNINGS** against operating procedures which could result in an accident or bodily injury. It also contains **CAUTIONS** against procedures which could result in damage to your vehicle. If you do not read this entire manual you may miss important information. Observe all Warnings and Cautions.

### VEHICLE IDENTIFICATION NUMBER

Vehicle Identification Number (VIN) is found on the driver's front corner of the instrument panel, visible through the windshield. This number also appears on the vehicle registration or title.

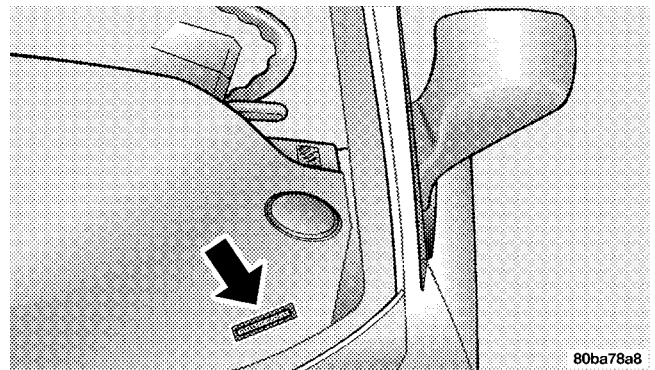

**VEHICLE MODIFICATIONS / ALTERATIONS**

1

**WARNING!**

**Any modifications or alterations to this vehicle could seriously affect its roadworthiness and safety and may lead to an accident resulting in serious injury or death.**





---

# THINGS TO KNOW BEFORE STARTING YOUR VEHICLE

## CONTENTS

---

■ A Word About Your Keys . . . . .	.12	□ If You Wish To Manually Lock The Steering Wheel . . . . .	.17
□ Ignition Key Removal . . . . .	.12	□ To Release The Steering Wheel Lock . . . . .	.17
□ Locking Doors With The Key . . . . .	.14	□ Automatic Transaxle Ignition Interlock System . . .	.18
□ Key-In-Ignition Reminder . . . . .	.14	■ Door Locks . . . . .	.18
■ Sentry Key . . . . .	.14	□ Manual Door Locks . . . . .	.18
□ Replacement Keys . . . . .	.16	□ Power Door Locks — If Equipped . . . . .	.19
□ Sentry Key Programming . . . . .	.16	□ Central Locking/Unlocking — If Equipped . . .	.20
□ General Information . . . . .	.17	□ Automatic Door Locks — If Equipped . . . . .	.20
■ Steering Wheel Lock — If Equipped . . . . .	.17		

**10 THINGS TO KNOW BEFORE STARTING YOUR VEHICLE**

□ “Child-Protection” Door Lock System (Rear Doors) . . . . .	.21	□ Security System Manual Override . . . . .	.27
■ Remote Keyless Entry — If Equipped . . . . .	.22	■ Liftgate . . . . .	.28
□ To Unlock The Doors And Liftgate . . . . .	.22	■ Emergency Seat Back Release . . . . .	.29
□ To Lock The Doors . . . . .	.23	■ Power Windows . . . . .	.30
□ Horn Chirp Feature . . . . .	.23	□ Auto Down Feature . . . . .	.31
□ Using The Panic Alarm . . . . .	.23	□ Rear Window Switches . . . . .	.31
□ To Program Transmitters . . . . .	.24	□ Wind Buffeting . . . . .	.32
□ General Information . . . . .	.24	■ Occupant Restraints . . . . .	.32
□ Transmitter Battery Service . . . . .	.25	□ Lap/Shoulder Belts . . . . .	.33
■ Security Alarm System — If Equipped . . . . .	.26	□ Adjustable Upper Shoulder Belt Anchorage . . . . .	.38
□ To Set The Alarm . . . . .	.26	□ Lap/Shoulder Belt Untwisting Procedure . . . . .	.39
□ To Disarm The System . . . . .	.27	□ Seat Belt Pretensioners . . . . .	.41
		□ Seat Belts And Pregnant Women . . . . .	.41

<hr/>		<b>THINGS TO KNOW BEFORE STARTING YOUR VEHICLE</b>	<b>11</b>
□ Driver And Front Passenger Supplemental Restraint System (SRS) - Airbag	.....	□ Exhaust Gas	.....59
□ Child Restraint	.....50	□ Safety Checks You Should Make Inside The Vehicle	.....60
■ Engine Break-In Recommendations	.....59	□ Periodic Safety Checks You Should Make Outside The Vehicle	.....61
■ Safety Tips	.....59		

### A WORD ABOUT YOUR KEYS

The dealer that sold you your new vehicle has the key code numbers for your vehicle locks. These numbers can be used to order duplicate keys from your dealer. Ask your dealer for these numbers and keep them in a safe place.

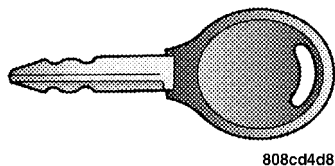

The double sided keys may be inserted into the locks with either side up.

### IGNITION KEY REMOVAL

#### Automatic Transaxle

Place the shift lever in PARK and make sure that the shift knob push button has returned to the out position. Turn the ignition switch to the OFF position, then to the LOCK position, and remove the key.

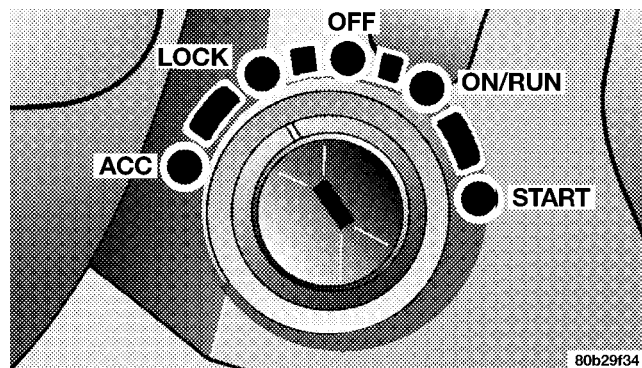

**NOTE:** If you try to remove the key before you place the lever in PARK, the key may become trapped temporarily in the ignition cylinder. If this occurs, rotate the key to the right slightly, then remove the key as described. If a malfunction occurs, the system will trap the key in the ignition cylinder to warn you that this safety feature is inoperable. The engine can be started and stopped but the key cannot be removed until you obtain service.

#### **Manual Transaxle**

Depress and hold the release button located between the ignition switch and the instrument panel. Turn the ignition switch to the LOCK position and remove the key.

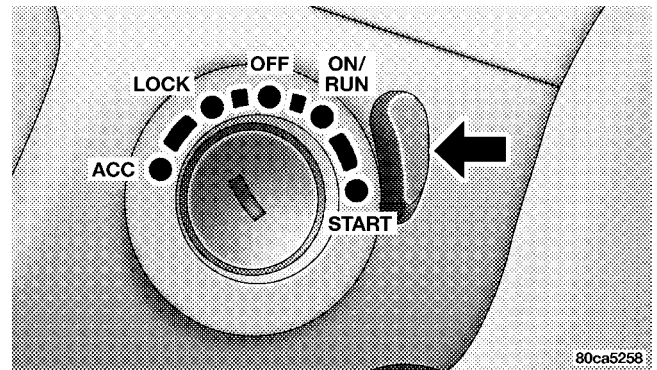

**WARNING!**

Leaving children in a vehicle unattended is dangerous for a number of reasons. A child or others could be injured. Children should be warned not to touch the parking brake, brake pedal or the gear selector lever. Don't leave the keys in the ignition. A child could operate power windows, other controls, or move the vehicle.

**CAUTION!**

An unlocked car is an invitation to thieves. Always remove key from the ignition and lock all doors when leaving the vehicle unattended.

**Locking Doors With The Key**

You can insert the key with either side up. To lock the door, turn the key rearward, to unlock the door, turn the key forward. See Section 7 of this manual for door lock lubrication.

**Key-In-Ignition Reminder**

Opening the driver's door when the key is in the ignition, sounds a signal to remind you to remove the key.

**NOTE:** With the driver's door open, and the key in the ignition, the power door locks will not function.

**SENTRY KEY**

The Sentry Key Immobilizer System prevents unauthorized operation of the vehicle by disabling the engine. The system will shut the engine off after 2 seconds of running if an invalid key is used to start the vehicle. This system utilizes ignition keys which have an electronic

chip (transponder) embedded into them. Only keys that have been programmed to the vehicle can be used to start and operate the vehicle.

The Sentry Key Immobilizer System does not need to be armed or activated. Operation of the system is automatic regardless of whether or not the vehicle is locked or unlocked. During normal operation, the Theft Alarm/Immobilizer Light will come on for three (3) seconds immediately after the ignition switch is turned on for a bulb check. Afterwards, if the bulb remains on, this indicates a problem with the electronics.

If the bulb begins to flash after the bulb check, this indicates that an invalid key has been used to start the vehicle. Both of these conditions will result in the engine being shut off after two (2) seconds of running.

Keep in mind that a key which has not been programmed is also considered an invalid key even if it is cut to fit the ignition lock cylinder for that vehicle.

If the Theft Alarm/Immobilizer Light comes on during normal vehicle operation (vehicle has been running for longer than 10 seconds), a fault has been detected in the electronics and the vehicle should be serviced as soon as possible.

**NOTE:**

- The Sentry Key Immobilizer System is not compatible with remote starting systems. Use of these systems may result in vehicle starting problems and loss of security protection.
- Exxon/Mobil Speed Pass,<sup>TM</sup> additional Sentry Keys, or any other transponder equipped components on the same keychain will **not** cause a key-related (transponder) fault unless the additional part is **physically held against the ignition key** being used when starting the vehicle. Cell phones, pagers, or other RF electronics will not cause interference with this system.

All of the keys provided with your new vehicle have been programmed to the vehicle electronics.

### Replacement Keys

**NOTE:** Only keys that have been programmed to the vehicle electronics can be used to start the vehicle. Once a Sentry Key has been programmed to a vehicle, it can not be programmed to any other vehicle.

At the time of purchase, the original owner is provided with a four digit PIN number. This number is required for dealer replacement of keys. Duplication of keys may be performed at an authorized dealer or by using the Customer Key Programming procedure. This procedure consists of programming a blank key to the vehicle electronics. A blank key is one which has never been programmed.

**NOTE:** When having the Sentry Key Immobilizer System serviced, bring all vehicle keys with you to the dealer.

### Sentry Key Programming

You can program new keys to the system if you have two valid sentry keys by performing the following procedure:

1. Cut the additional Sentry Key Transponder blank(s) to match the ignition switch lock cylinder key code.
2. Insert the first valid key into the ignition switch and turn the ignition switch ON for at least 3 seconds but no longer than 15 seconds. Turn the ignition switch OFF and remove the first key.
3. Insert the second valid key and turn the ignition switch ON within 15 seconds. After ten seconds a chime will sound and the Theft Alarm Light will begin to flash. Turn the ignition switch OFF and remove the second key.



4. Insert a blank Sentry Key into the ignition switch and turn the ignition switch ON within 60 seconds. After 10 seconds a single chime will sound. The Theft Alarm Light will stop flashing, turn on for 3 seconds; then turn off.

The new Sentry Key has been programmed.

Repeat this procedure to program up to a total of 8 keys. If you do not have a programmed sentry key, contact your dealer for details.

#### **General Information**

The Sentry Key system complies with FCC rules part 15 and with RSS-210 of Industry Canada. Operation is subject to the following conditions:

- This device may not cause harmful interference.
- This device must accept any interference that may be received, including interference that may cause undesired operation.

#### **STEERING WHEEL LOCK — IF EQUIPPED**

Your vehicle may be equipped with a passive steering wheel lock. This lock prevents steering the vehicle without the ignition key. If the steering wheel is moved no more than 1/2 turn in either direction and the key is not in the ignition switch, the steering wheel will lock.

#### **If You Wish To Manually Lock The Steering Wheel:**

With the engine running, turn the steering wheel upside down, turn off the engine and remove the key. Turn the steering wheel slightly in either direction until the lock engages.

#### **To Release The Steering Wheel Lock:**

Insert the key in the ignition switch and start the engine. If the key is difficult to turn, move the wheel slightly to the right or left to disengage the lock.

**NOTE:** If you turned the wheel to the right to engage the lock, you must turn the wheel slightly to the right to disengage it. If you turned the wheel to the left to engage the lock, turn the wheel slightly to the left to disengage it.

#### **Automatic Transaxle Ignition Interlock System**

This system prevents the key from being removed unless the shift lever is in PARK and the shift knob push-button is out. It also prevents shifting out of PARK unless the key is in the OFF, or ON positions.

#### **DOOR LOCKS**

##### **Manual Door Locks**

Use the manual door lock plunger to lock the doors from inside the vehicle. If the plunger is down when the door is closed, the door will lock. Therefore, make sure the keys are not inside the vehicle before closing the door.

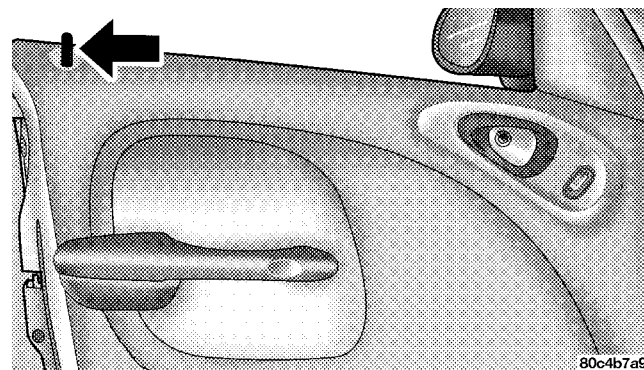

#### **WARNING!**

**For personal security, and safety in the event of an accident, lock the vehicle doors as you drive as well as when you park and leave the vehicle.**

**WARNING!**

When leaving the vehicle always remove the key from the ignition lock, and lock your vehicle. Do not leave children unattended in the vehicle, or with access to an unlocked vehicle. Unsupervised use of vehicle equipment may cause severe personal injuries and death.

**CAUTION!**

An unlocked vehicle is an invitation to thieves. Always remove the key from the ignition and lock all of the doors when leaving the vehicle unattended.

**Power Door Locks — If Equipped**

A door lock switch is on each front door panel. Press this switch to lock or unlock the doors.

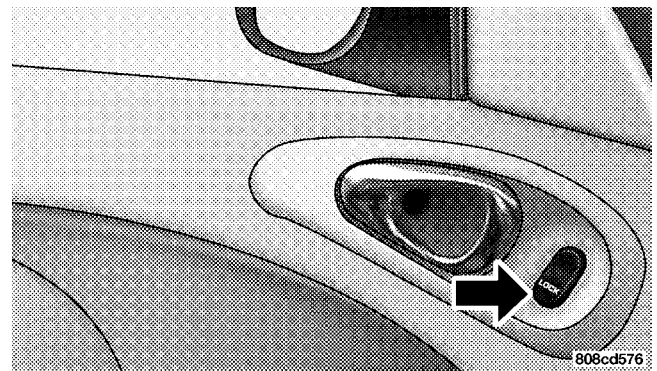

2

808cd576

### Central Locking/Unlocking — If Equipped

All vehicle doors and liftgate are locked with the first turn of the key to the LOCK position. The double unlock activation feature requires you to turn the key in the cylinder lock two times within five seconds to UNLOCK all vehicle doors and liftgate at once. You may turn this feature off and unlock all the doors and liftgate with one turn of the key by following these instructions.

**NOTE:** Steps 2 and 3 must be completed within 10 seconds.

1. Close all doors and place the key in the ignition switch.
2. Cycle the ignition switch ON/OFF four times ending in the OFF position.
3. Press the interior door lock switch to the UNLOCK position.

4. A single chime will sound to signify that you have successfully disabled the double activation feature.

You can turn the feature back on by repeating the above mentioned procedure.

### Automatic Door Locks — If Equipped

The doors will lock automatically if:

1. all doors are closed,
2. vehicle speed is above 15 mph (24 km/h),
3. the accelerator pedal is depressed.

The Automatic Door Locks can be enabled or disabled by performing the following procedure:

**NOTE:** Steps 2 and 3 must be completed within 10 seconds.

1. Close all doors and place the key in the ignition switch.

2. Cycle the ignition switch ON/OFF four times ending in the OFF position.
3. Press the interior door lock switch to the LOCK position.
4. A single chime will sound to signify that you have successfully completed the programming.

You can turn the feature back on by repeating the above mentioned procedure.

#### **“Child-Protection” Door Lock System (Rear Doors)**

To provide a safer environment for children riding in the rear seat, the rear doors have the “child-protection” door lock system.

To use the system, open each rear door and move the control UP to engage. When the system on a door is engaged, that door can only be opened by using the outside door handle even if the inside door lock is in the unlocked position.

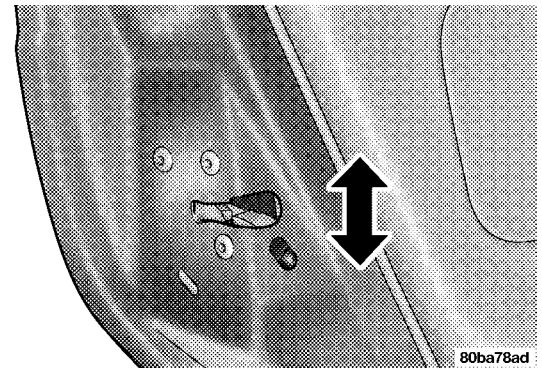

**WARNING!**

**Avoid trapping anyone in a vehicle in a collision. Remember that the rear doors can only be opened from the outside when the child protection locks are engaged.**

**NOTE:** For emergency exit with the system engaged, move the lock plunger up (unlocked position), roll down window and open the door with the outside door handle.

**REMOTE KEYLESS ENTRY — IF EQUIPPED**

This system allows you to lock or unlock the doors and activate the panic alarm from distances up to about 23 feet (7 meters) using a hand held transmitter. The transmitter need not be pointed at the vehicle to activate the system.

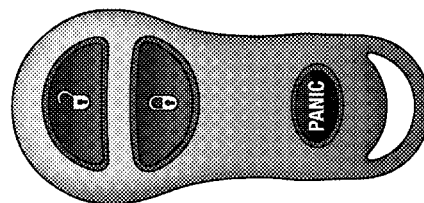

809dd723

**To Unlock The Doors and Liftgate:**

Press and release the UNLOCK button on the key fob once to unlock the driver's door, or twice within five seconds to unlock all doors and liftgate, the park lights will also flash twice. The interior lights also come on and remain on for about 30 seconds when you unlock the doors.

**NOTE:** You may turn off this feature and unlock all doors with one press of the button by following the procedure shown in the Central Locking/Unlocking paragraph.

**To Lock The Doors:**

Press and release the LOCK button to lock all doors and liftgate. The park lights will flash and the horn will chirp to acknowledge the signal.

**Horn Chirp Feature**

The horn chirp that signals that the doors have been locked can be turned on or off by using the following procedure:

1. Insert the key into the ignition switch and turn the switch to the ON position.
2. Press and hold the Unlock button on the transmitter for between four and ten seconds.

3. Continue to hold the Unlock button and press the Lock button.

4. Release both buttons.

A chime will sound to signify that the process is complete.

**Using The Panic Alarm:**

To turn on the panic alarm feature, press and release the PANIC button. When the panic alarm is on the headlights and park lights will flash, the horn will pulse on and off and the interior lights will turn on.

The panic alarm will stay on for 3 minutes unless you press the PANIC button a second time, or until vehicle speed reaches 15 mph (24 km/h).

**NOTE:** When you turn off the panic alarm by pressing the PANIC button a second time, you may have to be closer to the vehicle due to the radio frequency noises of the system.

### To Program Transmitters

Up to four transmitters can be programmed to your vehicle. Your new vehicle was shipped with two transmitters. See your dealer for additional transmitters

Additional transmitters can be programmed to the system by using the following procedure:

1. Insert the key into the ignition switch and turn the switch to the ON position.
2. Press and hold the Unlock button on the transmitter between four and ten seconds.
3. Continue to hold the Unlock button and press the Panic button. A chime will sound to indicate that the transmitter programming mode has been entered.
4. Press a button on all transmitters to be programmed to the system, including any previously programmed transmitters. A chime will sound when each transmitter has been programmed.

5. Turn the ignition switch off to exit the transmitter programming mode.

### General Information

This device complies with FCC rules part 15 and with RSS-210 of Industry Canada. Operation is subject to the following conditions:

- This device may not cause harmful interference.
- This device must accept any interference that may be received, including interference that may cause undesired operation.

If your transmitter fails to operate from a normal distance, check for these two conditions.

1. Weak batteries in transmitter. The expected life of batteries is from one to two years.
2. Closeness to a radio transmitter such as a radio station tower, airport transmitter, and some mobile or CB radios.



### Transmitter Battery Service

The recommended replacement battery is 2016 or its equivalent.

**NOTE:** Do not touch the battery terminals that are on the back housing or the printed circuit board.

1. With the transmitter buttons facing down, use a thin coin to pry the two halves of the transmitter apart. Make sure not to damage the rubber gasket during removal.

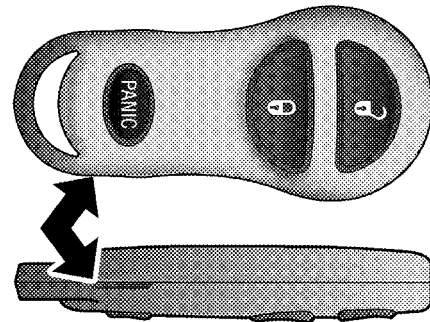

809dd6c1

2. Remove and replace the batteries. Avoid touching the new batteries with your fingers. Skin oils may cause battery deterioration. If you touch a battery, clean it with rubbing alcohol.
3. To reassemble the transmitter case snap two halves together. Make sure there is an even gap between the two halves. Test transmitter operation.

### **SECURITY ALARM SYSTEM — IF EQUIPPED**

The system monitors the doors, liftgate, and ignition switch for unauthorized operation.

If something triggers the alarm, the system will signal for about 18 minutes. For the first 3 minutes the horn will sound and the headlights, park lights, tail lights and the indicator light in the cluster will flash. Then the exterior lights will flash for another 15 minutes.

If the monitored system, which triggered the alarm is deactivated the alarm will continue to sound until 3 minutes of alarm time is reached. If the monitored system, which triggered the alarm is deactivated after the alarm has been on for 3 minutes the alarm will shut off immediately.

### **To set the alarm:**

1. Remove the keys from the ignition switch and get out of the vehicle.
2. Lock the door using either the door key, power door lock switch, or the Keyless Entry Transmitter and close all doors.
3. The indicator light in the instrument cluster will flash rapidly for 16 seconds. This shows that the system is arming. During this period, if a door is opened, the ignition switch is turned ON, or the power door locks are unlocked in any manner, the system will automatically disarm. After 16 seconds the indicator light will flash slowly. This shows that the system is fully armed.

**To disarm the system:**

Unlock a front door/liftgate using either the key or the Keyless Entry Transmitter.

Starting the vehicle with a valid Sentry key will disarm the system. A valid key is one that is programmed to that particular vehicle. A valid key will disarm the system, an invalid key will trigger the alarm.

**Tamper Alert**

If the horn sounds 3 times when you unlock a front door using either a key or the Keyless Entry Transmitter, the alarm has been activated. Check the vehicle for tampering.

**Security System Manual Override**

The system will not arm if you lock the doors using the manual door lock plunger.

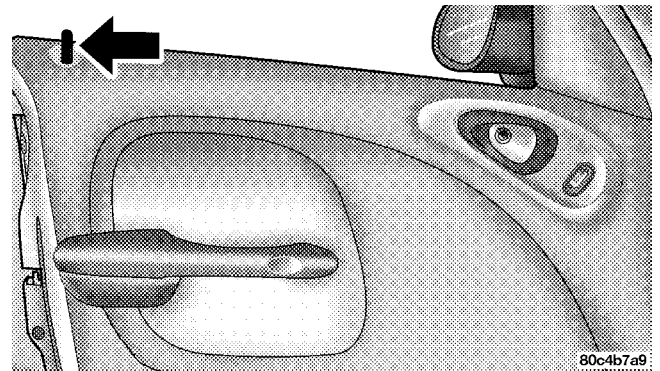

80c4b7a9

## LIFTGATE

**NOTE:** The key that is used to start the vehicle is also used to lock or unlock the doors and open the liftgate.

To open the liftgate, insert the key into the lock and turn to the left. The liftgate can also be unlocked using the remote keyless entry or by activating the power door lock switches located on the front doors. The central locking/unlocking feature (if equipped) can also be activated from the liftgate key cylinder.

Once unlocked, the liftgate can be opened or closed without using the key. To open the liftgate, pull out on the outside handle and lift up with one fluid motion.

### WARNING!

- **Driving with the liftgate open can allow poisonous exhaust gases into your vehicle. You and your passengers could be injured by these fumes. Keep the liftgate closed when you are operating the vehicle.**
- **If you are required to drive with the liftgate open, make sure that all windows are closed, and the climate control blower switch is set at high speed. DO NOT use the recirculation mode.**

Gas props support the liftgate in the open position. However, because the gas pressure drops with temperature, it may be necessary to assist the props when opening the liftgate in cold weather.

**EMERGENCY SEAT BACK RELEASE****WARNING!**

Do not allow children to have access to the liftgate area with the rear shelf panel in position 1 (Top) or position 2 (Middle), either by climbing into the liftgate from outside, or through the inside of the vehicle. Always close the liftgate when your vehicle is unattended. Once in the liftgate area, young children may not be able to escape, even if they entered through the rear seat. If trapped in the liftgate, children can die from suffocation or heat stroke.

As a security measure, a Seat Back Emergency Release lever is built into the left side rear seat back latching mechanism. In the event of an individual being locked inside the liftgate area with the rear shelf panel in

position 1 (Top) or position 2 (Middle), the left side rear seat back can be unlatched by pulling down on the glow-in-the-dark lever attached to the left rear seat back latching mechanism.

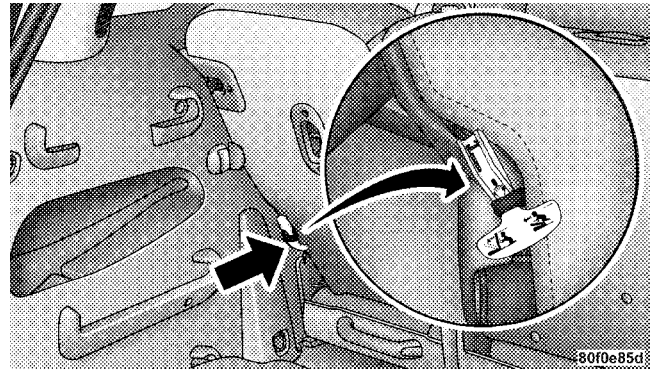

Once unlatched the seat back can be pushed forward to gain access into the interior of the vehicle.

**NOTE:** Make sure that the elastic loop is around the emergency release handle at all times. If the handle is pulled downward, entirely through the elastic loop, the handle will not return to its original position and the seat back may not operate properly.

#### POWER WINDOWS

The power window switches are located on the instrument panel above the A/C controls. The top left switch controls the left front window and the top right switch controls the right front window.

The lower left switch controls the left rear passenger's window and the lower right switch controls the right rear passenger's window.

The window lock switch located between the window switches allows you to disable the rear window switches that are located at the back of the center floor console.

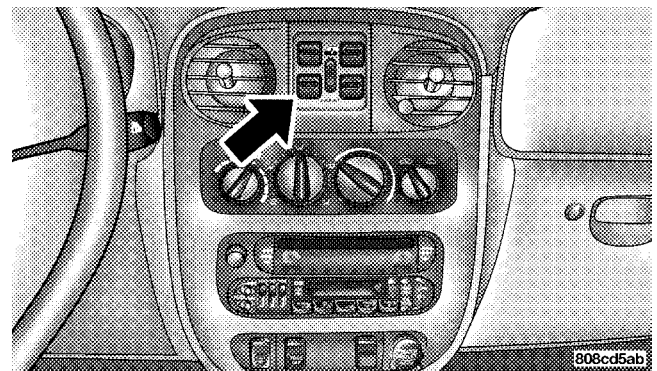

**WARNING!**

Never leave children in a vehicle, with the keys in the ignition switch. Occupants, particularly unattended children, can become entrapped by the windows while operating the power window switches. Such entrapment may result in serious injury or death.

**Auto Down Feature**

The driver's and passenger's front window switches have an auto down feature. Press the window switch past the detent, release, and the window will go down automatically. Press the switch a second time in either direction to stop the window.

To open the window part way, press the window switch part way and release it when you want the window to stop.

**Rear Window Switches**

There are also rear passenger window switches located at the rear of the center console near the floor.

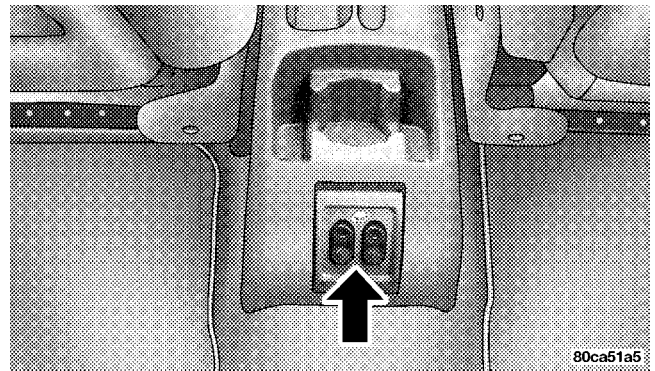

2

**Wind Buffeting**

Wind buffeting can be described as the perception of pressure on the ears or a helicopter type sound in the ears. Your vehicle may exhibit wind buffeting with the windows down, or the sunroof (if equipped) in certain open or partially open positions. This is a normal occurrence and can be minimized. If the buffeting occurs with the rear windows open, open the front and rear windows together to minimize the buffeting. If the buffeting occurs with the sunroof open, adjust the sunroof opening to minimize the buffeting.

**OCCUPANT RESTRAINTS**

Some of the most important safety features in your vehicle are the restraint systems. These include the front and rear seat belts for the driver and all passengers, front airbags for both the driver and front passenger and if equipped, side airbags for both the driver and front passenger. If you will be carrying children too small for

adult-size seat belts, your seat belts or the LATCH feature also, can be used to hold infant and child restraint systems.

Please pay close attention to the information in this section. It tells you how to use your restraint system properly to keep you and your passengers as safe as possible.

**WARNING!**

**In a collision, you and your passengers can suffer much greater injuries if you are not properly buckled up. You can strike the interior of your vehicle or other passengers, or you can be thrown out of the vehicle. Always be sure you and others in your vehicle are buckled up properly.**



Buckle up even though you are an excellent driver, even on short trips. Someone on the road may be a poor driver and cause a collision that includes you. This can happen far away from home or on your own street.

Research has shown that seat belts save lives, and they can reduce the seriousness of injuries in a collision. Some of the worst injuries happen when people are thrown from the vehicle. Seat belts reduce the possibility of ejection and the risk of injury caused by striking the inside of the vehicle. **Everyone** in a motor vehicle should be belted at all times.

#### **Lap/Shoulder Belts**

All the seats in your vehicle are equipped with Lap/Shoulder Belts.

The belt webbing retractor is designed to lock during very sudden stops or collisions. This feature allows the shoulder part of the belt to move freely with you under normal conditions. But in a collision, the belt will lock and reduce the risk of your striking the inside of the vehicle or being thrown out.

#### **WARNING!**

- **It is extremely dangerous to ride in a cargo area, inside or outside of a vehicle. In a collision, people riding in these areas are more likely to be seriously injured or killed.**
- **Do not allow people to ride in any area of your vehicle that is not equipped with seats and seat belts.**
- **Be sure everyone in your vehicle is in a seat and using a seat belt properly.**

**WARNING!**

- **Wearing a seat belt incorrectly is dangerous. Seat belts are designed to go around the large bones of your body. These are the strongest parts of your body and can take the forces of a collision the best.**
- **Wearing your belt in the wrong place could make your injuries in a collision much worse. You might suffer internal injuries, or you could even slide out of part of the belt. Follow these instructions to wear your seat belt safely and to keep your passengers safe, too.**
- **Two people should never be belted into a single seat belt. People belted together can crash into one another in an accident, hurting one another badly. Never use a lap/shoulder belt or lap belt for more than one person, no matter what their size.**

**Lap/Shoulder Belt Operating Instructions**

1. Enter the vehicle and close the door. Sit back and adjust the seat.
2. The seat belt latch plate is above the back of the front seat, next to your arm. Grasp the latch plate and pull out the belt. Slide the latch plate up the webbing as far as necessary to allow the belt to go around your lap.

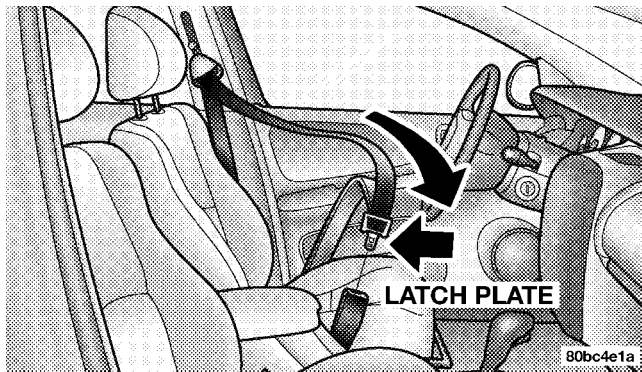

3. When the belt is long enough to fit, insert the latch plate into the buckle until you hear a “click.”

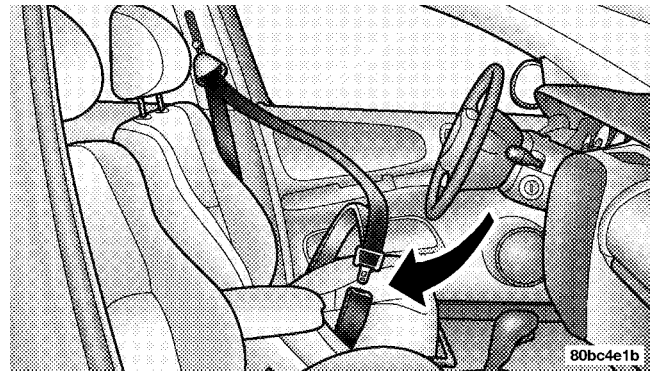

**WARNING!**

- A belt that is buckled into the wrong buckle will not protect you properly. The lap portion could ride too high on your body, possibly causing internal injuries. Always buckle your belt into the buckle nearest you.
- A belt that is too loose will not protect you as well. In a sudden stop you could move too far forward, increasing the possibility of injury. Wear your seat belt snugly.
- A belt that is worn under your arm is very dangerous. Your body could strike the inside surfaces of the vehicle in a collision, increasing head and neck injury. A belt worn under the arm can cause internal injuries. Ribs aren't as strong as shoulder bones. Wear the belt over your shoulder so that your strongest bones will take the force in a collision.
- A shoulder belt placed behind you will not protect you from injury during a collision. You are more likely to hit your head in a collision if you do not wear your shoulder belt. The lap and shoulder belt are meant to be used together.

4. Position the lap belt across your thighs, below your abdomen. To remove slack in the lap belt portion, pull up on the shoulder belt. To loosen the lap belt if it is too tight, tilt the latch plate and pull on the lap belt. A snug belt reduces the risk of sliding under the belt in a collision.

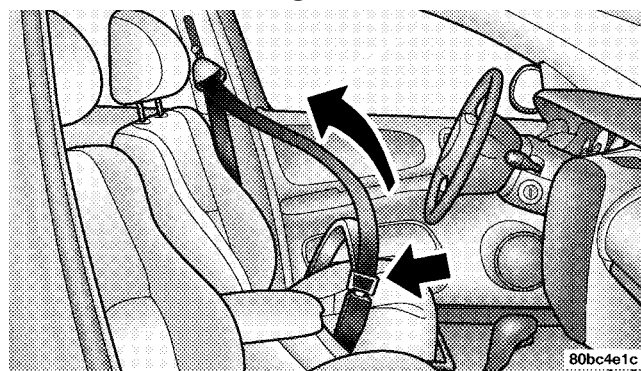

**WARNING!**

- **A lap belt worn too high can increase the risk of internal injury in a collision. The belt forces won't be at the strong hip and pelvic bones, but across your abdomen. Always wear the lap belt as low as possible and keep it snug.**
- **A twisted belt can't do its job as well. In a collision it could even cut into you. Be sure the belt is straight. If you can't straighten a belt in your vehicle, take it to your dealer and have it fixed.**

5. Position the shoulder belt on your chest so that it is comfortable and not resting on your neck. The retractor will withdraw any slack in the belt.

6. To release the belt, push the red button on the buckle. The belt will automatically retract to its stowed position. If necessary, slide the latch plate down the webbing to allow the belt to retract fully.

**WARNING!**

**A frayed or torn belt could rip apart in a collision and leave you with no protection. Inspect the belt system periodically, checking for cuts, frays, or loose parts. Damaged parts must be replaced immediately. Do not disassemble or modify the system. Seat belt assemblies must be replaced after a collision if they have been damaged (bent retractor, torn webbing, etc.).**

**Rear Center Lap/Shoulder Belt Retractor Lock-Out**

This feature is designed to lock the retractor whenever the rear seat back is not fully latched. This prevents someone from wearing the rear center lap/shoulder belt when the rear seat back is not fully latched.

**NOTE:**

- If the rear center lap/shoulder belt can not be pulled out, check that the rear seat back is fully latched.
- If the rear seat back is properly latched and the rear center lap/shoulder belt still can not be pulled out, the Automatic-Locking Retractor (ALR) system may be activated. To reset this feature you must let all of the belt webbing return into the retractor. You will not be able to pull out more webbing until all of the webbing has been returned back into the retractor.

**WARNING!**

**The rear center lap/shoulder belt is equipped with a lock-out feature to ensure that the rear seat back is in the fully upright and locked position when occupied. If the rear seat back is not fully upright and locked and the rear center lap/shoulder belt can be pulled out of the retractor, the vehicle should immediately be taken to your dealer for service. Failure to follow this warning could result in serious or fatal injury.**

**Adjustable Upper Shoulder Belt Anchorage**

In the front seat, the shoulder belt can be adjusted upward or downward to position the belt away from your neck. Push up or down on the anchorage button to release the anchorage, and move it up or down to the position that serves you best.

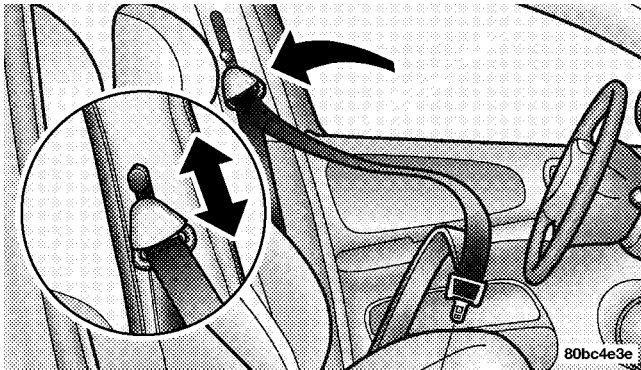

As a guide, if you are shorter than average, you will prefer a lower position, and if you are taller than average, you'll prefer a higher position. When you release the anchorage, try to move it up or down to make sure that it is locked in position.

### Lap/Shoulder Belt Untwisting Procedure

Use the following procedure to untwist a twisted lap/shoulder belt.

1. Position the latch plate as close as possible to the anchor point.

2

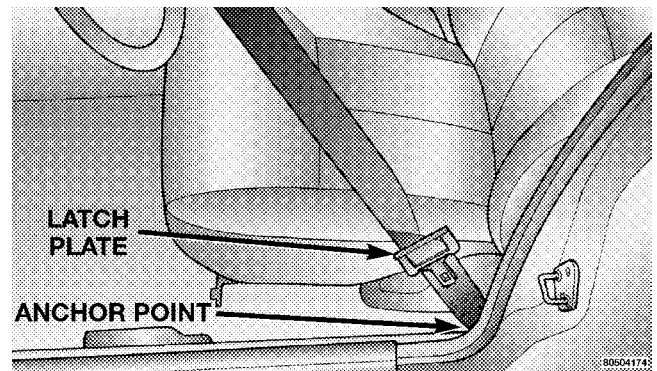

2. At about 6 to 12 inches (15 to 30 cm) above the latch plate, grasp and twist the belt webbing 180° to create a fold that begins immediately above the latch plate.

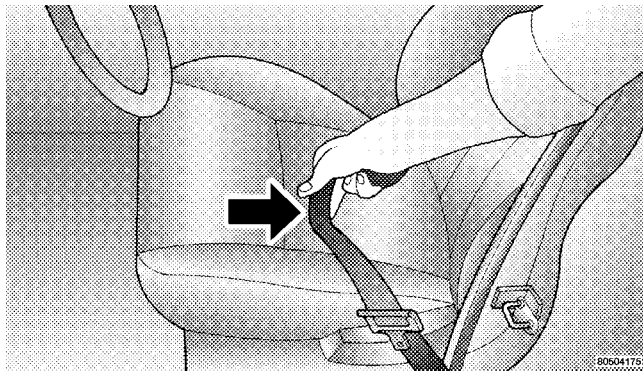

3. Slide the latch plate upward over the folded webbing. The folded webbing must enter the slot at the top of the latch plate.

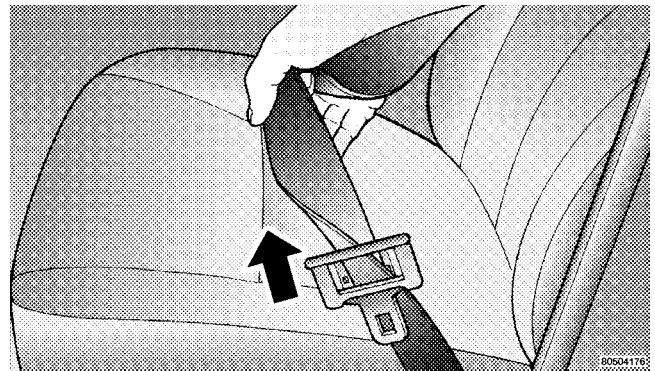

4. Continue to slide the latch plate up until it clears the folded webbing.



**Seat Belt Pretensioners**

The seat belts for both front seating positions are equipped with pretensioning devices that are designed to remove slack from the seat belt in the event of a collision. These devices improve the performance of the seat belt by assuring that the belt is tight about the occupant early in a collision. Pretensioners work for all size occupants, including those in child restraints.

**NOTE:** These devices are not a substitute for proper seat belt placement by the occupant. The seat belt still must be worn snugly and positioned properly.

The pretensioners are triggered by the front airbag control module (see Airbag Section). Like the front airbags, the pretensioners are single use items. After a collision that is severe enough to deploy the airbags and pretensioners, both must be replaced.

**Seat Belts And Pregnant Women**

We recommend that pregnant women use the seat belts throughout their pregnancy. Keeping the mother safe is the best way to keep the baby safe.

Pregnant women should wear the lap part of the belt across the thighs and as snug across the hips as possible. Keep the belt low so that it does not come across the abdomen. That way the strong bones of the hips will take the force if there is a collision.

**Driver and Front Passenger Supplemental Restraint System (SRS) - Airbag**

This vehicle has airbags for both the driver and front passenger as a supplement to the seat belt restraint systems. The driver's front airbag is mounted in the center of the steering wheel. The passenger's front airbag is mounted in the instrument panel, above the glove compartment. The words SRS AIRBAG are embossed on the airbag covers.

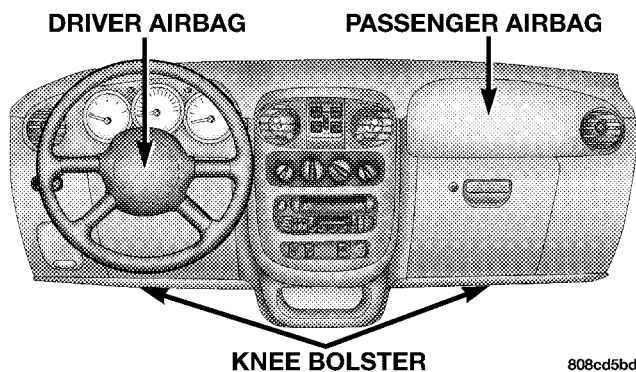

808cd5bd

**NOTE:** The front airbags are certified to the Federal regulations that allow less forceful deployment.

If the vehicle is equipped with side airbags, they are located inside the driver and front passenger seats, and their covers are also labeled SRS AIRBAG.

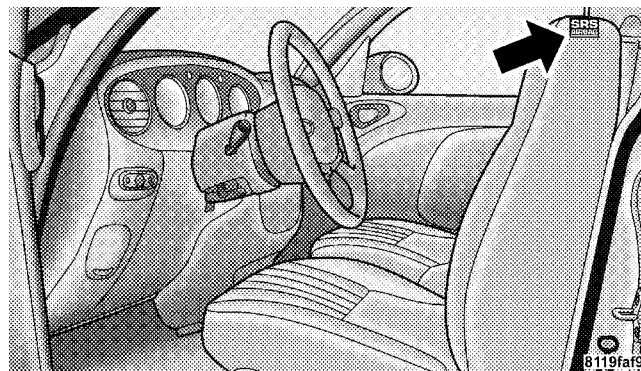

8119fa19

**WARNING!**

- **Do not put anything on or around the airbag covers or attempt to manually open them. You may damage the airbags and you could be injured because the airbags are not there to protect you. These protective covers for the airbag cushions are designed to open only when the airbags are inflating.**
- **If your vehicle is equipped with side airbags, do not use accessory seat covers or place objects between you and the side airbags; the performance could be adversely affected and/or objects could be pushed into you, causing serious injury.**
- **If your vehicle is equipped with side airbags, do not attach cup holders or any other objects on or around the door. The inflating side airbag could drive the object into occupants, causing serious injury.**

Airbags inflate in moderate to high speed impacts. Along with seat belts and pretensioners, front airbags work with the instrument panel knee bolsters to provide improved protection for the driver and front passenger. Side airbags also work with seat belts to improve occupant protection.

The seat belts are designed to protect you in many types of collisions. The front airbags deploy in moderate to severe frontal collisions. If your vehicle is equipped, the side airbag on the crash side of the vehicle is triggered in moderate to severe side collisions. In certain types of collisions, both the front and side airbags may be triggered. But even in collisions where the airbags work, you need the seat belts to keep you in the right position for the airbags to protect you properly.

Here are some simple steps you can take to minimize the risk of harm from a deploying airbag.

1. **Children 12 years old and under should always ride buckled up in a rear seat.**

#### 44 THINGS TO KNOW BEFORE STARTING YOUR VEHICLE

Infants in rear facing child restraints should **NEVER** ride in the front seat of a vehicle with a passenger front airbag. An airbag deployment can cause severe injury or death to infants in that position.

Children that are not big enough to properly wear the vehicle seat belt (see Section on Child Restraints) should be secured in the rear seat in child restraints or belt-positioning booster seats. Older children who do not use child restraints or belt-positioning booster seats should ride properly buckled up in the rear seat. Never allow children to slide the shoulder belt behind them or under their arm.

If a child from 1 to 12 years old must ride in the front passenger seat because the vehicle is crowded, move the seat as far back as possible, and use the proper child restraint. Refer to the section on Child Restraint.

You should read the instructions provided with your child restraint to make sure that you are using it properly.

2. **All occupants should wear their lap and shoulder belts properly.**
3. **The driver and front passenger seats should be moved back as far as practical to allow the front airbags room to inflate.**
4. **If your vehicle has side airbags, do not lean against the door, airbags will inflate forcefully into the space between you and the door.**

**WARNING!**

- Relying on the airbags alone could lead to more severe injuries in a collision. The airbags work with your seat belt to restrain you properly. In some collisions the airbags won't deploy at all. Always wear your seat belts even though you have airbags.
- Being too close to the steering wheel or instrument panel during front airbag deployment could cause serious injury. Airbags need room to inflate. Sit back, comfortably extending your arms to reach the steering wheel or instrument panel.
- If the vehicle has side airbags, they also need room to inflate. Do not lean against the door. Sit upright in the center of the seat.

**The front airbag system consists of the following:**

- Front Airbag Control Module (ACM)
- AIRBAG Readiness Light
- Driver and Passenger Front Airbag/Inflator Units
- Unique Steering Wheel and Column
- Unique Instrument Panel
- Interconnecting Wiring
- Seat Belt Pretensioners
- Knee Impact Bolster

**The Side Airbag System, on vehicles equipped, consists of the following:**

- AIRBAG Readiness Light (shared with the front airbag system)
- Side Airbag in the driver's seat

- Side Airbag in the passenger's seat
- Airbag Control Module (shared with the front airbag system)
- Side impact sensors
- Interconnecting Wiring

#### How The Airbag System Works

- The **front** airbag control module determines if a frontal impact is severe enough to require the airbags to inflate. The front control module will not detect side, roll over, or rear collisions.

The front airbag control module also monitors the readiness of the electronic parts of the system whenever the ignition switch is in the START or ON positions. These include all of the items listed above except the knee bolster, instrument panel and the steering wheel and column. If the key is in the OFF

position, in the ACC position, or not in the ignition switch, the airbags are not on and will not inflate.

#### **AIR BAG**

The front airbag control module also turns on the AIRBAG light in the instrument panel for 6 to 8 seconds when the ignition switch is first turned ON, then turns the light off. If the front or side airbag control modules detect a malfunction in any part of the system, the airbag light will turn on either momentarily or continuously.

#### **WARNING!**

**Ignoring the AIRBAG light in your instrument panel could mean you won't have the airbags to protect you in a collision. If the light does not come on, stays on after you start the vehicle, or if it comes on as you drive, have the airbag system checked right away.**

- When the front airbag control module detects a collision requiring the front airbags, it signals the inflator units. A large quantity of nontoxic gas is generated to inflate the front airbags. The front airbag covers separate and fold out of the way as the front airbags inflate to their full size. The front airbags fully inflate in about 50 milliseconds. This is only about half of the time it takes you to blink your eyes. The front airbags then quickly deflate while helping to restrain the driver and front passenger. The driver's front airbag gas is vented through the airbag material towards the instrument panel. The passenger's front airbag gas is vented through vent holes in the sides of the airbag. In this way the front airbags do not interfere with your control of the vehicle.
- The **Knee Impact Bolsters** help protect the knees and position you for the best interaction with the front airbags.

### Side Airbags Supplemental Restraint System (SRS)—If Equipped

The side airbag control module determines if a side collision is severe enough to require the side airbags to inflate. The side airbag control module will not detect roll over, front or rear collisions.

The Side Airbag Control Module monitors the readiness of the electronic parts of the system whenever the ignition switch is in the START or ON positions. These include all of the items listed under "The Side Airbag System", on vehicles equipped, consists of the following".

In moderate to severe side collisions, the side airbag inflator on the crash side of the vehicle is triggered, releasing a quantity of nontoxic gas. The inflating side airbag exits through the seat seam into the space between the occupant and the door. The side airbag moves at a very high speed and with such a high force, that it could

injure you if you are not seated properly, or if items are positioned in the area where the side airbag inflates. This especially applies to children.

**If A Deployment Occurs**

The airbag systems are designed to deploy when the airbag control modules detect a moderate-to-severe collision, to help restrain the driver and front passenger, and then immediately deflate.

**NOTE:** A collision that is not severe enough to need airbag protection will not activate the system. This does not mean something is wrong with the airbag system.

If you do have a collision which deploys the airbags, any or all of the following may occur:

- The nylon airbag material may sometimes cause abrasions and/or skin reddening to the driver and front passenger as the airbags deploy and unfold. The abrasions are similar to friction rope burns or those

you might get sliding along a carpet or gymnasium floor. They are not caused by contact with chemicals. They are not permanent and normally heal quickly. However, if you haven't healed significantly within a few days, or if you have any blistering, see your doctor immediately.

- As the airbags deflate you may see some smoke-like particles. The particles are a normal by-product of the process that generates the nontoxic gas used for airbag inflation. These airborne particles may irritate the skin, eyes, nose, or throat. If you have skin or eye irritation, rinse the area with cool water. For nose or throat irritation, move to fresh air. If the irritation continues, see your doctor. If these particles settle on your clothing, follow the garment manufacturer's instructions for cleaning.



- It is not advisable to drive your vehicle after the airbags have deployed. If you are involved in another collision, the airbags and seat belt pretensioners will not be in place to protect you.

**WARNING!**

Deployed airbags and seat belt pretensioners cannot protect you in another collision. Have the airbags and seat belt pretensioners replaced by an authorized dealer as soon as possible.

**Maintaining Your Airbag System**

**WARNING!**

- Modifications to any part of the airbag system could cause it to fail when you need it. You could be injured because the airbags are not there to protect you. Do not modify the components or wiring, including adding any kind of badges or stickers to the steering wheel hub trim cover or the upper right side of the instrument panel. Do not modify the front bumper, vehicle body structure, or frame.
- You need proper knee impact protection in a collision. Do not mount or locate any aftermarket equipment on or behind the knee bolsters.
- It is dangerous to try to repair any part of the airbag system yourself. Be sure to tell anyone who works on your vehicle that it has airbags.

### **Airbag Light**

You will want to have the airbags ready to inflate for your protection in a collision. While the airbag system is designed to be maintenance free, if any of the following occurs, have an authorized dealer service the system immediately.

- The AIRBAG light does not come on or flickers during the 6 to 8 seconds when the ignition switch is first turned on.
- The light remains on or flickers after the 6 to 8 second interval.
- The light flickers or comes on and remains on while driving.

### **Child Restraint**

Everyone in your vehicle needs to be buckled up at all times — babies and children, too. Every state in the United States and all Canadian provinces require that small children ride in proper restraint systems. This is the law, and you can be prosecuted for ignoring it.

Children 12 years and under should ride properly buckled up in a rear seat, if available. According to crash statistics, children are safer when properly restrained in the rear seats, rather than in the front.

**WARNING!**

**In a collision, an unrestrained child, even a tiny baby, can become a missile inside the vehicle. The force required to hold even an infant on your lap could become so great that you could not hold the child, no matter how strong you are. The child and others could be badly injured. Any child riding in your vehicle should be in a proper restraint for the child's size.**

**Infants And Small Children**

There are different sizes and types of restraints for children from newborn size to the child almost large enough for an adult safety belt. Always check the child seat owner's manual to ensure you have the correct seat for your child. Use the restraint that is correct for your child:

- Safety experts recommend that children ride rearward-facing in the vehicle until they are at least one year old and weigh at least 20 lbs (9 kg). Two types of child restraints can be used rearward-facing: infant carriers and "convertible" child seats. Both types of child restraints are held in the vehicle by the lap/shoulder belt or the LATCH child restraint anchorage system.
- The infant carrier is only used rearward-facing in the vehicle. It is recommended for children who weigh up to about 20 lbs (9 kg). "Convertible" child seats can be used either rearward-facing or forward-facing in the vehicle. Convertible child seats often have a higher weight limit in the rearward-facing direction than infant carriers do, so they can be used rearward-facing by children who weigh more than 9 kg (20 lbs) but are less than one year old.

## 52 THINGS TO KNOW BEFORE STARTING YOUR VEHICLE

- Rearward-facing child seats must **NEVER** be used in the front seat of a vehicle with a front passenger airbag. An airbag deployment could cause severe injury or death to infants in this position.
- Children who weigh more than 20 lbs (9 kg) and who are older than one year can ride forward-facing in the vehicle. Forward-facing child seats and convertible child seats used in the forward-facing direction are for children who weigh 20 to 40 lbs (9 to 18 kg) and who are older than one year. These child seats are also held in the vehicle by the lap/shoulder belt or the LATCH child restraint anchorage system.
- The belt-positioning booster seat is for children weighing more than 40 lbs (18 kg), but who are still too small to fit the vehicle's seat belts properly. If the child cannot sit with knees bent over the vehicle's cushion while the child's back is against the seat back; they should use a Belt Positioning Booster Seat. The child and booster seat are held in the vehicle by the lap/shoulder belt. (Some booster seats are equipped with a front shield and are held in the vehicle by the lap portion.)

**NOTE:** For additional information refer to [www.nhtsa.dot.gov](http://www.nhtsa.dot.gov) or [www.seatcheck.org](http://www.seatcheck.org).

**WARNING!**

- **Improper installation can lead to failure of an infant or child restraint. It could come loose in a collision. The child could be badly injured or killed. Follow the manufacturer's directions exactly when installing an infant or child restraint.**
- **A rearward facing child restraint should only be used in a rear seat. A rearward facing child restraint in the front seat may be struck by a deploying passenger airbag which may cause severe or fatal injury to the infant.**

**Here are some tips on getting the most out of your child restraint:**

- Before buying any restraint system, make sure that it has a label certifying that it meets all applicable Safety Standards. We also recommend that you make sure

that you can install the child restraint in the vehicle where you will use it, before you buy it.

- The restraint must be appropriate for your child's weight and height. Check the label on the restraint for weight and height limits.
- Carefully follow the instructions that come with the restraint. If you install the restraint improperly, it may not work when you need it.

The passenger seat belts are equipped with either cinching latch plates or switchable seat belt retractors, which are designed to keep the lap portion tight around the child restraint so that it is not necessary to use a locking clip. If the seat belt has a cinching latch plate, pulling up on the shoulder portion of the lap/shoulder belt will tighten the belt. The cinching latch plate will keep the belt tight, however, any seat belt system will loosen with time, so check the belt occasionally and pull it tight if necessary.

If the seat belt has a switchable retractor, it will have a distinctive label.

- In the rear seat, you may have trouble tightening the lap/shoulder belt on the child restraint because the buckle or latch plate is too close to the belt path opening on the restraint. Disconnect the latch plate from the buckle and twist the short buckle end of the belt several times to shorten it. Insert the latch plate into the buckle with the release button facing out.
  - If the belt still can't be tightened, or if by pulling and pushing on the restraint loosens the belt, disconnect the latch plate from the buckle, turn the buckle around, and insert the latch plate into the buckle again. If you still can't make the child restraint secure, try a different seating position.
  - Buckle the child into the seat according to the child restraint manufacturer's directions.
- When your child restraint is not in use, secure it in the vehicle with the seat belt or remove it from the vehicle. Don't leave it loose in the vehicle. In a sudden stop or collision, it could strike the occupants or seat backs and cause serious personal injury.

#### **Automatic-Locking Retractor (ALR)**

Pull the belt from the retractor until there is enough to allow you to pass through the child restraint and slide the latch plate into the buckle. Then pull on the belt until it is all removed from the retractor. Allow the belt to return into the retractor, pulling on the excess webbing to tighten the lap portion about the child restraint. Follow the instructions of the child restraint manufacture.

**NOTE:** To reset this feature you must let all of the belt webbing return into the retractor. You will not be able to pull out more webbing until all of the webbing has been returned back into the retractor.

**Lower Anchors and Tether for Children (LATCH)**

Your vehicle is equipped with the child restraint anchorage system called LATCH, which stands for Lower Anchors and Tether for Children. The LATCH system provides for the installation of the child restraint without using the vehicle seat belt. All three rear seating positions have exclusive lower anchorages located at the rear of the seat cushion. They are round bars, part of the seat and body structure, and are readily visible. In addition, there are tether strap anchorages behind each rear seating position, located in the rear surface of the seat back.

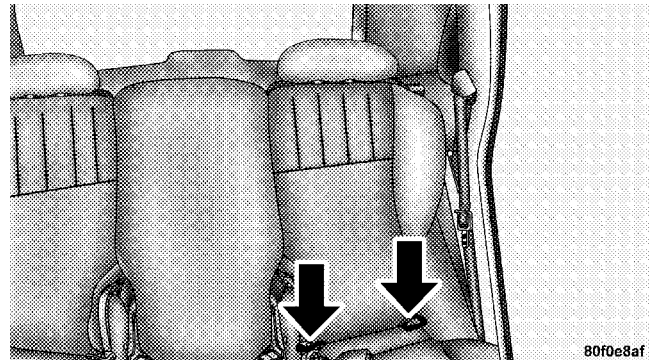

Child restraints systems having attachments designed to connect to the lower anchorages are now available. Child restraints having tether straps and hooks for connection to the top tether anchorage have been available for some time. In fact, many child restraint manufacturers will provide add-on tether strap kits for some of their older products. Tether anchorage kits are also available for most older vehicles.

Because the lower anchorages are to be introduced to passenger carrying vehicles over a period of years, child restraint systems having attachments for those anchorages will continue to have features for installation in vehicles using the lap or lap/shoulder belt. They will also have tether straps, and you are urged to take advantage of all of the available attachments provided with your child restraint in any vehicle.

#### **Installing the Child Restraint System**

While there are LATCH anchorages at all three rear seating positions, do not install child restraints at all three positions at the same time. The anchorages are not designed to restrain three child restraints at one time. Instead, you may install one child restraint at the center position, or two child restraints at the right and left positions.

#### **WARNING!**

**Do not install child restraint systems equipped with LATCH attachments at all three rear seating positions at one time. The LATCH anchorages are designed to restrain no more than two child restraints at a time in the event of a collision.**

We urge that you carefully follow the directions of the manufacturer when installing your child restraint. Many, but not all, restraint systems will be equipped with separate straps on each side, with each having a hook or connector and a means for adjusting the tension in the strap. Forward-facing toddler restraints and some rearward-facing infant restraints will also be equipped with a tether strap with a hook and means for adjusting the tension in the strap.



In general, you will first loosen the adjusters on the lower and tether straps so that you can more easily attach the hook or connector to the lower and tether anchorages. The tether strap should be routed under the center of the head restraint and attached to the tether anchor on the rear of the seat back. Then tighten all three straps as you push the child restraint rearward and downward into the seat.

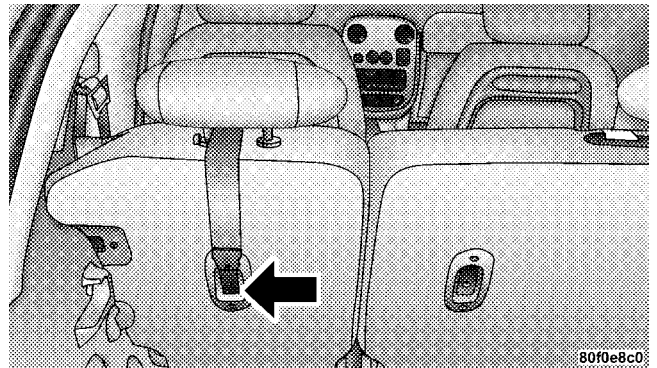

2

Not all child restraint systems will be installed as we have described here. Again, carefully follow the instructions that come with the child restraint system.

**NOTE:** If your child restraint seat is not LATCH compatible, install the restraint using the vehicle seat belts.

**WARNING!**

**An incorrectly anchored tether strap could lead to increased head motion and possible injury to the child. Use only the anchor position directly behind the child seat to secure a child restraint top tether strap.**

**Children Too Large For Booster Seats**

Children who are large enough to wear the shoulder belt comfortably, and whose legs are long enough to bend over the front of the seat when their back is against the seat back, should use the lap/shoulder belt in a rear seat.

- Make sure that the child is upright in the seat.
- The lap portion should be low on the hips and as snug as possible.

- Check belt fit periodically. A child's squirming or slouching can move the belt out of position.
- If the shoulder belt contacts the face or neck, move the child closer to the center of the vehicle. Never allow a child to put the shoulder belt under an arm or behind their back.

**Transporting Pets**

Airbags deploying in the front seat could harm your pet. An unrestrained pet will be thrown about and possibly injured, or injure a passenger during panic braking or in a collision.

Pets should be restrained in the rear seat in pet harnesses or pet carriers that are secured by seat belts.

### ENGINE BREAK-IN RECOMMENDATIONS

A long break-in period is not required for the engine in your new vehicle.

Drive moderately during the first 300 miles (500 km). After the initial 60 miles (100 km), speeds up to 50 or 55 mph (80 or 90 km/h) are desirable.

While cruising, brief full-throttle acceleration, within the limits of local traffic laws, contributes to a good break-in. Wide open throttle acceleration in low gear can be detrimental and should be avoided.

The engine oil installed in the engine at the factory is a high quality energy conserving type lubricant. Oil changes should be consistent with anticipated climate conditions under which vehicle operations will occur. The recommended viscosity and quality grades are shown in Section 7 of this manual. **NON-DETERGENT OR STRAIGHT MINERAL OILS MUST NEVER BE USED.**

A new engine may consume some oil during its first few thousand miles (kilometers) of operation. This should be considered as a normal part of the break-in and not interpreted as an indication of difficulty.

### SAFETY TIPS

#### Exhaust Gas

#### WARNING!

**Exhaust gases can injure or kill. They contain carbon monoxide (CO) which is colorless and odorless. Breathing it can make you unconscious and can eventually poison you. To avoid breathing (CO) follow the safety tips below.**

Do not run the engine in a closed garage or in confined areas any longer than needed to move your vehicle in or out of the area.

If it is necessary to sit in a parked vehicle with the engine running, adjust your heating or cooling controls to force outside air into the vehicle. Set the blower at high speed.

**WARNING!**

**If you are required to drive with the deck lid/liftgate open, make sure that all windows are closed, and the climate control blower switch is set at high speed. DO NOT use the recirculation mode.**

**Safety Checks You Should Make Inside The Vehicle**

**Seat Belts**

Inspect the belt system periodically, checking for cuts, frays and loose parts. Damaged parts must be replaced immediately. Do not disassemble or modify the system.

Front seat belt assemblies must be replaced after a collision. Rear seat belt assemblies must be replaced after a collision if they have been damaged (bent retractor, torn webbing, etc. If there is any question regarding belt or retractor condition, replace the belt.

**Airbag Light**

The light should come on and remain on for 6 to 8 seconds as a bulb check when the ignition switch is first turned ON. If the LED is not lit during starting, have it checked. If the light stays on or comes on while driving, have the system checked by an authorized dealer.

**Defroster**

Check operation by selecting the defrost mode and place the blower control on high speed. You should be able to feel the air directed against the windshield.

**Periodic Safety Checks You Should Make Outside The Vehicle****Tires**

Examine tires for excessive tread wear or uneven wear patterns. Check for stones, nails, glass, or other objects lodged in the tread. Inspect tread and sidewall for cuts or cracks. Check wheel nuts for tightness, and tires (including spare) for proper pressure.

**Lights**

Have someone observe the operation of exterior lights while you work the controls. Check turn signal and high beam indicator lights on the instrument panel.

**Fluid Leaks**

Check area under vehicle after overnight parking for fuel, engine coolant, oil or other fluid leaks. Also, if gasoline fumes are detected or fuel, power steering fluid or brake fluid leaks are suspected, the cause should be located and corrected immediately.



---

# UNDERSTANDING THE FEATURES OF YOUR VEHICLE

## CONTENTS

---

■ Mirrors . . . . .	.67	□ Operation . . . . .	.72
□ Inside Day/Night Mirror . . . . .	.67	□ Phone Call Features . . . . .	.76
□ Outside Mirror—Driver’s Side . . . . .	.67	□ Advanced Phone Connectivity . . . . .	.78
□ Outside Mirror—Passenger’s Side . . . . .	.68	□ UConnect™ System Features . . . . .	.79
□ Electric Remote-Control Mirrors — If Equipped . . . . .	.68	■ Seats . . . . .	.82
□ Illuminated Vanity Mirrors — If Equipped . . . . .	.69	□ Front Seat Adjustment . . . . .	.82
□ Sun Visor Sliding Feature . . . . .	.70	□ Driver’s Power Seat Height Adjuster — If Equipped . . . . .	.83
■ Hands-Free Communication (UConnect™) — If Equipped . . . . .	.70	□ Reclining Bucket Seats . . . . .	.84

64 UNDERSTANDING THE FEATURES OF YOUR VEHICLE

<input type="checkbox"/> Folding Front Passenger Seat — If Equipped . . .	.84	<input type="checkbox"/> Daytime Running Lights (Canada Only) . . . . .	.96
<input type="checkbox"/> Adjustable Head Restraints . . . . .	.85	<input type="checkbox"/> Lights-On Reminder . . . . .	.96
<input type="checkbox"/> Heated Seats — If Equipped . . . . .	.85	<input type="checkbox"/> Fog Lights — If Equipped . . . . .	.97
<input type="checkbox"/> Folding Rear Seat . . . . .	.86	<input type="checkbox"/> Turn Signals . . . . .	.97
<input type="checkbox"/> Tumbling Rear Seat . . . . .	.88	<input type="checkbox"/> Highbeam/Lowbeam Select Switch . . . . .	.97
<input type="checkbox"/> Rear Seat Removal . . . . .	.90	<input type="checkbox"/> Passing Light . . . . .	.97
■ To Open And Close The Hood . . . . .	.92	■ Windshield Wipers And Washers . . . . .	.98
■ Lights . . . . .	.93	<input type="checkbox"/> Windshield Washers . . . . .	.98
<input type="checkbox"/> Overhead Console Map/Reading Lights — If Equipped . . . . .	.93	<input type="checkbox"/> Mist Feature . . . . .	.98
<input type="checkbox"/> Interior Lights . . . . .	.94	<input type="checkbox"/> Windshield Wiper Operation . . . . .	.99
<input type="checkbox"/> Multi-Function Control Lever . . . . .	.95	<input type="checkbox"/> Intermittent Wiper System . . . . .	.99
<input type="checkbox"/> Headlights, Parking Lights, Instrument Panel Lights . . . . .	.96	■ Tilt Steering Column . . . . .	100
		■ Traction Control Switch — If Equipped . . . . .	100



<hr/>		<b>UNDERSTANDING THE FEATURES OF YOUR VEHICLE 65</b>
<b>■ Electronic Speed Control — If Equipped . . . . .</b>	101	<input type="checkbox"/> Outside Temperature . . . . . 107
<input type="checkbox"/> To Activate . . . . .	102	<b>■ Power Sunroof — If Equipped . . . . .</b>
<input type="checkbox"/> To Set At A Desired Speed . . . . .	102	<input type="checkbox"/> Express Open Feature . . . . . 108
<input type="checkbox"/> To Deactivate . . . . .	102	<input type="checkbox"/> Wind Buffeting . . . . . 109
<input type="checkbox"/> To Resume Speed . . . . .	103	<input type="checkbox"/> Sunroof Maintenance . . . . . 110
<input type="checkbox"/> To Vary The Speed Setting . . . . .	103	<b>■ Electrical Power Outlets . . . . .</b>
<input type="checkbox"/> Manual Transaxle . . . . .	103	<input type="checkbox"/> Electrical Outlet Use With Engine Off . . . . . 112
<input type="checkbox"/> To Accelerate For Passing . . . . .	104	<b>■ Console Features . . . . .</b>
<b>■ Overhead Console — If Equipped . . . . .</b>	104	<b>■ Storage . . . . .</b>
<input type="checkbox"/> Compass/Temperature Display . . . . .	105	<input type="checkbox"/> Front Seat Storage Bin — If Equipped . . . . . 114
<input type="checkbox"/> Automatic Compass Calibration . . . . .	106	<input type="checkbox"/> Storage Pockets . . . . . 114
<input type="checkbox"/> Compass Variance Selection . . . . .	106	<b>■ Rear Shelf Panel . . . . .</b>
<input type="checkbox"/> Manual Compass Calibration . . . . .	107	<input type="checkbox"/> Position 1 (Top) . . . . . 115

**66 UNDERSTANDING THE FEATURES OF YOUR VEHICLE**

---

<input type="checkbox"/> Position 2 (Middle) . . . . .	116	<input type="checkbox"/> Position 5 (Table) . . . . .	117
<input type="checkbox"/> Position 3 (Floor) . . . . .	116	<input checked="" type="checkbox"/> Roof Luggage Rack — If Equipped . . . . .	119
<input type="checkbox"/> Position 4 (Vertical) . . . . .	117		

## MIRRORS

### Inside Day/Night Mirror

Adjust the mirror to center on the view through the rear window. A two point pivot system allows for horizontal and vertical mirror adjustment.

Annoying headlight glare can be reduced by moving the small control under the mirror to the night position (toward rear of vehicle). The mirror should be adjusted while set in the day position (toward windshield).

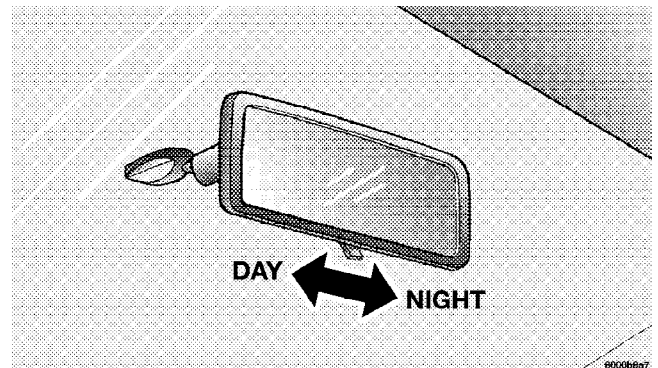

3

### Outside Mirror—Driver's Side

Adjust the outside mirror to center on the adjacent lane of traffic, with a slight overlap of the view obtained on the inside mirror.

**Outside Mirror—Passenger’s Side**

Adjust the convex outside mirror so you can just see the side of your vehicle in the part of the mirror closest to the vehicle.

**WARNING!**

**Vehicles and other objects seen in the passenger side convex mirror will look smaller and farther away than they really are. Relying too much on your passenger side mirror could cause you to collide with another vehicle or other object. Use your inside mirror when judging the size or distance of a vehicle seen in this convex mirror.**

**Electric Remote-Control Mirrors — If Equipped**

Use the mirror select switch, located to the left of the steering column on the instrument panel, to adjust the view obtained in the outside mirrors. Press the L or R button for Left or Right mirror selection. Use the center off position to guard against accidentally moving a mirror position.

Select a mirror and press one of the four arrows for the direction you want the mirror to move.

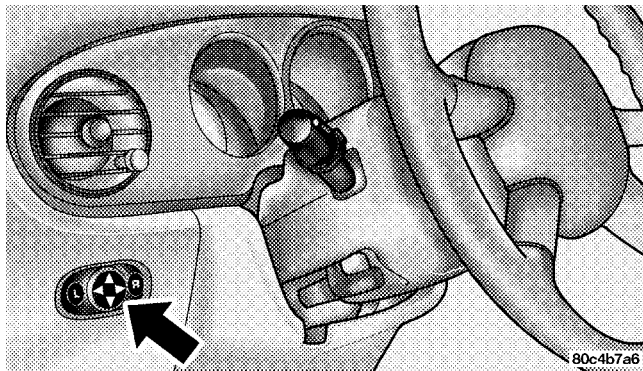

**Illuminated Vanity Mirrors — If Equipped**

An illuminated vanity mirror is on the sun visor. To use the mirror, rotate the sun visor down and swing the mirror cover upward. The lights turn on automatically. Closing the mirror cover turns off the lights.

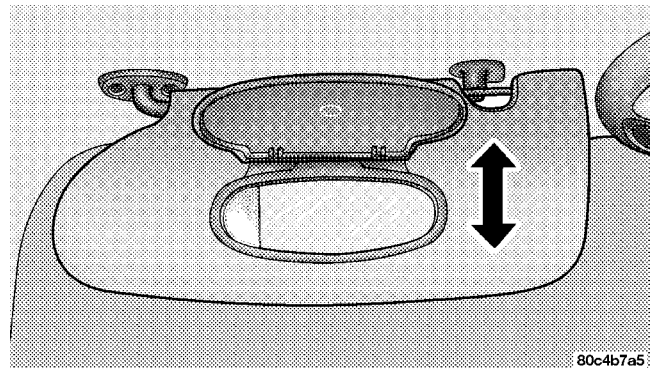

### **Sun Visor Sliding Feature**

The sun visors may be pulled out to provide extended coverage of the side glass.

### **HANDS-FREE COMMUNICATION (UConnect™) — IF EQUIPPED**

UConnect™ is a voice-activated, hands-free, in-vehicle communications system. UConnect™ allows you to dial your cellular phone using simple voice commands (e.g., “Call Mike Work” or “Dial 248-555-1212”). Your cellular phone’s audio is transmitted through your vehicle’s stereo system; the system will automatically mute your radio before receiving or sending a call.

UConnect™ allows you to transfer calls between the system and your cellular phone as you enter or exit your vehicle, and enables you to mute the system’s microphone for private conversations.

The UConnect™ phone book enables you to store up to 32 names and four numbers per name. This system is driven through your Bluetooth™ Hands-Free Profile cellular phone. UConnect™ features Bluetooth™ technology - the global standard that enables different electronic devices to connect to each other without wires or a docking station, so UConnect™ works no matter where you stow your cellular phone (be it your purse, pocket, or briefcase). UConnect™ allows up to seven cellular phones to be linked to the system, and it is available in English, French, or Spanish formats (as equipped).

The rearview mirror contains the microphone for the system and the control buttons that will enable you to access the system. The diagram below shows the mirror with the appropriate buttons. Individual button behavior is discussed in the “Operation” Section.

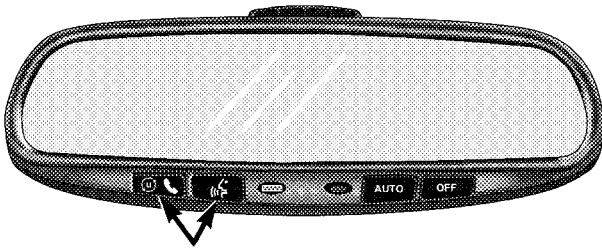

8105b20d

The UConnect™ system can be used with any Hands Free Profile certified Bluetooth™ cellular phone. If your cellular phone has a different profile (i.e. headset profile), you will not be able to use any UConnect™ features.

The UConnect™ system is fully integrated into your vehicle, including your vehicle's stereo system. All voice prompts as well as the other party's voice in a conversation will be played over your vehicle's stereo system. The volume of the UConnect™ system can be controlled through your normal stereo controls.

The radio display will be used for visual prompts from the UConnect™ system such as caller ID.

**Operation**

Voice commands can be used in the operation of the UConnect™ system and to navigate through the UConnect™ menu structure. Voice commands should be given after each UConnect™ system prompt. You will be prompted for a specific command and then guided through the available options. There are two ways to give commands to the UConnect™ system:

- You can say "Dial" at the "Ready" prompt. When prompted for the phone number you wish to dial, say the phone number ("123 456 7890").
- Alternatively as you become familiar with the UConnect™ system, you can combine the commands and say "Dial 123 456 7890".

**Pairing a Cellular Phone to the UConnect™ System**

To begin using your UConnect™ system, you must pair your compatible Bluetooth™ enabled cellular phone. To

complete the registration process, you will need to reference your cellular phone owner's manual.

- Press the 'Phone' button to begin.
- After the "Ready" prompt, say "Setup Phone Pairing".
- You will be asked to say a four-digit pin number into the UConnect™ system which you will later need to enter into your cellular phone during the cellular phone pairing process. You can enter any four-digit pin number. You will not need to remember this pin number after the initial registration process.
- The UConnect™ system will then prompt you to begin the cellular phone pairing process on your cellular phone. Please see your cellular phone user's manual for instructions on how to complete this step.



- For identification purposes, you will be prompted to give the UConnect™ system a name for your cellular phone. Each cellular phone that is paired should be given a unique phone name.
- You will then be asked to give your cellular phone a priority level between 1 and 7, 1 having the highest priority. You can connect up to seven cellular phones to your UConnect™ system and the priority allows the UConnect™ system to know which cellular phone to use if multiple cellular phones are in the vehicle at the same time. For example, if a priority 3 and priority 5 cellular phone are both in the vehicle, the UConnect™ system will use the priority 3 cellular phone when you make a call. You can select to use a lower priority cellular phone at any time.

### **Making a Phone Call Using Digit Dialing**

- Press the 'Phone' button to begin.
- After the "Ready" prompt, say "Dial" or "Call" followed by the phone number you wish to dial. For example, you can say "Dial 123 456 7890". The phone number that you enter must be a valid length.

### **Making a Phone Call Using Your UConnect™ Phonebook**

- Press the "Phone" button to begin.
- After the "Ready" prompt, say "Dial" or "Call" followed by the name and designation of a phonebook entry that you wish to dial. For example, you can say "Call John Doe Work".

**Add Names to Your UConnect™ Phonebook**

- Press the “Phone” button to begin.
- After the “Ready” prompt, say “Phonebook New Entry”.
- When prompted, say the name of the new entry.
- Next, enter the number designation (e.g. “Home”, “Work”, “Mobile”, or “Pager”). This will allow you to have multiple numbers for each phonebook entry.
- Recite the phone number for the phonebook entry that you are adding.

After you are finished adding an entry into the phonebook, you will be given the opportunity to add more phone numbers to the current entry or to return to the main menu.

The UConnect™ system will allow you to enter up to 32 names into the phonebook with each name having up to four associated phone numbers and designations.

**Edit Entries in the UConnect™ Phonebook**

- Press the ‘Phone’ button to begin.
- After the “Ready” prompt, say “Phonebook Edit”.
- You will then be asked for the name of the phonebook entry that you wish to edit.
- Next, choose the number designation that you wish to edit. The choices are home, work, mobile, or pager.
- Recite the new phone number for the phonebook entry that you are editing.

After you are finished editing an entry in the phonebook, you will be given the opportunities to edit another entry in the phonebook, call the number you just edited, or return to the main menu.

Phonebook edit can be used to add another phone number to a name entry that already exists in the phonebook. For example, the entry John Doe may have a mobile and a home number, but you can add John Doe's work number later through phonebook edit.

#### **Delete Entries in the UConnect™ Phonebook**

- Press the 'Phone' button to begin.
- After the "Ready" prompt, say "Phonebook Delete".
- After you enter the phonebook delete menu, you will then be asked for the name of the phonebook entry that you wish to delete. You can either say the name of a phonebook entry that you wish to delete or you can say "List Names" to hear a list of the entries in the phonebook from which you can choose. To select one of the entries from the list, press the "Voice Recognition" button while the UConnect™ system is playing the desired entry and say "Delete".

- After you enter the name, the UConnect™ system will ask you if you wish to delete the home, work, mobile, or pager number for this entry.

#### **Delete All Entries in the UConnect™ Phonebook**

- Press the 'Phone' button to begin.
- After the "Ready" prompt, say "Phonebook Delete All".
- The UConnect™ system will ask you to verify that you wish to delete all the entries from the phonebook.
- After confirmation, the phonebook entries will be deleted.

#### **List All Names in the UConnect™ Phonebook**

- Press the 'Phone' button to begin.
- After the "Ready" prompt, say "Phonebook List Names".

- The UConnect™ system will play the names of all the phonebook entries.
- To call one of the names in the list, press the 'Voice Recognition' button during the playing of the desired name and say "Call".
- The UConnect™ system will then prompt you as to number designation you wish to call.
- The selected number will be dialed.

#### **Phone Call Features**

The following feature(s) can be accessed through the UConnect™ system if the feature(s) are available on your cellular service plan. For example, if your cellular service plan provides three-way calling, this feature can be accessed through the UConnect™ system.

#### **Answer or Reject an Incoming Call - No Call Currently in Progress**

When you receive a call on your cellular phone, the UConnect™ system will interrupt the stereo audio and will ask if you would like to answer the call by pressing the 'Phone' button. Press the 'Phone' button to answer the call. To reject the call, press the 'Phone' button until you hear a single beep indicating that the incoming call was rejected.

#### **Answer or Reject an Incoming Call - Call Currently in Progress**

If a call is currently in progress and you have another incoming call, press the 'Phone' button to place the current call on hold and answer the incoming call. To reject the incoming call, you can disregard the call and continue with your current conversation.

**Making a Second Call while Current Call in Progress**

To make a second call while you are currently in a call, press the 'Voice Recognition' button and say "Dial" or "Call" followed by the phone number or phonebook entry you wish to call. The first call will be on hold while the second call is in progress.

**Putting a Call on Hold and Retrieving a Call from Hold**

To put a call on hold, press the 'Phone' button until you hear a single beep which will indicate that the call has been placed on hold. To bring the call back from hold, press the 'Phone' button.

**Toggling Between Two Calls**

If two calls are in progress (one active and one on hold), press the 'Phone' button until you hear a single beep indicating that the active and hold status of the two calls have switched. Only one call can be placed on hold at one time.

**Conference Call**

When two calls are in progress (one active and one on hold), press the 'Phone' button until you hear a double beep indicating that the two calls have been joined into one conference call.

**Three-Way Calling**

To initiate three-way calling, press the 'Voice Recognition' button while a call is in progress and make a second phone call. When the second call is established, press the 'Phone' button until you hear a double beep indicating that the two calls have been joined into one conference call.

**Call Termination**

To end a call in progress, press the 'Phone' button. All calls in progress will be terminated.

### **Phone Redial**

- Press the 'Phone' button to begin.
- After the "Ready" prompt, say "Redial".
- The UConnect™ system will call the last number that was dialed on your cellular phone. This may not be the last number dialed by your UConnect™ system.

### **Advanced Phone Connectivity**

#### **Transferring an Active Call between the UConnect™ System and Your Cellular Phone**

The UConnect™ system allows ongoing calls to be transferred to your cellular phone or to the UConnect™ system without terminating the call. To transfer an ongoing call from your cellular phone to the UConnect™ system or vice versa, press the 'Voice Recognition' button and say "Transfer Call".

### **Delete Paired Cellular Phones**

- Press the 'Phone' button to begin.
- After the "Ready" prompt, say "Setup Phone Pairing".
- At the next prompt, say "Delete".
- You will be asked to say the name of the phone that you wish to delete. You can either say the name of the phone that you wish to delete or you can say "All" to delete all the phones.

#### **Connect or Disconnect the Connection between the UConnect™ System and Your Cellular Phone**

Your cellular phone can be paired with many different electronic devices, but can only be actively "connected" with one electronic device at a time.

If you would like to connect or disconnect the Bluetooth™ connection between a paired cellular phone and the UConnect™ system, follow the instruction described in your cellular phone user's manual.

#### List Paired Cellular Phone Names

- Press the 'Phone' button to begin.
- After the "Ready" prompt, say "Setup List Phones" and the UConnect™ system will play the phone names of all paired cellular phones in order from highest priority to lowest priority.

#### Select a Lower Priority Paired Cellular Phone

- Press the 'Phone' button to begin.
- After the "Ready" prompt, say "Setup Select Phone".
- When prompted, say the phone name of the cellular phone you wish to use, or say "List Phones" to hear a list of all the phones that have been paired to your

UConnect™ system. To select a phone from the list, press the 'Voice Recognition' button and say "Select".

- The lower priority phone will only be used for the next phone call. After that, the UConnect™ system will return to using the highest priority phone in the vehicle.

#### UConnect™ System Features

##### Barge In - Touch Tone Phone Inputs

You can use your UConnect™ system to access a voice mail system, an automated service, or any other phone number that you can dial with any phone. When calling a number with your UConnect™ system that normally requires you to enter in a touch-tone sequence on your cellular phone keypad, you can push the 'Voice Recognition' button and say the sequence you wish to enter followed by "Send". For example, if required to enter your pin number, you can press the 'Voice Recognition' button and say "3 7 4 6 Send", or whatever you have made your

pin. This method can also be used in instances where you are pressing a number on your keypad to navigate through a menu structure or to enter a number for a pager.

#### **Barge In - Overriding Prompts**

The 'Voice Recognition' button can be used when you wish to skip part of a prompt and issue your voice recognition command immediately. For example, if a prompt is playing "Would you like to pair a phone, clear a...", you could press the 'Voice Recognition' button and say "Pair A Phone" to select that option without having to listen to the rest of the voice prompt.

#### **Language Selection**

To change the language that the UConnect™ system is using, press the 'Phone' button and say the name of the language you wish to switch to (English, Español, or

Français as equipped). After selecting one of the languages, all prompts and voice commands will be in the selected language.

#### **Turning Confirmation Prompts On/Off**

Turning confirmation prompts off will stop the system from confirming your choices (e.g. the UConnect™ system will not repeat a phone number before you dial it).

- Press the 'Phone' button to begin.
- After the "Ready" prompt, say "Setup Confirmation". The UConnect™ system will play the current confirmation prompt status and you will be given the choice to change it.



**Low Signal, Battery Strength, and Roam Notification**

The UConnect™ system will provide notification to inform you if your cellular phone is in roaming status, has low signal strength, or has a low battery when you are trying to place a phone call.

**Dialing Using the Cellular Phone Keypad**

You can dial a phone number with your cellular phone keypad and still use the UConnect™ system. By dialing a number with your paired Bluetooth™ cellular phone, the audio will be played through your vehicle's stereo system. The UConnect™ system will work the same as if you dialed the number using voice recognition.

**Mute/Unmute**

When you mute the UConnect™ system, you will still be able to hear the conversation coming from the other party, but the other party will not be able to hear you. In order to mute the UConnect™ system press the 'Voice

Recognition' button and say "Mute". In order to unmute the UConnect™ system; press the 'Voice Recognition' button and say "Unmute".

**Help**

If you need assistance at any prompt or if you want to know what your options are at any prompt, say "Help". The UConnect™ system will play all the options at any prompt if you ask for help.

**Cancel**

At any prompt, you can say "Cancel" and you will be returned to the previous menu.

**Emergency Assistance**

If you are in an emergency, say "Dial Emergency" or "Call Emergency" and the UConnect™ system will instruct your cellular phone to call 911.

### **Towing Assistance**

If you need towing assistance, say "Dial Towing Assistance" or "Call Towing Assistance". Please refer to the 24-Hour Towing Assistance coverage details in the DaimlerChrysler Motors Company 24-Hour Towing Assistance Program Guide.

### **SEATS**

#### **Front Seat Adjustment**

The adjusting bar is at the front of the seats, near the floor. Pull the bar up to move the seat to the desired position.



Using body pressure, move forward and rearward on the seat to be sure the seat adjusters have latched.

**WARNING!**

- **Adjusting a seat while the vehicle is moving is dangerous. The sudden movement of the seat could cause you to lose control. The seat belt might not be properly adjusted and you could be injured. Adjust the seat only while the vehicle is parked.**
- **Do not ride with the seatback reclined so that the shoulder belt is no longer resting against your chest. In a collision you could slide under the seat belt and be seriously or even fatally injured. Use the recliner only when the vehicle is parked.**

**Driver's Power Seat Height Adjuster — If Equipped**

The power seat height adjuster is on the outboard side of the driver's seat. Use this switch to move the seat up or down.

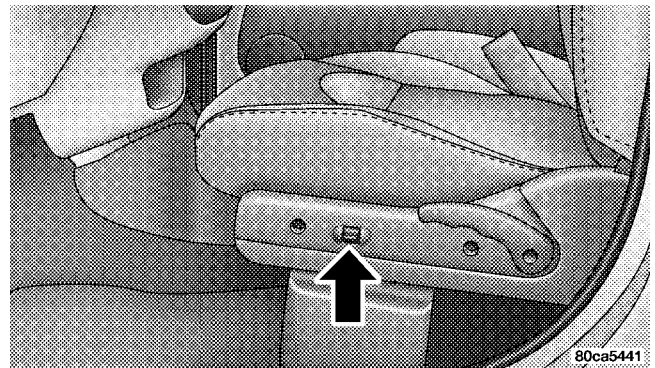

3

### Reclining Bucket Seats

The recliner control is on the outboard side of the seat. To recline, lean forward slightly before lifting the lever, then lean back to the desired position and release the lever. Lean forward and lift the lever to return the seatback to its normal position.

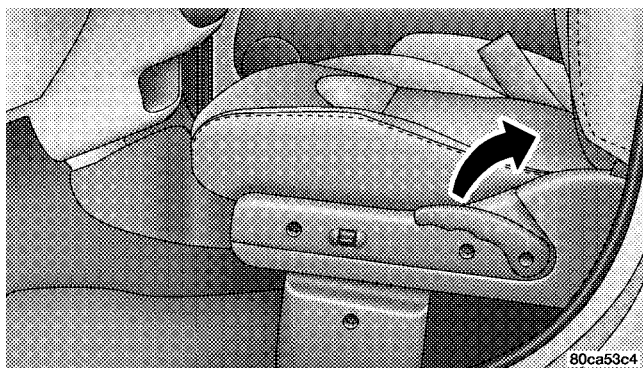

### Folding Front Passenger Seat — If Equipped

The passenger front seat may be folded fully forward to provide additional cargo space.

To fold the seat forward pull up on the recliner lever located on the outboard side of the seat.

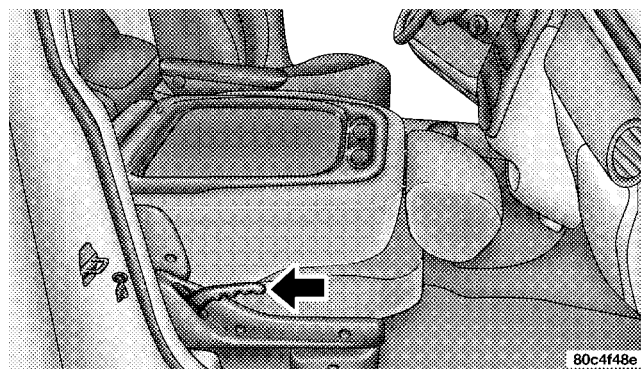

### Adjustable Head Restraints

Head restraints can reduce the risk of whiplash injury in the event of impact from the rear. Pull up or push down on the head restraints so that the upper edge is as high as practical. To raise the head restraint, pull up on the head restraint. To lower the head restraint, depress the button and push down on the head restraint.

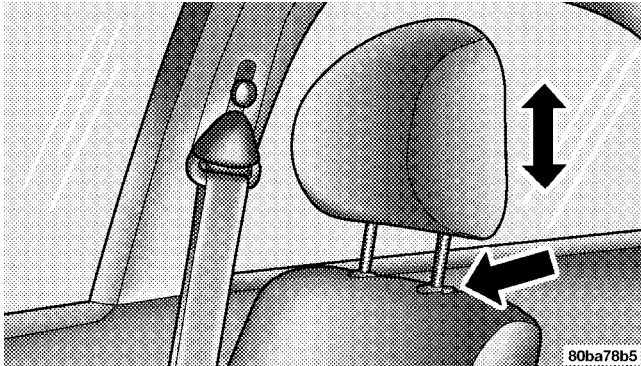

### Heated Seats — If Equipped

This feature heats the front driver's and passenger's seats. The control for the heater is located on the out-board side of each seat. After turning on the ignition, you may choose from HIGH, or LOW heat settings. An indicator on the switch shows which setting has been chosen.

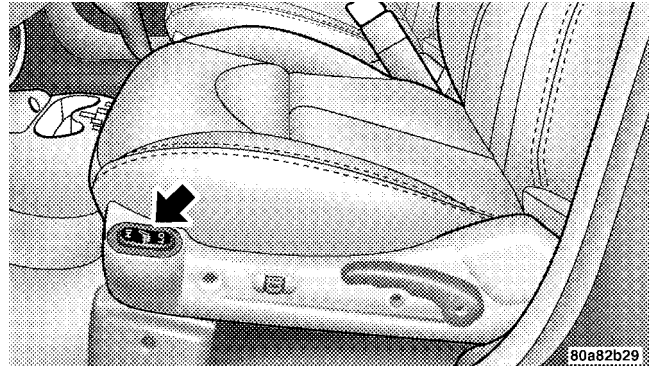

Press the switch once to select a heat setting (high or low) and press the switch a second time in the same direction to turn the heated seat off.

**NOTE:** Once a heat setting is selected, heat will be felt within 2 to 3 minutes.

**Folding Rear Seat**

To provide additional storage area, each rear seatback can be folded forward. Push and hold the buttons shown in the picture to fold down either or both seatbacks.

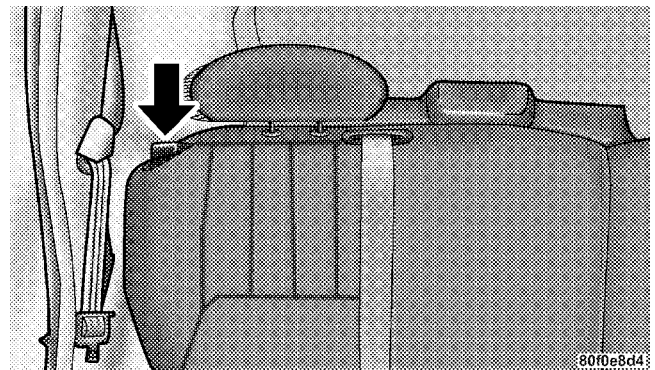

**WARNING!**

- It is extremely dangerous to ride in a cargo area, inside or outside of a vehicle. In a collision, people riding in these areas are more likely to be seriously injured or killed.
- Do not allow people to ride in any area of your vehicle that is not equipped with seats and seat belts
- Be sure that everyone in your vehicle is in a seat and using a seat belt properly.

**NOTE:**

- If the rear center lap/shoulder belt appears to be locked into place, check to verify that the seatback is fully latched.

- If the seatback is properly latched and the rear center lap/shoulder belt still does not operate properly check and see if the Automatic Locking retractor (ALR) system is activated.

**WARNING!**

The rear center lap/shoulder belt is equipped with a lock-out feature to ensure that the seatback is in the fully upright and locked position when occupied. If the rear seatback is not fully upright and locked and the rear center lap/shoulder belt can be pulled out of the retractor, the vehicle should immediately be taken to your dealer for service. Failure to follow this warning could result in serious or fatal injury.

### Tumbling Rear Seat

To provide additional storage in the cargo area, each rear seat can be tumbled forward.

#### CAUTION!

It is important that the front seats be pulled forward to the midpoint of the seat track to avoid contact between the rear seat and the front seatback. If the front seat is not pulled forward the two seats will make contact during the tumbling motion and cause damage to the rear seat material. After the rear seat is tumbled forward and secured the front seat can then be repositioned to the preferred position.

- Push and hold the button on the seatback and fold down the rear seatback.

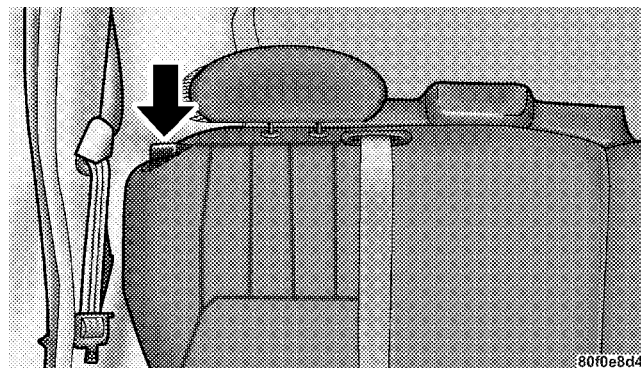



- Pull the release lever located on the outboard side of the seat. Lift up the seat and tumble the seat forward.

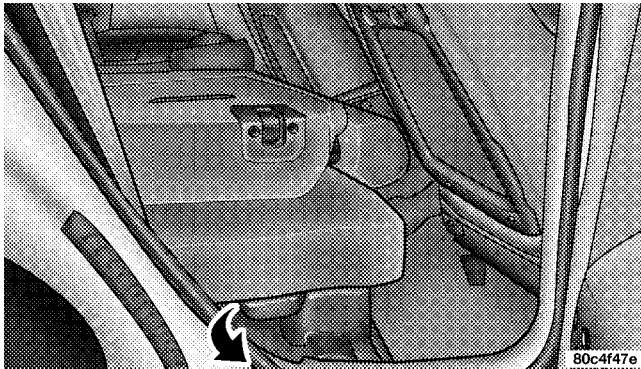

- Attach the elastic strap, located at the base of the seat cushion, onto the hook bar on the center trim panel to hold the seat in place.

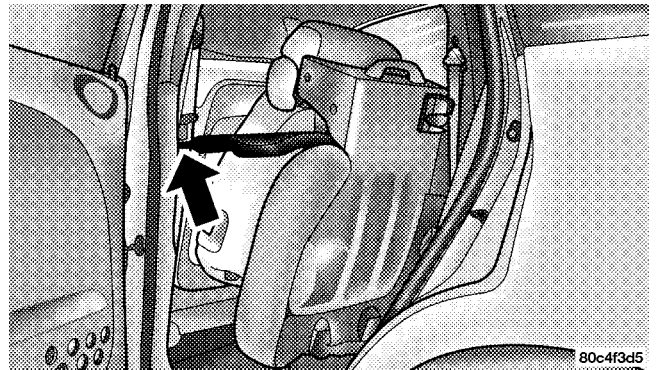

To return the rear seat to its upright latched position, rotate the seat cushion rearward to latch the seat. Then lift the seatback to its upright latched position.

**NOTE:** The elastic strap should be reinstalled in the clip on the base of the seat cushion before returning the seat to its normal position.

### Rear Seat Removal

The rear seats can be removed to provide more cargo space.

- Push and hold the button on the seatback and fold down the rear seatback.

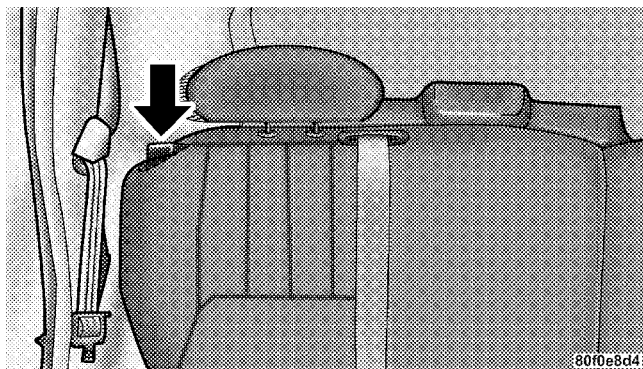

- Pull the release lever located on the outboard side of the seat. Lift up the seat and tumble the seat forward.

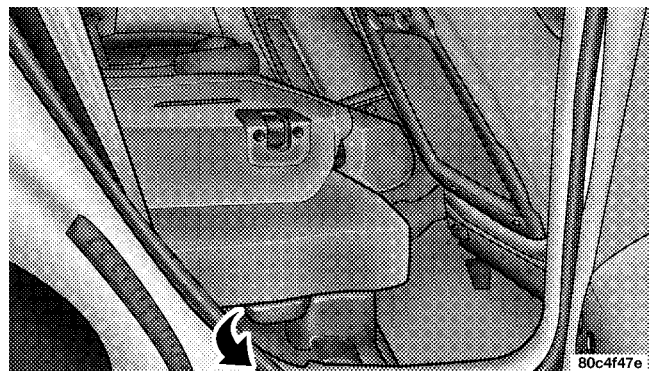

- Lift up the release levers to disengage the seat from the floor attachments.

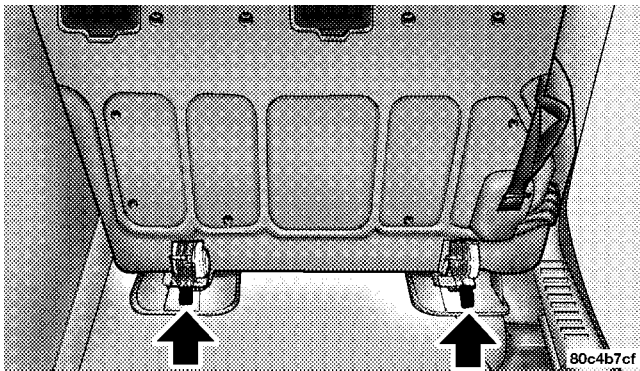

- Using the handle on the seat, the seat assembly can now be lifted and removed from the vehicle.

**NOTE:** Small rollers on the bottom of the folded seat and a handle at the top allow the seat to be easily moved when removed from the vehicle.

To reinstall the rear seat, insert the seat into the floor attachments. Lower the release levers of the seat to latch the front floor attachments and rotate the seat rearward to latch the seat. Lift the seat back to its upright latched position.

3

**WARNING!**

**In an accident, you or others in your vehicle could be injured if seats are not properly latched to their floor attachments. Always be sure the seats are fully latched.**

**TO OPEN AND CLOSE THE HOOD**

To open the hood, two latches must be released. First pull the hood release lever located under the left side of the instrument panel.

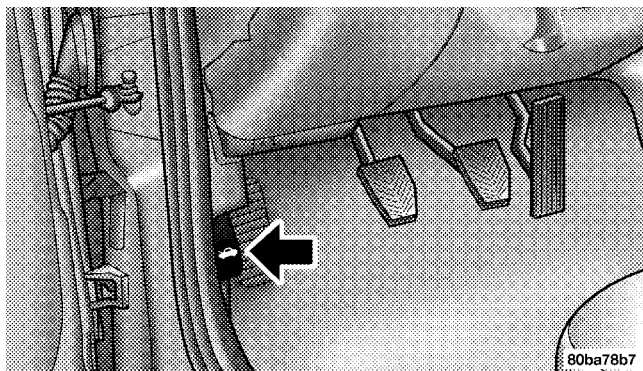

Then move the safety catch located under the front edge of the hood, near the center and slightly to the right, and raise the hood.

Use the hood prop rod clipped to the driver's side of the engine compartment to secure the hood in the open position. Place the hood prop at the location stamped into the inner hood surface.

To prevent possible damage, do not slam the hood to close it. Lower the hood until it is open approximately 20 cm (8 inches) and then drop it. This should secure both latches. Never drive your vehicle unless the hood is fully closed, with both latches engaged.

**WARNING!**

**If the hood is not fully latched it could fly up when the vehicle is moving and block your forward vision. You could have a collision. Be sure all hood latches are fully latched before driving.**

## LIGHTS

### Overhead Console Map/Reading Lights — If Equipped

These lights are mounted between the sun visors in the overhead console. Each light is turned ON by pressing the lens. Press the lens a second time to turn the light OFF. The lights also come on when a door is opened or the dimmer control is turned fully upward, past the second detent.

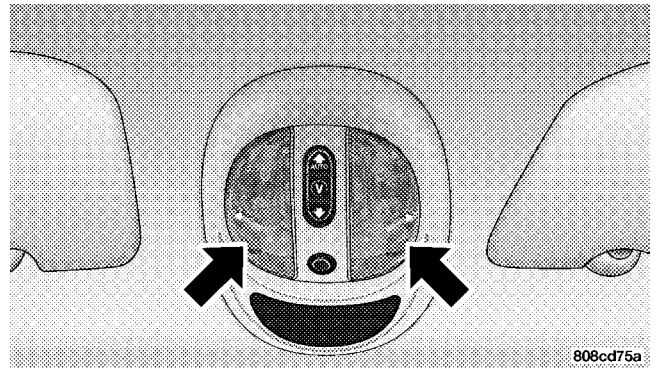

3

**NOTE:** The lights will remain on until the switch is pressed a second time, so be sure they have been turned off before leaving the vehicle. They will not turn off automatically.

**Interior Lights**

The interior lights come on when a door is opened.

With the ignition key in the OFF position, the interior lights will automatically turn off in about 8 minutes if a door is left open or the dimmer control is left in the Dome light position. Turn the ignition switch ON to restore the interior light operation.

**Dimmer Control**

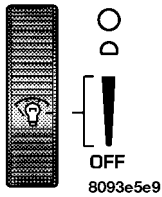

With the parking lights or headlights on, rotating the dimmer control for the interior lights on the Multi-Function Control Lever upward will increase the brightness of the instrument panel lights.

**Dome Light Position**

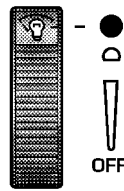

Rotate the dimmer control completely upward to the second detent to turn on the interior lights. The interior lights will remain on when the dimmer control is in this position. With the ignition key in the OFF position, the interior lights will automatically turn off in about 8 minutes if the dimmer control is left in the Dome light position.

tion.

**Interior light Defeat (OFF)**

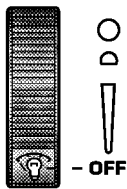

8093e60e

Rotate the dimmer control to the extreme bottom "OFF" position. The interior lights will remain off when the doors are open.

**Multi-Function Control Lever**

The Multi-Function Control Lever controls the operation of the headlights, parking lights, turn signals, headlight beam selection, instrument panel light dimming, interior lights, the passing lights, and fog lights. The lever is located on the left side of the steering column.

**Parade Mode (Daytime Brightness Feature)**

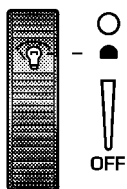

8093e650

Rotate the dimmer control to the first detent (white semi-circle). This feature brightens the odometer and radio display when the parking lights or headlights are on during daylight conditions.

**Headlights, Parking Lights, Instrument Panel Lights**

Turn the end of the Multi-Function Control Lever to the first detent for parking light operation. Turn to the second detent for headlight operation.

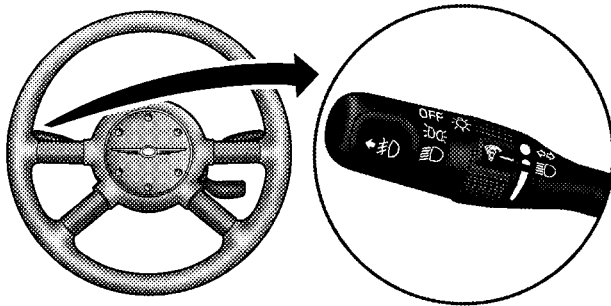

80c4f4a7

To change the brightness of the instrument panel lights, rotate the center portion of the Multi-Function Control Lever up or down.

**Daytime Running Lights (Canada Only)**

The front turn signal lights will come on as Daytime Running Lights whenever the ignition switch is on, the headlights are off, and the parking brake is off. The headlight switch must be used for normal night time driving.

**Lights-on Reminder**

If the headlights or parking lights are on after the ignition is turned OFF, a chime will sound to alert the driver when the driver's door is opened.



**Fog Lights — If Equipped**

 The front fog light switch is on the Multi-Function Control Lever. To activate the front fog lights, turn on the parking lights or the low beam headlights and pull out the end of the control lever.

**NOTE:** The fog lights will only operate with the headlights on low beam. Selecting high beam headlights will turn off the fog lights.

**Turn Signals**

Move the Multi-Function Control Lever up or down and the arrows on each side of the instrument cluster flash to show proper operation of the front and rear turn signal lights. You can signal a lane change by moving the lever partially up or down without moving beyond the detent.

If either light remains on and does not flash, or there is a very fast flash rate, check for a defective outside light bulb. If an indicator fails to light when the lever is moved, it would suggest that the fuse or indicator bulb is defective.

**Highbeam/Lowbeam Select Switch**

Pull the Multi-Function Control Lever towards you to switch the headlights to HIGH beam. Pull the control lever a second time to switch the headlights to LOW beam.

**Passing Light**

You can signal another vehicle with your headlights by lightly pulling the Multi-Function Control Lever toward you. This will cause the headlights to turn on at high beam and remain on until the lever is released.

### WINDSHIELD WIPERS AND WASHERS



The wipers and washers are operated by a switch on the control lever. The lever is located on the right side of the steering column. Move the control lever up to select the desired wiper speed.

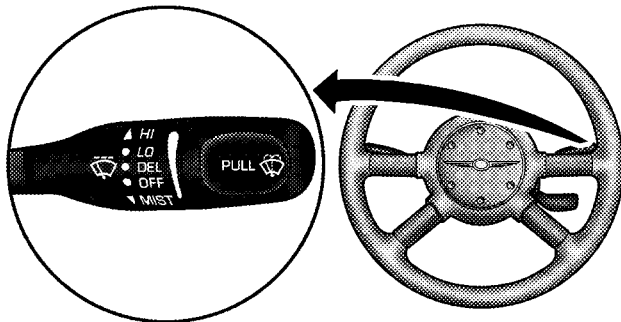

80c4b7a0

### Windshield Washers

To use the washer, pull the control lever toward you and hold while spray is desired. If the lever is pulled while in the delay range, the wiper will operate in low speed for two wipe cycles after the lever is released, and then resume the intermittent interval previously selected.

If the lever is pulled while in the OFF position, the wipers will operate for two wipe cycles, then turn OFF.

### Mist Feature

Push down on the wiper control lever to activate a single wipe to clear the windshield of road mist or spray from a passing vehicle. As long as the lever is held down, the wipers will continue to operate.

**CAUTION!**

In cold weather, always turn off the wiper switch and allow the wipers to return to the park position before turning off the engine. If the wiper switch is left on and the wipers freeze to the windshield, damage to the wiper motor may occur when the vehicle is restarted.

**Windshield Wiper Operation**

Move the lever upward to the second detent for Low speed wiper operation, or to the third detent for High speed operation

**Intermittent Wiper System**

Use the intermittent wiper when weather conditions make a single wiping cycle, with a variable pause between cycles, desirable. Move the lever to the DEL position, then select the delay interval by turning the end of the lever. Rotate the knob upward (clockwise) to decrease the delay time and downward (counterclockwise) to increase the delay time. The delay can be regulated from a maximum of approximately 18 seconds between cycles, to a cycle every second.

### TILT STEERING COLUMN

To tilt the column, push down on the lever below the multi-function control lever and move the steering wheel up or down, as desired. Pull the lever back up to lock the column firmly in place.

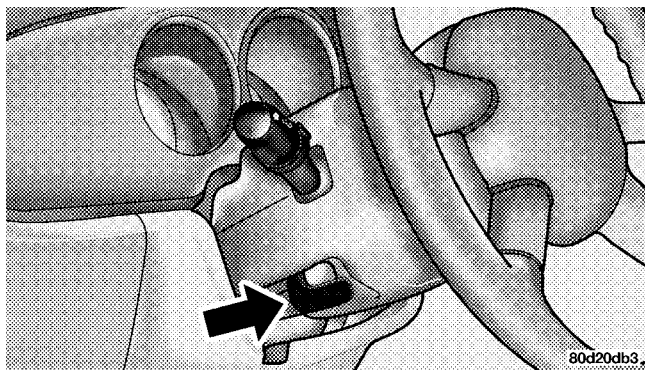

### WARNING!

**Tilting the steering column while the vehicle is moving is dangerous. Without a stable steering column, you could lose control of the vehicle and have an accident. Adjust the column only while the vehicle is stopped. Be sure it is locked before driving.**

### TRACTION CONTROL SWITCH — IF EQUIPPED

The TRAC indicator, located in the instrument cluster, will flash when the Traction Control System is in use.

The TRAC OFF switch is located on the instrument panel below the radio.

To turn the system OFF, press the TRAC OFF switch until the TRAC OFF indicator in the instrument cluster lights up.

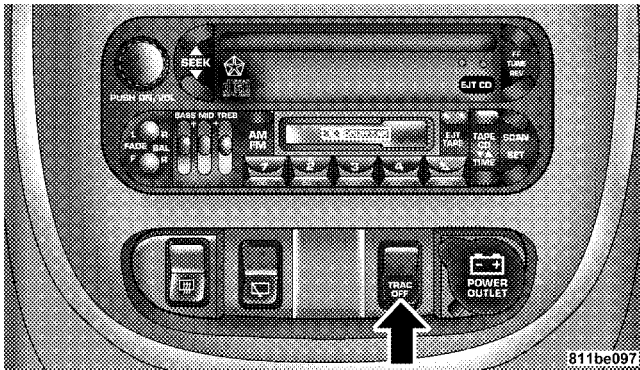

To turn the system back ON, press the switch a second time until the TRAC OFF indicator turns OFF.

**NOTE:** The Traction Control System indicator “TRAC OFF” will illuminate momentarily as a bulb check, each time the ignition switch is turned ON. This will occur even if you used the “TRAC OFF” switch to turn the system OFF.

**NOTE:** The Traction Control System will make buzzing or clicking sounds when the system is in operation.

**ELECTRONIC SPEED CONTROL — IF EQUIPPED**  
 When engaged, this device takes over the accelerator operation at speeds greater than 25 mph (40 km/h). The speed control lever is located on the right side of the steering wheel.

3

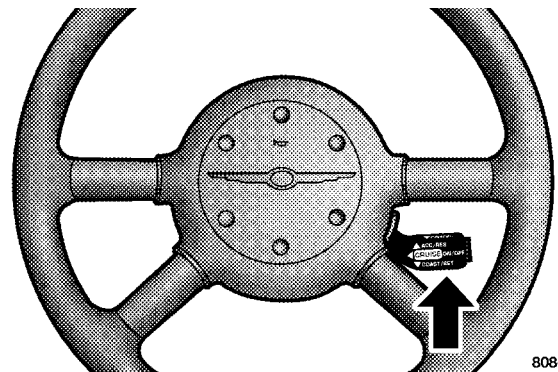

**To Activate:**

Push the ON/OFF button. The CRUISE indicator in the instrument cluster will illuminate. To turn the system OFF, push the ON/OFF button a second time. The CRUISE indicator will turn off. The system should be turned OFF when not in use.

**WARNING!**

**Leaving the Electronic Speed Control system on when not in use is dangerous. You could accidentally set the system or cause it to go faster than you want. You could lose control and have an accident. Always leave the system OFF when you are not using it.**

**To Set At A Desired Speed:**

When the vehicle has reached the desired speed, press down on the lever and release. Release the accelerator and the vehicle will operate at the selected speed.

**NOTE:** The vehicle should be traveling at a steady speed and on level ground before pressing the SET lever.

While in the AutoStick mode, speed control will only operate in third and fourth gear.

**To Deactivate:**

A soft tap on the brake pedal, pulling the speed control lever towards you "CANCEL", or normal brake or clutch pressure while slowing the vehicle will deactivate speed control without erasing the set speed memory. Pressing the ON/OFF button or turning off the ignition switch erases the set speed memory.

**To Resume Speed:**

To resume a previously set speed, push the “ACC/RES” lever up and release. Resume can be used at any speed above 20 mph (32 km/h).

**To Vary The Speed Setting:**

When the speed control is ON, speed can be increased by pushing up and holding “ACC/RES”. Release the lever when the desired speed is reached, and the new speed will be set.

Tapping “ACC/RES” once will result in a 2 mph (3 km/h) speed increase. Each time the lever is tapped, speed increases so that tapping the lever three times will increase speed by 6 mph (10 km/h), etc.

To decrease speed while speed control is ON, push down and hold “COAST/SET”. Release the lever when the desired speed is reached, and the new speed will be set.

Tapping the “COAST/SET” button once will result in a 1 mph (2 km/h) speed decrease. Each time the button is tapped, speed decreases.

**Manual Transaxle:**

Depressing the clutch pedal will disengage the speed control. A slight increase in engine RPM before the speed control disengages is normal.

Vehicles equipped with manual transaxles may need to be shifted into a lower gear to climb hills without speed loss.

**WARNING!**

**Speed Control can be dangerous where the system can't maintain a constant speed. Your vehicle could go too fast for the conditions, and you could lose control. An accident could be the result. Don't use Speed Control in heavy traffic or on roads that are winding, icy, snow-covered, or slippery.**

**To Accelerate For Passing:**

Depress the accelerator as you would normally. When the pedal is released, the vehicle will return to the set speed.

**Using Speed Control On Hills**

**NOTE:** The speed control system maintains speed up and down hills. A slight speed change on moderate hills is normal.

Vehicles equipped with four speed automatic transaxles may experience a downshift to 3rd gear while climbing uphill or descending downhill. This downshift to 3rd gear is necessary to maintain vehicle set speed.

On steep hills a greater speed loss or gain may occur so it may be preferable to drive without speed control.

**OVERHEAD CONSOLE — IF EQUIPPED**

This feature has a compass/temperature display and two map lamps. The overhead console is located on the headliner between the sun visors.

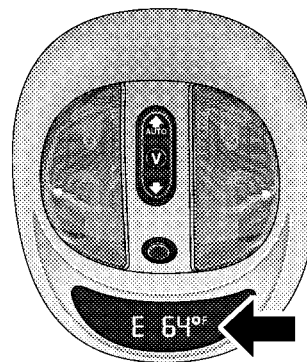

808cd7b9



**Compass/Temperature Display**

This display provides the outside temperature and one of eight compass readings to indicate the direction the vehicle is facing.

**WARNING!**

Even if the display still reads a few degrees above 32°F ( 0°C), the road surface may be icy, particularly in woods or on bridges. Drive carefully under such conditions to prevent an accident and possible personal injury or property damage.

STEP Button Functions:

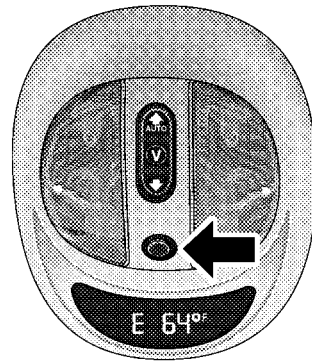

1. US
2. Metric
3. Off
4. Magnetic Zone Selection
5. Manual Compass Calibration

80cab076

### Automatic Compass Calibration

The automatic calibrating feature of the compass eliminates the need to calibrate the compass due to normal varying conditions.

### Compass Variance Selection

Variance is the difference between magnetic North and geographic North. For proper compass function, the correct variance zone must be set. Refer to the variance map for the correct variance zone. To check the variance zone, the ignition switch must be on and the compass/temperature displayed. Press and hold the STEP button for about 5 to 10 seconds until ZONE and the number appears in the display. The number displayed is the variance zone used by the compass. To change the zone, press the STEP button to scroll through numbers 1 through 15.

When the correct variance is selected release the step button and the Compass/Temperature display will return to normal after approximately 15 seconds.

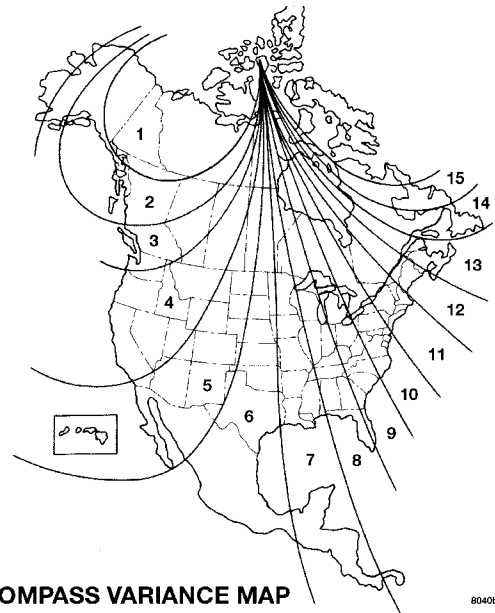

COMPASS VARIANCE MAP

80406197

**Manual Compass Calibration**

If the compass appears erratic, inaccurate, abnormal or the vehicle is new, you may calibrate the compass. Prior to calibrating the compass make sure the proper zone is selected. Refer to “Magnetic Zone Selection”. Find an open area away from large metal objects. With the vehicle running, press and hold the STEP button for (about 10 to 15 seconds). The display will illuminate the CAL indicator. Drive slowly (about 5 mph) in 3 complete 360 circles. The CAL indicator will turn off and the compass will be calibrated.

**NOTE:**

- The compass needs to go through a manual calibration to insure proper operation when taking vehicle delivery.

- The STEP button must be pressed for 10 to 15 seconds to place the compass into CAL mode. Regardless of whether the CAL indicator is already illuminated.

**Outside Temperature**

Because engine temperature can increase the displayed temperature, temperature readings are not updated when the vehicle is not moving.

If the display shows  $-49^{\circ}\text{F}$  ( $-45^{\circ}\text{C}$ ) or  $140^{\circ}\text{F}$  ( $60^{\circ}\text{C}$ ), see your authorized dealer for repair.

### POWER SUNROOF — IF EQUIPPED

The power sunroof control is located between the sun visors on the overhead console.

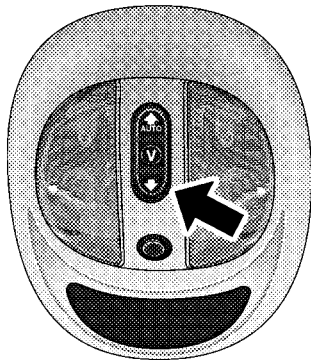

80cb2a4

Press and hold the switch rearward to fully open the sunroof. The sunroof can be stopped at any position between closed and full open. Momentarily pressing the switch rearward will activate the Express Open Feature, causing the sunroof to open automatically.

Press and hold the button in the center of the sunroof switch to open the vent. The sunroof can be stopped at any position between closed and full vent. To close the sunroof from the vent position, press and hold the switch forward. Releasing the switch will stop the movement of the sunroof and the sunroof will remain in the partial vent position until the switch is pushed forward again.

### Express Open Feature

During the Express Open operation, any movement of the switch will stop the sunroof and it will remain in a partial open position. Again, momentarily pressing the switch rearward will activate the Express Open Feature.

To close the sunroof, hold the switch in the forward position. Again, any release of the switch will stop the movement and the sunroof will remain in a partial open condition until the switch is pushed forward again.

The sunshade can be opened manually. It will also open as the sunroof opens. The sunshade cannot be closed if the sunroof is open.

**WARNING!**

Never leave children in a vehicle, with the keys in the ignition switch. Occupants, particularly unattended children, can become entrapped by the power sunroof while operating the power sunroof switch. Such entrapment may result in serious injury or death.

**WARNING!**

In an accident, there is a greater risk of being thrown from a vehicle with an open sunroof. You could also be seriously injured or killed. Always fasten your seat belt properly and make sure all passengers are properly secured too.

Do not allow small children to operate the sunroof. Never allow fingers or other body parts, or any object to project through the sunroof opening. Injury may result.

3

**Wind Buffeting**

Wind buffeting can be described as the perception of pressure on the ears or a helicopter type sound in the ears. Your vehicle may exhibit wind buffeting with the windows down, or the sunroof (if equipped) in certain open or partially open positions. This is a normal occurrence and can be minimized. If the buffeting occurs with

the rear windows open, open the front and rear windows together to minimize the buffeting. If the buffeting occurs with the sunroof open, adjust the sunroof opening to minimize the buffeting or open any window.

#### **Sunroof Maintenance**

Use only a non-abrasive cleaner and a soft cloth to clean the glass panel.

#### **ELECTRICAL POWER OUTLETS**

The outlets include tethered caps, labeled with a key symbol or battery symbol, indicating power source. All outlets are protected by a single 20 Amp fuse.

The standard outlet in the front of the center floor console is a conventional cigar lighter outlet.

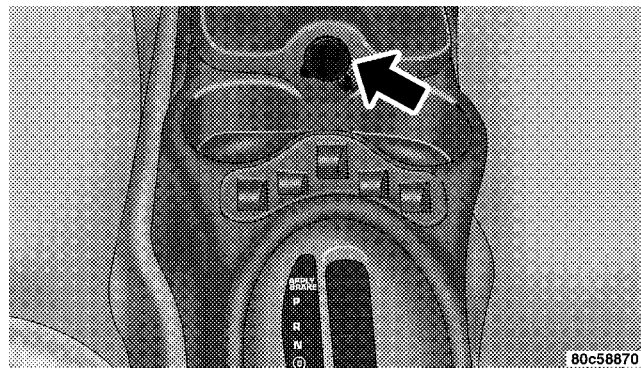

It will accept a cigar lighter unit, which is part of the optional Smokers Package. To preserve the heating element of the cigar lighter unit, do not hold the lighter in the heating position. As a child safety precaution, this outlet is powered by the ignition switch, only when the switch is in the "ON" or "ACCESSORY" positions.

There are two optional power outlets. One is in the Accessory Switch Bank, in the center of the instrument panel.

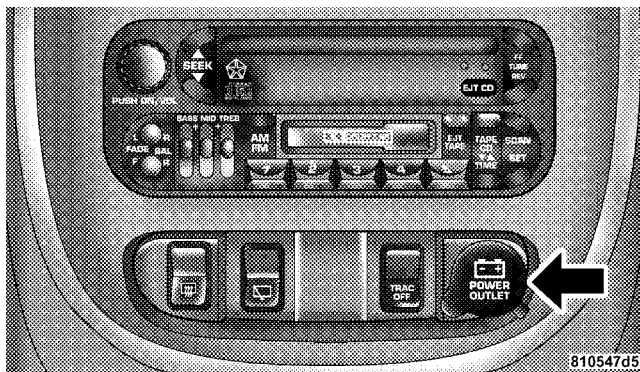

This outlet is powered directly by the battery, regardless of the ignition switch position. All accessories connected to this outlet should be removed or turned off when the vehicle is not in use, to protect the battery against discharge.

The second is in the right rear cargo area.

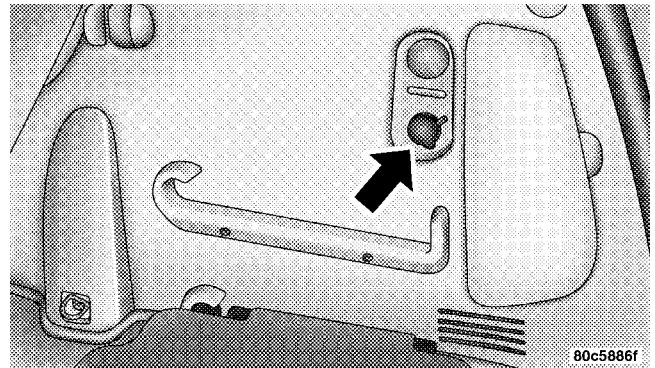

Since this outlet is remote from the driver, it is powered by the ignition switch, only when it is in the "ON" or "ACCESSORY" positions, to protect the battery against discharge. Note: Neither of the power outlets will accept a cigar lighter unit. They are intended only for accessory usage.

**Electrical Outlet Use With Engine Off****CAUTION!**

- **Many accessories that can be plugged in draw power from the vehicle's battery, even when not in use (i.e. cellular phones, etc.). Eventually, if plugged in long enough, the vehicle's battery will discharge sufficiently to degrade battery life and/or prevent engine starting.**
- **Accessories that draw higher power (i.e. coolers, vacuum cleaners, lights, etc.), will degrade the battery even more quickly. Only use these intermittently and with greater caution.**
- **After the use of high power draw accessories, or long periods of the vehicle not being started (with accessories still plugged in), the vehicle must be driven a sufficient length of time to allow the generator to recharge the vehicle's battery.**

**CONSOLE FEATURES**

The console has two front cup holders, a coin holder, 12 volt power outlet and a front storage tray. There are additional cup holders; one is molded in the center of the console to hold large cups and the other is at the rear of the console to serve passengers in the rear seat. The floor console power outlet will also operate a conventional cigar lighter unit (if equipped with an optional Smoker's Package).

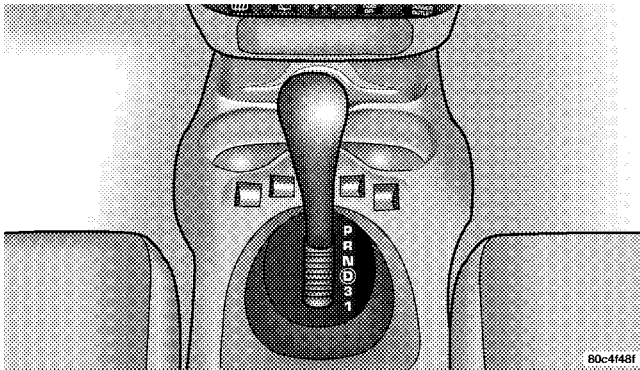

**CAUTION!**

- Many accessories that can be plugged into the 12 volt power outlet, draw power from the vehicle's battery, even when not in use; i.e. cellular phones, etc. Eventually, if plugged in long enough, the vehicle's battery will discharge sufficiently to degrade battery life and/or prevent engine starting.
- Accessories that draw higher power such as coolers, vacuum cleaners, lights, etc., will discharge the battery even more quickly. Only use these intermittently and with greater caution.
- After the use of high power draw accessories, or long periods of the vehicle not being started, (with accessories still plugged in), the vehicle must be driven a sufficient length of time to allow the generator to recharge the vehicle's battery.

## STORAGE

### Front Seat Storage Bin — If Equipped

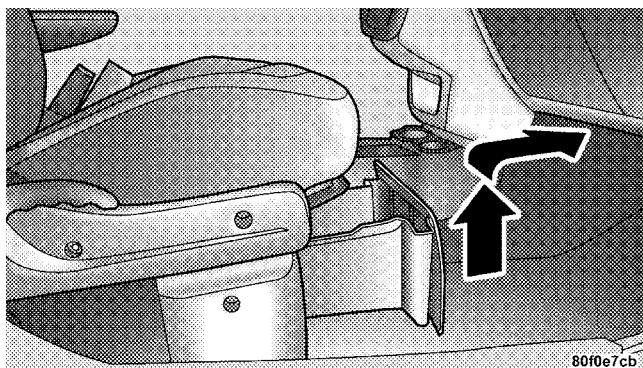

The storage bin is located under the front passenger's seat. To open **lift up on the handle** and pull the storage bin **forward**.

### Storage Pockets

There are also Storage pockets located on each door trim panel.

### REAR SHELF PANEL

The rear shelf panel attaches to guides in the rear cargo area. The rear shelf panel may be installed in one of five different positions.

**NOTE:** The liftgate may be opened or closed with the rear cargo shelf panel in position 1, position 2, position 3 or position 4.

**WARNING!**

- To avoid tipping, lock the shelf securely in all positions.
- Do not drive this vehicle with the liftgate open, or use the shelf as a seat.
- Failure to follow these warnings could result in serious or fatal injury.

**Position 1 (Top)**

Insert the front outboard corners of the shelf panel into the top guides and slide forward. Press down on the back of the shelf panel to lock it into place.

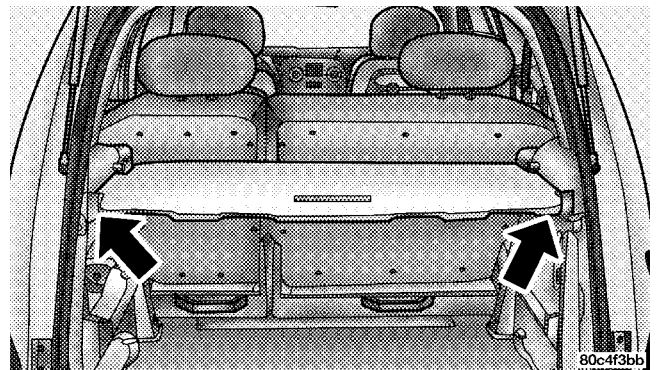
**WARNING!**

**Do not load objects on the shelf in position 1 (top). In an accident objects could strike occupants causing serious or fatal injury.**

**Position 2 (Middle)**

Insert the front outboard corners of the shelf panel into the middle guides and slide forward. Press down on the back of the shelf panel to lock it into place.

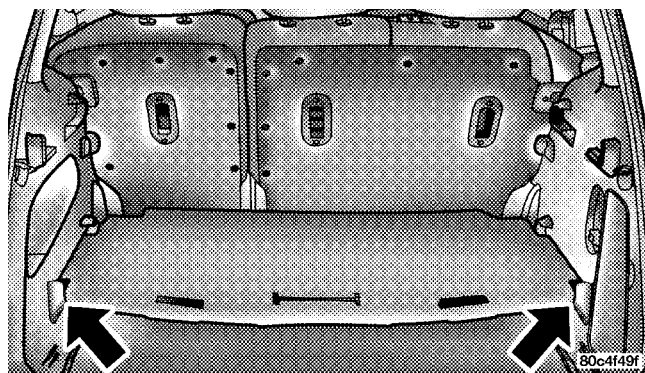

**WARNING!**

**Do not load objects over 100 lbs (45 kg) in position 2 (middle). Failure to follow this warning could cause the shelf to collapse resulting in personal injury.**

**Position 3 (Floor)**

Insert the front outboard corners of the shelf panel into the bottom guides and slide forward.

**NOTE:** To carry items that may soil the carpeting, the rear shelf panel may be inverted in position 2 or position 3.

**Position 4 (Vertical)**

Insert the front outboard corners of the shelf panel into the vertical guides behind the rear seatbacks near the floor and slide downward. Push the shelf panel forward to lock it into place.

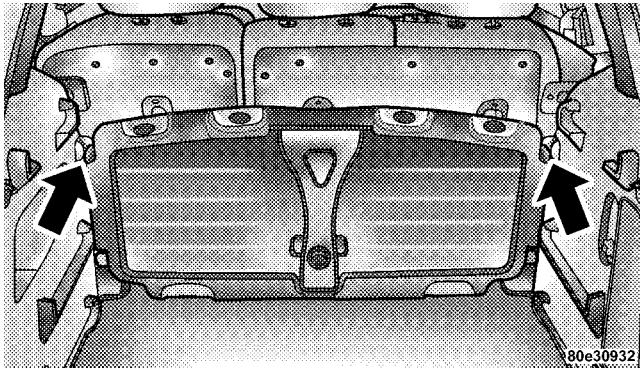
**WARNING!**

**When in the vertical position, the rear shelf panel should not be used as a barrier for large objects in the cargo area when the seatbacks folded down. In an accident objects could strike the seatbacks or occupants causing serious or fatal injury.**

3

**Position 5 (table)**

With the liftgate open the rear shelf panel can be moved rearward to act as a serving counter.

1. Install the front corners of the shelf panel into the top rear guides. Press down on the shelf panel to lock it into place.

2. Twist the knob on the underside of the panel and lower the shelf leg.

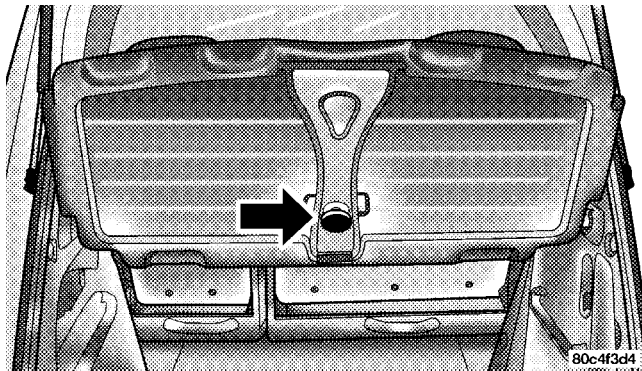

3. Install the shelf leg into the liftgate latch area as labeled on the rear scuff plate.

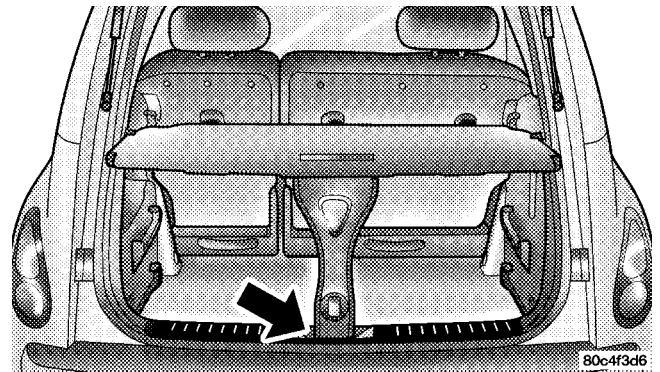

**WARNING!**

**Do not load objects over 100 lbs (45 kg) in position 5 (table). Failure to follow this warning could cause the shelf to collapse resulting in personal injury.**

**ROOF LUGGAGE RACK — IF EQUIPPED**

The crossbars and siderails are designed to carry the weight on vehicles equipped with a luggage rack. The load must not exceed 150 lbs (68 kg), and should be uniformly distributed over the luggage rack crossbars.

Use both adjustable crossbars assemblies to support the load and distribute the load as evenly as possible.

To adjust the crossbars with latch style releases, release the latches on the inboard side of the crossbar supports on each side of the vehicle, then move the crossbars to the desired position. Once the crossbar is in the desired position, return both latches to the locked position.

To adjust the crossbars with button style releases, depress the button and slide the crossbar to the next locking position. Alternate sides until the crossbars are positioned correctly for your cargo and the stanchions are locked square to the slide rails.

External racks do not increase the total load carrying capacity of the vehicle. Be sure that the total occupant and luggage load inside the vehicle, plus the load on the luggage rack, do not exceed the rated vehicle capacity.

**NOTE:** When the luggage rack is not in use, place the crossbars together at the rear of the vehicle. In this position they are designed to improve the vehicle aerodynamics and reduce wind noise.

**CAUTION!**

To avoid damage to the roof rack and vehicle, do not exceed the maximum roof rack load capacity of 150 lbs (68 kg). Always distribute heavy loads as evenly as possible and secure the load appropriately.

Long loads which extend over the windshield, such as wood panels or surfboards, should be secured to both the front and rear of the vehicle.

Travel at reduced speeds and turn corners carefully when carrying large or heavy loads on the roof rack. Wind forces, due to natural causes or nearby truck traffic, can add sudden upward loads. This is especially true on large flat loads and may result in damage to the cargo or your vehicle.

**WARNING!**

Cargo must be securely tied before driving your vehicle. Improperly secured loads can fly off the vehicle, particularly at high speeds, resulting in personal injury or property damage. Follow the roof rack "Cautions" when carrying cargo on your roof rack.



---

# UNDERSTANDING YOUR INSTRUMENT PANEL

## CONTENTS

---

■ Instrument Panel Features . . . . .	125	□ Two Types Of Signals . . . . .	136
■ Instrument Cluster . . . . .	126	□ Electrical Disturbances . . . . .	137
■ Instrument Cluster—Turbo, With AutoStick . . . . .	127	□ AM Reception . . . . .	137
■ Instrument Cluster—Turbo, Without AutoStick . . . . .	128	□ FM Reception . . . . .	137
■ Instrument Cluster Descriptions . . . . .	129	■ Sales Code RAZ—AM/ FM Stereo Radio With Cassette Tape Player, CD Player And CD Changer Controls — If Equipped . . . . .	138
■ Electronic Digital Clock . . . . .	136	□ Operating Instructions — Radio . . . . .	138
□ Clock Setting Procedure . . . . .	136	□ Power Switch, Volume Control . . . . .	138
■ Radio General Information . . . . .	136	□ Seek Button (Radio Mode) . . . . .	138
□ Radio Broadcast Signals . . . . .	136		

122 UNDERSTANDING YOUR INSTRUMENT PANEL

□ Tuning . . . . .	138	□ Tape Eject . . . . .	143
□ PTY (Program Type) Button . . . . .	139	□ Scan Button . . . . .	143
□ Balance . . . . .	140	□ Changing Tape Direction . . . . .	143
□ Fade . . . . .	140	□ Metal Tape Selection . . . . .	143
□ Tone Control . . . . .	140	□ Pinch Roller Release . . . . .	143
□ AM/FM Selection . . . . .	141	□ Noise Reduction . . . . .	143
□ Scan Button . . . . .	141	□ Operating Instructions — CD Player . . . . .	144
□ To Set The Radio Push-Button Memory . . . . .	141	□ Inserting The Compact Disc . . . . .	144
□ To Change From Clock To Radio Mode . . . . .	142	□ Seek Button . . . . .	145
□ Operating Instructions — Tape Player . . . . .	142	□ EJT CD (Eject) Button . . . . .	145
□ Seek Button . . . . .	142	□ FF/Tune/RW . . . . .	145
□ Fast Forward (FF) . . . . .	142	□ Program Button 4 (Random Play) . . . . .	145
□ Rewind (RW) . . . . .	142	□ Mode . . . . .	146

□ Tape CD Button . . . . .	146	□ Radio Operation . . . . .	154
□ Time Button . . . . .	146	□ CD Player Operation . . . . .	157
□ Scan Button . . . . .	146	■ Sales Code RB1—AM/FM Stereo Radio With DVD/GPS Navigation System . . . . .	161
□ CD Changer Control Capability — If Equipped . . . . .	146	■ Satellite Radio — If Equipped . . . . .	161
■ Sales Code RBK—AM/ FM Stereo Radio With CD Player And CD Changer Controls . . . . .	148	□ System Activation . . . . .	161
□ Radio Operation . . . . .	148	□ Electronic Serial Number/Sirius Identification Number (ENS/SID) . . . . .	162
□ CD Player Operation . . . . .	150	□ Selecting Satellite Mode In RBB And RBK Radios . . . . .	162
□ CD Changer Control Capability — If Equipped . . . . .	152	□ Selecting Satellite Mode In RBP, RBU, RAZ, And RBQ Radios . . . . .	162
□ Radio Display Messages . . . . .	154	□ Selecting a Channel . . . . .	163
■ Sales Code RBQ—AM/FM Stereo Radio With 6 - Disc CD Changer . . . . .	154	□ Storing And Selecting Pre-Set Channels . . . . .	163

124 UNDERSTANDING YOUR INSTRUMENT PANEL

□ Using The PTY (Program Type) Button (If Equipped) . . . . .	164	■ Climate Controls . . . . .	166
□ PTY Button "Scan" . . . . .	164	□ Air Conditioning . . . . .	166
□ PTY Button "Seek" . . . . .	164	□ Operating Tips . . . . .	171
□ Satellite Antenna . . . . .	164	■ Rear Window Features . . . . .	173
□ Reception Quality . . . . .	164	□ Electric Rear Window Defroster . . . . .	173
■ Cassette Tape And Player Maintenance . . . . .	165	□ Rear Wiper/Washer Switch . . . . .	174
■ CD/DVD Disc Maintenance . . . . .	166	□ Adding Washer Fluid . . . . .	175
■ Radio Operation And Cellular Phones . . . . .	166		

**INSTRUMENT PANEL FEATURES**

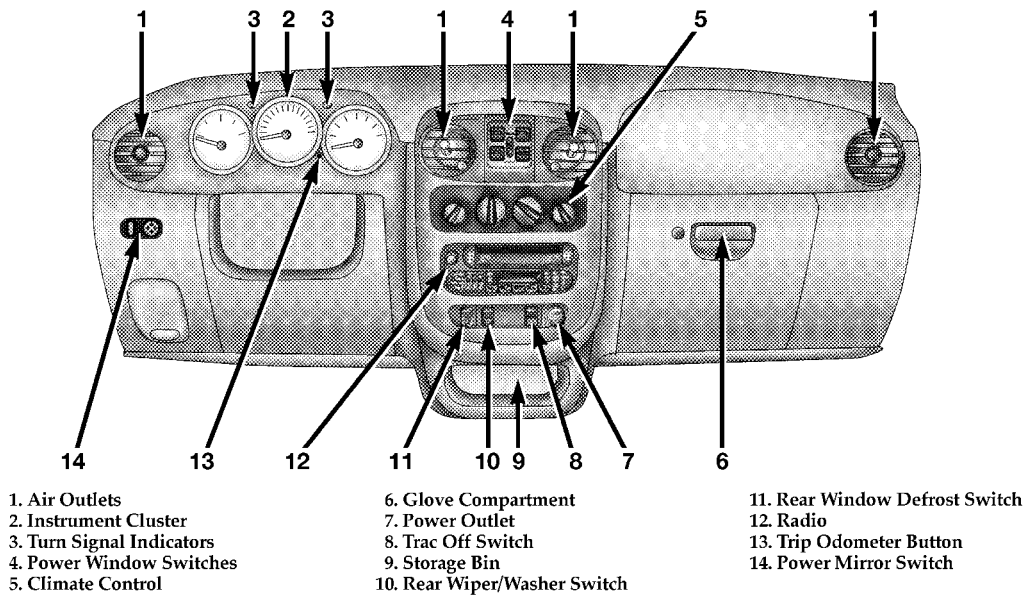

80ca52a0

**INSTRUMENT CLUSTER**

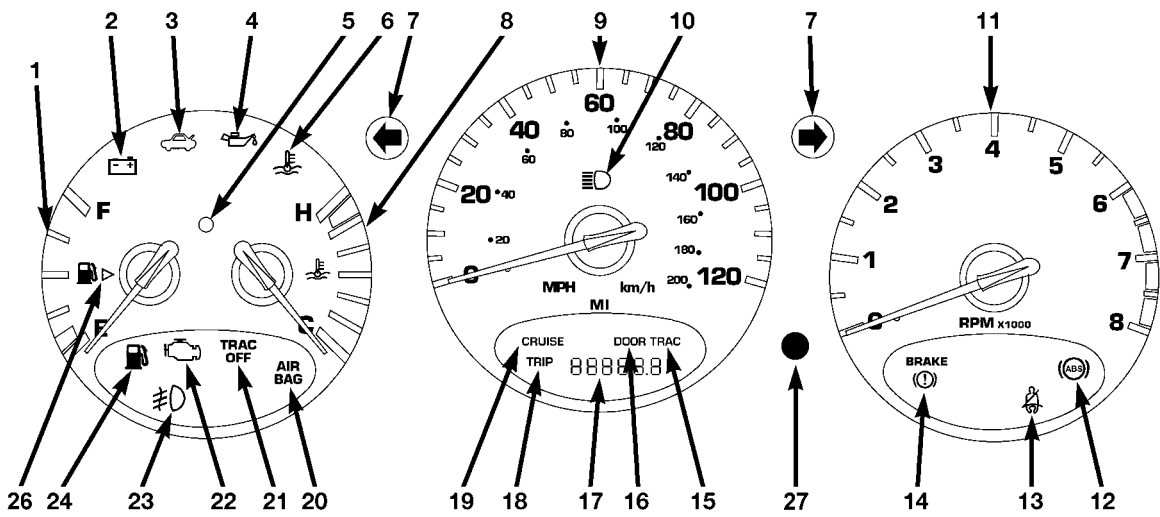

810a4d41

**INSTRUMENT CLUSTER—TURBO, WITH AUTOSTICK**

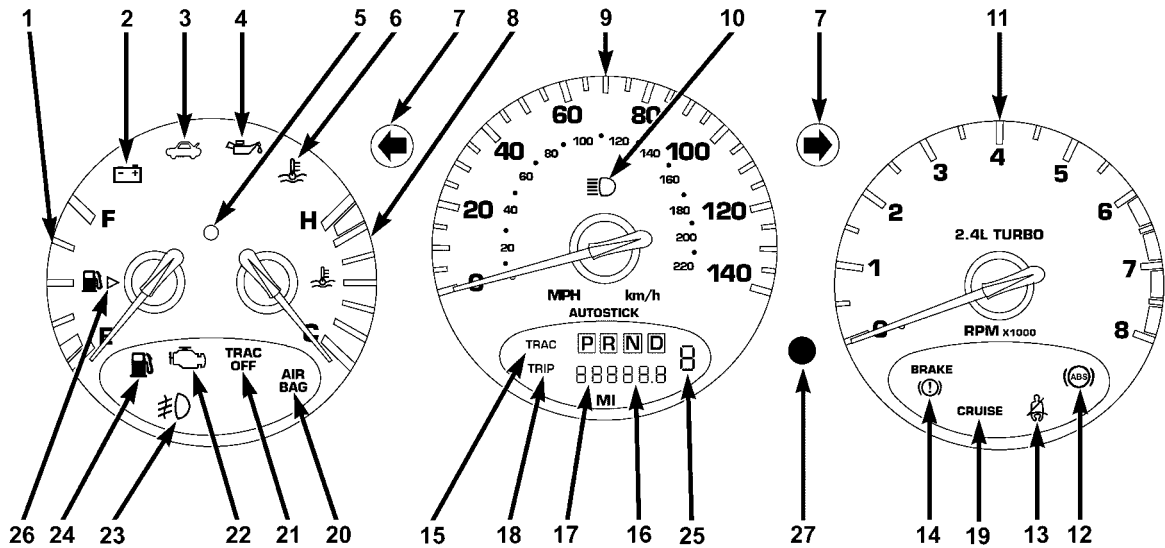

810a4d5d

**INSTRUMENT CLUSTER—TURBO, WITHOUT AUTOSTICK**

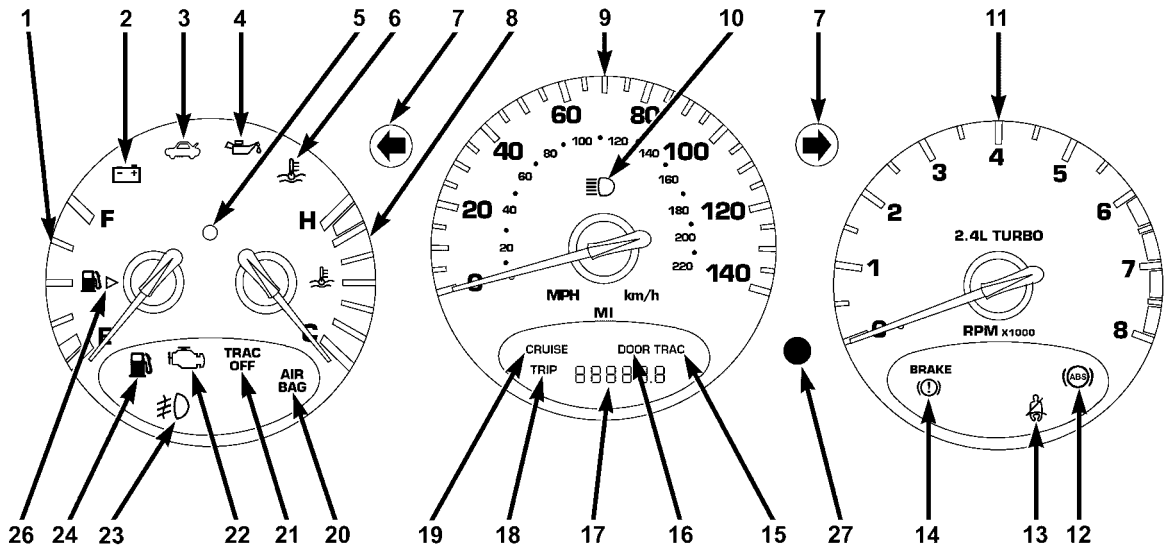

810a4d89



## INSTRUMENT CLUSTER DESCRIPTIONS

### 1. Fuel Gauge



When the ignition switch is in the ON position, the pointer will show the level of fuel remaining in the fuel tank.

### 2. Charging System Light



This light shows the status of the electrical charging system. The light should come on briefly when the ignition is first turned ON and remain on briefly as a bulb check. If the light stays on or comes on while driving, it means that there is a problem with the charging system. Obtain SERVICE IMMEDIATELY.

### 3. Liftgate Ajar



This light comes on if the liftgate is not completely closed.

### 4. Oil Pressure Light



Shows low engine oil pressure. The light will come on and remain on when the ignition switch is turned from the OFF to the ON position, and the light will turn off after the engine is started. If the bulb does not come on during starting, have the system checked by an authorized dealer.

If the light comes on and remains on while driving, stop the vehicle and shut off the engine. **DO NOT OPERATE THE VEHICLE UNTIL THE CAUSE IS CORRECTED.**

The light does not show the quantity of oil in the engine. This can be determined using the procedure shown in Section 7.

### 5. Theft Alarm Light — If Equipped

This light will flash rapidly for several seconds when the alarm system is arming. The light will begin to flash slowly indicating that the system is armed.

### 6. Engine Temperature Warning Light



This light warns of an overheated engine condition. If the engine is critically hot, a warning chime will sound 10 times. After the chime turns off, the engine will still be critically hot until the light goes out.

### 7. Turn Signal Indicators



The arrows will flash in unison with the exterior turn signal, when using the turn signal lever.

**NOTE:** Turn signal bulbs are located in the Instrument Panel.

### 8. Temperature Gauge



The temperature gauge shows engine coolant temperature. Any reading below the red area of the gauge shows that the engine cooling system is operating properly. The gauge pointer may show a higher than normal temperature when driving in hot weather, up mountain grades, in heavy stop and go traffic, or when towing a trailer.

If the pointer rises to the **H** (red) mark, the instrument cluster will sound a chime. Pull over and stop the vehicle. Idle the vehicle with the air conditioner turned off until the pointer drops back into the normal range. If the pointer remains on the **H** (red) mark, turn the engine off immediately and call for service.

There are steps that you can take to slow down an impending overheating condition. If your air conditioning is on, turn it off. The air conditioning system adds heat to the engine cooling system and turning off the A/C removes this heat. You can also turn the Temperature control to maximum heat, the Mode control to Floor and the Fan control to High. This allows the heater core to act as a supplement to the radiator and aids in removing heat from the engine cooling system.

### 9. Speedometer

Indicates vehicle speed.

**10. High Beam Indicator**

 This light shows that the headlights are on high beam. Pull the turn signal lever toward the steering wheel to switch the headlights from high or low beam.

**11. Tachometer**

The white area of the scale shows the permissible engine revolutions-per-minute (rpm x 1000) for each gear range. Before reaching the red area, ease up on the accelerator to prevent engine damage.

**12. Anti-Lock Warning Light (ABS) — If Equipped**

 This light monitors the Anti-Lock Brake System (ABS) described elsewhere in this manual. This light will come on when the ignition key is turned to the ON position and may stay on for as long as four seconds.

If the ABS light remains on or comes on during driving, it indicates that the Anti-Lock portion of the brake system

is not functioning and that service is required, however, the conventional brake system will continue to operate normally provided that the BRAKE warning light is not on.

If the ABS light is on, the brake system should be serviced as soon as possible to restore the benefit of Anti-Lock Brakes.

The warning light should be checked frequently to assure that it is operating properly. Turn the ignition key to the on position, but do not start the vehicle. The light should come on. If the light does not come on, have the system checked by an authorized dealer.

**13. Seat Belt Reminder Light**

 When the ignition switch is first turned ON, this light will come on for about six seconds. A chime will sound if you have not pulled the shoulder belt out of the retractor. This is a reminder to "buckle up". If you do not buckle up, the light will remain on.

**14. Brake System Warning Light**

**BRAKE**  
 This light monitors various brake functions, including brake fluid level and parking brake application. If the brake light comes on, it may indicate that the parking brake is applied, or there is a low brake fluid level. On vehicles equipped with Anti-lock brakes (ABS), it may also indicate an ABS malfunction that could lead to reduced braking performance.

**WARNING!**

**Driving a vehicle with the brake light on is dangerous. A significant decrease in braking performance or vehicle stability during braking may occur. It will take you longer to stop the vehicle or will make your vehicle harder to control. You could have an accident. Have the vehicle checked immediately.**

The operation of the Brake Warning light can be checked by turning the ignition key from the OFF to the ON position. The light should illuminate for three seconds, or until the engine is started, whichever comes first. The light should then go out unless the parking brake is applied or a brake fault is detected. If the light does not illuminate, have the light inspected and serviced as soon as possible.

The light will also come on when the parking brake is applied with the ignition switch in the ON position.

**NOTE:** This light shows only that the parking brake is applied. It does not show the degree of brake application.

If the parking brake is off and the light remains on, have the brake system inspected as soon as possible.

**15. Trac Indicator — If Equipped**

The TRAC Light will come on momentarily as a bulb check when the ignition switch is first turned ON.

The light will flash when the Traction Control System is controlling traction.

#### **16. Door Ajar Indicator**

This vacuum fluorescent display indicator illuminates the word "DOOR", when a door is not completely closed. If the door is open for more than 8 minutes, the light will turn off.

#### **17. Odometer/Trip Odometer**

The odometer shows the total distance the vehicle has been driven. The trip odometer shows the trip distance since the last reset.

U.S. Federal regulations require that upon transfer of vehicle ownership, the seller certify to the purchaser the correct mileage that the vehicle has been driven. Therefore, if the odometer reading changes during repair or replacement, be sure to keep a record of the reading before and after the service so the correct mileage can be determined.

#### **18. Trip Indicator**

This vacuum fluorescent display indicator will illuminate when the Trip Odometer is in use.

By pushing the trip button, located next to the instrument cluster, the odometer will toggle between total distance and trip distance. In the trip odometer mode, holding the trip button for more than 2 seconds will reset the trip odometer to "0".

#### **19. Cruise Indicator — If Equipped**

**CRUISE** This indicator shows that the Speed Control System is ON.

**NOTE:** The word "SET" **will not** illuminate when the Speed Control System is on.

**20. Airbag Light**

**AIR BAG** The light comes on and remains on for 6 to 8 seconds as a bulb check when the ignition switch is first turned ON. If the light does not come on during starting, stays on, or comes on while driving, have the system checked by an authorized dealer.

**21. Trac Off Light — If Equipped**

The TRAC OFF light will illuminate momentarily as a bulb check when the ignition switch is first turned ON. If the light does not come on, have the system checked.

The light will also come on if:

- The Traction Control switch has been used to turn the system off,
- There is an anti-lock system failure,
- There is a Traction Control system failure,

- The system has been automatically deactivated to prevent damage to the brake system due to overheated brake temperatures.

**NOTE:** Extended heavy use of Traction Control may cause the system to deactivate and turn on the TRAC OFF Light. This is to prevent overheating of the brake system and is a normal condition. The system will remain disabled for about 4 minutes until the brakes have cooled. The system will automatically reactivate and turn off the TRAC OFF Light.

**22. Malfunction Indicator Light**

This light is part of an onboard diagnostic system called OBD that monitors emissions, engine, and automatic transmission control systems. The light will illuminate when the key is in the ON/RUN position before engine start. If the bulb does not come on when turning the key from OFF to ON/RUN, have the condition checked promptly.

Certain conditions such as a loose or missing gas cap, poor fuel quality, etc. may illuminate the light after engine start. The vehicle should be serviced if the light stays on through several of your typical driving cycles. In most situations the vehicle will drive normally and will not require towing.

If the Malfunction Indicator Light flashes when the engine is running, serious conditions may exist that could lead to immediate loss of power or severe catalytic converter damage. The vehicle should be serviced as soon as possible if this occurs.

**23. Front Fog Light Indicator — If Equipped**

 This light shows when the front fog lights are ON.

**24. Low Fuel Light**

 When the fuel level drops to about 1/8 tank, the fuel symbol will light and a single chime will sound. The light will remain on until fuel is added.

If the fuel level drops to approximately 1.0 gallon (3.75 Liter), the fuel symbol will flash several times and the chime will sound several times.

**25. AutoStick Gear Position— If Equipped**

This vacuum fluorescent display indicator illuminates when the gearshift lever is moved to the AutoStick position and shows the current gear selection.

**26. Fuel Door Reminder**

This symbol is a reminder that the Fuel Filler Door is located on the front passenger's (right) side of the vehicle.

**27. Odometer/Trip Odometer Reset Knob**

Press the knob to switch between the odometer and trip odometer. While the trip odometer is being displayed, press and hold this knob for a few seconds to reset the trip odometer to zero miles/kilometers.

### ELECTRONIC DIGITAL CLOCK

The clock and radio each use the display panel built into the radio. A digital readout shows the time in hours and minutes whenever the ignition switch is in the ON or ACC position and the time button is pressed.

When the ignition switch is in the OFF position, or when the radio frequency is being displayed, time keeping is accurately maintained.

#### Clock Setting Procedure

1. Turn the ignition switch to the ON or ACC position and press the time button. Using the tip of a ballpoint pen or similar object, press either the hour (H) or minute (M) buttons on the radio.
2. Press the H button to set hours or the M button to set minutes. The time setting will increase each time you press a button.

### RADIO GENERAL INFORMATION

#### Radio Broadcast Signals

Your new radio will provide excellent reception under most operating conditions. Like any system, however, car radios have performance limitations, due to mobile operation and natural phenomena, which might lead you to believe your sound system is malfunctioning. To help you understand and save you concern about these “apparent” malfunctions, you must understand a point or two about the transmission and reception of radio signals.

#### Two Types of Signals

There are two basic types of radio signals... AM or Amplitude Modulation, in which the transmitted sound causes the amplitude, or height, of the radio waves to vary... and FM or Frequency Modulation, in which the frequency of the wave is varied to carry the sound.



**Electrical Disturbances**

Radio waves may pick up electrical disturbances during transmission. They mainly affect the wave amplitude, and thus remain a part of the AM reception. They interfere very little with the frequency variations that carry the FM signal.

**AM Reception**

AM sound is based on wave amplitude, so AM reception can be disrupted by such things as lightning, power lines and neon signs.

**FM Reception**

Because FM transmission is based on frequency variations, interference that consists of amplitude variations can be filtered out, leaving the reception relatively clear, which is the major feature of FM radio.

**NOTE:** On vehicles so equipped the radio, steering wheel radio controls and 6 disc CD/DVD changer if equipped, will remain active for up to 45 seconds after the ignition switch has been turned off. Opening a vehicle front door will cancel this feature.

### SALES CODE RAZ—AM/ FM STEREO RADIO WITH CASSETTE TAPE PLAYER, CD PLAYER AND CD CHANGER CONTROLS — IF EQUIPPED

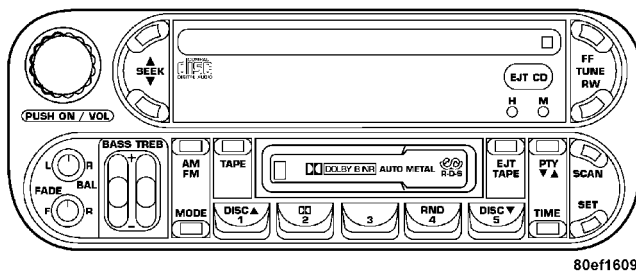

#### Operating Instructions — Radio

**NOTE:** Power to operate the radio is controlled by the ignition switch. It must be in the ON or ACC position to operate the radio.

#### Power Switch, Volume Control

Press the ON/VOL control to turn the radio on. Turn the volume control clockwise to increase the volume. The volume will be displayed and continuously updated while the button is pressed.

#### Seek Button (Radio Mode)

Press and release the Seek button to search for the next station in either the AM or FM mode. Press the top of the button to seek up and the bottom to seek down. Holding the button will pass stations until you release the button.

#### Tuning

Press the TUNE control up or down to increase or decrease the frequency. If you press and hold the button, the radio will continue to tune until you release the button. The frequency will be displayed and continuously updated while the button is pressed.

**PTY (Program Type) Button**

Pressing this button once will turn on the PTY mode for 5 seconds. If no action is taken during the 5 second time out the PTY icon will turn off. Pressing the PTY button within 5 seconds will allow the program format type to be selected. Many radio stations do not currently broadcast PTY information.

Toggle the PTY button to select the following format types:

<b>Program Type</b>	<b>Radio Display</b>
Adult Hits	Adlt Hit
Classical	Classicl
Classic Rock	Cls Rock
College	College
Country	Country
Information	Inform
Jazz	Jazz
Foreign Language	Language

<b>Program Type</b>	<b>Radio Display</b>
News	News
Nostalgia	Nostalga
Oldies	Oldies
Personality	Persnlty
Public	Public
Rhythm and Blues	R & B
Religious Music	Rel Musc
Religious Talk	Rel Talk
Rock	Rock
Soft	Soft
Soft Rock	Soft Rck
Soft Rhythm and Blues	Soft R&B
Sports	Sports
Talk	Talk
Top 40	Top 40
Weather	Weather

By pressing the SEEK button when the PTY icon is displayed, the radio will be tuned to the next frequency station with the same selected PTY name. The PTY function only operates when in the FM mode.

The radio display will flash "SEEK" and the selected PTY program type when searching for the next PTY station. If no station is found with the selected PTY program type, the radio will return to the last preset station.

If a preset button is activated while in the PTY (Program Type) mode, the PTY mode will be exited and the radio will tune to the preset station.

Pressing PTY, then SCAN will scan the FM Band and stop at all RDS stations. Each RDS station will be played for a 5 second scan once around the FM Band and stop at the last station. The PTY icon will then turn off.

### **Balance**

The Balance control adjusts the left-to-right speaker balance. Push in the button and it will pop out. Adjust the balance and push the button back in. The balance will be displayed and continuously updated while the button is turned.

### **Fade**

The Fade control provides for balance between the front and rear speakers. Push in the button and it will pop out. Adjust the balance and push the button back in. The fade will be displayed and continuously updated while the button is turned.

### **Tone Control**

Slide the Bass and/or Treble controls up or down to adjust the sound for the desired tone. The treble, and bass will be displayed and continuously updated while the slide is moved.

**AM/FM Selection**

Press the AM/FM button to change from AM to FM. The operating mode will be displayed next to the station frequency. The display will show ST when a stereo station is received.

**Scan Button**

Pressing the SCAN button causes the tuner to search for the next station, in either AM or FM, pausing for 5 seconds at each listenable station before continuing to the next.

Pressing the AM/FM button continues the search in the alternate frequency band.

To stop the search, press SCAN a second time.

**To Set The Radio Push-button Memory**

When you are receiving a station that you wish to commit to push-button memory, press the SET button. SET 1 will show in the display window. Select the push-button you wish to lock onto this station and press and release that button. If a station is not selected within 5 seconds after pressing the SET button, the station will continue to play but will not be locked into push-button memory.

You may add a second station to each push-button by repeating the above procedure with this exception: Press the SET button twice and SET 2 will show in the display window. Each button can be set for SET 1 and SET 2 in both AM and FM. This allows a total of 10 AM and 10 FM stations to be locked into memory. You can recall the stations stored in SET 2 memory by pressing the push-button twice.

**To Change From Clock To Radio Mode**

Press the Time button to change the display between radio frequency and time.

**Operating Instructions — Tape Player**

Insert the cassette with the exposed tape side toward the right and the mechanical action of the player will gently pull the cassette into the play position.

**NOTE:** When subjected to extremely cold temperatures, the tape mechanism may require a few minutes to warm up for proper operation. Sometimes poor playback may be experienced due to a defective cassette tape. Clean and demagnetize the tape heads at least twice a year.

**Seek Button**

Press the SEEK button up for the next selection on the tape and down to return to the beginning of the current selection.

Press the SEEK button up or down to move the track number to skip forward or backward 1 to 6 selections. Press the SEEK button once to move 1 selection, twice to move 2 selections, etc.

**Fast Forward (FF)**

Press the FF button up momentarily to advance the tape in the direction that it is playing. The tape will advance until the button is pressed again or the end of the tape is reached. At the end of the tape, the tape will play in the opposite direction.

**Rewind (RW)**

Press the RW button momentarily to reverse the tape direction. The tape will reverse until the button is pressed again or until the end of the tape is reached. At the end of the tape, the tape will play in the opposite direction.

**Tape Eject**

Press the EJT Tape button and the cassette will disengage and eject from the radio.

**Scan Button**

Press this button to play 10 seconds of each selection. Press the scan button a second time to cancel the feature.

**Changing Tape Direction**

If you wish to change the direction of tape travel (side being played), press the PTY button. The lighted arrow in the display window will show the new direction.

**Metal Tape Selection**

If a standard metal tape is inserted into the player, the player will automatically select the correct equalization and the 70 symbol will appear in the display window.

**Pinch Roller Release**

If ignition power or the radio ON/OFF switch are turned off, the pinch roller will automatically retract to protect the tape from any damage. When power is restored to the tape player, the pinch roller will automatically reengage and the tape will resume play.

**Noise Reduction**

The Dolby Noise Reduction System\* is on whenever the tape player is on, but may be switched off.

To turn off the Dolby Noise reduction System: Press the Dolby button (button 2) after you insert the tape. The NR light in the display will go off when the Dolby System is off. The Dolby System is automatically reactivated each time a tape is inserted.

\* "Dolby" noise reduction manufactured under license from Dolby Laboratories Licensing Corporation. Dolby and the double-D symbol are trademarks of Dolby Laboratories Licensing Corporation.

**Operating Instructions — CD Player**

**NOTE:** The ignition switch must be in the ON or ACC position and the volume control ON before the CD player will operate.

**CAUTION!**

**This CD player will accept 4 ¾ inch (12 cm) discs only. The use of other sized discs may damage the CD player mechanism.**

**Inserting The Compact Disc**

The CD player contained within the radio is not a multi-disc changer, and will only accept one CD. Gently insert one CD into the CD player with the CD label facing up. The CD will automatically be pulled into the CD Player.

If the volume control is ON, the unit will switch from radio to CD mode and begin to play. The display will show the track number and index time in minutes and seconds. Play will begin at the start of track one.

**NOTE:**

- You may eject a disc with the radio OFF. The ignition switch must be in the ON or ACC position to insert a disc with the radio OFF.
- If you insert a disc with the ignition ON and the radio OFF, the CD will automatically be pulled into the CD Player and the display will show the time of day. If you insert a disc with the ignition OFF, the display will show the time of day for about 5 seconds, then go out.



**Seek Button**

Press the top of the SEEK button for the next selection on the CD. Press the bottom of the button to return to the beginning of the current selection, or return to the beginning of the previous selection if the CD is within the first 10 seconds of the current selection.

**EJT CD (Eject) Button**

Press this button and the disc will unload and move to the entrance for easy removal. The unit will switch to the radio mode.

If you do not remove the disc within 15 seconds, it will be reloaded. The radio mode will continue to appear.

The disc can be ejected with the radio OFF.

**FF/TUNE/RW**

Press FF (Fast Forward) and the CD player will begin to fast forward until FF is released. The RW (Reverse) button works in a similar manner.

**Program Button 4 (Random Play)**

Press this button while the CD is playing to activate Random Play. This feature plays the tracks on the selected disc in random order to provide an interesting change of pace.

Press the SEEK button to move to the next randomly selected track.

Press TUNE FF to fast forward through the tracks. Press the FF button a second time to stop the fast forward feature. If TUNE RW is pressed, the current track will reverse to the beginning of the track and begin playing.

Press button 4 a second time to stop Random Play.

**MODE**

Press the MODE button to select between the tape player, CD player, or satellite radio (if equipped).

To select Satellite Radio (if equipped), press the MODE button until the word SIRIUS appears. The following will be displayed in this order: After three seconds, the current channel name and number will be displayed for five seconds. The current program type and channel number will then be displayed for five seconds. The current channel name and number will then be displayed until an action occurs. A CD or tape may remain in the player while in the Satellite Radio mode.

**Tape CD Button**

Press this button to select between CD player and Tape player.

**Time Button**

Press this button to change the display from elapsed CD playing time to time of day.

**Scan Button**

Press this button to play the first 10 seconds of each track. To stop the scan function, press the button a second time.

**CD Changer Control Capability — If Equipped**

This radio is compatible with a remote mounted CD changer available through Mopar Accessories. The following instructions are for the radio controls that operate this CD changer.

**Mode Button**

To activate the CD changer, press the MODE button until CD information appears on the display.

**Push-Button**

While the CD changer is playing, press the NUMBER 1 push-button or the NUMBER 5 push-button to select a disc numbered higher or lower than the one currently being played.

**Seek Button**

Press the SEEK up or down to select another track on the same disc. A SEEK symbol will appear on the display.

**Fast Forward And Rewind Buttons**

Press and hold the FF button for fast forward. Press and hold the RW button for fast reverse.

The audio output can be heard when fast forward and fast reverse are activated.

**Random Play (RND)**

Press the Random button to play the tracks on the selected disc in random order for an interesting change of pace.

Random can be cancelled by pressing the button a second time or by ejecting the CD from the changer.

**CD Diagnostic Indicators**

When driving over a very rough road, the CD player may skip momentarily. Skipping will not damage the disc or the player, and play will resume automatically.

As a safeguard and to protect your CD player, one of the following warning symbols may appear on your display.

A CD HOT symbol indicates the player is too hot.

CD HOT will pause the operation. Play can be resumed when the operating temperature is corrected or another MODE is selected.

An ERR symbol will appear on the display if the laser is unable to read the Disc data for the following reasons:

- Excessive vibration
- Disc inserted upside down
- Damaged disc
- Water condensation on optics

### SALES CODE RBK—AM/ FM STEREO RADIO WITH CD PLAYER AND CD CHANGER CONTROLS

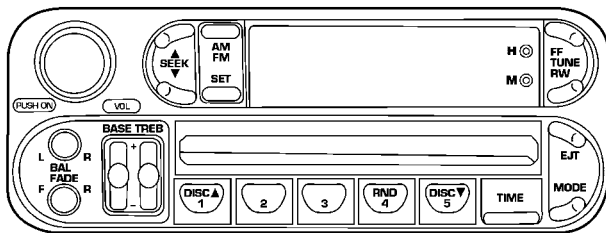

80e571f6

### Radio Operation

#### Power/Volume Control

Press the ON/VOL control to turn the radio on. Turn the volume control clockwise to increase the volume.

**NOTE:** Power to operate the radio is supplied through the ignition switch. It must be in the ON or ACC position to operate the radio.

#### Seek

Press and release the SEEK button to search for the next station in either the AM or FM mode. Press the top of the button to seek up and the bottom to seek down. The radio will remain tuned to the new station until you make another selection. Holding the button in will bypass stations without stopping until you release it.

**Tune**

Press the TUNE control up or down to increase or decrease the frequency. If you press and hold the button, the radio will continue to tune until you release the button. The frequency will be displayed and continuously updated while the button is pressed.

**Balance**

The Balance control adjusts the left-to-right speaker balance. Press the BAL button in and it will pop out. Adjust the balance and push the button back in.

**Fade**

The Fade control provides for balance between the front and rear speakers. Press the FADE button in and it will pop out. Adjust the balance and push the button back in.

**Bass and Treble Tone Control**

The tone controls consist of 2 separate bands. The bass band is on the left, and the treble band is on the right. Each band is adjusted by a slider control with a detent at

the mid-position. Moving the control up or down increases or decreases amplification of that band. The mid position provides a balanced output.

**AM/FM Selection**

Press the AM/FM button to change from AM to FM. The operating mode will be displayed next to the station frequency. The display will show ST when a stereo station is received.

**To Set The Radio Push-Button Memory**

When you are receiving a station that you wish to commit to push-button memory, press the SET button. SET 1 will show in the display window. Select the "1-5" button you wish to lock onto this station and press and release that button. If a button is not selected within 5 seconds after pressing the SET button, the station will continue to play but will not be locked into push-button memory.

You may add a second station to each push-button by repeating the above procedure with this exception: Press the SET button twice and SET 2 will show in the display window. Each button can be set for SET 1 and SET 2 in both AM and FM. This allows a total of 10 AM and 10 FM stations to be locked into push-button memory. The stations stored in SET 2 memory can be selected by pressing the push-button twice. Every time a preset button is used a corresponding button number will be displayed.

**Time**

Press the TIME button to change the display between radio frequency and time.

**General Information**

This radio complies with Part 15 of FCC rules and with RSS-210 of Industry Canada. Operation is subject to the following conditions:

1. This device may not cause harmful interference,
2. This device must accept any interference received, including interference that may cause undesired operation.

**NOTE:** Changes or modifications not expressly approved by the party responsible for compliance could void the user's authority to operate the equipment.

**CD Player Operation**

**NOTE:** The ignition switch must be in the ON or ACC position and the volume control ON before the CD player will operate.

### Inserting The Compact Disc

#### CAUTION!

**This CD player will accept 4 ¾ inch (12 cm) discs only. The use of other sized discs may damage the CD player mechanism.**

You may either insert or eject a disc with the radio OFF.

If you insert a disc with the ignition ON and the radio OFF, the display will show the time of day.

If the power is ON, the unit will switch from radio to CD mode and begin to play when you insert the disc. The display will show the track number and index time in minutes and seconds. Play will begin at the start of track one.

#### Seek

Press the top of the SEEK button for the next selection on the CD. Press the bottom of the button to return to the beginning of the current selection, or return to the beginning of the previous selection if the CD is within the first second of the current selection.

#### EJT — Eject

Press the EJT button and the disc will unload and move to the entrance for easy removal. The unit will switch to the radio mode.

If you do not remove the disc within 15 seconds, it will be reloaded. The unit will continue in radio mode.

The disc can be ejected with the radio and ignition OFF.

#### FF/TUNE/RW

Press FF (Fast Forward) and the CD player will begin to fast forward until FF is released. The RW ( Reverse) button works in a similar manner.

**Random Play — RND/Program Button 4**

Press the RND (button 4) button while the CD is playing to activate Random Play. This feature plays the tracks on the selected disc in random order to provide an interesting change of pace.

Press the SEEK button to move to the next randomly selected track.

Press the RND (button 4) button a second time to stop Random Play.

**Mode**

Press the MODE button repeatedly to select between the CD player, the optional remote CD changer and the Satellite Radio (if equipped). When Satellite Radio (if equipped) is selected "SA" will appear in your radio display.

A CD or tape may remain in the player while in the Satellite mode.

**Time**

Press the TIME button to change the display from elapsed CD playing time to time of day.

**CD Changer Control Capability — If Equipped**

This radio is compatible with a remote mounted CD changer available through Mopar Accessories. The following instructions are for the radio controls that operate this CD changer.

**Mode Button**

To activate the CD changer, press the MODE button until CD information appears on the display.

**Push-Button**

While the CD changer is playing, press the NUMBER 1 push-button or the NUMBER 5 push-button to select a disc numbered higher or lower than the one currently being played.



**Seek Button**

Press the SEEK up or down to select another track on the same disc. A SEEK symbol will appear on the display.

**Fast Forward And Rewind Buttons**

Press and hold the FF button for fast forward. Press and hold the RW button for fast reverse.

The audio output can be heard when fast forward and fast reverse are activated.

**Random Play (RND)**

Press the Random button to play the tracks on the selected disc in random order for an interesting change of pace.

Random can be cancelled by pressing the button a second time or by ejecting the CD from the changer.

**CD Diagnostic Indicators**

When driving over a very rough road, the CD player may skip momentarily. Skipping will not damage the disc or the player, and play will resume automatically.

As a safeguard and to protect your CD player, one of the following warning symbols may appear on your display.

A CD HOT symbol indicates the player is too hot.



CD HOT will pause the operation. Play can be resumed when the operating temperature is corrected or another MODE is selected.

An ERR symbol will appear on the display if the laser is unable to read the Disc data for the following reasons:

- Excessive vibration
- Disc inserted upside down
- Damaged disc
- Water condensation on optics

### Radio Display Messages

Your radio has been designed to display certain messages when a problem is detected with the CD player.

DISPLAY	EXPLANATION	WHAT TO DO
E-01	Deadlock problem	See your dealer for service
E-02	Disc eject problem	See your dealer for service
E-06	Elevator problem	See your dealer for service
E-07	Magazine eject problem	Check that magazine is OK- if not see your dealer for service
	No discs in magazine. Load discs in magazine.	
	Player overheating. Allow to cool down.	

### SALES CODE RBQ—AM/FM STEREO RADIO WITH 6 - DISC CD CHANGER

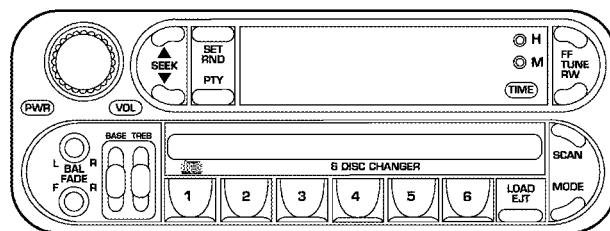

80f1ee0e

### Radio Operation

#### Power/Volume Control

Press the PWR/VOL control to turn the radio on. Turn the volume control clockwise to increase the volume.

**NOTE:** Power to operate the radio is controlled by the ignition switch. It must be in the ON or ACC position to operate the radio.

#### **Mode**

Press the MODE button repeatedly to select between AM, FM, the CD changer and Sirius Satellite Radio™ (if equipped). The display will show ST when a stereo station is received.

To select Sirius Satellite Radio™ (if equipped), press the MODE button until the word SIRIUS appears. The following will be displayed in this order: After three seconds, the current channel name and number will be displayed for five seconds. The current program type and channel number will then be displayed for five seconds. The current channel name and number will then be displayed until an action occurs. CD's may remain in the player while in the Satellite Radio mode.

#### **Seek**

Press and release the SEEK button to search for the next station in either the AM or FM mode. Press the top of the button to seek up and the bottom to seek down. The radio will remain tuned to the new station until you make another selection. Holding the button in will bypass stations without stopping until you release it.

#### **Tune**

Press the TUNE control up or down to increase or decrease the frequency. If the button is pressed and held, the radio will continue to tune until the button is released. The frequency will be displayed and continuously updated while the button is pressed.

#### **Balance — BAL**

The Balance control adjusts the left-to-right speaker balance. Press the BAL button in and it will pop out. Adjust the balance and push the button back in.

**Fade**

The Fade control provides for balance between the front and rear speakers. Press the FADE button in and it will pop out. Adjust the balance and push the button back in.

**Tone Control**

The tone controls affect the Bass and Treble frequency bands. Each is controlled by a slider control with a detent at the mid position. Moving a control up or down increases or decreases amplification of the band. The mid position provides a balanced output.

**To Set The Radio Push-Button Memory**

When you are receiving a station that you wish to commit to push-button memory, press the SET RND button. SET 1 will show in the display window. Select the "1-6" button you wish to lock onto this station and press and release that button. If a button is not selected within

5 seconds after pressing the SET RND button, the station will continue to play but will not be locked into push-button memory.

You may add a second station to each push-button by repeating the above procedure with this exception: Press the SET button twice and SET 2 will show in the display window. Each button can be set for SET 1 and SET 2 in both AM and FM. This allows a total of 12 AM and 12 FM stations to be locked into push-button memory. The stations stored in SET 2 memory can be selected by pressing the corresponding push-button twice. Every time a preset button is used, a corresponding button number will be displayed.

**Time Button**

Press the TIME button to change the display between radio frequency and time.

**General Information**

This radio complies with Part 15 of FCC rules and with RSS-210 of Industry Canada. Operation is subject to the following conditions:

1. This device may not cause harmful interference,
2. This device must accept any interference received, including interference that may cause undesired operation.

**NOTE:** Changes or modifications not expressly approved by the party responsible for compliance could void the user's authority to operate the equipment.

**CD Player Operation**

**NOTE:** The ignition switch must be in the ON or ACC position and the Power / Volume control pushed ON before the CD player will operate.

**Inserting The Compact Disc****CAUTION!**

**This CD player will accept 4 ¾ inch (12 cm) discs only. The use of other sized discs may damage the CD player mechanism.**

4

You may either insert or eject a disc with the radio OFF.

If you insert a disc with the ignition ON and the radio OFF, the display will show the time of day. If you insert a disc with the ignition OFF, the display will show the time of day for about 5 seconds, then go out.

If you insert a disc with the ignition ON and the radio ON, the unit will switch from radio to CD mode and begin to play when you insert the disc. The display will

show the disc number, the track number, and index time in minutes and seconds. Play will begin at the start of track 1.

**LOAD/ EJT — Load**

Press the LOAD/ EJT button and the button with the corresponding number where the CD is being loaded. After the radio displays “load” insert the CD into the player.

Radio display will show “loading” when it is being loaded.

**LOAD / EJT — Eject**

Press the LOAD/ EJT button and the button with the corresponding number where the CD was loaded and the disc will unload and move to the entrance for easy removal.

Radio display will show “ejecting” when it is being ejected.

If you have ejected a disc and have not removed it within 15 seconds, it will be reloaded. If the CD is not removed, the radio will continue to play the non-removed CD. If the CD is removed and there are other CD's in the radio, the radio will play the next CD. If the CD is removed and there are no other CD's in the radio, the radio will return to the last selected AM or FM mode.

The disc can be ejected with the radio and ignition OFF.

**Seek**

Press the top of the SEEK button for the next selection on the CD. Press the bottom of the button to return to the beginning of the current selection, or return to the beginning of the previous selection if the CD is within the first second of the current selection.

**Scan**

Press the Scan button to scan through each track on the CD currently playing.

**FF/TUNE/RW**

Press FF (Fast Forward) and the CD player will begin to fast forward until FF is released. The RW ( Reverse) button works in a similar manner.

**Random Play — SET / RND**

Press the RND button while the CD is playing to activate Random Play. This feature plays the tracks on the disc in random order to provide an interesting change of pace.

Press the SEEK button to move to the next randomly selected track.

Press TUNE FF to fast forward through the tracks. Press the FF button a second time to stop the fast forward feature. If TUNE RW is pressed, the current track will reverse to the beginning of the track and begin playing.

Press the SET / RND button a second time to stop Random Play.

**PTY (Program Type) Button**

Pressing this button once will turn on the PTY mode for 5 seconds. If no action is taken during the 5 second time out the PTY icon will turn off. Pressing the PTY button within 5 seconds will allow the program format type to be selected. Many radio stations do not currently broadcast PTY information.

Toggle the PTY button to select the following format types:

Program Type	Radio Display
Adult Hits	Adlt Hit
Classical	Classicl
Classic Rock	Cls Rock
College	College
Country	Country
Emergency	ALERT!
Emergency Test	Test
Information	Inform
Jazz	Jazz

Program Type	Radio Display
Foreign Language	Language
News	News
Nostalgia	Nostalga
Oldies	Oldies
Personality	Persnlty
Public	Public
Rhythm and Blues	R & B
Religious Music	Rel Musc
Religious Talk	Rel Talk
Rock	Rock
Soft	Soft
Soft Rock	Soft Rck
Soft Rhythm and Blues	Soft R&B
Sports	Sports
Talk	Talk
Top 40	Top 40
Weather	Weather

By pressing the SEEK button when the PTY icon is displayed, the radio will be tuned to the next frequency station with the same selected PTY name. The PTY function only operates when in the FM mode.

The radio display will flash "SEEK" and the selected PTY program type when searching for the next PTY station. If no station is found with the selected PTY program type, the radio will return to the last station.

If a preset button is activated while in the PTY (Program Type) mode, the PTY mode will be exited and the radio will tune to the preset station.

By pressing the SCAN button when the PTY icon is displayed, the radio will stop at every PTY station on the band and list each corresponding program type in the radio display.

#### **Time**

Press the TIME button to change the display from elapsed CD playing time to time of day.



### SALES CODE RB1—AM/FM STEREO RADIO WITH DVD/GPS NAVIGATION SYSTEM

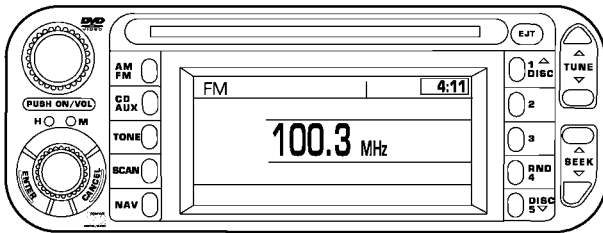

810774da

The navigation system provides maps, turn identification, selection menus and instructions for selecting a variety of destinations and routes. Refer to your “Navigation User’s Manual” for detailed operating instructions.

### SATELLITE RADIO — IF EQUIPPED

Satellite radio uses direct satellite to receiver broadcasting technology to provide clear digital sound, coast to coast. The subscription service provider is Sirius™ Satellite Radio. This service offers up to 100 channels of music, sports, news, entertainment, and programming for children, directly from its satellites and broadcasting studios.

#### System Activation

To activate your Sirius Satellite Radio service, call the toll-free number 888-539-7474, or visit the Sirius web site at [www.sirius.com](http://www.sirius.com). Please have the following information available when activating your system:

1. The Electronic Serial Number/Sirius Identification Number (ESN/SID).
2. Credit card information.
3. Your Vehicle Identification Number.

**Electronic Serial Number/Sirius Identification Number (ENS/SID)**

The Electronic Serial Number/Sirius Identification Number is needed to activate your Sirius Satellite Radio system. To access the ESN/SID, refer to the following steps:

**ESN/SID Access With RBB and RBK Radios**

With the ignition switch in the ACCESSORY position and the radio OFF, press the Tape Eject or CD Eject (depending on the radio type) and Time buttons simultaneously for 3 seconds. The first four digits of the twelve-digit ESN/SID number will be displayed. Press the SEEK UP button to display the next four digits. Continue to press the SEEK UP button until all twelve ESN/SID digits have been displayed. The SEEK DOWN will page down until the first four digits are displayed. The radio will exit the ESN/SID mode when any other button is pushed, the ignition is turned OFF, or 5 minutes has passed since any button was pushed.

**ESN/SID Access With RBP, RBU, RAZ, and RBQ Radios**

With the ignition switch in the ACCESSORY position and the radio OFF, press the CD Eject and TIME buttons simultaneously for 3 seconds. All twelve ESN/SID numbers will be displayed. The radio will exit the ESN/SID mode when any other button is pushed, the ignition is turned OFF, or 5 minutes has passed since any button was pushed.

**Selecting Satellite Mode in RBB and RBK Radios**

Press the MODE button repeatedly until "S A" appears in the display. A CD or tape may remain in the radio while in the Satellite radio mode.

**Selecting Satellite Mode in RBP, RBU, RAZ, and RBQ Radios**

Press the MODE button repeatedly until the word "SIRIUS" appears in the display. These radios will also display the following:

- After 3 seconds, the current channel name and channel number will be displayed for 5 seconds.
- The current program type and channel number will then be displayed for 5 seconds.
- The current channel number will then be displayed until an action occurs.

A CD or tape may remain in the radio while in the Satellite radio mode.

#### **Selecting a Channel**

Press and release the SEEK or TUNE buttons to search for the next channel. Press the top of the button to search up and the bottom of the button to search down. Holding the TUNE button causes the radio to bypass channels until the button is released.

Press and release the SCAN button (if equipped) to automatically change channels every 7 seconds. The radio will pause on each channel for 7 seconds before moving on to the next channel. The word "SCAN" will appear in the display between each channel change. Press the SCAN button a second time to stop the search.

**NOTE:** Channels that may contain objectionable content can be blocked. Contact Sirius Customer Care at 888-539-7474 to discuss options for channel blocking or unblocking. Please have your ESN/SID information available.

#### **Storing and Selecting Pre-Set Channels**

In addition to the 10 AM and 10 FM pre-set stations, you may also commit 10 satellite stations to push button memory. These satellite channel pre-set stations will not erase any AM or FM pre-set memory stations. Follow the memory pre-set procedures that apply to your radio.

**Using the PTY (Program Type) Button (if equipped)**

Follow the PTY button instructions that apply to your radio.

**PTY Button "SCAN"**

When the desired program type is obtained, press the "SCAN" button within five seconds. The radio will play 7 seconds of the selected channel before moving to the next channel of the selected program type. Press the "SCAN" button a second time to stop the search.

**NOTE:** Pressing the "SEEK" or "SCAN" button while performing a music type scan will change the channel by one and stop the search. Pressing a pre-set memory button during a music type scan, will call up the memory channel and stop the search.

**PTY Button "SEEK"**

When the desired program is obtained, press the "SEEK" button within five seconds. The channel will change to the next channel that matches the program type selected.

**Satellite Antenna**

To ensure optimum reception, do not place items on the roof around the rooftop antenna location. Metal objects placed within the line of sight of the antenna will cause decreased performance. Larger luggage items should be placed as far forward as possible. Do not place items directly on or above the antenna.

**Reception Quality**

Satellite reception may be interrupted due to one of the following reasons.

- The vehicle is parked in an underground parking structure or under a physical obstacle.

- Dense tree coverage may interrupt reception in the form of short audio mutes.
- Driving under wide bridges or along tall buildings can cause intermittent reception.
- Placing objects over or too close to the antenna can cause signal blockage.

#### CASSETTE TAPE AND PLAYER MAINTENANCE

To keep the cassette tapes and player in good condition, take the following precautions:

1. Do not use cassette tapes longer than C-90; otherwise, sound quality and tape durability will be greatly diminished.
2. Keep the cassette tape in its case to protect from slackness and dust when it is not in use.
3. Keep the cassette tape away from direct sunlight, heat and magnetic fields such as the radio speakers.
4. Before inserting a tape, make sure that the label is adhering flatly to the cassette.
5. A loose tape should be corrected before use. To rewind a loose tape, insert the eraser end of a pencil into the tape drive gear and twist the pencil in the required directions.

Maintain your cassette tape player. The head and capstan shaft in the cassette player can pick up dirt or tape deposits each time a cassette is played. The result of deposits on the capstan shaft may cause the tape to wrap around and become lodged in the tape transport. The other adverse condition is low or "muddy" sound from one or both channels, as if the treble tone control were turned all the way down. To prevent this, you should periodically clean the head with a commercially available WET cleaning cassette.

As preventive maintenance, clean the head about every 30 hours of use. If you wait until the head becomes very

dirty (noticeably poor sound), it may not be possible to remove all deposits with a simple WET cleaning cassette.

#### **CD/DVD DISC MAINTENANCE**

To keep the CD/DVD discs in good condition, take the following precautions:

1. Handle the disc by its edge; avoid touching the surface.
2. If the disc is stained, clean the surface with a soft cloth, wiping from center to edge.
3. Do not apply paper, paper CD labels, or tape to the disc; avoid scratching the disc.
4. Do not use solvents such as benzine, thinner, cleaners, or antistatic sprays.
5. Store the disc in its case after playing.
6. Do not expose the disc to direct sunlight.

7. Do not store the disc where temperatures may become too high.

#### **RADIO OPERATION AND CELLULAR PHONES**

Under certain conditions, the cellular phone being On in your vehicle can cause erratic or noisy performance from your radio. This condition may be lessened or eliminated by relocating the cellular phone antenna. This condition is not harmful to the radio. If your radio performance does not satisfactorily "clear" by the repositioning of the antenna, it is recommended that the radio volume be turned down or off during cellular phone operation.

#### **CLIMATE CONTROLS**

##### **Air Conditioning**

The Air Conditioning System allows you to balance the temperature, amount, and direction of air circulating throughout the vehicle. The controls are located on the instrument panel, above the radio.

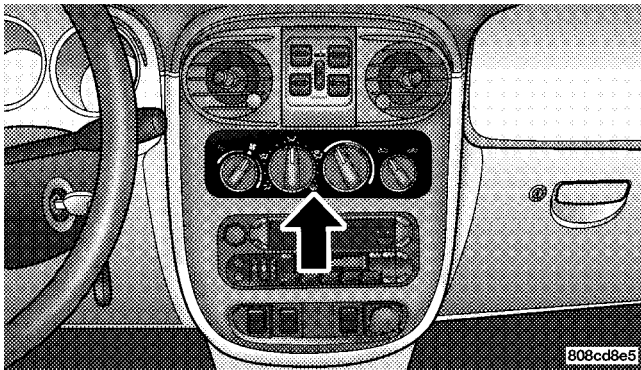

The air conditioning system of your vehicle contains R-134a, a refrigerant that does not deplete the ozone layer in the upper atmosphere.

The controls are as follows:

### Fan and Air conditioning Control

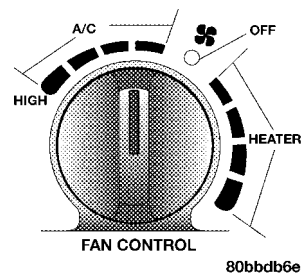

Use this control to regulate the amount of air forced through the system in any mode you select. The fan speeds to the left of the OFF position are for Air Conditioning. Choosing one of these speeds turns on the air conditioning compressor. The fan speed increases as you move the control to the left from the OFF position.

**NOTE:** The air conditioning compressor will not engage until the engine has been running for about 10 seconds.

Fan speeds to the right of OFF are for heater or ventilation operation. The fan speed increases as you move the control to the right from the OFF position.

### Mode Control (Air Direction)

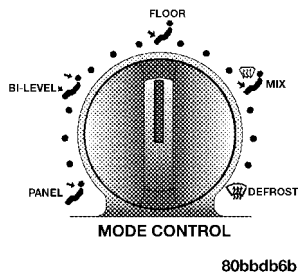

The mode control allows you to choose from several patterns of air distribution. You can select either a primary mode, as identified by the symbols, or a blend of two of these modes. The center point between modes gives an even blend of both modes. The closer the control is to a particular mode, the more air distribution you receive from that mode.

#### **Panel**

 Air is directed through the outlets in the instrument panel. These outlets can be adjusted to direct air flow.

#### **Bi-Level**

 Air is directed through the panel and floor outlets.

**NOTE:** There is a difference in temperature between the upper and lower outlets for added comfort. The warmer air goes to the floor outlets. This feature gives improved comfort during sunny but cool conditions.

#### **Floor**

 Air is directed through the floor outlets and side window demist outlets with a small amount through the defrost outlet.

#### **Mix**

 Air is directed through the floor, defrost and side window demist outlets. This setting works best in cold or snowy conditions that require extra heat at the windshield. This setting is good for maintaining comfort while reducing moisture on the windshield.



**Defrost**

Air is directed through the windshield and side window demist outlets. Use this mode with maximum fan and temperature settings for best windshield and side window defrosting.

**NOTE:** The air conditioning compressor operates in both Mix and Defrost or a blend of these modes even if the fan switch is not in the A/C position. This dehumidifies the air to help dry the windshield. To improve fuel economy, use these modes only when necessary.

**Air Outlets**

The airflow from each of the instrument panel outlets can be adjusted for direction and turned on or off to control air flow.

A knob attached in the center of each instrument panel outlet is used to adjust the airflow direction, and a knob

on the outer edge of each instrument panel outlet grille opens or closes a shutter to turn airflow on or off through that outlet.

**NOTE:** For maximum airflow to the rear seat passengers, the center instrument panel outlets can be aimed, so that the left center outlet is directed toward the right rear passenger and the right center outlet is directed toward the left rear passenger.

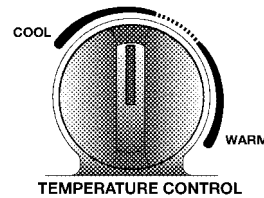
**Temperature Control**

Use this control to regulate the temperature of the air inside the passenger compartment. The blue area of the scale indicates cooler temperatures while the red area indicates warmer temperatures.

80bbdb6c

**NOTE:** If your air conditioning performance seems lower than expected, check the front of the A/C condenser: located in front of the radiator, for an accumulation of dirt or insects. Clean with a gentle water spray from behind the radiator and through the condenser. Fabric front fascia protectors may reduce air flow to the condenser, reducing air conditioning performance.

### Circulation Control

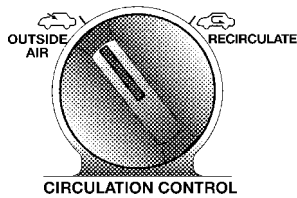

80bbdb6d

Use this control to choose between outside air intake or recirculation of the air inside the vehicle. Only use the recirculate mode to temporarily block out any outside odors, smoke, or dust and to cool the interior rapidly upon initial start up in very hot or humid weather.

This control only operates in the Outside Air and Recirculate modes; there is no in between position. Do not place the control between these positions.











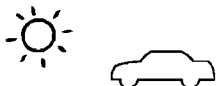









**NOTE:** Continuous use of the recirculate mode may make the inside air stuffy and window fogging may occur. Extended use of this mode is not recommended.

In cold or damp weather, the use of the Recirculate position will cause windows to fog on the inside because of moisture build up inside the vehicle. For maximum defogging, select the Outside Air position.

If the mode control is in the range between Mix and Defrost and you choose the recirculate mode, the mode control knob will automatically move to the left of the Mix position.

**NOTE:** If you choose Defrost mode and the Circulation control is in the recirculate Mode, the system will automatically switch to the Outside Air mode and the knob will move to that position.

Operating Tips

WEATHER	CONTROL SETTINGS
<p>HOT WEATHER AND VEHICLE INTERIOR IS VERY HOT</p> 	<p>Open the windows, start the vehicle, and place the Circulation control at . Set the Fan control to the high A/C position (full counterclockwise) position. Set the Mode control at or between  and . Set the temperature control to full cool. After the hot air is flushed from the vehicle, turn the Circulation control to  and roll up the windows. Once you are comfortable, place the Circulation control at  and adjust the temperature control for comfort.</p>
<p>WARM WEATHER</p> 	<p>Set the Circulation control to . If it's sunny, set the Mode control at or near  and turn the air conditioning on. If it's cloudy or dark, set the Mode control at or near .</p>
<p>COOL OR COLD HUMID CONDITIONS</p> 	<p>Set the Circulation control to . If it's sunny, set the Mode control at or between  and  then turn the air conditioning on. If it's cloudy or dark, set the Mode control at or near  and turn the air conditioning on.</p>
<p>COLD DRY CONDITIONS</p> 	<p>Set the Circulation control to . Set the Mode control at or near . If it is sunny, you may want more upper air. In this case, set the Mode control at or between  and . In very cold weather, if you need extra heat at the windshield, set the Mode control at or near the .</p>

80504196

**Window Fogging**

Vehicle side windows tend to fog on the inside in mild rainy or humid weather. To clear the windows, use the A/C, PANEL and blower controls. Direct the panel outlets toward the side windows. Do not use recirculate without A/C for long periods as fogging may occur.

Interior fogging on the windshield can be quickly removed by using the defrost position.

If the fogging problem persists, clean the inside window surfaces. The cause of undue fogging may be dirt collecting on the inside surface of the glass

**NOTE:** In cold weather, the use of the recirculate position will cause windows to fog on the inside because of moisture build up inside the vehicle. For maximum defogging, use the Outside Air position.

**Summer Operation**

Air conditioned vehicles must be protected with a high-quality antifreeze coolant to provide proper corrosion protection and to raise the boiling point of the coolant for protection against overheating. A 50% concentration is recommended.

**Outside Air Intake**

When operating the system during the winter months, make sure the air intake, directly in front of the windshield, is free of ice, slush, snow or other obstructions such as leaves. Leaves collected in the air-intake plenum may reduce air flow and plug the plenum water drains.

The blower air will heat faster in cold weather if you use only a low blower speed for the first few minutes of vehicle operation.

### Side Window Demisters

A side window demister outlet is at each end of the instrument panel. These nonadjustable outlets direct air toward the side windows when the system is in either the FLOOR, MIX, or DEFROST mode. The air is directed at the area of the windows through which you view the outside mirrors.

### REAR WINDOW FEATURES

#### Electric Rear Window Defroster



The push-button is located at the center of the instrument panel, below the radio. Press this button to turn on the rear window defroster, and the optional electric remote control heated mirrors. An amber light shows that the defroster is on.

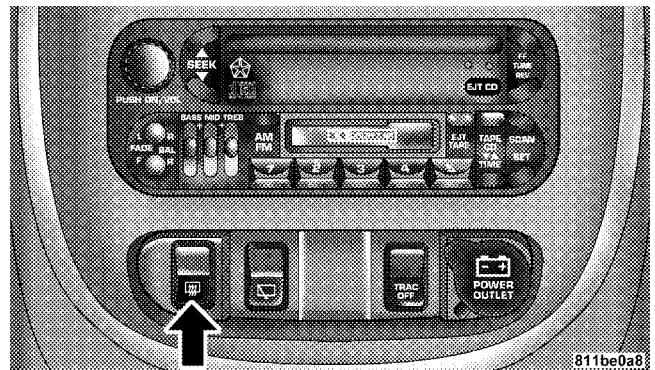

**NOTE:** The defroster turns off automatically after 10 minutes of operation. Each following activation of the defroster will last for five minutes.

**CAUTION!**

To avoid damaging the electrical conductors, do not use scrapers, sharp instruments, or abrasive window cleaners on the interior surface of the rear window. Labels can be peeled off after soaking with warm water.

**Rear Wiper/Washer Switch**

A push-button at the center of the instrument panel, below the radio, turns the rear wiper ON or OFF. When this switch is pressed the rear wiper will operate at a fixed interval of about 4 seconds between wipes.

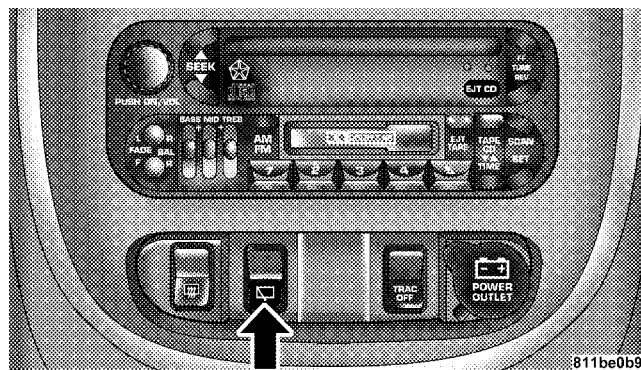

 Press and hold the switch as long as spray is desired. If the switch is depressed while the wiper is on, the wiper will operate for a few seconds after the switch is released then resume the previously set mode of intermittent wiper.

### Adding Washer Fluid

The fluid reservoir for the windshield washers and the rear window washer is shared. It is located in the rear of the engine compartment on the passenger side and should be checked for fluid level at regular intervals. Fill the reservoir with windshield washer solvent (not radiator antifreeze) and operate the system for a few seconds to flush out the residual water.

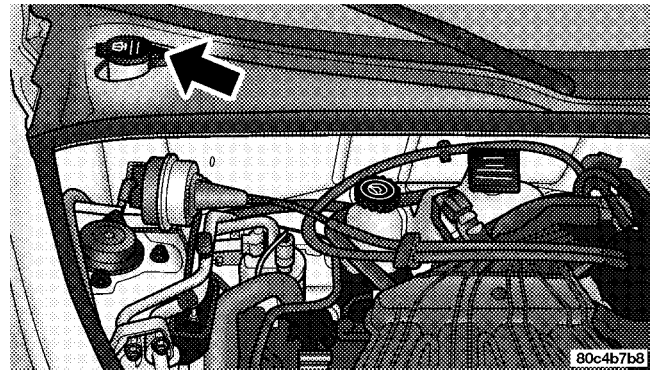





---

# STARTING AND OPERATING

## CONTENTS

---

■ Starting Procedures . . . . .	180	■ Automatic Transaxle — If Equipped . . . . .	183
□ Automatic Transaxle . . . . .	180	□ Brake/Transmission Interlock System . . . . .	184
□ Manual Transaxle . . . . .	180	□ Automatic Transaxle Ignition Interlock System . . . . .	184
□ Normal Starting . . . . .	180	□ Four Speed Automatic Transaxle . . . . .	184
□ Extremely Cold Weather (Below -20°F Or -29°C) . . . . .	181	□ Reset Mode . . . . .	184
□ If Engine Fails To Start . . . . .	181	□ Gear Ranges For Four Speed Automatic Transaxle . . . . .	185
□ After Starting . . . . .	182	■ AutoStick — If Equipped . . . . .	187
□ Turbocharger “Cool Down” . . . . .	182	□ AutoStick Operation . . . . .	187

178 STARTING AND OPERATING

□ AutoStick General Information . . . . .	188	□ Tire Identification Number (TIN) . . . . .	201
■ Manual Transaxle Operation . . . . .	189	□ Tire Loading And Tire Pressure . . . . .	202
□ 2.4 Liter Turbo— If Equipped . . . . .	190	■ Tires—General Information . . . . .	206
□ Recommended Shift Speeds . . . . .	190	□ Tire Pressure . . . . .	206
□ Downshifting . . . . .	191	□ Tire Inflation Pressures . . . . .	207
■ Parking Brake . . . . .	192	□ Radial-Ply Tires . . . . .	210
■ Brake System . . . . .	194	□ Compact Spare Tire — If Equipped . . . . .	210
□ Anti-Lock Brake System (ABS) — If Equipped . . . . .	194	□ Tire Spinning . . . . .	211
■ Power Assisted Steering . . . . .	196	□ Tread Wear Indicators . . . . .	212
■ Traction Control — If Equipped . . . . .	196	□ Replacement Tires . . . . .	212
■ Tire Safety Information . . . . .	197	□ Alignment And Balance . . . . .	213
□ Tire Markings . . . . .	197	■ Tire Chains . . . . .	214
		■ Snow Tires . . . . .	214

■ Tire Rotation Recommendations . . . . .	215	□ Materials Added To Fuel . . . . .	219
■ Fuel Requirements . . . . .	216	□ Fuel System Cautions . . . . .	219
□ 2.4L Standard Engine And 2.4L Standard Turbo Engine . . . . .	216	□ Carbon Monoxide Warnings . . . . .	220
□ 2.4L High Output Turbo Engine . . . . .	216	■ Adding Fuel . . . . .	221
□ Reformulated Gasoline . . . . .	217	□ Fuel Filler Cap (Gas Cap) . . . . .	221
□ Gasoline/Oxygenate Blends . . . . .	217	■ Vehicle Loading . . . . .	223
□ MMT In Gasoline . . . . .	218	■ Trailer Towing . . . . .	223
□ Sulfur In Gasoline . . . . .	218	□ Warranty Requirements . . . . .	224

**STARTING PROCEDURES**

Before starting your vehicle, adjust your seat, adjust both inside and outside mirrors, and fasten your seat belts.

**CAUTION!**

Long periods of engine idling, especially at high engine speeds can cause excessive exhaust temperatures which can damage your vehicle. Do not leave your vehicle unattended with the engine running.

**WARNING!**

Do not leave children or animals inside parked vehicles in hot weather. Interior heat build up may cause serious injury or death.

**Automatic Transaxle**

The gear selector must be in the NEUTRAL or PARK position before you can start the engine. Apply the brakes before shifting to any driving gear.

**NOTE:** You must press the brake pedal before shifting out of Park.

**Manual Transaxle**

Before starting the engine fully apply the parking brake, press the clutch pedal to the floor and place the gear selector in NEUTRAL.

**NOTE:** The engine will not start unless the clutch pedal is pressed to the floor.

**Normal Starting**

Normal Starting of either a cold or a warm engine does not require pumping or depressing the accelerator pedal. Simply turn the ignition switch to the "START" position and release when the engine starts. If the engine has not

started within 3 seconds, slightly depress the accelerator pedal while continuing to crank. If the engine fails to start within 15 seconds, turn the ignition switch to the "OFF" position, wait 10 to 15 seconds, then repeat the normal starting procedure.

**WARNING!**

**Do not attempt to push or tow your vehicle to get it started. Vehicles equipped with an automatic trans-axle cannot be started this way. Unburned fuel could enter the catalytic converter and once the engine has started, ignite and damage the converter and vehicle. If the vehicle has a discharged battery, booster cables may be used to obtain a start from another vehicle. This type of start can be dangerous if done improperly, so follow the procedure carefully. See section 6 of this manual for jump starting instructions.**

**Extremely Cold Weather (below  $-20^{\circ}\text{F}$  or  $-29^{\circ}\text{C}$ )**

To insure reliable starting at these temperatures, use of an externally powered electric engine block heater (available from your dealer) is recommended.

**If Engine Fails to Start**

If the engine fails to start after you have followed the "NORMAL STARTING" procedure, it may be flooded. Push the accelerator pedal all the way to the floor and hold it there. Crank the engine for no more than 15 seconds. This should clear any excess fuel in case the engine is flooded. Leave the ignition key in the ON position, release the accelerator pedal and repeat the "NORMAL STARTING" procedure.

5

**WARNING!**

**Never pour fuel or other flammable liquid into the throttle body air inlet opening in an attempt to start the vehicle. This could result in flash fire causing serious personal injury.**

**CAUTION!**

To prevent damage to the starter, do not crank the engine for more than 15 seconds at a time. Wait 10 to 15 seconds before trying again.

**After Starting**

The idle speed will automatically decrease as the engine warms up.

**Turbocharger "Cool Down"**

**NOTE:** Letting the engine idle after severe operation allows the turbine housing to cool to normal operating temperature.

The following chart should be used as a guide in determining the amount of engine idle time required to sufficiently cool down the turbocharger before shut down, depending upon the type of driving and the amount of cargo.

<b>TURBOCHARGER "COOL DOWN" CHART</b>	
<b>Driving Conditions</b>	<b>Idle Time (in minutes) Before Shut Down</b>
Normal Driving	Not required.
Aggressive Driving or Heavily Loaded	3
Trailer Tow	5

**AUTOMATIC TRANSAXLE — IF EQUIPPED****CAUTION!**

Damage to the transaxle may occur if the following precautions are not observed:

- Shift into PARK only after the vehicle has come to a complete stop.
- Shift into or out of REVERSE only after the vehicle has come to a complete stop and the engine is at idle speed.
- Do not shift from REVERSE, PARK, or NEUTRAL into any forward gear when the engine is above idle speed.
- Before shifting into any gear, make sure your foot is firmly on the brake pedal.

**NOTE:** You **MUST** press and hold the brake pedal down while shifting out of Park.

**WARNING!**

It is dangerous to shift the selector lever out of “P” or “N” if the engine speed is higher than idle speed. If your foot is not firmly on the brake pedal, the vehicle could accelerate quickly forward or in reverse. You could lose control of the vehicle and hit someone or something. Only shift into gear when the engine is idling normally and when your right foot is firmly on the brake pedal.

**Brake/Transmission Interlock System**

This system prevents you from moving the gear shift out of Park and into any gear unless the brake pedal is pressed. This system is active only while the ignition switch is in the ON positions. Always depress the **brake pedal first**, before moving the gear selector out of PARK.

**Automatic Transaxle Ignition Interlock System**

This system prevents the key from being removed unless the shift lever is in PARK and the shift knob push button is out. It also prevents shifting out of PARK unless the key is in the OFF or ON positions.

**NOTE:** If a malfunction occurs, the system will trap the key in the ignition cylinder to warn you that this safety feature is inoperable. The engine can be started and stopped but the key cannot be removed until you obtain service.

**Four Speed Automatic Transaxle**

The electronically controlled transaxle provides a precise shift schedule. The transaxle electronics are self-calibrating; therefore, the first few shifts on a new vehicle may be somewhat abrupt. This is a normal condition, and precision shifts will develop within a few shift cycles.

**Reset Mode**

The transaxle is monitored electronically for abnormal conditions. If a condition is detected that could cause damage, the transaxle shifts automatically into second gear. The transaxle remains in second gear despite the forward gear selected. Park (P), Reverse (R), and Neutral (N) will continue to operate. This second gear limp-in feature allows the vehicle to be driven to a dealer for service without damaging the transaxle.

In the event that the problem has been momentary, the transaxle can be reset to regain all forward gears.

Stop the vehicle and shift into Park (P).



Turn the Key to OFF then restart the engine.

Shift into D and resume driving.

**NOTE:** Even if the transaxle can be reset, it is recommended that you visit a dealer at your earliest possible convenience. Your dealer has diagnostic equipment to determine if the problem could recur.

If the transaxle cannot be reset, dealer service is required.

#### **Gear Ranges For Four Speed Automatic Transaxle**

DO NOT race the engine when shifting from PARK or NEUTRAL positions into another gear range.

#### **“P” Park**

Supplements the parking brake by locking the transmission. The engine can be started in this range. Never use P (Park) while the vehicle is in motion. Apply the parking

brake when leaving the vehicle in this range. Always apply the parking brake first, and then place the selector in P (Park) position.

#### **WARNING!**

**Unintended movement of a vehicle could injure those in and near the vehicle. As with all vehicles, you should never exit a vehicle while the engine is running. Before exiting a vehicle, you should always shift the vehicle into P (Park), remove the key from the ignition, and apply the parking brake. Once the key is removed from the ignition, the transmission shift lever is locked in the P (Park) position, securing the vehicle against unwanted movement. Furthermore, you should never leave children unattended inside a vehicle.**

The following indicators should be used to ensure that you have engaged the transmission shift lever into the P (Park) position:

- When shifting into P (Park), depress the button on the shift lever and firmly move the lever all the way forward until it stops.
- Look at the shift indicator window on the console to ensure it is in the P (Park) position.
- When engaged in P (Park), you will not be able to move the shifter rearward without depressing the shift lever button.

**CAUTION!**

Before moving the shift lever out of P (Park), you must turn the ignition from LOCK to ON so the steering wheel and shift lever are released. Otherwise, damage to the steering column or shifter could result.

**“R” Reverse**

Shift into this range only after the vehicle has come to a complete stop.

**“N” Neutral**

Engine may be started in this range.

**“D” Overdrive**

This range should be used for most city and highway driving. It provides smoothest up shifts and down shifts and best fuel economy.

When frequent transaxle shifting occurs while using the Overdrive range, such as when operating the vehicle under heavy loading conditions (in hilly terrain, traveling into strong head winds, or while towing trailers), use the “3” range.

**“3” Drive**

This range eliminates shifts into Overdrive. The transaxle will operate normally in first and second while in this range.

**NOTE:** Using the “3” range while operating the vehicle under heavy operating conditions will improve performance, fuel economy, and extend transaxle life by reducing excessive shifting and heat build up.

Use the “3” range when descending steep grades to prevent brake system distress.

**“1” Low**

This range should be used for maximum engine braking when descending steep grades. In this range, up shifts will occur only to prevent engine over speed while down shifts from 2nd to first will occur as early as possible.

**AUTOSTICK — IF EQUIPPED**

Autostick is a driver-interactive transmission that offers manual gear shifting capability to provide you with more control. Autostick allows you to maximize engine braking, eliminate undesirable upshifts and downshifts, and improve overall vehicle performance. This system can also provide you with more control during passing, city driving, cold slippery conditions, mountain driving, trailer towing, and many other situations.

**Autostick Operation**

The Autostick position is just below the Overdrive position and is identified by the word “AUTOSTICK”. When you place the shift lever in the Autostick position, it can be moved from side to side. Moving the lever to the left (-) triggers a downshift and to the right (+) an upshift. The gear position will be shown in the transmission gear display, located in the instrument cluster.

You can shift in or out of the autostick mode at any time without taking your foot off the accelerator pedal. If you choose the Overdrive mode, the transmission will operate automatically; shifting between the four available gears. When you wish to engage autostick, simply move the shift lever to the AUTOSTICK position. The transmission will remain in the current gear until an upshift or downshift is chosen.

Move the lever back to the Overdrive position to shift out of the Autostick mode.

#### **Autostick General Information**

- The transmission will automatically upshift from first to second gear and from second to third gear when engine speed reaches about 6300 RPM.
- Downshifts from third to second gear above 74 mph (119 km/h) and from second to first gear above 41 mph (66 km/h) will be ignored.
- You can start out in first, second, or third gear. Shifting into fourth gear can occur only after vehicle speed reaches 15 mph (24 km/h).
- The transmission will automatically downshift to first gear when coming to a stop.
- Starting out in third gear is helpful in snowy or icy conditions.
- While in the Autostick mode, Speed Control will only function in third or fourth gear.  
Downshifting out of third gear will turn off the speed control.
- If the system detects powertrain overheating, the transmission will revert to the automatic shift mode and remain in that mode until the powertrain cools off.
- If the system detects a problem it will disable the Autostick mode and the transmission will return to the automatic mode until the problem is corrected.

### MANUAL TRANSAXLE OPERATION

**NOTE:** The parking brake should be engaged and the gear selector placed in REVERSE before leaving the vehicle, especially on an incline.

Fully depress the clutch pedal before you shift gears. As you release the clutch pedal, lightly depress the accelerator pedal.

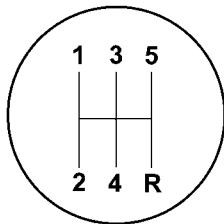

80f7bc4b

Use each gear in numerical order - do not skip a gear. Be sure the transaxle is in FIRST gear, (not THIRD), when starting from a standing position. Damage to the clutch can result from starting in THIRD.

For most city driving you will find it easier to use only the lower gears. For steady highway driving with light accelerations, 5th gear is recommended.

Never drive with your foot resting on the clutch pedal, or try to hold the vehicle on a hill with the clutch pedal partially engaged. This will cause abnormal wear on the clutch.

Never shift into REVERSE until the vehicle has come to a complete stop.

**NOTE:** During cold weather, until the transaxle lubricant is warm, you may experience slightly higher shift efforts. This is normal and not harmful to the transaxle.

### 2.4 Liter Turbo— If Equipped

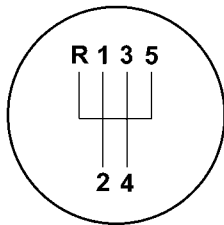

807bc54

The neutral position of the shift lever is located between THIRD and FOURTH gear. This is the position the shifter lever will return to automatically when neutral is selected. When shifting into FIFTH gear, be sure to press the shifter lever all the way to the right to avoid accidentally selecting THIRD gear. Also, use care when selecting FIRST gear to avoid accidentally selecting REVERSE.

When moving the shifter lever into REVERSE press the lever to the left until the resistance is overcome. When the ignition switch is in the ON position, a chime will sound to confirm that reverse has been selected and the backup lights will illuminate.

**NOTE:** Listen for the audible chime to confirm REVERSE gear is properly selected. Never shift into REVERSE until the vehicle has come to a complete stop.

#### Recommended Shift Speeds

To use your manual transaxle for optimal fuel economy, it should be upshifted as listed in table 1.

TABLE 1-MANUAL TRANSAXLE NORMAL ACCELERATION AND CRUISE SHIFT SPEEDS				
IN mph (km/h)				
ENGINE SIZE	1 to 2	2 to 3	3 to 4	4 to 5
<b>2.4L</b>	15 (24)	25 (40)	33 (53)	44 (70)

For improved performance, your manual transaxle may be upshifted up to the maximum speeds listed in table 2 (within legal speed limits).

TABLE 2-MANUAL TRANSAXLE MAXIMUM PERFORMANCE SHIFT SPEEDS				
IN mph (km/h)				
ENGINE SIZE	1 to 2	2 to 3	3 to 4	4 to 5
2.4L	30 (48)	60 (97)	85 (136)	115 (185)

If you exceed these speeds, you may notice the engine cut in and out. This is caused by an electronic limiter in the engine computer. The engine will run normally when you reduce engine speed.

### Downshifting

Proper downshifting will improve fuel economy and prolong engine life.

### CAUTION!

**If you skip more than one gear while downshifting or downshift at too high an engine speed, you could damage the engine, transmission, or clutch.**

5

To maintain a safe speed and prolong brake life, shift down to 2nd or 1st when descending a steep grade.

When turning a corner, or driving up a steep grade, downshift early so that the engine will not be overburdened.

**PARKING BRAKE**

When the parking brake is applied with the ignition on, the Brake Light in the instrument cluster will come on.

**NOTE:** This light only shows that the parking brake is on. It does not show the degree of brake application.

If the parking brake is applied while the vehicle is moving, a chime will sound to alert the driver. The chime will sound up to 10 times or until the vehicle has returned to a stop.

Before leaving the vehicle, make sure that the parking brake is set. To set the parking brake, pull up firmly on the lever. Also place the gear selector in the Park position (automatic transaxle) or Reverse (manual transaxle). To release the parking brake, apply the brake pedal, pull up

slightly on the lever, then depress the button on the end of the lever and push the lever fully down toward the floor.

**NOTE:** The parking brake lever will not release unless the lever is pulled up slightly past its applied position.

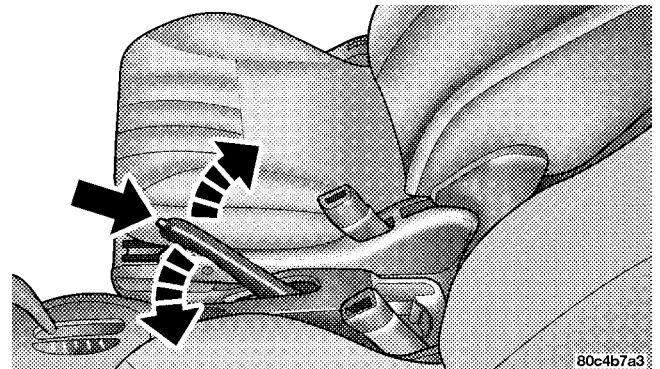

80c4b7a3



When parking on a hill, it is important to set the parking brake before placing the gear selector in Park, otherwise the load on the automatic transaxle locking mechanism may make it difficult to move the selector out of Park. As an added precaution, turn the front wheels toward the curb on a downhill grade and away from the curb on an uphill grade.

You should always apply the parking brake before leaving the vehicle.

**WARNING!**

- **Leaving children in a vehicle unattended is dangerous for a number of reasons. A child or others could be injured. Children should be warned not to touch the parking brake or the gear selector. Don't leave the keys in the ignition. A child could operate power windows, other controls, or move the vehicle.**
- **Be sure the parking brake is fully disengaged before driving; failure to do so can lead to brake failure and an accident.**

**BRAKE SYSTEM**

Your vehicle is equipped with power assisted brakes as standard equipment. In the event power assist is lost for any reason (for example, repeated brake applications with the engine off), the brakes will still function. However, the effort required to brake the vehicle will be much greater than that required with the power system operating.

**WARNING!**

**Riding the brakes can lead to brake failure and possibly an accident. Driving with your foot resting or riding on the brake pedal can result in abnormally high brake temperatures, excessive lining wear, and possible brake damage. You wouldn't have your full braking capacity in an emergency.**

If either of the two hydraulic systems lose normal capability, the remaining system will still function with some loss of overall braking effectiveness. This will be evident by increased pedal travel during application and greater pedal force required to slow or stop. In addition, if the malfunction is caused by an internal leak, as the brake fluid in the master cylinder drops, the brake warning indicator will light.

**Anti-Lock Brake System (ABS) — If Equipped**

The ABS gives increased vehicle stability and brake performance under most braking conditions. The system automatically “pumps” the brakes during severe braking conditions to prevent wheel lock up.

All vehicle wheels and tires must be the same size and tires must be properly inflated to produce accurate signals for the computer. However, the system will compensate when the compact spare is in use.

During stops where ABS is activated, a vibration of the brake pedal may be felt and associated system noises may be heard.

**NOTE:** Pumping of the brake pedal will diminish the effectiveness of Anti-lock brakes and may lead to an accident. Pumping makes the stopping distance longer. Just press firmly on your brake pedal when you need to slow down or stop.

**WARNING!**

- **Anti-lock system (ABS) cannot prevent the natural laws of physics from acting on the vehicle, nor can it increase braking or steering efficiency beyond that afforded by the condition of the vehicle brakes and tires or the traction afforded.**
- **The ABS cannot prevent accidents, including those resulting from excessive speed in turns, following another vehicle too closely, or hydroplaning. Only a safe, attentive, and skillful driver can prevent accidents.**
- **The capabilities of an ABS equipped vehicle must never be exploited in a reckless or dangerous manner which could jeopardize the user's safety or the safety of others.**

**POWER ASSISTED STEERING**

The power assisted steering system of your vehicle provides mechanical steering capability in the event power assist is lost.

If for some reason the hydraulic pressure is interrupted, it will still be possible to steer your vehicle. Under these conditions you will observe a substantial increase in steering effort.

**TRACTION CONTROL — IF EQUIPPED**

The Traction Control System will improve acceleration and steering on slippery surfaces by reducing tire spin. The system reduces wheel slip and maintains traction at the driving (front) wheels by engaging the brake on the wheel that is losing traction. When this occurs the TRAC indicator light located above the instrument cluster odometer will flash. The system operates at speeds below 40 mph (64 km/h).

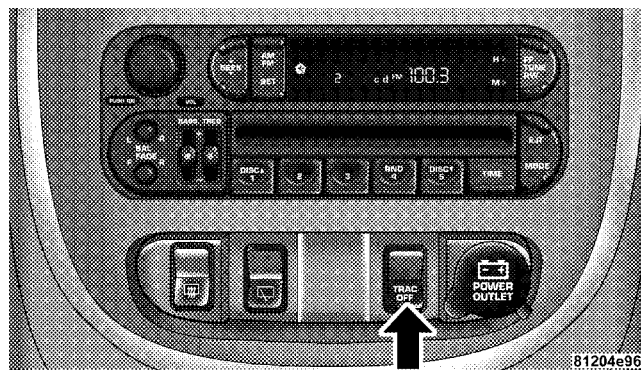

A push-button at the center of the instrument panel, below the radio, turns the Traction Control System ON or OFF.

The system is always in the “ON” mode unless:

- The TRAC OFF switch has been used to turn the system off;

- There is a Anti-Lock Brake System malfunction;
- There is a Traction Control System malfunction;
- The system has been automatically deactivated to prevent damage to the brake system due to overheated brake temperatures.

**NOTE:** Extended heavy use of Traction Control may cause the system to deactivate and turn on the TRAC OFF Light located in the instrument cluster.

This is to prevent overheating of the brake system and is a normal condition. The system will remain disabled for about 4 minutes until the brakes have cooled. The system will automatically reactivate and turn off the TRAC OFF light.

If your vehicle becomes stuck in mud, ice, or snow, turn the Traction Control System Off before attempting to “rock” the vehicle free.

## TIRE SAFETY INFORMATION

### Tire Markings

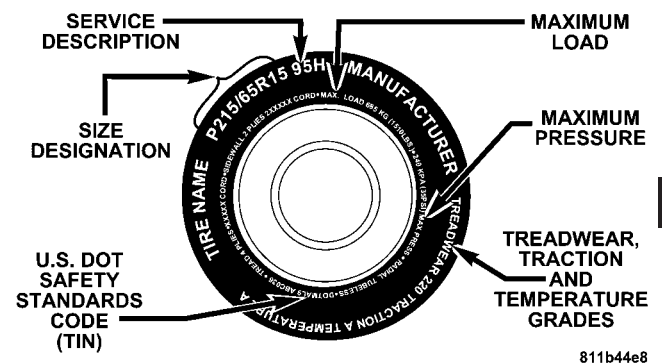

### NOTE:

- P (Passenger)-Metric tire sizing is based on U.S. design standards. P-Metric tires have the letter “P” molded into the sidewall preceding the size designation. Example: P215/65R15 95H.

- European Metric tire sizing is based on European design standards. Tires designed to this standard have the tire size molded into the sidewall beginning with the section width. The letter "P" is absent from this tire size designation. Example: 215/65R15 96H
- LT(Light Truck)-Metric tire sizing is based on U.S. design standards. The size designation for LT-Metric tires is the same as for P-Metric tires except for the letters "LT" that are molded into the sidewall preceding the size designation. Example: LT235/85R16.
- Temporary Spare tires are high pressure compact spares designed for temporary emergency use only. Tires designed to this standard have the letter "T" molded into the sidewall preceding the size designation. Example: T145/80D18 103M.
- High Flotation tire sizing is based on U.S. design standards and begins with the tire diameter molded into the sidewall. Example: 31x10.5 R15 LT.

## Tire Sizing Chart

<b>EXAMPLE:</b>	
<b>Size Designation:</b>	
<b>P</b> = Passenger car tire size based on U.S. design standards	
<b>"...blank..."</b> = Passenger car tire based on European design standards	
<b>LT</b> = Light Truck tire based on U.S. design standards	
<b>T</b> = Temporary Spare tire	
<b>31</b> = Overall Diameter in Inches (in)	
<b>215</b> = Section Width in Millimeters (mm)	
<b>65</b> = Aspect Ratio in Percent (%)	
	—Ratio of section height to section width of tire.
<b>10.5</b> = Section Width in Inches (in)	
<b>R</b> = Construction Code	
	—"R" means Radial Construction.
	—"D" means Diagonal or Bias Construction.
<b>15</b> = Rim Diameter in Inches (in)	

<b>EXAMPLE:</b>	
<b>Service Description:</b>	
<b>95 = Load Index</b>	—A numerical code associated with the maximum load a tire can carry.
<b>H = Speed Symbol</b>	—A symbol indicating the range of speeds at which a tire can carry a load corresponding to its load index under certain operating conditions. —The maximum speed corresponding to the Speed Symbol should only be achieved under specified operating conditions. (ie. tire pressure, vehicle loading, road conditions and posted speed limits).
<b>Load Identification:</b>	
<b>"...blank..." = Absence of any text on sidewall of the tire indicates a Standard Load (SL) Tire</b>	
<b>Extra Load (XL) = Extra Load (or Reinforced) Tire</b>	
<b>Light Load = Light Load Tire</b>	
<b>C,D,E = Load range associated with the maximum load a tire can carry at a specified pressure</b>	
<b>Maximum Load</b> — Maximum Load indicates the maximum load this tire is designed to carry.	
<b>Maximum Pressure</b> — Maximum Pressure indicates the maximum permissible cold tire inflation pressure for this tire.	



**Tire Identification Number (TIN)**

The TIN may be found on one or both sides of the tire however the date code may only be on one side. Tires with white sidewalls will have the full TIN including date code located on the white sidewall side of the tire.

Look for the TIN on the outboard side of black sidewall tires as mounted on the vehicle. If the TIN is not found on the outboard side then you will find it on the inboard side of the tire.

<b>EXAMPLE:</b>
<b>DOT MA L9 ABCD 0301</b>
<b>DOT</b> = Department of Transportation —This symbol certifies that the tire is in compliance with the U.S. Department of Transportation tire safety standards, and is approved for highway use.
<b>MA</b> = Code representing the tire manufacturing location.(2 digits)
<b>L9</b> = Code representing the tire size.(2 digits)
<b>ABCD</b> = Code used by tire manufacturer.(1 to 4 digits)
<b>03</b> = Number representing the week in which the tire was manufactured.(2 digits) —03 means the 3rd week.
<b>01</b> = Number representing the year in which the tire was manufactured.(2 digits) —01 means the year 2001. —Prior to July 2000, tire manufacturers were only required to have 1 number to represent the year in which the tire was manufactured. Example: 031 could represent the 3rd week of 1981 or 1991.

### Tire Loading and Tire Pressure

#### Tire Placard Location

**NOTE:** Some vehicles have a “Tire and Loading Information” placard located on the driver’s side “B” pillar.

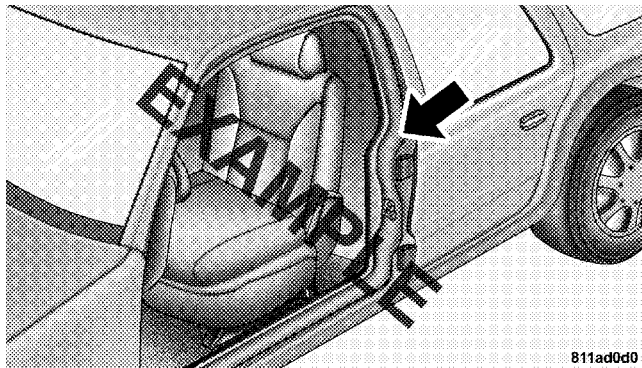

### Tire and Loading Information Placard

**TIRE AND LOADING INFORMATION**

SEATING CAPACITY - TOTAL 5 FRONT 2 REAR 3

THE COMBINED WEIGHT OF OCCUPANTS AND CARGO SHOULD NEVER EXCEED XXX KG OR XXX LBS.

TIRE	FRONT	REAR	SPARE
ORIGINAL TIRE SIZE	P195/70R14	P195/70R14	T125/70D15
COLD TIRE INFLATION PRESSURE	200kPa, 29PSI	200kPa, 29PSI	420kPa, 60PSI

SEE OWNER'S MANUAL FOR ADDITIONAL INFORMATION

4N109268

811b5a9a

This placard tells you important information about the,

- 1) number of people that can be carried in the vehicle
- 2) the total weight your vehicle can carry
- 3) the tire size designed for your vehicle
- 4) the cold tire inflation pressures for the front, rear and spare tires.

**Loading**

The vehicle maximum load on the tire must not exceed the load carrying capacity of the tire on your vehicle. You will not exceed the tire's load carrying capacity if you adhere to the loading conditions, tire size and cold tire inflation pressures specified on the Tire and Loading Information placard and the Vehicle Loading section of this manual.

**NOTE:** Under a maximum loaded vehicle condition, gross axle weight ratings (GAWR's) for the front and rear axles must not be exceeded. For further information on GAWR's, vehicle loading and trailer towing, see the Vehicle Loading section of this manual.

To determine the maximum loading conditions of your vehicle, locate the statement "The combined weight of occupants and cargo should never exceed XXX kg or XXX lbs." on the Tire and Loading Information placard. The combined weight of occupants, cargo/luggage and trailer tongue weight (if applicable) should never exceed the weight referenced here.

**Steps for Determining Correct Load Limit**

1. Locate the statement "The combined weight of occupants and cargo should never exceed XXX pounds" on your vehicle's placard.
2. Determine the combined weight of the driver and passengers that will be riding in your vehicle.

3. Subtract the combined weight of the driver and passengers from XXX kilograms or XXX pounds.
4. The resulting figure equals the available amount of cargo and luggage load capacity. For example, if "XXX" amount equals 1400 lbs. and there will be five 150 lb. passengers in your vehicle, the amount of available cargo and luggage load capacity is 650 lb. (1400-750 (5 x 150) = 650 lb.)
5. Determine the combined weight of luggage and cargo being loaded on the vehicle. That weight may not safely exceed the available cargo and luggage load capacity calculated in step 4.

6. If your vehicle will be towing a trailer, load from your trailer will be transferred to your vehicle. Consult this manual to determine how this reduces the available cargo and luggage load capacity of your vehicle.

**NOTE:** The following table shows examples on how to calculate total load, cargo/luggage and towing capacities of your vehicle with varying seating configurations and number and size of occupants. This table is for illustration purposes only and may not be accurate for the seating and load carry capacity of your vehicle.

**NOTE:** For the following example the combined weight of occupants and cargo should never exceed 865 lbs. (392 Kg).

Occupants			Combined weight of occupants and cargo from Tire Placard	MINUS	Combined Occupant's weight	=	AVAILABLE Cargo/Luggage and Trailer Tongue Weight
TOTAL	FRONT	REAR					
<u>EXAMPLE 1</u>			865 lbs	minus	Occupant 1: 200 lbs Occupant 2: 130 lbs Occupant 3: 160 lbs Occupant 4: 100 lbs Occupant 5: 80 lbs TOTAL WEIGHT: 670 lbs	=	195 lbs
5	2	3					
<u>EXAMPLE 2</u>			865 lbs	minus	Occupant 1: 210 lbs Occupant 2: 180 lbs Occupant 3: 150 lbs TOTAL WEIGHT: 540 lbs	=	325 lbs
3	2	1					
<u>EXAMPLE 3</u>			865 lbs	minus	Occupant 1: 200 lbs Occupant 2: 200 lbs TOTAL WEIGHT: 400 lbs	=	465 lbs
2	2	0					

811a4d11

**WARNING!**

Overloading of your tire is dangerous. Overloading can cause tire failure, affect vehicle handling, and increase your stopping distance. Use tires of the recommended load capacity for your vehicle. Never overload them.

**TIRES—GENERAL INFORMATION****Tire Pressure**

Proper tire inflation pressure is essential to the safe and satisfactory operation of your vehicle. Three primary areas are affected by improper tire pressure:

**1. Safety—****WARNING!**

Improperly inflated tires are dangerous and can cause accidents.

- Under inflation increases tire flexing and can result in tire failure.
- Over inflation reduces a tire's ability to cushion shock. Objects on the road and chuck holes can cause damage that results in tire failure.
- Unequal tire pressures can cause steering problems. You could lose control of your vehicle.
- Over inflated or under inflated tires can affect vehicle handling and can fail suddenly, resulting in loss of vehicle control.
- Unequal tire pressures from one side of the vehicle to the other can cause the vehicle to drift to the right or left.

Always drive with each tire inflated to the recommended cold tire inflation pressure.

### **2. Economy—**

Improper inflation pressures can cause uneven wear patterns to develop across the tire tread. These abnormal wear patterns will reduce tread life resulting in a need for earlier tire replacement. Underinflation also increases tire rolling resistance and results in higher fuel consumption.

### **3. Ride Comfort and Vehicle Stability—**

Proper tire inflation contributes to a comfortable ride. Overinflation produces a jarring and uncomfortable ride.

#### **Tire Inflation Pressures**

The proper cold tire inflation pressure for passenger cars is listed on either the face of the driver's door or the driver's side "B" pillar. For vehicles other than passenger cars, the cold tire inflation pressures are listed on either the "B" pillar, the Certification Label or in the Tire Inflation Pressures brochure in the glove compartment.

Some vehicles may have Supplemental Tire Pressure Information for vehicle loads that are less than the maximum loaded vehicle condition. These pressure conditions will be found in the "Supplemental Tire Pressure Information" section of this manual.

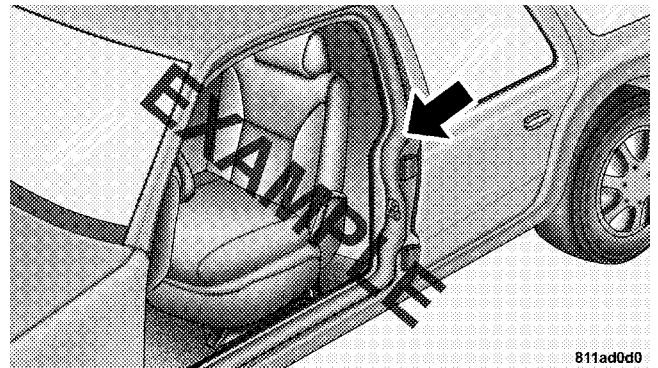

**"B" PILLAR**

The pressure should be checked and adjusted as well as inspecting for signs of tire wear or visible damage at least once a month. Use a good quality pocket-type gauge to check tire pressure. Do not make a visual judgement when determining proper inflation. Radial tires may look properly inflated even when they are underinflated.

**CAUTION!**

**After inspecting or adjusting the tire pressure always reinstall the valve stem cap—if equipped. This will prevent moisture and dirt from entering the valve stem, which could damage the valve stem.**

Inflation pressures specified on the placard are always “cold tire inflation pressure”. Cold tire inflation pressure is defined as the tire pressure after the vehicle has not been driven for at least 3 hours, or driven less than 1 mile

(1 km) after a 3 hour period. The cold tire inflation pressure must not exceed the maximum inflation pressure molded into the tire side wall.

Check tire pressures more often if subject to a wide range of outdoor temperatures, as tire pressures vary with temperature changes.

Tire pressures change by approximately 1 psi (7 kPa) per 12° F (7° C) of air temperature change. Keep this in mind when checking tire pressure inside a garage especially in the winter.

Example: If garage temperature = 68° F (20° C) and the outside temperature = 32° F (0° C) then the cold tire inflation pressure should be increased by 3 psi (21 kPa), which equals 1 psi (7 kPa) for every 12° F (7° C) for this outside temperature condition.



Tire pressure may increase from 2 to 6 psi (13 to 40 kPa) during operation. DO NOT reduce this normal pressure build up or your tire pressure will be too low.

#### **Tire Pressures for High Speed Operation**

The manufacturer advocates driving at safe speeds within posted speed limits. Where speed limits or conditions are such that the vehicle can be driven at high speeds, maintaining correct tire inflation pressure is very important. Increased tire pressure and reduced vehicle loading may be required for high speed vehicle operation. Refer to original equipment or an authorized tire dealer for recommended safe operating speeds, loading and cold tire inflation pressures.

#### **WARNING!**

**High speed driving with your vehicle under maximum load is dangerous. The added strain on your tires could cause them to fail. You could have a serious accident. Don't drive a vehicle loaded to the maximum capacity at continuous speeds above 75 mph (120 km/h).**

### Radial-Ply Tires

**WARNING!**

**Combining radial ply tires with other types of tires on your vehicle will cause your vehicle to handle poorly. The instability could cause an accident. Always use radial ply tires in sets of four (or 6, in case of trucks with dual rear wheels). Never combine them with other types of tires.**

Cuts and punctures in radial tires are repairable only in the tread area because of sidewall flexing. Consult your authorized tire dealer for radial tire repairs.

### Compact Spare Tire — If Equipped

The compact spare is for temporary emergency use with radial tires. It is engineered to be used on your style vehicle only. Since this tire has limited tread life, the original tire should be repaired (or replaced) and reinstalled at the first opportunity.

**WARNING!**

**Temporary use spare tires are for emergency use only. With these tires, do not drive more than 50 mph (80 km/h). Temporary-use spare tires have limited tread life. When two or more tread wear indicators appear in adjacent grooves, the temporary use spare tire needs to be replaced. Be sure to follow the warnings which apply to your spare. Failure to do so could result in spare tire failure and loss of vehicle control.**

Do not install a wheel cover or attempt to mount a conventional tire on the compact spare wheel, since the wheel is designed specifically for the compact spare.

Do not install more than one compact spare tire/wheel on the vehicle at any given time.

**CAUTION!**

**Because of the reduced ground clearance, do not take your vehicle through an automatic car wash with the compact spare installed. Damage to the vehicle may result.**

**Tire Spinning**

When stuck in mud, sand, snow, or ice conditions, do not spin your vehicle's wheels above 35 mph (55 km/h).

See the paragraph on Freeing A Stuck Vehicle in Section 6 of this manual.

**WARNING!**

**Fast spinning tires can be dangerous. Forces generated by excessive wheel speeds may cause tire damage or failure. A tire could explode and injure someone. Do not spin your vehicle's wheels faster than 35 mph (55 km/h) when you are stuck. And don't let anyone near a spinning wheel, no matter what the speed.**

### Tread Wear Indicators

Tread wear indicators are in the original equipment tires to help you in determining when your tires should be replaced.

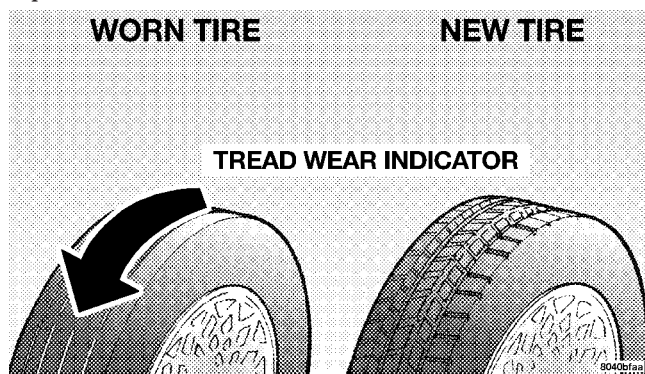

These indicators are molded into the bottom of the tread grooves and will appear as bands when the tread depth becomes 1/16 inch (2 mm). When the indicators appear in 2 or more adjacent grooves, the tire should be replaced.

Many states have laws requiring tire replacement at this point.

### Replacement Tires

The tires on your new vehicle provide a balance of many characteristics. They should be inspected regularly for wear and correct cold tire inflation pressure. The manufacturer strongly recommends that you use tires equivalent to the originals in size, quality and performance when replacement is needed (see the paragraph on tread wear indicators). Refer to the Tire and Loading Information placard for the size designation of your tire. The service description and load identification will be found on the original equipment tire. Failure to use equivalent replacement tires may adversely affect the safety, handling, and ride of your vehicle. We recommend that you contact your original equipment or an authorized tire dealer with any questions you may have on tire specifications or capability.

**WARNING!**

- Do not use a tire, wheel size or rating other than that specified for your vehicle. Some combinations of unapproved tires and wheels may change suspension dimensions and performance characteristics, resulting in changes to steering, handling, and braking of your vehicle. This can cause unpredictable handling and stress to steering and suspension components. You could lose control and have an accident resulting in serious injury or death. Use only the tire and wheel sizes with load ratings approved for your vehicle.
- Never use a tire with a smaller load index or capacity, other than what was originally equipped on your vehicle. Using a tire with a smaller load index could result in tire overloading and failure. You could lose control and have an accident.
- Failure to equip your vehicle with tires having adequate speed capability can result in sudden tire failure and loss of vehicle control.

**CAUTION!**

Replacing original tires with tires of a different size may result in false speedometer and odometer readings.

**Alignment And Balance**

Poor suspension alignment may result in:

- Fast tire wear.
- Uneven tire wear, such as feathering and one-sided wear.
- Vehicle pull to right or left.

Tires may also cause the vehicle to pull to the left or right. Alignment will not correct this condition. See your dealer for proper diagnosis.

Improper alignment will not cause vehicle vibration. Vibration may be a result of tire and wheel out-of-balance. Proper balancing will reduce vibration and avoid tire cupping and spotty wear.

**TIRE CHAINS**

Due to limited clearance, tire chains are not recommended.

**CAUTION!**

**Damage to the vehicle may result if tire chains are used.**

**SNOW TIRES**

Some areas of the country require the use of snow tires during winter. Standard tires are of the all season type and satisfy this requirement as indicated by the M+S designation on the tire side wall.

If you need snow tires, select tires equivalent in size and type to the original equipment tires. Use snow tires only in sets of 4, failure to do so may adversely affect the safety and handling of your vehicle.

Snow tires generally have lower speed ratings than what was originally equipped with your vehicle and should not be operated at sustained speeds over 75 mph (120 km/h).

### Tire Rotation Recommendations

Tires on the front and rear axles of vehicles operate at different loads and perform different steering, driving and braking functions. For these reasons, they wear at unequal rates, and tend to develop irregular wear patterns.

These effects can be reduced by timely rotation of tires. The benefits of rotation are especially worthwhile with aggressive tread designs such as those on all season type tires. Rotation will increase tread life, help to maintain mud, snow and wet traction levels, and contribute to a smooth, quiet ride.

Follow the recommended tire rotation frequency for your type of driving found in the "Maintenance Schedules" Section of this manual. More frequent rotation is permissible if desired. The suggested rotation method is the "forward-cross" shown in the diagram.

### TIRE ROTATION PATTERN

← FRONT OF VEHICLE

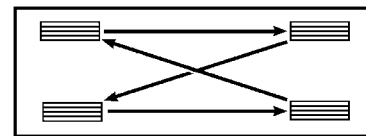

4 TIRE ROTATION

## FUEL REQUIREMENTS

### 2.4L Standard Engine and 2.4L Standard Turbo Engine



Your vehicle is designed to meet all emission regulations and provide excellent fuel economy when using high quality regular unleaded gasoline with an octane rating of 87. The use of premium gasoline is not recommended. The use of premium gasoline will provide no benefit over high quality regular gasolines, and in some circumstances, may result in poorer performance.

### 2.4L High Output Turbo Engine



Your engine is designed to meet all emission regulations and provide excellent fuel economy and performance when using high quality unleaded gasoline having an octane rating of 91. The purchase of higher octane is not required.

The use of high quality unleaded gasoline having an octane rating of 91 is recommended but not required. High quality unleaded gasoline having a minimum octane rating of 87 may safely be used for your vehicle. Use of these lower octane gasolines, however, may result in reduced acceleration performance.

Light spark knock at low engine speeds is not harmful to your engine. However, continued heavy spark knock at high speeds can cause damage and immediate service is required. Engine damage resulting from operating with a heavy spark knock may not be covered by the new vehicle warranty.

Poor quality gasoline can cause problems such as hard starting, stalling and hesitations. If you experience these symptoms, try another brand of gasoline (with the appropriate octane rating for your engine) before considering service for the vehicle.



Over 40 automobile manufacturers around the world have issued and endorsed consistent gasoline specifications (the World Wide Fuel Charter, WWFC) to define fuel properties necessary to deliver enhanced emissions, engine performance, and durability for your vehicle. The manufacturer recommends the use of gasolines that meet the WWFC specifications if they are available.

#### **Reformulated Gasoline**

Many areas of the country require the use of cleaner burning gasoline referred to as "Reformulated Gasoline".

Reformulated gasolines contain oxygenates, and are specifically blended to reduce vehicle emissions and improve air quality.

The manufacturer supports the use of reformulated gasolines. Properly blended reformulated gasolines will provide excellent performance and durability of engine and fuel system components.

#### **Gasoline/Oxygenate Blends**

Some fuel suppliers blend unleaded gasoline with oxygenates such as 10% ethanol, MTBE, and ETBE. Oxygenates are required in some areas of the country during the winter months to reduce carbon monoxide emissions. Fuels blended with these oxygenates may be used in your vehicle.

#### **CAUTION!**

**DO NOT use gasolines containing Methanol. Use of these blends may result in starting and driveability problems and may damage critical fuel system components.**

Problems that result from using methanol/gasoline blends are not the responsibility of the manufacturer and

may not be covered by the vehicle warranty. While MTBE is an oxygenate made from Methanol, it does not have the negative effects of Methanol.

#### **MMT In Gasoline**

MMT is a manganese containing metallic additive that is blended into some gasoline to increase the octane number. Gasolines blended with MMT offer no performance advantage beyond gasolines of the same octane number without MMT. Gasolines blended with MMT have shown to reduce spark plug life and reduce emission system performance in some vehicles. The manufacturer recommends using gasolines without MMT. Since the MMT content of gasoline may not be indicated on the pump, you should ask your gasoline retailer whether or not his/her gasoline contains MMT.

It is even more important to look for gasolines without MMT in Canada, because MMT can be used at levels higher than those allowed in the United States.

MMT is prohibited in Federal and California reformulated gasolines.

#### **Sulfur In Gasoline**

Your vehicle may have been designed to meet California low emission standards with cleaner burning California reformulated gasoline with low sulfur. This vehicle may be sold nationwide. Your vehicle will operate satisfactorily on fuels meeting Federal specification, but emission control system performance may be adversely affected.

Gasoline sold outside of California is permitted to have higher sulfur levels which may affect the performance of the vehicle's catalytic converter. This may cause the Malfunction Indicator light to illuminate. The manufacturer recommends that you try a different brand of unleaded gasoline having lower sulfur to determine if the problem is fuel related prior to returning your vehicle to an authorized dealer for service.

**CAUTION!**

If the Malfunction Indicator light is flashing, immediate service is required. See the paragraph on the Onboard Diagnostics System in section 7 of this manual.

**Materials Added to Fuel**

All gasoline sold in the United States is required to contain effective detergent additives. Use of additional detergents or other additives is not needed under normal conditions and would result in additional cost. Therefore you should not have to add anything to the fuel.

**Fuel System Cautions****CAUTION!**

Follow these guidelines to maintain your vehicle's performance:

- The use of leaded gas is prohibited by Federal law. Using leaded gasoline can impair engine performance, damage the emission control system, and could result in loss of warranty coverage.
- An out-of-tune engine, or certain fuel or ignition malfunctions, can cause the catalytic converter to overheat. If you notice a pungent burning odor or some light smoke, your engine may be out of tune or malfunctioning and may require immediate service. Contact your dealer for service assistance.

- The use of fuel additives which are now being sold as octane enhancers is not recommended. Most of these products contain high concentrations of methanol. Fuel system damage or vehicle performance problems resulting from the use of such fuels or additives is not the responsibility of the manufacturer and may not be covered under the New Vehicle Warranty.

**NOTE:** Intentional tampering with emissions control systems can result in civil penalties being assessed against you.

#### Carbon Monoxide Warnings

<b>WARNING!</b>
<b>Carbon monoxide (CO) in exhaust gases is deadly. Follow the precautions below to prevent carbon monoxide poisoning:</b>

- Do not inhale exhaust gases. They contain carbon monoxide, a colorless and odorless gas which can kill. Never run the engine in a closed area, such as a garage, and never sit in a parked vehicle with the engine running for an extended period. If the vehicle is stopped in an open area with the engine running for more than a short period, adjust the ventilation system to force fresh, outside air into the vehicle.
- Guard against carbon monoxide with proper maintenance. Have the exhaust system inspected every time the vehicle is raised. Have any abnormal conditions repaired promptly. Until repaired, drive with all side windows fully open.
- Keep the liftgate closed when driving your vehicle to prevent carbon monoxide and other poisonous exhaust gases from entering the vehicle.

**ADDING FUEL**

The fuel tank filler tube has a restricting door about 2 inches (50 mm) inside the opening. If using a portable container, it should have a flexible nozzle long enough to force open the restricting door.

**Fuel Filler Cap (Gas Cap)**

The gas cap is behind the fuel filler door, on the passenger's side of the vehicle. If the gas cap is lost or damaged, be sure the replacement cap is for use with this vehicle.

**NOTE:** When removing the fuel filler cap, lay the cap tether in the hook, located on the fuel filler cap door reinforcement.

**CAUTION!**

Damage to the fuel system or emission control system could result from using an improper fuel tank filler tube cap (gas cap). A poorly fitting cap could let impurities into the fuel system.

**CAUTION!**

A poorly fitting gas cap may cause the Malfunction Indicator Light to turn on.

**CAUTION!**

To avoid fuel spillage and overfilling, do not “top off” the fuel tank after filling.

**NOTE:** When the fuel nozzle “clicks” or shuts off, the fuel tank is full.

**WARNING!**

- Remove the fuel tank filler tube cap (gas cap) slowly to prevent fuel spray from the filler neck which may cause injury.
- The volatility of some gasolines may cause a build up of pressure in the fuel tank that may increase while you drive. This pressure can result in a spray of gasoline and/or vapors when you remove the cap from a hot vehicle. Removing the cap slowly allows the pressure to vent and prevents fuel spray.
- Never have any smoking materials lit in or near the vehicle when the gas cap is removed or the tank filled.
- Never add fuel when the engine is running. This is in violation of most state and federal fire regulations and will cause the malfunction indicator light to turn on.

**NOTE:** Tighten the gas cap about 1/4 turn until you hear one click. This is an indication that cap is properly tightened.

If the gas cap is not tighten properly, the Malfunction Indicator Light will come on. Be sure the gas cap is tightened every time the vehicle is refueled.

**WARNING!**

**A fire may result if gasoline is pumped into a portable container that is inside of a vehicle. You could be burned. Always place gas containers on the ground while filling.**

**VEHICLE LOADING**

Vehicle Loading Capacities

Front Seat Occupants . . . . .	2
Rear Seat Occupants . . . . .	3
Luggage . . . . .	115 lbs (52 kg)
Rated Vehicle Capacity . . . . .	865 lb (392 kg)

**TRAILER TOWING**

In this section you will find safety tips and information on limits to the type of towing you can reasonably do with your vehicle. Before towing a trailer carefully review this information to tow your load as efficiently and safely as possible.

To maintain warranty coverage, follow the requirements and recommendations in this manual concerning vehicles used for trailer towing.

Perform maintenance services as prescribed in the maintenance schedules manual. When your vehicle is used for trailer towing, never exceed the gross axle weight rating (GAWR) by the addition of:

- The tongue weight of the trailer.
- The weight of any other type of cargo or equipment put in or on your vehicle.
- Remember that everything put in or on the trailer adds to the load on your vehicle.

#### Warranty Requirements

The Manufacturer's Passenger Vehicle Warranty will apply to vehicles used to tow trailers for non-commercial use. However the following conditions must be met:

- The maximum frontal area of the trailer cannot exceed 20 square feet (1.86 square meters).

- If using a manual transaxle vehicle for trailer towing, all starts must be in FIRST gear to avoid excessive clutch slippage.
- The trailer tongue load must be considered as part of the combined weight of occupants and cargo, and should never exceed the weight referenced on the Tire and Loading Information placard. Refer to the Tire-Safety Information Section in this manual.
- The "D" range can be selected when towing. However, if frequent shifting occurs while in this range, the "3" range must be selected.

**NOTE:** Using the "3" range while operating the vehicle under heavy operating conditions will improve performance and extend transaxle life by reducing excessive shifting and heat build up.



**WARNING!**

**Connecting trailer brakes to your vehicle's hydraulic brake lines can overload your brake system and cause it to fail. You might not have brakes when you need them and could have an accident.**

- Do not attempt to tow a trailer while using a compact spare tire.
- Whenever you pull a trailer, regardless of the trailer size, stop lights and turn signals on the trailer are recommended for motoring safety.
- The automatic transaxle fluid and filter should be changed if you REGULARLY tow a trailer for more than 45 minutes of continuous operation. See Schedule "B" in section 8 of this manual for transaxle fluid change intervals.

**NOTE:** Check the automatic transaxle fluid level before towing.

**NOTE:** For vehicles equipped with Autostick. By using the Autostick modes, and selecting a specific gear range, frequent shifting can be avoided. The highest gear range should be selected that allows for adequate performance. For example, choose "4" if the desired speed can be maintained. Choose "3" or "2" if needed to maintain the desired speed.

**NOTE:** Extended driving at high RPM should be avoided to prevent excess heat generation. A reduction in vehicle speed may be required to avoid extended driving at high RPM. Return to a higher gear range or vehicle speed when road conditions and RPM level allows.



---

## WHAT TO DO IN EMERGENCIES

### CONTENTS

---

■ Hazard Warning Flasher . . . . .	228	■ Driving On Slippery Surfaces . . . . .	238
■ If Your Engine Overheats . . . . .	228	□ Acceleration . . . . .	238
■ Jacking And Tire Changing . . . . .	230	□ Traction . . . . .	238
□ Jack Location . . . . .	231	■ Freeing A Stuck Vehicle . . . . .	239
□ Spare Tire Stowage . . . . .	231	■ Towing A Disabled Vehicle . . . . .	240
□ Preparations For Jacking . . . . .	232	□ With Ignition Key . . . . .	240
□ Jacking Instructions . . . . .	233	□ Without The Ignition Key . . . . .	241
■ Jump-Starting Procedures Due To A Low Battery . . . . .	235		

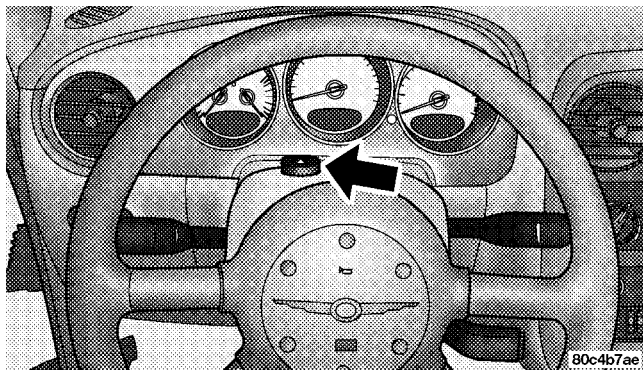
**HAZARD WARNING FLASHER**

 The flasher switch is on top of the steering column, just behind the steering wheel. Depress the switch and both cluster indicators and all front and rear directional signals will flash. Depress the switch again to turn Hazard Warning Flashers off.

Do not use this emergency warning system when the vehicle is in motion. Use it when your vehicle is disabled and is creating a safety hazard for other motorists.

If it is necessary to leave the vehicle to go for service, the flasher system will continue to operate with the ignition key removed and the vehicle locked.

**NOTE:** With extended use, the flasher may wear down your battery.

**IF YOUR ENGINE OVERHEATS**

In any of the following situations, you can reduce the potential for overheating by taking the appropriate action.

- On the highways — Slow down.
- In city traffic — While stopped, put transaxle in neutral, but do not increase engine idle speed.

If the pointer rises to the **H** (red) mark, the instrument cluster will sound a chime. Pull over and stop the vehicle. Idle the vehicle with the air conditioner turned off until the pointer drops back into the normal range. If the pointer remains on the H (red) mark, turn the engine off immediately and call for service.

**NOTE:** There are steps that you can take to slow down an impending overheat condition. If your air conditioner is on, turn it off. The air conditioning system adds heat to the engine cooling system and turning off the A/C removes this heat. You can also turn the Temperature control to maximum heat, the Mode control to floor, and the fan control to High. This allows the heater core to act as a supplement to the radiator and aids in removing heat from the engine cooling system.

**CAUTION!**

**Driving with a hot cooling system could damage your vehicle. If temperature gauge reads “H”, pull over and stop the vehicle. Idle the vehicle with the air conditioner turned off until the pointer drops back into the normal range. After appropriate action has been taken, if the pointer remains on the “H”, turn the engine off immediately, and call for service.**

**WARNING!**

A hot engine cooling system is dangerous. You or others could be badly burned by steam or boiling coolant. You may want to call a service center if your vehicle overheats. If you decide to look under the hood yourself, refer to Section 7, Maintenance, of this manual. Follow the warnings under the Cooling System Pressure Cap paragraph.

**JACKING AND TIRE CHANGING****WARNING!**

- Being under a jacked-up vehicle is dangerous. The vehicle could slip off the jack and fall on you. You could be crushed. Never put any part of your body under a vehicle that is on a jack. Never start or run the engine while the vehicle is on a jack. If you need to get under a raised vehicle, take it to a service center where it can be raised on a lift.
- The jack is designed to use as a tool for changing tires only. The jack should not be used to lift the vehicle for service purposes. The vehicle should be jacked on a firm level surface only. Avoid ice or slippery areas.

### Jack Location

The jack and jack-handle are stowed behind the right rear side trim panel in the cargo area.

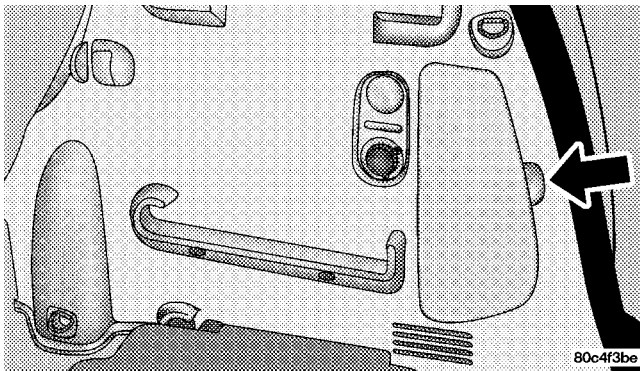

Do not attempt to raise this vehicle using a bumper jack.

### Spare Tire Stowage

The compact spare tire is stowed under the rear of the vehicle by means of a hook/basket mechanism. To remove or stow the compact spare, use the jack handle to rotate the "spare tire drive" nut. The nut is located under the rear scuff plate at the right rear of the cargo area, just inside the liftgate opening.

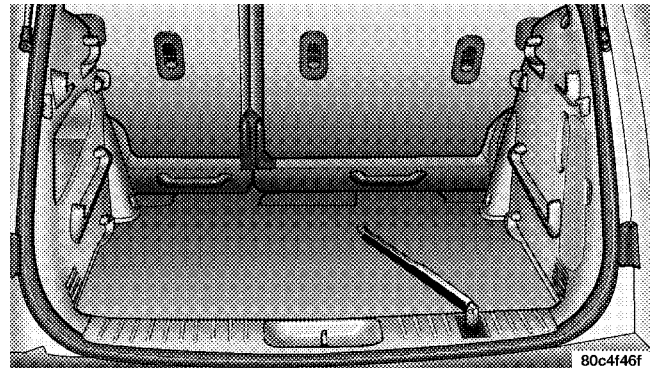

**Spare Tire Removal**

Lift up the cover and fit the jack-handle over the drive nut. Rotate the nut to the left until you can remove the swivel hook from the stowage basket. Swing the basket down to remove the compact spare tire.

**CAUTION!**

The hook is designed for use with the jack handle only. Use of an air wrench or other power tools is not recommended and can damage the winch.

**Preparations For Jacking**

Park the vehicle on a firm level surface, avoid ice or slippery areas, **set the parking brake** and place the gear selector in PARK (automatic transaxle) or REVERSE (manual transaxle). Turn OFF the ignition.

**WARNING!**

Do not attempt to change a tire on the side of the vehicle close to moving traffic. Pull far enough off the road to avoid the danger of being hit when operating the jack or changing the wheel.

- Turn on the Hazard Warning Flasher.

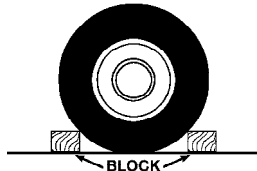

- Block both the front and rear of the wheel diagonally opposite the jacking position. For example, if changing the right front tire, block the left rear wheel.
- Passengers should not remain in the vehicle while the vehicle is being jacked.



### Jacking Instructions

1. Remove the scissors jack and lug wrench from the stowage bag.

**NOTE:** If equipped with a center cap that covers the wheel nuts, pry off the cap using the small end of the lug wrench. To reinstall the cap, make sure it is properly lined up before pushing it on to the wheel.

2. Loosen, but do not remove, the wheel nuts by turning them to the left one turn while the wheel is still on the ground.

3. There are two front jacking locations on each side of the body and rear jacking locations located on the trailing arm bracket under the triangular cut out symbol. Turn the jack screw to the right until the jack head is properly engaged with the lift area closest to the wheel to be changed.

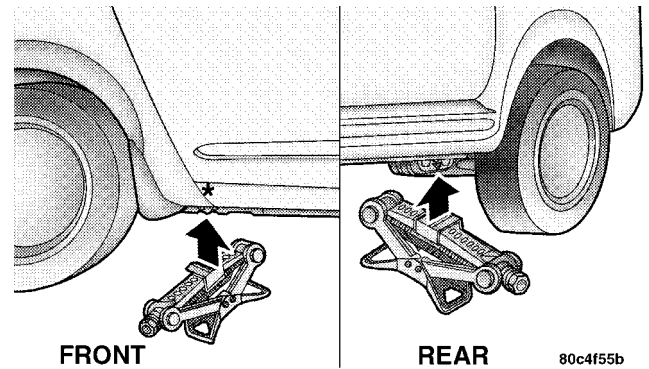

### CAUTION!

Do not attempt to raise the vehicle by jacking on the crossmember below the radiator, on the front suspension crossmember, or on the rear axle assembly.

Do not raise the vehicle until you are sure the jack is securely engaged.

4. Raise the vehicle by turning the jack screw to the right, using the swivel wrench. Raise the vehicle only until the tire just clears the surface and enough clearance is obtained to install the spare tire. Minimum tire lift provides maximum stability.

**WARNING!**

**Raising the vehicle higher than necessary can make the vehicle less stable. It could slip off the jack and hurt someone near it. Raise the vehicle only enough to remove the tire.**

5. Remove the wheel nuts and pull the wheel and wheel covers where applicable off the hub. Install the spare wheel and wheel nuts with the cone shaped end of the

nuts toward the wheel. Lightly tighten the nuts. To avoid the risk of forcing the vehicle off the jack, do not tighten the nuts fully until the vehicle has been lowered.

**WARNING!**

**To avoid possible personal injury, handle the wheel covers with care to avoid contact with any sharp edges.**

**NOTE:** The wheel cover is held on the wheel by the wheel nuts. When reinstalling original wheel, properly align the wheel cover to the valve stem, place the wheel cover onto the wheel, then install the wheel nuts.

6. Lower the vehicle by turning the jack screw to the left.

7. Finish tightening the nuts. Push down on the wrench while tightening the wheel nuts. Alternate nuts until each nut has been tightened twice. Correct wheel nut torque is

100 ft. lbs (135 N·m). If you doubt that you have tightened the nuts correctly, have them checked with a torque wrench by your dealer or at a service station.

8. Remove the wheel blocks and lower the jack until it is free. Stow the lug wrench, and jack in their designated location. Secure all parts using the means provided.

**WARNING!**

**A loose tire or jack thrown forward in a collision or hard stop could endanger the occupants of the vehicle. Always stow the jack parts and the spare tire in the places provided.**

9. Place the deflated (flat) tire in the cargo area, **have the tire repaired or replaced as soon as possible.**

**WARNING!**

**A loose tire thrown forward in a collision or hard stop could injure the occupants in the vehicle. Have the deflated (flat) tire repaired or replaced immediately.**

10. Check the tire pressure as soon as possible. Correct pressure as required.

**JUMP-STARTING PROCEDURES DUE TO A LOW BATTERY**

**6**

**WARNING!**

**Take care to avoid the radiator cooling fan whenever the hood is raised. It can start anytime the ignition switch is on. You can be hurt by the fan.**

**WARNING!**

**Do not attempt to push or tow your vehicle to get it started. Vehicles equipped with an automatic transaxle cannot be started this way. Unburned fuel could enter the catalytic converter and once the engine has started, ignite and damage the converter and vehicle. If the vehicle has a discharged battery, booster cables may be used to obtain a start from another vehicle. This type of start can be dangerous if done improperly, so follow this procedure carefully.**

1. Wear eye protection and remove any metal jewelry such as watch bands or bracelets that might make an inadvertent electrical contact.

2. When boosting from a battery in another vehicle, park that vehicle within booster cable reach but without letting the vehicles touch. Set parking brake, place automatic transaxle in PARK (manual transaxle in NEUTRAL) and turn ignition to OFF for both vehicles.

3. Turn off the heater, radio and all unnecessary electrical loads.

4. Connect one end of a jumper cable to the positive terminal of the booster battery. Connect the other end of the jumper cable to the positive jump start terminal, located near the Power Distribution Center, of the vehicle with the discharged battery.

**WARNING!**

Battery fluid is a corrosive acid solution; do not allow battery fluid to contact eyes, skin or clothing. Don't lean over battery when attaching clamps or allow the clamps to touch each other. If acid splashes in eyes or on skin, flush the contaminated area immediately with large quantities of water.

A battery generates hydrogen gas which is flammable and explosive. Keep flame or spark away from the vent holes. Do not use a booster battery or any other booster source with an output that exceeds 12 volts.

5. Connect the other cable, first to the negative terminal of the booster battery and then to the negative jump start terminal, located near the hood release latch, of the vehicle with the discharged battery. Make sure you have a good contact.

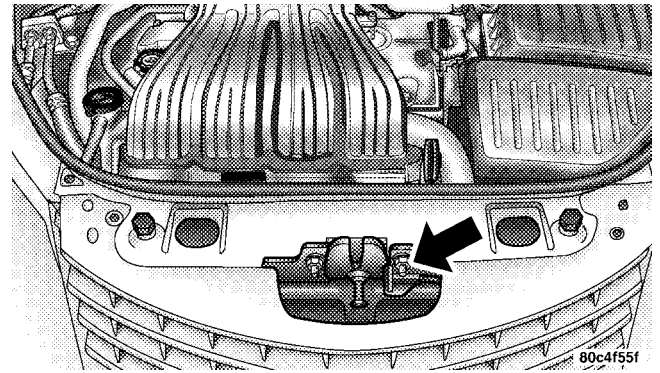

**Negative Jump Start**

6. If the vehicle is equipped with Sentry Key Immobilizer, turn the ignition switch to the ON position for 3 seconds before moving the ignition switch to the START position.

7. Start the engine in the vehicle that has the booster battery, let the engine idle a few minutes, then start the engine in the vehicle with the discharged battery.
8. When removing the jumper cables, reverse the sequence exactly. Be careful of the moving belts and fan.

## DRIVING ON SLIPPERY SURFACES

### Acceleration

Rapid acceleration on snow covered, wet, or other slippery surfaces may cause the front wheels to pull erratically to the right or left. This phenomenon occurs when there is a difference in the surface traction under the front (driving) wheels.

### WARNING!

**Rapid acceleration on slippery surfaces is dangerous. Unequal traction can cause sudden pulling of the front wheels. You could lose control of the vehicle and possibly have an accident. Accelerate slowly and carefully whenever there is likely to be poor traction (ice, snow, wet, mud, loose sand, etc.).**

### Traction

When driving on wet or slushy roads, it is possible for a wedge of water to build up between the tire and road surface. This is hydroplaning and may cause partial or complete loss of vehicle control and stopping ability. To reduce this possibility, the following precautions should be observed:

1. Slow down during rainstorms or when roads are slushy.

2. Slow down if road has standing water or puddles.
3. Replace tires when tread wear indicators first become visible.
4. Keep tires properly inflated.
5. Maintain enough distance between your vehicle and the vehicle in front of you to avoid a collision in a sudden stop.

#### **FREEING A STUCK VEHICLE**

**NOTE:** If your vehicle is equipped with Traction Control, turn the system OFF before attempting to “rock” the vehicle.

If your vehicle becomes stuck in mud, sand or snow, it can often be moved by a rocking motion. Turn your steering wheel right and left to clear the area around the front wheels. Then shift back and forth between Reverse and First gear. Usually the least accelerator pedal pressure to maintain the rocking motion without spinning the wheels is most effective.

#### **WARNING!**

**Fast spinning tires can be dangerous. Forces generated by excessive wheel speeds may cause tire damage or failure. A tire could explode and injure someone. Do not spin your vehicle's wheels faster than 35 mph (55km/h) when you are stuck. And don't let anyone near a spinning wheel, no matter what the speed.**

**CAUTION!**

**Racing the engine or spinning the wheels too fast may lead to transaxle overheating and failure. It can also damage the tires. Do not spin the wheels above 35 mph (55km/h).**

**TOWING A DISABLED VEHICLE****With Ignition Key****Four Speed Automatic Transaxle**

Your vehicle may be towed under the following conditions: The steering column must be unlocked and the

gear selector must be in NEUTRAL, the distance to be towed must not exceed 100 miles (160 km), and the towing speed must not exceed 44 mph (72 km/h). If the transaxle is not operative, or if the vehicle is to be towed more than 100 miles (160 km), the vehicle must be towed with the front wheels off the ground to avoid damage to the transaxle.

**Manual Transaxle**

Your vehicle may be towed if the gearshift lever is in NEUTRAL. If the transaxle is not operative, the vehicle must be towed with the front wheels off the ground.



**All Transaxles****CAUTION!**

**If the vehicle being towed requires steering, the ignition switch must be in the OFF position, not in the LOCK or ACCESSORY positions.**

**Do not attempt to use sling type equipment when towing. When securing vehicle to flat bed truck, do not attach to front or rear suspension components. Damage to your vehicle may result from improper towing.**

If it is necessary to use the accessories while being towed (wipers, defrosters, etc.), the key must be in the ON position, not the ACCESSORY position. Make certain the transaxle remains in NEUTRAL.

**Without The Ignition Key**

Special care must be taken when the vehicle is towed with the ignition in the LOCK position. A dolly should be used under the front wheels if the rear wheels are raised. Proper towing equipment is necessary to prevent damage to the vehicle.

**Towing This Vehicle Behind Another Vehicle (Flat Towing With All Four Wheels On The Ground)**

If your vehicle is equipped with a manual transaxle, it may be towed at any legal highway speed, for any distance, if the transaxle is in neutral.

If the ignition key is not available, vehicles with automatic transaxles can not be flat towed at any time.



---

## MAINTAINING YOUR VEHICLE

### CONTENTS

---

■ 2.4L High Output Turbo Engine Compartment . . .246	□ Drive Belts — Check Condition And Tension . . .256
■ 2.4L Engine Compartment . . . . .247	□ Spark Plugs . . . . .256
■ Onboard Diagnostic System — OBD II . . . . .248	□ Ignition Wiring System . . . . .256
■ Emissions Inspection And Maintenance Programs . . . . .249	□ Catalytic Converter . . . . .256
■ Replacement Parts . . . . .250	□ Engine Timing Belt . . . . .258
■ Dealer Service . . . . .250	□ Crankcase Emission Control System . . . . .258
■ Maintenance Procedures . . . . .251	□ Fuel Filter . . . . .258
□ Engine Oil . . . . .251	□ Air Cleaner Element (Filter) . . . . .258
	□ Maintenance-Free Battery . . . . .259

244 MAINTAINING YOUR VEHICLE

□ Air Conditioner . . . . .	261	□ Appearance Care And Protection From Corrosion . . . . .	276
□ Power Steering — Fluid Check . . . . .	261	■ Fuses . . . . .	282
□ Front Suspension Ball Joints . . . . .	262	□ Underhood Fuses (Power Distribution Center) . . . . .	282
□ Body Lubrication . . . . .	262	□ Interior Fuses . . . . .	285
□ Windshield Wiper Blades . . . . .	263	■ Vehicle Storage . . . . .	285
□ Windshield Washer Reservoir . . . . .	264	■ Replacement Bulbs . . . . .	286
□ Exhaust System . . . . .	264	■ Bulb Replacement . . . . .	287
□ Cooling System . . . . .	265	□ Headlight Bulb Replacement . . . . .	287
□ Hoses And Vacuum/Vapor Harnesses . . . . .	269	□ Front Park/Turn Signal/Side Marker Lights . . . . .	288
□ Fuel System Connections . . . . .	270	□ Front Fog Lights — If Equipped . . . . .	288
□ Brake System . . . . .	270	□ Tail/Stop, And Rear Turn Signal Lights . . . . .	288
□ Automatic Transaxle . . . . .	273	□ Back Up Light Bulb . . . . .	289
□ Manual Transaxle . . . . .	276		

<hr/>		<b>MAINTAINING YOUR VEHICLE 245</b>	
□ Center High Mounted Stop Light . . . . .	289	□ Engine . . . . .	291
■ Fluids And Capacities . . . . .	290	□ Chassis . . . . .	292
■ Recommended Fluids, Lubricants And Genuine Parts . . . . .	291		

### 2.4L HIGH OUTPUT TURBO ENGINE COMPARTMENT

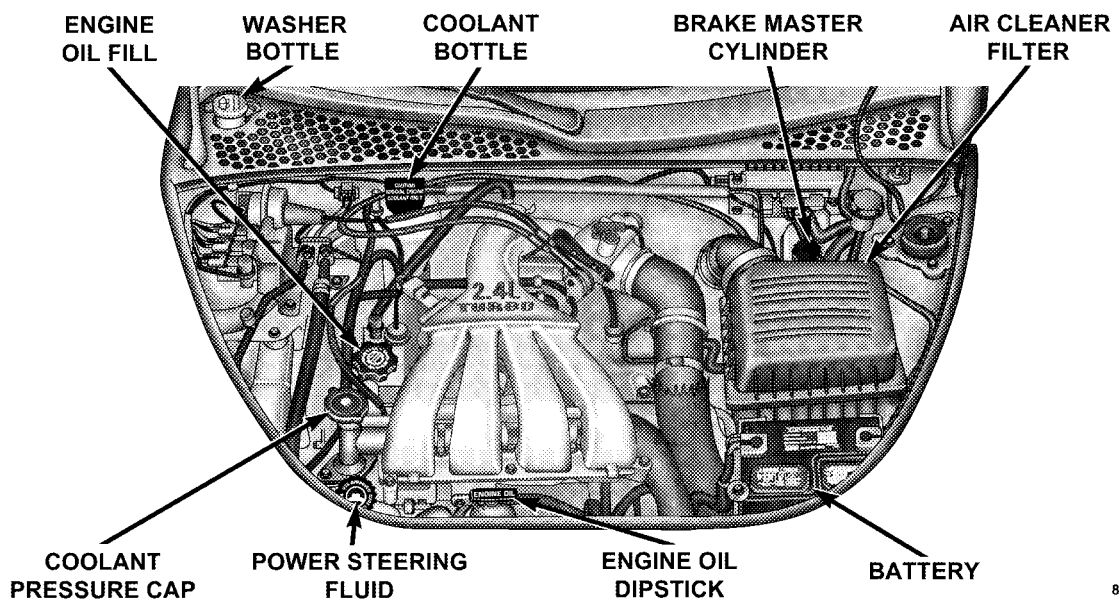

80f1075b

2.4L ENGINE COMPARTMENT

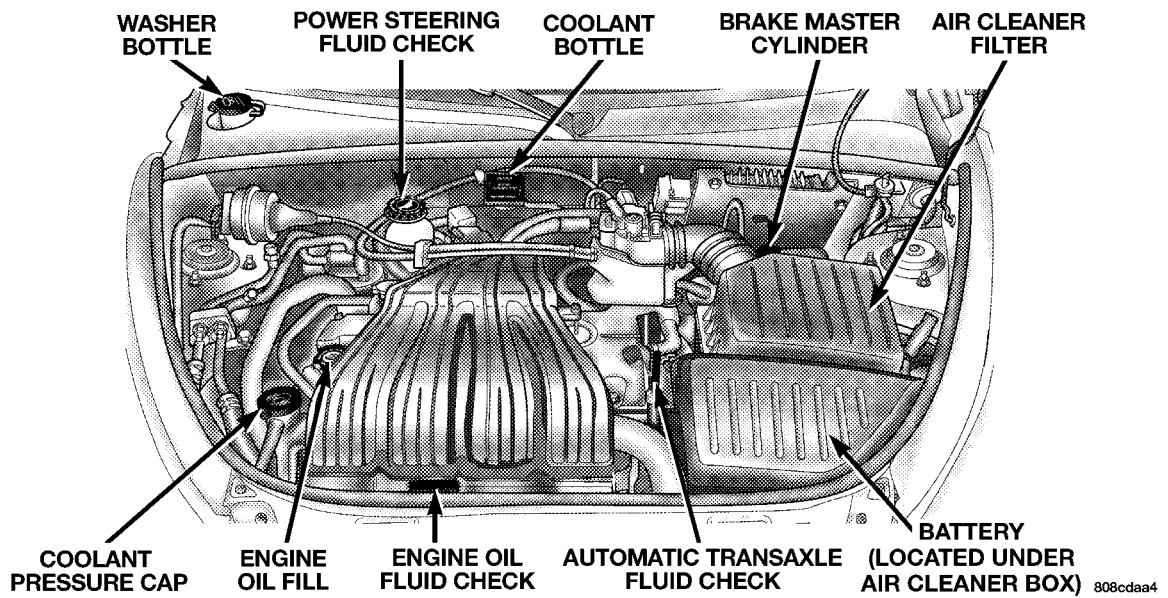

**ONBOARD DIAGNOSTIC SYSTEM — OBD II**

Your vehicle is equipped with a sophisticated onboard diagnostic system called OBD II. This system monitors the performance of the emissions, engine, and automatic transmission control systems. When these systems are operating properly, your vehicle will provide excellent performance and fuel economy, as well as engine emissions well within current government regulations.

If any of these systems require service, the OBD II system will turn on the “Malfunction Indicator Light.” It will also store diagnostic codes and other information to assist your service technician in making repairs. Although your vehicle will usually be drivable and not need towing, see your dealer for service as soon as possible.

**CAUTION!**

- **Prolonged driving with the “Malfunction Indicator Light” on could cause further damage to the emission control system. It could also affect fuel economy and driveability. The vehicle must be serviced before any emissions tests can be performed.**
- **If the “Malfunction Indicator Light” is flashing while the engine is running, severe catalytic converter damage and power loss will soon occur. Immediate service is required.**



### EMISSIONS INSPECTION AND MAINTENANCE PROGRAMS

In some localities, it may be a legal requirement to pass an inspection of your vehicle's emissions control system. Failure to pass could prevent vehicle registration.



For states which have an I/M (Inspection and Maintenance) requirement, this check verifies the following: the MIL (Malfunction Indicator Lamp) is functioning and is not on when the engine is running, and that the OBD (On Board Diagnostic) system is ready for testing.

Normally, the OBD system will be ready. The OBD system may **not** be ready if your vehicle was recently serviced, if you recently had a dead battery, or a battery replacement. If the OBD system should be determined not ready for the I/M test, your vehicle may fail the test.

Your vehicle has a simple ignition key actuated test which you can use prior to going to the test station. To check if your vehicle's OBD system is ready, you must do the following:

1. Insert your ignition key into the ignition switch.
2. Turn the ignition to the ON position, but do not crank or start the engine.
3. If you crank or start the engine, you will have to start this test over.
4. As soon as you turn your key to the ON position, you will see your MIL symbol come on as part of a normal bulb check.
5. Approximately 15 seconds later, one of two things will happen:
  - a. The MIL will flash for about 10 seconds and then return to being fully illuminated until you turn off the

ignition key or start the engine. This means that your vehicle's OBD system is **not ready** and you should **not** proceed to the I/M station.

b. The MIL will not flash at all and will remain fully illuminated until you turn off the ignition key or start the engine. This means that your vehicle's OBD system is **ready** and you can proceed to the I/M station.

If your OBD system is **not ready**, you should see your authorized dealer or repair facility. If your vehicle was recently serviced or had a battery failure or replacement, you may need to do nothing more than drive your vehicle as you normally would in order for your OBD system to update. A recheck with the above test routine may then indicate that the system is now ready.

Regardless of whether your vehicle's OBD system is ready or not ready, if the MIL symbol is illuminated during normal vehicle operation, you should have your

vehicle serviced before going to the I/M station. The I/M station can fail your vehicle because the MIL symbol is on with the engine running.

#### **REPLACEMENT PARTS**

Use of genuine Mopar® parts for normal/scheduled maintenance and repairs is highly recommended to insure the designed performance. Damage or failures caused by the use of non-Mopar® parts for maintenance and repairs will not be covered by the manufacturer's warranty.

#### **DEALER SERVICE**

Your dealer has the qualified service personnel, special tools and equipment to perform all service operations in an expert manner. Service Manuals are available which include detailed service information for your vehicle. Refer to these manuals before attempting any procedure yourself.

**NOTE:** Intentional tampering with emissions control systems can result in civil penalties being assessed against you.

**WARNING!**

**You can be badly injured working on or around a motor vehicle. Do only that service work for which you have the knowledge and the proper equipment. If you have any doubt about your ability to perform a service job, take your vehicle to a competent mechanic.**

### **MAINTENANCE PROCEDURES**

The pages that follow contain the **required** maintenance services determined by the engineers who designed your vehicle.

Besides the maintenance items for which there are fixed maintenance intervals, there are other items that should operate satisfactorily without periodic maintenance. However, if a malfunction of these items does occur, it could adversely affect the engine or vehicle performance. These items should be inspected if a malfunction is observed or suspected.

#### **Engine Oil**

##### **Checking Oil Level**

To assure proper engine lubrication, the engine oil must be maintained at the correct level. Check the oil level at regular intervals, such as every fuel stop.

The best time to check the engine oil level is about 5 minutes after a fully warmed engine is shut off or before starting the engine after it has sat overnight.

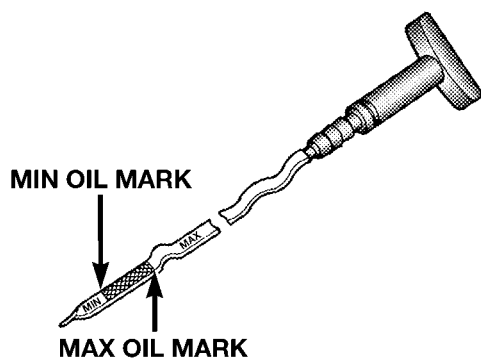

80975a64

Checking the oil while the vehicle is on level ground, will improve the accuracy of the oil level readings. Maintain the oil level between the MIN and MAX markings on the

dipstick. Adding one quart of oil when the reading is at the MIN mark will result in a MAX reading on these engines.

### CAUTION!

Overfilling the crankcase as indicated by an oil level above the "Max" mark on the engine oil dipstick will cause oil aeration, which can lead to loss of oil pressure and an increase in oil temperature. This could damage your engine.

### Change Engine Oil

Road conditions and your kind of driving affects the interval at which your oil should be changed. Check the following list to decide if any apply to you.

- Day and night temperatures are below 32°F (0°C).
- Stop and Go driving.

- Extensive engine idling.
- Driving in dusty conditions.
- Short trips of less than 10 miles (16 km).
- More than 50% of your driving is at sustained high speeds during hot weather, above 90°F (32°C).
- Trailer towing.
- Taxi, Police or delivery service (commercial service).
- Off-Road or desert operation.

**NOTE:** If ANY of these apply to you, then change your engine oil every 3,000 miles (4 800 km) or 3 months, whichever comes first and follow maintenance schedule “B”—ALL ENGINES in the maintenance schedule section of this manual.

If none of these apply to you, and your vehicle is equipped with a Non-Turbo Charged Engine then

change your engine oil at every interval shown on schedule “A”—NON TURBO CHARGED ENGINES in the maintenance schedule section of this manual.

If none of these apply to you, and your vehicle is equipped with a Turbo Charged Engine change your engine oil at every interval shown on schedule “A”—TURBO CHARGED ENGINES in the maintenance schedule section of this manual.

**NOTE:** Under no circumstances should oil change intervals exceed 6000 miles (10 000 km) or 6 months whichever comes first.

#### **Engine Oil Selection**

For best performance and maximum protection under all types of operating conditions, the manufacturer only recommends engine oils that are API certified and meet the requirements of DaimlerChrysler Material Standard MS-6395.

### American Petroleum Institute (API) Engine Oil Identification Symbol



This symbol means that the oil has been certified by the American Petroleum Institute (API). The manufacturer only recommends API Certified engine oils.

### Engine Oil Viscosity (SAE Grade)

The proper SAE viscosity grade of engine oil should be selected based on the following recommendation and be within the operating temperature shown in the engine oil viscosity chart.

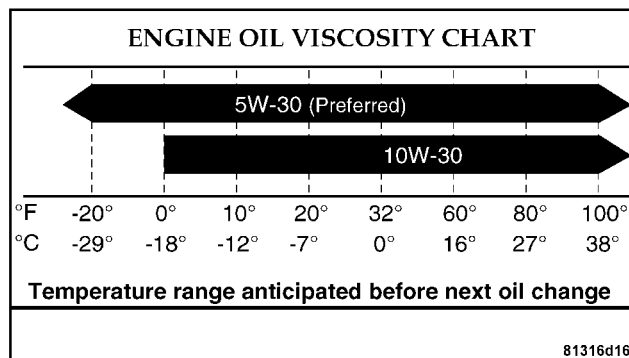

- **SAE 5W-30** engine oil is preferred. SAE 5W-30 engine oils improve low temperature starting and helps vehicle fuel economy.

Lubricants which do not have both, the engine oil certification mark and the correct SAE viscosity grade number should not be used.

**Synthetic Engine Oils**

There are a number of engine oils being promoted as either synthetic or semi-synthetic. If you chose to use such a product, use **only** those oils that are American Petroleum Institute (API) Certified and SAE viscosity standard. Follow the service schedule that describes your driving type.

**Materials Added To Engine Oils**

The manufacture strongly recommends against the addition of any additives (other than leak detection dyes) to the engine oil. Engine oil is an engineered product and it's performance may be impaired by supplemental additives.

**Disposing of Used Engine Oil**

Care should be taken in disposing of used engine oil from your vehicle. Used oil, indiscriminately discarded, can present a problem to the environment. Contact your

dealer, service station, or governmental agency for advice on how and where used oil can be safely discarded in your area.

**Engine Oil Filter**

The engine oil filter should be replaced at every engine oil change.

**Engine Oil Filter Selection**

All of this manufacturers engines have a full-flow type disposable oil filter. Use a filter of this type for replacement. The quality of replacement filters varies considerably. Only high quality filters should be used to assure most efficient service. Mopar Engine Oil Filters are high quality oil filters and are recommended.

**Drive Belts — Check Condition and Tension**

At the mileage shown in the maintenance schedules, check all drive belts for condition and proper tension. Improper belt tension can cause belt slippage and failure.

Inspect the drive belts for evidence of cuts, cracks, or glazing and replace them if there is any sign of damage which could result in belt failure. If adjustment is required, see your authorized dealer for service.

Special tools are required to properly measure tension and to restore belt tension to factory specifications. Also, check belt routing to make sure there is no interference between the belts and other engine components.

**Spark Plugs**

Spark plugs must fire properly to assure engine performance and emission control. New plugs should be installed at the specified mileage. The entire set should be replaced if there is any malfunction due to a faulty spark

plug. Refer to the Engine data Label located under the hood for the proper type of spark plug for use in your vehicle.

**Ignition Wiring System**

The ignition cables should be kept clean and properly connected. Terminals should be fully seated. Cracked, damaged, or faulty cables should be replaced.

**Catalytic Converter**

The catalytic converter requires the use of unleaded fuel only. Leaded gasoline will destroy the effectiveness of the catalyst as an emission control device.

Under normal operating conditions, the catalytic converter will not require maintenance. However, it is important to keep the engine properly tuned to assure proper catalyst operation and prevent possible catalyst damage.



**CAUTION!**

Damage to the catalytic converter can result if your vehicle is not kept in proper operating condition. In the event of engine malfunction, particularly involving engine misfire or other apparent loss of performance, have your vehicle serviced promptly. Continued operation of your vehicle with a severe malfunction could cause the converter to overheat, resulting in possible damage to the converter and the vehicle.

**WARNING!**

A hot exhaust system can start a fire if you park over materials that can burn. Such materials might be grass or leaves coming into contact with your exhaust system. Do not park or operate your vehicle in areas where your exhaust system can contact anything that can burn.

In unusual situations involving grossly malfunctioning engine operation, a scorching odor may suggest severe and abnormal catalyst overheating. If this occurs, stop the vehicle, turn off the engine and allow it to cool. Service, including a tune up to manufacturers specifications, should be obtained immediately.

To minimize the possibility of catalyst damage:

- Do not shut off the engine or interrupt the ignition when the transaxle is in gear and the vehicle is in motion.
- Do not try to start the engine by pushing or towing the vehicle.
- Do not idle the engine with any spark plug wires disconnected for prolonged period.

#### **Engine Timing Belt**

Replace the engine timing belt at the intervals described in the appropriate maintenance schedule.

#### **Crankcase Emission Control System**

Proper operation of this system depends on freedom from sticking or plugging due to deposits. As vehicle mileage builds up, the PCV valve and passages may

accumulate deposits. If a valve is not working properly, replace it with a new valve. **DO NOT ATTEMPT TO CLEAN THE OLD PCV VALVE!**

Check ventilation hose for indication of damage or plugging deposits. Replace if necessary.

#### **Fuel Filter**

A plugged fuel filter can cause hard starting or limit the speed at which a vehicle can be driven. Should an excessive amount of dirt accumulate in the fuel tank, frequent filter replacement may be necessary. The fuel filters are located inside the fuel tank. See your dealer for service.

#### **Air Cleaner Element (Filter)**

Under normal driving conditions, replace the filter at the intervals shown on Schedule "A". If, however, you drive the vehicle frequently under dusty or severe conditions,

the filter element should be inspected periodically and replaced if necessary at the intervals shown on Schedule "B".

**WARNING!**

The air cleaner can provide a measure of protection in the case of engine backfire. Do not remove the air cleaner unless such removal is necessary for repair or maintenance. Make sure that no one is near the engine compartment before starting the vehicle with the air cleaner removed. Failure to do so can result in serious personal injury.

**Maintenance-Free Battery**

You will never have to add water, nor is periodic maintenance required.

**CAUTION!**

When servicing the battery, always reinstall the battery thermowrap. The thermowrap provides battery heat protection and will extend overall battery life. Failure to reinstall the thermowrap can result in evaporative loss of the battery fluid.

**WARNING!**

Battery fluid is a corrosive acid solution and can burn or even blind you. Don't allow battery fluid to contact your eyes, skin or clothing. Don't lean over a battery when attaching clamps. If acid splashes in eyes or on skin, flush the area immediately with large amounts of water.

Battery gas is flammable and explosive. Keep flame or sparks away from the battery. Don't use a booster battery or any other booster source with an output greater than 12 volts. Don't allow cable clamps to touch each other.

Battery posts, terminals and related accessories contain lead and lead compounds. Wash hands after handling.

**CAUTION!**

It is essential when replacing the cables on the battery that the positive cable is attached to the positive post and the negative cable is attached to the negative post. Battery posts are marked positive (+) and negative (-) and identified on the battery case. Cable clamps should be tight on the terminal posts and free of corrosion. Apply grease to posts and clamps after tightening.

If a "fast charger" is used while the battery is in the vehicle, disconnect both vehicle battery cables before connecting the charger to battery. Do not use a "fast charger" to provide starting voltage as battery damage can result.

**Air Conditioner**

Check the air conditioning system at the start of the warm weather season.

**NOTE:** If your air conditioning performance seems lower than expected, check the front of the A/C condenser for an accumulation of dirt or insects. Clean with a gentle water spray from behind the radiator and through the condenser as required. Fabric front fascia protectors may reduce air flow to the condenser, reducing air conditioning performance.

**WARNING!**

**The air conditioning system contains refrigerant under high pressure. To avoid risk of personal injury or damage to the system, adding refrigerant or any repair requiring lines to be disconnected should be done by an experienced repairman.**

**Refrigerant Recovery And Recycling**

The air conditioning system of your vehicle contains R-134a, a refrigerant that does not deplete the ozone layer in the upper atmosphere, the manufacturer recommends that air conditioning service be done by facilities using refrigerant recycling and recovery equipment that meets SAE standard J1991.

**Power Steering — Fluid Check**

Checking the power steering fluid level at a defined service interval is not required. The fluid should only be checked if a leak is suspected, abnormal noises are apparent, and/or the system is not functioning as anticipated. Coordinate inspection efforts through a certified DaimlerChrysler Dealership."

**WARNING!**

**Fluid level should be checked on a level surface and with the engine off to prevent injury from moving parts and to insure accurate fluid level reading. Do not overfill. Use only manufacturers recommended power steering fluid.**

If necessary, add fluid to restore to the proper indicated level. With a clean cloth, wipe any spilled fluid from all surfaces. Refer to Recommended Fluids, Lubricants, and Genuine Parts for correct fluid types.

**Front Suspension Ball Joints**

There are two front suspension lower ball joints that are permanently lubricated. Inspect these ball joints whenever under vehicle service is done. Damaged seals and their corresponding potentially damaged ball joints must be replaced.

**Body Lubrication**

Locks and all body pivot points, including such items as seat tracks, doors, liftgate and hood hinges, should be lubricated periodically to assure quiet, easy operation and to protect against rust and wear. Prior to the application of any lubricant, the parts concerned should be wiped clean to remove dust and grit; after lubricating excess oil and grease should be removed. Particular attention should also be given to hood latching components to insure proper function. When performing other underhood services, the hood latch, release mechanism and safety catch should be cleaned and lubricated.

The external lock cylinders should be lubricated twice a year, preferably in the fall and spring. Apply a small amount of a high quality lubricant such as Mopar® Lock Cylinder Lubricant directly into the lock cylinder.

### Windshield Wiper Blades

Clean the rubber edges of the wiper blades and the windshield periodically with a sponge or soft cloth and a mild non abrasive cleaner or use the washer solvent. This will remove accumulations of salt, waxes or road film and help reduce streaking and smearing.

Operation of the wipers on dry glass for long periods may cause deterioration of the wiper blades. Always use washer fluid when using the wipers to remove salt or dirt from a dry windshield. Avoid using the wiper blades to remove frost or ice from the windshield. make sure that they are not frozen to the glass before turning them on to avoid damaging the blade. Keep the blade rubber out of contact with petroleum products such as engine oil, gasoline, etc.

### Windshield Wiper Blade Replacement

1. Lift the wiper arm away from the glass.

2. Push the release tab shown in the illustration and slide the wiper blade assembly down along the arm. Gently place the wiper arm on the windshield.
3. Install the new blade assembly onto the wiper arm tip until it locks in place.

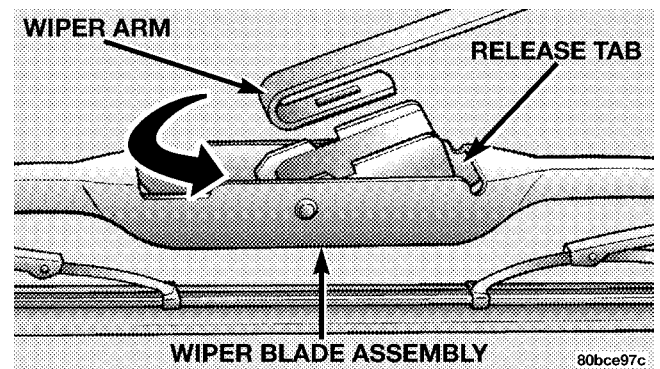

### Windshield Washer Reservoir

The washer fluid reservoir is located in the rear of the engine compartment on the passenger side and should be checked for fluid level at regular intervals. Fill the reservoir with windshield washer solvent (not radiator antifreeze).

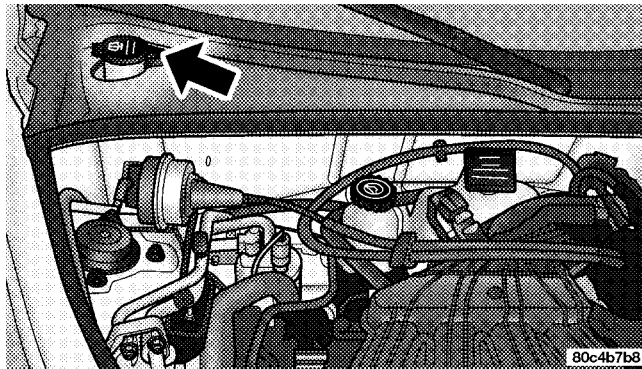

### Exhaust System

The best protection against carbon monoxide entry into the vehicle body is a properly maintained engine exhaust system.

If you notice a change in the sound of the exhaust system, or if exhaust fumes can be detected inside the vehicle, or when the underside or rear of the vehicle is damaged; have a competent technician inspect the complete exhaust system and adjacent body areas for broken, damaged, deteriorated, or mispositioned parts. Open seams or loose connections could permit exhaust fumes to seep into the passenger compartment. In addition, inspect the exhaust system each time the vehicle is raised for an oil change or lubrication. Replace as required.



**WARNING!**

Exhaust gases can injure or kill. They contain carbon monoxide which is colorless and odorless. Breathing it can make you unconscious and can eventually poison you. Follow the above precautions to keep your exhaust system as safe as possible.

**Cooling System****WARNING!**

- When working near the radiator cooling fan, disconnect the fan motor lead or turn the ignition switch to the OFF position. The fan is temperature controlled and can start at any time the ignition switch is in the ON position.
- You or others can be badly burned by hot coolant or steam from your radiator. If you see or hear steam coming from under the hood, don't open the hood until the radiator has had time to cool. Never try to open a cooling system pressure cap when the radiator is hot.

**Coolant Checks**

Check coolant protection every 12 months (before the onset of freezing weather, where applicable). If coolant is dirty or rusty in appearance, the system should be drained, flushed and refilled with fresh coolant.

Check the front of the radiator for an accumulation of bugs, leaves, etc. Clean the radiator by gently spraying water from a garden hose at the back of the core.

Check the coolant recovery bottle tubing for brittle rubber, cracking, tears, cuts and tightness of the connection at the bottle and radiator. Inspect the entire system for leaks.

With the engine at normal operating temperature (but not running), check the cooling system pressure cap for proper vacuum sealing by draining a small amount of coolant from the radiator drain cock. If the cap is sealing properly, the coolant will begin to drain from the coolant recovery bottle. Do not remove the cap when the cooling system is hot.

**Cooling System — Drain, Flush And Refill**

At the intervals shown on the Maintenance Schedules, the system should be drained, flushed and refilled.

If the solution is dirty and contains a considerable amount of sediment, clean and flush with a reliable cooling system cleaner. Follow with a thorough rinsing to remove all deposits and chemicals. Discard old antifreeze solution.

**Engine Coolant Disposal**

Used ethylene glycol based engine coolant is a regulated substance requiring proper disposal. Check with your local authorities to determine the disposal rules for your community. To prevent ingestion by animals or children do not store ethylene glycol based engine coolant in open containers or allow it to remain in puddles on the ground. If ingested by a child, contact a physician immediately. Clean up any ground spills immediately.

**Selection Of Coolant**

Use only the manufacturers recommended coolant, refer to Recommended Fluids, Lubricants and Genuine Parts for correct coolant type.

**CAUTION!**

**Failure to use the proper antifreeze could cause radiator plugging and engine overheating. Do not mix antifreeze brands or use plain water alone or alcohol based antifreeze products. Do not use additional rust inhibitors or antirust products, as they may not be compatible with the radiator coolant and may plug the radiator.**

**Adding Coolant**

When adding coolant, a minimum solution of 50% ethylene glycol antifreeze coolant in water should be used.

Use higher concentrations (not to exceed 70%) if temperatures below  $-34^{\circ}\text{F}$  ( $-37^{\circ}\text{C}$ ) are anticipated.

Use only high purity water such as distilled or deionized water when mixing the water/antifreeze solution. The use of lower quality water will reduce the amount of corrosion protection in the engine cooling system.

Please note that it is the owner's responsibility to maintain the proper level of protection against freezing according to the temperatures occurring in the area where the vehicle is operated.

**NOTE:** Mixing coolant types will decrease the life of the engine coolant and will require more frequent coolant changes.

**Cooling System Pressure Cap**

The cap must be fully tightened to prevent loss of coolant, and to insure that coolant will return to the radiator from the coolant recovery bottle.

The cap should be inspected and cleaned if there is any accumulation of foreign material on the sealing surfaces.

**WARNING!**

**The warning words “DO NOT OPEN HOT” on the cooling system pressure cap are a safety precaution. Never add coolant when the engine is overheated. Do not loosen or remove the cap to cool an overheated engine. Heat causes pressure to build up in the cooling system. To prevent scalding or injury, do not remove the pressure cap while the system is hot or under pressure.**

**Coolant Level**

The coolant recovery bottle provides a quick visual method for determining that the coolant level is adequate. With the engine idling, and warm to normal

operating temperature, the level of the coolant in the bottle should be between the “FULL” and “ADD” marks.

The radiator normally remains completely full, so there is no need to remove the radiator cap unless checking for coolant freeze point or replacing coolant. Advise your service attendant of this. As long as the engine operating temperature is satisfactory, the coolant recovery bottle need only be checked once a month.

When additional coolant is needed to maintain the proper level, it should be added to the coolant recovery bottle. Do not overfill.

**Points To Remember**

**NOTE:** When the vehicle is stopped after a few kilometers (a few miles) of operation, you may observe vapor coming from the front of the engine compartment. This is normally a result of moisture from rain, snow, or high

humidity accumulation on the radiator and being vaporized when the thermostat opens, allowing hot water to enter the radiator.

If an examination of your engine compartment shows no evidence of radiator or hose leaks, the vehicle may be safely driven. The vapor will soon dissipate.

- Do not overfill the coolant recovery bottle.
- Check coolant freeze point in the system.
- If frequent coolant additions are required, the cooling system should be pressure tested for leaks.
- Maintain coolant concentration at 50% ethylene glycol antifreeze (minimum) in water for proper corrosion protection of your engine which contains aluminum components.
- Make sure that the radiator and coolant recovery bottle hoses are not kinked or obstructed.

- Keep the front of the radiator clean. If your vehicle has air conditioning, keep the front of the condenser clean, also.
- Do not change the thermostat for summer or winter operation. If replacement is ever necessary, install ONLY the correct type thermostat. Other designs may result in unsatisfactory coolant performance, poor gas mileage, and increased emissions.

#### **Hoses And Vacuum/Vapor Harnesses**

Inspect surfaces of hoses and nylon tubing for evidence of heat and mechanical damage. Hard or soft spots, brittle rubber, cracking, tears, cuts, abrasions, and excessive swelling indicate deterioration of the rubber

Pay particular attention to the hoses nearest to high heat sources such as the exhaust manifold. Inspect hose routing to be sure hoses do not touch any heat source or moving component that may cause heat damage or mechanical wear.

Inspect nylon tubing in these areas has not melted or collapsed

Inspect all hose connections such as clamps and couplings to make sure they are secure and no leaks are present.

Components should be replaced immediately if there is any evidence of degradation that could cause failure.

#### **Fuel System Connections**

Electronic Fuel Injection high pressure fuel systems are designed with tubes and special connects, connections and clamps which have unique material characteristics to provide adequate sealing and resist attack by deteriorated gasoline.

You are urged to use only the manufacturer-specified tubes, connections and clamps, or their equivalent in material and specification, in any fuel system servicing.

#### **Brake System**

In order to assure brake system performance, all brake system components should be inspected periodically. Suggested service intervals can be found in the Maintenance Section.

#### **WARNING!**

**Riding the brakes can lead to brake failure and possibly an accident. Driving with your foot resting or riding on the brake pedal can result in abnormally high brake temperatures, excessive lining wear, and possible brake damage. You wouldn't have your full braking capacity in an emergency.**

#### **Brake And Power Steering System Hoses**

When servicing the vehicle for scheduled maintenance, inspect the surface of the hoses and nylon tubing for evidence of heat and mechanical damage. Hard and

brittle rubber, cracking, tears, cuts, abrasions, and excessive swelling suggest deterioration of the rubber. Particular attention should be made to examining those hose surfaces nearest to high heat sources, such as the exhaust manifold.

Inspect all hose clamps and couplings to make sure they are secure and no leaks are present.

Insure nylon tubing in these areas has not melted or collapsed.

**NOTE:** Often, fluids such as oil, power steering fluid, and brake fluid are used during assembly plant operations to ease the assembly of hoses to couplings. Therefore, oil wetness at the hose-coupling area is not necessarily an indication of leakage. Actual dripping of hot fluid when systems are under pressure (during vehicle operation) should be noted before a hose is replaced based on leakage.

**NOTE:** Inspection of brake hoses should be done whenever the brake system is serviced and at every engine oil change.

#### WARNING!

**Worn brake hoses can burst and cause brake failure. You could have an accident. If you see any signs of cracking, scuffing, or worn spots, have the brake hoses replaced immediately.**

#### Brake Master Cylinder

The fluid level in the master cylinder should be checked when performing under hood services, or immediately if the brake system warning lamp is on.

Be sure to clean the top of the master cylinder area before removing the cap. If necessary, add fluid to bring the fluid level up to the requirements described on the brake

fluid reservoir. Fluid level can be expected to fall as the brake pads wear. Brake fluid level should be checked when pads are replaced. However, low fluid level may be caused by a leak and a checkup may be needed.

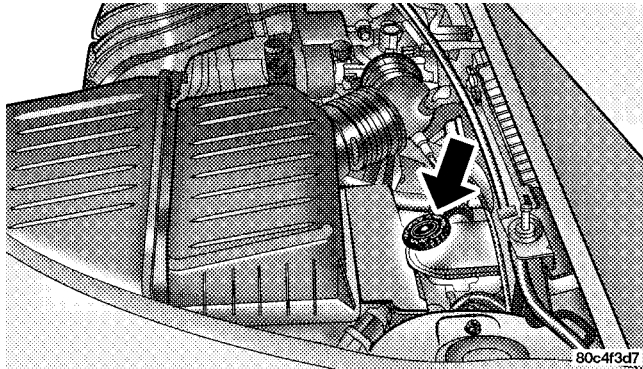

Use only manufacturers recommended brake fluid, refer to Recommended Fluids, Lubricants and Genuine Parts for correct fluid type.

**WARNING!**

Use of a brake fluid that may have a lower initial boiling point or unidentified as to specification, may result in sudden brake failure during hard prolonged braking. You could have an accident.

**WARNING!**

Overfilling the brake fluid reservoir can result in spilling brake fluid on hot engine parts and the brake fluid catching fire.

Use only brake fluid that has been in a tightly closed container to avoid contamination from foreign matter.

Do not allow petroleum based fluid to contaminate the brake fluid as seal damage will result!



**Automatic Transaxle**

All front wheel drive vehicles have a transmission and differential assembly contained within a single housing.

**Selection Of Lubricant**

It is important that the proper lubricant is used in the transaxle to assure optimum transaxle performance. Use only manufacturers recommended transmission fluid, refer to Recommended Fluids, Lubricants and Genuine Parts for correct fluid type. It is important that the transmission fluid be maintained at the prescribed level using the recommended fluid.

**CAUTION!**

**Using a transmission fluid other than the manufacturers recommended fluid may cause deterioration in transmission shift quality and/or torque converter shudder. Using a transmission fluid other than the manufacturers recommended fluid will result in more frequent fluid and filter changes. Refer to Recommended Fluids, Lubricants and Genuine Parts for correct fluid type.**

**Fluid Level Check**

The fluid level in the automatic transaxle should be checked whenever the vehicle is serviced. Operation with an improper fluid level will greatly reduce the life of the transaxle and of the fluid.

**Procedure For Checking Fluid Level**

To properly check the automatic transaxle fluid level, the following procedure must be used:

1. The vehicle must be on level ground.
2. The engine should be running at curb idle speed for a minimum of 60 seconds.
3. Fully apply parking brake.
4. Place the gear selector momentarily in each gear position ending with the lever in P (PARK).
5. Remove the dipstick and determine if the fluid is hot or warm. Hot fluid is approximately 180°F (82°C) which is the normal operating temperature after the vehicle has been driven at least 24 km (15 miles). The fluid cannot be comfortably held between the finger tips. Warm is when the fluid is between 85° to 125°F (29° to 52°C).

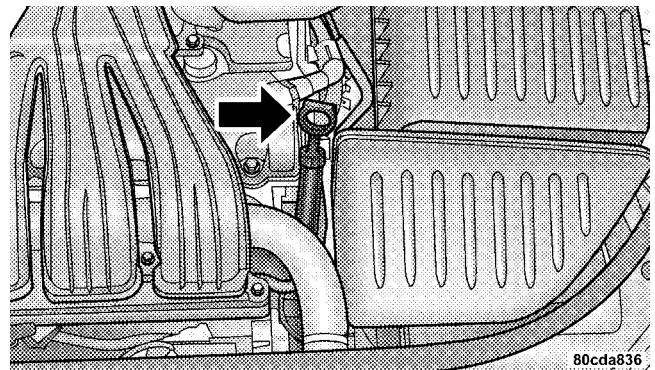

6. Wipe the dipstick clean and reinsert until seated. Remove dipstick and note reading.

If the fluid is hot, reading should be in the cross hatched area marked "HOT" between the upper two holes in the dipstick.

If the fluid is cold, the fluid level should be between the lower two holes, into the area marked "LOW".

If the fluid level shows low, add sufficient transmission fluid to bring to the proper level.

### CAUTION!

**Do not overfill. Dirt and water in the transaxle can cause serious damage. To prevent dirt and water from entering the transaxle after checking or replenishing fluid, make certain that the dipstick cap is seated properly.**

#### Fluid And Filter Changes

Automatic transmission fluid and filter should be changed as follows:

**Maintenance schedule "A"—Non Turbo Charged Engines** – No change necessary.

**Maintenance schedule "A"—Turbo Charged Engines** – No change necessary.

**Maintenance schedule "B"—All Engines** – Every 60,000 miles (96 000 km) change fluid and filter under the following conditions:

- Police, taxi, limousine, commercial type operation, or trailer towing where the vehicle is driven **regularly** for more than 45 minutes of continuous operation.

**NOTE:** Refer to Section 8 of this manual for maintenance schedules.

If the transaxle is disassembled for any reason, the fluid and filter should be changed.

**Special Additives**

The manufacturer recommends against the addition of any fluid additives to the transaxle. The only exception to this policy is the use of special dyes to aid in detecting fluid leaks. The use of transmission sealers should be avoided as they may adversely affect seals.

**Manual Transaxle****Lubricant Selection**

Use only manufacturers recommended transmission fluid, refer to Recommended Fluids, Lubricants and Genuine Parts for correct fluid type.

**Fluid Level Check**

Check the fluid level by removing the fill plug. The fluid level should be between the bottom of the fill hole and a point not more than  $3/16$ " (4.7 mm) below the bottom of the hole.

Add fluid, if necessary, to maintain the proper level.

**Frequency Of Fluid Change**

Under normal operating conditions, the fluid installed at the factory will give satisfactory lubrication for the life of the vehicle. Fluid changes are not necessary unless the following conditions exist:

- The lubricant has become contaminated with water. If contaminated with water, the fluid should be changed immediately.
- If severe usage has occurred, refer to Maintenance Schedule "B" in Section 8 of this manual.

**Appearance Care And Protection From Corrosion****Protection Of Body And Paint from Corrosion**

Vehicle body care requirements vary according to geographic locations and usage. Chemicals that make roads passable in snow and ice, and those that are sprayed on trees and road surfaces during other seasons, are highly corrosive to the metal in your vehicle. Outside parking,

which exposes your vehicle to airborne contaminants, road surfaces on which the vehicle is operated, extreme hot or cold weather and other extreme conditions will have an adverse effect on paint, metal trim, and underbody protection.

The following maintenance recommendations will enable you to obtain maximum benefit from the corrosion resistance built into your vehicle.

#### **What Causes Corrosion?**

Corrosion is the result of deterioration or removal of paint and protective coatings from your vehicle.

The most common causes are:

- Road salt, dirt and moisture accumulation.
- Stone and gravel impact.
- Insects, tree sap and tar.

- Salt in the air near sea coast localities.
- Atmospheric fallout/industrial pollutants.

#### **Washing**

- Wash your vehicle regularly. Always wash your vehicle in the shade using a mild car wash soap, and rinse the panels completely with clear water.
- If insects, tar or other similar deposits have accumulated on your vehicle, wash it as soon as possible.
- Use Mopar auto polish to remove road film and stains and to polish your vehicle. Take care never to scratch the paint.
- Avoid using abrasive compounds and power buffing that may diminish the gloss or thin out the paint finish.

**CAUTION!**

**Do not use abrasive or strong cleaning materials such as steel wool or scouring powder, which will scratch metal and painted surfaces.**

**Special Care**

- If you drive on salted or dusty roads or if you drive near the ocean, hose off the undercarriage at least once a month.
- It is important that the drain holes in the lower edges of the doors, rocker panels and rear deck lid be kept clear and open.
- If you detect any stone chips or scratches in the paint, touch them up immediately. The cost of such repairs is considered the responsibility of the owner.
- Use Mopar touch up paint on scratches or chips as soon as possible. Your dealer has touch up paint to match the color of your vehicle.
- If your vehicle is damaged due to an accident or similar cause which destroys the paint and protective coating have your vehicle repaired as soon as possible. The cost of such repairs is considered the responsibility of the owner.
- If you carry special cargo such as chemicals, fertilizers, deicer salt, etc., be sure that such materials are well packaged and sealed.
- If a lot of driving is done on gravel roads, consider mud or stone shields behind each wheel.

**CAUTION!**

If your vehicle is equipped with flame or woodgrain graphics, it is recommended that special care be taken when using hand-held pressure washers to clean your vehicle. The pressure of these hand-held car wash wands can vary greatly and could possibly cause damage to the surface of the graphic. Hold the tip of the wand at least 12 inches away from the graphic surface when cleaning the vehicle.

**Wheel And Wheel Trim Care**

All wheels and wheel trim, especially Aluminum and Chrome plated, should be cleaned regularly, when cool, using mild soap and water to maintain their luster and to prevent corrosion. Wash them with the same soap solution as the body of your vehicle. Rinse wheels thoroughly.

When cleaning extremely dirty wheels, care must be taken in the selection of tire and wheel cleaning chemicals and equipment to prevent damage to the wheels. Only Mopar Wheel Cleaners are recommended. DO NOT USE any of the items listed below which can damage your wheels and wheel trim.

**DO NOT USE:**

- Any abrasive cleaner
- Any abrasive cleaning pad (such as steel wool) or abrasive brush
- Any cleaner that contains an acid which can react with and discolor the chrome surface.
- Chrome polish
- Oven cleaner
- A car wash that uses carbide-tipped wheel cleaning brushes or acidic solutions.

**CAUTION!**

**Many wheel cleaners contain acids that may harm the wheel surface.**

**NOTE:** Replacement costs for components damaged as a result of not following the recommended cleaning practices are considered the responsibility of the customer.

**Interior Care**

Use Mopar Fabric Cleaner to clean fabric upholstery and carpeting.

Use Mopar Vinyl Cleaner to clean vinyl upholstery and vinyl trim.

Mopar Total Clean is specifically recommended for leather upholstery.

Your leather upholstery can be best preserved by regular cleaning with a damp soft cloth. Small particles of dirt can act as an abrasive and damage the leather upholstery and should be removed promptly with a damp cloth. Stubborn soils can be removed easily with a soft cloth and Mopar Total Clean. Care should be taken to avoid soaking your leather upholstery with any liquid. Please do not use polishes, oils, cleaning fluids, solvents, detergents, or ammonia based cleaners to clean your leather upholstery. Application of a leather conditioner is not required to maintain the original condition.

**WARNING!**

**Do not use volatile solvents for cleaning purposes. Many are potentially flammable, and if used in closed areas they may cause respiratory harm.**



**Cleaning Headlights**

Your vehicle has plastic headlights that are lighter and less susceptible to stone breakage than glass headlights.

Plastic is not as scratch resistant as glass and therefore different lens cleaning procedures must be followed.

To minimize the possibility of scratching the lenses and reducing light output, avoid wiping with a dry cloth. To remove road dirt, wash with a mild soap solution followed by rinsing.

Do not use abrasive cleaning components, solvents, steel wool or other aggressive material to clean the lenses.

**Glass Surfaces**

All glass surfaces should be cleaned on a regular basis with any commercial household-type glass cleaner. Never use an abrasive type cleaner. Use caution when

cleaning inside rear windows equipped with electric defrosters. Do not use scrapers or other sharp instruments which may scratch the elements.

**Instrument Panel Cover**

The instrument panel cover has a low glare surface which minimizes reflections in the windshield. Do not use protectants or other products which may cause undesirable reflections. Use soap and warm water to restore the low glare surface.

**Cleaning Plastic Instrument Cluster Lenses**

The lenses in front of the instruments in the vehicle are molded in clear plastic. When cleaning the lenses, care must be taken to avoid scratching the plastic.

1. Clean with a wet soft rag. A mild soap solution may be used, but do not use high alcohol content of abrasive cleaners. If soap is used, wipe clean with a clean damp rag.

2. Dry with a soft tissue.

#### **Seat Belt Maintenance**

Do not bleach, dye or clean the belts with chemical solvents or abrasive cleaners. This will weaken the fabric. Sun damage will also weaken the fabric.

If the belts need cleaning, use a mild soap solution or lukewarm water. Do not remove the belts from the vehicle to wash them.

Replace the belts if they appear frayed or worn or if the buckles do not work properly.

## **FUSES**

### **Underhood Fuses (Power Distribution Center)**

A Power Distribution Center is located in the engine compartment; next to the air cleaner filter. A label identifying the components and circuits is located on the underside of the cover.

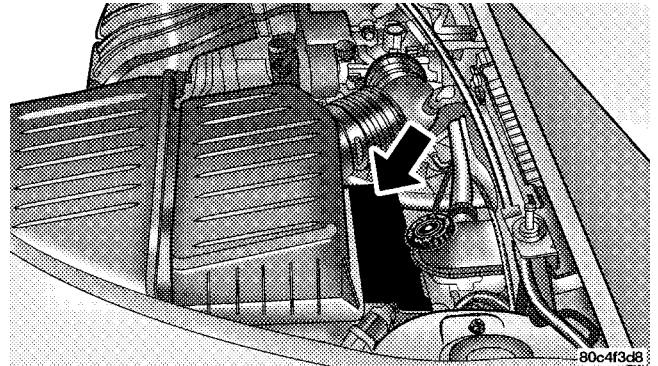

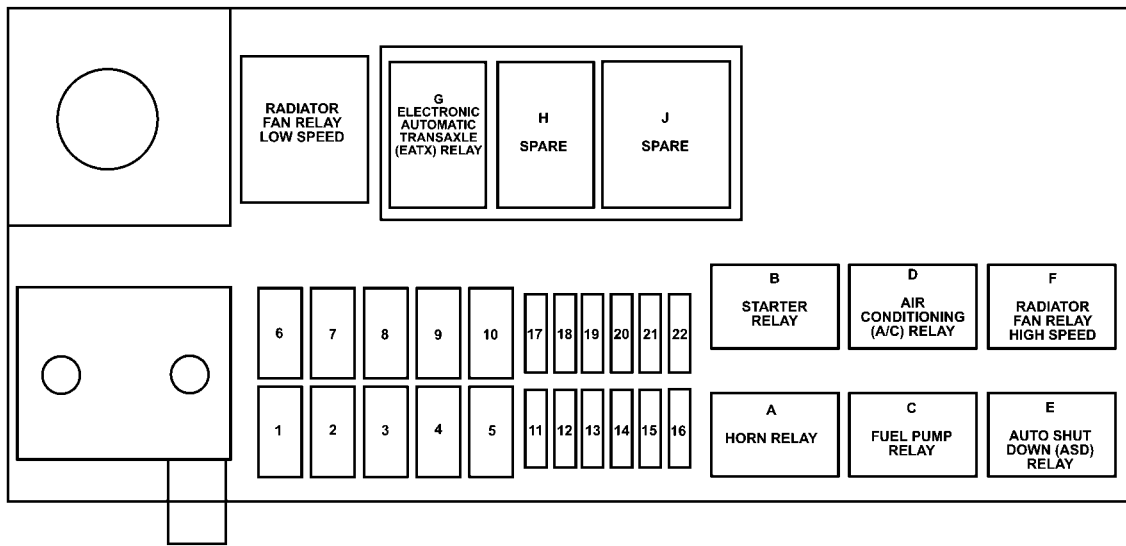

Power Distribution Center Cover

809cc391

FUSE	Amp/Color	Items Fused
1	30 Amp/Pink	Ignition Start
2	40 Amp/Green	Anti-Lock Brake (ABS) Pump
3	40 Amp/Green	Ignition Run
4	30 Amp/Blue	Heated Seats
5	40 Amp/Green	Radiator Fan
6	20 Amp/Blue	Power Height Adjuster
7	30 Amp/Blue	Anti-Lock Brake (ABS) Solenoid
8	40 Amp/Green	Electric Back Light (EBL)
9	Spare	
10	40 Amp/Green	Exterior Lighting, Remote Keyless Entry, Alarm and Door Locks
11	10 Amp/Red	Air Conditioning (A/C)
12	15 Amp/Lt. Blue	Stop Lights

FUSE	Amp/Color	Items Fused
13	20 Amp/Yellow	Fuel Pump/Auto Shut Down (ASD)
14	15 Amp/Lt. Blue	Horn
15	20 Amp/Yellow	Electronic Automatic Transaxle (ETAX)
16	15 Amp/Lt. Blue	Hi Beam
17	20 Amp/Yellow	Ignition Off Draw (IOD)
18	15 Amp/Lt. Blue	Hazard
19	20 Amp/Yellow	Power Outlets
20	Spare	
21	20 Amp/Yellow	Fog Lights (Build-Up Export Only)
22	Spare	

### Interior Fuses

The fuse access panel is on the left side of the instrument panel next to the steering column. To remove the panel, pull it out, as shown. A label identifying the components and circuits is located on the inside of the cover.

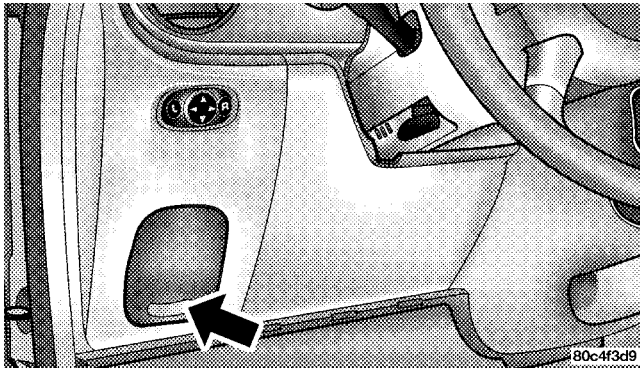

### CAUTION!

When replacing a blown fuse, it is important to use only a fuse having the correct amperage rating. The use of a fuse with a rating other than indicated may result in a dangerous electrical system overload. If a properly rated fuse continues to blow, it shows a problem in the circuit that must be corrected.

### VEHICLE STORAGE

If you will not be using your vehicle for more than 21 days you may want to take steps to preserve your battery. You may:

- Disengage the mini fuse in the Power Distribution Center labeled IOD (Ignition Off-Draw).
- Or, disconnect the negative cable from the battery.

**REPLACEMENT BULBS**

<b>LIGHT BULBS — Inside</b>	<b>Bulb No.</b>
ABS Indicator . . . . .	LED
Airbag Indicator . . . . .	LED
Brake System Warning Indicator . . . . .	LED
Center Console Floor Lamp . . . . .	T37
Climate Controls . . . . .	6233137
Console Gear Selector . . . . .	PC194
Cruise Indicator . . . . .	VFD *
Dome Light . . . . .	T579
Door Ajar Indicator . . . . .	VFD *
Front Fog Indicator . . . . .	LED
High Beam Indicator . . . . .	74
Instrument Cluster Illumination . . . . .	74
Liftgate Ajar Indicator . . . . .	LED
Low Fuel Indicator . . . . .	LED
Low Oil Pressure Indicator . . . . .	LED
Overhead Reading Light (Overhead Console) . . . . .	T1037

**LIGHT BULBS — Inside**

	<b>Bulb No.</b>
Overhead Reading Light (Rearview Mirror) . . . . .	T192
Rear Cargo . . . . .	T906
Seat Belt Indicator . . . . .	LED
Security Alarm Indicator . . . . .	LED
Malfunction Indicator Light . . . . .	LED
Temperature Indicator . . . . .	LED
Trac (Active) Indicator . . . . .	VFD *
TRAC OFF Indicator . . . . .	LED
Trip Indicator . . . . .	VFD *
Turn Signal Indicator . . . . .	103
Visor Vanity . . . . .	6501966
Voltage Indicator . . . . .	LED

**NOTE:** \* Vacuum Fluorescent Display

All the inside bulbs are brass or glass wedge base. Aluminum base bulbs are not approved and should not be used for replacement.

<b>LIGHTS BULBS — Outside</b>	<b>Bulb No.</b>
Low Beam Headlight . . . . .	9006XS
High Beam Headlight . . . . .	9005XS
Front Park/Turn Signal/Side Marker Light . . . . .	4157NAKX
Front Fog Light . . . . .	9006
Center High Mounted Stop Light (CHMSL) . . . . .	921-W16W
Rear Tail/Stop/Turn Signal Light . . . . .	3157-P27/7W
Backup Light . . . . .	3157-P27/7W
License Light . . . . .	168

**BULB REPLACEMENT**

**Headlight Bulb Replacement**

**CAUTION!**

**Do not touch the new headlight bulb with your fingers. Oil contamination will severely shorten bulb life.**

1. Remove the headlight access cover splash shield, located in the front wheel well opening.
2. Disconnect the electrical connector.

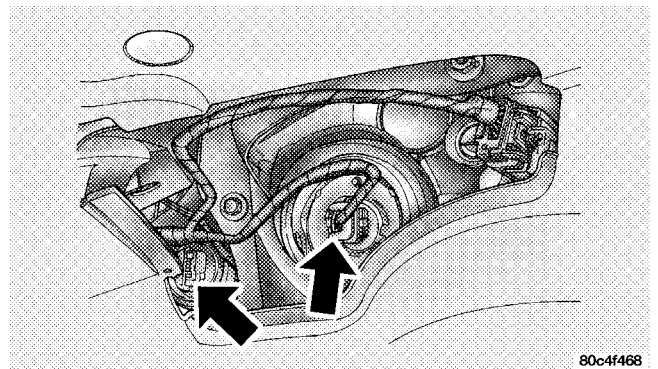

3. Rotate the socket to the left one quarter turn and replace the bulb.

### Front Park/Turn Signal/Side Marker Lights

1. Remove the headlight access cover splash shield, located in the front wheel well opening.
2. Rotate the socket to the left one quarter turn to replace and replace the bulb.

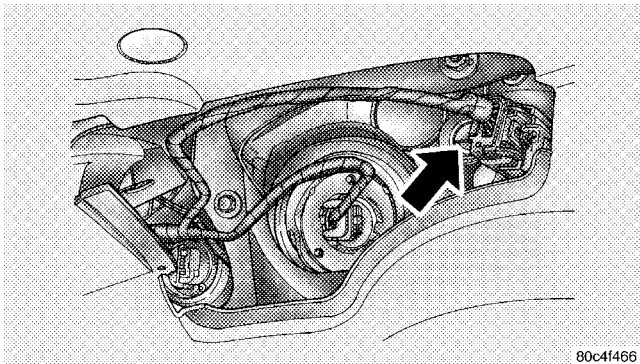

### Front Fog Lights — If Equipped

1. Remove the fasteners attaching the lower splash shield to gain access to the fog light.
2. Twist and remove the bulb from the fog light housing.
3. Disconnect the electrical connector and replace bulb.

### Tail/Stop, and Rear Turn Signal Lights

1. Remove the screw attaching the tail light housing and remove the housing from the vehicle.
2. Twist the bulb socket 1/4 turn to remove it from the housing.



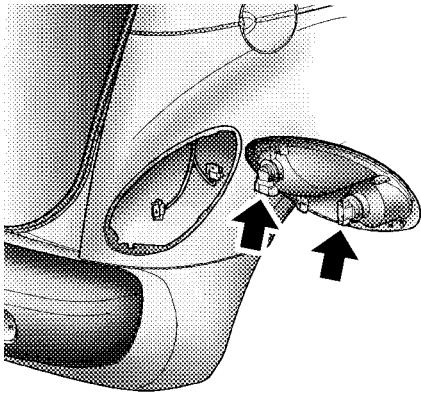

3. Pull the bulb out of the socket and replace.

80c4f469

### Back Up Light Bulb

1. Remove the screws attaching the back up light to the rear fascia and remove the housing.
2. Remove the socket from the housing.
3. Pull the bulb out of the socket and replace.

### Center High Mounted Stop Light

1. Open the liftgate and remove the liftgate CHMSL cover.
2. Remove CHMSL lens from the housing by unlatching the two side latches.
3. Pull the bulb out of the socket and replace.

**FLUIDS AND CAPACITIES**

	<b>U.S.</b>	<b>Metric</b>
<b>Fuel (Approximate)</b>	15 Gallons	56.7 Liters
<b>Engine Oil-With Filter</b>		
2.4 Liter Engines (SAE 5W-30, API Certified Engine Oil)	5.0 qts	4.8 Liters
<b>Cooling System *</b>		
2.4 Liter Turbocharged Engines (Mopar® Antifreeze/Coolant 5 Year/100,000 Miles Formula)	8.1 qts	7.7 Liters
2.4 Liter Non-Turbocharged Engines (Mopar® Antifreeze/Coolant 5 Year/100,000 Miles Formula)	6.5 qts	6.2 Liters
* Includes heater and coolant recovery bottle filled to MAX level.		

**RECOMMENDED FLUIDS, LUBRICANTS AND GENUINE PARTS****Engine**

<b>Component</b>	<b>Fluids, Lubricants and Genuine Parts</b>
Engine Coolant	Mopar® Antifreeze/Coolant 5 Year/100,000 Mile Formula HOAT (Hybrid Organic Additive Technology)
Engine Oil	Use API Certified SAE 5W-30 Engine Oil. Refer to oil viscosity chart for correct SAE grade meeting DaimlerChrysler Material Standard MS-6395.
Engine Oil Filter	Non Turbo—Mopar 4105409 or equiv. Turbo—Mopar 4781452AA or equiv.
Spark Plugs	Refer to the Vehicle Emission Control Information label in the engine compartment.
Fuel Selection	91 Octane for High Output 2.4L Turbo and 87 Octane for 2.4L Standard Turbo and 2.4L Standard Non Turbo Engines.

**Chassis**

<b>Component</b>	<b>Fluids, Lubricants and Genuine Parts.</b>
Automatic Transmission Fluid.	Mopar® ATF+4 Automatic Transmission Fluid.
Manual Transmission Fluid.	Mopar® ATF+4 Automatic Transmission Fluid.
Brake Master Cylinder	Mopar® DOT 3 and SAE J1703 should be used. If DOT 3 brake fluid is not available, then DOT 4 is acceptable. Use only recommended brake fluids.
Power Steering Reservoir	Mopar® ATF+4 Automatic Transmission Fluid.

---

## MAINTENANCE SCHEDULES

### CONTENTS

---

<ul style="list-style-type: none"> <li>■ Emission Control System Maintenance . . . . .294</li> <li>■ Maintenance Schedule . . . . .294           <ul style="list-style-type: none"> <li>□ Schedule “B”—All Engines . . . . .297</li> </ul> </li> </ul>	<ul style="list-style-type: none"> <li>□ Schedule “A”—2.4L Non Turbo Charged Engines . . . . .305</li> <li>□ Schedule “A”—2.4L Turbocharged Engines . . .309</li> </ul>
--	---

### EMISSION CONTROL SYSTEM MAINTENANCE

The “Scheduled” maintenance services, listed in **bold type** must be done at the times or mileages specified to assure the continued proper functioning of the emission control system. These, and all other maintenance services included in this manual, should be done to provide best vehicle performance and reliability. More frequent maintenance may be needed for vehicles in severe operating conditions such as dusty areas and very short trip driving.

Inspection and service also should be done any time a malfunction is suspected.

**NOTE:** Maintenance, replacement, or repair of the emission control devices and systems on your vehicle may be performed by any automotive repair establishment or individual using any automotive part which has been certified pursuant to U.S. EPA or, in the State of California, California Air Resources Board regulations.

### MAINTENANCE SCHEDULE

There are three maintenance schedules that show **required** service for your vehicle.

First is Schedule “**B**”—**ALL ENGINES**. It is for vehicles that are operated under the conditions that are listed below and at the beginning of the schedule.

- Day and night temperatures are below 32° F (0° C).
- Stop and go driving.
- Extensive engine idling.
- Driving in dusty conditions.
- Short trips of less than 10 miles (16 km).
- More than 50% of your driving is at sustained high speeds during hot weather, above 90° F (32° C).
- Trailer towing.†◇
- Taxi, police, or delivery service (commercial service).†◇

- Off-road or desert operation.
- **If equipped for and operating with E-85 (ethanol) fuel.**

**NOTE:** If ANY of these apply to you then change your engine oil every 3,000 miles (5 000 km) or 3 months, whichever comes first and follow schedule "B—All Engines" of the "Maintenance Schedules" section of this manual.

**NOTE:** Most vehicles are operated under the conditions listed for Schedule "B"—ALL ENGINES.

Second is Schedule "A"—**NON TURBO CHARGED ENGINES.** It is for vehicles that are not operated under any of the conditions listed under Schedule "B"—ALL ENGINES.

Third is Schedule "A"—**TURBO CHARGED ENGINES.** It is for vehicles that are not operated under any of the conditions listed under Schedule "B"—ALL ENGINES.

Use the schedule that best describes your driving conditions. Where time and mileage are listed, follow the interval that occurs first.

### CAUTION!

**Failure to perform the required maintenance items may result in damage to the vehicle.**

#### *At Each Stop for Fuel*

- Check the engine oil level about 5 minutes after a fully warmed engine is shut off. Checking the oil level while the vehicle is on level ground will improve the accuracy of the oil level reading. Add oil only when the level is at or below the ADD or MIN mark.
- Check the windshield washer solvent and add if required.

**Once a Month**

- Check tire pressure and look for unusual wear or damage.
- Inspect the battery and clean and tighten the terminals as required.
- Check the fluid levels of coolant reservoir, brake master cylinder and transaxle and add as needed.
- Check all lights and all other electrical items for correct operation.
- Check rubber seals on each side of the radiator for proper fit.

**At Each Oil Change**

- Change the engine oil filter.
- Inspect the exhaust system.

- Inspect the brake hoses.
- Inspect the CV joints and front suspension components.
- Check the automatic transaxle fluid level.
- Check the manual transaxle fluid level and fill plug condition.
- Check the coolant level, hoses, and clamps.
- Rotate the tires at each oil change interval shown on Schedule "A"—NON TURBO CHARGED ENGINES 6,000 miles (10 000 km), Schedule "A"—TURBO CHARGED ENGINES 5,000 miles (8 000 km), or every other interval shown on Schedule "B"—ALL ENGINES 6,000 miles (10 000 km).



**SCHEDULE "B"—ALL ENGINES**

Follow schedule "B"—All Engines if you usually operate your vehicle under one or more of the following conditions.

Change the automatic transmission fluid and filter every 60,000 miles (96 000 km) if the vehicle is usually operated under one or more of the conditions marked with an  $\diamond$ .

Change the manual transaxle fluid every 48,000 miles (77 000 km) if the vehicle is usually operated under one or more of the conditions marked with an  $\dagger$ .

- Day and night temperatures are below 32° F (0° C).
- Stop and go driving.
- Extensive engine idling.
- Driving in dusty conditions.
- Short trips of less than 10 miles (16.2 km).
- More than 50% of your driving is at sustained high speeds during hot weather, above 90° F (32° C).
- Trailer towing. $\dagger \diamond$
- Taxi, police, or delivery service (commercial service). $\dagger \diamond$
- Off-road or desert operation.
- **If equipped for and operating with E-85 (ethanol) fuel.**

**NOTE:** If ANY of these apply to you then change your engine oil every 3,000 miles (5 000 km) or 3 months, whichever comes first and follow schedule "B—All Engines" of the "Maintenance Schedules" section of this manual.

298 MAINTENANCE SCHEDULES

If none of these apply to you, and your vehicle is equipped with a Non-Turbo Charged Engine then change your engine oil at every interval shown on schedule "A"—NON TURBO CHARGED ENGINES in the maintenance schedule section of this manual.

If none of these apply to you, and your vehicle is equipped with a Turbo Charged Engine change your engine oil at every interval shown on schedule "A"—TURBO CHARGED ENGINES in the maintenance schedule section of this manual.

Miles (Kilometers)	3,000 (5 000)	6,000 (10 000)	9,000 (14 000)	12,000 (19 000)	15,000 (24 000)	18,000 (29 000)
Change engine oil and engine oil filter.	X	X	X	X	X	X
Inspect the brake linings.				X		
Inspect the <b>engine air cleaner filter</b> . Replace as necessary.*					X	
Inspect the <b>PCV make-up air filter</b> . Replace as necessary.					X	

Miles (Kilometers)	21,000 (34 000)	24,000 (38 000)	27,000 (43 000)	30,000 (48 000)	33,000 (53 000)	36,000 (58 000)
Change engine oil and engine oil filter.	X	X	X	X	X	X
Inspect the brake linings.		X				X
Replace the <b>engine air cleaner filter</b> .				X		
Replace the <b>spark plugs</b> .				X		
Inspect the tie rod ends and boot seals.				X		
Inspect the <b>PCV valve</b> and replace as necessary.*				X		
Replace the <b>PCV make-up air filter</b> .				X		
Adjust the generator drive belt tension.				X		

300 MAINTENANCE SCHEDULES

Miles ( Kilometers)	39,000 (62 000)	42,000 (67 000)	45,000 (72 000)	48,000 (77 000)	51,000 (82 000)	54,000 (86 000)
Change engine oil and engine oil filter.	X	X	X	X	X	X
Inspect the brake linings.				X		
Change the brake fluid. If vehicle is used for trailer towing.				X		
Inspect the <b>engine air cleaner filter</b> . Replace as necessary.*			X			
Change the manual transaxle fluid.†				X		
Inspect the <b>PCV make-up air filter</b> . Replace as necessary.			X			

Miles ( Kilometers)	57,000 (91 000)	60,000 (96 000)	63,000 (101 000)	66,000 (106 000)	69,000 (111 000)	72,000 (115 000)
Change engine oil and engine oil filter.	X	X	X	X	X	X
Inspect the brake linings.		X				X
Replace the <b>engine air cleaner filter</b> .		X				
Replace the <b>spark plugs and ignition cables</b> .		X				
Inspect the tie rod ends and boot seals.		X				
Inspect the <b>PCV valve</b> and replace if necessary. Not required if previously changed. * ‡		X				
Inspect the <b>PCV make-up air filter</b> . Replace as necessary.		X				
Adjust the generator drive belt tension.		X				
Change the automatic transaxle fluid and filter. ◇		X				

302 MAINTENANCE SCHEDULES

Miles (Kilometers)	75,000 (120 000)	78,000 (125 000)	81,000 (130 000)	84,000 (135 000)	87,000 (130 000)	90,000 (144 000)
Change engine oil and engine oil filter.	X	X	X	X	X	X
Inspect the brake linings.				X		
Inspect the <b>engine air cleaner filter</b> and replace as necessary.*	X					
Replace the <b>engine air cleaner filter</b> .						X
Replace the <b>spark plugs</b> .						X
Inspect the tie rod ends and boot seals.						X
Inspect the <b>PCV valve</b> and replace if necessary. Not required if previously changed. * ‡						X
Replace the <b>engine timing belt</b> . *						X
Inspect the <b>PCV make-up air filter</b> . Replace as necessary.	X					X
Adjust the generator drive belt tension.						X

Miles (Kilometers)	93,000 (150 000)	96,000 (154 000)	99,000 (159 000)	102,000 (164 000)	105,000 (168 000)
Change engine oil and engine oil filter.	X	X	X	X	X
Inspect the brake linings.		X			
Change the brake fluid. If vehicle is used for trailer towing.		X			
Inspect the <b>engine air cleaner filter</b> and replace as necessary.*					X
Change the manual transaxle fluid.†		X			
Flush and replace the engine coolant at 60 months or 102,000 miles.				X	
Inspect the <b>PCV make-up air filter</b> . Replace as necessary.					X

304 MAINTENANCE SCHEDULES

Miles (Kilometers)	108,000 (173 000)	111,000 (178 000)	114,000 (183 000)	117,000 (188 000)	120,000 (193 000)
Change engine oil and engine oil filter.	X	X	X	X	X
Inspect the brake linings.			X		
Inspect the <b>engine air cleaner filter</b> and replace as necessary.*	X				
Inspect the tie rod ends and boot seals.					X
Inspect the <b>PCV make-up air filter</b> . Replace as necessary.	X				X
Adjust the generator drive belt tension.					X
Change automatic transaxle fluid and filter. ◇					X

\* This maintenance is recommended by the manufacturer to the owner but is not required to maintain the emissions warranty.

‡ This maintenance is not required if previously replaced.

† This maintenance is required only for police, taxi, limousine type operation, or trailer towing.

◇ This maintenance is required only for police, taxi, limousine type operation, or trailer towing.

Inspection and service should also be performed anytime a malfunction is observed or suspected. Retain all receipts.



**SCHEDULE "A"—2.4L NON TURBO CHARGED ENGINES**

<b>Miles (Kilometers ) [Months]</b>	<b>6,000 (10 000) [6]</b>	<b>12,000 (19 000) [12]</b>	<b>18,000 (29 000) [18]</b>	<b>24,000 (38 000) [24]</b>	<b>30,000 (48 000) [30]</b>	<b>36,000 (58 000) [36]</b>
Change engine oil and engine oil filter.	X	X	X	X	X	X
Inspect the brake linings.			X			X
Replace the <b>engine air cleaner filter</b> .					X	
Replace the <b>spark plugs</b> .					X	
Inspect the tie rod ends and boot seals.					X	
Replace the <b>PCV make-up air filter</b> .					X	
Adjust the generator drive belt tension					X	

306 MAINTENANCE SCHEDULES

Miles (Kilometers) [Months]	42,000 (67 000) [42]	48,000 (77 000) [48]	54,000 (86 000) [54]	60,000 (96 000) [60]	66,000 (106 000) [66]
Change engine oil and engine oil filter.	X	X	X	X	X
Inspect the brake linings.			X		
Replace the <b>engine air cleaner filter</b> .				X	
Replace the <b>spark plugs and ignition cables</b> .				X	
Inspect the tie rod ends and boot seals.				X	
Inspect the <b>PCV valve</b> and replace, if necessary.*				X	
Flush and replace the engine coolant at 60 months, regardless of mileage.				X	
Replace the <b>PCV make-up air filter</b> .				X	
Adjust the generator drive belt tension.				X	

Miles (Kilometers)	72,000 (115 000)	78,000 (125 000)	84,000 (134 000)	90,000 (144 000)	96,000 (154 000)	102,000 (163 000)
[Months]	[72]	[78]	[84]	[90]	[96]	[102]
Change engine oil and engine oil filter.	X	X	X	X	X	X
Inspect the brake linings.	X			X		
Replace the <b>engine air cleaner filter</b> .				X		
Replace the <b>spark plugs</b> .				X		
Inspect the tie rod ends and boot seals.				X		
Inspect the <b>PCV valve</b> and replace if necessary. Not required if previously changed. * ‡				X		
Replace the <b>PCV make-up air filter</b> .				X		
Adjust the generator drive belt tension.				X		
Flush and replace the engine coolant at 60 months or 102,000 miles.						X

308 MAINTENANCE SCHEDULES

Miles (Kilometers) [Months]	108,000 (173 000) [108]	114,000 (182 000) [114]	120,000 (192 000) [120]
Change engine oil and engine oil filter.	X	X	X
Inspect the <b>PCV valve</b> and replace if necessary. *			X

\* This maintenance is recommended by the manufacturer to the owner but is not required to maintain the emissions warranty.

‡ This maintenance is not required if previously replaced.

Inspection and service should also be performed anytime a malfunction is observed or suspected. Retain all receipts.

**SCHEDULE “A”—2.4L TURBOCHARGED ENGINES**

<b>Miles (Kilometers) [Months]</b>	<b>5,000 (8 000) [6]</b>	<b>10,000 (16 000)</b>	<b>15,000 (24 000) [12]</b>	<b>20,000 (32 000) [18]</b>	<b>25,000 (40 000)</b>	<b>30,000 (48 000) [24]</b>
Change engine oil and engine oil filter.	X	X	X	X	X	X
Inspect the brake linings.				X		
Replace the <b>engine air cleaner filter</b> .						X
Replace the <b>spark plugs</b> .						X
Inspect the tie rod ends and boot seals.						X
Replace the <b>PCV make-up air filter</b> .						X
Adjust the generator drive belt tension.						X

**310 MAINTENANCE SCHEDULES**

<b>Miles (Kilometers) [Months]</b>	<b>35,000 (56 000) [30]</b>	<b>40,000 (64 000)</b>	<b>45,000 (72 000) [36]</b>	<b>50,000 (80 000) [42]</b>	<b>55,000 (88 000)</b>
Change engine oil and engine oil filter.	X	X	X	X	X
Inspect the brake linings.		X			

Miles (Kilometers)	60,000 (96 000)	65,000 (104 000)	70,000 (112 000)	75,000 (120 000)	80,000 (128 000)	85,000 (136 000)
[Months]	[48]	[54]		[60]	[66]	
Change engine oil and engine oil filter.	X	X	X	X	X	X
Inspect the brake linings.	X				X	
Replace the <b>engine air cleaner filter</b> .	X					
Replace the <b>spark plugs and ignition cables</b> .	X					
Inspect the tie rod ends and boot seals.	X					
Inspect the <b>PCV valve</b> and replace if necessary. Not required if previously changed. * ‡	X					
Flush and replace the engine coolant at 60 months, regardless of mileage.				X		
Replace the <b>PCV make-up air filter</b> .	X					
Adjust the generator drive belt tension.	X					

312 MAINTENANCE SCHEDULES

Miles (Kilometers) [Months]	90,000 (144 000) [72]	95,000 (156 000) [78]	100,000 (160 000)	105,000 (168 000) [84]
Change engine oil and engine oil filter.	X	X	X	X
Inspect the brake linings.			X	
Replace the <b>engine air cleaner filter</b> .	X			
Replace the <b>spark plugs</b> .	X			
Adjust the generator drive belt tension.	X			
Inspect the tie rod ends and boot seals.	X			
Inspect the <b>PCV valve</b> and replace if necessary. Not required if previously changed. * ‡	X			
Flush and replace the engine coolant if not done at 60 months.			X	
Replace the <b>PCV make-up air filter</b> .	X			
Replace the <b>engine timing belt</b> .				X



Miles (Kilometers) [Month]	110,000 (177 000) [90]	115,000 (185 000) [96]	120,000 (193 000) [102]
Change engine oil and engine oil filter.	X	X	X
Inspect the <b>PCV Valve</b> and replace if necessary. *			X

\* This maintenance is recommended by the manufacturer to the owner but is not required to maintain the emissions warranty.

‡ This maintenance is not required if previously replaced.

Inspection and service should also be performed anytime a malfunction is observed or suspected. Retain all receipts.

<b>WARNING!</b>
<b>You can be badly injured working on or around a motor vehicle. Do only that service work for which you have the knowledge and the right equipment. If you have any doubt about your ability to perform a service job, take your vehicle to a competent mechanic.</b>



---

## IF YOU NEED CONSUMER ASSISTANCE

### CONTENTS

---

■ Suggestions For Obtaining Service For Your Vehicle . . . . .	316	■ Reporting Safety Defects . . . . .	321
□ Prepare For The Appointment . . . . .	316	□ In Canada . . . . .	321
□ Prepare A List . . . . .	316	■ Publication Order Forms . . . . .	322
□ Be Reasonable With Requests . . . . .	316	■ Department Of Transportation Uniform Tire Quality Grades . . . . .	323
■ If You Need Assistance . . . . .	316	□ Treadwear . . . . .	323
■ Warranty Information . . . . .	319	□ Traction Grades . . . . .	323
■ Mopar® Parts . . . . .	321	□ Temperature Grades . . . . .	324

**SUGGESTIONS FOR OBTAINING SERVICE FOR YOUR VEHICLE****Prepare For The Appointment**

If you're having warranty work done, be sure to have the right papers with you. Take your warranty folder. All work to be performed may not be covered by the warranty, discuss additional charges with the service manager. Keep a maintenance log of your vehicle's service history. This can often provide a clue to the current problem.

**Prepare A List**

Make a written list of your vehicle's problems or the specific work you want done. If you've had an accident, or work done that is not on your maintenance log, let the service advisor know.

**Be Reasonable With Requests**

If you list a number of items, and you must have your vehicle by the end of the day, discuss the situation with the service advisor and list the items in order of priority. At many dealers you may obtain a rental vehicle at a minimal daily charge. If you need a rental, it is advisable to make these arrangements when you call for an appointment.

**IF YOU NEED ASSISTANCE**

The manufacturer and its dealers are vitally interested in your satisfaction. We want you to be happy with our products and services.

Your selling dealer is best equipped and most anxious to provide prompt resolution for any warranty issue or related matter that you may experience. The manufacturer's dealers have the facilities, factory-trained technicians, special tools, and the latest information to assure your vehicle is fixed correctly and in a timely manner.

The manufacturer has empowered its dealers to make warranty and repair decisions that ensure you are not inconvenienced. There is no need for you to wait for a decision from the manufacturer. If a special circumstance occurs that requires information from the manufacturer, we have asked the dealer's service management to make the contact on your behalf.

This is why you should always talk to your dealer's service manager first. Most matters can be resolved with this process.

- If for some reason you are still not satisfied, talk to the general manager or owner of the dealership. They want to know if you need assistance.
- If your dealership is unable to resolve the concern, you may contact the Manufacturer's Customer Center.

Any communication to the Manufacturer's Customer Center should include the following information:

- Owner's name and address
- Owner's telephone number (home and office)
- Dealership name
- Vehicle identification number
- Vehicle delivery date and mileage

***DaimlerChrysler Motors Corporation Customer Center***

P.O. Box 21-8004

Auburn Hills, MI 48321-8004

Phone: (800) 992-1997

***DaimlerChrysler Canada Inc. Customer Center***

P.O. Box 1621

Windsor, Ontario N9A 4H6

Phone —(800) 465-2001

***In Mexico contact:***

Av. Prolongacion Paseo de la Reforma, 1240  
Sante Fe C.P. 05109  
Mexico, D. F.  
In Mexico (915) 729-1248 or 729-1240  
Outside Mexico (525) 729-1248 or 729-1240

***Customer Assistance For The Hearing Or Speech Impaired (TDD/TTY)***

To assist customers who have hearing difficulties, the manufacturer has installed special TDD (Telecommunication Devices for the Deaf) equipment at its Customer Center. Any hearing or speech impaired customer who has access to a TDD or a conventional teletypewriter (TTY) in the United States can communicate with the manufacturer by dialing 1-800-380-CHRY.

***Service Contract***

You may have purchased a service contract for your vehicle to help protect you from the high cost of unexpected repairs after your manufacturer's new vehicle limited warranty expires. The manufacturer stands behind only the manufacturer's Service Contracts. If you purchased a manufacturer's Service Contract, you will receive Plan Provisions and an Owner Identification Card in the mail within three weeks of your vehicle delivery date. If you have any questions about your service contract, call the manufacturer's Service Contract National Customer Hotline at 1-800-521-9922.

The manufacturer will not stand behind any service contract that is not the manufacturer's Service Contract. It is not responsible for any service contract other than the manufacturer's Service Contract. If you purchased a service contract that is not a manufacturer's Service

Contract, and you require service after your manufacturer's new vehicle limited warranty expires, please refer to your contract documents, and contact the person listed in those documents.

We appreciate that you have made a major investment when you purchased your new vehicle. Your dealer has also made a major investment in facilities, tools, and training to assure that you are absolutely delighted with your ownership experience. You'll be pleased with their

sincere efforts to resolve any warranty issues or related concerns.

**WARRANTY INFORMATION**

See your manufacturer's Warranty Information Booklet for information on warranty coverage and transfer of warranty.

320 IF YOU NEED CONSUMER ASSISTANCE

DESCRIPTION	1 Yr/ 12,000	2 Yr/ 24,000	3 Yr/ 36,000	3 Yr/ 50,000	3 Yr/ Unimtd	5 Yr/ 100,000	7 Yr/ 70,000	8 Yr/ 80,000
Basic Limited Warranty Coverage								
<b>Special Extended Warranty Coverage</b>								
Powertrain Limited Warranty (\$100 deductible)				1st Owner & 2nd Owner with Paid Powertrain Transfer				
	2nd Owner if Powertrain Not Transferred and 3rd (And After) Owners							
Anti-Corrosion Perforation Limited Warranty: All Panels								
Outer Panels								
Federal Emission Warranty								
Federal Emission Warranty - Specified Components								
California Emission Warranty								
California Emission Warranty - Specified Components								

**NOTE:** Vehicles used as a police vehicle, taxi, limousine, postal delivery vehicle, ambulance or rental vehicle are covered only under the 3 year/36,000 mile Basic Limited Warranty. 8132c269



**MOPAR® PARTS**

Mopar® fluids, lubricants, parts, and accessories are available from your dealer. They will help you keep your vehicle operating at its best.

**REPORTING SAFETY DEFECTS**

In the 50 United States and Washington D.C.: If you believe that your vehicle has a defect which could cause a crash or cause injury or death, you should immediately inform the National Highway Traffic Safety Administration (NHTSA) in addition to notifying the manufacturer.

If NHTSA receives similar complaints, it may open an investigation, and if it finds that a safety defect exists in a group of vehicles, it may order a recall and remedy campaign. However, NHTSA cannot become involved in individual problems between you, your dealer, and the manufacturer.

To contact NHTSA, you may either call the Auto Safety Hotline toll free at 1-800-424-9393 (or 366-0123 in Washington DC area) or write to: NHTSA, U.S. Dept. of Transportation, Washington DC 20590. You can also obtain other information about motor vehicle safety from the Hotline.

**In Canada:**

If you believe that your vehicle has a safety defect, you should contact the Customer Service Department immediately. Canadian customers who wish to report a safety defect to the Canadian government should write to Transport Canada, Motor Vehicle Defect Investigations and Recalls, 2780 Sheffield Road, Ottawa, Ontario K1B 3V9.

**PUBLICATION ORDER FORMS**

To order the following manuals, you may use either the website or the phone numbers listed below. Visa, Mastercard, American Express, and Discover orders are accepted. If you prefer mailing your payment, please call for an order form.

**NOTE:** A street address is required when ordering manuals. (No P.O. Boxes).

- *Service Manuals.*

These comprehensive service manuals provide the information that students and professional technicians need in diagnosing/troubleshooting, problem solving, maintaining, servicing and repairing DaimlerChrysler Corporation vehicles. A complete working knowledge of the vehicle, system and/or components is written in straightforward language with illustrations, diagrams and charts.

- *Diagnostic Procedure Manuals.*

Filled with diagrams, charts and detailed illustrations, these practical manuals make it easy for students and technicians to find and fix problems on computer-controlled vehicle systems and features. They show exactly how to find and correct problems the first time, using step-by-step troubleshooting and driveability procedures, proven diagnostic tests and a complete list of all tools and equipment.

- *Owner's Manuals.*

These manuals have been prepared with the assistance of service and engineering specialists to acquaint you with specific Chrysler group vehicles. Included are starting, operating, emergency and maintenance procedures as well as specifications, capabilities and safety tips.

Call Toll Free at 1-800-890-4038 (U.S.) or 1-800-387-1143 (Canada)

Or

Visit us on the World Wide Web at:

[www.techauthority.daimlerchrysler.com](http://www.techauthority.daimlerchrysler.com) or  
[www.daimlerchrysler.ca/manuals](http://www.daimlerchrysler.ca/manuals)

#### **DEPARTMENT OF TRANSPORTATION UNIFORM TIRE QUALITY GRADES**

The following describes the tire grading categories established by the National highway Traffic Safety Administration. The specific grade rating assigned by the tire's manufacturer in each category is shown on the sidewall of the tires on your car.

All Passenger Car Tires Must Conform to Federal Safety Requirements in Addition to These Grades.

#### **Treadwear**

The treadwear grade is a comparative rating based on the wear rate of the tire when tested under controlled conditions on a specified government test course. For example, a tire graded 150 would wear one and a half (1 1/2) times as well on the government course as a tire graded 100. The relative performance of tires depends upon the actual conditions of their use, however, and may depart significantly from the norm due to variations in driving habits, service practices and differences in road characteristics and climate.

#### **Traction Grades**

The traction grades, from highest to lowest, are A, B, and C, and they represent the tire's ability to stop on wet pavement as measured under controlled conditions on specified government test surfaces of asphalt and concrete. A tire marked C may have poor traction performance.

**WARNING!**

The traction grade is based on braking (straight-ahead) traction tests and does not include cornering (turning) performance.

**Temperature Grades**

The temperature grades are A (highest), B, and C, representing the tire's resistance to the generation of heat and its ability to dissipate heat when tested under controlled conditions on a specified indoor laboratory test wheel. Sustained high temperature can cause the material of the tire to degenerate and reduce tire life, and excessive temperature can lead to sudden tire failure. The grade C corresponds to a level of performance which all passenger car tires must meet under the Federal Motor Vehicle Safety Standard No. 109. Grades B and A represent higher levels of performance on the laboratory test wheel than the minimum required by law.

**WARNING!**

The temperature grade is established for a tire that is properly inflated and not overloaded. Excessive speed, underinflation, or excessive loading, either separately or in combination, can cause heat buildup and possible tire failure.

---

# INDEX

ABS (Anti-Lock Brake) System	194	Alignment and Balance	213
Adding Engine Coolant (Antifreeze)	267	Alterations/Modifications, Vehicle	7
Adding Fuel	221	Antenna, Satellite Radio	164
Adding Washer Fluid	175	Antifreeze (Engine Coolant)	267,290,291
Additives, Fuel	219	Capacities	290
Air Cleaner, Engine	258	Anti-Lock Brake System	194
Air Conditioning	261	Anti-Lock Warning Light	131
Air Conditioning Controls	166	Anti-Theft Security Alarm	26
Air Conditioning, Operating Tips	171	Appearance Care	276
Air Conditioning Refrigerant	261	Auto Down Power Windows	31
Air Conditioning System	166,261	Automatic Door Locks	20
Air Pressure, Tires	207	Automatic Transaxle	12,180,183,273
Airbag	41	Fluid and Filter Changes	275
Airbag Deployment	48	Fluid Level Check	273,274
Airbag Light	45,50,60,134	Interlock System	18,184
Airbag Maintenance	49	Reset Mode	184
Airbag, Side	47	Selection Of Lubricant	273
Alarm, Panic	23	Shifting	185
Alarm System	26,129	Special Additives	276

Autostick .....	135,187	Brake/Transmission Interlock .....	184
Back-Up Lights .....	289	Break-In Recommendations, New Vehicle .....	59
Ball Joints .....	262	Bulb Replacement .....	286,287
Battery .....	259	Bulbs, Light .....	286
Keyless Transmitter Replacement .....	25	Calibration, Compass .....	107
Belts, Drive .....	256	Capacities, Antifreeze (Engine Coolant) .....	290
Belts, Engine .....	258	Capacities, Fluid .....	290
Body Mechanism Lubrication .....	262	Caps, Filler	
B-Pillar Location .....	202	Fuel .....	221
Brake Fluid .....	292	Radiator .....	267
Brake, Parking .....	192	Carbon Monoxide Warning .....	220
Brake System .....	194,270	Cargo Compartment	
Anti-Lock .....	194	Luggage Carrier .....	119
Hoses .....	270	Carrier, Luggage .....	119
Master Cylinder .....	271	Cassette Tape and Player Maintenance .....	165
Parking .....	192	Cassette Tape Player .....	138
Warning Light .....	132	Catalytic Converter .....	256
Brakes .....	194,270	Caution, Exhaust Gas .....	59

CD Changer	146,152	Compact Disc Player	138,144
CD Player	144,148,150,154,157	Compact Spare Tire	210
CD Player Maintenance	166	Compass	105
Cellular Phone	70,166	Compass Calibration	107
Center High Mounted Stop Light	289	Compass Variance	106
Central Door Locks	20	Console	112
Chains, Tire	214	Console, Overhead	104
Changing A Flat Tire	230	Contract, Service	318
Chart, Tire Sizing	199	Cool Down, Turbo	182
Child Restraint	50	Coolant	290,291
Child Restraint Tether Anchors	55	Coolant Pressure Cap	267
Child Restraint with Automatic Belts	54	Cooling System	265
Child Safety Locks	21	Adding Coolant (Antifreeze)	267
Child Seat	56	Coolant Level	266,268
Clean Air Gasoline	217	Disposal of Used Coolant	266
Climate Control	166	Drain, Flush, and Refill	266
Clock	136	Inspection	268
Coin Holder	112	Points to Remember	268
Compact Disc Maintenance	166	Pressure Cap	267



Radiator Cap .....	267	Downshifting .....	191
Selection of Coolant .....	267	Drive Belts .....	256
Corrosion Protection .....	276	Driving .....	
Crankcase Emission Control System .....	258	On Slippery Surfaces .....	238
Cruise Light .....	133	Electric Rear Window Defrost .....	173
Cup Holder .....	112	Electric Remote Mirrors .....	68
Customer Assistance .....	316	Electrical Power Outlets .....	110
Dealer Service .....	250	Electronic Power Distribution Center .....	282
Defroster, Rear Window .....	173	Electronic Speed Control .....	101
Defroster, Windshield .....	60,168,169	Emergency, In Case of .....	
Delay Wipers .....	99	Jacking .....	230
Diagnostic System, Onboard .....	248	Jump Starting .....	235
Dimmer Switch, Headlight .....	97	Towing .....	240
Disposal .....		Emergency Trunk Release .....	29
Engine Oil .....	255	Emission Control System Maintenance .....	249,294
Door Ajar .....	133	Engine .....	246,247
Door Locks .....	18	Break-In Recommendations .....	59
Door Locks, Automatic .....	20	Checking Oil Level .....	251

Exhaust Gas Caution	220	Engine Oil	255,291
Fuel Requirements	216	Flashers	228
Jump Starting	235	Hazard Warning	228
Oil	251,290,291	Flat Tire Stowage	235
Oil Change Interval	252	Flooded Engine Starting	181
Oil Filter	291	Fluid, Brake	292
Oil Selection	253	Fluid Capacities	290
Oil Synthetic	255	Fluid Leaks	61
Overheating	228	Fluid Level Checks	
Temperature Gauge	130	Automatic Transaxle	273
Timing Belt	258	Fog Light Service	288
Engine Oil Viscosity Chart	254	Fog Lights	97,135
Exhaust Gas Caution	28,59,220,264	Folding Rear Seat	86
Exhaust System	264	Freeing A Stuck Vehicle	239
Filler Location Fuel	135	Fuel	216,291
Filters		Adding	221
Air Cleaner	258	Additives	219
Engine Fuel	258	Capacity	290
		Clean Air	217

Filler Cap .....	135,221	Gauges	
Filler Door .....	135	Coolant Temperature .....	130
Filter .....	258	Fuel .....	129
Gasoline .....	216	Tachometer .....	131
Gauge .....	129	Gearshift .....	185
Hoses .....	270	General Information .....	17,24
Light .....	135	General Maintenance .....	251
Octane Rating .....	216	Glass Cleaning .....	281
Requirements .....	216	Hands-Free Phone .....	70
System Hoses .....	270	Hazard Warning Flasher .....	228
Tank Capacity .....	290	Head Restraints .....	85
Fueling .....	221	Headlights	
Fuses .....	282	Bulb Replacement .....	287
Gas Cap .....	221	Cleaning .....	281
Gasoline .....	216,290	High Beam .....	97,131
Gasoline, Clean Air .....	217	High Beam/Low Beam Select Switch .....	97
Gasoline, Reformulated .....	217	Passing .....	97
		Switch .....	96

Heated Seats	85	Intermittent Wipers	99
Hood Release	92	Introduction	4
Hoses	269		
Ignition	12	Jack Location	231
Key	12	Jack Operation	230,233
Wiring System	256	Jacking Instructions	233
Immobilizer	14,27	Jump Starting	235
Indicator, Traction Control	132,134	Key, Programming	16
Infant Restraint	51	Key Release Button	13
Inside Rearview Mirror	67	Key, Replacement	16
Instrument Cluster	126,129	Key, Sentry	14
Instrument Panel and Controls	125	Key-In Reminder	14
Instrument Panel Cover	281	Keyless Entry System	22
Instrument Panel Lens Cleaning	281	Keys	12
Integrated Power Module	282	Knee Bolster	45,47
Interior Appearance Care	280		
Interior Fuses	285	Lane Change and Turn Signals	130
Interior Lights	94	Lap/Shoulder Belts	33

Latches		High Beam Indicator	131
Hood	92	Instrument Cluster	96
Lead Free Gasoline	216	Interior	94
Liftgate	28	Liftgate Ajar	129
Light Bulbs	286,287	Lights On Reminder	96
Lights	61,93	Low Fuel	135
Airbag	45,50,60,134	Malfunction Indicator	134
Anti-Lock	131	Oil Pressure	129
Back-Up	289	Rear Servicing	288
Brake Warning	132	Seat Belt Reminder	131
Center Mounted Stop	289	Security Alarm	26
Courtesy/Reading	93	Service	287
Daytime Running	96	Theft Alarm	129
Dimmer Switch, Headlight	95	Traction Control	132,134,197
Engine Temperature Warning	130	Turn Signal	95,97,130,288
Fog	97,135,288	Voltage	129
Front Replacement	287	Warning (Instrument Cluster Description)	129
Headlight Switch	96	Loading Vehicle	223
Headlights	96	Tires	202

Locks			
Central	20	Downshifting	191
Child Protection	21	Fluid Level Check	276
Door	18	Frequency of Fluid Change	276
Power Door	19	Lubricant Selection	276
Steering Wheel	17	Master Cylinder	271
Lubrication, Body	262	Mirrors	67
Luggage Rack	119	Electric Remote	68
		Outside	67
Maintenance Free Battery	259	Rearview	67
Maintenance, General	251	Vanity	69
Maintenance Procedures	251	Modifications/Alterations, Vehicle	7
Maintenance Schedule		Mopar Parts	250,321
Schedule "A"	305,309	Multi-Function Control Lever	95
Schedule "B"	297		
Maintenance Schedules	294	Navigation System	161
Malfunction Indicator Light	134,249	New Vehicle Break-In Period	59
Manual, Service	322		
Manual Transaxle	180,189,276	Occupant Restraints	32
		Octane Rating, Gasoline	216

Odometer	133	Overhead Console	104
Trip	133,135	Overhead Travel Information Center	104
Oil, Engine	251,290	Overheating, Engine	228
Capacity	290	Owner's Manual	4,322
Change Interval	252	Paint Care	276
Checking	251	Panel Rear Shelf	114
Disposal	255	Panic Alarm	23
Filter	255	Parking Brake	192
Identification Logo	254	Passing Light	97
Materials Added to	255	Pets	58
Quality	254	Phone, Cellular	70
Recommendation	253,290	Phone, Hands-Free	70
Synthetic	255	Placard, Tire and Loading Information	202
Viscosity	254	Power	
Oil Pressure Light	129	Distribution Center	282
Onboard Diagnostic System	248,249	Door Locks	19
Operator Manuals	4	Outlet	110
Outside Air Intake	172	Steering	196,261
Overdrive	186		

Steering, Checking	261	Rear Shelf Panel	114
Sunroof	108	Rear Window	31
Windows	30	Rear Window Defroster	173
Power Steering Fluid	292	Rear Window Features	173
Pregnant Women and Seat Belts	41	Rear Wiper/Washer	174
Preparation for Jacking	232	Reclining Front Seats	84
Pretensioners		Recommended Fluids, Lubricants and Genuine	
Seat Belts	41	Parts	291
Programming Transmitters	24	Remote Keyless Entry	22
Radial Ply Tires	210	Replacement Bulbs	286
Radiator Cap	267	Replacement Keys	16
Radio	138,148,154	Replacement Parts	250
Radio Broadcast Signals	136	Replacement Tires	212
Radio Operation	148,166	Reporting Safety Defects	321
Radio, Satellite	161	Restraints, Child	50,56
Rear Liftgate	28	Restraints, Infant	51
Rear Seat, Folding	86,88	Roof Rack	119
Rear Seat Removal	90	Rotation, Tires	215



Safety Checks Inside Vehicle	60	Seats	82
Safety Checks Outside Vehicle	61	Adjustment	82
Safety Defects, Reporting	321	Head Restraints	85
Safety Information, Tire	197	Heated	85
Safety Tips	59	Height Adjustment	83
Satellite Radio	161	Rear Folding	86,88
Satellite Radio Antenna	164	Reclining	84
Schedule, Maintenance	294	Removal	90
Seat Belts	32	Security Alarm	26
Adjustable Shoulder Belt	38	Sentry Key	14,27
Adjustable Upper Shoulder Anchorage	38	Sentry Key Programming	16
And Pregnant Women	41	Service and Maintenance	294
Child Restraint	50	Service Assistance	316
Cleaning	282	Service Contract	318
Front Seat	33	Service Manuals	322
Pretensioners	41	Setting the Clock	136
Rear Seat	33	Severe Service	297
Reminder	131	Shift Speeds, Manual Transaxle	190
Untwisting Procedure	39	Shoulder Belts	33

Side Airbag	47	Storage Bin	114
Side Window Demisters	173	Stuck, Freeing	239
Slippery Surfaces, Driving On	238	Sulfur in Gasoline	218
Snow Tires	214	Sun Roof	108
Spare Tire	231	Sun Visor Extension	70
Spark Plugs	256	Supplemental Restraint System - Airbag	41
Speed Control	101,133	Synthetic Engine Oil	255
Speedometer	130	System, Navigation	161
Speedometer and Odometer	126	Tachometer	131
Starting	180	Temperature Gauge, Engine Coolant	130,229
Automatic Transmission	180	Tether Anchor, Child Restraint	55
Engine Fails to Start	181	Theft Alarm	26
Manual Transmission	180	Theft System	26
Starting Procedures	180	Tilt Steering Column	100
Steering		Tire and Loading Information Placard	202
Power	196,261	Tire Identification Number (TIN)	201
Tilt Column	100	Tire Markings	197
Wheel Lock	17	Tire Safety Information	197
Storage	114,285		

Tires . . . . .	61,206,323	Spare Tire . . . . .	231
Air Pressure . . . . .	206	Spinning . . . . .	211
Alignment . . . . .	213	Tread Wear Indicators . . . . .	212
Chains . . . . .	214	Towing . . . . .	
Changing . . . . .	230	Disabled Vehicle . . . . .	240
Compact Spare . . . . .	210	Traction . . . . .	238
Flat Changing . . . . .	235	Traction Control . . . . .	100,132,134,196
General Information . . . . .	206	Traction Control Switch . . . . .	100,196
High Speed . . . . .	209	Trailer Towing . . . . .	223
Inflation Pressures . . . . .	207	Minimum Requirements . . . . .	224
Jacking . . . . .	230	Trailer and Tongue Weight . . . . .	224
Load Capacity . . . . .	202,203	Warnings . . . . .	223
Quality Grading . . . . .	323	Transaxle . . . . .	183
Radial . . . . .	210	Automatic . . . . .	12,180,183,273
Replacement . . . . .	212	Autostick . . . . .	187
Rotation . . . . .	215	Manual . . . . .	13,180,189
Safety . . . . .	197,206	Operation . . . . .	183
Sizes . . . . .	199	Overdrive . . . . .	186
Snow Tires . . . . .	214	Selection of Lubricant . . . . .	273

Transmitter Battery Service .....	25	Vehicle Loading .....	203,223
Transmitter Programming .....	24	Vehicle Modifications/Alterations .....	7
Transmitter, Remote Keyless Entry .....	22	Vehicle Storage .....	285
Transporting Pets .....	58	Vehicle Theft Alarm .....	26
Tread Wear Indicators .....	212	Warning, Door Ajar .....	133
Trip Odometer Reset Button .....	133,135	Warning Lights (Instrument Cluster Description) .	129
Trunk Release, Emergency .....	29	Warnings and Cautions .....	6
Turbo Cool Down .....	182	Warranty Information .....	319
Turn Signals .....	97,130	Washer, Adding Fluid .....	175
Understanding Your Instrument Panel .....	125	Washer, Rear .....	174
Uniform Tire Quality Grades .....	323	Washers, Windshield .....	98
Unleaded Gasoline .....	216	Washing Vehicle .....	277
Untwisting Procedure, Seat Belt .....	39	Wheel Alignment and Balance .....	213
Vacuum/Vapor Harnesses .....	269	Wheel and Wheel Trim Care .....	279
Vanity Mirrors .....	69	Wind Buffeting .....	32,109
Variance, Compass .....	106	Window Fogging .....	172
Vehicle Identification Number .....	6	Windows .....	30
		Windshield Washers .....	98

Windshield Wipers . . . . .	98,263	Wiper, Rear . . . . .	174
Wiper Blade Replacement . . . . .	263	Wipers, Intermittent . . . . .	99

## Free Manuals Download Website

<http://myh66.com>

<http://usermanuals.us>

<http://www.somanuals.com>

<http://www.4manuals.cc>

<http://www.manual-lib.com>

<http://www.404manual.com>

<http://www.luxmanual.com>

<http://aubethermostatmanual.com>

Golf course search by state

<http://golfingnear.com>

Email search by domain

<http://emailbydomain.com>

Auto manuals search

<http://auto.somanuals.com>

TV manuals search

<http://tv.somanuals.com>