



Cisco SCE 2000 4xGBE Installation and Configuration Guide

Version 3.0
OL-7824-04

Corporate Headquarters
Cisco Systems, Inc.
170 West Tasman Drive
San Jose, CA 95134-1706
USA
<http://www.cisco.com>
Tel: 408 526-4000
800 553-NETS (6387)
Fax: 408 526-4100

Customer Order Number: DOC-7824-04=
Text Part Number: OL-7824-04



THE SPECIFICATIONS AND INFORMATION REGARDING THE PRODUCTS IN THIS MANUAL ARE SUBJECT TO CHANGE WITHOUT NOTICE. ALL STATEMENTS, INFORMATION, AND RECOMMENDATIONS IN THIS MANUAL ARE BELIEVED TO BE ACCURATE BUT ARE PRESENTED WITHOUT WARRANTY OF ANY KIND, EXPRESS OR IMPLIED. USERS MUST TAKE FULL RESPONSIBILITY FOR THEIR APPLICATION OF ANY PRODUCTS.

THE SOFTWARE LICENSE AND LIMITED WARRANTY FOR THE ACCOMPANYING PRODUCT ARE SET FORTH IN THE INFORMATION PACKET THAT SHIPPED WITH THE PRODUCT AND ARE INCORPORATED HEREIN BY THIS REFERENCE. IF YOU ARE UNABLE TO LOCATE THE SOFTWARE LICENSE OR LIMITED WARRANTY, CONTACT YOUR CISCO REPRESENTATIVE FOR A COPY.

The following information is for FCC compliance of Class A devices: This equipment has been tested and found to comply with the limits for a Class A digital device, pursuant to part 15 of the FCC rules. These limits are designed to provide reasonable protection against harmful interference when the equipment is operated in a commercial environment. This equipment generates, uses, and can radiate radio-frequency energy and, if not installed and used in accordance with the instruction manual, may cause harmful interference to radio communications. Operation of this equipment in a residential area is likely to cause harmful interference, in which case users will be required to correct the interference at their own expense.

The following information is for FCC compliance of Class B devices: The equipment described in this manual generates and may radiate radio-frequency energy. If it is not installed in accordance with Cisco's installation instructions, it may cause interference with radio and television reception. This equipment has been tested and found to comply with the limits for a Class B digital device in accordance with the specifications in part 15 of the FCC rules. These specifications are designed to provide reasonable protection against such interference in a residential installation. However, there is no guarantee that interference will not occur in a particular installation.

Modifying the equipment without Cisco's written authorization may result in the equipment no longer complying with FCC requirements for Class A or Class B digital devices. In that event, your right to use the equipment may be limited by FCC regulations, and you may be required to correct any interference to radio or television communications at your own expense.

You can determine whether your equipment is causing interference by turning it off. If the interference stops, it was probably caused by the Cisco equipment or one of its peripheral devices. If the equipment causes interference to radio or television reception, try to correct the interference by using one or more of the following measures:

- Turn the television or radio antenna until the interference stops.
- Move the equipment to one side or the other of the television or radio.
- Move the equipment farther away from the television or radio.
- Plug the equipment into an outlet that is on a different circuit from the television or radio. (That is, make certain the equipment and the television or radio are on circuits controlled by different circuit breakers or fuses.)

Modifications to this product not authorized by Cisco Systems, Inc. could void the FCC approval and negate your authority to operate the product.

The Cisco implementation of TCP header compression is an adaptation of a program developed by the University of California, Berkeley (UCB) as part of UCB's public domain version of the UNIX operating system. All rights reserved. Copyright © 1981, Regents of the University of California.

NOTWITHSTANDING ANY OTHER WARRANTY HEREIN, ALL DOCUMENT FILES AND SOFTWARE OF THESE SUPPLIERS ARE PROVIDED "AS IS" WITH ALL FAULTS. CISCO AND THE ABOVE-NAMED SUPPLIERS DISCLAIM ALL WARRANTIES, EXPRESSED OR IMPLIED, INCLUDING, WITHOUT LIMITATION, THOSE OF MERCHANTABILITY, FITNESS FOR A PARTICULAR PURPOSE AND NONINFRINGEMENT OR ARISING FROM A COURSE OF DEALING, USAGE, OR TRADE PRACTICE.

IN NO EVENT SHALL CISCO OR ITS SUPPLIERS BE LIABLE FOR ANY INDIRECT, SPECIAL, CONSEQUENTIAL, OR INCIDENTAL DAMAGES, INCLUDING, WITHOUT LIMITATION, LOST PROFITS OR LOSS OR DAMAGE TO DATA ARISING OUT OF THE USE OR INABILITY TO USE THIS MANUAL, EVEN IF CISCO OR ITS SUPPLIERS HAVE BEEN ADVISED OF THE POSSIBILITY OF SUCH DAMAGES.

CCSP, the Cisco Square Bridge logo, Follow Me Browsing, and StackWise are trademarks of Cisco Systems, Inc.; Changing the Way We Work, Live, Play, and Learn, and iQuick Study are service marks of Cisco Systems, Inc.; and Access Registrar, Aironet, ASIST, BPX, Catalyst, CCDA, CCDP, CCIE, CCIP, CCNA, CCNP, Cisco, the Cisco Certified Internetwork Expert logo, Cisco IOS, Cisco Press, Cisco Systems, Cisco Systems Capital, the Cisco Systems logo, Cisco Unity, Empowering the Internet Generation, Enterprise/Solver, EtherChannel, EtherFast, EtherSwitch, Fast Step, FormShare, GigaDrive, GigaStack, HomeLink, Internet Quotient, IOS, IP/TV, IQ Expertise, the IQ logo, IQ Net Readiness Scorecard, LightStream, Linksys, MeetingPlace, MGX, the Networkers logo, Networking Academy, Network Registrar, Packet, PIX, Post-Routing, Pre-Routing, ProConnect, RateMUX, ScriptShare, SlideCast, SMARTnet, StrataView Plus, SwitchProbe, TeleRouter, The Fastest Way to Increase Your Internet Quotient, TransPath, and VCO are registered trademarks of Cisco Systems, Inc. and/or its affiliates in the United States and certain other countries.

All other trademarks mentioned in this document or Website are the property of their respective owners. The use of the word partner does not imply a partnership relationship between Cisco and any other company. (0501R)

Printed in the USA on recycled paper containing 10% postconsumer waste.

Cisco SCE 2000 4xGBE Installation and Configuration Guide

Copyright © 2002-2005 Cisco Systems, Inc.
All rights reserved.



Preface v

- Document Revision History v
- Audience v
- Organization vi
- Related Publications vii
- Conventions vii
- Obtaining Documentation ix
 - World Wide Web ix
 - Documentation CD-ROM ix
 - Ordering Documentation ix
 - Documentation Feedback x
- Obtaining Technical Assistance x
 - Cisco.com x
 - Technical Assistance Center xi

Overview 1-1

- The Cisco Service Control Concept 1-1
 - Service Control for Broadband Service Providers 1-2
- Cisco Service Control Capabilities 1-2
- The SCE Platform 1-3
- Management and Collection 1-4
 - Network Management 1-5
 - Subscriber Management 1-5
 - Collection 1-5
- Service Configuration Management 1-5

Introduction to the SCE Platform 2-1

- The SCE Platform 2-1
- Front Panel 2-2

- Back Panel 2-4
- Checking the Shipping Container Contents 2-5
 - SCE 2000 Component List 2-6
- SCE 2000 Installation Checklist 2-7

Topology 3-1

- The SCE 2000 Platform 3-1
- Topology Considerations 3-1
 - Functionality 3-2
 - Number of links 3-2
 - Redundancy 3-2
 - Link Continuity 3-3
- Physical Topologies 3-4
 - Single SCE 2000 Topologies 3-4
 - Two Cascaded SCE 2000s For Dual Links 3-8
 - Topology-Related Parameters 3-9

Installation and Maintenance 4-1

- Preparing to Install the SCE 2000 Platform 4-1
 - Tools and Parts Required 4-2
 - Site Requirement Guidelines 4-3
- Installing the SCE 2000 Platform 4-4
 - Installation Precautions 4-5
 - Installing the SCE 2000 on a Workbench or Tabletop 4-5
 - Rack-Mounting a SCE 2000 Platform 4-6
 - Attaching a Chassis Ground Connection 4-10
- Power Supply Overview 4-12
 - LEDs 4-13
 - Power Supply Specifications 4-14
- Removing and Replacing a Power Supply Unit 4-14
 - Powering Down the Power Supply Unit and Disconnecting Input Power 4-15
 - Removing the Power Supply Unit 4-16
 - Replacing the Power Supply Unit 4-17
 - Reconnecting the Power 4-17
- Fan Module Overview 4-20

Removing and Replacing the Fan Module 4-20

Replacing the Battery 4-22

Connecting the Management Interfaces and Performing Initial System Configuration 5-1

Connecting the Local Console 5-1

Setting Up the Local Console 5-2

Initial System Configuration 5-3

Setup Command Parameters 5-3

Step 1: Configuring Initial Settings 5-6

Step 2: Configuring the Hostname 5-7

Step 3: Setting the Passwords 5-7

Step 4: Configuring Time Settings 5-8

Step 5: Configuring the DNS Settings 5-10

Step 6: Configuring the RDR Formatter Destination 5-11

Step 7: Configuring Access Control Lists (ACLs) 5-12

Step 8: Configuring SNMP 5-16

Step 9: Configuring the Topology-Dependent Parameters 5-18

Step 10: Completing and Saving the Configuration 5-22

Connecting the Management Interface 5-25

Cabling the Management Port 5-25

Verifying Management Interface Connectivity 5-26

Cabling the Line Ports and Completing the Installation 6-1

Connecting the line ports to the network 6-1

Cabling Diagrams 6-2

Configuring the GBE Interface Parameters 6-6

Connecting the GBE Line Interface Ports 6-7

Testing Connectivity: Examining Link LEDs and Counters 6-9

Installing a Cascaded System 6-10

CLI Commands 6-11

Loading and Activating a Service Control Application 6-14

Basic SCE 2000 Platform Operations 7-1

Starting the SCE 2000 Platform 7-1

Checking Conditions Prior to System Startup 7-1

- Starting the System and Observing Initial Conditions 7-2
- Final Tests 7-3
- Managing SCE 2000 Configurations 7-4
 - Viewing Configuration 7-4
 - Saving the Configuration Settings 7-6
 - Recovering a Previous Configuration 7-8
- Performing Complex Configurations 7-9
- Rebooting and Shutting Down the SCE Platform 7-9
 - Rebooting the SCE Platform 7-9
 - Shutting Down the SCE Platform 7-10
- Troubleshooting 8-1**
 - Troubleshooting Overview 8-1
 - Troubleshooting Tools 8-2
 - CLI Commands for Troubleshooting 8-3
 - The User Log 8-4
 - Check the LEDs 8-7
 - Problem Solving Using a Subsystems Approach 8-8
 - Identifying Startup Problems 8-8
 - Troubleshooting the Power Subsystem 8-9
 - Troubleshooting the Firmware Package Installation 8-11
 - Troubleshooting the Management Subsystem 8-12
 - Troubleshooting the Link Interface Subsystem 8-14
- The External Optical Bypass Module A-1**
 - External Optical Bypass Functionality A-2
 - The External Optical Bypass Module Front Panel A-3
 - Installing the External Bypass Module A-3
 - Installing the Module in a Rack A-4
 - Cabling the External Optical Bypass Module A-4
 - Specifications A-7
- Index I-1**



Preface

This preface describes who should read the *SCE 2000 4xGBE Installation and Configuration Guide*, how it is organized, and its document conventions.

Document Revision History

Cisco Service Control Release	Part Number	Publication Date
Release 3.0	OL-7824-03	December, 2005

DESCRIPTION OF CHANGES

Added the following new features:

- Redundant Management (Mng) port.

Release 2.5.7	OL-7824-02	August, 2005
---------------	------------	--------------

Audience

This guide is for the networking or computer technician responsible for installing and configuring the *SCE 2000* platform on-site. To use this publication, you should be familiar with telecommunications equipment and installation procedures, as well as electronic circuitry and wiring practices. You should also have experience as an electronic or electromechanical technician.

This installation guide explains the initial hardware installation and basic configuration procedures for the *SCE 2000*. It contains procedures for unpacking and installing the device and performing basic configuration via the setup wizard. After completing the installation and basic configuration procedures covered in this guide, you will then use the appropriate companion publications to more completely configure your system.

This guide contains instructions on how to install and run the *SCE 2000* platform. This guide assumes a basic familiarity with telecommunications equipment and installation procedures.

Organization

The major sections of this guide are as follows:

Chapter	Title	Description
1	Introduction	This chapter provides a brief introduction to Cisco Service Control.
2	<i>Overview</i> (on page 2-1)	This chapter provides a hardware overview of the <i>SCE 2000</i> platform.
3	<i>Topology</i> (on page 3-1)	This chapter describes the possible deployment topologies of the <i>SCE 2000</i> and explains how various aspects of the topology determine the configuration of the system.
4	<i>Installation and Maintenance</i> (on page 4-1)	This chapter explains how to install a <i>SCE 2000</i> platform in a rack or in a general tabletop installation and how to install or replace the power supply units and fan modules.
5	<i>Connecting the Management Interfaces and Performing Initial System Configuration</i> (on page 5-1)	This chapter explains how to connect the <i>SCE 2000</i> platform to a local console and perform the initial system configuration via the setup wizard that runs automatically.
6	<i>Cabling the Line Ports and Completing the Installation</i> (on page 6-1)	This chapter provides instructions for cabling the Gigabit Ethernet ports for both one and two <i>SCE 2000</i> topologies, and for configuring Gigabit Ethernet (GBE) interface parameters. In a topology utilizing two <i>SCE 2000s</i> (cascade), this includes the cascade ports as well as the line ports.
7	<i>Basic SCE 2000 Platform Operations</i> (on page 7-1)	This chapter describes how to start up the <i>SCE 2000</i> platform, reboot, and shutdown. It also describes how to manage configurations.
8	<i>Troubleshooting</i> (on page 8-1)	This chapter provides basic system startup troubleshooting information.
A	<i>External Optical Bypass</i> (on page A-1)	This appendix explains how to install the optional external optical bypass module.

Related Publications

Your *SCE 2000* platform and the software running on it contain extensive features and functionality, which are documented in the following resources:

- Cisco CLI software:
 - *Cisco Service Control Engine (SCE) Software Configuration Guide*
 - *Cisco Service Control Engine (SCE) CLI Command Reference*



Note

You can access Cisco software configuration and hardware installation and maintenance documentation on the World Wide Web at *Cisco Website URL* (<http://www.cisco.com>). Translated documentation is available at the following URL: *International Cisco Website* (http://www.cisco.com/public/countries_languages.shtml).

- For initial installation and startup information, refer to the *SCE 2000 4xGBE Quick Start Guide*.
- For international agency compliance, safety, and statutory information for wide-area network (WAN) interfaces for the *SCE 2000* platform, refer to the *Regulatory Compliance and Safety Information for Cisco Service Control Engine (SCE)*.
- For installation and configuration of the other components of the Service Control solution, refer to:
 - *Cisco Service Control Management Suite Subscriber Management User Guide*
 - *Cisco Service Control Management Suite Collection Manager User Guide*
 - *Cisco Service Control Application for Broadband User Guide*
 - *Cisco Service Control Application Reporter User Guide*
- To view Cisco documentation or obtain general information about the documentation, refer to the following sources:
 - *Obtaining Documentation* on page [ix](#)
 - The Cisco Information Packet that shipped with your *SCE 2000* platform.

Conventions

This document uses the following conventions:

Convention	Description
boldface font	Commands and keywords are in boldface .
<i>italic font</i>	Arguments for which you supply values are in <i>italics</i> .
[]	Elements in square brackets are optional.
{x y z}	Alternative keywords are grouped in braces and separated by vertical bars.

[x y z]	Optional alternative keywords are grouped in brackets and separated by vertical bars.
string	A nonquoted set of characters. Do not use quotation marks around the string, or the string will include the quotation marks.
screen font	Terminal sessions and information the system displays are in screen font.
boldface screen font	Information you must enter is in boldface screen font .
<i>italic screen font</i>	Arguments for which you supply values are in <i>italic screen font</i> .
→	This pointer highlights an important line of text in an example.
^	The symbol ^ represents the key labeled Control—for example, the key combination ^D in a screen display means hold down the Control key while you press the D key.
< >	Nonprinting characters, such as passwords, are in angle brackets.
[]	Default responses to system prompts are in square brackets.
!, #	An exclamation point (!) or a pound sign (#) at the beginning of a line of code indicates a comment line.

Notes use the following conventions:



Note

Means *reader take note*. Notes contain helpful suggestions or references to materials not contained in this manual.

Cautions use the following conventions:



Caution

Means *reader be careful*. You are capable of doing something that might result in equipment damage or loss of data.

Warnings use the following conventions:



Warning

Means *reader be warned*. You are capable of doing something that might result in bodily injury.

Obtaining Documentation

The following sections provide sources for obtaining documentation from Cisco Systems.

World Wide Web

You can access the most current Cisco documentation on the World Wide Web at the following sites:

- <http://www.cisco.com>
- <http://www-china.cisco.com>
- <http://www-europe.cisco.com>

Documentation CD-ROM

Cisco documentation and additional literature are available in a CD-ROM package, which ships with your product. The Documentation CD-ROM is updated monthly and may be more current than printed documentation. The CD-ROM package is available as a single unit or as an annual subscription.

Ordering Documentation

Cisco documentation is available in the following ways:

- Registered Cisco Direct Customers can order Cisco Product documentation from the networking Products MarketPlace:
http://www.cisco.com/cgi-bin/order/order_root.pl
- Registered Cisco.com users can order the Documentation CD-ROM through the online Subscription Store:
<http://www.cisco.com/pcgi-bin/marketplace/welcome.pl>
- Nonregistered Cisco.com users can order documentation through a local account representative by calling Cisco corporate headquarters (California, USA) at 408 526-7208 or, in North America, by calling 800 553-NETS(6387).

Documentation Feedback

If you are reading Cisco product documentation on the World Wide Web, you can submit technical comments electronically. Click **Feedback** in the toolbar and select **Documentation**. After you complete the form, click **Submit** to send it to Cisco.

You can email your comments to bug-doc@cisco.com.

To submit your comments by mail, use the response card behind the front cover of your document, or write to the following address:

Attn Document Resource Connection

Cisco Systems, Inc.

170 West Tasman Drive

San Jose, CA 95134-9883

We appreciate your comments.

Obtaining Technical Assistance

Cisco provides [Cisco.com](http://www.cisco.com) (on page [x](#)) as a starting point for all technical assistance. Customers and partners can obtain documentation, troubleshooting tips, and sample configurations from online tools. For Cisco.com registered users, additional troubleshooting tools are available from the TAC website.

Cisco.com

Cisco.com is the foundation of a suite of interactive, networked services that provides immediate, open access to Cisco information and resources at anytime, from anywhere in the world. This highly integrated Internet application is a powerful, easy-to-use tool for doing business with Cisco.

Cisco.com provides a broad range of features and services to help customers and partners streamline business processes and improve productivity. Through Cisco.com, you can find information about Cisco and our networking solutions, services, and programs. In addition, you can resolve technical issues with online technical support, download and test software packages, and order Cisco learning materials and merchandise. Valuable online skill assessment, training, and certification programs are also available.

Customers and partners can self-register on Cisco.com to obtain additional personalized information and services. Registered users can order products, check on the status of an order, access technical support, and view benefits specific to their relationships with Cisco.

To access Cisco.com, go to the following website:

<http://www.cisco.com>

Technical Assistance Center

The Cisco TAC website is available to all customers who need technical assistance with a Cisco product or technology that is under warranty or covered by a maintenance contract.

Contacting TAC by Using the Cisco TAC Website

If you have a priority level 3 (P3) or priority level 4 (P4) problem, contact TAC by going to the TAC website:

<http://www.cisco.com/tac>

P3 and P4 level problems are defined as follows:

- P3—Your network is degraded. Network functionality is noticeably impaired, but most business operations continue.
- P4—You need information or assistance on Cisco product capabilities, product installation, or basic product configuration.

In each of the above cases, use the Cisco TAC website to quickly find answers to your questions.

To register for *Cisco.com* (on page *x*), go to the following website:

<http://tools.cisco.com/RPF/register/register.do>

If you cannot resolve your technical issue by using the TAC online resources, Cisco.com registered users can open a case online by using the TAC Case Open tool at the following website:

<http://www.cisco.com/tac/caseopen>

Contacting TAC by Telephone

If you have a priority level 1 (P1) or priority level 2 (P2) problem, contact TAC by telephone and immediately open a case. To obtain a directory of toll-free numbers for your country, go to the following website:

<http://www.cisco.com/warp/public/687/Directory/DirTAC.shtml>

P1 and P2 level problems are defined as follows:

- P1—Your production network is down, causing a critical impact to business operations if service is not restored quickly. No workaround is available.
- P2—Your production network is severely degraded, affecting significant aspects of your business operations. No workaround is available.

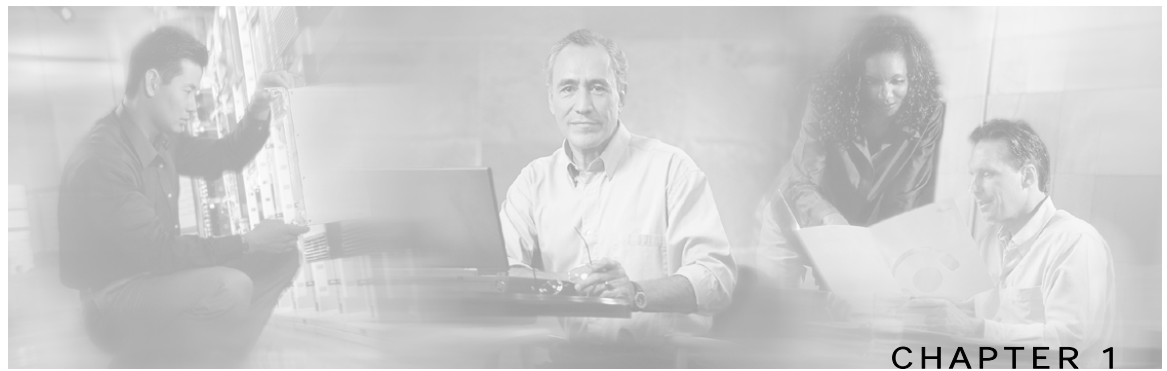

Overview

This chapter provides a general overview of the Cisco Service Control solution. It introduces the Cisco Service Control concept and the Service Control capabilities. It also briefly describes the hardware capabilities of the Service Control Engine (SCE) platform, as well as the Cisco specific applications that together compose the total Cisco Service Control solution.

This chapter contains the following sections:

- [The Cisco Service Control Concept](#) 1-1
- [Cisco Service Control Capabilities](#) 1-2
- [The SCE Platform](#) 1-3
- [Management and Collection](#) 1-4
- [Service Configuration Management](#) 1-5

The Cisco Service Control Concept

The Cisco Service Control solution is delivered through a combination of purpose-built hardware and specific software solutions that address various Service Control challenges faced by service providers. The SCE platform is designed to support classification, analysis, and control of Internet/IP traffic.

Service Control enables service providers to create profitable new revenue streams while capitalizing on their existing infrastructure. With the power of Service Control, service providers have the ability to analyze, charge for, and control IP network traffic at multi-Gigabit wire line speeds. The Cisco Service Control solution also gives service providers the tools they need to identify and target high-margin content-based services, and enable their delivery.

As the downturn in the telecommunications industry has shown, IP service providers' business models need to be reworked to make them profitable. Having spent billions of dollars to build ever larger data links, providers have incurred massive debts and rising costs. At the same time, access and bandwidth have become a commodity where prices continually fall and profits disappear. Service providers have realized that they must offer value-added services to derive more revenue from the traffic and services running on their networks. However, capturing real profits from IP services requires more than simply running those services over data links; it requires detailed monitoring and precise, real-time control and awareness of services as they are delivered. Cisco provides Service Control solutions that allow the service provider to bridge this gap.

Service Control for Broadband Service Providers

Service providers of any access technology (DSL, cable, mobile, and so on) targeting residential and business consumers must find new ways to get maximum leverage from their existing infrastructure, while differentiating their offerings with enhanced IP services.

The Cisco Service Control Application for Broadband adds a new layer of service intelligence and control to existing networks that can:

- Report and analyze network traffic at subscriber and aggregate level for capacity planning
- Provide customer-intuitive tiered application services and guarantee application SLAs
- Implement different service levels for different types of customers, content, or applications
- Identify network abusers who are violating the Acceptable Use Policy
- Identify and manage peer-to-peer, NNTP (news) traffic, and spam abusers
- Enforce the Acceptable Use Policy (AUP)
- Integrate Service Control solutions easily with existing network elements and BSS/ OSS systems

Cisco Service Control Capabilities

At the core of the Cisco Service Control solution stands the purpose-built network hardware device: the Service Control Engine (SCE). The core capabilities of the SCE platform, which support a wide range of applications for delivering Service Control solutions, include:

- Subscriber and application awareness—Application-level drilling into IP traffic for real-time understanding and controlling of usage and content at the granularity of a specific subscriber.
- Subscriber awareness—The ability to map between IP flows and a specific subscriber for maintaining the state of each subscriber transmitting traffic through the SCE platform, and enforcing the appropriate policy on this subscriber's traffic

Subscriber awareness is achieved using dedicated integrations with subscriber management repositories, such as a DHCP or a Radius server, or via sniffing of Radius or DHCP traffic

- Application awareness—The ability to understand and analyze traffic up to the application protocol layer (Layer 7)

For application protocols implemented using bundled flows (such as FTP, which is implemented using Control and Data flows), the SCE platform understands the bundling connection between the flows and treats them accordingly

- Application-layer, stateful, real-time traffic control—The ability to perform advanced control functions, including granular BW metering and shaping, quota management, and redirection, using application-layer stateful real-time traffic transaction processing. This requires highly adaptive protocol and application-level intelligence.
- Programmability—The ability to quickly add new protocols and easily adapt to new services and applications in the ever-changing service provider environment. Programmability is achieved using the Cisco Service Modeling Language (SML).

Programmability is required for new services to be deployed quickly, and it provides an easy upgrade path for network, application, or service growth.

- Robust and flexible back-office integration—The ability to integrate with existing third-party systems at the Service Provider, including provisioning systems, subscriber repositories, billing systems, and OSS systems. The SCE provides a set of open and well-documented APIs that allows a quick and robust integration process.
- Scalable high-performance service engines—The ability to perform all these operations at wire speed.

The SCE Platform

The SCE family of programmable network devices is capable of performing application-layer stateful-flow inspection of IP traffic, and controlling that traffic based on configurable rules. The SCE platform is a purpose-built network device that uses ASIC components and RISC processors to go beyond packet counting and delve deeper into the contents of network traffic. Providing programmable, stateful inspection of bidirectional traffic flows and mapping these flows with user ownership, the SCE platforms provide a real-time classification of network usage. This information provides the basis of the SCE platform advanced traffic-control and bandwidth-shaping functionality. Where most bandwidth shaper functionality ends, the SCE platform provides more control and shaping options including:

- Layer 7 stateful wire-speed packet inspection and classification
- Robust support for over 600 protocols and applications including:
 - General—HTTP, HTTPS, FTP, TELNET, NNTP, SMTP, POP3, IMAP, WAP, and others
 - P2P file sharing—FastTrack-KazaA, Gnutella, BitTorrent, Winny, Hotline, eDonkey, DirectConnect, Piolet, and others
 - P2P VoIP—Skype, Skinny, DingoTel, and others
 - Streaming & Multimedia—RTSP, SIP, HTTP streaming, RTP/RTCP, and others
- Programmable system core for flexible reporting and bandwidth control
- Transparent network and BSS/OSS integration into existing networks
- Subscriber awareness that relates traffic and usage to specific customers

The following diagram illustrates a common deployment of an SCE platform in a network.

Figure 1-1: SCE Platform in the Network

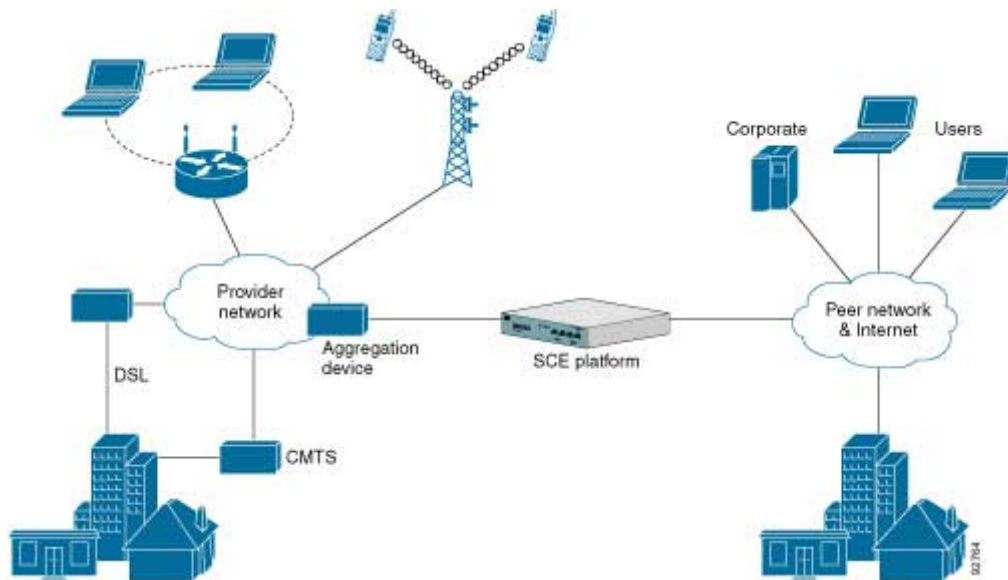

Management and Collection

The Cisco Service Control solution includes a complete management infrastructure that provides the following management components to manage all aspects of the solution:

- Network management
- Subscriber management
- Service Control management

These management interfaces are designed to comply with common management standards and to easily integrate with existing OSS infrastructure.

Figure 1-2: Service Control Management Infrastructure

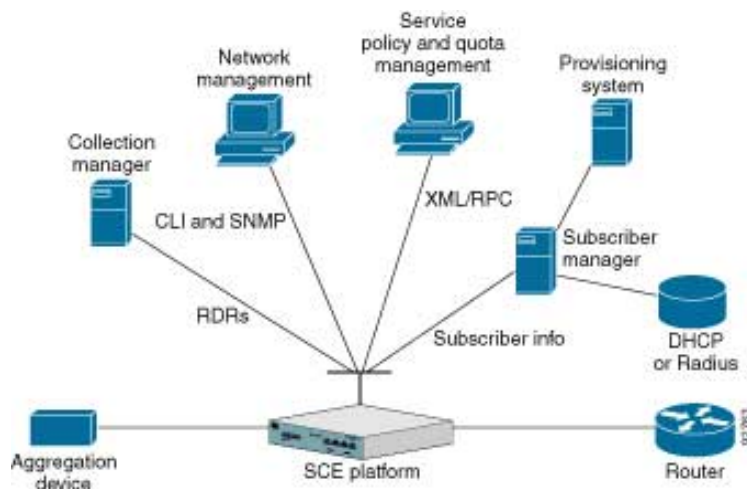

Network Management

Cisco provides complete network FCAPS (Fault, Configuration, Accounting, Performance, Security) Management.

Two interfaces are provided for network management:

- Command-Line Interface (CLI)—The CLI is accessible through the Console port or through a Telnet connection; it is used for configuration and security functions
- SNMP—SNMP provides fault management via SNMP traps, as well as performance monitoring functionality

Subscriber Management

In cases where *SCE 2000* is used to enforce different policies on different subscribers, and tracks usage on an individual subscriber basis, the Cisco Service Control Management Suite (SCMS) Subscriber Manager (SM) may be used as middleware software for bridging between the OSS and the SCE platforms. Subscriber information is stored in the SM database and can then be distributed between multiple platforms according to actual subscriber placement.

The SM provides subscriber awareness, mapping network IDs to subscriber IDs. It obtains subscriber information using dedicated integration modules, which integrate with AAA devices, such as Radius or DHCP servers.

Subscriber information may be obtained in one of two ways:

- Push Mode—The SM pushes subscriber information to the SCE platform automatically upon logon of a subscriber
- Pull Mode—On-demand, in response to a query from the SCE platform to the SM

Collection

The Cisco Service Control solution generates usage data and statistics from the SCE platform and forwards them as Raw Data Records (RDRs), using a simple TCP-based protocol (RDR-Protocol). The Service Control solution provides the Cisco Service Control Management Suite (SCMS) Collection Manager (CM) software as an implementation of a collection system, listening in on RDRs from one or more SCE platforms, and processing them on the local machine. The data is then stored for analysis and reporting functions, as well as simple collection and presentation of data to additional OSS systems such as billing.

Service Configuration Management

Service configuration management is the ability to configure the general service definitions of a service control application. A service configuration file containing settings for traffic classification, accounting & reporting, and control is created and applied to an SCE platform. SCA BB provides tools to automate the distribution of these configuration files to SCE platforms, and this simple, standards-based approach makes it easy to manage multiple devices in a large network.

Service Control provides an easy-to-use GUI to edit and create these files, as well as a complete set of APIs to automate their creation.

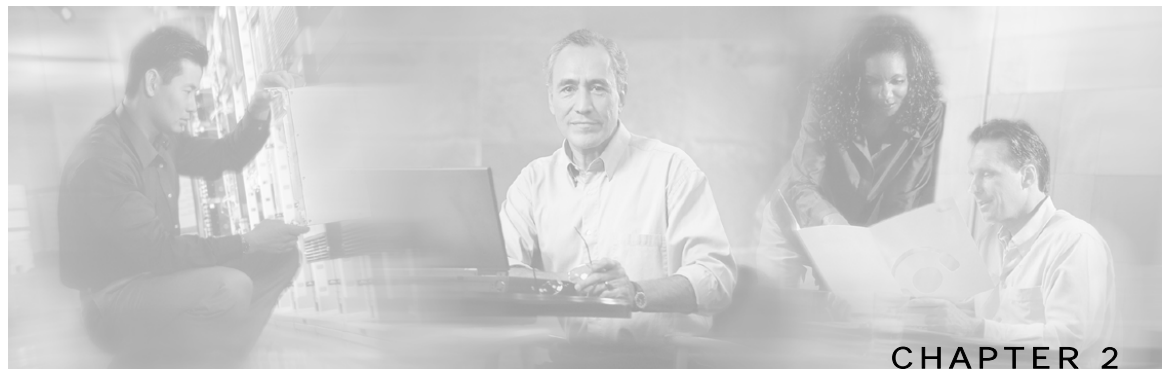

Introduction to the SCE Platform

This chapter provides an introduction to the SCE 2000 4xGBE Platform, the Service Control hardware component.

This chapter contains the following sections:

- [The SCE Platform](#) 2-1
- [Front Panel](#) 2-2
- [Back Panel](#) 2-4
- [Checking the Shipping Container Contents](#) 2-5
- [SCE 2000 Installation Checklist](#) 2-7

The SCE Platform

The Service Control Engine (SCE) platform, which is the hardware component of the Cisco Service Control solution, is designed to support observation, analysis, and control of Internet/IP traffic. The following table summarizes model information for the SCE 2000 platform.

Table 2-1 SCE Platform Model Information

Model number	SCE 2020 4xGBE
Link Type	Gigabit Ethernet
Number of Ports	4
Number of Links	2

Front Panel

The *SCE 2000* Front Panel consists of ports and LEDs as shown in the following figure and tables.

Figure 2-1: *SCE 2000* Front Panel

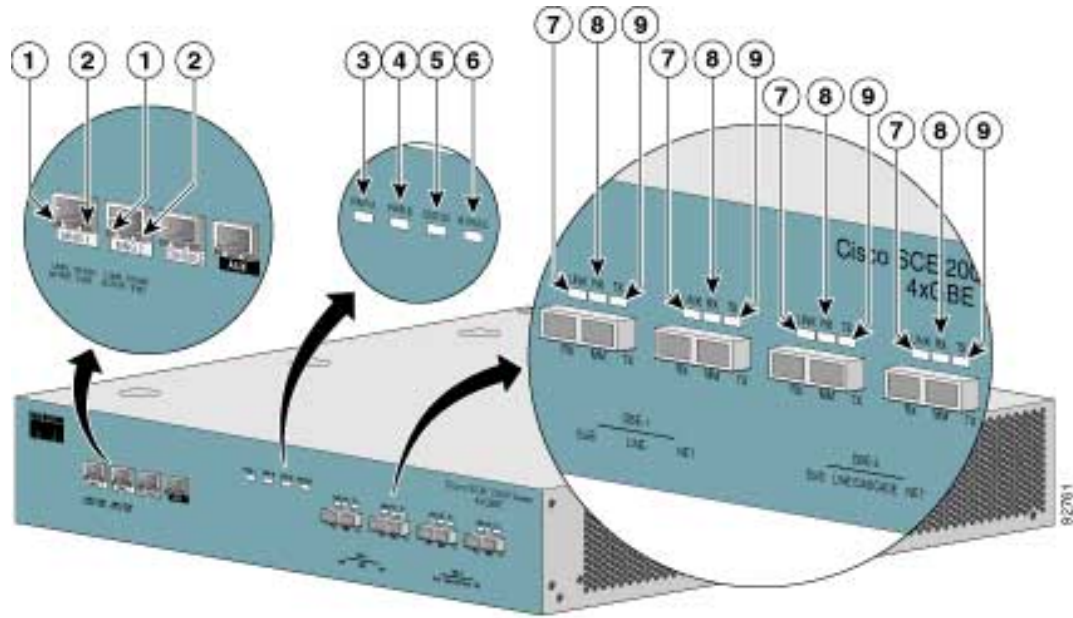

Table 2-2 *SCE 2000* Ports

Port	Quantity	Description	Connect This Port To...
Mng1/ Mng2	2	10/100/1000 Ethernet RJ-45 ports for management of the <i>SCE 2000</i> . CLI designation: interface Management 0/1, 0/2.	A LAN using an FE cable with an RJ-45 connector. If both interfaces are used to provide a redundant management interface, connect both ports to the LAN via a switch.
Console	1	RS-232 RJ-45 port for use by technicians	A local terminal (console) using an RS-232 cable with an RJ-45 connector, as provided in the <i>SCE 2000</i> kit.
AUX	1	RS-232 RJ-45 port used by technicians	
GBE ports 1-4	4	GigabitEthernet SC ports for connecting to the line and/or cascading two devices CLI designation: interface GigabitEthernet 0/1 through 0/4	Refer to Connecting the Line Ports (on page 6-1) for cabling diagrams for various topologies

Table 2-3 SCE 2000 LED Groups

LED Groups	Description
Power A	<ul style="list-style-type: none"> • Continuous green — Power supply A is functioning normally • Red — Power supply A present, but malfunctioning • Unlit — Power supply A is either not present or has failed.
Power B	<ul style="list-style-type: none"> • Continuous green — Power supply B is functioning normally • Red — Power supply B present, but malfunctioning • Unlit — Power supply B is either not present or has failed.
Status	<p>The Status LED indicates the operational status of the <i>SCE 2000</i> system, as follows:</p> <ul style="list-style-type: none"> • Unlit — indicates no power from either power unit. • Orange — indicates that the system is booting up. • Flashing green — indicates that the system is fully operational. • Flashing orange — indicates that the system is operational, but is in a warning state. • Red — indicates that there is a problem or failure <p>Note that Alarms are hierarchical: Failure takes precedence over Warning, which takes precedence over operational.</p>
Bypass	<ul style="list-style-type: none"> • Continuous green — indicates that the traffic bypasses the <i>SCE 2000</i> through an internal electrical bypass module. <p>Single <i>SCE 2000</i> topology — The <i>SCE 2000</i> is either in bypass or sniffing mode</p> <p>Cascaded topology — Either the <i>SCE 2000</i> is forwarding traffic to the other <i>SCE 2000</i>, where it is being processed, or is simply in bypass mode, so traffic through it is not being processed.</p> <ul style="list-style-type: none"> • Unlit — traffic is not being bypassed <p>Single <i>SCE 2000</i> topology — indicates normal operation of the <i>SCE 2000</i></p> <p>Cascaded topology — indicates normal operation of the active <i>SCE 2000</i></p>
GBE ports	<p>The GBE LEDs indicate the operational status of the <i>SCE 2000</i> line ports, as follows:</p> <ul style="list-style-type: none"> • Link <ul style="list-style-type: none"> Green — indicates that the port link is up Unlit — indicates that the port link is down • Rx <ul style="list-style-type: none"> Flashing Green — indicates that there are incoming packets • Tx <ul style="list-style-type: none"> Flashing Green — indicates that there are outgoing packets

LED Groups	Description
Mng	<p>The Mng port LEDs indicate the operational status of the <i>SCE 2000</i> out-of-band LAN-based management port, as follows:</p> <ul style="list-style-type: none"> • Link/Active <ul style="list-style-type: none"> Green — indicates that the port link is up Unlit — indicates that the port link is down • 10/100/1000 <ul style="list-style-type: none"> Steady green — indicates that the port is set to 100 Mbps Unlit — indicates that the port is set to 10 Mbps Orange — indicates that the port is set to 1000 Mbps

Back Panel

The *SCE 2000* platform back-panel contains the following components:

- Two field-replaceable power supply units with ON/OFF switches
- A field-replaceable fan drawer
- Ground connections
- Two connectors to the external bypass module

The rear panels of both the AC- and DC-powered *SCE 2000* platforms are shown in the following pair of figures.

Figure 2-2: *SCE 2000* Back Panel: AC Power

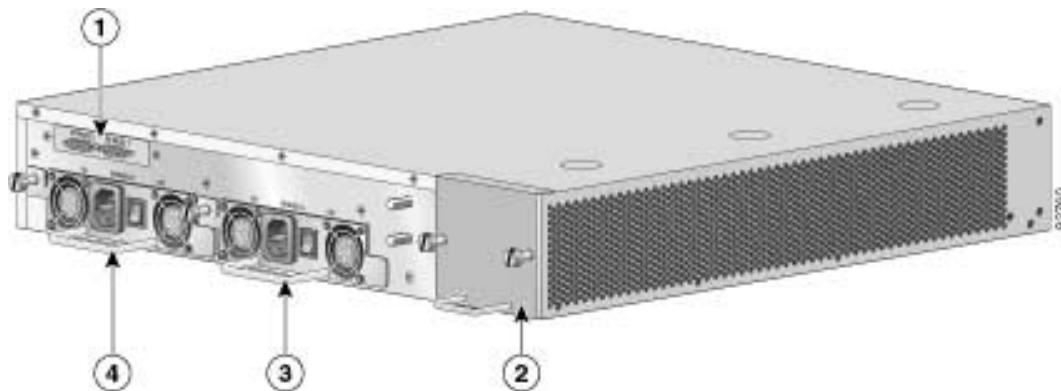

Figure 2-3: SCE 2000 Back Panel DC power



Checking the Shipping Container Contents

Use the *SCE 2000* Component List to check the contents of the *SCE 2000* platform shipping container.

Do not discard the shipping container. You need the container if you move or ship the *SCE 2000* platform in the future.

SCE 2000 Component List

Table 2-4 SCE 2000 Component List

Component	Description	Received
SCE 2000 platform	SCE 2020 4xGBE platform configured with either AC or DC power supplies.	
Accessories	The following accessories might arrive in separate shipping containers:	
<ul style="list-style-type: none"> • Rack mount kit 	<ul style="list-style-type: none"> • Two mounting brackets for 19" rack • Six screws (Philips), 8-32 x 3/8" (for attaching the brackets to the SCE 2000 chassis) • supporting mounting brackets for 19" rack • Two crossrail supports for 19" rack with front and back posts 	
<ul style="list-style-type: none"> • Management cables 	<ul style="list-style-type: none"> • Fast Ethernet cable for connecting to the Management ports • RS-232 serial cable (DB-9 to RJ-45) for connecting to a local terminal 	
<ul style="list-style-type: none"> • Power cables 	Two AC power supply cords,if ordered with AC-input power supply units	
<ul style="list-style-type: none"> • Grounding kit 	<ul style="list-style-type: none"> • Grounding cable • Two Hex nuts (#1/4") • Two spring washers (#1/4") 	
<ul style="list-style-type: none"> • Documentation 	If ordered, SCE 2000 hardware and software documentation set and the Cisco Documentation CD-ROM package*	
Optional Equipment	Four rubber feet for tabletop installation	
External Optical Bypass module kit	<ul style="list-style-type: none"> • 1 External Optical Bypass module • 1 19" rack mounting panel • 1 control cable 	

*Titles and quantities of documents will vary. You must order the type and quantity of documentation sets when you order the hardware.



Note

We no longer ship the entire SCE 2000 documentation set automatically with each system. You must specifically order the documentation as part of the sales order. If you ordered documentation and did not receive it, we will ship the documents to you within 24 hours. To order documents, contact a customer service representative.

SCE 2000 Installation Checklist

To assist you with your installation and to provide a historical record of what was done by whom, photocopy the following *SCE 2000* Installation Checklist. Indicate when each procedure or verification is completed. When the checklist is completed, place it in your site log along with the other records for your new *SCE 2000* platform.

Table 2-5 SCE 2000 Installation Checklist

Task	Verified By	Date
Date <i>SCE 2000</i> received		
<i>SCE 2000</i> and all accessories unpacked		
Safety recommendations and guidelines reviewed		
Topology verified: number of <i>SCE 2000</i> platforms, number of links, and whether inline or receive-only		
Installation Checklist copied		
Site log established and background information entered		
Site power voltages verified		
Site environmental specifications verified		
Required passwords, IP addresses, device names, and so on, needed for initial configuration available (refer to <i>Setup Command Parameters</i> (on page 5-3))		
Required tools available		
Network connection equipment available		
<i>SCE 2000</i> mounted in rack (optional)		
AC/DC power cables connected to AC/DC sources and <i>SCE 2000</i> platform		
Console port set for 9600 baud, 8 data bits, no parity, and 1 stop bit (9600 8N1)		
ASCII terminal attached to console port		
FE management ports are operational		
GBE line and cascade ports operational		
Network interface cables and devices connected		
System power turned on		
System boot complete (SYSTEM-UP LED is on)		
Correct hardware configuration displayed after system banner appears		

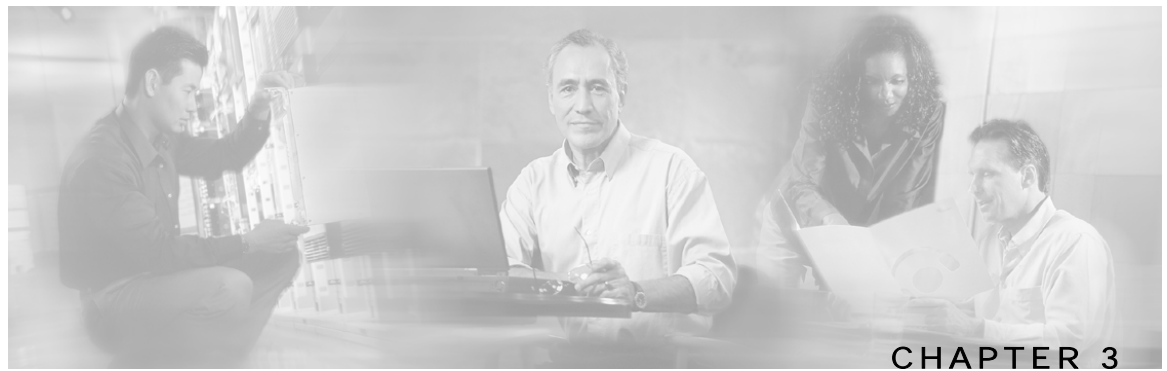

Topology

This chapter describes the possible deployment topologies of the *SCE 2000*. The Cisco SCE solution offers a number of basic topology options that permit the user to tailor the SCE Platform to fit the needs of a particular installation. An understanding of the various issues and options is crucial to designing, deploying, and configuring the topology that best meets the requirements of the individual system.

This chapter contains the following sections:

- [The SCE 2000 Platform](#) 3-1
- [Topology Considerations](#) 3-1
- [Physical Topologies](#) 3-4

The SCE 2000 Platform

The *SCE 2000* introduces a solution for dual links with load sharing and asymmetrical routing and support for fail-over between two SCE platforms.

The *SCE 2000* supports wire speed processing of full-duplex 2-Gigabit Ethernet streams. The *SCE 2000* can, therefore, be deployed in a multi-link environment, either in a single or dual SCE platform topology.

- single *SCE 2000* topology — Provides increased network capacity and the ability to process both directions of a bi-directional flow, processing both the upstream and downstream paths of a flow, even if they traverse different links
- dual *SCE 2000* topology (cascade) — cascaded *SCE 2000*s provide high-availability and fail-over solution and maintain the line and service in case of *SCE 2000* failure.

Topology Considerations

There are several issues that must be considered in order to arrive at the optimum configuration of the topology-related parameters:

- Functionality — Will the system be used solely to monitor traffic flow, with report functionality only, or will it be used for traffic flow control, with enforcement as well as report functionality?

- Number of links — The *SCE 2000* may be connected to one or two GBE links. This is relevant for both Inline and Receive-Only topologies.
- Redundancy — Must the system be designed to guarantee uninterrupted *SCE 2000* functionality? If so, there must be a backup *SCE 2000* Platform to assume operation in case of failure of the primary device.
- Link continuity — How should the *SCE 2000* respond to platform failure with regard to link continuity? Should traffic flow continue even though the unit is not operating, or be halted until the platform is repaired/replaced?

These issues determine three important aspects of system deployment and configuration:

- How many *SCE 2000* Platforms are needed and how will they be installed?
- Physical topology of the system — The actual physical placement of the *SCE 2000* in the system.
- Topology-related configuration parameters — The correct values for each parameter must be ascertained before configuring the system to make sure that the system will function in the desired manner.

Functionality

The *SCE 2000* can serve one of two general functions:

- Monitoring and Control — The *SCE 2000* monitors and controls traffic flow. Decisions are enforced by the *SCE 2000* depending on the results of the monitoring functions of the *SCE 2000* and the configuration of the Service Control Application for Broadband or Mobile solution.

In order to perform control functions, the *SCE 2000* must be physically installed as an inline installation and the connection mode must be “inline”.

- Monitoring only — The *SCE 2000* monitors traffic flow, but cannot control it.

Either an inline installation or an optical splitter installation may be used for monitoring only. In the latter case connection mode must be “receive-only”.

Number of links

The *SCE 2000* can be deployed in a single GBE link or in two GBE links. The two-link topology may implement load-sharing and the *SCE 2000* in this case is able to process both directions of a bi-directional flow even if they split to both links.

Redundancy

When a high degree of reliability is desired, a second *SCE 2000* Platform should be installed to provide backup operation capabilities. The combination of two *SCE 2000s* guarantees uninterrupted functioning in case of a failure of one of the platforms. The two *SCE 2000s* are cascaded, so that, although all processing is performed only in the active *SCE 2000*, the standby *SCE 2000* is constantly updated with all the necessary information so that it can instantly take over processing the traffic on the data links should the active *SCE 2000* fail.

If only preservation of the network links is required, and uninterrupted functionality of the *SCE 2000* is not required, a single *SCE 2000* is sufficient.

Link Continuity

The bypass mechanism of the *SCE 2000* allows traffic to continue to flow, if desired, even if the device itself is not functioning.

Note that when the *SCE 2000* is connected to the network through an optical splitter, a failure of the *SCE 2000* does not affect the traffic flow, as the traffic continues to flow through the optical splitter.

Bypass Mechanism

The *SCE 2000* includes a Network Interface Card with a bypass mechanism that is enabled upon *SCE 2000* failure. In addition, when connected in-line it can also be enabled in normal operation to simultaneously bypass traffic flow to the other side and direct it internally for analysis. In this case it maintains "receive-only"-like monitoring functions, when control functionality is not required.

The bypass card supports the following four modes:

- **Bypass** — The bypass mechanism preserves the network link, but traffic is not processed for monitoring or for control.
- **Forwarding** — This is the normal operational mode, in which the *SCE 2000* processes the traffic for monitoring and control purposes.
- **Sniffing** — The bypass mechanism preserves the network link, while in parallel allowing the *SCE 2000* to process the traffic for monitoring only.
- **Cutoff** — There is no forwarding of traffic, and the physical link is forced down (cutoff functionality at layer 1).

Maintaining the Network Links vs Maintaining SCE 2000 Platform Functionality

When a single *SCE 2000* is deployed, the user may decide that in case of a failure, maintaining the network link is more important than providing the *SCE 2000* functionality. In this scenario, when the *SCE 2000* detects a failure that requires a reboot process for recovering, it immediately switches to Bypass mode, allowing all traffic to bypass the *SCE 2000*. The *SCE 2000* stays in Bypass mode maintaining the network link, albeit without *SCE 2000* processing, until the *SCE 2000* fully recovers from the failure and is ready to resume normal functioning.

Alternatively, the user may decide that the *SCE 2000* functionality is sufficiently crucial to require severing the link if the *SCE 2000* platform fails. In this case, when the *SCE 2000* detects a failure that requires a reboot process for recovering, it immediately switches to Cutoff mode, stopping all traffic flow. The *SCE 2000* stays in Cutoff mode, halting all traffic, until it fully recovers from the failure and is ready to resume normal functioning. In Cutoff the physical interface is blocked, enabling the network device connected to the *SCE 2000* to sense that the link is down.

Physical Topologies

Following are descriptions of a number of physical topologies that the *SCE 2000* supports.

Single SCE 2000 Topologies

A single *SCE 2000* supports both single GBE link and dual GBE link topologies.

Single Link: Inline Topology

Typically, the *SCE 2000* is connected in a full duplex GBE link between two devices (Router, BRAS, etc.). When the *SCE 2000* is installed as an inline installation, it physically resides on the data link between the subscribers and the network.

Figure 3-1: Single SCE Platform Single Link: In-line Topology

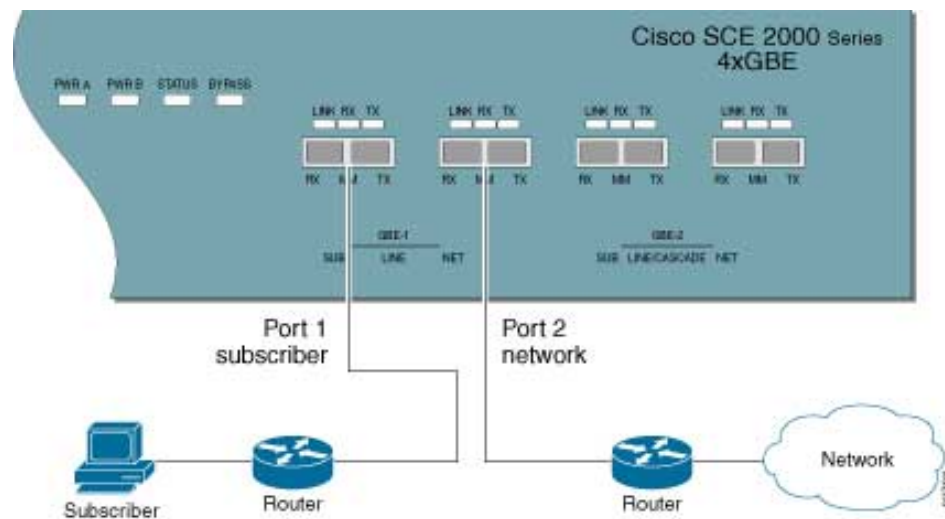

When configuring the *SCE 2000*, an inline installation is referred to as “inline” connection mode.

Dual link: Inline Installation

In this topology, one *SCE 2000* is connected inline in two full duplex, GBE links.

In case the two links are load-shared, asymmetrical routing might occur, and some of the flows may be split, i.e. the upstream packets of the flow go on one link, and the downstream packets go on the other link.

When installed in this topology, the *SCE 2000* completely overcomes this phenomenon, and provides its normal functionality as if asymmetrical routing were not occurring in the two links.

Figure 3-2: Single SCE Platform Dual Link Inline Topology

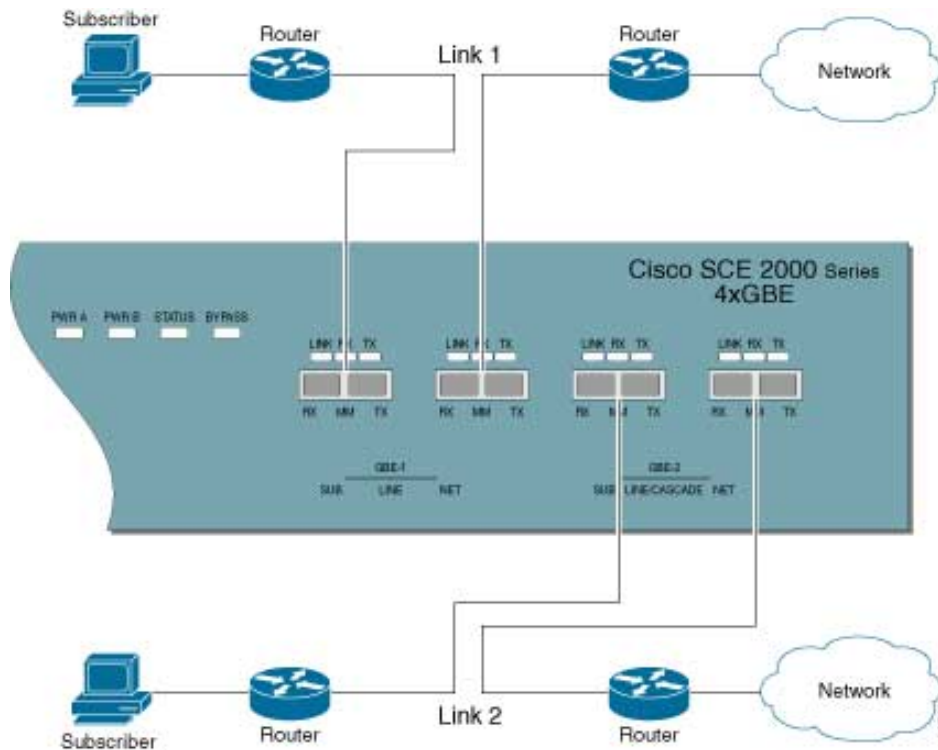

This topology supports both monitoring and control functionality, and is referred to as “inline” connection mode.

Single Link: Receive-only Topology

In this topology, an optical splitter resides physically on the GBE link between the subscribers and the network. The traffic passes through the optical splitter, which splits traffic to the **SCE 2000**. The **SCE 2000**, therefore, only receives traffic and does not transmit.

Figure 3-3: Single SCE Platform Single Link: Receive-Only Topology

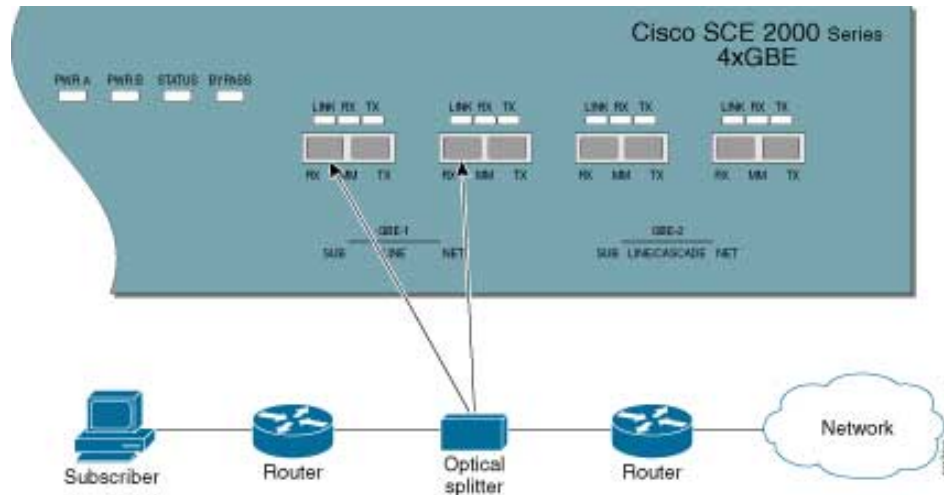

When configuring the **SCE 2000**, an optical splitter topology is referred to as “receive-only” connection mode.

Note that in an optical splitter topology, the **SCE 2000** only enables traffic monitoring functionality.



Note

When implementing receive-only topologies with a switch, the switch must support SPAN functionality that includes separation between ingress and egress traffic and multiple SPAN-ports destinations.

Dual Link: Receive-Only Topology

In this topology, one *SCE 2000* is connected in receive-only mode to two full duplex, GBE links using optical splitters. If the two links are load-shared, asymmetrical routing might occur, and some of the flows may be split, i.e. the upstream packets of the flow go on one link, and the downstream packets go on the other link.

When installed in this topology, the *SCE 2000* completely overcomes this phenomenon, and provides its normal monitoring functionality as if asymmetrical routing were not occurring in the two links.

This installation supports monitoring functionality only, and is configured as “receive-only” connection mode.

Figure 3-4: Single SCE Platform Dual Link Receive-Only Topology

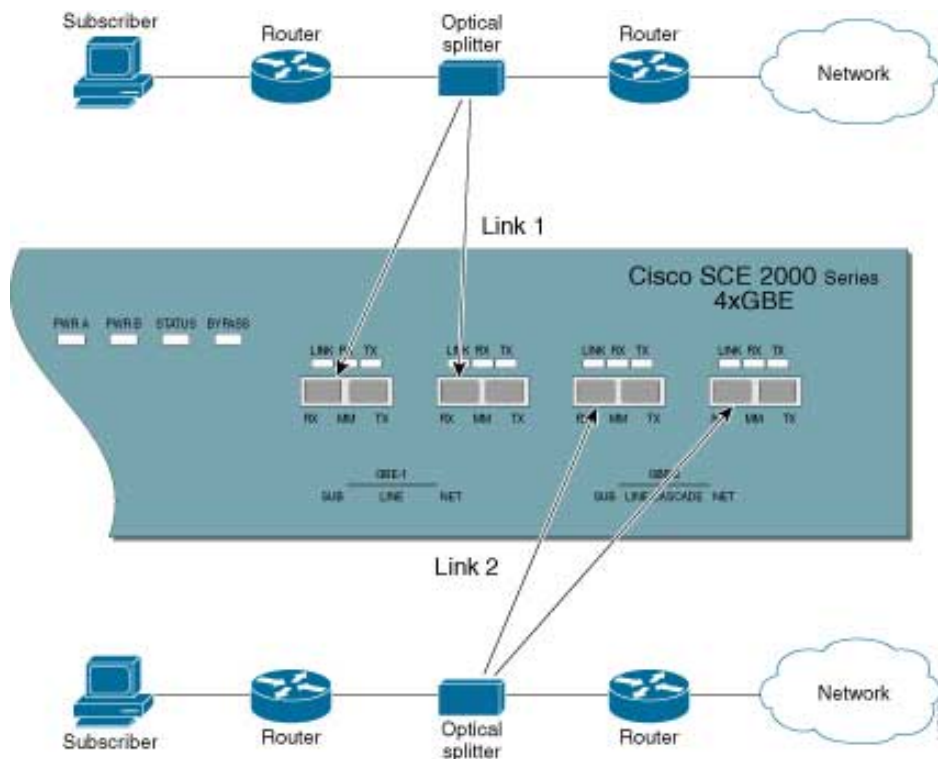

Note When implementing receive-only topologies with a switch, the switch must support SPAN functionality that includes separation between ingress and egress traffic and multiple SPAN-ports destinations.

- When one *SCE 2000* fails (depending on the type of failure) its link traffic is still bypassed to the functioning *SCE 2000* and processed there, so the traffic processing continues for both the links.
- The bypass of the traffic through the failed *SCE 2000* is configurable, and the user may choose to always cutoff the line that goes through the failed *SCE 2000*. In this case network redundancy protocols like HSRP are responsible for identifying the line cutoff and switching all the traffic to go through the functioning *SCE 2000*.

Topology-Related Parameters

Refer to the following sections to determine the correct values for all topology-related parameters before beginning run the initial setup of the *SCE 2000*.

SCE 2000 Configuration

There are four topology-related parameters:

- **Connection mode** — Can be any one of the following, depending on the physical installation of the *SCE 2000* (Refer to [Connection Mode Parameter](#) (on page 3-9)):
 - Inline — single *SCE 2000* inline
 - Receive-only — single *SCE 2000* receive-only
 - Inline-cascade — two *SCE 2000s* inline
 - Receive-only-cascade — two *SCE 2000s* receive-only
- **Physically-connected-links** — In cascaded configurations, this parameter defines the number of the link connected to this *SCE 2000* (Refer to [Physically Connected Links Parameter](#) (on page 3-10)).

It is applicable only in a cascade topology.

- **Priority** — This parameter defines which is the primary *SCE 2000* (Refer to [Priority](#) (on page 3-10)).

It is applicable only in a cascade topology.

- **On-failure** — This parameter determines whether the system cuts the traffic or bypasses it when the *SCE 2000* either has failed or is booting. It is not applicable to receive-only topologies (Refer to [On-Failure Mode Parameter](#) (on page 3-10)).

Any of these parameters may be configured via either the `setup` command or the `connection-mode` command.

Connection Mode Parameter

The connection mode parameter refers directly to the physical topology in which the *SCE 2000* is installed. The connection mode depends on two factors:

- **Inline/Receive-only:**
 - **Inline** — The *SCE 2000* resides on the data link between the subscriber side and the network side, thus both receiving and transmitting packets.

- **Receive-only** — The *SCE 2000* does not reside physically on the data link. Data is forwarded to the *SCE 2000* via an external switch. The *SCE 2000* itself receives only and does not transmit.
- **Cascade** — Indicates a two *SCE 2000* topology where the *SCE 2000*s are connected via the cascade ports.

The connection mode parameter is determined by the physical deployment of the *SCE 2000*, as follows:

- Single *SCE 2000* inline installation = “**Inline**” connection mode.
- Single *SCE 2000* optical splitter installation = “**Receive-only**” connection mode.
- Two *SCE 2000* inline installation = “**Inline-cascade**” connection mode.
- Two *SCE 2000* optical splitter installation = “**Receive-only-cascade**” connection mode.

Physically Connected Links Parameter

If the system consists of more than one device, this parameter defines which link is connected to this *SCE 2000*. Currently the system supports a maximum of two links, which are designated link 0 and link 1.

Priority

In a cascade topology, the user must define the priority of each *SCE 2000*.

- **Primary** — The Primary *SCE 2000* is active by default
- **Secondary** — The Secondary *SCE 2000* is the default standby.

Note that these defaults apply only when both devices are started together. However, if the primary *SCE 2000* fails and then recovers, it will not revert to active status, but remains in standby status, while the secondary device remains active.

On-Failure Mode Parameter

As described in the section The Bypass Mechanism, the bypass card supports four different modes. The following two modes are possible when the *SCE 2000* is not operational due to platform failure or boot:

- **Bypass** — The optical splitter forwards traffic with no intervention of the control application running in the *SCE 2000* platform, but monitoring functions continue uninterrupted.
- **Cutoff** — There is no forwarding of traffic. The link is forced down, resulting in traffic cutoff at Layer1.

The **Forwarding** mode enables control of traffic flow and is not compatible with the non-operational status.

In a single *SCE 2000* topology, the value of this parameter is determined by whether or not the link can be completely cut when the *SCE 2000* fails, or whether traffic flow should continue across the link in spite of platform failure.

- **Cutoff** mode is required for the following:
 - Redundant inline topology.

- Non-redundant inline topology if value-added services are crucial and are more important than maintaining connectivity.
- **Bypass** mode is required for the following:
 - Non-redundant inline topology if connectivity is crucial.

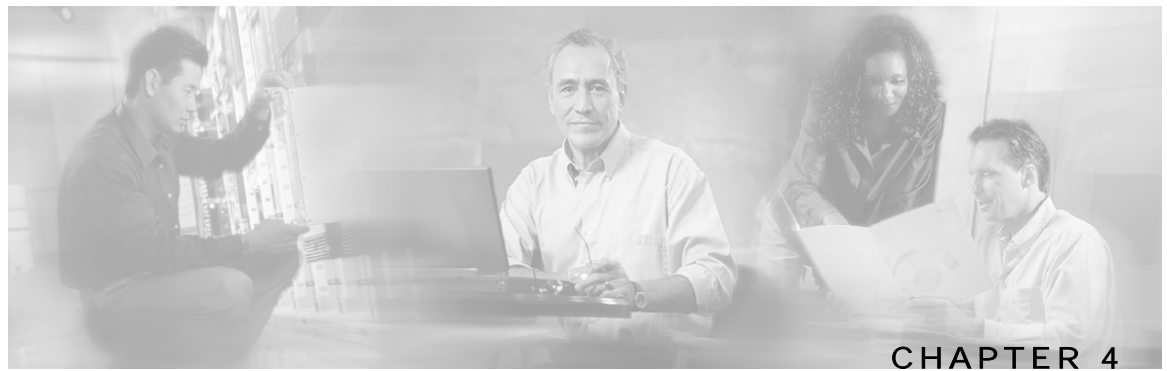

Installation and Maintenance

This chapter explains how to install a *SCE 2000* platform in a rack or in a general tabletop or workbench installation. Additionally, this chapter contains instructions for installing or replacing the power supply units and fan modules.



Warning

Before you install, operate, or service the system, read the *Regulatory Compliance and Safety Information for the Cisco Service Control Engine*. This guide contains important safety information you should know before working with the system.

This chapter contains the following sections:

- [Preparing to Install the SCE 2000 Platform](#) 4-1
- [Installing the SCE 2000 Platform](#) 4-4
- [Power Supply Overview](#) 4-12
- [Removing and Replacing a Power Supply Unit](#) 4-14
- [Fan Module Overview](#) 4-20
- [Replacing the Battery](#) 4-22

Preparing to Install the SCE 2000 Platform

Before installing your *SCE 2000* platform, you should consider the power and cabling requirements that must be in place at your installation site, the equipment you need to install the platform, and the environmental conditions your installation site must meet to maintain normal operation. This section guides you through the process of preparing for your *SCE 2000* platform installation and the installation in a rack. The section contains the following topics:

- [Tools and Parts Required](#) (on page 4-2)
- [Site Requirement Guidelines](#) (on page 4-3)

Figure 4-1: SCE 2000 Measurements

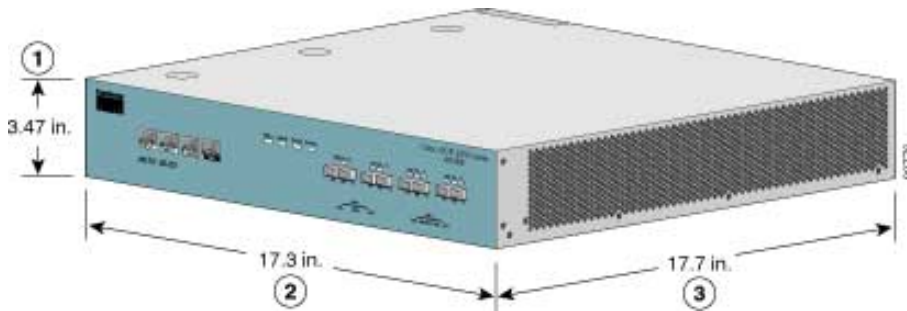

Table 4-1 SCE 2000 Dimensions

Dimension	Measurement
Height	3.47 inches (9.5 cm)
Width	17.4 inches (4.43 cm)
Depth	18 inches (4.6 cm)
Weight	33 lb (15 kg)

Tools and Parts Required

The **SCE 2000** chassis is fully assembled at the factory, including the application and software packages. No assembly is required. However, you need the following tools and equipment to install the **SCE 2000** chassis and the rack-mount kit (if installing the **SCE 2000** platform in a rack), fan modules, and power supplies:

- Number 1 and 2 Phillips screwdriver
- 1/4 inch flat-blade screwdriver
- #1/4" Hex Wrench
- Screws compatible with your rack (for mounting the **SCE 2000** to the rack)
- 12 AWG or 2.5-mm copper installation wire with hex or loop connectors for DC power leads

Ring terminals must be UL approved and suitable for 12 AWG wire.

- Level (optional)
- Tape measure (optional)
- Appropriate cables to connect the **SCE 2000** to the network and console terminal
- Rack-mounting kit (optional)
- A new AC-input or DC-input power supply
- A new fan module

Site Requirement Guidelines

The environmental monitoring functionality in the *SCE 2000* protects the system and components from potential damage from over-voltage and over-temperature conditions. To ensure normal operation and to avoid unnecessary maintenance, plan your site configuration and prepare your site *before* installation. After installation, make sure the site maintains an ambient temperature of 41°F to 104°F (5°C to 40°C) with short term temperatures ranging from 23°F to 131°F (-5°C to 55°C), and keep the area around the *SCE 2000* chassis free from dust.

Planning a proper location for the *SCE 2000* and the layout of your equipment rack or wiring closet is essential for successful system operation. Equipment placed too close together or inadequately ventilated can cause system over-heating. In addition, chassis panels made inaccessible by poor equipment placement can make system maintenance difficult.

Airflow

Figure 4-2: Airflow Through the SCE 2000



When you plan the location and layout of your equipment rack or wiring closet you need to consider how air flows through your system. The *SCE 2000* draws cooling air in through the intake vents on the left side of the chassis, moves the air across the internal components, and out through the right side and rear panel of the chassis. The above figure illustrates the airflow through the *SCE 2000*.



Note

Remember to leave a two inch (5 cm) clearance on both sides of the *SCE 2000* and five inches (12.7 cm) at the rear for adequate airflow for the inlet and exhaust vents.

Site Requirements

The following tables contain the site requirement specifications for the *SCE 2000*.

Table 4-2 SCE 2000 Environmental Requirements

Specification	Acceptable Range
Temperature -	nominal 41°F to 104°F (5°C to 40°C)
Short term temperatures*	23°F to 131°F (-5°C to +55°C)
Relative humidity	5% to 95% (non-condensing)
Heat dissipation	683 BTU/hour

*Short term is defined as not more than 96 consecutive hours, not more than 15 days in one year. 360 hours total in any given year, but no more than 15 occurrences in a one-year period.

Table 4-3 SCE 2000 Approvals Specifications

Approval	Specification
EMC	<ul style="list-style-type: none"> • CE Mark • EMISSIONS: FCC Part 15 CFR 47 Class A, EN 55022 Class A, CISPR22 Class A, VCCI Class A, AS/NZS CISPR22 Class A • Immunity - EN 50082-1 EN 55024, CISPR24 (ESD, RFI, EFT, etc.) (Commercial)
Safety	UL/CSA 60950, IEC60950, EN60950, AS/NZS, 60950, NOM-019,IEC/EN60825-1, -2, 21CFR1040, 73/23/ECC

For more complete information regarding safety and regulatory compliance, refer to the *Regulatory Compliance and Safety Information for the Cisco Service Control Engine* document.



Warning

The DC-powered *SCE 2000* should be installed in a Restricted Access Location only.

Installing the SCE 2000 Platform

The *SCE 2000* operates as either a tabletop or a rack-mounted unit. A rack-mounting kit is included with the *SCE 2000* when it is shipped from the factory. The kit provides the hardware needed (see *SCE 2000 Component List* (on page 2-6)) to mount the *SCE 2000* in either of two types of standard 19-inch equipment rack:

- 19-inch rack with only two posts in the front — Use the supporting brackets included in the kit
- 19-inch rack with four posts, two in the front and two in the back — Use the crossrail supports included in the kit

If you are not rack-mounting your *SCE 2000*, place it on a sturdy tabletop or workbench. A rubber feet kit is included for tabletop installations.

This section provides instructions for the physical installation of the *SCE 2000* platform, including how to install the *SCE 2000* in a rack, how to install the *SCE 2000* on a tabletop or workbench, and how to properly ground the *SCE 2000* platform. The section contains the following topics:

- [Installation Precautions](#) (on page 4-5)
- [Installing the SCE 2000 on a Workbench or Tabletop](#) (on page 4-5)
- [Rack-Mounting a SCE 2000 Platform](#) ("Rack-Mounting a SCE 2000 Platform" on page 4-6)
- [Attaching a Chassis Ground Connection](#) (on page 4-10)

Installation Precautions

The router should already be in the area where you will install it, and your installation location should already be determined. If not, see [Site Requirement Guidelines](#) (on page 4-3) and the [Site Preparation and Safety Guide](#).

When installing the **SCE 2000**, please observe the following conditions:

- Allow at least 2 inches (5 cm) of clearance at its left and right sides for airflow clearance from the inlet and exhaust vents, and that no exhaust air from other equipment is drawn into the **SCE 2000**. For descriptions and illustrations regarding airflow, see [Airflow](#) (on page 4-3).
- Do not place the **SCE 2000** on the floor during installation. Dust that accumulates on the floor is drawn into the interior of the **SCE 2000** by the cooling fans. Excessive dust inside the **SCE 2000** can cause over-temperature conditions and component failures.
- Allow at least 5 inches (12.7 cm) of clearance at the front and rear of the **SCE 2000** for installing and rudimentary maintenance for accessing network cables or equipment.
- Ensure that the **SCE 2000** will receive adequate ventilation. Do not install the **SCE 2000** in an enclosed cabinet where ventilation is inadequate!
- Provide an adequate chassis Ground (earth) connection for the **SCE 2000** (see [Attaching a Chassis Ground Connection](#) (on page 4-10) for instructions).

Installing the SCE 2000 on a Workbench or Tabletop

You can install the **SCE 2000** platform on any flat surface as long as the surface is large enough for the **SCE 2000** (see the table in **SCE 2000 Dimensions**), and allows for adequate airflow/ventilation around the sides of the **SCE 2000**, as described in the [Installation Precautions](#) (on page 4-5). When installing the **SCE 2000** on a workbench or tabletop or in a rack, ensure that the surface is clean and in a safe location.

Figure 4-3: Installing the System on a Flat Surface

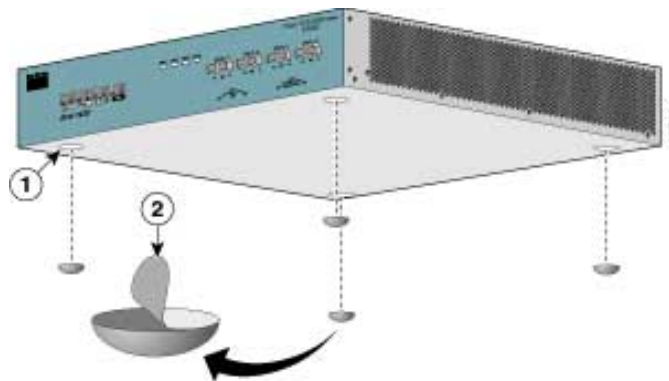

To install a **SCE 2000** platform on a workbench or tabletop, complete the following steps:

- Step 1** Remove any debris and dust from the tabletop or workbench, as well as the surrounding area. Also make sure your path between the **SCE 2000** platform and its new location is unobstructed.
- Step 2** Place the **SCE 2000** platform on the tabletop or workbench.

- Step 3** View the bottom panel by lifting the *SCE 2000*, placing your hands around the *SCE 2000* sides and lifting the *SCE 2000* from underneath. To prevent injury, avoid sudden twists or moves.
- There are four marked locations, indicating where to affix the rubber feet (see figure above).
- Step 4** Attach the rubber feet by removing the adhesive strips and affix the rubber feet onto the marked locations (on the bottom panel).
- Step 5** Replace the *SCE 2000* platform firmly on the tabletop or workbench.
- Remember to check for proper ventilation. Allow at least 2 inches (5 cm) on each side for proper ventilation and 5 inches (12.7 cm) at the back for ventilation and power cord clearance.

This completes the general workbench or tabletop installation.

Proceed to section, [Attaching a Chassis Ground Connection](#) (on page 4-10) to continue the installation.

Rack-Mounting a SCE 2000 Platform

You can mount the *SCE 2000* platform to a 19" rack. There are two standard types of equipment racks, and the appropriate brackets for each are provided in the enclosed kit.

- 19" rack with front rack posts — the mounting kit includes two mounting brackets as illustrated below.
- 19" rack with front and back rack posts — in addition to the mounting brackets illustrated below, the mounting kit includes two crossrail supports that the unit slides onto.

Mounting Brackets for 2-post Rack



Mounting Brackets for 4-post Rack

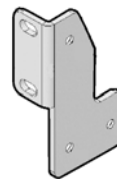

The *SCE 2000* mounts to the two front rack posts with brackets that attach to the front of the *SCE 2000*. The inside width between the two posts or mounting strips (left and right) must be at least 17.3 inches (44 cm).



Note

Remember to leave a two-inch (5 cm) clearance on both sides of the *SCE 2000* and at the rear for adequate airflow for the inlet and exhaust vents.

Because the inlet and exhaust ports (vents) for cooling air are located at both sides of the chassis, respectively, multiple *SCE 2000s* can be stacked in a rack with no vertical clearance.

Attaching the Brackets to the SCE 2000

Before installing the *SCE 2000* in the rack, you must first install an appropriate rack-mount bracket on each side of the front of the *SCE 2000*, as illustrated in the following figure. See [Tools and Parts Required](#) (on page 4-2) for a listing of the parts and tools required for installing the rack-mount.

To install the rack-mount brackets on the *SCE 2000* chassis, complete the following steps:

-
- Step 1** Align the rack-mount bracket to the side of the *SCE 2000*. Choose the proper bracket for your installation (2-post rack or 4-post rack) as illustrated in [Rack-Mounting a SCE 2000 Platform](#) ("Rack-Mounting a SCE 2000 Platform" on page 4-6).
- Step 2** Insert and tighten three screws.

Figure 4-4: Attaching the Mounting Brackets (4-post)

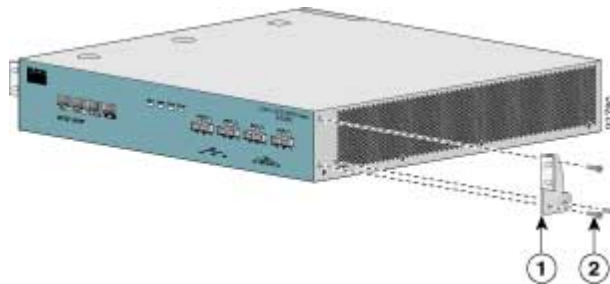
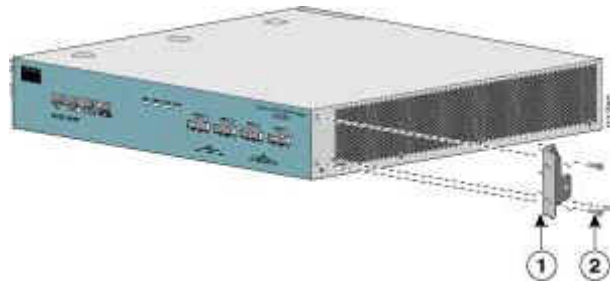

Figure 4-5: Attaching the Mounting Brackets (2-post)



- Step 3** Repeat steps 1 and 2 on the other side of the *SCE 2000*.

This completes the steps for attaching the rack-mount brackets to the *SCE 2000*.

If mounting the *SCE 2000* in a rack with only two posts, skip to [Mounting the System to a Rack](#) (Mounting the System to a Rack "Mounting the System to the Rack" on page 4-9).

If mounting the *SCE 2000* in a rack with four posts, proceed to the next step to attach the crossrail supports to the rack.

Attaching the Crossrail Supports to the Rack

When mounting in a rack with four posts (front and back) the two crossrail supports are mounted one on each side of the rack. The *SCE 2000* then slides into these crossrails, which support the weight of the unit.



Note

Cisco recommends that you allow at least 1 or 2 inches (2.54 or 5.08 cm) of vertical clearance between the *SCE 2000* and any equipment directly above and below it.

To install the crossrail supports on a four-post rack (both front and back posts), complete the following steps:

- Step 1** Assemble the two crossrail supports as illustrated below. Use three screws for each crossrail assembly.

Make sure that they are oriented so that both crossrails will support the *SCE 2000* when they are attached to the rack.

Figure 4-6: Assembling the Slider Brackets

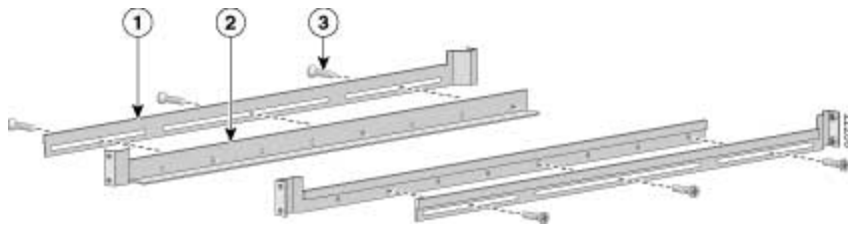

- Step 2** Align the crossrail supports with the side of the rack, parallel to the floor.
- Step 3** Insert and tighten two screws to the front posts or mounting strips of the rack
- Step 4** Insert and tighten two screws to the Back posts of the rack.

Figure 4-7: Attaching the Crossrails to the Rack

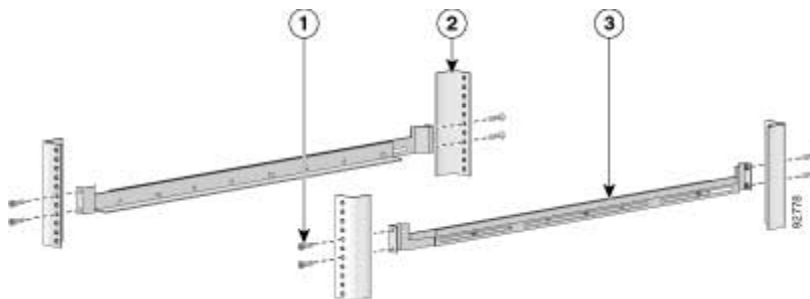

- Step 5** Repeat steps 2 through 4 on the other side of the rack, keeping the brackets flush against the posts and parallel to the supporting bracket on first side of the rack.

This completes the steps for attaching the rack-mount supporting brackets to the rack. You are now ready to mount the *SCE 2000* to the rack.

Mounting the System to the Rack

When the appropriate mounting brackets are securely installed, the *SCE 2000* can be installed into the rack.

To mount the *SCE 2000* to the rack after the brackets are installed, complete the following steps:

- Step 1** Make sure that your path to the rack is unobstructed. If the rack is on wheels, ensure that the brakes are engaged or that the rack is otherwise stabilized.
- Step 2** Position the *SCE 2000* so that the front end is closest to you, and lift it carefully to place it into the rack. To prevent injury, avoid sudden twists or moves.
- Step 3** Slide the *SCE 2000* into the rack, pushing it back until the brackets (installed at the front of the *SCE 2000*) meet the mounting strips or posts on both sides of the rack.

A rack with both front and back posts will have the crossrail supports installed. Slide the *SCE 2000* onto these crossrails and push it all the way back.

Figure 4-8: Sliding the SCE 2000 into the Rack

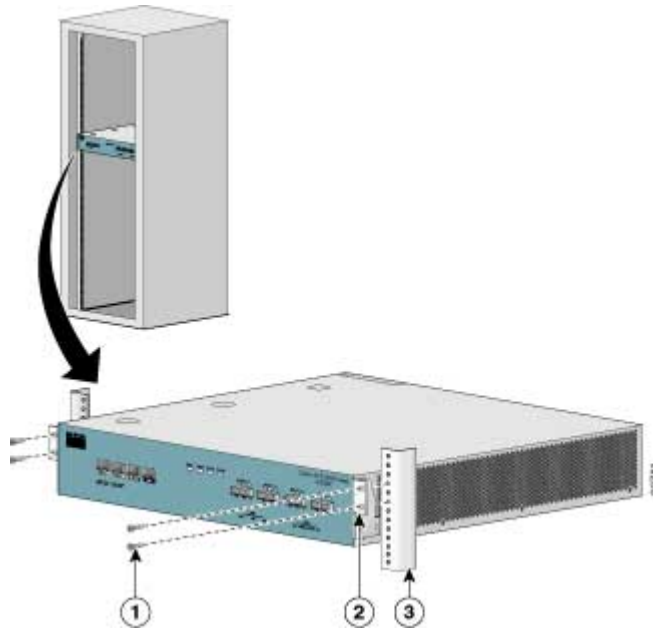

- Step 4** While keeping the brackets flush against the posts or mounting strips, align the holes in the brackets with the holes on the rack or mounting strip.

Figure 4-9: Securing the SCE 2000 to the Rack

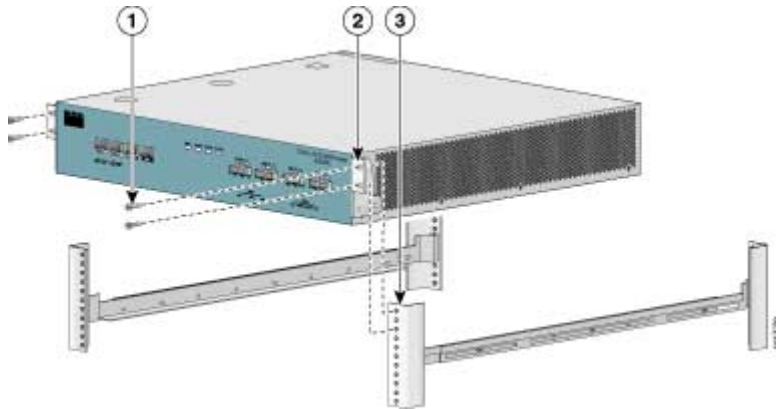

- Step 5** For each bracket, insert and tighten two appropriate screws to the rack.



- Note** Since the brackets support the weight of the entire *SCE 2000* chassis, be sure to use all four screws to fasten the two rack-mount brackets to the rack posts.

Attaching a Chassis Ground Connection

Before you connect the power or turn on the power to the *SCE 2000* platform, it is required that you provide an adequate chassis Ground (protective earth) connection for the *SCE 2000* chassis. A Grounding kit is provided with each *SCE 2000*.

Use the Grounding kit to properly ground the *SCE 2000* chassis (see *SCE 2000 Component List* (on page 2-6) for details).



- Warning** When installing the unit, the chassis ground connection must always be made first and disconnected last.

To connect the grounding cable to the chassis grounding connector on the *SCE 2000*, complete the following steps:

- Step 1** From the enclosed Grounding kit, remove the necessary materials — the grounding cable (green and yellow colored cable) and pairs of hex nuts and spring washers.
- Step 2** On the Rear panel of the *SCE 2000*, locate the chassis grounding connector (refer to the appropriate figure for an AC- or DC-powered *SCE 2000* below).

Step 3 Attach the grounding cable (green and yellow colored cable), firmly fastening the (enclosed) hex nuts and spring washers with a #1/4" hex wrench (refer to the appropriate figure for an AC- or DC-powered *SCE 2000* below).

The other side of the grounding cable must be connected to the site equivalent of the AC earth.

Figure 4-10: Grounding the Unit (AC)

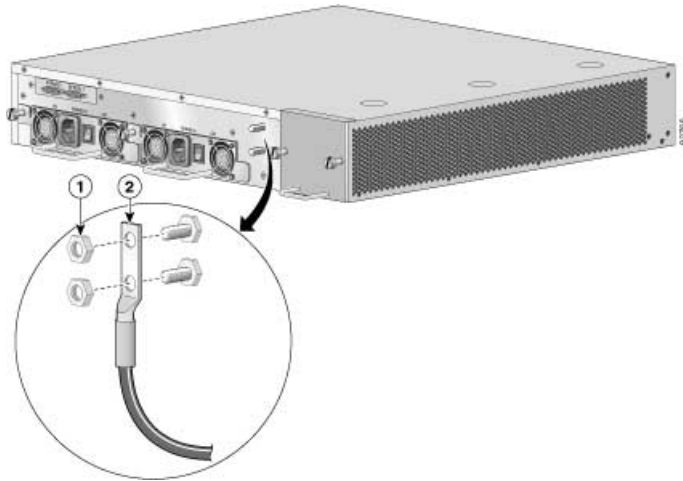
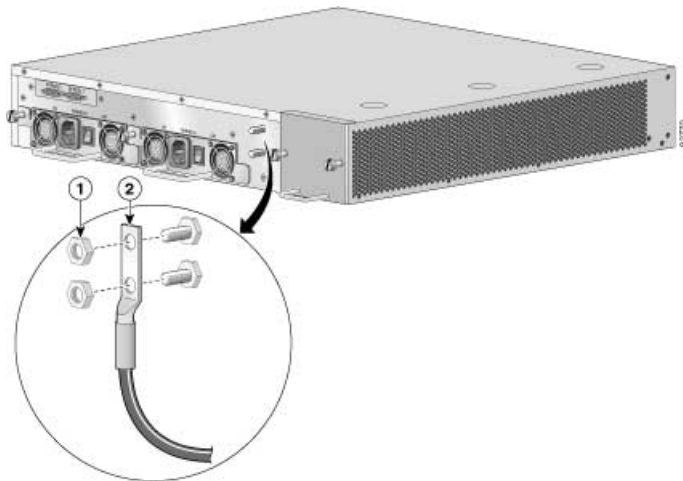

Figure 4-11: Grounding the Unit (DC)



This completes the procedure for installing the *SCE 2000* chassis. Proceed to the next section, *Connecting to the Power Supply*, to continue the installation.

Power Supply Overview

The *SCE 2000* is available in two power options:

- Dual line feed AC power — *SCE 2000* is shipped with two appropriate AC power supply cords.
- Dual line feed DC power — requires appropriate cables (hex or loop connectors) (see *Connecting the DC Power Supply*).

The dual power supply units supply hot-swappable, redundant power. Redundant power is useful as a failover; if a situation occurs where one power supply is down (for instance, a power supply fails or a new power supply needs to be installed), the *SCE 2000* can continue to run properly using the other power supply.

Each power supply has fans that cool the power supply unit. These fans also help to cool the internal components of the *SCE 2000*, as they direct the air flow to the outside through vents in the rear of the power supply unit.

The faceplates of both power supplies have a handle, an on/off switch, and one captive installation screw. An AC-input power receptacle is available on the AC-input power supply and a DC-input terminal block is available on the DC-input power supply.

Note that the power supply units are asymmetrical, with a screw in only one corner of the unit. Therefore, both power supply units can be fastened only if both units are inserted in the proper orientation. This also prevents the accidental installation of one DC unit and one AC unit. (Refer to the following figures).

The handle of the AC unit is at the bottom of the unit.

Figure 4-12: AC Power Module

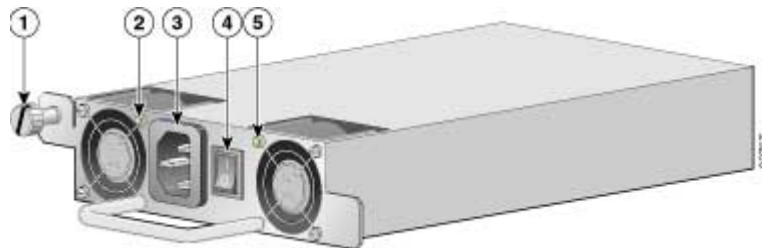

The handle of the DC unit is at the top of the unit.

Figure 4-13: DC Power Module

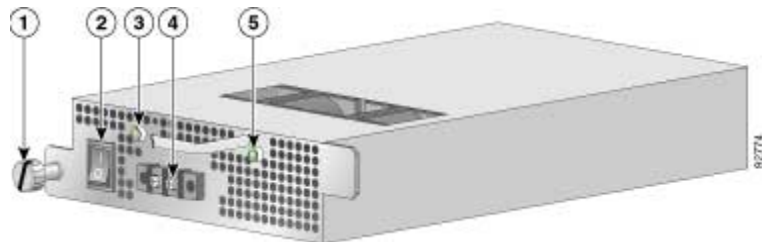

LEDs

The following LEDs are used to monitor the functioning of the power supply units:

- On the power supply unit (both AC-input and DC-input):
 - IN LED (green)
 - OK LED (green)
- On the *Front Panel* (on page 2-2):
 - Power LED: There are two Power LEDs on the front panel (Power A and Power B), one LED corresponding to each power supply unit

On both the AC-input and DC-input power supplies, the IN LED is used to monitor the voltages received by the platform from the power source. If the input voltages are within normal operating ranges, the green IN LED is illuminated. If the input voltages are above or below normal ranges, the IN LED is not illuminated.

On both the AC-input and DC-input power supplies, the OK LED is used to monitor the power supply DC output voltages used to power the platform. The normal operating ranges for the 12 VDC output voltage is between 11.9V and 12.1V. If the output voltages are within normal operating ranges, the green OK LED is illuminated. If the 12 VDC output voltages are above (more than 12.1V) or below (less than 11.9V) normal ranges, the OK LED is not illuminated.

The Power A and Power B LEDs on the front panel indicate whether the corresponding power supply unit is functioning normally.

Refer to the following tables for LED status information

Table 4-4 IN LED Status for AC-input and DC-input Power Supply Units

LED State	Power Supply Unit Condition
On (green)	The input voltage is in the required range.
Off	The input voltage is not in the required range.

Table 4-5 OK LED Status for AC-input and DC-input Power Supply Units

LED State	Power Supply Unit Condition
On (green)	The output voltage is in the required range (between 11.9 and 12.1 VDC).
Off	The output voltage is not within the required range. (is greater than 12.1 VDC or less than 11.9 VDC)

Table 4-6 Power LED (on front panel) Status for AC-input and DC-input Power Supply Units

LED State	Power Supply Unit Condition
Continuous green	Corresponding power supply unit is present and functioning normally
Red	Corresponding power supply unit present, but malfunctioning
Unlit	Corresponding power supply unit is either not present or has failed.

**Note**

Simple Network Management Protocol (SNMP) monitors the activity of the power supplies. In most cases when a power supply problem occurs, an SNMP trap is sent in SNMP and the appropriate message is posted on the *SCE 2000* CLI.

Power Supply Specifications

The following table lists the AC-input and DC-input power supply specifications for the *SCE 2000* platform:

Table 4-7 SCE 2000 Power Supply Specifications

AC-input power	200W maximum
AC-input voltage rating	100 to 240 VAC
AC-input current rating	Rated for 4.5A when $V_{in} = 100$ VAC or 2A when $V_{in} = 200$ VAC
AC-input frequency rating	50 to 60 Hz
AC-input cable	18 AWG three-wire cable, with a three-lead IEC-320 receptacle on the power supply end, and a country-dependent plug on the power source end.
DC-input power	200W maximum
DC-input voltage rating	-48/-60 VDC nominal (-36 to -72 VDC supply tolerance)
DC-input current rating	7A at -48 VDC
DC-input cable	12 AWG or 2.5-mm copper installation wire with hex or loop connectors
DC-input circuit breaker	One Fast 10A for each power supply unit

**Note**

For AC-input power, we recommend powering the *SCE 2000* platform from a 120 VAC, 15A receptacle U.S. (240 VAC, 10A international) at the power source.

Removing and Replacing a Power Supply Unit

The procedures for removing and replacing the AC-input or DC-input power supply are explained in the following sections:

- [Powering Down the Power Supply Unit and Disconnecting Input Power](#) (on page 4-15)
- [Removing the Power Supply Unit](#) (on page 4-16)
- [Replacing the Power Supply Unit](#) (on page 4-17)
- [Reconnecting the Power](#) (on page 4-17)

**ESD Warning**

Do not remove or install modules without using appropriate anti-static guard measures. The *SCE 2000* includes an anti-static wrist strap in the accessory kit. Attach the copper tape strap to an unpainted metal surface on the chassis. You may leave the strap connected to the chassis when you have finished.

**Warning**

Never install an AC power module and a DC power module in the same chassis.

Powering Down the Power Supply Unit and Disconnecting Input Power

The following sections describe how to remove power from an AC-input power supply and a DC-input power supply:

- [Powering Down an AC-Input Power Supply](#) (on page 4-15)
- [Powering Down a DC-Input Power Supply Unit and Removing the DC-Input Leads](#) (on page 4-16)

Powering Down an AC-Input Power Supply

To power down an AC-input power supply to the *SCE 2000* platform, complete the following steps:

**Warning**

Make sure that the power supply unit is switched off before replacing a power supply unit (NO hot-swap).

Note that one AC-input power supply can be running when the other power supply is being removed or replaced.

- Step 1** Place the on/off switch on the AC-input power supply in the OFF (O) position.
- Step 2** Observe that the corresponding Power LED on the front panel turns off.
- Step 3** Remove the cable from the AC-input power receptacle

This completes the procedure for powering down an AC-input power supply unit on a *SCE 2000* platform. Proceed to [Removing the Power Supply Unit](#) (on page 4-16).

Powering Down a DC-Input Power Supply Unit and Removing the DC-Input Leads

To power down a DC-input power supply to the *SCE 2000* platform, complete the following steps:



Warning

Before completing any of the following steps, and to prevent short-circuit or shock hazards, ensure that power is removed from the DC circuit. To ensure that all power to the power supply unit is OFF, locate the circuit breaker on the panel board that services the DC circuit, switch the circuit breaker to the OFF position, and tape the switch handle of the circuit breaker in the OFF position.

Note that the power to the relevant power supply unit should be off, not necessarily all power to the *SCE 2000* platform. One DC-input power supply can be running when the other power supply is being removed or replaced.

- Step 1** Place the on/off switch on the DC-input power supply in the OFF (O) position.
- Step 2** Make sure that that power is removed from the DC circuit by turning off the circuit breaker or switch providing power to the DC-input power supply.
- Step 3** Observe that the corresponding Power LED on the front panel turns off.
- Step 4** Remove the screw from one DC power line input lead receptacle and pull the lead from the connector. Repeat this step for the remaining lead.

This completes the procedure for powering down a DC-input power supply unit on a *SCE 2000* platform. Proceed to [Removing the Power Supply Unit](#) (on page 4-16).

Removing the Power Supply Unit

To remove the AC-input or DC-input power supply unit from the *SCE 2000* platform, complete the following steps:

- Step 1** Using a 1/4-inch flat-blade screwdriver, loosen the captive installation screw on the corner of the faceplate of the power supply.
- Step 2** Grasp the power supply handle and pull the power supply from the router.

This completes the procedure for removing the power supply from a *SCE 2000* platform.

Replacing the Power Supply Unit

**Warning**

Do not mix AC-input and DC-input power supply units in the same *SCE 2000* platform.

To install a new power supply into a *SCE 2000* platform, complete the following steps:

- Step 1** Grasp the power supply unit handle with one hand and place your other hand underneath the power supply for support.
- Step 2** Fit the groove in the side of the new power supply module into the guide in the chassis.
- Step 3** Gently, but firmly, slide the module into the chassis until its faceplate is flush with the chassis rear panel.

**Warning**

When inserting a power supply into the *SCE 2000* platform, do not use unnecessary force; slamming the power supply into the chassis can damage the connectors on the rear of the power supply.

- Step 4** Seat the power supply in the *SCE 2000* platform by tightening the captive installation screw with a 1/4-inch flat-blade screwdriver.

**Note**

The power supply is not fully seated until you tighten the installation screw on the faceplate.

This completes the procedures for replacing a power supply in a *SCE 2000* platform.

Reconnecting the Power

The following sections describe how to reconnect the AC or DC power:

- [Reconnecting AC-Input Power Supply Unit](#) (on page 4-18)
- [Reconnecting DC-Input Power Supply Unit](#) (on page 4-19)

Reconnecting AC-Input Power Supply Unit

The following procedures explain how to reconnect an AC-input power to the *SCE 2000* platform.

If you are reconnecting DC-input power, proceed to [Reconnecting DC-Input Power Supply Unit](#) (on page 4-19).

To reconnect the AC-input power to the *SCE 2000* platform, complete the following steps:

-
- Step 1** Plug the AC-input power cable into the AC-input power receptacle on the AC-input power supply

Figure 4-14: Connecting the AC Power

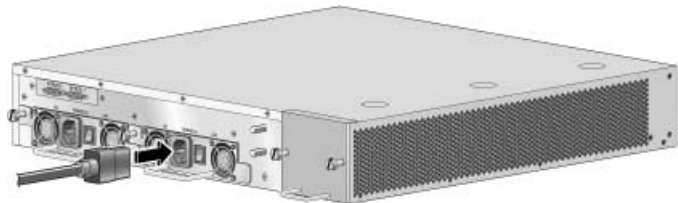

-
- Note** For AC-input power, we recommend powering the *SCE 2000* platform from a 120 VAC, 15A receptacle U.S. (240 VAC, 10A international) at the power source. 15 A branch circuit protection is recommended.
-

- Step 2** Plug the AC power supply cable into the AC power source.
- Step 3** Turn the on/off switch to the on (|) position.
- Step 4** Look at the IN and OK LEDs on the power supply unit and the corresponding Power LED on the front panel. If the new AC-input power supply unit is operating properly, these LEDs will be glowing green.
- Step 5** Ensure that the power supply is properly aligned and the installation screw is tightened.
-

This completes the steps for reconnecting the AC-input power supply to the *SCE 2000* platform.

Reconnecting DC-Input Power Supply Unit

The following procedures explain how to reconnect a DC-input power to the *SCE 2000* platform.



Warning

Before completing any of the following steps, and to prevent short-circuit or shock hazards, ensure that power is removed from the DC circuit. To ensure that all power to the power supply unit is OFF, locate the circuit breaker on the panel board that services the DC circuit, switch the circuit breaker to the OFF position, and tape the switch handle of the circuit breaker in the OFF position.

Note that the power to the relevant power supply unit should be off, not necessarily all power to the *SCE 2000* platform. One DC-input power supply can be running when the other power supply is being removed or replaced.



Warning

Wiring should be done by a professional in accordance with state and local electrical codes.

To reconnect the DC-input power to the *SCE 2000* platform, complete the following steps:

- Step 1** Ensure that the DC power line input leads are disconnected from the power source.
- Step 2** Using the number 2 Phillips screwdriver, remove the protective plate from the terminal block.
- Step 3** Insert one receptacle screw into the hex or loop connector on one power line input, insert the screw with the connector into the corresponding lead receptacle and tighten the receptacle screw using the number 2 Phillips . Repeat for the remaining power line input lead.

Figure 4-15: Connecting the DC Power

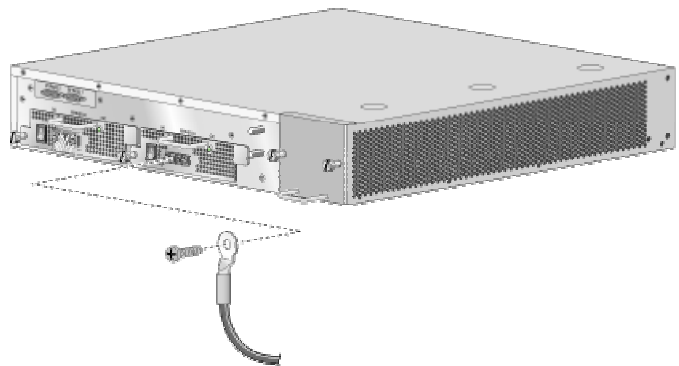

Note

The color coding of the DC-input power supply leads depends on the color coding of the DC power source at your site. Make certain the lead color coding you choose for the DC-input power supply matches lead color coding used at the DC power source.



Note Use 12 AWG (2.5 mm) copper wire only with hex or loop connectors. Ring terminals must be UL approved and suitable for 12 AWG wire.

- Step 4** Using the number 2 Phillips screwdriver, securely fasten the protective plate to the terminal block.
- Step 5** Connect the DC power line input leads to the DC power source through a fast 10A circuit breaker.
- Step 6** Turn the on/off switch to the on (|) position.
- Step 7** Look at the IN and OK LEDs on the power supply unit and the corresponding Power LED on the front panel. If the new DC-input power supply unit is operating properly, these LEDs will be glowing green.
- Step 8** Ensure that the power supply is properly aligned and the installation screw is tightened.
-

This completes the steps for reconnecting the DC-input power supply to the *SCE 2000* platform.

Fan Module Overview

The fan module provides cooling for the internal components. The fan drawer is a field-replaceable unit containing five fans, and is installed at the right rear of the *SCE 2000* platform.

When a fan malfunctions, the fan module should be replaced as promptly as possible. Although it is possible for the unit to function for some time with one non-functioning fan, this is not optimal or recommended.

Figure 4-16: *SCE 2000* Fan Module

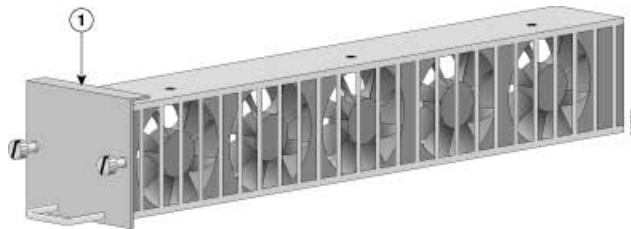

When a fan failure occurs, the environment monitor will send an error message to the console. An SNMP trap indicating that the fan is not functioning properly is also sent. Note that a fan failure is often audible.

Removing and Replacing the Fan Module

The following sections explain how to remove and replace a fan module in a *SCE 2000* platform:

- [Removing the Fan Module](#) (on page 4-21)
- [Replacing the Fan Module](#) (on page 4-21)

**ESD Warning**

Do not remove or install modules without using appropriate anti-static guard measures. The *SCE 2000* includes an anti-static wrist strap in the accessory kit. Attach the copper tape strap to an unpainted metal surface on the chassis. You may leave the strap connected to the chassis when you have finished.

**Warning**

Removing the Fan Module

When removing the fan drawer, keep hands and fingers away from the spinning fan blades. Let the fan blades stop completely before removing the fan drawer.

To remove the fan module, complete the following steps:

- Step 1** Using a 1/4-inch flat-blade screwdriver, loosen the two captive screws on the faceplate of the fan module.
- Step 2** Grasp the fan module handle and remove it from the router.

This completes the procedure for removing the fan module from a *SCE 2000* platform.

Replacing the Fan Module

To install a new fan module into a *SCE 2000* platform, complete the following steps:

- Step 1** Grasp the fan module handle with one hand and place your other hand underneath the fan module for support. The handle of the unit should be at the bottom.
- Step 2** Fit the groove in the side of the new fan module into the guide in the chassis.
- Step 3** Gently, but firmly, slide the module into the chassis until its faceplate is flush with the chassis rear panel.

Figure 4-17: Inserting the Fan Module

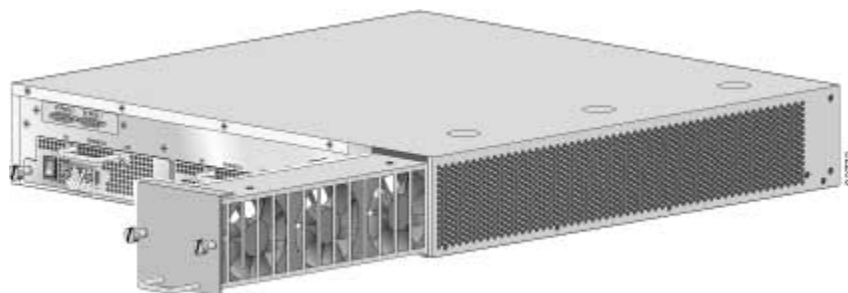

Replacing the Battery

**Warning**

When inserting a fan module into the *SCE 2000* platform, do not use unnecessary force; slamming the fan module into the chassis can damage the connectors on the rear of the module.

Step 4

Seat the fan module in the *SCE 2000* platform by tightening the two captive installation screws with a 1/4-inch flat-blade screwdriver.

**Note**

The fan module is not fully seated until you tighten the installation screws on the faceplate.

This completes the procedures for replacing a fan module in a *SCE 2000* platform.

Replacing the Battery

The *SCE 2000* has a lithium battery on its main circuit board. When the battery loses its charge, call Cisco Technical Support to replace the battery.

**Warning**

Do not attempt to replace this battery yourself

**Warning**

There is danger of explosion if the lithium battery is incorrectly replaced. Replace only with the same or equivalent type recommended by the manufacturer. Dispose of used batteries according to the manufacturer's instructions.

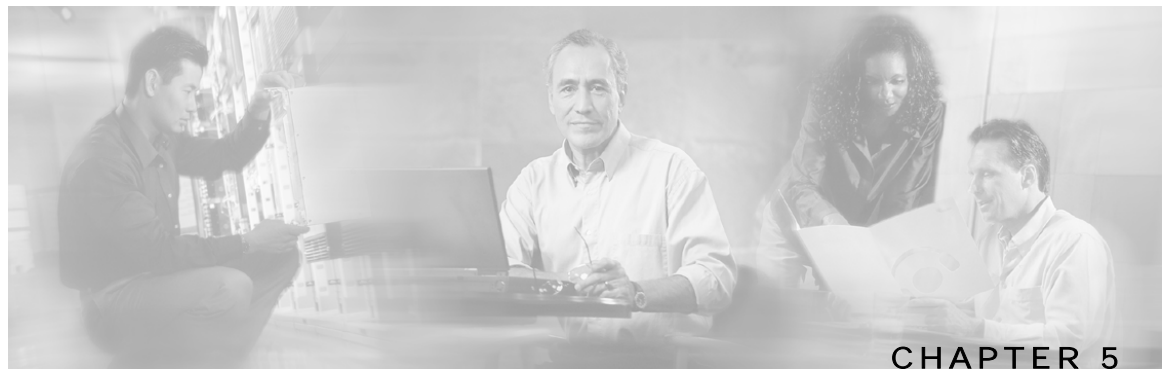

Connecting the Management Interfaces and Performing Initial System Configuration

This chapter explains how to connect the *SCE 2000* platform to a local console and perform the initial system configuration via the setup wizard that runs automatically.

Additionally, this chapter contains instructions for cabling the Fast Ethernet Management interfaces.

**Note**

When installing a cascaded system, it is extremely important to follow the sequence of procedures outlined in the section *Installing a Cascaded System* (on page 6-10).

This chapter contains the following sections:

- [Connecting the Local Console](#) 5-1
- [Initial System Configuration](#) 5-3
- [Connecting the Management Interface](#) 5-25

Connecting the Local Console

Even if you will be managing the *SCE 2000* from a remote location, you must first connect the unit to a local console and configure the initial settings for the *SCE 2000* to support remote management. When the initial connection is established, the setup utility will run automatically, prompting you to perform the initial system configuration.

Setting Up the Local Console

This section provides instructions for setting up your local terminal at your workstation, to enable you to perform the initial system configuration of the *SCE 2000* system using the setup utility.

Figure 5-1: Connecting to the Local Console



Make sure that the terminal configuration is as follows:

- 9600 baud
- 8 data bits
- No Parity
- 1 stop bits
- No flow control

The above *SCE 2000* port parameters are fixed and are not configurable.

To set up the local console, complete the following steps:

Step 1 Plug the RS-232 serial cable provided with the *SCE 2000* into the CON port on the front panel of the *SCE 2000*.

Make sure that you push on the RJ-45 connector (attached to the RS-232 serial cable) until you hear a “click”, which indicates that the connector is fully inserted and secured in the receptacle. Gently pull on the plug to confirm whether the plug is locked into the socket.

Step 2 Connect the other end of the serial cable (with an attached DB-9 connector) to the VT100 compatible local (serial) terminal.

Step 3 Make sure the local terminal is configured as a VT-100 terminal, according to the fixed *SCE 2000* CON port parameters.

Step 4 Press **Enter** several times until the Cisco logo appears on the local terminal and the setup configuration dialog is entered.

```
--- System Configuration Dialog ---
```

```
At any point you may enter a question mark '?' followed by 'Enter' for help.
Use ctrl-C to abort configuration dialog at any prompt.
Use ctrl-Z to jump to the end of the configuration dialog at any prompt.
Default settings are in square brackets '['].
```

```
Would you like to continue with the System Configuration Dialog? [yes/no]: y
```

Step 5 Type **y** and press **Enter**.

The system configuration dialog begins.

Initial System Configuration

Upon initial connection to the local terminal, as described above, the system configuration wizard automatically runs to guide the user through the entire setup process. The wizard prompts for all necessary parameters, displaying default values, where applicable. You may accept the default values or define other values.

With the exception of the time settings, which take effect immediately when entered, the new configuration is applied and saved only at the end of the dialog when approved by the user. Therefore, if the setup dialog is aborted, no change takes place in the configuration, other than time settings (if entered).

When the dialog is complete, you may review the new configuration before applying it. The system displays the configuration, including parameters that were not changed. The system also displays any errors that are detected in the configuration. When the configuration is satisfactory, you may apply and save the new configuration.

The following table lists all the parameters included in the initial configuration. It is recommended that you obtain values for any parameters that you will configure at this time before beginning the setup.



Note

For further information regarding any configuration step or specific parameter, refer to the relevant section in the *Cisco Service Control Engine (SCE) Software Configuration Guide*.

Setup Command Parameters

Table 5-1 Setup Command Parameters

Parameter	Definition
IP address	IP address of the <i>SCE 2000</i> .
subnet mask	Subnet mask of the <i>SCE 2000</i> .
default gateway	Default gateway.
hostname	Character string used to identify the <i>SCE 2000</i>
admin password	Admin level password. Character string from 4-100 characters beginning with an alpha character.
root password	Root level password. Character string from 4-100 characters beginning with an alpha character.
password encryption status	Enable or disable password encryption?
Time Settings	

Initial System Configuration

Parameter	Definition
time zone name and offset	Standard time zone abbreviation and minutes offset from UTC.
local time and date	Current local time and date. Use the format: 00:00:00 1 January 2002
SNTP Configuration	
broadcast client status	Set the status of the SNTP broadcast client. If enabled, the SCE will synchronize its local time with updates received from SNTP broadcast servers.
unicast query interval	Interval in seconds between unicast requests for update (64 – 1024)
unicast server IP address	IP address of the SNTP unicast server.
DNS Configuration	
DNS lookup status	Enable or disable IP DNS-based hostname translation.
default domain name	Default domain name to be used for completing unqualified host names
IP address	IP address of domain name server. (maximum of 3 servers)
RDR Formatter Destination Configuration	
IP address	IP address of the RDR-formatter destination
TCP port number	TCP port number of the RDR-formatter destination
Access Control Lists	
Access Control List number	How many ACLs will be necessary? What IP addresses will be permitted/denied access for each management interface? You may want ACLs for the following: <ul style="list-style-type: none"> • Any IP access • Telnet access • SNMP GET access • SNMP SET access
list entries (maximum 20 per list)	IP address, and whether permitted or denied access.
IP access ACL	ID number of the ACL controlling IP access.
telnet ACL	ID number of the ACL controlling telnet access.
SNMP Configuration	
SNMP agent status	Enable or disable SNMP management.
GET community names	Community strings to allow GET access and associated ACLs (maximum 20).
SET community names	Community strings to allow SET access and associated ACLs (maximum 20).
trap managers (maximum 20)	Trap manager IP address, community string, and SNMP version.

Parameter	Definition
Authentication Failure trap status	Sets the status of the Authentication Failure traps.
enterprise traps status	Sets the status of the enterprise traps.
system administrator	Name of the system administrator.
Topology Configuration	
connection mode	Is the <i>SCE 2000</i> installed using inline topology or receive-only topology using an optical splitter?
type of deployment	Is this a cascade topology, with two <i>SCE 2000s</i> connected via the cascade ports? Or is this a single platform topology?
physically connected link (cascade topology only)	In a cascade deployment this parameter sets the index for the link that this <i>SCE 2000</i> is deployed on. The options for <i>SCE 2000</i> are link-0 or link-1. In a single- <i>SCE 2000</i> Platform deployment this parameter is not relevant since one <i>SCE 2000</i> is deployed on both links. In this case the link connected to port1-port2 is by default link-0 and the link connected to port3-port4 is be default link-1.
priority (cascade topology only)	If this is a cascaded topology, is this <i>SCE 2000</i> the primary or secondary <i>SCE 2000</i> ?
on-failure behavior (inline connection mode only)	If this <i>SCE 2000</i> is deployed inline, should the failure behavior be bypass or cutoff of the link?
Admin status of the <i>SCE 2000</i> after abnormal boot	After a reboot due to a failure, should the <i>SCE 2000</i> remain in a Failure status or move to operational status provided no other problem was detected?

Following are some general instructions regarding the setup dialog:

- All default values appear in square brackets [**default**].

If no value appears in the brackets [], or more than one option appears [**yes/no**], then this parameter does not have a default value.

- To accept the default value, press **Enter**.
- If you need more information about any parameter, type ? and press **Enter**.

A help message will appear describing the expected format of the parameter and any other requirements.

- To jump to the end of the setup dialog at any point, accepting all remaining default values, press **^z**.
- In certain cases, there will be two or more logically related parameters within a menu. In these situations, it is not permitted to jump to the end of the setup dialog until all related parameters are configured. If you try to jump to the end of the setup dialog, the following message will appear: "Sorry, Skipping is not allowed at this stage."

- Certain groups of related parameters, such as time, date, and SNTP settings, form sub-dialogs or menus within the setup dialog. You may skip an entire menu, thereby accepting all default values for the parameters within the menu.

Each group of related parameters is prefaced by a question, asking whether you want to enter the menu. To skip the menu, answer no (“n”) to the question.

EXAMPLE:

```
Would you like to enter the SNMP configuration menu? n
```

- To abort the setup dialog at any point without making any configuration changes, press **^c**. All changes already entered will be lost, with the exception of time settings.

Step 1: Configuring Initial Settings

Verify the following initial settings for the *SCE 2000*:

- IP address
- Subnet mask
- Default gateway

All values are Internet addresses of the form ‘X.X.X.X’, where each letter corresponds to a decimal number between 0 and 255.

To configure the initial settings, complete the following steps:

-
- Step 1** The current IP address is displayed.
- To accept the displayed value, press **Enter**.
 - To change the value, type the desired value in the format “x.x.x.x” and press **Enter**.
- Step 2** The current subnet mask is displayed.
- To accept the displayed value, press **Enter**.
 - To change the value, type the desired value in the format “x.x.x.x” and press **Enter**.
- Step 3** The current IP address of the default gateway is displayed.
- To accept the displayed value, press **Enter**.
 - To change the value, type the desired value in the format “x.x.x.x” and press **Enter**.
-

EXAMPLE:

The following example displays a typical configuration of the IP address (10.1.5.109), subnet mask (255.255.0.0), and default gateway (10.1.1.3).

Since the IP address and the subnet mask are related, when the IP address is changed, there is no longer a default value of the subnet mask, and it must be entered explicitly.

```
Enter IP address [10.1.1.201]:10.1.5.109
Enter IP subnet mask:255.255.0.0
Enter IP address of default gateway [10.1.1.3]:
```

Step 2: Configuring the Hostname

The hostname is used to identify the *SCE 2000*. It appears as part of the CLI prompt and is also returned as the value of the MIB-II object sysName.

The default hostname is *SCE 2000*.

To configure the hostname, complete the following steps:

Step 1 The current hostname is displayed.

- To accept the displayed value, press **Enter**.
- To change the value, type any desired character string and press **Enter**.

Enter hostname [*SCE 2000*]:

Step 3: Setting the Passwords

Configure the passwords as follows:

- Set the password for each authorization level (User, Admin, Root).
- Enable/disable password encryption. When password encryption is enabled, it encrypts the previously entered passwords.



Note

Passwords are needed for all authorization levels in order to prevent unauthorized users from accessing the *SCE 2000*. Admin level should be used by the network administrator. Root level is for use by Cisco technician.

Passwords must meet the following criteria:

- Minimum length — 4 characters
- Maximum length — 100 characters
- Begin with an alpha character
- May contain only printable characters



Note

Passwords are case sensitive.



Note

The default password for all levels is “cisco”.

To change the passwords, complete the following steps:

-
- Step 1** The default User password is displayed.
- To accept the displayed value, press **Enter**.
 - To change the value, type the desired string and press **Enter**.
- Step 2** The default Admin password is displayed.
- To accept the displayed value, press **Enter**.
 - To change the value, type the desired string and press **Enter**.
- Step 3** The default Root password is displayed.
- To accept the displayed value, press **Enter**.
 - To change the value, type the desired string and press **Enter**.
- Step 4** Configure password encryption. By default, password encryption is not enabled.
- To disable password encryption, press **Enter**.
 - To enable password encryption, type **y** and press **Enter**.
-

EXAMPLE:

Following is an example of changing all passwords. Password encryption is not enabled (default).

```
Enter a User password [cisco]: userin
Enter an Admin password [cisco]: mng123
Enter a Root password [cisco]: cistech
Enable passwords encryption? [no]:
```

Step 4: Configuring Time Settings

The time settings menu configures all time and date related parameters in the system. The time settings menu includes the following:

- Time zone
- Local time
- Date
- SNTP menu

You must enter the time setting menu in order to configure SNTP settings. You may choose to skip the time settings menu if you wish to accept all default values.



Note Unlike all other settings defined in the system configuration, setting the time is done immediately and not at the end of the setup process.

To configure the time settings, complete the following steps:

Step 1 Enter the time settings menu.

Would you like to enter the Time settings menu? [no]: **y**

Type **y** and press **Enter**.

The time settings dialog begins.

Step 2 Type the time zone abbreviation and press **Enter**.

Enter time zone name [UTC]: **CET**

Step 3 Type the minutes offset from UTC and press **Enter**.

Enter time zone minutes offset from UTC: **60**

The local time and date are displayed, and you are asked whether you want to change them.

The local time and date is 15:00:01 CET FRI 01 July 2002

Would you like to set a new time and date? [no]:

Step 4 If the time and date are correct, go to step 5.

If the time and date are not correct, answer yes to the above question, and press **Enter**.

Would you like to set a new time and date? [no]: **y**

Confirm your response and type the new time and date.

This change will take effect immediately both on the system clock and the calendar; it will also set the time zone you entered. Are you sure?

[yes/no]: **y**

Enter new local time and date: **14:00:01 1 July 2002**

Time zone was successfully set.

The system clock and the calendar were successfully set.

Step 5 You are asked whether you wish to enter the SNTP configuration menu.

If you do not wish to configure the SNTP, skip the rest of this section and go to [Step 5: Configuring the DNS Settings](#) (on page 5-10).

To enter the SNTP configuration dialog, type **y**, and press **Enter**

Would you like to enter the SNTP configuration menu? [no]: **y**

Step 6 Configure the SNTP broadcast client. By default the SNTP broadcast client is not enabled.

- To disable the SNTP broadcast client, press **Enter**.
- To enable the SNTP broadcast client, type **y** and press **Enter**.

Enable SNTP broadcast client? [no]:

Step 7 Define the time interval between unicast updates.

- To accept the displayed default value, press **Enter**.
- To change the value, type the desired number of seconds (64 through 1024) and press **Enter**.

Enter time interval in seconds between unicast updates [1024]:

Step 8 You may enter an IP address for the SNTP unicast server. Type in the hostname or the IP address in the form *x.x.x.x*, and press **Enter**

Would you like to configure SNTP unicast servers? [no]: **y**

Enter IP address or hostname of SNTP unicast server: **10.1.1.1**

EXAMPLE:

Following is a sample time setting dialog. In addition to setting the time zone, time and date are changed, and SNTP unicast updates are configured.

```
Would you like to enter the Time settings menu? [no]: y
Enter time zone name [UTC]: ISR
Enter time zone minutes offset from UTC: 120

The local time and date is 15:35:23 ISR FRI July 19 2002
Would you like to set a new time and date? [no]: y
This change will take effect immediately both on the system clock and the
calendar; it will also set the time zone you entered. Are you sure?
[yes/no]: y
Enter new local time and date: 14:35:23 19 July 2002
Time zone was successfully set.
The system clock and the calendar were successfully set.
Would you like to enter the SNTP configuration menu? [no]: y
Enable SNTP broadcast client? [no]: y
Enter time interval in seconds between unicast updates [900]:
Would you like to configure SNTP unicast servers? [no]: y
Enter IP address or hostname of SNTP unicast server: 10.1.1.1
```

Step 5: Configuring the DNS Settings

The DNS configuration menu defines the IP address of the domain name server, which is used for DNS lookup, as well as the default domain name, which is used to complete unqualified host names.

You may choose to skip the DNS configuration menu if you wish to accept all default values.

To configure DNS settings, complete the following steps:

Step 1 Enter the DNS settings menu.

```
Would you like to enter the DNS configuration menu? [no]: y
```

Type **y** and press **Enter**.

The DNS settings dialog begins.

Step 2 Enable or disable DNS lookup.

- To enable DNS lookup, press **Enter**.
- To disable DNS lookup, type **n** and press **Enter**.

```
Enable IP DNS-based hostname translation? [yes]:
```

If you choose to disable DNS lookup, skip the rest of this section and go to [Step 6: Configuring the RDR Formatter Destination](#) (on page 5-11). The rest of the dialog is not presented, as it is irrelevant when DNS lookup is disabled.

Step 3 Type the default domain name to be used, and press **Enter**.

Note that there is no default domain name.

You may accept the default domain name or enter a new one.

```
Enter default domain name []:
```

Step 4 Type the IP address of the primary domain name server and press **Enter**.

```
Enter Primary DNS IP address:
```

Note that there is no default for this parameter.

- Step 5** You may configure up to three domain servers.
Would you like to add another Name Server? [no]:
- To exit the DNS settings dialog, press **Enter**.
 - To add another domain server, type **y** and press **Enter**.

You are asked to enter the IP address of the next domain name server.
Enter Secondary DNS IP address:

- Step 6** When IP addresses for all servers have been entered, exit the dialog by pressing **Enter**.
Would you like to add another Name Server? [no]:
-

EXAMPLE:

Following is a sample DNS configuration dialog. The default domain name is pcube.com, and the IP address of the Domain Name Server is 10.1.1.230.

```
Would you like to enter the DNS configuration menu? [no]: y
Enable IP DNS-based hostname translation? [yes]:
Enter default domain name []: pcube.com
Enter Primary DNS IP address: 10.1.1.230
Would you like to add another Name Server? [no]:
```

Step 6: Configuring the RDR Formatter Destination

The *SCE 2000* passes Raw Data Records (RDRs) to an external collection system via the RDR-Formatter. In order for the data to reach the correct location, the IP address of the external collection system and its port number must be configured.

To configure the RDR-formatter destination, complete the following steps:

- Step 1** Enter the RDR formatter configuration menu.
Would you like to enter the RDR-formatter configuration menu? [no]: y
Type **y** and press **Enter**.

The RDR-formatter destination dialog begins.

- Step 2** Type the IP address of the RDR-formatter destination and press **Enter**.
Enter RDR-formatter destination's IP address:

Note that there is no default for this parameter.

- Step 3** Type the TCP port number of the RDR-formatter destination and press **Enter**.

Note that there is no default for this parameter.
Enter RDR-formatter destination's TCP port number:

EXAMPLE:

Following is a sample RDR-formatter configuration dialog, assigning the IP address and TCP port number.

```
Would you like to enter the RDR-formatter configuration menu? [no]: y
Enter RDR-formatter destination's IP address: 10.1.1.230
Enter RDR-formatter destination's TCP port number: 33000
```

Step 7: Configuring Access Control Lists (ACLs)

The *SCE 2000* can be configured with Access Control Lists (ACLs), which are used to permit or deny incoming connections on any of the management interfaces.



Note ACL #0 is a pre-defined list that permits access to all IP addresses.

Configuration of access control lists is done in two stages:

Step 1 Create the access control lists.

You may create 99 ACLs with a maximum of 20 entries per list. Each entry consists of an IP address, and an indication of whether access is permitted or denied to this IP address.

Step 2 Assign the ACLs to the appropriate management interface. (See Step 9: Configuring the Topology-Dependent Parameters.)

The dialog permits you to skip the creation/editing of the ACLs and go directly to assigning ACLs to the management interfaces.

Entry Formats

Each ACL may permit/deny access to any IP address, one or more ranges of IP addresses, or one or more individual IP address. Three entry formats are available to support these options:

- **Any IP address** — Type the word “**any**”. Any IP address will be permitted or denied access.
- **Range of IP addresses** — Type the beginning IP address in the desired range, then enter the wildcard bits that define the range.

This wildcard functions like a reverse mask, in that all “1” bits in the wildcard indicate the corresponding bit in the IP address should be ignored. All other bits must match the corresponding bit in the specified IP address. Refer to the table below for examples.

Each range of IP addresses can be configured to be permitted or denied access.

- **Individual IP address** — Type the desired IP address, then enter the wildcard bits **0.0.0.0**.

Each individual IP address can be configured to be permitted or denied access.

Table 5-2 IP address/Wildcard bit examples

Initial IP address	Wildcard bits	Range
10.1.1.0	0.0.0.255	10.1.1.0–10.1.1.255
10.1.1.0	0.0.0.63	10.1.1.0–10.1.1.63
10.1.1.0	0.0.0.0	10.1.1.0 (individual entry)

Order of Entries

The order of the entries in the list is important. The entries in the list are tested sequentially, and the action is determined by the first entry that matches the connecting IP address. Therefore, when the entry “any” appears in an Access Control List, all succeeding entries are irrelevant.

Consider two hypothetical ACLs containing the same entries in a different order.

The following list would permit access to all IP addresses, including 10.1.1.0:

permit any

deny 10.1.1.0

Note that the above list could not actually be created using the setup utility, since after the “any” entry, no other entries could be added to the list.

The following list will deny access to IP address 10.1.1.0, but permit access to all others:

deny 10.1.1.0

permit any

If no entry in the assigned Access Control List matches the connection, or if the Access Control List is empty, the default action is **deny**.

To create the access control lists, complete the following steps:

-
- Step 1** Enter the Access Control Lists configuration menu.
 Would you like to enter the Access lists configuration menu? [no]: **y**
 Type **y** and press **Enter**.
 The Access Control Lists configuration dialog begins.
- Step 2** You have the option of creating or modifying Access Control Lists, or skipping this section and proceeding directly to assign the existing ACLs to the desired management interfaces.
 Would you like to create new Access lists or modify existing lists? [no]: **y**
 If you choose not to create or edit Access Control Lists, skip to Step 9: Configuring the Topology-Dependent Parameters.
- Step 3** Type the number of the Access Control List to be configured (1 through 99) and press **Enter**.
 Note that there is no default for this parameter.
- Step 4** Begin adding entries to the selected list.
 Indicate whether this entry is permitted access or denied access.
- To permit access press **Enter**.

- To deny access type **n** and press **Enter**.

Does this entry permit access? [yes]:

Step 5 Type the IP address to be added to this list, and press **Enter**.

Type “**any**” and press **Enter** to include any IP address in the ACL.

Note that there is no default for this parameter.

Enter IP address or the word ‘any’ to denote any IP address:

Step 6 If you entered a specific IP address, enter the wildcard bits to define a range of IP addresses and press **Enter**. (See *Entry Formats* (on page 5-12).)

To define an individual IP address, type **0.0.0.0** and press **Enter**.

There is no default for this parameter.

Enter wildcard bits:

Step 7 The maximum number of entries in an ACL is 20.

If the “any” option was used, no other IP addresses may be added to the list.

- To add more entries, type **y** and press **Enter**

Would you like to add another entry to this list? [no]:**y**

Enter up to 20 entries as described in step 5 and step 6.

- When all entries have been added, press **Enter**

Would you like to add another entry to this list? [no]:

Step 8 When all entries are added to one list, you are asked whether you would like to create another ACL. You may define up to 99 ACLs.

- To create another ACL, type **y** and press **Enter**

Would you like to configure another list? [no]: **y**

Enter up to 20 IP addresses in this new ACL, as described in step 5 and step 6.

- When all ACLs have been created, press **Enter**.

Would you like to configure another list? [no]:

You are now prompted to assign the desired ACLs to restrict IP and Telnet access.

Step 9 Restrict IP access to the *SCE 2000* by assigning the appropriate ACL.

Type the number of the ACL to be assigned to IP access and press **Enter**.

To accept the default ACL, press **Enter**.

Enter IP access-class [0]:

Step 10 Restrict Telnet access to the *SCE 2000* by assigning the appropriate ACL.

Type the number of the ACL to be assigned to the Telnet interface and press **Enter**.

To accept the default ACL, press **Enter**.

Enter Telnet access-class [0]: **2**

EXAMPLE:

This example illustrates a common access control scenario. Let us assume the following:

- We want to permit every station to access the SCE on the management port (e.g. ping, SNMP polling etc.).
- We want to restrict Telnet access to only a few permitted stations.

We therefore need to create two access control lists:

- For general IP access — permit access to all IP addresses.
- For Telnet — permit access to the specified IP address, and deny to all others.

ACL #1 = permit any IP address. Assign to IP access.

ACL #2 = permit access to 10.1.1.0, 10.10.10.1, deny to all others. Assign to Telnet access.

```

Would you like to enter the Access lists configuration menu? [no]: y
Would you like to create new Access lists or modify existing lists? [no]: y
Enter ACL number: 1
Does this entry permit access? [yes]:
Enter IP address or the word 'any' to denote any IP address: any
This entry matches every IP address, no use in adding more entries to this
list.
Would you like to configure another list? [no]: y
Enter ACL number: 2
Does this entry permit access? [yes]:
Enter IP address or the word 'any' to denote any IP address: 10.1.1.0
Enter wildcard bits: 0.0.0.0
Would you like to add another entry to this list? [no]:y
Does this entry permit access? [yes]:
Enter IP address or the word 'any' to denote any IP address: 10.10.10.1
Enter wildcard bits: 0.0.0.0
Would you like to add another entry to this list? [no]:y
Does this entry permit access? [yes]:n
Enter IP address or the word 'any' to denote any IP address: any
This entry matches every IP address, no use in adding more entries to this
list.
Would you like to configure another list? [no]:
Enter IP access-class [0]: 1
Enter Telnet access-class [0]: 2

```

EXAMPLE 2:

This example skips the first section of the dialog (creating/modifying), and proceeds directly to assign existing ACLs.

```

Would you like to enter the Access lists configuration menu? [no]: y
Would you like to create new Access lists or modify existing lists? [no]:
Enter IP access-class [0]: 10
Enter Telnet access-class [0]: 22

```

Step 8: Configuring SNMP

Managing the *SCE 2000* is possible also via a Network Management System (NMS) that supports SNMP. By default, SNMP is disabled on the *SCE 2000*.

To enable SNMP management you must configure the following basic SNMP parameters:

- SNMP traps status and managers.
- Community strings (where an SNMP community string is a text string that acts like a password to permit access to the SNMP agent on the *SCE 2000*).

To configure SNMP parameters, complete the following steps:

Step 1 Enter the SNMP configuration menu.

Would you like to enter the SNMP configuration menu? [no]: **y**

Type **y** and press **Enter**.

The SNMP configuration dialog begins.

Step 2 Enable SNMP management.

Type **y** and press **Enter**.

Enable SNMP management? [no]: **y**

If you choose to disable SNMP management, skip the rest of this section and go to Step 9: Configuring the Topology-Dependent Parameters. The rest of the dialog is not presented, as it is irrelevant when SNMP management is disabled.

Step 3 Type the SNMP GET community name and press **Enter**.

The SNMP agent that resides inside the *SCE 2000* will respond only to GET requests that use this community string.

Enter SNMP GET community name:

Note that there is no default for this parameter.

Step 4 Assign an access list to restrict the SNMP management stations that may use this GET community.

Type a number (1 through 99) or type "0" to permit access to all IP addresses, and press **Enter**.

Enter Access list number allowing access with this community string, use '0' to allow all:

Step 5 The maximum number of GET communities is 20.

- To add more entries, type **y** and press **Enter**
- Would you like to add another SNMP GET community? [no]:**y**

Enter up to 20 SNMP GET communities as described in step 3 and step 4.

- When all entries have been added, press **Enter**
- Would you like to add another SNMP GET community? [no]:

Step 6 Type the SNMP SET community name and press **Enter**.

The SNMP agent that resides inside the *SCE 2000* will respond only to SET requests that use this community string.

Enter SNMP SET community name:

Note that there is no default for this parameter.

Step 7 Assign an access list to restrict the SNMP management stations that may use this SET community.

Type a number (1 through 99) or type "0" to permit access to all IP addresses, and press **Enter**.

Enter Access list number allowing access with this community string, use '0' to allow all:

Step 8 The maximum number of SET communities is 20.

- To add more entries, type **y** and press **Enter**

Would you like to add another SNMP SET community? [no]:**y**

Enter up to 20 SNMP SET communities as described in step 6 and step 7.

- When all entries have been added, press **Enter**

Would you like to add another SNMP SET community? [no]:

Step 9 Enter the SNMP trap managers menu.

Would you like to configure SNMP trap managers? [no]: **y**

Type **y** and press **Enter**.

The SNMP trap managers dialog begins.

If you choose not to configure SNMP trap managers, the dialog skips to the authentication failure trap status. (See step 14.)

Step 10 Type the trap manager IP address and press **Enter**.

Enter SNMP trap manager IP address:

Note that there is no default for this parameter.

Step 11 Type the trap manager community string and press **Enter**.

Note that there is no default for this parameter.

Enter SNMP trap manager community string:

Step 12 Type the number of the trap manager SNMP version (1 or 2c) and press **Enter**

Note that there is no default for this parameter.

Enter trap manager SNMP version:

Step 13 The maximum number of trap managers is 20.

- To add more entries, type **y** and press **Enter**

Would you like to add another SNMP trap manager? [no]:**y**

Enter up to 20 trap managers as described in step 10 through step 12.

- When all entries have been added, press **Enter**

Would you like to add another SNMP trap manager? [no]:

Step 14 Configure the Authentication Failure trap status.

- To disable the Authentication Failure trap, press **Enter**.
- To enable the Authentication Failure trap, type **y** and press **Enter**.

Enable the 'Authentication Failure' trap [no]:

Step 15 Configure the SCE enterprise trap status.

- To disable the SCE enterprise traps, type **n** press **Enter**.

- To enable the SCE enterprise traps, type **y** and press **Enter**.
Enable the SCE enterprise traps []:

Step 16 Type the name of the system administrator and press **Enter**.

Note that there is no default for this parameter.

Enter system administrator contact name []:

EXAMPLE:

Following is a sample SNMP configuration, configuring one trap manager, one GET community, and one SET community, and enabling the authentication failure trap, as well as all enterprise traps.

```
Would you like to enter the SNMP configuration menu? [no]: y
Enable SNMP management? [no]: y
Enter SNMP GET community name[]: public
Enter Access list number allowing access with this community string, use '0'
to allow all: 0
Would you like to add another SNMP GET community? [no]:
Enter SNMP SET community name[]: private
Enter Access list number allowing access with this community string, use '0'
to allow all: 2
Would you like to add another SNMP SET community? [no]:
Would you like to configure SNMP trap managers? [no]: y
Enter SNMP trap manager IP address: 10.1.1.253
Enter SNMP trap manager community string: public
Enter trap manager SNMP version: 2c
Would you like to add another SNMP trap manager? [no]:
Enable the 'Authentication Failure' trap [no]: y
Enable SCE enterprise traps []: y
Enter system administrator contact name []: John Smith
```

Step 9: Configuring the Topology-Dependent Parameters

The topology configuration menu is a series of guided questions relating to the deployment of the *SCE 2000* in the network and its mode of operation. Values for the parameters are configured based on the user answers.

The correct value for each parameter must be ascertained before configuring the system to make sure that the system will function in the desired manner. (See [Topology](#) (on page 3-1) for a comprehensive discussion of topology and the related parameters.)



Note

Values may not be requested for all topology-dependent parameters, as certain parameters do not apply to all topologies.

There are six topology-related parameters:

- **Connection mode** — Can be either of the following, depending on the physical installation of the *SCE 2000*.
 - Inline
 - Receive-only

- **Type of deployment** — Can be one of the following, depending on the actual deployment:
 - Single-SCE Platform — a single *SCE 2000* is deployed on one or two Console links
 - Cascade — two cascaded *SCE 2000*s are deployed on two Console links, working as a fully redundant solution.
- **Physically connected link (cascade topology only)** — In a cascade topology, the user must assign an index to each of the links. This index is used to identify the services per link.

In a single-SCE Platform deployment, the indices of the links cannot be changed by the user and are:

- link-0 — the link connected to ports 1 and 2
- link-1 — the link connected to ports 3 and 4

In a cascade deployment, the user must define which link is connected to which *SCE 2000*. The index must be different for each *SCE 2000*. In this case the user can choose one of the following:

- Link-0 — the link connected to this *SCE 2000* is identified as 0.
- Link-1 — the link connected to this *SCE 2000* is identified as 1.
- **Priority (cascade topology only)** — In a cascade topology, this parameter determines which *SCE 2000* is chosen as the active *SCE 2000* in the “active election” procedure. This decision is taken only when both *SCE 2000*s are starting up together. If there is one working *SCE 2000* and the other is just starting up, then the working one will automatically be chosen as active and the other one as standby. This parameter can be set to one of the following:
 - Primary
 - Secondary
- **On-Failure behavior** — Determines the behavior of the *SCE 2000* upon failure, or reboot. One of the following link modes may be chosen for the *SCE 2000* in the cases of failure or reboot.:
 - Bypass — traffic is bypassed using the internal bypass card.
 - Cutoff — the link is forced down.
- **Admin status after abnormal reboot** — This parameter determines whether the *SCE 2000* returns to full operational mode after abnormal (not user-requested) boot, or stays in non-operational mode, in which the *SCE 2000* behaves as in failure mode. This parameter can be set to one of the following:
 - Operational
 - Non-operational

The procedure described below is a presentation of all the questions in the topology configuration. In actual practice, all questions may not be presented for a particular configuration, depending on the topology deployed.

Study the examples that follow to understand the procedure for various topologies.

To configure topology dependent parameters, complete the following steps:

Step 1 Enter the topology configuration menu.

```
Would you like to enter the Topology configuration menu? [no]: y
```

Type **y** and press **Enter**.

The topology configuration dialog begins.

Step 2 Specify the connection mode.

- To define **inline** connection mode, press **Enter**.
- To define **receive-only** connection mode, type **2** and press **Enter**.

```
Enter Connection mode:
1- inline
2- receive-only
Enter your choice [1]:
```

Step 3 Specify the deployment type.

- To specify a **Single-SCE Platform** deployment, press **Enter**.
- To specify a **Cascade** deployment, type **y** and press **Enter**.

```
Is this a cascade deployment? [no]:
```

Step 4 Specify the physically-connected-link index.

- To specify **link-0**, press **Enter**.
- To specify link-1, type **1** and press **Enter**.

```
Enter Physically connected link:
0- link-0
1- link-1
Enter your choice [0]:
```

Step 5 Specify the **SCE 2000** priority.

- To specify **Primary**, press **Enter**.
- To specify **Secondary**, type **2** and press **Enter**.

```
Enter SCE 2000 priority:
1- primary
2- secondary
Enter your choice [1]:
```

Step 6 Specify the On-failure link behavior.

- To specify **Bypass**, press **Enter**.
- To specify **Cutoff**, type **2** and press **Enter**.

```
Enter On-failure behavior:
1- bypass
2- cutoff
Enter your choice [1]:
```

Step 7 Specify the status of the **SCE 2000** after abnormal boot.

- To specify **Operational** status after abnormal boot, press **Enter**.
- To specify **Not-Operational** status after abnormal boot, type **2** and press **Enter**.

```
Enter admin status of the SCE after abnormal boot:
1- Operational
2- Not-Operational
Enter your choice [1]:
```

The following examples present the procedure for configuring the topology-related parameters for various topologies.

EXAMPLE #1:

Following is a sample topology configuration for a non-redundant topology using an optical splitter, that is, a single *SCE 2000* connected in receive-only connection mode, to one or two GBE links

```
Would you like to enter the Topology configuration menu? [no]: y
Would you like to enter the Topology configuration menu? [no]: y
Enter Connection mode:
1- inline
2- receive-only
Enter your choice [1]: 2
Is this a cascade deployment? [no]: no
Enter admin status of the SCE after abnormal boot:
1- Operational
2- Not-Operational
Enter your choice [1]: 1
```

Data collection for the system configuration is completed.

All other parameter values are automatically assigned by the system.

EXAMPLE #2:

Following is a sample topology configuration for a non-redundant inline topology. In this topology, a single *SCE 2000* is connected to one or two GBE links.

When the inline connection mode is specified, the user must specify the on-failure link behavior.

```
Would you like to enter the Topology configuration menu? [no]: y
Enter Connection mode:
1- inline
2- receive-only
Enter your choice [1]: 1
Is this a cascade deployment? [no]: no
Enter On-failure behavior:
1- bypass
2- cutoff
Enter your choice [1]: 1
Enter admin status of the SCE after abnormal boot:
1- Operational
2- Not-Operational
Enter your choice [1]: 1
```

Data collection for the system configuration is completed.

EXAMPLE #3:

Following is a sample topology configuration for a secondary *SCE 2000* in a redundant inline topology. In this topology there are two *SCE 2000*s that are cascaded via the cascade GBE ports (ports 3 and 4). Each *SCE 2000* is connected inline to both sides (subscribers/network) of one GBE link.

In this case, the user must specify the physically-connected-link index (link-0 in our example), the priority of the *SCE 2000*, and the on-failure link behavior.

```
Would you like to enter the Topology configuration menu? [no]: y
Enter Connection mode:
1- inline
2- receive-only
Enter your choice [1]: 1
Is this a cascade deployment ? [no]: yes
Enter Physically connected link:
0- link-0
1- link-1
Enter your choice [0]: 0
Enter SCE 2000 priority:
1- primary
2- secondary
Enter your choice [1]: 2
Enter On-failure behavior:
1- bypass
2- cutoff
Enter your choice [1]: 1
Enter admin status of the SCE after abnormal boot:
1- Operational
2- Not-Operational
Enter your choice [1]: 1
```

Data collection for the system configuration is completed.

Step 10: Completing and Saving the Configuration

When you have completed the entire configuration, the system checks for errors. If errors are found, a warning message appears. When the configuration is error-free, you may apply and save it.

To complete and save the configuration, complete the following steps:

Step 1 The system informs you that data collection is complete.

It is recommended that you view the entire new configuration before it is applied.

Type **y** and press **Enter**.

Note that there is no default.

If there are no errors, go to step 3.

```
Data collection for the system configuration is completed.
```

```
Would you like to view the new configuration before it is applied? [yes/no]:
y
```

Step 2 If any errors are detected, you may choose to view them.

Press **Enter**.

```
Found errors in the new configuration, would you like to view them? [yes]:
```

```
The following errors were found:
Warning - RDR formatter destination 10.1.1.1 is not allowed in the IP
access-class.
```

Step 3 You are asked whether to apply and save the configuration.

```
Apply and Save this configuration? [yes/no]:
```

- To apply and save the configuration, type **y** and press **Enter**.
- To abort the setup procedure without applying or saving the configuration (recommended if there are errors), type **n** and press **Enter**.

```
Setup procedure aborted, no configuration changes made.
```

If the setup is aborted, the dialog is ended.

Step 4 If there are no errors, the system requests confirmation of either a yes or no answer, in order to prevent mistakes.

Type the appropriate answer (y or n) and press **Enter**.

```
The running configuration would be overwritten by the changes you have just
entered, are you sure? [yes/no]:
```

The selected action is carried out by the system.

- If the apply and save action is not confirmed (**no**), the setup is aborted.
Setup procedure aborted, no configuration changes made.
- If the apply and save action is confirmed (**yes**), the configuration is applied and saved.
The new running configuration will be saved to the startup configuration.

Step 5 If the configuration was applied and saved, you may also save it to a file at a remote station.

```
Do you want to save a copy of the startup configuration file in a remote
station? [no]:
```

To save the configuration to a remote station, type **y** and press **Enter**.

The system will ask for FTP path:

```
Enter a full FTP path of the remote destination:
```

Step 6 The system informs you that the configuration is complete.

```
Committing configuration...
```

```
Configuration completed successfully.
```

```
Saving configuration...
```

```
Writing general configuration file to temporary location...
```

```
Backing-up general configuration file...
```

```
Copy temporary file to final location...
```

```
Done!
```

This completes the procedures for initial configuration of the *SCE 2000* platform.

EXAMPLE #1:

Following is an example of a configuration that the user aborted due to errors detected in the configuration.

Note that no confirmation is requested for the decision to abort the setup. Had there been no errors, confirmation would have been requested before aborting.

```
Data collection for the system configuration is completed.
```

```

Would you like to view the new configuration before it is applied? [yes/no]:
n
Found errors in the new configuration, would you like to view them? [yes]: y
The following errors were found:
Warning - RDR formatter destination 10.1.1.1 is not allowed in the IP
access-class.
Warning - default Gateway 10.1.1.1 is not allowed in the IP access-class.
Warning - IP Access list (1) conflicts with Telnet Access list (2) as
follows:
Access list 2 permits all addresses while Access list 1 denies it.
Apply and Save this configuration? [yes/no]: n

```

Setup procedure aborted, no configuration changes made.

EXAMPLE #2:

Following is an example of a configuration that was applied and saved to the startup configuration as well as to an FTP site.

Although not demonstrated in this example, it is recommended that you always view the configuration before applying it.

```

Data collection for the system configuration is completed.
Would you like to view the new configuration before it is applied? [yes/no]:
Apply and Save this configuration? [yes/no]: y

```

(New configuration would be displayed here)

```

The running configuration would be overwritten by the changes you have just
entered, are you sure? [yes/no]:y

```

```

The new running configuration will be saved to the startup configuration.
Do you want to save a copy of the startup configuration file in a remote
station? [no]:y
Enter a full FTP path of the remote destination:
ftp://vk:vk@10.1.1.253/h:/copyofstartup.txt
Committing configuration...

```

Configuration completed successfully.

```

Saving configuration...
Writing general configuration file to temporary location...
Backing-up general configuration file...
Copy temporary file to final location...

```

Done!

EXAMPLE #3:

Following is an example of a configuration that was aborted, although no errors were detected.

```

Data collection for the system configuration is completed.
Would you like to view the new configuration before it is applied? [yes/no]:
Apply and Save this configuration? [yes/no]: n
The changes you have just entered would be discarded, are you sure?
[yes/no]:y

```

Setup procedure aborted, no configuration changes made.

Connecting the Management Interface

The SCE platform is equipped with two RJ-45 management (MNG) ports. These ports provide access from a remote management console to the SCE platform via a LAN. The two management ports provide the possibility for a redundant management interface, thus ensuring management access to the SCE platform even if there is a failure in one of the management links.

If only one management port is used, the desired port is simply connected directly to the LAN. If both management ports are used, they must both be connected to the management console via a switch. In this way, the IP address of the MNG port is always the same, regardless of which physical port is currently active.

The procedures for cabling the management port and testing connectivity between the *SCE 2000* and the remote management host are explained in the following sections:

- [Cabling the Management Port](#) (on page 5-25)
- [Verifying Management Interface Connectivity](#) (on page 5-26)

Cabling the Management Port

The *SCE 2000* has two management ports, labeled Mng1 and Mng 2.

To cable the management port, complete the following steps:

-
- Step 1** Take the Ethernet cable provided (with attached RJ-45 connector) and plug it into the desired MNG port on the front panel of the *SCE 2000*, as shown in the following figure.

Figure 5-2: Cabling the Management Port



- Step 2** Connect the other end of the Ethernet cable into your management network.
- If only one management port is used — connect the port directly to the LAN.
 - If both management ports are used — connect both ports to the LAN via a switch.

Make sure that you push on the RJ-45 connector attached to the cable until you hear a click, which indicates that the connector is fully inserted and secured in the receptacle. Gently pull on the plug to confirm whether the plug is locked into the socket.

If the Link LED on the *SCE 2000* management port does not light, try removing the cable and reinserting it firmly into the module socket. To disconnect the plug from the socket, press down on the raised portion on top of the plug, releasing the latch. You should hear an audible click indicating the latch has released. Carefully pull the plug out of the socket.

If the management port Link LED on the *SCE 2000* still does not light, verify that the cable is

connected correctly to the appropriate network element on its second end.

Verifying Management Interface Connectivity

If the *SCE 2000* platform has been powered up, test now to verify that connectivity has been established between the *SCE 2000* and the remote management host. If the *SCE 2000* platform is not powered up, perform this step after starting the *SCE 2000* platform.

To verify that connectivity has been established between the *SCE 2000* and the remote management host, complete the following steps:

- Step 1** After you connect the cable to the appropriate Mng port and to your network, check the relevant Mng port LEDs.

There are two Mng LEDs — Link/Active, and 10/100/1000 (refer to Front Panel).

At this point, check that the Link/Active LED is green.

The state of the 10/100/1000 LED will depend on the Ethernet network settings.

Green indicates 100 Mbps and ‘Off’ indicates 10 Mbps.

- Step 2** Test connectivity. From the host that you intend to use for remote management, ping to the *SCE 2000* by typing **ping** and the *SCE 2000* IP address, and pressing **Enter** (see the example, below).



- Note** Please note that only step 2 above, is performed from the remote management host (Mng port connection).

This verifies that an active connection exists between the specified station and the management port.

The ping program sends an echo request packet to an IP address and then awaits a reply. Ping output can help you evaluate path-to-host reliability, delays over the path, and whether the host can be reached or is functioning.

This completes the procedures for connecting the management interfaces and for initial configuration of the *SCE 2000* platform. Proceed to the next chapter for a description of the procedures for cabling the Gigabit Ethernet ports and for configuring Gigabit Ethernet (GBE) interface parameters.

EXAMPLE:

The following example displays a typical ping response where the target IP address is 10.1.1.201.

```
C:\>ping 10.1.1.201
pinging 10.1.1.201 ...
PING 10.1.1.201: 56 data bytes
64 bytes from host (10.1.1.201): icmp_seq=0. time=0. ms
64 bytes from host (10.1.1.201): icmp_seq=1. time=0. ms
64 bytes from host (10.1.1.201): icmp_seq=2. time=0. ms
```

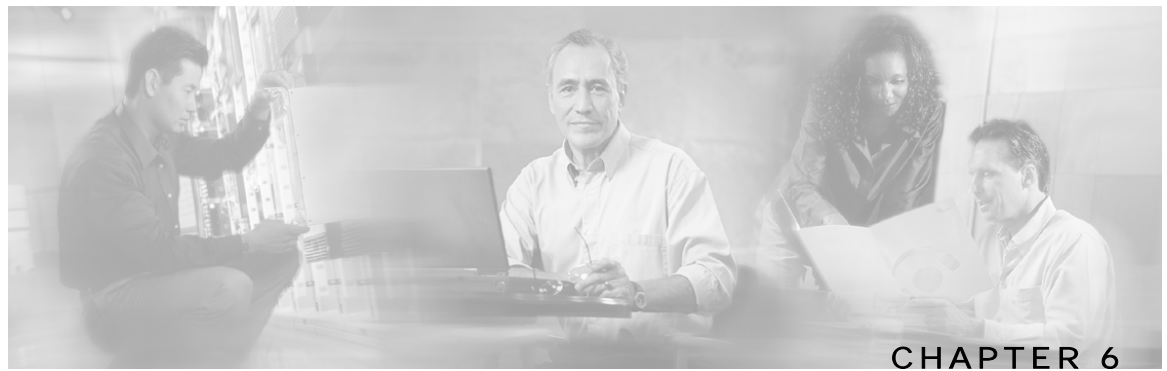

```
64 bytes from host (10.1.1.201): icmp_seq=3. time=0. ms
----10.1.1.201 PING Statistics----
4 packets transmitted, 4 packets received, 0% packet loss
round-trip (ms) min/avg/max = 0/0/0
```

Cabling the Line Ports and Completing the Installation

This chapter provides instructions for cabling the Gigabit Ethernet ports for both one and two *SCE 2000* topologies, and for configuring Gigabit Ethernet (GBE) interface parameters. In a topology utilizing two *SCE 2000*s (cascade), this includes the cascade ports as well as the line ports.

**Note**

When installing a cascaded system, it is extremely important to follow the sequence of procedures outlined in the section [Installing a Cascaded System](#) (on page 6-10).

**Note**

When installing an External Optical Bypass module, the *SCE 2000* line ports are connected to the module. See [Cabling the External Optical Bypass Module](#) (on page A-4) for complete instructions.

This chapter contains the following sections:

- [Connecting the line ports to the network](#) 6-1
- [Installing a Cascaded System](#) 6-10
- [Loading and Activating a Service Control Application](#) 6-14

Connecting the line ports to the network

The procedures for cabling the line ports, configuring the interface parameters, and testing connectivity of the links are explained in the following sections:

- [Cabling Diagrams](#) (on page 6-2)
- [Configuring the GBE Interface Parameters](#) (on page 6-6)
- [Connecting the GBE Line Interface Ports](#) (on page 6-7)

- [Testing Connectivity: Examining Link LEDs, GBE Counters](#) ("Testing Connectivity: Examining Link LEDs and Counters" on page 6-9)

Cabling Diagrams

Before beginning, find the appropriate cabling diagram for the topology in your installation:

- Single *SCE 2000* topologies
 - [Single Link: Inline Topology](#) (on page 6-2)
 - [Single Link: Receive-only Topology](#) (on page 6-3)
 - [Dual Link: Single SCE 2000 Topologies](#) (on page 6-3)
- Dual *SCE 2000* topologies (cascaded)
 - [Dual Link: Two SCE 2000s Topology](#) (on page 6-5)



Note

When installing a cascaded system, it is extremely important to follow the sequence of procedures outlined in the section [Installing a Cascaded System](#) (on page 6-10).

Single Link: Inline Topology

In the inline topology, the *SCE 2000* resides physically on the GBE (Gigabit Ethernet) link between the subscribers, which are usually connected through either a BRAS (in DSL access), a PDSN (in wireless access), a CMTS (in the Cable access), or a switch or router aggregator (in other topologies), and the network, where the *SCE 2000* usually connects to a router or layer 3 switch network element.

Figure 6-1: Cabling Diagram for Single Link Inline Topology

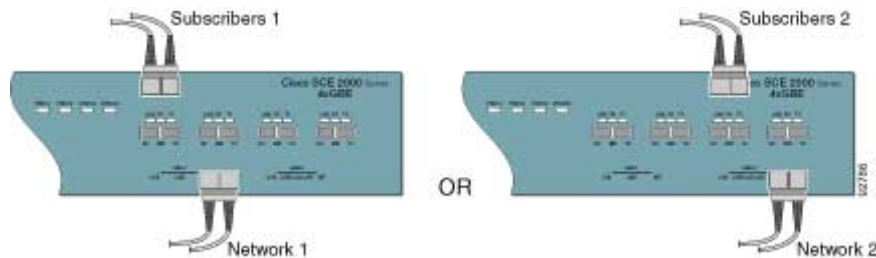

In the single link inline topology, either the first GBE link (first two ports) of the *SCE 2000* or the second GBE link (third and fourth ports) can be used, as illustrated in the diagram above. The remaining pair of ports is unused.

Either port 1 or port 3 is used for connecting to the network element that is deployed on the subscriber side of the *SCE 2000* while port 2 or port 4 is used for connecting to the network element that is deployed on the network side of the *SCE 2000*.

Inline topology requires both Receive and Transmit fibers

Single Link: Receive-only Topology

In this topology, an optical splitter resides physically on the GBE link that the *SCE 2000* should monitor. The optical splitter is connected to the *SCE 2000* via Rx links only.

In this topology, the traffic passes through the optical splitter, which splits traffic to the *SCE 2000*.



Note

Receive-only topologies can also be implemented using a switch. Such a switch must support SPAN functionality that includes separation between ingress and egress traffic and multiple SPAN-ports destinations.

Figure 6-2: Cabling Diagram for Single SCE 2000 Single Link Receive-only Topology

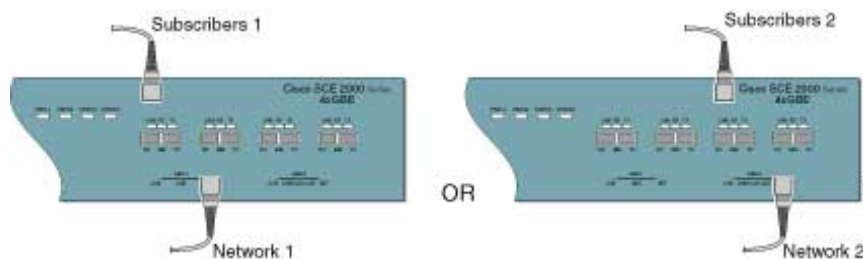

The single link receive-only topology cabling is similar to that for single link inline, in that either the first GBE link (first two ports) or the second GBE link (third and fourth ports) can be used, as illustrated in the diagram above. The remaining pair of ports is unused.

Either port 1 or port 3 is used for connecting to the network element that is deployed on the subscriber side of the *SCE 2000* while port 2 or port 4 is used for connecting to the network element that is deployed on the network side of the *SCE 2000*.

Dual Link: Single SCE 2000 Topologies

In this topology, one *SCE 2000* is connected to two full duplex, GBE links. The *SCE 2000* may be either inline, to support both monitoring and traffic control functionality, or receive-only for traffic monitoring functionality only.

When one *SCE 2000* supports two links, the first two ports are connected to one link, while ports 3 and 4 are connected to the second link as follows;

- Port 1: Link 1, Subscriber side
- Port 2: Link 1, Network side
- Port 3: Link 2, Subscriber side
- Port 4: Link 2, Network side

Connecting the line ports to the network

As with the single link cabling, inline topologies require both Receive and Transmit fibers, while Receive-only systems use only Receive fibers.

**Note**

Receive-only topologies can be implemented using either an optical splitter or a switch. If a switch is used, it must support SPAN functionality that includes separation between ingress and egress traffic and multiple SPAN-ports destinations.

The following two diagrams illustrate the connections for dual links, with a single *SCE 2000* deployed for both inline and receive-only topologies.

Figure 6-3: Cabling Diagram: Dual Link One SCE 2000 Inline

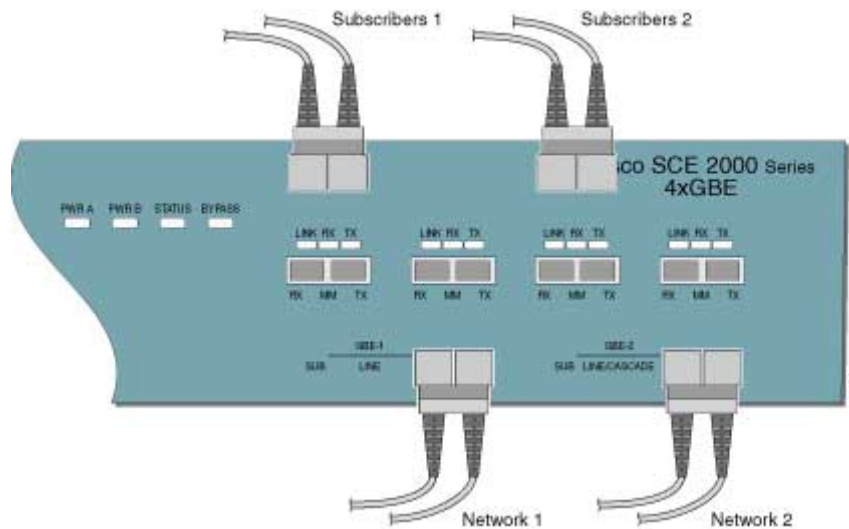
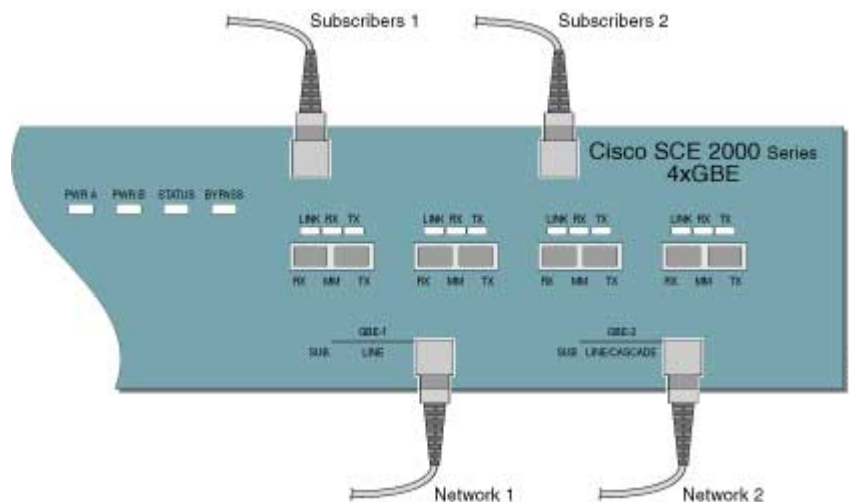

Figure 6-4: Cabling Diagram: Dual Link One SCE 2000 Receive-only



Dual Link: Two SCE 2000s Topology

In this topology, two *SCE 2000s* are connected to two full duplex, GBE links, providing full redundancy through cascading the two *SCE 2000s*. The *SCE 2000s* may be either inline, to support both monitoring and traffic control functionality, or receive-only for traffic monitoring functionality only.



Note When installing a cascaded system, it is extremely important to follow the sequence of procedures outlined in the section [Installing a Cascaded System](#) (on page 6-10).



Note Receive-only topologies can be implemented using either an optical splitter or a switch. If a switch is used, it must support SPAN functionality that includes separation between ingress and egress traffic and multiple SPAN-ports destinations.

When two *SCE 2000s* are used, the first two ports in each *SCE 2000* are connected to the links, while ports 3 and 4 are the cascade ports that are used for communicating between the two *SCE 2000s* as follows:

SCE 2000#1

- Port 1: Link 1, Subscribers side
- Port 2: Link 1, Network side
- Port 3: Cascade, connect to Port 4 in *SCE 2000 #2*
- Port 4: Cascade, connect to Port 3 in *SCE 2000 #2*

SCE 2000#2

- Port 1: Link 2, Subscribers side
- Port 2: Link 2, Network side
- Port 3: Cascade, connect to Port 4 in *SCE 2000 #1*
- Port 4: Cascade, connect to Port 3 in *SCE 2000 #1*

Connecting the line ports to the network

Inline topologies require connecting both Receive and Transmit fibers to the *SCE 2000*. Cascade ports always require both Receive and Transmit fibers to be connected.

The following diagram illustrates the connections for a dual link, two *SCE 2000* inline topology

Figure 6-5: Cabling Diagram: Dual Link Inline Topology Two Cascaded SCE 2000s

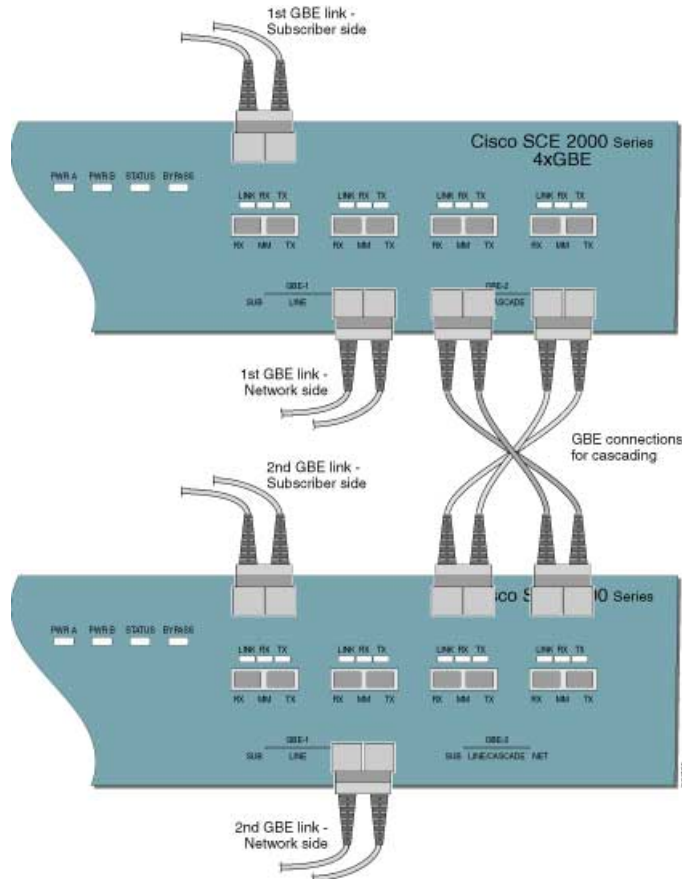

Configuring the GBE Interface Parameters

By default, the *SCE 2000* GBE line interface ports are configured with auto-negotiation disabled. The procedure for enabling auto-negotiation for the GBE line interface ports is explained in the following section.



Note Auto-negotiation must be disabled when the *SCE 2000* is deployed via an external optical splitter (receive-only topology)



Note If you change any parameters, you must save the new configuration settings. Type **copy running-config startup-config**, and press **Enter**

Configuring the Gigabit Ethernet Line Interfaces

To configure GBE auto-negotiation for a specified GBE line interface, complete the following steps:

-
- Step 1** To enter the Global Configuration Mode, at the *SCE 2000*# prompt, type **configure**, and press **Enter**.
The *SCE 2000*(config)# prompt appears.
- Step 2** To enter the desired GBE port interface, type **interface GigabitEthernet 0/***portnumber*, and press **Enter**, where *portnumber* is the number of the selected port (1-4).
The *SCE 2000*(config if)# prompt appears.
- Step 3** Type **auto-negotiate** and press **Enter**.
The *SCE 2000*(config if)# prompt appears.
- Step 4** To return to Global Configuration Mode, type **exit** and press **Enter**.
The *SCE 2000*(config)# prompt appears.
- Repeat this procedure to configure auto-negotiation for the other GBE port interfaces as needed.
-

Connecting the GBE Line Interface Ports

The following sections present the general procedure for cabling the GBE interface ports. Refer to [Cabling Diagrams](#) (on page 6-2) to find the appropriate cabling diagram for the topology of your system for the specific connections required.



Note When installing an External Optical Bypass module, the *SCE 2000* line ports are connected to the module. See [Cabling the External Optical Bypass Module](#) (on page A-4) for complete instructions.

Fiber Specifications

The following table presents the fiber specifications. The *SCE 2000* may be ordered with either Multimode or Single Mode transceivers. The transceiver type is indicated on the front panel under the ports. Note that both transceivers on any individual *SCE 2000* are the same, either 850nm Multimode OR 1310nm Single Mode.

Table 6-1 Fiber Specifications

SCE Model	Transceiver	Transmit Power	Receive Power	Typical (Max.) Distance
SCE 2000 4xGBE MM	850nm Multimode	-9.5 to -4 dBm	-17 to 0 dBm	<ul style="list-style-type: none"> • 750m for 50µm Core Diameter MMF • 400m for 62.5µm Core Diameter MMF
SCE 2000 4xGBE SM	1310nm FRP laser Single Mode	-9.5 to -3 dBm	-20 to 3 dBm	10 km for 9.0µm Core Diameter SMF

Cabling the GBE Port



Warning

Class 1 laser. Avoid exposure to radiation and do not stare into open aperture.

To cable the *SCE 2000* GBE line port, complete the following steps:

- Step 1** Take the appropriate fiber optic cable (see [Fiber Specifications](#) (on page 6-7)) and plug it into the appropriate GBE port on the front panel of the *SCE 2000*.

Make sure to push on the connector until you hear a click, which indicates that the connector is fully inserted and secured in the receptacle. Always make sure that you insert the connector completely into the socket.

Figure 6-6: Cabling the GBE Interface



- Step 2** Verify that the link LED is green.

If the link LED does not light, try removing the network cable plug and reinserting it firmly into the module socket.

Testing Connectivity: Examining Link LEDs and Counters

If the *SCE 2000* platform has been powered up, test now to verify that connectivity has been established on all links. If the *SCE 2000* platform is not powered up, perform this step after starting the *SCE 2000* platform.

Examining the LEDs

The GBE Link LED must be green in order to verify that an active connection exists.

The GBE Rx and Tx LEDs (if flashing green) indicate that traffic is being received or transmitted by the *SCE 2000* platform, respectively.

Note that in an inline topology, the Rx and Tx LEDs indicate that packets are being received/transmitted by the *SCE 2000* platform.

In optical splitter topologies, the Rx LEDs are the sole indicators. The Tx LEDs do not “blink”, since the Tx is not connected to the port in this topology.

Viewing the Counters to Verify that the Network Traffic is Reaching the Device

In an inline topology, you can monitor traffic via the platform counters for both the Rx and Tx connections. The counters increase, together with the increased number of packets that flow through the *SCE 2000* for both Rx and Tx.

However, in external switch topologies, the counters for the Tx do not increment, that is, Tx does not have a function in monitoring traffic, as it is disconnected.

To view the Gigabit Ethernet port status, complete the following steps:

Step 1 At the *SCE 2000#* prompt, type **show interface GigabitEthernet 0/interface-number**.

This displays the port link and auto-negotiation status.

EXAMPLE:

The following example displays a system response.

```
SCE 2000#show interface GigabitEthernet 0/1
Auto negotiation configured: Enabled
Actual Status:
Link is on
Auto negotiation: Enabled
Bandwidth: 100000Kbps
Burst-size: 50000bytes
```

Again, auto-negotiation for bump-in-the-wire topology may be enabled or disabled. For receive-only topologies, using an external splitter, auto-negotiation must be disabled.

To view the Gigabit Ethernet counters, complete the following steps:

-
- Step 1** At the *SCE 2000*# prompt, type **show interface GigabitEthernet 0/interface-number counters**.

This displays the GigabitEthernet counters. This command enables you to verify that traffic is taking place. You can see that the counters increase, together with the increased number of packets that flow through the *SCE 2000*.

Again, in bump-in-the-wire topology, both the Rx and Tx counters apply as traffic monitors. For receive-only topologies, using an external splitter, only the Rx counters apply.

EXAMPLE:

The following example shows the counters of the first Gigabit Ethernet interface.

```
SCE 2000#show interface GigabitEthernet 0/1 counters
In total octets: 100
In good unicast packets: 90
In good multicast packets: 0
In good broadcast packets: 10
In packets discarded: 0
In packets with CRC/Alignment error: 0
In undersized packets: 0
In oversized packets: 0
Out total octets: 93*2^32+1022342538
Out unicast packets: 858086051
Out non unicast packets: 0
Out packets discarded: 0
```

You are now ready to continue to the next stage, loading and activating an SCE application.

Installing a Cascaded System

This section outlines the installation procedures for a redundant solution with two cascaded *SCE 2000* platforms. Refer to the *Cisco Service Control Engine (SCE) CLI Command Reference* for details of the CLI commands.



Warning

When working with two *SCE 2000* platforms with split-flow and redundancy, it is extremely important to follow this installation procedure.

To install a cascaded system, complete the following steps:

- Step 1** Install both *SCE 2000* platforms, power them up, and perform the initial system configuration. (See [Installation and Maintenance](#) (on page 4-1) and [Connecting the Management Interfaces and Performing Initial System Configuration](#) (on page 5-1).)

- Step 2** Connect both *SCE 2000* platforms to the management station. (See *Connecting the Management Interface* (on page 5-25).)
- Step 3** Connect the cascade ports. (See *Dual Link: Two SCE 2000s Topology* (on page 6-5).)
- Step 4** Set topology configurations for each *SCE 2000* platform via the connection-mode options. (See *Topology-Related Parameters for Redundant Topologies* (on page 6-11).)
- Step 5** Make sure that the *SCE 2000* platforms have synchronized and active *SCE 2000* platform was selected.
- Use the **show interface linecard 0 connection-mode** command.
- Step 6** If you want to start with bypass/sniffing, change the link mode to your required mode in both *SCE 2000* platforms on both links. The bypass mode will be applied only to the active *SCE 2000* platform. (See *Link Mode* (on page 6-13).)
- Step 7** Make sure that the link mode is as you required. (See *Monitoring the System* (on page 6-14).)
- Use the **show interface linecard 0 link mode** command.
- Step 8** Connect the traffic port of *SCE 2000* platform #1. This will cause a momentary down time until the network elements from both sides of the *SCE 2000* platform auto-negotiate with it and start working (when working inline). (See *Dual Link: Two SCE 2000s Topology* (on page 6-5).)
- Step 9** Connect the traffic port of *SCE 2000* platform #2, this will cause a momentary down time until the network elements from both sides of the *SCE 2000* platform auto-negotiate with it and start working (when working inline). (See *Dual Link: Two SCE 2000s Topology* (on page 6-5).)
- Step 10** When full control is needed, change the link mode on both *SCE 2000* platforms on both links to 'forwarding'. It is recommended to first configure the active *SCE 2000* platform and then the standby. (See *Link Mode* (on page 6-13).)
- Step 11** You can now start working with the Subscriber Manager.
-

CLI Commands

This section presents CLI commands relevant to the configuration and monitoring of a redundant system.

Use the following commands to configure and monitor a redundant system:

- `connection-mode`
- `[no] force failure-condition`
- `Show interface linecard 'number' connection-mode`
- `Show interface linecard 'number' physically-connected links`

Topology-Related Parameters for Redundant Topologies

All four of the topology-related parameters are required when configuring a redundant topology.

- **Connection mode** — Redundancy is achieved by cascading two *SCE 2000* platforms. Therefore the connection mode for both *SCE 2000* platforms may be either:
 - Inline-cascade

- Receive-only-cascade
- **Physically-connected-links** — For each of the cascaded *SCE 2000* platforms, this parameter defines the number of the link (Link 0 or Link 1) connected to this *SCE 2000* platform.
- **Priority** — For each of the cascaded *SCE 2000* platforms, this parameter defines whether it is the primary or secondary device.
- **On-failure** — For each of the cascaded *SCE 2000* platforms, this parameter determines whether the system cuts the traffic or bypasses it when the *SCE 2000* platform either has failed or is booting.

Configuring the Connection Mode

Use the following command to configure the connection mode, including the following parameters:

- inline/receive only
- physically connected links
- behavior upon failure of the *SCE 2000* platform
- primary/secondary

To configure the connection mode:

From the *SCE 2000(config if)#* prompt, type **connection-mode inline-cascade/receive-only-cascade** [**physically-connected-links** {*link-0/link-1*}] [**priority** {*primary/secondary*}] [**on-failure** {*bypass/cutoff*}] and press **Enter**.

EXAMPLE 1

Use the following command to configure the primary *SCE 2000* platform in a two-*SCE 2000* platform inline topology. Link 1 is connected to this *SCE 2000* platform and the behavior of the *SCE 2000* platform if a failure occurs is *bypass*.

```
SCE 2000(config if)# connection-mode inline-cascade physically-connected-links link-1 priority primary on-failure bypass
```

EXAMPLE 2

Use the following command to configure the *SCE 2000* platform that might be cascaded with the *SCE 2000* platform in Example 1. This *SCE 2000* platform would have to be the secondary *SCE 2000* platform, and Link 0 would be connected to this *SCE 2000* platform, since Link 1 was connected to the primary. The connection mode would be the same as the first, and the behavior of the *SCE 2000* platform if a failure occurs is also *bypass*.

```
SCE 2000(config if)# connection-mode inline-cascade physically-connected-links link-0 priority secondary on-failure bypass
```

Link Mode

The *SCE 2000* platform has an internal hardware card used to maintain the links even when the *SCE 2000* platform fails. This hardware card has four possible modes of operation:

- bypass
- forwarding
- cutoff
- sniffing

Normally, the link mode is selected by the *SCE 2000* platform software according to the configured connection-mode. However, the **link-mode** command can be used to enforce a specific desired mode. This may be useful when debugging the network, or in cases where we would like the *SCE 2000* platform just to forward the traffic. (Note that this is only relevant to inline topologies even though the configuration is available also when in receive-only mode.)

The following link mode options are available:

- **Forwarding** — forwards traffic on the specified link to the *SCE 2000* platform for processing.
- **Bypass** — stops all forwarding of traffic on the specified link to the *SCE 2000* platform. Traffic still flows on the link, but is not processed in any way by the *SCE 2000* platform.

This does not affect the redundancy states.

- **Sniffing** — allows the *SCE 2000* platform to forward traffic on the specified link through the bypass mechanism while still analyzing the traffic passively.

Sniffing is permitted to be configured for for all links, only (use the all-links option).

- **Cutoff** — completely cuts off flow of traffic through the specified link.

Note the following recommendations and restrictions:

- Since the *SCE 1000* platform has only one link, the link is not specified.
- Since the *SCE 2000* platforms have more than one link, it is required to specify the link. The link designations are different for the GBE and FE platforms, as follows:
 - *SCE 2000 4xGBE* — GBE1-GBE2/GBE3-GBE4
 - *SCE 2000 4/8xFE* — LINK1/LINK2
- Use the **'all-links'** option to configure the link mode for all links (*SCE 2000* platforms only).
- It is recommended that both links be configured together. Use the all-links option.
- Link mode is relevant only to inline topologies.
- It is recommended that in cascaded topologies, both *SCE 2000* platforms be configured for the same link mode, otherwise the service will be unpredictable.
- Sniffing can only be configured for all links, therefore, to configure sniffing, the all-links option is required, not just recommended.
- The default link mode is forwarding. When other link modes are selected, active service control is not available and any service control configuration will not be applicable.

To set the link mode:

From the *SCE 2000* (config if)# prompt, type **link-mode** [*<link>/all-links*] [*forwarding/bypass/sniffing/cutoff*] and press **Enter**.

Monitoring the System

Use the following commands to view the current connection mode and link mode parameters.

To view the current connection mode:

From the *SCE 2000*# prompt, type **show interface linecard 0 connection-mode** and press *Enter*.

To view the current link mode:

From the *SCE 2000*# prompt, type **show interface linecard 0 link mode** and press *Enter*.

To view the current link mappings:

From the *SCE 2000*# prompt, type **show interface linecard 0 physically-connected-links** and press *Enter*.

Loading and Activating a Service Control Application

The *SCE 2000* platform provides the basic functionalities of Service Control analysis and enforcement. A Service Control solution requires that a Service Control application be loaded into the platform, to take advantage of the unique SCE platform capabilities.

Loading and activating an application includes the following stages:

- Downloading the application provided as an SLI file to the *SCE 2000* disk.
- Activating the application.
- Configuring the application.

The detailed procedure of how to perform these operations is not specified and described in this manual. For further details, refer to the following documentation:

- *Service Control Application Suite for Broadband User Guide*
- *Service Control Application Suite for Broadband Reference Guide*

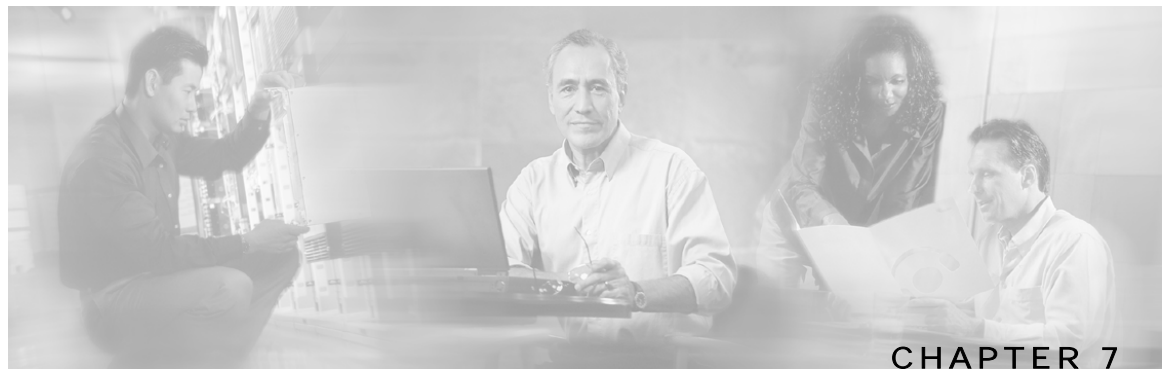

Basic SCE 2000 Platform Operations

This chapter describes how to start up the *SCE 2000* platform, reboot, and shutdown. It also describes how to manage configurations.

This chapter contains the following sections:

- [Starting the SCE 2000 Platform](#) 7-1
- [Managing SCE 2000 Configurations](#) 7-4
- [Performing Complex Configurations](#) 7-9
- [Rebooting and Shutting Down the SCE Platform](#) 7-9

Starting the SCE 2000 Platform

The procedures for starting the *SCE 2000* platform are explained in the following sections:

- [Checking Conditions Prior to System Startup](#) (on page 7-1)
- [Starting the System and Observing Initial Conditions](#) (on page 7-2)

Checking Conditions Prior to System Startup

Check the following conditions before you start your *SCE 2000* platform:

- Both power supply units are installed and connected
- First-time startup at installation:
 - *SCE 2000* platform connected to local console (CON port)
 - The console terminal is turned on and properly configured
- Subsequent startups
 - Line and Cascade interfaces are properly cabled (optional)
 - *SCE 2000* platform is connected to at least one of the following types of management stations:
 - Direct connection to local console (CON port)
 - Remote management station via the LAN (Mng port)

You are now ready to start your *SCE 2000* platform. Proceed to the section [Starting the System and Observing Initial Conditions](#) (on page 7-2).

Starting the System and Observing Initial Conditions

After installing your *SCE 2000* platform and connecting cables, complete the following steps to start the *SCE 2000* platform:

-
- Step 1** Make sure the power cables are connected to the *SCE 2000* platform.
- Step 2** Plug the AC power supply cables into the AC power source, or make sure the circuit breakers at the DC panels are turned to the on position. Turn both power switches on (|).
- Step 3** Listen for the fans; you should immediately hear them operating.
- Step 4** During the boot process, observe the following LEDs:
- Both Power LEDs should be green.
 - Bypass LED should be green while the *SCE 2000* is on bypass and unlit when the bypass is turned off.
 - The Status LED should be a constant orange while booting. After a successful boot, the Status LED is flashing green.



Note It takes a several minutes for the *SCE 2000* to boot and for the status LED to change from orange to flashing orange or flashing green.

- Step 5** Observe the initialization process. When the system boot is complete, the console screen displays a script and system banner similar to the following:

```
Cisco Internetwork Operating System Software
IOS (tm) 7300 Software (C7300-JS-M), Version 12.1(9), CISCO RELEASED VERSION
Copyright (c) 1986-2001 by Cisco Systems, Inc.
Compiled Tue 17-Jul-01 01:51 by biff
Image text-base:0x40008970, data-base:0x40BF8000
```

- Step 6** When you start up the *SCE 2000* platform for the first time, the system automatically enters the setup wizard, which prompts you for configuration information for initial system configuration. On the console terminal, after the system displays the system banner and hardware configuration, you will see the System Configuration Dialog prompt. (Refer to [Initial System Configuration](#) (on page 5-3) for a complete description of the setup wizard.)

You have the option of proceeding with the setup wizard to configure the system, or exiting from setup and using configuration commands to configure global (system-wide) and interface-specific parameters. You do not have to configure the interfaces immediately.

If the system does not complete each of the steps in the startup procedure, proceed to Chapter 7, [Troubleshooting](#) (on page 8-1) for troubleshooting recommendations and procedures.

Final Tests

The procedures for performing the final tests to verify that the *SCE 2000* is functioning properly are explained in the following sections:

- [Verifying Operational Status](#) (on page 7-3)
- [Viewing the User Log Counters](#) (on page 7-3)

Verifying Operational Status

After all the ports are connected, verify that the *SCE 2000* is not in a Warning state.

To verify that the *SCE 2000* is not in a warning state, complete the following steps:

-
- Step 1** On the *SCE 2000* Front panel, examine that the Status LED is flashing green.
- Step 2** To display the operation status of the system, at the *SCE 2000*# prompt, type **show system operation-status** and press **Enter**.

A message displaying the operation status of the system appears. If the system is operating in order, the following message appears:

```
System Operation status is Operational.
```

EXAMPLE:

The following example displays a sample output where the LEDs appear red/orange:

```
SCE 2000#show system operation-status  
System Operation status is Operational
```

Viewing the User Log Counters

View the user log for errors that occurred during the installation process.

To display the user log device counters, complete the following steps:

At the *SCE 2000*# prompt, type **show logger device User-File-Log counters** and press **Enter**.

EXAMPLE:

The following example shows the current User-File-Log device counters.

```
SCE 2000#show logger device user-file-log counters  
Logger device User-File-Log counters:  
Total info messages: 1  
Total warning messages: 0  
Total error messages: 0  
Total fatal messages: 0
```

If there are “Total error messages” or “Total fatal messages”, use the **show logger device User-File-Log** command to display details about the errors.

Managing SCE 2000 Configurations

The procedures for managing *SCE 2000* configurations are explained in the following sections:

- [Viewing Configuration](#) (on page 7-4)
- [Saving the Configuration Settings](#) (on page 7-6)
- [Recovering a Previous Configuration](#) (on page 7-8)

Viewing Configuration

When you enter configuration commands, it immediately effects the *SCE 2000* operation and configuration. This configuration, referred to as the *running-config*, is saved in the *SCE 2000* volatile memory and is effective while the *SCE 2000* is up. After reboot, the *SCE 2000* loads the *startup-config*, which includes the non-default configuration as saved by the user, into the *running-config*.

The *SCE 2000* provides commands for:

- Viewing the running configuration
- Viewing the startup configuration

After configuring the *SCE 2000*, you may query for the running configuration using the command **show running-config**. This command displays the non-default running configuration. To view all *SCE 2000* running configuration, whether it is the default or not, you may use the option **all-data** in the **show running-config** command.

To view the running configuration, complete the following steps:

At the *SCE 2000*# prompt, type **show running-config**.

The system shows the running configuration.

```
SCE 2000#show running-config
#This is a general configuration file (running-config).
#Created on 15:50:56 CET MON February 11 2002
#cli-type 1
#version 1

clock timezone CET 1
snmp-server community "public" ro
snmp-server host 10.1.1.253 traps version 1 "public"
interface LineCard 0
connection-mode active
no silent
no shutdown
flow-aging default-timeout UDP 60
interface FastEthernet 0/0
ip address 10.1.5.109 255.255.0.0
interface FastEthernet 0/1
interface FastEthernet 0/2
exit
line vty 0 4
no timeout
exit
SCE 2000#
```

One of the useful show commands is the **show version** command. This command displays global static information on the *SCE 2000* as software and hardware version, image build time, system uptime, last open packages names and information on the SLI application assigned.

To show the version information for the *SCE 2000* software and hardware, complete the following steps:

At the *SCE 2000*# prompt, type **show version**.

The system shows the version information.

```
SCE 2000#show version
System version: Version 2.5.2 Build 240
Build time: Jan 11 2005, 07:34:47
Software version is: Version 2.5.2 Build 240
Hardware information is:
rx          : 0x0075
dp          : 0x1808
tx          : 0x1708
ff          : 0x0077
cls         : 0x1721
cpld        : 0x0025
Lic         : 0x0176
rev         : G001
Bootrom     : 2.1.0
L2 cache    : Samsung 0.5
lic type    : MFE
optic mode  :
Part number: 53AA-BXC1-AAAA
Revision: A02A
Software revision: G001
Serial number: 043P6982
Power Supply type: AC

SML Application information is:
Application file: /tffs0/temp.sli
Application name:
Application help:
Original source file:
H:\work\Emb\jrt\V2.5\sml\actions\drop\drop_basic_anyflow.san
Compilation date: Wed, September 22, 2004 at 21:25:21
Compiler version: SANC v2.50 Build 32 gcc_codelets=true built on: Tue
September 22 2004 09:51:57 AM.;SME plugin v1.1
Default capacity option used.

Logger status: Enabled

Platform: SCE 2000 - 4xFE
Management agent interface version: SCE Agent 2.5.1 Build 18
Software package file:
ftp://vk:vk@10.1.8.22/P:/EMB/LatestVersion/2.5.2/se1000.pkg

SCE 2000 uptime is 21 minutes, 37 seconds
SCE 2000#
```

Another useful show command is the **show system-uptime** command. This command displays information similar to the last line above, which indicates how long the system has been running since the last reboot.

To show the system uptime for the *SCE 2000* software and hardware, complete the following steps:

At the *SCE 2000*# prompt, type **show system-uptime**.

The system shows how long the system has been running since the last reboot.

```
SCE 2000#show system-uptime
SCE 2000 uptime is 21 minutes, 37 seconds
SCE 2000#
```

Saving the Configuration Settings

When you make changes to the current running configuration and you want those changes to continue to be valid when the system restarts, you must save the changes before leaving the management session, that is, you must save the running configuration to the startup configuration file.

The *SCE 2000* platform provides multiple interfaces for the purpose of configuration and management. All interfaces supply an API to the same database of the *SCE 2000* platform and any configuration made through one interface is reflected through all interfaces. Furthermore, when saving the running configuration to the startup configuration from any management interface, all configuration settings are saved regardless of the management interface used to set the configuration.

To save configuration changes, complete the following steps:

Step 1 At the *SCE 2000*# prompt, type **show running-config** to view the running configuration.

The running configuration is displayed.

Step 2 Check the displayed configuration to make sure that it is set the way you want. If not, make the changes you want before saving.

Step 3 Type **copy running-config startup-config**.

The system saves all running configuration information to the configuration file, which is used when the system reboots.

The configuration file holds all information that is different from the system default in a file called config.txt located in the directory: tffs0:system.

EXAMPLE:

The following example shows the running configuration file.

```
SCE 2000#show running-config
#This is a general configuration file (running-config).
```



```
#Created on 15:50:56 CET MON February 11 2002
#cli-type 1
#version 1

clock timezone CET 1
snmp-server community "public" ro
snmp-server host 10.1.1.253 traps version 1 "public"
interface LineCard 0
connection-mode active
no silent
no shutdown
flow-aging default-timeout UDP 60
interface FastEthernet 0/0
ip address 10.1.5.109 255.255.0.0
interface FastEthernet 0/1

interface FastEthernet 0/2

exit
line vty 0 4
no timeout
exit
SCE 2000#
SCE 2000#copy running-config startup-config
Writing general configuration file to temporary location...
Backing-up general configuration file...
Copy temporary file to final location...
SCE 2000#
```

For backup purposes, the old startup-config file is saved under the directory: `tffs0:system/prevconf`. Refer to [Recovering a Previous Configuration](#) (on page 7-8) for an explanation on how to recover previous configuration.

To remove a configuration command from the running-config, use the no form of the command.

EXAMPLE:

The following example illustrates how to remove all DNS settings from the running configuration.

```
SCE 2000(config)#no ip name-server
SCE 2000(config)#
```

Recovering a Previous Configuration

When you save a new configuration, the system automatically backs up the old configuration in the directory `tffs0:system/prevconf/`. Up to nine versions of the startup configuration file are saved, namely `config.tx1-config.tx9`, where `config.tx1` is the most recently saved file.

You can view the old startup configuration files using the CLI command **more**.

Restoring a previous startup configuration means renaming the file so it overwrites the startup configuration (`config.txt`) file.

To restore a previous startup configuration, complete the following steps:

Step 1 At the *SCE 2000*# prompt, type **more tffs0:system/prevconf/config.txt** to view the configuration file.

The system displays the configuration information stored in the file.

Step 2 Read the configuration information to make sure it is the configuration you want to restore.

Note that you cannot undo the configuration restore command.

Step 3 Type
copy tffs0:system/prevconf/config.tx1 tffs0:system/config.txt.

The system sets the startup configuration to the configuration from `config.tx1`.

EXAMPLE:

The following example displays a saved configuration file and then restores the file to overwrite the current configuration.

```
SCE 2000#more tffs0:system/prevconf/config.tx1
#This is a general configuration file (running-config).
#Created on 19:36:07 UTC THU February 14 2002

#cli-type 1
#version 1

interface LineCard 0
no silent
no shutdown

interface FastEthernet 0/0
ip address 10.1.5.109 255.255.0.0

interface FastEthernet 0/1

interface FastEthernet 0/2

exit

line vty 0 4
exit
SCE 2000#copy tffs0:system/prevconf/config.tx1 tffs0:system/config.txt
SCE 2000#
```

Performing Complex Configurations

After you have installed your *SCE 2000* platform hardware, checked all external connections, turned on the system power, allowed the system to boot up, and performed the initial system configuration, you might need to perform more complex configurations, which are beyond the scope of this publication.

For further information on system and interface configuration, refer to the following documents:

- *Cisco Service Control Engine (SCE) Software Configuration Guide*
- *Cisco Service Control Engine (SCE) CLI Command Reference*

Rebooting and Shutting Down the SCE Platform

Rebooting the SCE Platform

Rebooting the *SCE 2000* platform is required after installing a new firmware, in order for that firmware to take effect. There might be other occasions where rebooting the *SCE 2000* platform is necessary.

**Note**

When the SCE restarts, it loads the startup configuration, so all changes made in the running configuration will be lost. You are advised to save the running configuration before performing reload, as described in [Saving the Configuration Settings](#) (on page 7-6).

To reboot your *SCE 2000* platform, complete the following steps:

-
- Step 1** At the *SCE 2000*# prompt, type **reload** and press **Enter**.
A confirmation message appears.
- Step 2** Type **Y** to confirm the reboot request and press **Enter**.
-

EXAMPLE:

The following example shows the commands for system reboot.

```
SCE 2000# reload
Are you sure? y
the system is about to reboot, this will end your CLI session
```

Shutting Down the SCE Platform

Shutting down the *SCE 2000* platform is required before turning the power off. This helps to ensure that non-volatile memory devices in the *SCE 2000* platform are properly flushed in an orderly manner.



Note When the SCE platform restarts, it loads the startup configuration, so all changes made in the running configuration will be lost. You are advised to save the running configuration before performing reload, as described in [Saving the Configuration Settings](#) (on page 7-6).

To shut down your *SCE 2000* platform, complete the following steps:

-
- Step 1** Connect to the serial console port (The CON connector on the *SCE 2000* platform front panel, 9600 baud).
- The *SCE 2000#* prompt appears.
- Step 2** Type `reload shutdown`.
- A confirmation message appears.
- Step 3** Type `Y` to confirm the shutdown request and press **Enter**.
-

EXAMPLE:

The following example shows the commands for system shutdown.

```
SCE 2000#reload shutdown
You are about to shut down the system.
The only way to resume system operation after this
is to cycle the power off, and then back on.
Continue?
Y

IT IS NOW SAFE TO TURN THE POWER OFF.
```



Note Since the *SCE 2000* platform can recover from the power-down state only by being physically turned off (or cycling the power), this command can only be executed from the serial CLI console. This limitation helps prevent situations in which a user issues this command from a Telnet session, and then realizes he/she has no physical access to the *SCE 2000* platform.

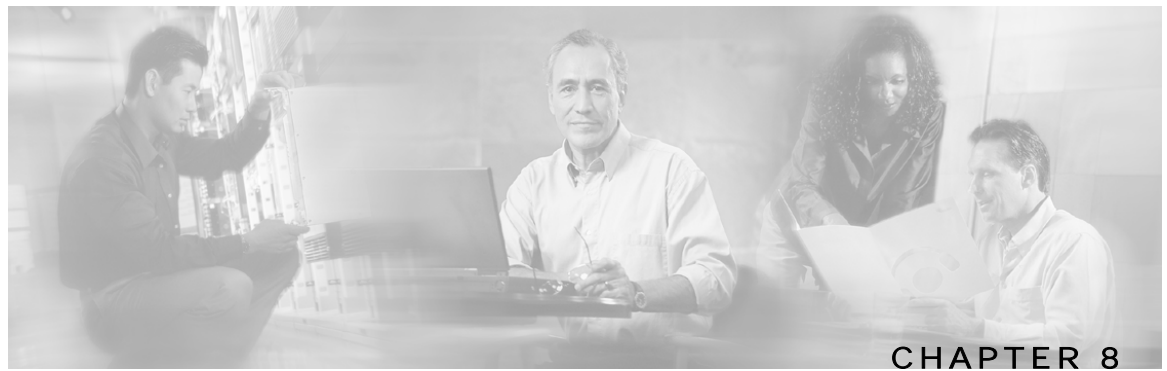

Troubleshooting

Your *SCE 2000* platform went through extensive testing before leaving the factory. However, if you encounter problems starting it, use the information in this chapter to help isolate the cause of the problems. The procedures in this chapter assume that you are troubleshooting the initial system startup, and that your *SCE 2000* platform is in the original factory configuration. If you have removed or replaced components or changed any default settings, the recommendations in this chapter might not apply. Make sure to review the safety warnings listed in the *Regulatory Compliance and Safety Information for the Cisco Service Control Engine* document that accompanied your *SCE 2000* platform before using the troubleshooting procedures in this chapter.

This chapter contains the following sections:

- [Troubleshooting Overview](#) 8-1
- [Troubleshooting Tools](#) 8-2
- [Problem Solving Using a Subsystems Approach](#) 8-8

Troubleshooting Overview

This section describes the troubleshooting methods used in this chapter and describes how the *SCE 2000* platform is divided into subsystems for more efficient problem solving. If you are unable to easily solve the problem, contact a customer service representative for assistance and further instructions. Provide the representative with the following information:

- Date you received the router
- Chassis serial number
- Type of software and release number
- Brief description of the problem you are having
- Brief explanation of the steps you have taken to isolate and resolve the problem
- Maintenance agreement or warranty information

The following table shows the general troubleshooting strategy described in this chapter. Refer to this table, as necessary, to follow the steps to isolate problems to a specific subsystem and resolve the problem if possible.

Table 8-1 Troubleshooting Strategy for Startup Problems

	Action	Yes	No
Step 1	Turn power on. Go to Step 2		
Step 2	Power A/Power B LEDs on?	Go to Step 3	Refer to <i>Troubleshooting the power subsystem</i> ("Troubleshooting the Power Subsystem" on page 8-9) and go to Step 3.
Step 3	Status LED red (failure)	Refer to <i>Troubleshooting the firmware package installation</i> (on page 8-11) and go to Step 4.	Go to Step 4
Step 4	Management interface operational?	Go to Step 5	Refer to <i>Troubleshooting the management subsystem</i> ("Troubleshooting the Management Subsystem" on page 8-12) and go to Step 4.
Step 5	Link interfaces operational?	Go to Step 6	Refer to <i>Troubleshooting the link interface subsystem</i> ("Troubleshooting the Link Interface Subsystem" on page 8-14) and go to Step 5.
Step 6	System startup successful (all interfaces operating normally).	—	—

Troubleshooting Tools

There are three tools that will help you to successfully troubleshoot your *SCE 2000* installation:

- *CLI Commands for Troubleshooting* (on page 8-3)
- *The User Log* (on page 8-4)
- *Check the LEDs* (on page 8-7)

CLI Commands for Troubleshooting

Use the following commands to provide information to help you troubleshoot installation of your *SCE 2000* platform. Refer to *Cisco Service Control Engine (SCE) Software Configuration Guide* or the *Cisco Service Control Engine (SCE) CLI Command Reference* for more information.



Note

Remember that if the management interface is not operational, you should connect the *SCE 2000* platform to a local console so that you can enter CLI commands for troubleshooting.

- **Troubleshooting firmware package installation:**

- **Boot system <filename>** — Specifies and verifies the package file to be installed. Error messages or other output identify problems with the package file.

Following is a sample output from the **Boot system** command.

```
SCE 2000(config)#boot system ftp://vk:vk@10.1.1.230/downloads/SENum.pkg.pkg
Verifying package file SENum.pkg.pkg...
Package file verified OK.
```

- **Troubleshooting the management subsystem:**

- **show interface Mng** — Displays IP address and auto-negotiation information for the management interfaces.

Following is a sample output from the **show interface Mng** command.

```
ip address: 10.1.6.145
subnet mask: 255.255.0.0
Configured speed: auto, configured duplex: auto
AutoNegotiation is On, link is Up, actual speed: 100, actual duplex: half
```

- **show ip default-gateway** — Displays the IP address of the configured default gateway.

Following is a sample output from the **show ip default-gateway** command.

```
Default gateway: 10.1.1.1
```

- **show ip route** — Displays the entire routing table and the destination of last resort (default-gateway).

Following is a sample output from the **show ip route** command.

```
gateway of last resort is 10.1.1.1
```

- **show access-lists** — Shows all access-lists or a specific access list.

Following is a sample output from the **show access-lists** command.

```
Standard IP access list 1
Permit 10.1.1.0, wildcard bits 0.0.0.255
deny any
```

- **show telnet** — Displays the status of the telnet server daemon (**status**) or any active Telnet sessions (**sessions**).

Following is a sample output from the **show telnet** command.

```
show telnet sessions
There is 1 active telnet session:
```

```
Index | Source
=====
0 | 10.1.1.201
```

```
show telnet status
Telnet daemon is enabled.
```

- `show line vty timeout` — Shows the timeout configured for Telnet sessions.

Following is a sample output from the `show line vty timeout` command.

```
Timeout is 30 minutes
```

- **Troubleshooting the link interface subsystem:**

- `show interface GigabitEthernet 0/#` — Displays information for a specific GBE Interface.

Following is a sample output from the `show interface` command.

```
ip address: 10.1.6.145
subnet mask: 255.255.0.0
Configured duplex: auto
AutoNegotiation is On, link is Up, actual duplex: half
```

- `show interface GigabitEthernet 0/# counters` — Displays the values of counters of a GBE interface.

Following is a sample output from the `show interface counters` command.

```
In total octets: 191520
In good unicast packets: 560
In good multicast packets: 0
In good broadcast packets: 0
In packets discarded: 0
In packets with CRC/Alignment error: 0
In undersized packets: 0
In oversized packets: 0
Out total octets: 0
Out unicast packets: 0
Out non unicast packets: 0
Out packets discarded: 0
```

Refer to [The User Log](#) (on page 8-4) for an explanation of commands related to the user log.

The User Log

The user log is an ASCII file that can be viewed in any editor. It contains a record of system events, including startup, shutdown and errors. You can use the Logger to view the user log to determine whether or not the system is functioning properly, as well as for technical support purposes.

The Logging System

Events are logged to one of two log files. After a file reaches maximum capacity, the events logged in that file are then temporarily archived. New events are then automatically logged to the alternate log file. When the second log file reaches maximum capacity, the system then reverts to logging events to the first log file, thus overwriting the temporarily archived information stored in that file.

Basic operations include:

- Copying the User Log to an external source
- Viewing the User Log
- Clearing the User Log

- Viewing/clearing the User Log counters

Copying the User Log

You can view the log file by copying it to an external source or to disk. This command copies both log files to the local *SCE 2000* platform disk or any external host running a FTP server.

To copy the user log to an external source, use the following command:

From the *SCE 2000*# prompt, type **logger get user-log file-name**
ftp://username:password@ipaddress/path and press **Enter**.

The *SCE 2000*# prompt appears.

To copy the user log to an internal location, use the following command:

From the *SCE 2000*# prompt, type **logger get user-log file-name** *target-filename* and press **Enter**.

The *SCE 2000*# prompt appears.

Viewing the User Log



Note

This command is not recommended when the user log is large. Copy a large log to a file to view it (see [Copying the User Log](#) (on page 8-5))

To view the user log:

From the *SCE 2000*# prompt, type **more user-log** and press **Enter**.

The user log appears, followed by the *SCE 2000*# prompt.

Clearing the User Log

You can clear the contents of the user log at any time. The user log contains important information regarding the functioning of the system. It is recommended that a copy be made before the log is cleared.

To clear the user log, complete the following steps:

Step 1 From the *SCE 2000*# prompt, type **clear logger device user-file-log** and press **Enter**.

Step 2 The system asks *Are you sure?*

Step 3 Type **Y** and press **Enter**.

The *SCE 2000*# prompt appears.

Viewing the User Log Counters

There are two types of log counters:

- User log counters — count the number of system events logged from the *SCE 2000* platform last reboot.
- Non-volatile counters — are not cleared during boot time

To view the user log counters for the current session, use the following command:

From the *SCE 2000*# prompt, type **show logger device user-file-log counters** and press **Enter**.

The logger lines information appears, followed by the *SCE 2000*# prompt.

To view the non-volatile logger counters for both the User log file and the debug log file, use the following command:

From the *SCE 2000*# prompt, type **show logger nv-counters** and press **Enter**.

The non-volatile log counter information appears, followed by the *SCE 2000*# prompt.

To view the non-volatile counter for the user-file-log only, use the following command:

From the *SCE 2000*# prompt, type **show logger device user-file-log nv-counters** and press **Enter**.

The user-file-log non-volatile log counter information appears, followed by the *SCE 2000*#

prompt.

Generating a File for Technical Support

In order for technical support to be most effective, the user should provide them with the information contained in the system logs. Use the `logger get support-file` command to generate a support file for the use of Cisco technical support staff.

To generate a log file for technical support:

From the `SCE 2000#` prompt, type `logger get support-file filename` and press **Enter**.

The support information file is created using the specified filename, and the `SCE 2000#` prompt appears. This operation may take some time.

Check the LEDs

The front panel LEDs are the most immediate problem-detection mechanism of the platform. Refer to the following sections for information on `SCE 2000` platform LEDs:

- [Front Panel](#) (on page 2-2)
- [LEDs](#) (on page 4-13)
- [SCE 2000 Operational Status](#) (on page 8-7)

SCE 2000 Operational Status

The following table lists the operational states of the `SCE 2000`. The Status LED on the `SCE 2000` Front Panel reflects the current `SCE 2000` operational status. The operational status can be displayed using CLI command `show system operation-status`.

Table 8-2 SCE 2000 Operational States

<i>SCE 2000</i> Operational Status	Description	Status LED State
Booting	Initial state after reset	Orange
Operational	<p><i>SCE 2000</i> becomes operational after completing the following process:</p> <ul style="list-style-type: none"> • Boot is completed • Power self-tests are completed without failure • Platform configuration is applied 	Flashing green

<i>SCE 2000</i> Operational Status	Description	Status LED State
Warning	<p><i>SCE 2000</i> is fully operational (as above) but one of the following occurred:</p> <ul style="list-style-type: none"> • Line ports (GBE ports) to the link are down • Management port link is down • Temperature raised above threshold • Voltage not in required range • Fans problem • Power supply problem • Insufficient space on the disk <p>Note: If the condition that caused the <i>SCE 2000</i> to be in Warning state is resolved (for example, link is up) the <i>SCE 2000</i> reverts to Operational state.</p>	Flashing orange
Failure	<p>System is in Failure state after Boot due to one of the following conditions:</p> <ul style="list-style-type: none"> • Power on test failure • Three abnormal reboots in less than 20 minutes • Platform configured to enter Failure mode consequent to failure-induced reboot (this is configurable using CLI command) <p>Note: Depending on the cause of failure, the management interface and the platform configuration may or may not be active/available.</p>	Red

Problem Solving Using a Subsystems Approach

Identifying Startup Problems

Startup problems are commonly due to the source power or to a poor cable connection.

When you start up the *SCE 2000* platform for the first time, you should observe the startup sequence described in the [Starting the SCE 2000 Platform](#) (on page 7-1). This section contains a more detailed description of the normal startup sequence and describes the steps to take if the system does not perform that sequence as expected. LEDs indicate all system states in the startup sequence. By checking the state of the LEDs, you can determine when and where the system failed in the startup sequence. Use the following descriptions to isolate the problem to a subsystem, and then proceed to the appropriate sections to try to resolve the problem.

When you start up the system by turning on the power supply switch, the following should occur:

- You should immediately hear the fans operating.

- When all LEDs come on to indicate that the system has booted successfully, the initial system banner should be displayed on the console screen. If it is not displayed, see [Connecting the Local Console](#) (on page 5-1) to verify that the terminal is set correctly and that it is properly connected to the console port.
- If the banner is displayed, but the Status LED is flashing orange, indicating a warning state, check the user log:

At the prompt, type: **more user log**

If any of the following warning messages appear, turn the *SCE 2000* platform off and call technical support.

- "voltage problem:"
- "fans problem"
- "abnormal raise in interior temperature:"

If the following warning message appears, delete unneeded files from the disk.

- "insufficient disk space:"

Troubleshooting the Power Subsystem

Check the following to help isolate a problem in the power subsystem. In the normally configured *SCE 2000* platform with redundant power supply units, it is unlikely that the device will not start at all. However, at startup it should be verified that both power supply units are operational, and therefore the following steps should be followed if one of the Power LEDs on the front panel remains unlit when the *SCE 2000* platform is powered up.



Note

If the system powers off due to an environmental shutdown, wait at least one minute before manually rebooting the system, or it will pause indefinitely.

Table 8-3 Troubleshooting the Power Subsystem

Symptom	Possible Cause	Possible Solution
Power LED on the front panel and LEDs on the power supply unit are not lit, or do not remain lit continuously.	Power cable not fully seated at system.	Turn the power switch to the off position and reseal the power cable in the system.
	Power cable not fully seated at source.	Turn the switch to the off position and reseal the power cable at the power source.
	Power source is faulty.	Turn the switch to the off position, connect the power cable to another power source, if available, and turn the switch back on.
	Faulty power cable.	Turn the switch to the off position, remove the cable and replace it.
	Faulty power supply.	If the system still fails to come up when the power supply is connected to a different power source with a new power cable, the power supply unit is probably faulty. Contact a service representative.

Table 8-4 Power Supply LEDs

LED Label	Color	State	Function
IN	Green	On	The input voltage is in the required range.
		Off	The input voltage is not in the required range.
OK	Green	On	The output voltage is in the required range (between 11.9 and 12.1 VDC).
		Off	The output voltage is not within the required range (is greater than 12.1 VDC or less than 11.9 VDC).
Power A/B (front panel)	Green	Steady	Corresponding power supply unit is present and functioning normally.
		Red	Corresponding power supply unit present, but malfunctioning.
		Off	Corresponding power supply unit is either not present or has failed.

Troubleshooting the Firmware Package Installation

Check the following to help isolate a problem in the installation of the firmware package.

Problems related to the installation of the firmware package could be any of the following:

- File not found in the expected location
- Wrong file type.
- Device to which the file is to be extracted is full.

Table 8-5 Troubleshooting the Firmware Package Installation

Diagnostic Action		
Symptom	Possible Cause	Possible Solution
Enter the CLI command:		
<ul style="list-style-type: none"> • configure • Boot system <filename> 		
Returned error is: Error-File <file name> does not exist	The package file does not exist in the specified location.	Verify package file location and try again.
In the output of the command, the package file type is management-image instead of system-image	Package file type mismatch.	Verify that you are trying to open the correct package file.
In the output of the command, the package file platform is not the correct installation file for the SCE 2000 .	Package file platform mismatch.	Verify that you have the package file appropriate to your platform type.
Returned error is: Package file <file name> does not contain magic header	The file is not a software installation package file.	Verify that you are trying to open the correct package file.
Returned error is: Error-There are only X free bytes on device <device name>, but Y bytes are needed for the extraction (where X and Y are stated in bytes)	/tffs0/ device is full.	Delete old and unnecessary files and try the package extraction again.

Troubleshooting the Management Subsystem

Check the following to help isolate a problem in the management subsystem.

Problems in the management subsystem could be any of the following:

- Management link is down. (Mng LINK LED not lit--also Status is WARNING)
- Management link is up (Mng LINK LED lit) but does not answer ping
- Telnet connection cannot be established due to link problems (Mng LINK LED not lit)
- Management link is up (Mng LINK LED lit) but Telnet connection cannot be established
- Telnet connection established, but terminates automatically



Note

When the management link is down and/or a Telnet connection cannot be established, you must open a CLI session on a local terminal connected to the CON port. This enables you to solve the problem and then reconnect through the management port.

Table 8-6 Troubleshooting the Management Subsystem

Symptom	Diagnostic Action	Possible Cause	Possible Solution
Management link down: <ul style="list-style-type: none"> • Mng LINK LED not lit • Status is WARNING (Status LED is flashing orange) 	<ul style="list-style-type: none"> • CLI command <code>show interface Mng</code> • <code>ping</code> to management interface fails 	RJ 45 connector is not connected to the platform or to the network.	Reconnect the cable to the Mng port and to network.
		Cable not connected to configured Mng port.	Reconnect the cable to the appropriate port or reconfigure active port. Interface Mng {0/1 0/2} active-port
		Cable is broken.	Check / Replace the cable.
Management link up: <ul style="list-style-type: none"> • Mng LINK LED is lit • <code>ping</code> to management interface fails 	CLI commands <ul style="list-style-type: none"> • <code>show ip route</code> • <code>show ip default-gateway</code> 	One of the following configurations may be wrong: <ul style="list-style-type: none"> • IP address / subnet mask • IP default gateway 	See <i>Initial System Configuration</i> (on page 5-3) Refer to "IP Configuration" in the <i>Cisco Service Control Engine (SCE) Software Configuration Guide</i> .

	CLI command <code>show access-lists</code>	An ACL may be assigned that denies entry.	See Initial System Configuration (on page 5-3) Refer to " Access Control Lists " in the <i>Cisco Service Control Engine (SCE) Software Configuration Guide</i> .
<ul style="list-style-type: none"> • Telnet connection cannot be established • Mng LINK LED is not lit (link is down) 	<ul style="list-style-type: none"> • CLI command <code>show interface mng</code> 	Management interface IP address or subnet mask is incorrect.	Check / reconfigure management port IP address and subnet mask
<ul style="list-style-type: none"> • Telnet connection cannot be established • Mng LINK LED is lit (link is up) 	CLI command: <code>show telnet status</code>	Telnet server is disabled.	Enable Telnet server: <code>service telnetd</code>
	CLI command: <code>show telnet sessions</code>	Too many Telnet connections (up to 5 concurrent sessions are supported).	Close one or more of the open Telnet sessions.
	CLI command: <code>show ip default-gateway</code>	Default gateway is incorrect (when the host used as client is not in the same network as the SCE Platform).	Check / reconfigure default gateway. See Initial System Configuration (on page 5-3) Refer to " IP Configuration " in the <i>Cisco Service Control Engine (SCE) Software Configuration Guide</i> .
	CLI command: <code>show ip route <host-ip-address></code>	Routing tables are incorrectly configured (when the host used as client is not in the same network as the SCE Platform, and there is more than one gateway on the SCE Platform network).	Check / reconfigure routing tables. See Initial System Configuration (on page 5-3) Refer to " IP Configuration " in the <i>Cisco Service Control Engine (SCE) Software Configuration Guide</i> .
	CLI commands: <ul style="list-style-type: none"> • <code>show access-lists</code> • <code>show line vty access-class</code> • <code>show ip access-class</code> 	Host is not a member of a valid access-list.	Check / reconfigure access-list. See Initial System Configuration (on page 5-3) Refer to " Access Control Lists " in the <i>Cisco Service Control Engine (SCE) Software Configuration Guide</i> .

Problem Solving Using a Subsystems Approach

Telnet connection terminates automatically	CLI commands: <ul style="list-style-type: none"> • show line • show line vty timeout 	Telnet connection may be timing out.	Reconfigure line timeout. <pre>timeout <time in seconds></pre>
--	--	--------------------------------------	---

Troubleshooting the Link Interface Subsystem

Check the following to help isolate a problem in the link interface subsystem.

In general, the case where no traffic is coming out of the *SCE 2000* is often caused by link problems or GBE interface configuration. Note that in some cases, the problem which seems as a transmit problem could be in the Rx (no traffic is being received by the *SCE 2000* or there is actually no traffic on the line, which could be a normal situation).



Note

In CLI commands of GigabitEthernet interfaces, # stands for the number of the interface. This can be 1 through 4.

Problems in the link interface subsystem could be any of the following:

- Link is down. (LINK LED not lit and system status is WARNING)
- Peer does not receive traffic from *SCE 2000* (GBE link is lit and Tx LED is flashing)
- GBE link is up but not receiving from peer (GBE link is lit, but Rx LED is not flashing)

Table 8-7 Troubleshooting the Link Interface Subsystem

Symptom	Diagnostic Action	Possible Cause	Possible Solution
<ul style="list-style-type: none"> • Link is down. (LINK LED not lit) • Status is WARNING (Status LED is flashing orange) • Output counters not incrementing. 	CLI command: <ul style="list-style-type: none"> • show interface GigabitEthernet 0/# counters 	Connector is not connected to the platform or to the network.	Reconnect the cable to the GBE port and to network.
		GBE cable is broken.	Reconnect / replace the cable to the GBE port.
			If GBE counters are incrementing, this indicates LED problem. Contact customer support.

	<p>CLI commands:</p> <pre>show interface GigabitEthernet 0/# counters</pre> <p>Check output of this command for: “In good unicast packet” and “Out unicast packet”. These counters should be constantly incrementing.</p>	Auto-negotiation may be incorrectly configured.	Check <i>auto-negotiation</i> (“Configuring the GBE Interface Parameters” on page 6-6) configuration in the <i>SCE 2000</i> and in its peers.
<ul style="list-style-type: none"> • GBE link is up (GBE interface link LED is continuous green and GBE interface Tx LED is flashing) • Peer does not receive traffic from <i>SCE 2000</i> 	<p>CLI commands:</p> <ul style="list-style-type: none"> • <pre>show interface GigabitEthernet 0/# counters</pre> <p>Check output of this command for: “Out unicast packet”. This counter should be constantly incrementing.</p> <pre>show interface GigabitEthernet 0/#</pre>	Auto-negotiation is disabled at the <i>SCE 2000</i> but enabled at peer.	Check <i>auto-negotiation</i> (“Configuring the GBE Interface Parameters” on page 6-6) configuration in the <i>SCE 2000</i> and in peer.
<ul style="list-style-type: none"> • GBE link is up (GBE interface link LED is continuous green) • No traffic received (GBE interface Rx LED is not flashing) 		No traffic is being transmitted to the <i>SCE 2000</i> from its peers.	Check traffic connection at peer.
		Auto-negotiation is disabled at the <i>SCE 2000</i> but enabled at peer.	Check <i>auto-negotiation</i> (“Configuring the GBE Interface Parameters” on page 6-6) configuration in the <i>SCE 2000</i> and in peer.

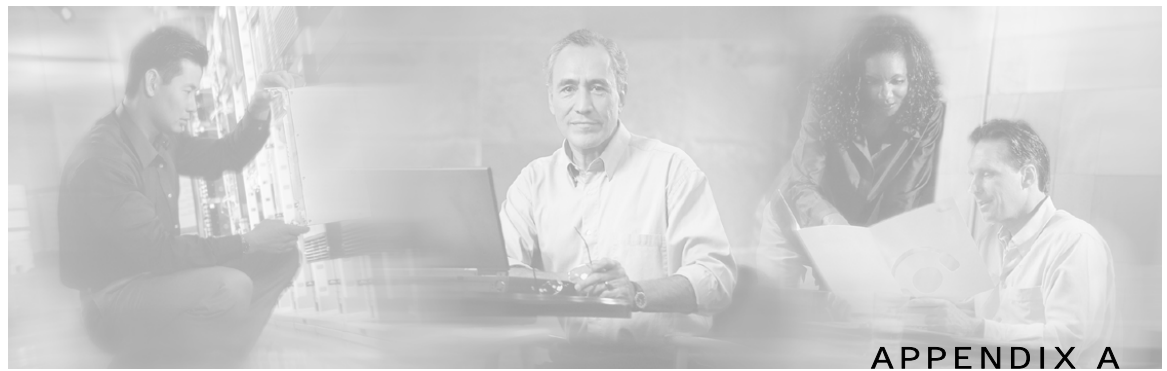

The External Optical Bypass Module

The *SCE 2000* platform External Optical Bypass module preserves the service provider GBE links in case of complete power failure of the *SCE 2000* platform, or for implementing a maintenance window.

The *SCE 2000* platform state-of-the-art Service Control platform is being deployed at ISPs, Cable and Wireless Tier1 provider networks, and is therefore required to comply with the carrier grade availability requirements of these mission critical networks.

The *SCE 2000* platform already includes an internal Electrical Bypass module that puts the *SCE 2000* platform into bypass state in case of a software or hardware failure at the platform main board, thereby preserving the GBE network link.

The External Optical Bypass module provides additional service protection by enabling automatic preservation of the network GBE link in two additional important scenarios:

- Complete loss of power in the *SCE 2000* platform — The *SCE 2000* platform includes redundant Power Supply Units and redundant power feeds, in both the DC and AC versions. However, in case either both PSUs fail, or both power feeds stop providing power to the *SCE 2000* platform simultaneously, the network link will be preserved by the External Optical Bypass module.
- Maintenance window implementation — In certain situations the *SCE 2000* platform should be pulled from the network for replacement, such as:
 - Hardware failure in the *SCE 2000* platform.
 - Hardware upgrade on the *SCE 2000* platform

In these cases, a maintenance window is implemented, during which the *SCE 2000* platform is pulled from the network. It may be replaced by another *SCE 2000* platform, either almost immediately, or after several hours or days. An External Optical Bypass module enables the implementation of such replacement while preserving normal operation of the network link.

The External Optical Bypass module is another important component in the Cisco overall carrier-grade solution for high-availability service provider networks.

External Optical Bypass Functionality

The External Optical Bypass module is connected bump-in-the-wire in the GBE link. It is then connected to the *SCE 2000* platform with two types of connections:

- GBE optical connections for data link traffic — GBE connections from the External Optical Bypass module to one pair of the GBE line ports.
- Power and Control connection — Connection to a dedicated connector on the *SCE 2000* platform back panel, so the *SCE 2000* platform can provide power to the External Optical Bypass module. (Note that the power connection also provides the logical control functionality.)

The External Optical Bypass module is normally inactive, (not in bypass), and simply transfers the two GBE signals to and from the *SCE 2000* platform.

In case the *SCE 2000* platform stops providing power to the External Optical Bypass module, or in case the power cable is disconnected from the optical bypass module, the External Optical Bypass module becomes active, bypassing the two GBE links to the *SCE 2000* platform, and thus preserving network connectivity.

The figure below illustrates the operation of the bypass module when it is inactive (not in bypass). The data traffic is simply transferred through the bypass module to the *SCE 2000* platform.

Figure A-1: External Optical Bypass Module: Inactive (not in bypass)

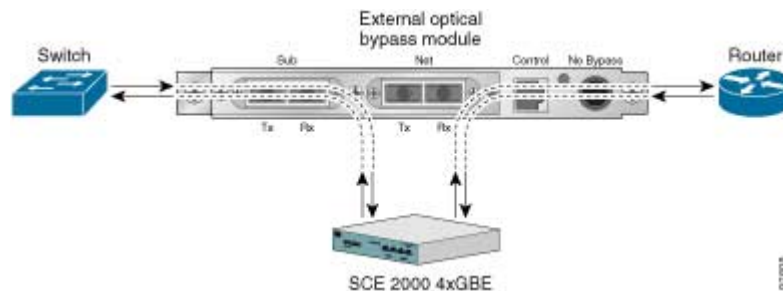

The figure below illustrates the operation of the bypass module when it is active (in bypass). The data traffic flows through the bypass module, and the GBE link no longer includes the *SCE 2000* platform. Note that when the bypass module is active, it puts the *SCE 2000* platform into a loop connection, creating a shortcut between the *SCE 2000* platform GBE interfaces.

Figure A-2: External Optical Bypass Module: Active (in bypass)

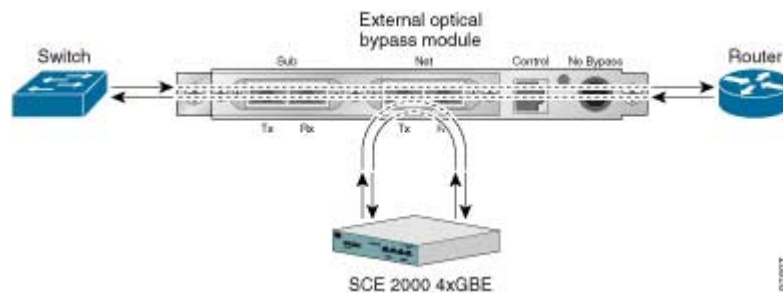

The External Optical Bypass Module Front Panel

The front panel of the External Optical bypass module contains the following components:

- SUB Rx/Tx — GBE port that connects to the network element on the Subscriber side of the link.
- NET Rx/Tx — GBE port that connects to the network element on the Network side of the link.
- CONTROL — RJ-45 port that connects to the Bypass connector on the rear panel of the *SCE 2000* platform. The *SCE 2000* platform controls the External Optical Bypass module via this connection, by the presence or absence of electrical power.
- Pigtail fiber connectors — Four fiber cables that connect to the GBE link ports on the front panel of the *SCE 2000* platform
 - NET Tx
 - NET Rx
 - SUB Tx
 - SUB Rx
- No Bypass LED:
 - ON = Bypass module is not active (GBE traffic flows through the *SCE 2000* platform)
 - OFF = Bypass module is active (GBE traffic flows through the bypass module)

Figure A-3: External Optical Bypass Module

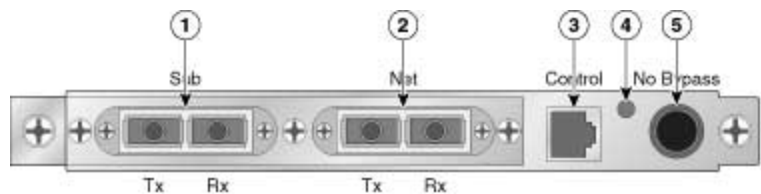

Installing the External Bypass Module

Installation of the External Optical Bypass module requires two main steps, which are described in detail in the following sections.

To install the External Optical Bypass module:

-
- Step 1** Install the module in the rack.
 - Step 2** Cable the module.
-

Installing the Module in a Rack

The following procedure describes how to install the module in the rack.

Note that, although each module is shipped with its own mounting panel, it is not necessary to install each module in a separate mounting panel. Up to three modules may be installed in one mounting panel.

To install the External Optical Bypass module in a 19" rack, complete the following steps:

-
- Step 1** Using the screws attached to the module, screw it into an empty position in the mounting panel.
- Step 2** Secure the module panel to the two front posts of the rack above the *SCE 2000* platform. Leave at least 1.5 cm vertical clearance between the *SCE 2000* platform and the module panel to provide space for the cables from the front panel of the module to the rear of the *SCE 2000* platform.

The module can now be cabled as explained in the next section.



Note If only one or two External Optical Bypass modules are deployed in one panel, the empty third position can be used for transferring the cables, thus saving rack space.

Cabling the External Optical Bypass Module

The following procedure describes how to cable the External Optical Bypass module. Note the following:

- All connections to the External Optical Bypass module are on the front panel of the module.
- If installing only one module, the connections are as follows:
 - Connect the fiber (steps 3 and 4) to the GBE-1 Line ports on the *SCE 2000* platform.
 - Connect the control cable to the **Bypass 1** 9-pin D-Type connector on the rear panel of the *SCE 2000* platform.
- If installing two modules, repeat the entire procedure for the second module, with the following changes:
 - Connect the fiber (steps 3 and 4) to the GBE-2 Line/Cascade ports on the *SCE 2000* platform.

- Connect the control cable to the **Bypass 2** 9-pin D-Type connector on the rear panel of the **SCE 2000** platform.

Figure A-4: Bypass Connectors on the Rear of the SCE 2000



The following figure illustrates the connectivity of the External Optical Bypass module.

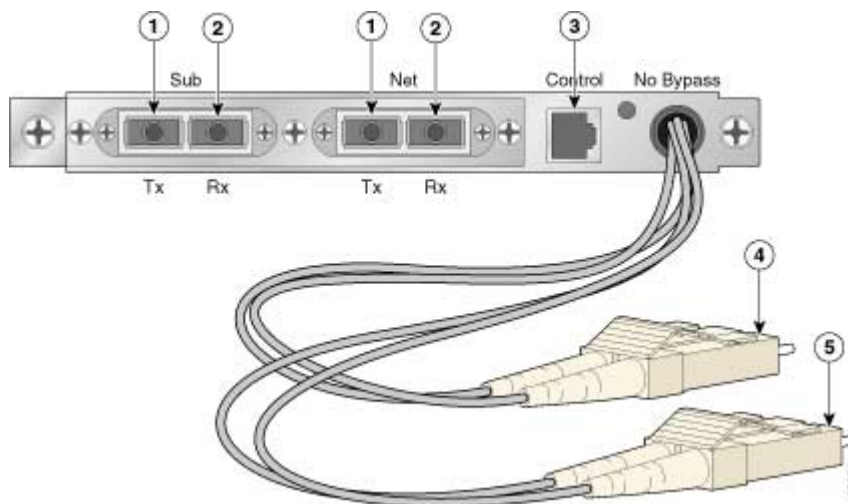

To cable the External Optical Bypass module:

- Step 1** Connect an optical cable (user supplied) between the GBE port on the Subscriber side network element and the **SUB** port on the External Optical Bypass module.
- Step 2** Connect an optical cable (user supplied) between the GBE port on the Network side network element and the **NET** port on the External Optical Bypass module.
Verify that the links between the two network elements are active.
- Step 3** Connect the **SUB** cable of the fiber of the External Optical Bypass module to the **SUB** GBE port of the **SCE 2000** platform.
Rx <-> Tx
- Step 4** Connect the **NET** cable of the fiber of the External Optical Bypass module to the **NET** GBE port of the **SCE 2000** platform.
Rx <-> Tx
- Step 5** Power up the **SCE 2000** platform, as explained in [Starting the System and Observing Initial Conditions](#) (on page 7-2).

**Warning**

Auto-Negotiation should be configured identically for the two *SCE 2000* platform GBE interfaces and the GBE interfaces of the switch/router on either side of the External Optical Bypass module. It is recommended that the two GBE interfaces of the *SCE 2000* platform, as well as the GBE interfaces of the switch/router on either side of the External Optical Bypass module, be configured to **Auto-Negotiation = OFF**

Verify that the relevant GBE interfaces of the *SCE 2000* platform are now in sync, as the External Optical Bypass module is now active (in bypass), and is performing a loopback on these interfaces.

- Step 6** Connect the control cable (supplied in the kit) from the **Bypass** 9-pin D-Type connector on the rear panel of the *SCE 2000* platform to the **Control** connector on the External Optical Bypass module.

The *SCE 2000* platform immediately starts providing power to the External Optical Bypass module, so the bypass module becomes inactive, and starts transferring the traffic to the *SCE 2000* platform. The “**No Bypass**” LED should therefore be lit.

The figure below illustrates the connections between a *SCE 2000* platform and two External Optical Bypass modules.

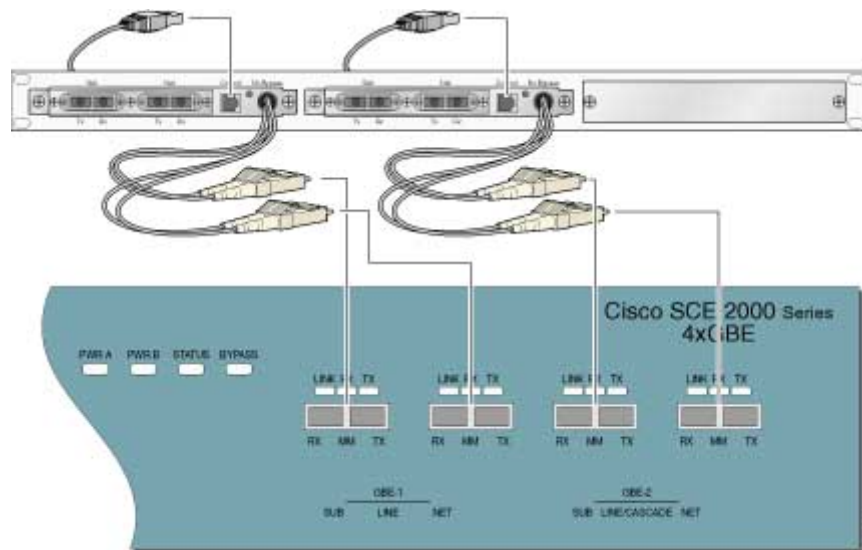

Specifications

Item	Value
Optical Connectors	SC
Switching Speed	15 ms max
Operating Wavelength	<ul style="list-style-type: none"> • Multi Mode: 850 nm • Single Mode: 1310 nm
Operating Temperature	-10° C to +65° C (14° F to 149° F)
Storage Temperature	-30° C to +70° C (-22° F to 158° F)
Weight	12 oz (340 g)

Table A-1 Control cable pinouts

Function	Pin (D-type side)	Pin (RJ-45 side)
Bypass Present (common to 2)	1	1
Bypass Present (common to 1)	2	2
GND	3	3
GND	4	4
+5V	5	5
+5V	6	6
--	7-NC	7
--	8-NC	8
--	9-NC	--
Shield	Shield	Shield

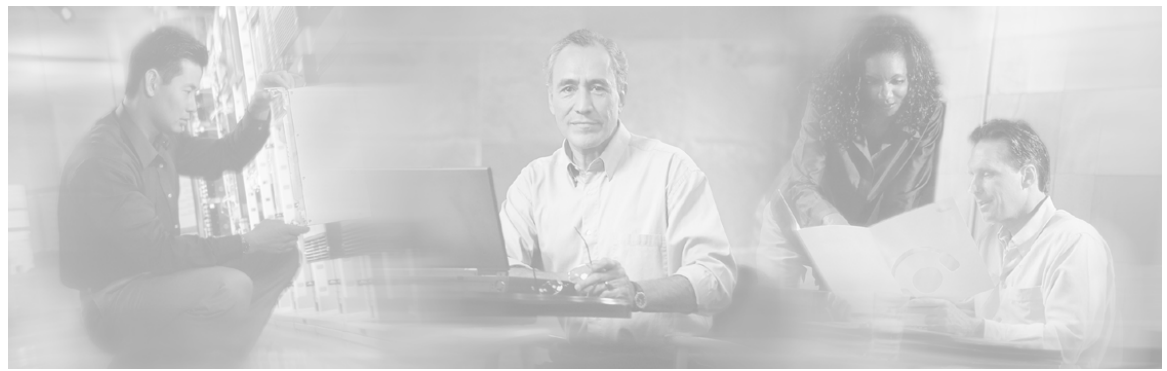

Index

A

- Airflow • 4-3
- Attaching a Chassis Ground Connection • 4-10
- Attaching the Brackets to the SCE 2000 • 4-7
- Attaching the Crossrail Supports to the Rack • 4-8
- Audience • v

B

- Back Panel • 2-4
- Basic SCE 2000 Platform Operations • 7-1
- Bypass Mechanism • 3-3

C

- Cabling Diagrams • 6-2
- Cabling the External Optical Bypass Module • A-4
- Cabling the GBE Port • 6-8
- Cabling the Line Ports and Completing the Installation • 6-1
- Cabling the Management Port • 5-25
- Check the LEDs • 8-7
- Checking Conditions Prior to System Startup • 7-1
- Checking the Shipping Container Contents • 2-5
- Cisco Service Control Capabilities • 1-2
- Cisco.com • x
- Clearing the User Log • 8-6
- CLI Commands • 6-11
- CLI Commands for Troubleshooting • 8-3
- Collection • 1-5
- Configuring the Connection Mode • 6-12
- Configuring the GBE Interface Parameters • 6-6

- Configuring the Gigabit Ethernet Line Interfaces • 6-7
- Connecting the GBE Line Interface Ports • 6-7
- Connecting the line ports to the network • 6-1
- Connecting the Local Console • 5-1
- Connecting the Management Interface • 5-25
- Connecting the Management Interfaces and Performing Initial System Configuration • 5-1
- Connection Mode Parameter • 3-9
- Contacting TAC by Telephone • xi
- Contacting TAC by Using the Cisco TAC Website • xi
- Conventions • vii
- Copying the User Log • 8-5

D

- Document Revision History • v
- Documentation CD-ROM • ix
- Documentation Feedback • x
- Dual link
 - Inline Installation • 3-5
- Dual Link
 - Receive-Only Topology • 3-7
 - Single SCE 2000 Topologies • 6-3
 - Two SCE 2000s Topology • 6-5

E

- Entry Formats • 5-12
- Examining the LEDs • 6-9
- External Optical Bypass Functionality • A-2

F

- Fan Module Overview • 4-20
- Fiber Specifications • 6-7
- Final Tests • 7-3

Front Panel • 2-2
 Functionality • 3-2

G

Generating a File for Technical Support • 8-7

I

Identifying Startup Problems • 8-8
 Initial System Configuration • 5-3
 Installation and Maintenance • 4-1
 Installation Precautions • 4-5
 Installing a Cascaded System • 6-10
 Installing the External Bypass Module • A-3
 Installing the Module in a Rack • A-4
 Installing the SCE 2000 on a Workbench or Tabletop • 4-5
 Installing the SCE 2000 Platform • 4-4
 Introduction to the SCE Platform • 2-1

L

LEDs • 4-13
 Link Continuity • 3-3
 Link Mode • 6-13
 Loading and Activating a Service Control Application • 6-14

M

Maintaining the Network Links vs Maintaining SCE 2000 Platform Functionality • 3-3
 Management and Collection • 1-4
 Managing SCE 2000 Configurations • 7-4
 Monitoring the System • 6-14
 Mounting the System to the Rack • 4-9

N

Network Management • 1-5
 Number of links • 3-2

O

Obtaining Documentation • ix
 Obtaining Technical Assistance • x
 On-Failure Mode Parameter • 3-10
 Order of Entries • 5-13
 Ordering Documentation • ix
 Organization • vi
 Overview • 1-1

P

Performing Complex Configurations • 7-9
 Physical Topologies • 3-4
 Physically Connected Links Parameter • 3-10
 Power Supply Overview • 4-12
 Power Supply Specifications • 4-14
 Powering Down a DC-Input Power Supply Unit and Removing the DC-Input Leads • 4-16
 Powering Down an AC-Input Power Supply • 4-15
 Powering Down the Power Supply Unit and Disconnecting Input Power • 4-15
 Preface • v
 Preparing to Install the SCE 2000 Platform • 4-1
 Priority • 3-10
 Problem Solving Using a Subsystems Approach • 8-8

R

Rack-Mounting a SCE 2000 Platform • 4-6
 Rebooting and Shutting Down the SCE Platform • 7-9
 Rebooting the SCE Platform • 7-9
 Reconnecting AC-Input Power Supply Unit • 4-18
 Reconnecting DC-Input Power Supply Unit • 4-19
 Reconnecting the Power • 4-17
 Recovering a Previous Configuration • 7-8
 Redundancy • 3-2
 Related Publications • vii
 Removing and Replacing a Power Supply Unit • 4-14
 Removing and Replacing the Fan Module • 4-20
 Removing the Fan Module • 4-21
 Removing the Power Supply Unit • 4-16
 Replacing the Battery • 4-22
 Replacing the Fan Module • 4-21
 Replacing the Power Supply Unit • 4-17

S

Saving the Configuration Settings • 7-6
 SCE 2000 Component List • 2-6
 SCE 2000 Configuration • 3-9
 SCE 2000 Installation Checklist • 2-7

- SCE 2000 Operational Status • 8-7
 - Service Configuration Management • 1-5
 - Service Control and the SCE Platform • 2-1
 - Service Control for Broadband Service Providers • 1-2
 - Setting Up the Local Console • 5-2
 - Setup Command Parameters • 5-3
 - Shutting Down the SCE Platform • 7-10
 - Single Link
 - Inline Topology • 3-4, 6-2
 - Receive-only Topology • 3-6, 6-3
 - Single SCE 2000 Topologies • 3-4
 - Site Requirement Guidelines • 4-3
 - Site Requirements • 4-3
 - Specifications • A-7
 - Starting the SCE 2000 Platform • 7-1
 - Starting the System and Observing Initial Conditions • 7-2
 - Step 1
 - Configuring Initial Settings • 5-6
 - Step 10
 - Completing and Saving the Configuration • 5-22
 - Step 2
 - Configuring the Hostname • 5-7
 - Step 3
 - Setting the Passwords • 5-7
 - Step 4
 - Configuring Time Settings • 5-8
 - Step 5
 - Configuring the DNS Settings • 5-10
 - Step 6
 - Configuring the RDR Formatter Destination • 5-11
 - Step 7
 - Configuring Access Control Lists (ACLs) • 5-12
 - Step 8
 - Configuring SNMP • 5-16
 - Step 9
 - Configuring the Topology-Dependent Parameters • 5-18
 - Subscriber Management • 1-5
- T**
- Technical Assistance Center • x
 - Testing Connectivity
 - Examining Link LEDs and Counters • 6-9
 - The Cisco Service Control Concept • 1-1
 - The External Optical Bypass Module • A-1
 - The External Optical Bypass Module Front Panel • A-3
 - The Logging System • 8-4
 - The SCE 2000 Platform • 3-1
 - The SCE Platform • 1-3
 - The User Log • 8-4
 - Tools and Parts Required • 4-2
 - Topology • 3-1
 - Topology Considerations • 3-1
 - Topology-Related Parameters • 3-9
 - Topology-Related Parameters for Redundant Topologies • 6-11
 - Troubleshooting • 8-1
 - Troubleshooting Overview • 8-1
 - Troubleshooting the Firmware Package Installation • 8-11
 - Troubleshooting the Link Interface Subsystem • 8-14
 - Troubleshooting the Management Subsystem • 8-12
 - Troubleshooting the Power Subsystem • 8-9
 - Troubleshooting Tools • 8-2
 - Two Cascaded SCE 2000s
 - Inline Topology • 3-8
 - Two Cascaded SCE 2000s For Dual Links • 3-8
- V**
- Verifying Management Interface Connectivity • 5-26
 - Verifying Operational Status • 7-3
 - Viewing Configuration • 7-4
 - Viewing the Counters to Verify that the Network Traffic is Reaching the Device • 6-9
 - Viewing the User Log • 8-5
 - Viewing the User Log Counters • 7-3, 8-6
- W**
- World Wide Web • ix

Free Manuals Download Website

<http://myh66.com>

<http://usermanuals.us>

<http://www.somanuals.com>

<http://www.4manuals.cc>

<http://www.manual-lib.com>

<http://www.404manual.com>

<http://www.luxmanual.com>

<http://aubethermostatmanual.com>

Golf course search by state

<http://golfingnear.com>

Email search by domain

<http://emailbydomain.com>

Auto manuals search

<http://auto.somanuals.com>

TV manuals search

<http://tv.somanuals.com>