

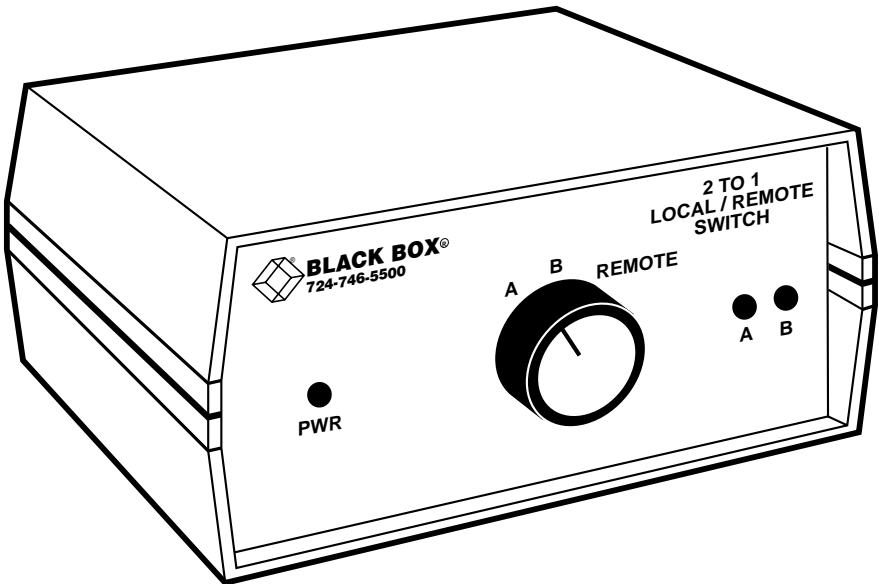

Local/Remote Electronic Switches



**CUSTOMER
SUPPORT
INFORMATION**

Order toll-free in the U.S. 24 hours, 7 A.M. Monday to midnight Friday: **877-877-BBOX**
FREE technical support, 24 hours a day, 7 days a week: Call **724-746-5500** or fax **724-746-0746**
Mail order: **Black Box Corporation**, 1000 Park Drive, Lawrence, PA 15055-1018
Web site: www.blackbox.com • E-mail: info@blackbox.com

FEDERAL COMMUNICATIONS COMMISSION AND INDUSTRY CANADA RADIO-FREQUENCY INTERFERENCE STATEMENTS

This equipment generates, uses, and can radiate radio frequency energy and if not installed and used properly, that is, in strict accordance with the manufacturer's instructions, may cause interference to radio communication. It has been tested and found to comply with the limits for a Class A computing device in accordance with the specifications in Subpart J of Part 15 of FCC rules, which are designed to provide reasonable protection against such interference when the equipment is operated in a commercial environment. Operation of this equipment in a residential area is likely to cause interference, in which case the user at his own expense will be required to take whatever measures may be necessary to correct the interference.

Changes or modifications not expressly approved by the party responsible for compliance could void the user's authority to operate the equipment.

This digital apparatus does not exceed the Class A limits for radio noise emission from digital apparatus set out in the Radio Interference Regulation of Industry Canada.

Le présent appareil numérique n'émet pas de bruits radioélectriques dépassant les limites applicables aux appareils numériques de la classe A prescrites dans le Règlement sur le brouillage radioélectrique publié par Industrie Canada.

EUROPEAN UNION DECLARATION OF CONFORMITY

This equipment complies with the requirements of the European EMC Directive 89/336/EEC.

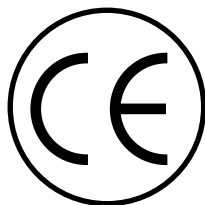

**NORMAS OFICIALES MEXICANAS (NOM)
ELECTRICAL SAFETY STATEMENT****INSTRUCCIONES DE SEGURIDAD**

1. Todas las instrucciones de seguridad y operación deberán ser leídas antes de que el aparato eléctrico sea operado.
2. Las instrucciones de seguridad y operación deberán ser guardadas para referencia futura.
3. Todas las advertencias en el aparato eléctrico y en sus instrucciones de operación deben ser respetadas.
4. Todas las instrucciones de operación y uso deben ser seguidas.
5. El aparato eléctrico no deberá ser usado cerca del agua—por ejemplo, cerca de la tina de baño, lavabo, sótano mojado o cerca de una alberca, etc.
6. El aparato eléctrico debe ser usado únicamente con carritos o pedestales que sean recomendados por el fabricante.
7. El aparato eléctrico debe ser montado a la pared o al techo sólo como sea recomendado por el fabricante.
8. Servicio—El usuario no debe intentar dar servicio al equipo eléctrico más allá a lo descrito en las instrucciones de operación. Todo otro servicio deberá ser referido a personal de servicio calificado.
9. El aparato eléctrico debe ser situado de tal manera que su posición no interfiera su uso. La colocación del aparato eléctrico sobre una cama, sofá, alfombra o superficie similar puede bloquea la ventilación, no se debe colocar en libreros o gabinetes que impidan el flujo de aire por los orificios de ventilación.
10. El equipo eléctrico deber ser situado fuera del alcance de fuentes de calor como radiadores, registros de calor, estufas u otros aparatos (incluyendo amplificadores) que producen calor.
11. El aparato eléctrico deberá ser conectado a una fuente de poder sólo del tipo descrito en el instructivo de operación, o como se indique en el aparato.

12. Precaución debe ser tomada de tal manera que la tierra física y la polarización del equipo no sea eliminada.
13. Los cables de la fuente de poder deben ser guiados de tal manera que no sean pisados ni pellizcados por objetos colocados sobre o contra ellos, poniendo particular atención a los contactos y receptáculos donde salen del aparato.
14. El equipo eléctrico debe ser limpiado únicamente de acuerdo a las recomendaciones del fabricante.
15. En caso de existir, una antena externa deberá ser localizada lejos de las líneas de energía.
16. El cable de corriente deberá ser desconectado del cuando el equipo no sea usado por un largo periodo de tiempo.
17. Cuidado debe ser tomado de tal manera que objetos líquidos no sean derramados sobre la cubierta u orificios de ventilación.
18. Servicio por personal calificado deberá ser provisto cuando:
 - A: El cable de poder o el contacto ha sido dañado; u
 - B: Objetos han caído o líquido ha sido derramado dentro del aparato; o
 - C: El aparato ha sido expuesto a la lluvia; o
 - D: El aparato parece no operar normalmente o muestra un cambio en su desempeño; o
 - E: El aparato ha sido tirado o su cubierta ha sido dañada.

TRADEMARKS USED IN THIS MANUAL

Any trademarks used in this manual are acknowledged to be the property of the trademark owners.

Contents

Chapter	Page
1. Specifications	5
2. Introduction	7
3. Installation and Configuration	8
3.1 Before You Install	8
3.2 The Setup Procedure	9
4. Operation	17
4.1 Local Switching	17
4.1.1 ABC and ABCDE Switches (SW980 and SW982 Units)	17
4.1.2 X Switches (SW981 Units)	18
4.2 Remote Switching	19
4.2.1 ABC and ABCDE Switches (SW980 and SW982 Units)	19
4.2.2 X Switches (SW981 Units)	19
4.3 Test Results	22
5. Troubleshooting	23
5.1 Calling Black Box	23
5.2 Shipping and Packaging	23

1. Specifications

Compliance —	FCC Part 15 Subpart J Class A, IC Class/class A
Data Rate —	Up to 256 kbps typical; higher speeds possible with careful consideration of cabling and equipment requirements
User Controls —	All models: Remote switching either through TTL, RS-232, RS-422/485, or other active drivers or through dry-contact closure; SW980 and SW982 models: (1) Rear-mounted 2-position DIP switch for grounding; SW981 models: (2) Rear-mounted 2-position DIP switches for grounding
Indicators —	Front-mounted LEDs: All models: (1) for Power; SW980 models: (2) for Active Port; SW981 models: (1) for Straight, (1) for Crossed; SW982 models: (4) for Active Port
Connectors —	All models: (1) Rear-mounted RJ-45 female, (1) Internal 4-position terminal block; SW980 models: (3) Rear-mounted DB25 female; SW981 models: (4) Rear-mounted DB25 female; SW982 models: (5) Rear-mounted DB25 female
Leads Supported —	DB25: All
Signal Levels —	Between ± 15 VDC maximum for all leads
“On” Resistance Through Switch —	SW980 and SW981 models: 35 ohms maximum, 22 ohms typical; SW982 models: 100 ohms maximum, 40 ohms typical
Port-to-Port Switching Speed Using Remote Inputs —	Less than 1 μ s

LOCAL/REMOTE ELECTRONIC SWITCHES

Remote Input Logic Levels —

V_{IH} greater than 2.5 volts, maximum +15 volts;
 V_{IL} less than 0.5 volts, minimum -15 volts

NOTE

For dry-contact operation, the total external-connection DC resistance must be less than 240 ohms when the dry contact is closed for the Local/Remote Electronic Switch to correctly read this condition as a “low” input.

Power —

SW980A, SW981A, SW982A:
From wallmount power supply PS154:
Input: 120 VAC, 60 Hz;
Output: 17 VAC CT;
SW980AE, SW981AE, SW982AE:
From wallmount power supply PS154E:
Input: 230 VAC, 50 Hz;
Output: 17 VAC CT;
Consumption: 1 watt

MTBF —

65,000 hours

Operating Temperature —

32 to 140°F (0 to 60°C)

Storage Temperature —

-4 to +158°F (-20 to +70°C)

Humidity —

Up to 95% noncondensing

Enclosure —

High-impact plastic

Size —

SW980 and SW981 models: 2.5"H x 6"W x 6.3"D
(6.4 x 15.2 x 16 cm);
SW982 models: 3.5"H x 6"W x 6.3"D
(8.9 x 15.2 x 16 cm)

Weight —

1.5 lb. (0.7 kg)

2. Introduction

Switching between data lines manually can often damage the connected equipment, because this relatively slow and imprecise action can cause data-line surges and spikes large enough to damage today's sensitive circuitry. With the Local/Remote Electronic Switches, you can eliminate this potential hazard. Their electronic switching action provides surgeless, spikeless changeovers—something a mechanical switch just can't do.

In addition, these switches can be controlled remotely, from a convenient out-of-sight location.

The stock models available are:

SW980A	115-VAC 2-to-1 Switch
SW980AE	230-VAC 2-to-1 Switch
SW981A	115-VAC "X" (2-to-2) Switch
SW981AE	230-VAC "X" (2-to-2) Switch
SW982A	115-VAC 4-to-1 Switch
SW982AE	230-VAC 4-to-1 Switch

These Switches can also be cascaded to allow a larger number of ports to be switched.

3. Installation and Configuration

3.1 Before You Install

Check the box and its contents before you begin installing your Local/Remote Electronic Switch. You should have received one Switch unit, one AC power supply, and one copy of this manual. If you didn't receive all of these items, or if they have sustained damage that does not seem to be shipping-related, notify Black Box right away. If they have sustained impact or water damage that seems to have happened during shipping, notify both Black Box and the shipping carrier immediately.

Unpack the box carefully. We recommend that you save the original container and its packing materials in case you need to ship the Switch later.

You'll need to install the Switch within 6 feet (1.8 m) of an AC outlet. Also, keep the Switch away from water and extreme temperatures.

Make sure you have the proper cables or adapters. Whatever interface you want to switch (RS-232, RS-422, RS-485, V.35, TTL, etc.), you must use either cables with DB25 male connectors or adapters that convert the interface from your cables' connectors to DB25 male connectors. To perform remote switching, you must use an appropriate length of cable that has at least four wires. If you intend to connect it to the Switch's internal terminal block, this cable must be unterminated at the Switch end. If you intend to connect it to the Switch's "REMOTE" connector, this cable must have wires pinned to Pins 3 through 6 of a male RJ-45 connector at the Switch end. (If you must use existing cables that do not meet these requirements, call Black Box Technical Support; we might be able to provide adapters or create a special product for you.)

3.2 The Setup Procedure

Installing and configuring a Local/Remote Electronic Switch is relatively quick and easy, and will vary only slightly depending on which model you've chosen. Follow these steps:

(Steps 1 through 4 are for *remotely switched applications* only.)

1. Make sure that the Switch is unplugged (is not receiving AC power). Open the Switch by unscrewing the two screws on the bottom of the unit (save these screws) and removing the top of the unit's housing. (You will probably have to peel back the CE sticker on the bottom of the unit to get at one of the screws.)
2. Find jumper W1 (for SW980 or SW981 units) or jumpers W2 and W3 (for SW982 units) on the Switch's circuit board. Refer to **Figure 3-1** on the next page if your unit is an SW980 model, to **Figure 3-2** on page 11 if your unit is an SW981 model, or to **Figure 3-3** on page 12 if your unit is an SW982 model. Set the jumper(s) as appropriate for your application:
 - Set W1, or W2 and W3, to the A-B position for applications that use dry-contact closure to perform remote switching.
 - Set W1, or W2 and W3, to the B-C position for applications that use active driver(s) to perform remote switching.

(text continued on page 13)

LOCAL/REMOTE ELECTRONIC SWITCHES

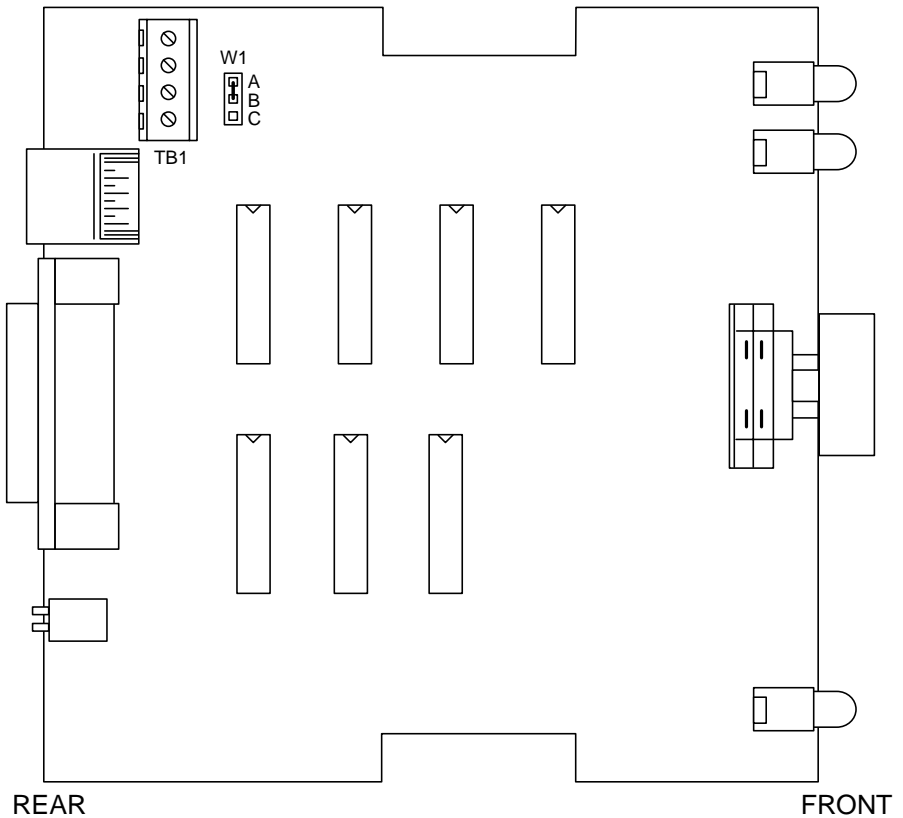

Figure 3-1. PCB layout of the SW980 models.

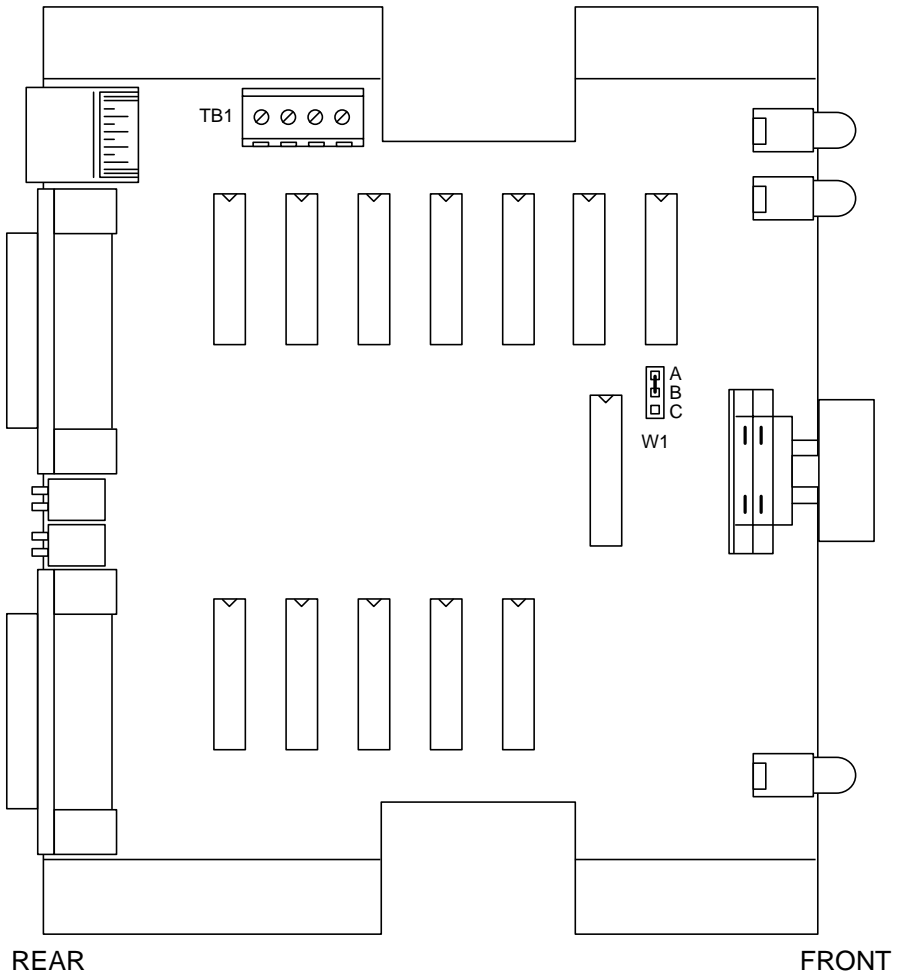

Figure 3-2. PCB layout of the SW981 models.

LOCAL/REMOTE ELECTRONIC SWITCHES

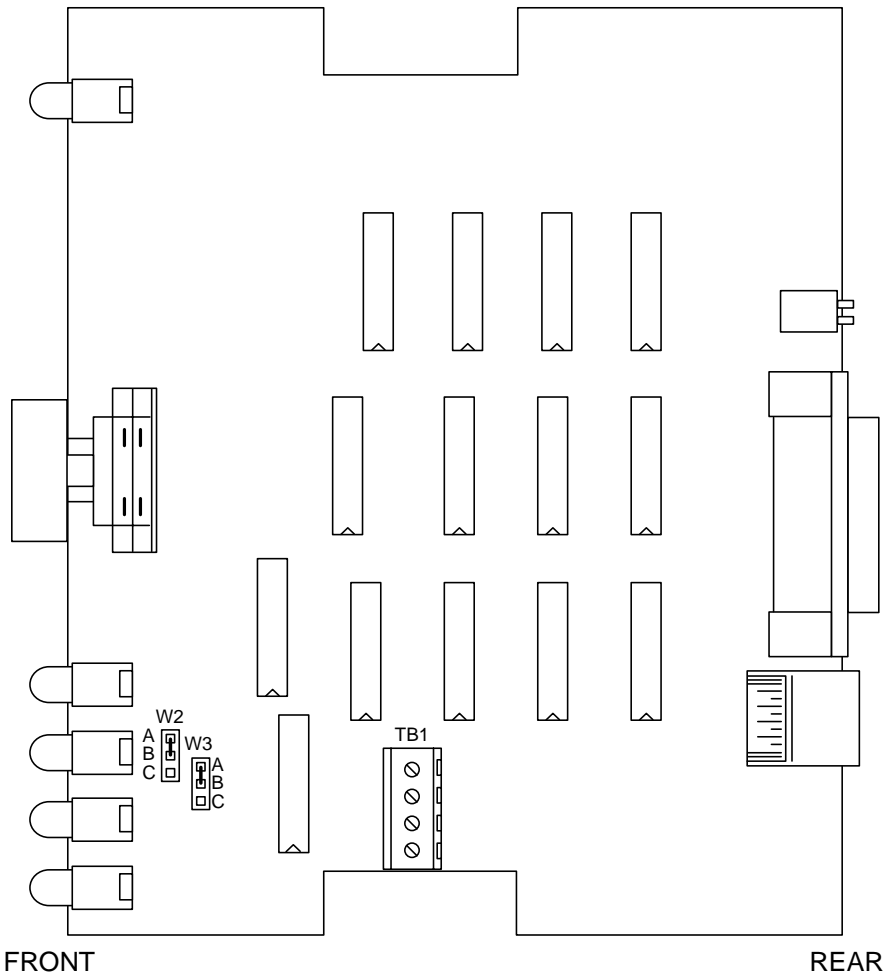

Figure 3-3. PCB layout of the SW982 models.

(text continued from page 9)

3. If you will be performing remote switching using a cable that is unterminated at the Switch end, attach the cable's wires to the appropriate positions of the 4-position terminal block labeled "TB1" (refer to **Figures 3-1** through **3-3** on pages 10 through 12 and to **Tables 4-1** and **4-2** on pages 20 and 21). Connect the ground of the remote driver, or one side of the dry contact, to (either of) the terminal block's ground pin(s). Connect the remote driver's output(s), or the other side of the dry contact, to the terminal block's input pin(s).
4. Close the Switch's housing and screw the two screws you removed in step 1 back in. If you are using a remote-switching cable that is unterminated at the Switch end, make sure that the cable is seated in the slot on the left side of the Switch's rear panel before you put the cover back on.

(The installation procedure for *locally switched applications* begins with Step 5:)

5. Find DIP switch S2 (for SW980 and SW982 units) or DIP switches S2 and S3 (for SW981 units) on the Switch's rear panel. Refer to **Figure 3-4** below or **Figure 3-5** or **3-6** on the next page, which show the rear panels of the SW980, SW981, and SW982 models respectively.

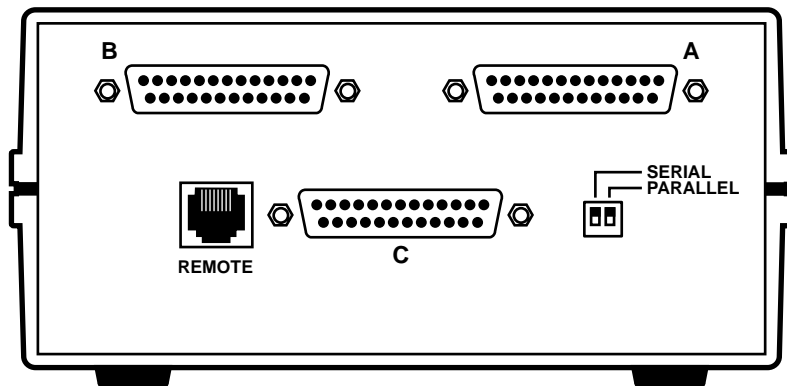

Figure 3-4. Rear panel of the SW980 models.

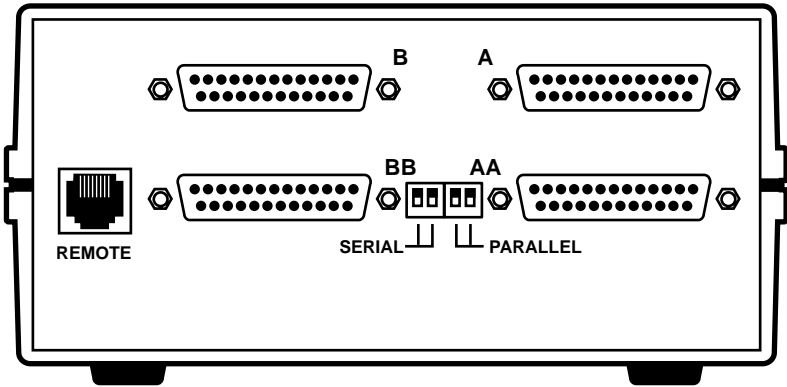

Figure 3-5. Rear panel of the SW981 models.

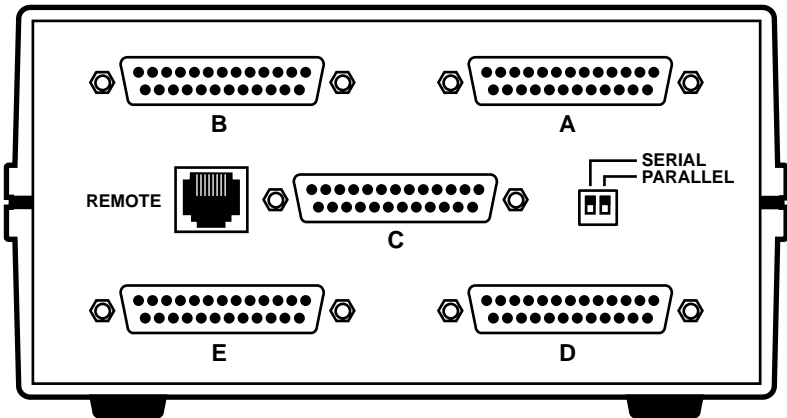

Figure 3-6. Rear panel of the SW982 models.

6. Set the DIP switch(es) as appropriate for your application. Refer to Table 3-1 and **Figure 3-7** below, and keep in mind that OFF = UP and ON = DOWN.

Table 3-1. Possible Settings for Switches S2 and S3

All 25 leads of the Local/Remote Electronic Switch's DB25 connectors are straight-through and are isolated from one another. In RS-232 and DB25 parallel applications, we recommend that you use DIP switches S2 and S3 to make a "common" ground connection; this will help eliminate intermittent noise problems.

Recommended Settings for RS-232 Applications:

Model(s)	S2		S3		Connection(s) Made
	Pos. 1	Pos. 2	Pos. 1	Pos. 2	
SW980/982 units	ON (down)	OFF (up)	N/A	N/A	Port C Pin 7 to Switch ground
SW981 units	ON (down)	ON (down)	OFF (up)	OFF (up)	Ports AA and BB Pin 7 to Switch ground

Recommended Settings for DB25 Parallel Applications:

Model(s)	S2		S3		Connection(s) Made
	Pos. 1	Pos. 2	Pos. 1	Pos. 2	
SW980/982 units	OFF (up)	ON (down)	N/A	N/A	Port C Pin 18 to Switch ground
SW981 units	OFF (up)	OFF (up)	ON (down)	ON (down)	Ports AA and BB Pin 18 to Switch ground

Recommended Settings for Other Applications:

All models—Set all positions of switches S2 [and S3] to OFF (up).

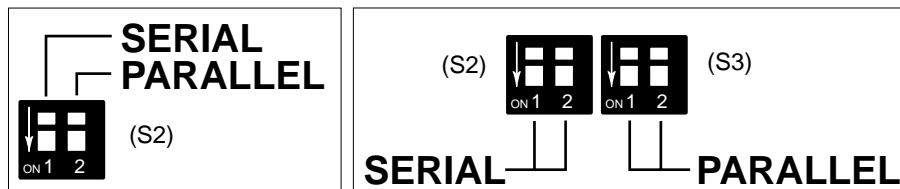

Figure 3-7. DIP switch S2 of the SW980 and SW982 models (left) and DIP switches S2 and S3 of the SW981 models (right).

LOCAL/REMOTE ELECTRONIC SWITCHES

7. Put the Switch in the site you've selected.
8. Shut off the equipment you plan to connect to the Switch.
- 9A. *SW980 and SW982 units only:* Connect the cable from the "common" device (the one that's going to access—or be shared by—the other devices) to the common connector (marked "C") on the Switch's rear panel. Connect the cables from the "branch" devices (those that will share—or be intermittently accessed by—the other device) to the branch connectors (marked "A" and "B" [and "D" and "E" on the SW982]) on the Switch's rear panel.
- 9B. *SW981 units only:* Connect the cables from the two "source" devices to the connectors on the Switch's rear panel labeled "A" and "B." Connect the cables from the "destination" devices to the connectors on the Switch's rear panel labeled "AA" and "BB."
10. *Remotely switched applications using terminated cable only:* Plug the cable's RJ-45 plug into the connector marked "REMOTE" on the Switch's rear panel. Make sure that the appropriate wires are attached to the appropriate pins in the RJ-45 plug (refer to **Tables 4-1** and **4-2** on pages 20 and 21). The ground of the remote driver, or one side of the dry contact, must be connected to the connector's ground pin. The remote driver's output(s), or the other side of the dry contact, must be connected to the connector's input pin(s).
11. Plug the Switch's power supply into an AC outlet.
12. Turn on the attached equipment.

Your Local/Remote Electronic Switch should now be ready for continuous operation, but test it to make sure it has been installed properly. See **Chapter 4**.

4. Operation

4.1 Local Switching

4.1.1 ABC AND ABCDE SWITCHES (SW980 AND SW982 UNITS)

Refer to Figure 4-1 below: Test your Local/Remote Electronic Switch system by having the common device send data to, or receive data from, branch devices “A” and “B” (and, for SW982 units, “D” and “E”), one after the other. Switch between branch devices by manually turning the knob on the Switch’s front panel.

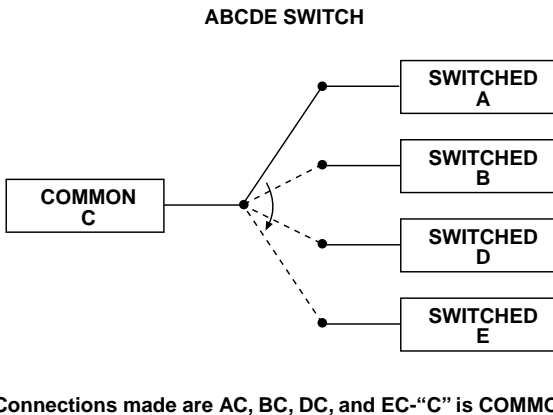
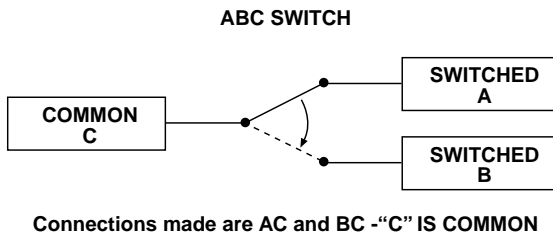
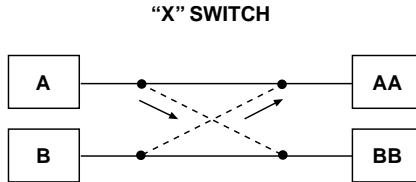

Figure 4-1. Switching in the SW980 (top) and SW982 (bottom) models.

LOCAL/REMOTE ELECTRONIC SWITCHES

4.1.2 X SWITCHES (SW981 UNITS)

Refer to **Figure 4-2** below: Test your Local/Remote Electronic Switch system by having each source device ("A" and "B") send data to each destination device ("AA" and "BB"), one after the other. Switch between data pathways by manually turning the knob on the Switch's front panel.



Connections made are A-AA & B-BB or A-BB & B-AA

Figure 4-2. Switching in the SW981 models.

4.2 Remote Switching

When you do remote switching, keep these things in mind:

- The knob on the Switch's front panel must be in the "REMOTE" position.
- The Switch interprets any voltage more negative than approximately 1.4 volts as a "low" and any voltage more positive than approximately 1.4 volts as a "high" (see the "Remote Input Logic Levels" spec in **Chapter 1** for maximum and minimum switching points).
- In dry-contact applications, the Switch will read a "low" when the contact is closed and a "high" when the contact is open.
- The maximum allowed voltage on the remote-input leads is ± 15 volts.

4.2.1 ABC AND ABCDE SWITCHES (SW980 AND SW982 UNITS)

To test the remote-switching capability of your Local/Remote Electronic Switch system, you must first turn the knob on the Switch's front panel to "REMOTE." Now have the common device send data to, or receive data from, branch devices "A" and "B" (and, for SW982 units, "D" and "E"), one after the other. Switch between branch devices by sending "high" and "low" electric signals to the Switch through its RJ-45 connector or its internal 4-position terminal block. See **Tables 4-1** and **4-2** on pages 20 and 21 for pinouts and signal levels; see **Figure 4-1** on page 17 for basic illustrations of how the Switches function.

4.2.2 X SWITCHES (SW981 UNITS)

To test the remote-switching capability of your Local/Remote Electronic Switch system, you must first turn the knob on the Switch's front panel to "REMOTE." Now have each source device ("A" and "B") send data to each destination device ("AA" and "BB"), one after the other. Switch between data pathways by sending "high" and "low" electric signals to the Switch through its RJ-45 connector or its internal 4-position terminal block. See **Table 4-1** on the next page for pinouts and signal levels; see **Figure 4-2** on the previous page for a basic illustration of how the Switch functions.

Table 4-1. Connector Pinouts and Signal Levels for Port Selection with the ABC Switch (SW980 Models) or Path Selection with the X Switch (SW981 Models)

Pinout of the RJ-45 Connector

1	N/C
2	N/C
3	N/C
4	Remote input
5	+5 VDC output
6	Signal ground
7	N/C
8	N/C

Pinout of the 4-Position Terminal Block

1	Signal ground
2	N/C
3	Remote input
4	Signal ground

Signal Levels for Port Selection (SW980 Models)

<i>Port Selected</i>	<i>Remote Input</i>
A	High
B	Low

Signal Levels for Path Selection (SW981 Models)

<i>Paths Selected</i>	<i>Remote Input</i>
A to AA, B to BB (straight)	High
B to AA, A to BB (crossed)	Low

Table 4-2. Connector Pinouts and Signal Levels for Port Selection with the ABCDE Switch (SW982 Models)

Pinout of the RJ-45 Connector

1	N/C
2	Reserved for future use
3	Remote input B
4	Remote input A
5	+5 VDC output
6	Signal ground
7	N/C
8	N/C

Pinout of the 4-Position Terminal Block

1	Signal ground
2	Remote input B
3	Remote input A
4	Reserved for future use

Signal Levels for Port Selection

<i>Port Selected</i>	<i>Remote Input A</i>	<i>Remote Input B</i>
A	High	High
B	Low	High
D	High	Low
E	Low	Low

4.3 Test Results

If data doesn't seem to be getting through when a device on one side of the Switch is connected to a device on the other side of the Switch, make sure that:

- Both devices are turned on and receiving power.
- The Switch is receiving power (its "POWER" LED should be lit).
- The Switch's front-panel knob is set properly.
- All cables are good and cable connections are secure.
- Any software involved is configured and operating correctly.

If your Switch is working properly, your system is ready to go. If the Switch fails the test, or if it should begin malfunctioning later, contact Black Box Technical Support (see **Chapter 5**).

5. Troubleshooting

5.1 Calling Black Box

If you determine that your Local/Remote Electronic Switch is malfunctioning, *do not attempt to alter or repair the unit*. It contains no user-serviceable parts. Call Black Box Technical Support at 724-746-5500.

Before you do, make a record of the history of the problem. We will be able to provide more efficient and accurate assistance if you have a complete description, including:

- the nature and duration of the problem;
- when the problem occurs;
- the components involved in the problem;
- any particular application that, when used, appears to create the problem or make it worse; and
- the results of any testing you've already done.

5.2 Shipping and Packaging

If you need to transport or ship your Local/Remote Electronic Switch:

- Package it carefully. We recommend that you use the original container.
- If you are returning the Switch, please include everything you received with it. If you are shipping the Switch for repair or return, contact Black Box to get a Return Authorization (RA) number.

NOTES



© Copyright 2000. Black Box Corporation. All rights reserved.

1000 Park Drive • Lawrence, PA 15055-1018 • 724-746-5500 • Fax 724-746-0746

Free Manuals Download Website

<http://myh66.com>

<http://usermanuals.us>

<http://www.somanuals.com>

<http://www.4manuals.cc>

<http://www.manual-lib.com>

<http://www.404manual.com>

<http://www.luxmanual.com>

<http://aubethermostatmanual.com>

Golf course search by state

<http://golfingnear.com>

Email search by domain

<http://emailbydomain.com>

Auto manuals search

<http://auto.somanuals.com>

TV manuals search

<http://tv.somanuals.com>