



BLACK & DECKER

NO. 3027-09 & 3027-90

7 $\frac{1}{4}$ " SAWCAT[®] CIRCULAR SAW

Featuring:

- 1) Double Insulated construction with 3-wire, grounding 10 foot rubber power cord.
- 2) Motor brushes are easily serviced.
- 3) Good visibility of blade and cutting line from operating position. Adjustable cutting guide.
- 4) Rolled edge on shoe facilitates using guide strip for accurate cutting.
- 5) Knobs control bevel and cutting depth adjustments.
- 6) Enclosed lower guard return spring. Separate, removable switch handle, if replacement ever needed.

MAXIMUM CUTTING DEPTH at 90°—2 $\frac{1}{8}$ " ; at 45°—1 $\frac{7}{8}$ "

120 Volts, 10 Amps.

5500 R.P.M.

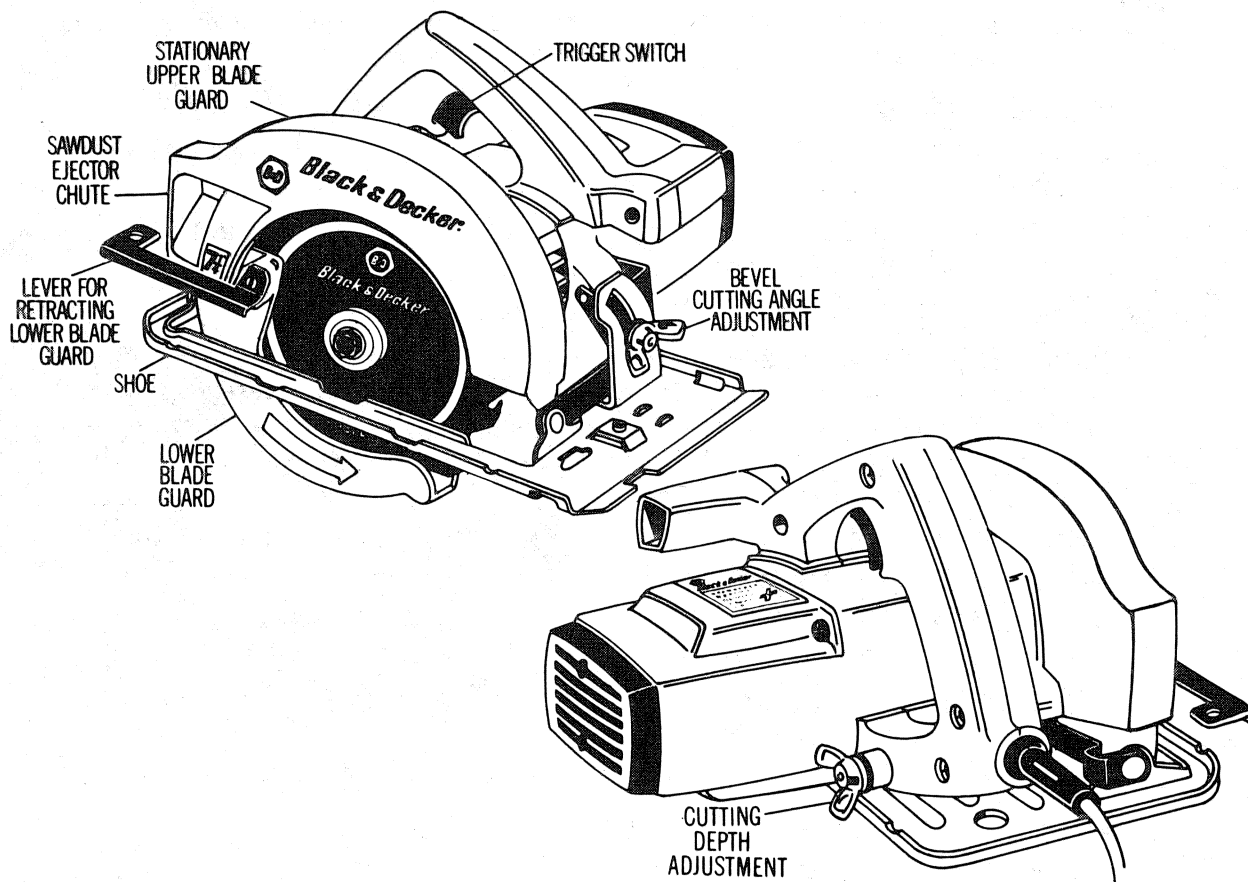

INSTRUCTION MANUAL

IMPORTANT SAFETY INSTRUCTIONS

WARNING: When using Electric Tools, basic safety precautions should always be followed to reduce risk of fire, electric shock, and personal injury, including the following:

READ ALL INSTRUCTIONS

1. **KEEP WORK AREA CLEAN.** Cluttered areas and benches invite injuries.
2. **CONSIDER WORK AREA ENVIRONMENT.** Don't expose power tools to rain. Don't use power tools in damp or wet locations. Keep work area well lit.
3. **GUARD AGAINST ELECTRIC SHOCK.** Prevent body contact with grounded surfaces. For example: pipes, radiators, ranges, refrigerator enclosures.
4. **KEEP CHILDREN AWAY.** All visitors should be kept away from work area. Do not let visitors contact tool or extension cord.
5. **STORE IDLE TOOLS.** When not in use, tools should be stored in dry, and high or locked-up place—out of reach of children.
6. **DON'T FORCE TOOL.** It will do the job better and safer at the rate for which it was intended.
7. **USE RIGHT TOOL.** Don't force small tool or attachment to do the job of a heavy-duty tool. Don't use tool for purpose not intended, for example, don't use circular saw for cutting tree limbs or logs.
8. **DRESS PROPERLY.** Do not wear loose clothing or jewelry. They can be caught in moving parts. Rubber gloves and non-skid footwear are recommended when working outdoors. Wear protective hair covering to contain long hair.
9. **USE SAFETY GLASSES.** Also use face or dustmask if cutting operation is dusty.
10. **DON'T ABUSE CORD.** Never carry tool by cord or yank it to disconnect from receptacle. Keep cord from heat, oil, and sharp edges.
11. **SECURE WORK.** Use clamps or a vise to hold work. It's safer than using your hand and it frees both hands to operate tool.
12. **DON'T OVERREACH.** Keep proper footing and balance at all time.
13. **MAINTAIN TOOLS WITH CARE.** Keep tools sharp and clean for better and safe performance. Follow instructions for lubricating and changing accessories. Inspect tool cords periodically and if damaged have repaired by authorized service facility. Inspect extension cords periodically and replace if damaged. Keep handles dry, clean, and free from oil and grease.
14. **DISCONNECT TOOLS.** When not in use, before servicing, and when changing accessories, such as blades, bits, cutters.
15. **REMOVE ADJUSTING KEYS AND WRENCHES.** Form habit of checking to see that keys and adjusting wrenches are removed from tool before turning it on.
16. **AVOID UNINTENTIONAL STARTING.** Don't carry plugged-in tool with finger on switch. Be sure switch is off when plugging in.
17. **OUTDOOR USE EXTENSION CORDS.** When tool is used outdoors, use only extension cords intended for use outdoors and so marked.

18. **STAY ALERT.** Watch what you are doing. Use common sense. Do not operate tool when you are tired.
19. **CHECK DAMAGED PARTS.** Before further use of the tool, a guard or other part that is damaged should be carefully checked to determine that it will operate properly and perform its intended function. Check for alignment of moving parts, binding of moving parts, breakage of parts, mounting, and any other conditions that may affect its operation. A guard or other part that is damaged should be properly repaired or replaced by an authorized service center unless otherwise indicated elsewhere in this instruction manual. Have defective switches replaced by Authorized Service Center. Do not use tool if switch does not turn it on and off.
20. **DO NOT OPERATE** portable electric tools near flammable liquids or in gaseous or explosive atmospheres. Motors in these tools normally spark, and the sparks might ignite fumes.

CIRCULAR SAW SAFETY INSTRUCTIONS

1. Disconnect plug from power supply before changing blades, making cutting depth or cutting angle adjustments, inspecting, cleaning or when saw is not used.
2. Keep guards in place and in working order. Never wedge or tie lower guard open. Check operation of lower guard before each use. Do not use if lower guard does not close briskly over saw blade. CAUTION: If saw is dropped, lower guard may be bent, restricting full return.
3. **KEEP BLADES CLEAN AND SHARP.** Sharp blades minimize stalling and kick back.
4. **DANGER: KEEP HANDS AWAY FROM CUTTING AREA.** (See fig. 7) Keep hands away from blades. Do not reach underneath work while blade is rotating. Do not attempt to remove cut material when blade is moving. CAUTION: Blades coast after turn off.
5. **SUPPORT LARGE PANELS.** Large panels must be supported as shown in FIGURE 8 to minimize the risk of blade pinching and kick back. When cutting operation requires the resting of the saw on the work-piece, the saw shall be rested on the larger portion and the smaller piece cut off. (See FIGURE 7)
6. **USE RIP FENCE.** Always use a fence or straight edge guide when ripping.
7. **GUARD AGAINST KICK BACK.** Kick back occurs when the saw stalls rapidly and is driven back towards the operator. Release switch immediately if blade binds or saw stalls. Keep blades sharp. Support large panels as shown in FIGURE 8. Use fence or straight edge guide when ripping. Don't force tool. Stay alert, exercise control. Don't remove saw from work during a cut while the blade is moving.
8. **LOWER GUARD.** Raise lower guard with the retracting handle.
9. **ADJUSTMENTS.** Before cutting be sure depth and bevel adjustments are tight.
10. **USE ONLY CORRECT BLADES IN MOUNTING.** Do not use blades with incorrect size holes. Never use defective or incorrect blade washers or bolts.
11. **AVOID CUTTING NAILS.** Inspect for and remove all nails from lumber before cutting.

SAVE THESE INSTRUCTIONS

GROUNDING

This tool should be grounded while in use to protect the operator from electric shock. The tool is equipped with an approved three-conductor cord and three-prong grounding type plug to fit the proper grounding type receptacle. The green (or green and yellow) conductor in the cord is the grounding wire. Never connect the green (or green and yellow) wire to a live terminal.

If your unit is for use on less than 150 volts, it has a plug like that shown in Figure A. If it is for use on 150 to 250 volts, it has a plug like that shown in Figure D. An adapter, Figures B and C, is available for connecting Figure A plugs to two-prong receptacles. The green-colored rigid ear, lug, etc., must be connected to a permanent ground such as a properly grounded outlet box.

No adapter is available for a plug as shown in Figure D. Adapter shown in Figures B & C is Not for Use in Canada.

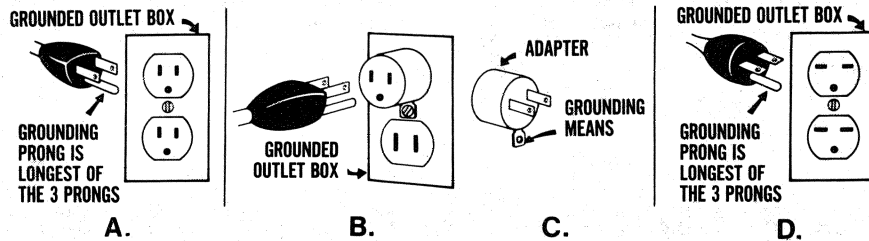

We recommend that you **NEVER** disassemble the tool or try to do any rewiring in the electrical system. Any repairs should be performed only by B&D Service Centers or other qualified service organizations. Should you be determined to make a repair yourself, remember that the green colored wire is the "grounding" wire. Never connect this green wire to a "live" terminal. If you replace the plug on the power cord, be sure to connect the green wire only to the grounding (longest) prong on a 3-prong plug.

SAVE THESE INSTRUCTIONS

EXTENSION CORDS

Tools that have 3 wire cords requiring grounding must only be used with extension cords that have 3-prong grounding type plugs and 3-pole receptacles. Only round jacketed extension cords should be used, and we recommend that they be listed by Underwriters Laboratories (U.L.) (C.S.A. in Canada). If the extension will be used outside, the cord must be suitable for outdoor use. Any cord marked as outdoor can also be used for indoor work.

An extension cord must have adequate wire size (AWG or American Wire Gauge) for safety, and to prevent loss of power and overheating. The smaller the gauge number of the wire, the greater the capacity of the cable, that is 16 gauge has more capacity than 18 gauge. When using more than one extension to make up the total length, be sure each individual extension contains at least the minimum wire size.

To determine the minimum wire size required, refer to the chart below:

NAMEPLATE RATING - AMPS	CHART FOR MINIMUM WIRE SIZE (AWG) OF EXTENSION CORDS							
	TOTAL EXTENSION CORD LENGTH - FEET							
	25	50	75	100	125	150	175	200
0 - 10.0	18	18	16	16	14	14	12	12
10.1 - 13.0	16	16	14	14	14	12	12	12
13.1 - 15.0	14	14	12	12	12	12	12	—

Before using an extension cord, inspect it for loose or exposed wires, damaged insulation, and defective fittings. Make any needed repairs or replace the cord if necessary. Black & Decker has extension cords available that are U.L. (C.S.A. in Canada) listed for outdoor use.

MOTOR

Your Black & Decker tool is powered by a B & D-built motor. Be sure your power supply agrees with the nameplate marking.

Volts 50/60 Hz or "AC only" means your tool must be operated only with alternating current and **never** with direct current. Volts DC-60Hz or AC/DC means your tool may be operated with either alternating or direct current.

Voltage decrease of more than 10% will cause loss of power and over-heating. All B&D tools are factory-tested; if this tool does not operate, check the power supply.

MAINTENANCE

It is recommended that, once a year, you take or send the tool to a B&D Service Center for a thorough cleaning, inspection and lubrication of the gear case. Service Center addresses are shown on the owner registration card packed with your tool.

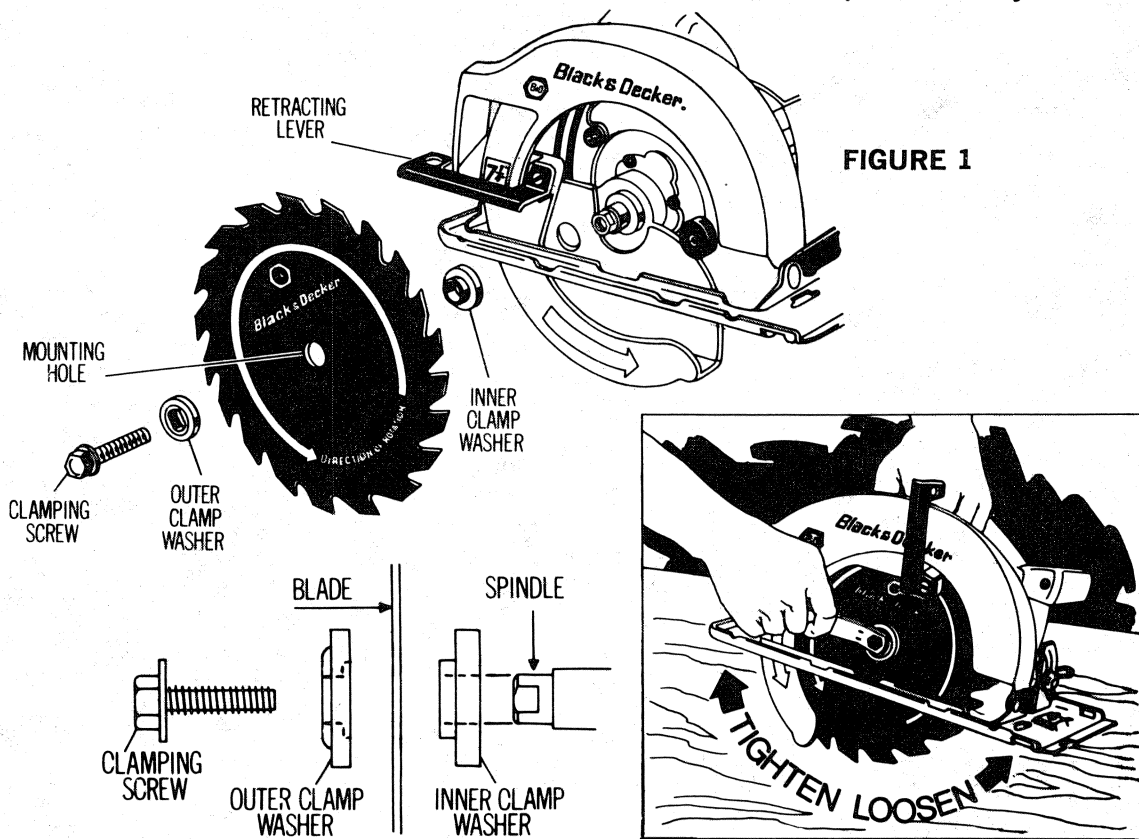

FIGURE 2

ATTACHING & REMOVING BLADES

1. BE SURE SAW IS DISCONNECTED FROM POWER SUPPLY!
2. To remove blade clamping screw (Fig. 1):

—a. ON NEW SAWS (without blade attached). Turn screw counter-clockwise with blade wrench provided. If screw does not loosen easily from spindle, tap the outer end of the wrench sharply in a counter-clockwise direction with a piece of wood to “free” the screw threads. Remove screw and outer clamp washer.

—b. ON SAWS WITH BLADE ATTACHED. Using the retracting lever, retract the lower blade guard and place the Saw on a piece of scrap lumber as shown in Figure 2. Press down on the Saw so that the blade teeth dig slightly into the lumber and prevent the blade from turning. Then, with the blade wrench provided, turn the clamping screw counter-clockwise and remove the screw and outer clamp washer. Disengage the blade teeth from the lumber, and with the lower blade guard still retracted, lift off the blade.

3. To attach the blade: Place inner clamp washer on spindle if previously removed. Retract lower blade guard and place blade over inner clamp washer with printed side of blade out (teeth at bottom of blade pointing forward). Fit outer clamp washer onto spindle . . . “flats” on the outer washer must mesh with the “flats” on the spindle. Thread on clamping screw firmly by hand to hold washers in position. Place Saw on piece of scrap lumber as shown in Figure 2 and press down on the Saw so that blade teeth dig slightly into wood and prevent the blade from turning. Tighten clamping screw (clockwise) firmly with the blade wrench.

NOTE: An alternate way to keep the blade from turning, when tightening or loosening the blade screw, is to hold a large nail through the hole in the blade and against the forward part of the shoe. Rest the nail on top of the shoe when tightening, against the bottom when loosening. **CAUTION:** Remove nail before connecting plug.

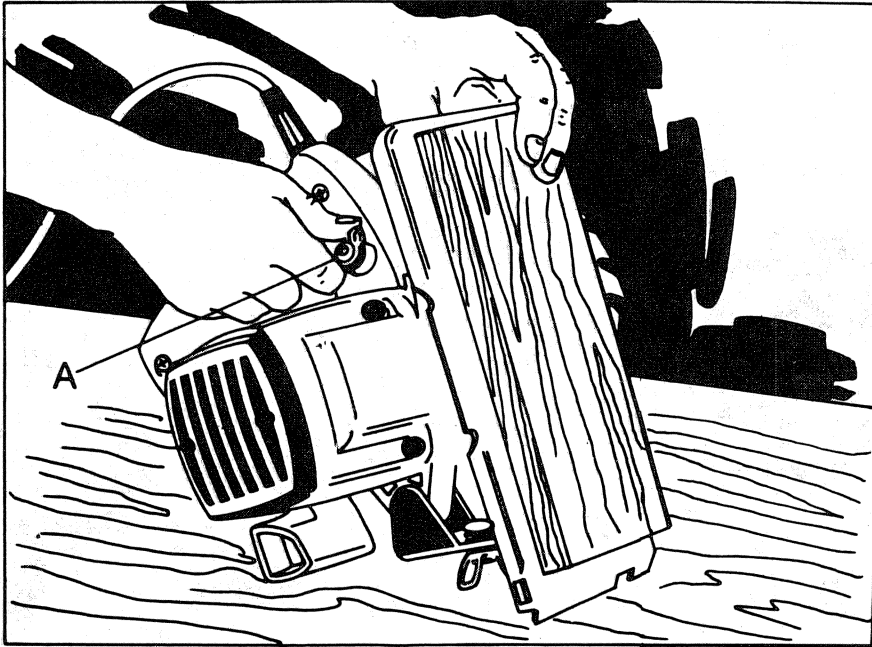

FIGURE 3

CUTTING DEPTH ADJUSTMENT

DISCONNECT PLUG FROM POWER SUPPLY BEFORE MAKING THIS OR ANY OTHER ADJUSTMENT.

For the most efficient cutting action, set the Depth Adjustment so that one tooth of the blade will project below the material to be cut. This distance is from the tip of the tooth to the bottom of the gullet in front of it. This keeps blade friction at a minimum, removes sawdust from the cut, and results in cooler, faster sawing.

NOTE: When using Carbide-Tipped Blades, make an exception to the above rule and allow only one-half of a tooth to project below the material being cut.

To adjust the cutting depth:

1. BE SURE THE SAW IS DISCONNECTED FROM THE POWER SUPPLY!
2. Place the saw in the position shown in Figure 3 and loosen depth adjustment knob "A".
3. Place a scrap piece of the material to be cut along the side of the blade as shown. Raise or lower the shoe until the blade projects from the shoe the desired distance. Retighten knob.

SWITCH

Pull the trigger switch to turn the motor "ON". Releasing the trigger instantly turns the motor "OFF". For safer operation, this tool has no provision to lock the switch in the "ON" position.

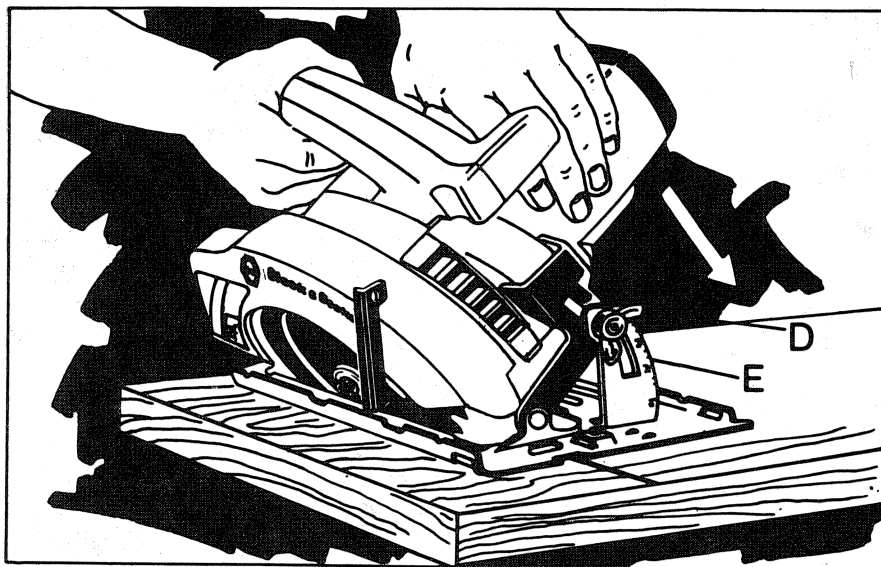

FIGURE 4

BEVEL ANGLE ADJUSTMENT

DISCONNECT THE SAW FROM THE POWER SUPPLY BY PULLING THE PLUG, BEFORE MAKING THIS, OR ANY OTHER ADJUSTMENT! On the front of the saw is a bevel angle adjustment device (Figure 4) consisting of calibrated quadrant "E" and a knob "D". To set the saw for a bevel cut, loosen knob and tilt shoe to angle desired. Retighten knob firmly.

CAUTION: When making bevel cuts, place one hand on the motor housing as shown in Figure 4. Exert only enough pressure in the direction of the arrow to keep the saw shoe flat on the work. This will insure an accurate bevel cutting angle and help prevent the blade from binding in the cut.

GUIDE EDGES

Guide along the penciled cutting line so that the kerf falls into the waste or surplus material—See Figure 5.

GUIDE ALONG PENCILLED CUTTING LINE
SO KERF FALLS IN WASTE STOCK

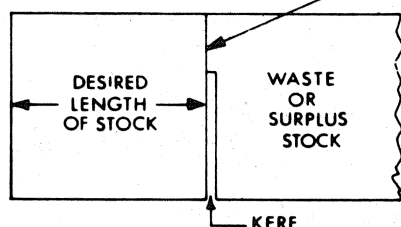

FIGURE 5

An Adjustable Guide on the front of the saw shoe has two guide edges (Figure 6)—one for vertical cutting, and one for 45° bevel cutting. These edges enable you to guide the saw along penciled lines, and the edges line up with the left (inner) side of the saw blade. This makes the slot or "kerf" cut by the moving blade fall to the right of the guide mark.

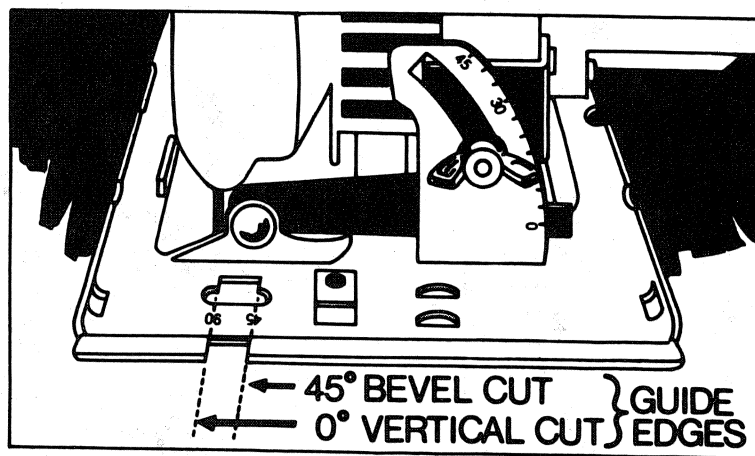

FIGURE 6

OPERATION

Figure 7 shows proper sawing position. Note that hands are kept away from cutting area, safety glasses are worn, power cord is kept clear of cutting area and positioned so that it will not be caught on the work piece while cutting and that clothing is not loose to the point where it might get caught in moving parts.

When operating the saw, keep the cord away from the cutting area and prevent it from becoming hung up on the work piece.

FIGURE 7

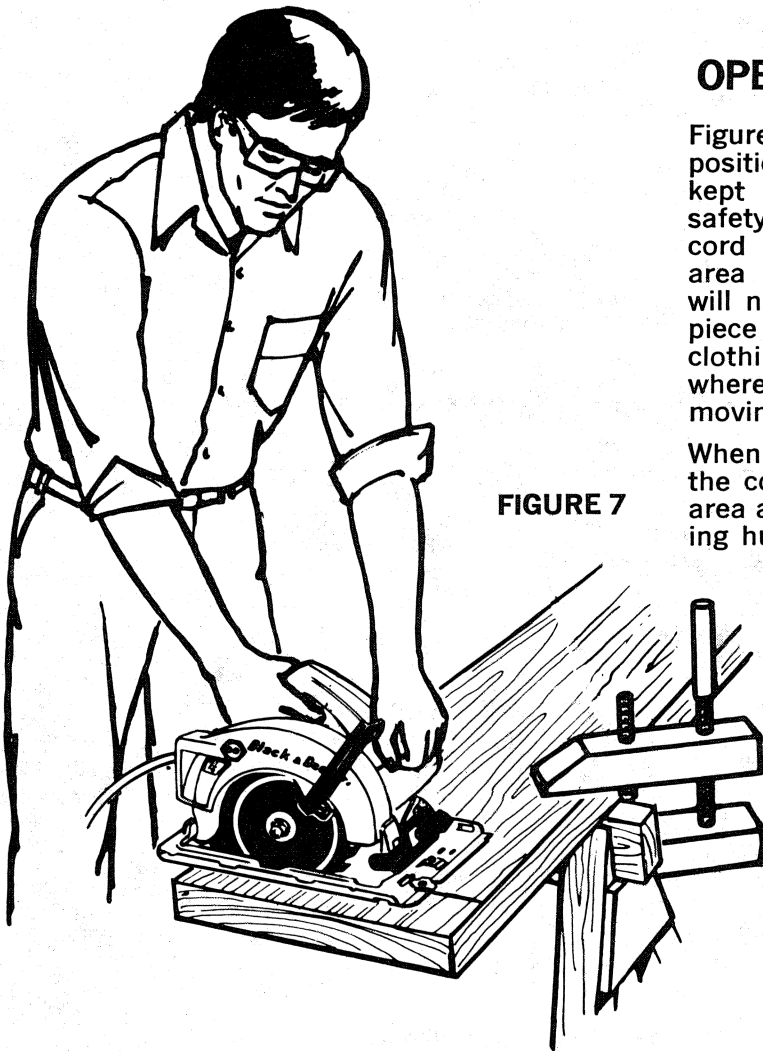

WARNING: It is important to support the work properly and to hold the saw firmly to prevent loss of control which could cause personal injury. Figure 7 illustrates typical hand support of the saw.

TO AVOID KICKBACK, DO SUPPORT BOARD OR PANEL NEAR THE CUT.

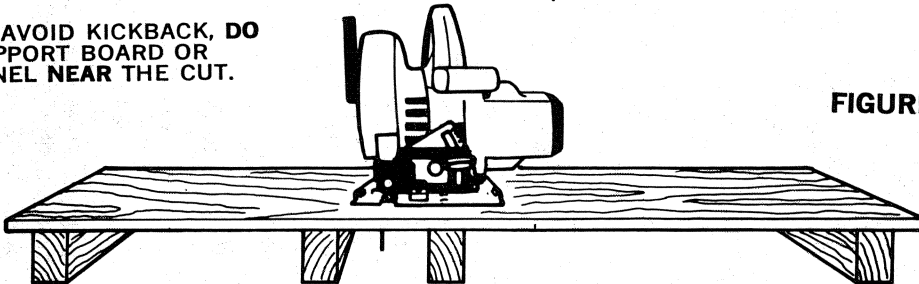
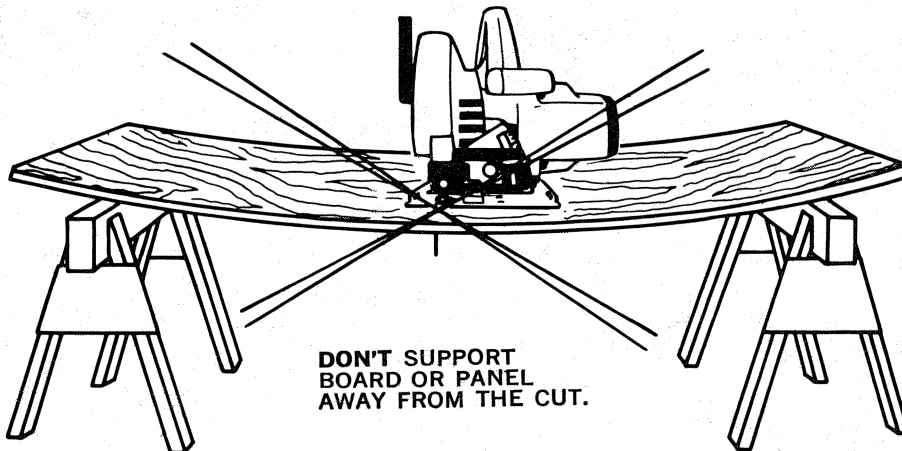

FIGURE 8



DON'T SUPPORT BOARD OR PANEL AWAY FROM THE CUT.

OPERATION

WARNING: It is important to support the work properly and to hold the saw firmly to prevent loss of control which could cause personal injury.

ALWAYS DISCONNECT SAW BEFORE MAKING ANY ADJUSTMENTS! Place the work with its "good" side—the one on which appearance is most important—down. The saw cuts upward, so any splintering will be on the work face that is up when you saw it.

Support the work so that the cut will be on your right. Place the wider portion of the saw shoe on that part of the work piece which is solidly supported, not on the section that will fall off when the cut is made. As examples, Figure 9 illustrates the RIGHT way to cut off the end of a board, and Figure 10 the WRONG way. If the work is short or small, clamp it down. Don't try to hold short pieces by hand!

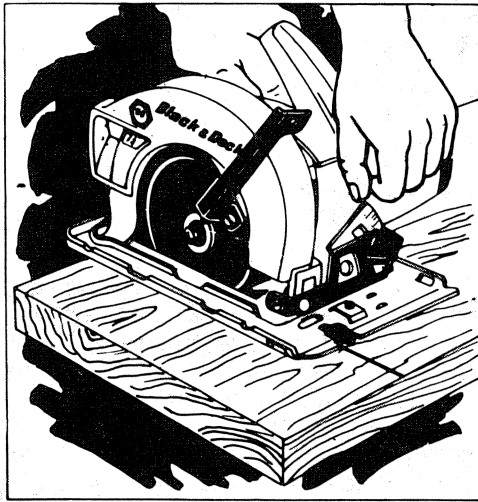

FIG. 9 — RIGHT

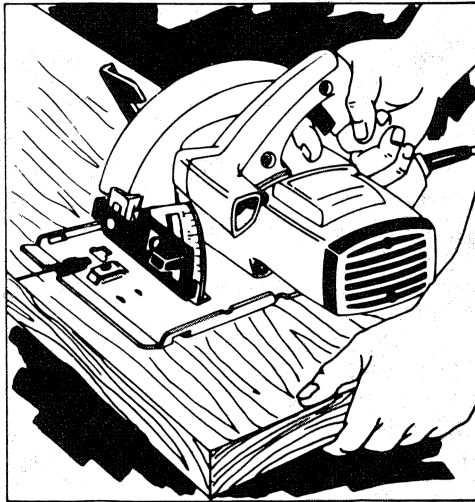

FIG. 10 — WRONG

Draw the required guide lines. Then rest the front of the saw shoe on the work with the guide edge lined up with the drawn guide line. Before starting the motor, push the blade lightly against the edge of the work and then back off about $\frac{1}{4}$ ". Now, start the motor, and when the blade gains full speed, push the saw forward and begin sawing. As you begin cutting, the lower blade guard will automatically begin to telescope into the upper blade guard. This telescoping action will continue as you advance the saw until it reaches the position in Figure 9

Push the saw forward at a speed which allows the blade to cut without laboring. Hardness and toughness can vary even in the same piece of material, and a knotty or damp section can put a heavy load on the saw. When this happens, push the saw more slowly, but hard enough to keep it working without much decrease in speed. Forcing it beyond this makes for rough cuts, inaccuracy and overheating of the motor.

Should your cut begin to go off the line, don't try to force the saw back on. Release trigger and allow blade to come to a complete stop. Then you can withdraw the saw, sight anew, and start a new cut a trifle inside the wrong one. In any event, withdraw the saw if you must shift the cut. Forcing a correction inside the cut can stall the saw and perhaps spoil the work. **IF SAW STALLS, RELEASE THE TRIGGER, BACK THE SAW UNTIL IT IS LOOSE. BE SURE BLADE IS STRAIGHT IN THE CUT BEFORE RESTARTING.**

As you finish a cut, release the trigger and allow the blade to stop before lifting the saw from the work. As you lift the saw the spring-tensioned telescoping guard will automatically close under the saw. Remember the blade is exposed until this occurs; **never reach under the work for any reason whatsoever.** When you have to retract the telescoping guard manually (as is necessary for starting pocket cuts) always use the retracting lever.

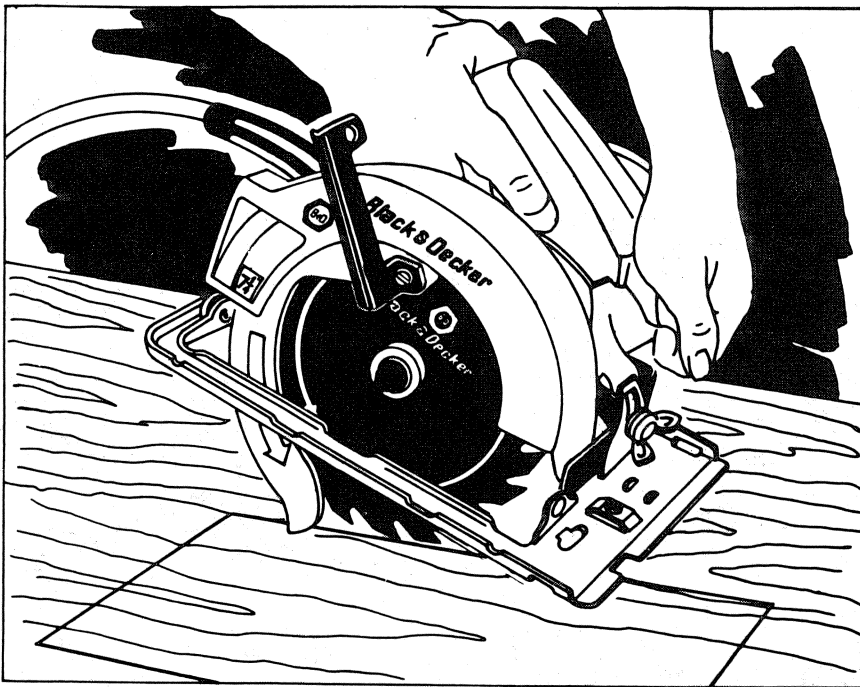

FIGURE 11

POCKET CUTTING

DISCONNECT SAW FROM POWER SUPPLY BEFORE MAKING CUTTING DEPTH ADJUSTMENT! Set blade to desired cutting depth. Tilt saw forward and rest front of shoe on material to be cut. Using the retracting lever, retract blade guard to an upward position. Lower rear of shoe until blade teeth almost touch cutting line. Now release the blade guard and its contact with the work will keep it in position to open freely as you start the cut (Figure 11). Start the motor and gradually lower the saw until its shoe rests flat on the material to be cut. Advance saw along cutting line until cut is completed. Release trigger and allow blade to stop completely before withdrawing the blade from the material. When starting each new cut, repeat as above. **Never tie the blade guard in a raised position.**

ACCESSORIES

The accessories listed in this manual are available at extra cost from your local dealer or Black & Decker Service Center. A complete listing of service centers is included on the owner's registration card packed with your tool.

If you need assistance in locating any accessory, please contact: Black & Decker (U.S.) Inc., User Services Department, 10 North Park Drive, P.O. Box 857, Hunt Valley, MD 21030-0857.

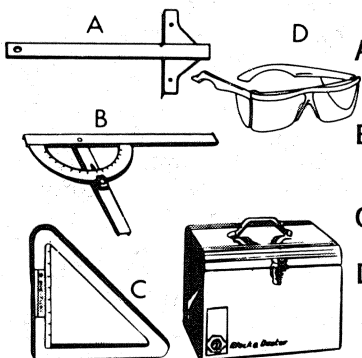

- A. **RIP FENCE** . . . Attaches to top of Saw shoe. Permits rip cuts without penciled guide lines.
- B. **SAW PROTRACTOR** . . . Guides Saw for accurate cut-off work. Adjusts from 0° to 70°.
- C. **CUT-OFF GUIDE** . . . For 90° or 45° cuts.
- D. **SAFETY GLASSES** . . . Lightweight, one-piece, impact resistant, clear plastic safety glasses with side shields. Can be worn directly over eyes or over prescription glasses. Comfortable.

SAW CARRYING CASE . . . Protect your saw, keep saw accessories and extra blades handy on the job.

CAUTION: Recommended accessories and saw blades for your Saw are listed above and on the next page of this manual. The use of any other type of blade or accessory might be hazardous.

BLACK & DECKER CIRCULAR SAW BLADES











A dull blade will cause slow, inefficient cutting and will overload the saw motor. It is a good practice to keep extra blades on hand so that sharp blades are available while the dull ones are being sharpened (See "SAWS—SHARPENING" in Yellow Pages). In fact, many lower priced blades can be replaced with new ones at very little cost over the sharpening price. USE ONLY 7¼", 7⅝" or 7" BLADES, WITH ⅝" ARBOR HOLE, ON YOUR SAW.

Hardened gum on the blade will slow down the cutting. This gum can best be removed with trichlorethylene, kerosene or turpentine. Remove blade before cleaning to prevent solvent from damaging plastic parts of saw.

Black & Decker manufactures a complete line of saw blades and the following types are available.

Standard: Outstanding value for the price. These blades are also available in bulk quantities. Ask for quantity prices. (When sold in bulk, "-01" is added to catalog number).

Premium: Industrial chrome plating gives twice the cutting life of unplated blades.

TYPE OF BLADE	TOOTH SHAPE		
COMBINATION Chisel tooth configuration means this blade is the fastest cutting blade in our line. Specifically designed for general-purpose ripping and cross-cutting where the finish of the cut is not critical.			
FRAMING/RIP An all-purpose blade for smooth, fast cutting in any direction. Rips, crosscuts, miters, etc. Gives especially fast, smooth finishes when cutting with the grain of both soft and hard woods.			
METAL CUTTING Teeth shaped and set specifically for cutting aluminum, copper, lead and other soft metals.			
HOLLOW GROUND PLANER Specially ground for satin-smooth finish cuts (cross-cuts, rips and miters) in all solid woods. A professional quality blade for use in cabinet work, furniture, etc. Specifically designed to make extremely smooth cuts in wood.			
CARBIDE TIPPED (8 tooth) Specially designed for cutting tough-to-cut materials such as: Transite, Cemesto board, asbestos, Formica and Masonite. Will also cut wood where speed and finish are not critical.			
CARBIDE TIPPED (20 tooth) Chisel tooth combination blade for fast general-purpose cutting in all types of woods. Tips are of tungsten carbide material which outlasts regular steel blades up to 10 to 1. Teeth are accurately set for ease of cutting.			
FLOORING For use where nails or other metal objects may be encountered, such as cutting reclaimed lumber, flooring, opening crates. Allows crosscuts as well as miters.			
HOLLOW GROUND PLYWOOD Special taper grinding on the sides of this thin-rim blade gives an absolutely smooth cut in plywood, veneers and laminates, etc. Can be used in crosscutting and mitering for a professional finish on all types of cabinet work.			
STEEL CUTTING FRICTION Designed for cutting corrugated or sheet roofing, black iron, furnace pipe or thin bar stock. Cuts faster with less filings than abrasive blades. Cuts by friction action.			
CROSS-CUT Specifically designed for smooth, fast cutting cross the grain of both hard and soft woods where finish is an important factor. May also be used for rip and crosscuts on extremely hard woods.			

ABRASIVE BLADES (Fiberglass Reinforced)

Aluminum Oxide cuts ferrous metals and hardened non-ferrous metals.

Silicon Carbide cuts masonry materials and soft non-ferrous metals.

CLEANING

Use only mild soap and a damp cloth to clean the tool. Many household cleaners contain chemicals which could seriously damage the plastic. Also, do not use gasoline, turpentine, lacquer or paint thinner, dry cleaning fluids or similar products. Never let any liquid get inside the tool; never immerse any part of the tool into a liquid.

IMPORTANT

To assure product SAFETY and RELIABILITY, repairs, maintenance and adjustment (including brush inspection and replacement) should be performed by Black & Decker Service Centers or other qualified service organizations, always using Black & Decker replacement parts. When servicing Double-Insulated Tools, it is extremely important that ONLY IDENTICAL REPLACEMENT PARTS BE USED and that REASSEMBLY OF TOOL IS IDENTICAL TO THE ORIGINAL ASSEMBLY.

COMMERCIAL/INDUSTRIAL USE WARRANTY

Black & Decker (U.S.) Inc. warrants this product for one year from date of purchase. We will repair without charge, any defects due to faulty material or workmanship. Please return the complete unit, transportation prepaid, to any Black & Decker Service Center or Authorized Service Station listed under "Tools Electric" in the yellow pages. This warranty does not apply to accessories or damage caused where repairs have been made or attempted by others.

Like all Black & Decker tools, your Saw is listed by Underwriters' Laboratories to ensure that it meets stringent safety requirements.

This symbol on the nameplate means the product is Listed by Underwriters' Laboratories, Inc.



See 'Tools-Electric'
—Yellow Pages—
for Service & Sales

BLACK & DECKER (U.S.) INC.
U.S. Power Tools Group • 10 North Park Drive
P.O. Box 798 • Hunt Valley, MD 21030-0798

Free Manuals Download Website

<http://myh66.com>

<http://usermanuals.us>

<http://www.somanuals.com>

<http://www.4manuals.cc>

<http://www.manual-lib.com>

<http://www.404manual.com>

<http://www.luxmanual.com>

<http://aubethermostatmanual.com>

Golf course search by state

<http://golfingnear.com>

Email search by domain

<http://emailbydomain.com>

Auto manuals search

<http://auto.somanuals.com>

TV manuals search

<http://tv.somanuals.com>