

Owner's Manual
for Vehicle



The Ultimate
Driving Machine



M3 Convertible

Thank you for deciding on a BMW M3 Convertible.

Thorough familiarity with your vehicle will provide you with enhanced control and security when you drive it. Therefore, we have one request:

Read the information contained in this Owner's Manual before driving your new BMW M3 Convertible for the first time. It contains important information on vehicle operation that will enable you to make full use of the advanced technical equipment of your BMW M3 Convertible. In addition, you will receive information on vehicle maintenance to help ensure operating and traffic safety as well as the best possible value retention of your BMW. For more detailed information refer to the supplemental manuals.

BMW also makes decisive contributions toward greater safety in traffic through its BMW driver training.

This Owner's Manual should be considered a permanent part of this vehicle. It should stay with the vehicle when sold to provide the next owner with important operating, safety and maintenance information.

We wish you an enjoyable driving experience.

BMW AG

4 Notes

About this Owner's Manual

We have made every effort to ensure that you are able to find what you need in this Owner's Manual as quickly as possible. The fastest way to find certain topics is by using the detailed index at the end. If you wish to gain an initial overview of your vehicle, you will find this in the first chapter.

Should you wish to sell your BMW at some time in the future, please remember to hand over this Owner's Manual to the new owner; it is an important part of the vehicle.

© 2004 Bayerische Motoren Werke
Aktiengesellschaft
Munich, Germany

Reprinting, including excerpts, only with the
written consent of BMW AG, Munich.

Order No. 01 41 0 158 515

US English VIII/04

Printed in Germany

Printed on environmentally friendly paper,
bleached without chlorine, suitable for recycling.

Additional sources of information

Should you have any further questions, your BMW center will be glad to assist at any time.

You can find more information about BMW, for example on its technology, on the Internet at www.bmw.com.

Symbols used



Indicates precautions that must be followed precisely in order to avoid the possibility of personal injury and serious damage to the vehicle.



Indicates information that will assist you in gaining the optimum benefit from your vehicle and enable you to care more effectively for your vehicle.



Refers to measures that can be taken to help protect the environment.

◀ Marks the end of a specific item of information.

* Indicates special equipment, country-specific equipment and optional extras, as well as equipment and functions not yet available at the time of printing.



Vehicle Memory, Key Memory, refer to page 64. Identifies functions that can be specifically adapted for a particular key or vehicle. These adjustments can be performed by your BMW center. ◀



Indicates that you should consult the relevant section of this Owner's Manual for information on a particular part or assembly.

Your individual vehicle

On purchasing your BMW, you have decided in favor of a model with individualized equipment and features. This Owner's Manual will describe all of the equipment that the BMW M3 Convertible has to offer you.

We hope you will understand that equipment and features are included that you might not have chosen for your vehicle. You can easily identify any differences with the aid of the asterisk * used to identify all optional equipment and accessories.

If your BMW features equipment that is not described in this Owner's Manual, such as a car radio or telephone, we have enclosed Supplementary Owner's Manuals. We ask you to read these manuals as well.

Status at time of printing

BMW pursues a policy of continuous, ongoing development that is conceived to ensure that our vehicles continue to embody the highest quality and safety standards combined with advanced, state-of-the-art technology. In exceptional cases, the features described in this Owner's Manual could therefore differ from those on your vehicle.

For your own safety

Maintenance and repair

 Advanced technology, e.g. the use of modern materials and high-performance electronics, requires specially adapted maintenance and repair methods. Therefore, only have corresponding work on your BMW carried out by a BMW center or a workshop that works according to BMW repair procedures with correspondingly trained personnel. If work is carried out improperly there is a danger of consequential damage and the related safety risks. ◀

Proposition 65 warning

California laws require us to state the following warning:

 Engine exhaust and a wide variety of automobile components and parts, including components found in the interior furnishings in a vehicle, contain or emit chemicals known to the State of California to cause cancer and birth defects and reproductive harm. In addition, certain fluids contained in vehicles and certain products of component wear contain or emit chemicals known to the State of California to cause cancer and birth defects or other reproductive harm. Battery posts, terminals and related accessories contain lead and lead compounds. Batteries also contain other chemicals known to the State of California to cause cancer. Wash your hands after handling. Used engine oil contains chemicals that have caused cancer in laboratory animals. Always protect your skin by washing thoroughly with soap and water. ◀

Parts and accessories

 Important safety information! For your own safety, use genuine parts and accessories approved by BMW.

When you purchase accessories tested and approved by BMW and Original BMW Parts, you simultaneously acquire the assurance that they have been thoroughly tested by BMW to ensure optimum performance when installed on your vehicle.

BMW warrants these parts to be free from defects in material and workmanship.

BMW will not accept any liability for damages resulting from installation of parts and accessories not approved by BMW.

BMW cannot test every product made by other manufacturers to verify if it can be used on a BMW safely and without risk to either the vehicle, its operation, or its occupants.

Original BMW Parts, BMW Accessories and other products approved by BMW, together with professional advice on using these items, are available from all BMW centers.

Installation and operation of non-BMW approved accessories such as alarms, radios, amplifiers, radar detectors,

wheels, suspension components, brake dust shields, telephones, including operation of any mobile phone from within the vehicle without using an externally mounted antenna, or transceiver equipment, for instance, CBs, walkie-talkie, ham radio or similar accessories, may cause extensive damage to the vehicle, compromise its safety, interfere with the vehicle's electrical system or affect the validity of the BMW Limited Warranty. Contact your BMW center for additional information. Do not use key or remote control to lock doors or luggage compartment with anyone inside the car. Refer to the Owner's Manual for more details. ◀



Maintenance, replacement, or repair of the emission control devices and systems may be performed by any automotive repair establishment or individual using any certified automotive part. ◀

Service and warranty

This manual is supplemented by a Service and Warranty Information Booklet for US models or a Warranty and Service Guide Booklet for Canadian models.

We recommend that you read this publication thoroughly.

Your BMW is covered by the following warranties:

- ▷ New Vehicle Limited Warranty
- ▷ Rust Perforation Limited Warranty
- ▷ Federal Emissions System Defect Warranty
- ▷ Federal Emissions Performance Warranty
- ▷ California Emission Control System Limited Warranty.

Detailed information about these warranties is listed in the Service and Warranty Information Booklet for US models or in the Warranty and Service Guide Booklet for Canadian models.

Reporting safety defects

The following only applies to vehicles owned and operated in the US.

If you believe that your vehicle has a defect which could cause a crash or could cause injury or death, you should immediately inform the National Highway Traffic Safety Administration NHTSA in addition to notifying BMW of North America, LLC, P.O. Box 1227, Westwood, New Jersey 07675-1227, telephone toll-free 1-800-831-1117.

If NHTSA receives similar complaints, it may open an investigation, and if it finds that a safety defect exists in a group of vehicles, it may order a recall and remedy campaign. However, NHTSA cannot become involved in individual problems between you, your dealer, or BMW of North America, LLC.

To contact NHTSA, you may either call the Auto Safety Hotline toll-free at 1-800-424-9393 or 366-0123 in the Washington, D.C. area, or write to: NHTSA, U.S. Department of Transportation, Washington, D.C. 20590. You can also obtain other information about motor vehicle safety from the Hotline.

Contents

Notes

- About this Owner's Manual 4
- Additional sources of information 4
- Symbols used 4
- Your individual vehicle 5
- Status at time of printing 5
- For your own safety 6
- Service and warranty 7
- Reporting safety defects 7

Overview

- Cockpit 14
- Instrument cluster 16
- Indicator and warning lamps 18
- Buttons in steering wheel 22
- Hazard warning triangle* 23
- First-aid kit* 23
- Refueling 24
- Fuel specifications 25

Controls and features

Opening and closing:

- Keys 28
- Central locking system 28
- Opening and closing – via the remote control 29
- Opening and closing – via the door lock 31
- Opening and closing – from the inside 32
- Luggage compartment lid 33
- Luggage compartment 35
- Alarm system* 36
- Electric power windows 38
- Convertible top 39
- Wind deflector* 44

To adjust:

- Safe seating position 46
- Seats 47
- Power seat adjustment 47
- Head restraints 48
- Entering the rear 49
- Safety belts 50
- Seat and mirror memory 51
- Seat heating* 52
- Mirrors 53
- Steering wheel 54

Contents

Controls and features	Passenger safety systems:	Operation, maintenance	Special operating instructions:
	Airbags 55		Break-in procedures 110
	Transporting children safely 58		General driving notes 111
	Rollover protection system 62		Antilock Brake System (ABS) 113
	Vehicle Memory, Key Memory 64		Hardtop* 113
	Driving:		Wheels and tires:
	Ignition lock 65		Tire inflation pressure 116
	Starting the engine and driving off 66		Tire code 118
	Switching off the engine 68		Tire condition 119
	Parking brake 68		New wheels and tires 120
	Manual transmission 69		Snow chains* 122
	Sequential M gearbox with Drivelogic* 70		In the engine compartment:
	Turn signal indicator/Headlamp flasher 75		Hood 123
	Washer/wiper system/Rain sensor* 76		Engine compartment essentials 124
	Cruise control 77		Washer fluids 126
	Everything under control:		Engine oil 126
	Odometer 79		Coolant 128
	Tachometer 79		Brake fluid 129
	Engine oil temperature 79		Maintenance:
	Fuel gauge 80		BMW Maintenance System 130
Engine coolant temperature gauge 80	OBD interface socket 132		
Service interval display 81			
Check Control 81			
Clock 82			
Computer 83			
	Technology for safety and driving convenience:		
	Park Distance Control (PDC)* 85		
	Dynamic Stability Control DSC 86		
	Flat Tire Monitor 87		
	M Engine dynamics control 89		
	Brake force display 89		
	Lamps:		
	Parking lamps/Low beams 90		
	Instrument lighting 91		
	High beams/Standing lamps 91		
	Front fog lamps 92		
	Interior lamps 92		
	Reading lamps 92		
	Controlling the climate for pleasant driving:		
	Automatic climate control 94		
	Interior conveniences:		
	Glove compartment 99		
	Storage compartments 99		
	Microphone* 100		
	Ashtray, front* 100		
	Ashtray, rear* 101		
	Loading and transporting:		
	Ski bag* 102		
	Cargo loading 104		
	Roof-mounted luggage rack for the hardtop* 107		

Contents

Owner service procedures

Replacement procedures:

- Onboard tool kit [136](#)
- Windshield wiper blades [136](#)
- Lamps and bulbs [137](#)
- Tire repair with the M Mobility system [141](#)
- Battery [144](#)
- Fuses [145](#)

Giving and receiving assistance:

- Receiving assistance [146](#)
- Jump-starting [147](#)
- Towing and tow-starting the vehicle [149](#)

Technical data

- Engine data [154](#)
- Dimensions [155](#)
- Weights [156](#)
- Capacities [157](#)

Index

- Everything from A to Z [160](#)



Overview

Controls and features

Operation, maintenance

Owner service procedures

Technical data

Index



Overview

Controls

Maintenance

Repairs

Data

Index

14 Cockpit

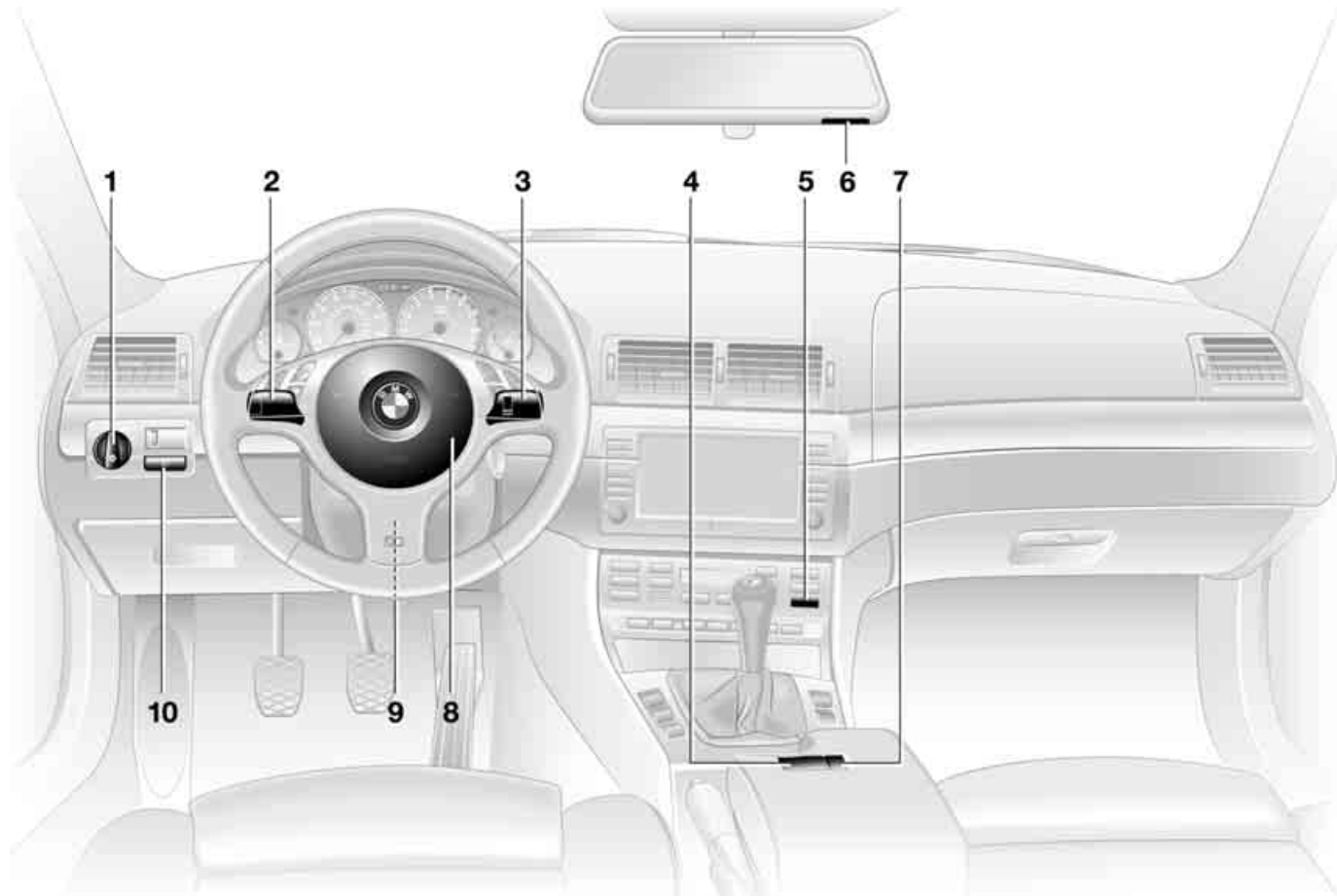

MY0294PCMA

Cockpit

- 1 Parking lamps/Low beams [90](#)
- 2 ▷ Turn signal indicators [75](#)
 - ▷ Standing lamps [91](#)
 - ▷ High beams [91](#)
 - ▷ Headlamp flasher [75](#)
 - ▷ Computer [83](#)
- 3 Washer/wiper system/Rain sensor [76](#)
- 4 Hazard warning flashers
- 5 Rear window defroster [97](#)
- 6 ▷ Initiating an emergency call [146](#)
 - ▷ Mobile Service [147](#)
- 7 Central locking system [28](#)
- 8 Horn: the entire surface
- 9 Steering wheel adjustment [54](#)
- 10 Fog lamps [92](#)

16 Instrument cluster

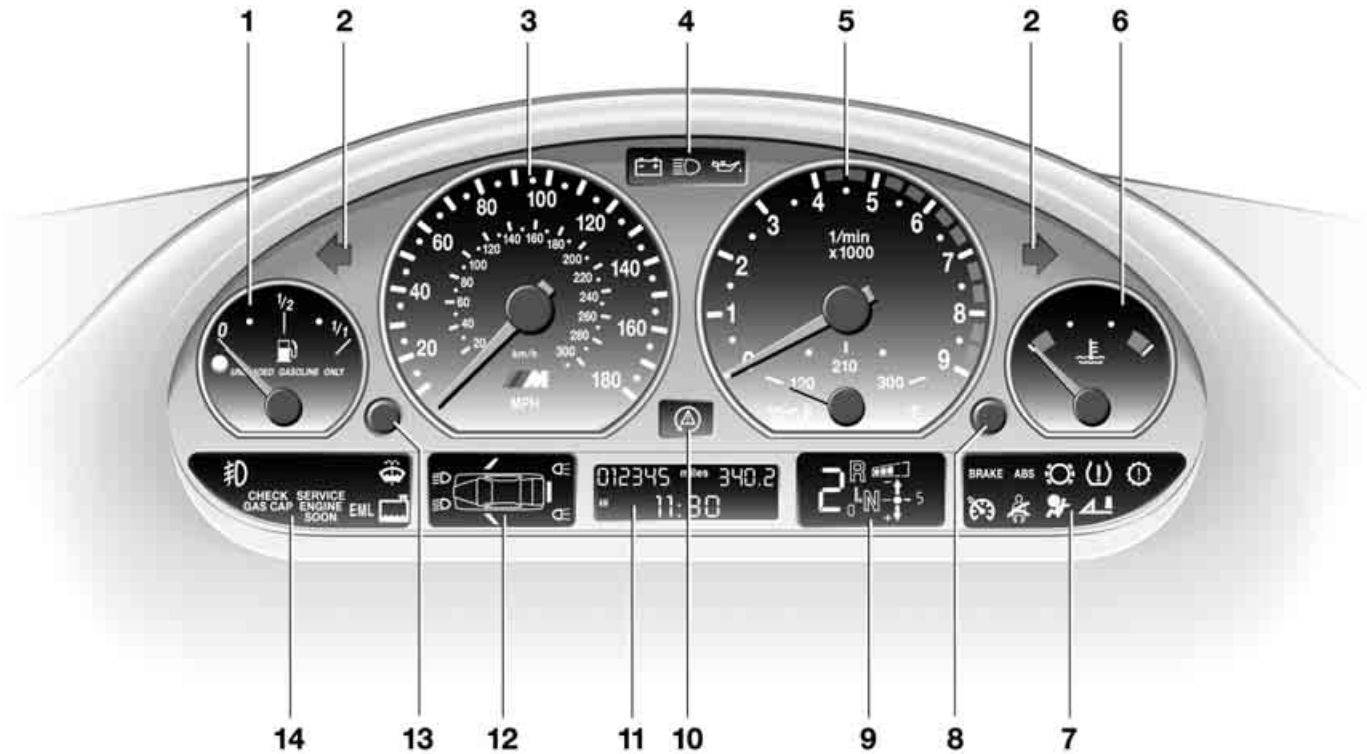

MV102794CMA

Instrument cluster

- 1 Fuel gauge [80](#)
- 2 Turn signal indicator [20](#)
- 3 Speedometer
- 4 Indicator and warning lamps [18](#)
to [21](#)
- 5 Tachometer and engine oil
temperature gauge [79](#)
- 6 Engine coolant temperature
gauge [80](#)
- 7 Indicator and warning lamps [18](#)
to [21](#)
- 8 Control button for
 - ▷ Clock [82](#)
 - ▷ Unit of measure of outside
temperature display [83](#)
- 9 Display for sequential M gearbox
with Drivelogic [71](#)
- 10 Indicator lamp for Dynamic Stability
Control (DSC) [86](#)
- 11 Display for
 - ▷ Trip odometer [79](#)
 - ▷ Clock [82](#)
 - ▷ Service interval [81](#)
 - ▷ Computer [83](#)
- 12 Check Control [81](#)
- 13 Trip odometer, reset to zero [79](#)
- 14 Indicator and warning lamps [18](#)
to [21](#)

18 Indicator and warning lamps

Technology that monitors itself

Indicator and warning lamps that are identified by ● are tested for proper functioning whenever the ignition key is turned. They each light up once for different periods of time.

If a fault should occur in one of these systems, the corresponding lamp does not go out after the engine is started, or it lights up while the vehicle is moving. You will see how to react to this below.

Red: stop immediately

 Battery charge current ●
The battery is no longer being charged. There is a malfunction of the alternator drive belt or in the charging circuit of the alternator. Please contact the nearest BMW center.

 If the drive belt is defective, stop and switch off the engine immediately to prevent overheating and serious engine damage. If the drive belt is defective, increased steering effort is also required. ◀

 Engine oil pressure ●
An alarm sounds at the same time. The engine oil pressure is too low. Stop the vehicle immediately and switch off the engine. It is not possible to continue driving. Please contact the nearest BMW center.

 Do not continue driving, as the engine could sustain serious damage from inadequate lubrication. ◀

 Flat Tire Monitor ●
In addition, an acoustic signal is sounded: there is a flat tire.
Reduce speed and carefully come to a stop. Avoid sudden braking and steering maneuvers.
For additional information, refer to page 88.

 Brake warning lamp ●
If the lamp comes on when the parking brake is not engaged: check the brake fluid level. It is very important that you follow the instructions on page 129 before driving on. Have the system checked immediately.

 Brake warning lamp for Canadian models.

Red: an important reminder

 Brake warning lamp ●
Comes on when the parking brake is engaged – an additional acoustic signal sounds when starting off.

For additional information, refer to page 68.

 Brake warning lamp for Canadian models.

 Lock seat backrest/Please fasten safety belt ●
Comes on together with an acoustic signal until driver fastens safety belt. Flashes when the backrest is not locked.

For additional information on locking the seat backrests, refer to page 49.
For additional information on safety belts, refer to page 50.

 Airbags ●
Have the system checked as soon as possible.

For additional information, refer to page 57.

Indicator and warning lamps

Red and yellow: continue driving cautiously

BRAKE The brake warning lamp comes on together with the yellow indicator lamps for ABS ● and DSC:

ABS The entire ABS, CBC and DSC control system has failed. Continue driving cautiously and defensively and avoid full brake applications. Please have the system checked by your BMW center as soon as possible.

For additional information, refer to pages [86](#), [113](#).

 Indicator and warning lamps CBC, ABS and DSC for Canadian models.





Orange: consult the nearest BMW center

 Sequential M gearbox with Drivelogic

If the indicator lamp fails to go out after the engine is started, or if it comes on during normal driving: this indicates a malfunction in the system. Have the system checked immediately. Indicator lamp flashes: a system overload has occurred.

For additional information, refer to page [74](#).

Yellow: check as soon as possible

 Engine oil level

Comes on while driving and is accompanied by an alarm: the engine oil level has fallen to the absolute minimum; refill as soon as possible. Do not drive more than 30 miles/50 km before refilling.

For additional information, refer to page [126](#).



Engine oil level

Comes on after the engine has been shut off and is accompanied by an alarm: add engine oil at your earliest opportunity such as when you stop to refuel

For additional information, refer to page [126](#).



Brake pads ●

Have the brake pads checked immediately.

For additional information, refer to page [112](#).



Flat Tire Monitor ●

The Flat Tire Monitor has been deactivated, either at the button or in response to a system malfunction. If there is a malfunction, have the system checked.

For additional information, refer to page [88](#).

20 Indicator and warning lamps



Dynamic Stability Control
DSC ●

The indicator lamp flashes and an acoustic signal sounds: the system is active and governs drive and braking force.

If the indicator lamp fails to go out after the engine is started, or if it comes on during normal driving and stays on: DSC has been deactivated, either at the button or in response to a system malfunction.

If there is a malfunction, have the system checked as soon as possible.

For additional information, refer to page [86](#).



Dynamic Brake Control (DBC) ●

Malfunction in DBC system.

Conventional braking efficiency is available and unrestricted.

Have the system checked as soon as possible.

For additional information, refer to page [113](#).



Dynamic Brake Control (DBC)
warning lamp for Canadian
models.



Add washer fluid

The washer fluid level is too low, top it up at the earliest opportunity.

For additional information, refer to page [126](#).



SERVICE ENGINE SOON ●

If the indicator lamp comes on either continuously or intermittently, this indicates a fault in the emissions-related electronic systems.

Although the vehicle remains operational, you should have the systems checked by your BMW center at the earliest possible opportunity.

For additional information: Refer to page [132](#).



Service Engine Soon indicator
lamp for Canadian models.



Engine electronics ●

There is a fault in the electronic engine-management system.

You can continue to drive with reduced engine output or engine speed. Please have the system inspected at your BMW center.



Add coolant

Coolant level too low, top up as soon as possible.

For additional information, refer to page [128](#).



CHECK GAS CAP* ●

This indicator lamp comes on when the gas cap is loose or missing.

Close the gas cap tightly: refer to page [25](#).



Rollover protection system ●

The rollover protection system is deactivated due to a malfunction. Please have the system inspected immediately at your BMW center.

For additional information, refer to page [62](#).

Green: for your information



Turn signal indicator

Flashes when turn signals are on. Rapid flashing: indicates a system malfunction.

For additional information, refer to page [75](#).

Indicator and warning lamps



Cruise control

Lights up when the cruise control is activated. Ready for operation via the buttons in the steering wheel.

For additional information, refer to page [77](#).



Front fog lamps

Lights up whenever the fog lamps are on.

For additional information, refer to page [92](#).

Blue: for your information



High beams

Comes on when the high beams are on or the headlamp flasher is actuated.

For additional information, refer to pages [75](#), [91](#).

22 Buttons in steering wheel

These buttons let you operate the following functions quickly and without being distracted from traffic conditions:

- ▷ Selected radio functions
- ▷ The cruise control
- ▷ Selected telephone functions*
- ▷ The voice command system*.

 The controls are active only when the corresponding systems and accessories are switched on. ◀



Press briefly:

Receive a phone call, initiate dialing, terminate a call.

Extended pressure:

Activate and deactivate voice command.



Display/hide telephone book. Display the entries one after another with the forward/backward buttons.



Forward:

- ▷ Radio
Press briefly: next station in station memory
Extended pressure: station search
- ▷ CD
Press briefly: jump to next track
Extended pressure: search function in track
- ▷ Cassette
Press briefly: jump to next track or stop fast forward
Extended pressure: fast forward
- ▷ Phone
Scan personal phone book.



Rewind: same functions as forward.



Volume.



Cruise control: select a stored setting.



Cruise control: store and accelerate + or decelerate and store -.



Cruise control: activate/interrupt/deactivate.

Hazard warning triangle*



The hazard warning triangle is stored ready to use in the luggage compartment lid inside the toolbox for the onboard tool kit.

To open the container, loosen the wing nut.

 Always observe all legal regulations requiring a warning triangle to be carried in the vehicle. ◀

First-aid kit*

23



The first-aid kit is located under the front passenger's seat.

To open: pull the handle and fold the cover down.

To fasten: fold the cover up and press it until the tab engages.

 Several of the items contained in the first-aid pouch have a limited service life. For this reason, check the expiration dates of each of the items regularly, and replace any with passed dates. These items can be purchased in any drugstore or pharmacy. Always observe all legal regulations requiring a first-aid kit to be carried in the vehicle. ◀

Overview

Controls

Maintenance

Repairs

Data

Index

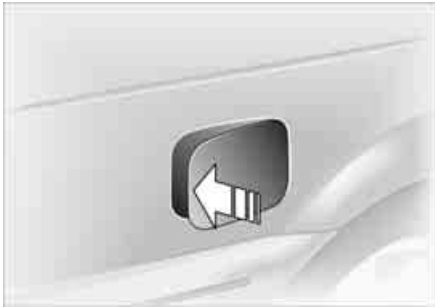

 When handling fuels, comply with all of the applicable safety precautions posted at the service station. Never carry spare fuel containers in your vehicle. Whether empty or full, these containers can leak, cause an explosion, or lead to fire in the event of a collision. ◀

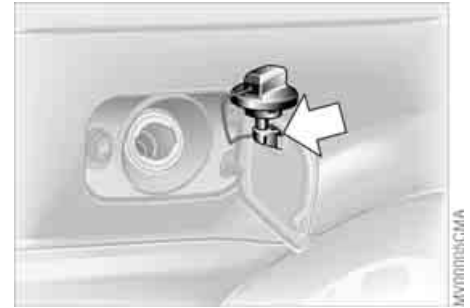

Fuel filler door

 Always switch off the engine before refueling, as it is not possible to add fuel with the engine running, and attempts may also trigger the SERVICE ENGINE SOON lamp. ◀

Press on the rear edge of the fuel filler door to open and close it.

If an electrical malfunction occurs, you can unlock the fuel filler door manually: Pull the knob with the fuel pump symbol on the right trim panel of the luggage compartment.

Please observe while refuelling

 Open the gas cap carefully to prevent fuel from spraying out. Fuel spray may cause injury. ◀

Place the gas cap in the bracket attached to the fuel filler door.

When refueling, insert the filler nozzle completely into the filler pipe. Lifting the nozzle during refueling

- ▷ results in premature pump shutoff
- ▷ and will reduce the effect of the vapor recovery system on the pump.

The fuel tank is full when the filler nozzle shuts off the first time.

Refueling

Closing the gas cap

Place the cap in position and turn it until a clearly audible click is heard.

 Close the gas cap carefully after refueling until a click is heard. While closing, be sure not to squeeze the strap which is fastened to the cap. A loose or missing cap will activate the CHECK GAS CAP* lamp. ◀

 Warning lamp* lights up. The gas cap is not properly closed or is missing. Check if the gas cap is properly closed.

Fuel tank capacity

- ▷ Approx. 16.6 gal./63 liters, of which
- ▷ approx. 2.1 gal./8 liters are reserve capacity.

 Do not drive to the last drop of fuel. This can prevent the engine from operating properly and result in damage. ◀

Fuel specifications

The engine uses lead-free gasoline only.

Required fuel

Premium Unleaded Gasoline,
Minimum Octane Rating: AKI 91.

Minimum Octane Rating corresponds to the Anti Knock Index AKI and is determined according to the so-called (R+M)/2 method.

 Do not use leaded gasoline, as otherwise the lambda probe and catalytic converter will be permanently damaged. ◀

Use high-quality brands

Field experience has indicated significant differences in fuel quality: volatility, composition, additives, etc., among gasolines offered for sale in the United States and Canada. Fuels containing up to and including 10% ethanol or other oxygenates with up to 2.8% oxygen by weight, that is, 15% MTBE or 3% methanol plus an equivalent amount of co-solvent, will not void the applicable warranties with respect to defects in materials or workmanship.



The use of poor-quality fuels may result in drivability, starting and stalling problems especially under certain environmental conditions such as high ambient temperature and high altitude.

Should you encounter drivability problems which you suspect could be related to the fuel you are using, we recommend that you respond by switching to a recognized high-quality brand.

Failure to comply with these recommendations may also result in unscheduled maintenance. ◀



Overview

Controls and features

Operation, maintenance

Owner service procedures

Technical data

Index

Overview

Controls

Maintenance

Repairs

Data

Index

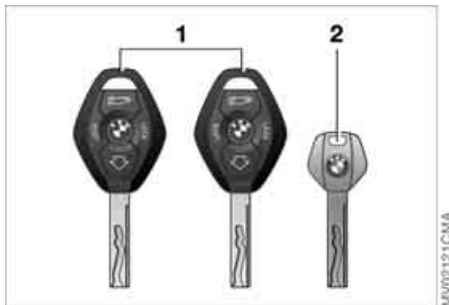

This key cannot be used to open the locks for the luggage compartment lid or the glove compartment. This can be advantageous for valet parking, for example. The key is not intended for constant use.

The key set

- 1 Each master key with remote control is powered by an extended-life battery that is charged automatically in the ignition lock as you drive. For this reason, use every master key at least twice a year to keep its battery charged. Depending on which master key is recognized when the vehicle is unlocked, different settings are called up and carried out in the vehicle, refer to Vehicle Memory, Key Memory on page 64.
- 2 Replacement key for storage in a safe place, e.g. your wallet.

Central locking system

The concept

The central locking system engages and releases the following locks at the same time:

- ▷ doors
- ▷ luggage compartment lid
- ▷ fuel filler door and
- ▷ glove compartment.

The central locking system is ready for operation whenever the driver's door is closed.

The central locking system can be operated

- ▷ from outside via the door lock and using the remote control
- ▷ from inside via the central locking system button.

If it is operated from inside, the fuel filler door will not be locked, refer to page 32.

Operating it from outside simultaneously activates the anti-theft system, which prevents the doors from being unlocked via the door lock buttons or the door release handles.

In the event of a sufficiently severe accident, the central locking system unlocks automatically. In addition, the hazard warning flashers and interior lamps come on.

Opening and closing – via the remote control

The concept

The remote control also provides two additional functions beyond the central locking feature:

- ▷ Switch on the interior lamps, refer to page 30.

With this function you can also search for your vehicle – when parked in an underground garage, for instance

- ▷ Open the luggage compartment lid, refer to page 30.

The luggage compartment lid will open slightly, regardless of whether it was locked or unlocked.

Whenever you unlock or lock the vehicle, you simultaneously deactivate/activate the anti-theft system and switch the interior lamps on/off.



You can have the signal confirming that the vehicle's locks have engaged securely deactivated. ◀

Master keys with remote control



Since passengers or animals remaining in the vehicle might be able to lock the doors from the inside, always take the vehicle's keys with you so that the vehicle can be opened again from the outside at any time. ◀



If it is no longer possible to lock the vehicle via the remote control, the battery is discharged. Use this key while driving for an extended period in order to recharge the battery. To prevent unauthorized use of the remote control, surrender only the spare key when leaving the vehicle for valet parking, for example.

In the event of a system malfunction, please contact your BMW center. You can also obtain replacement keys there. ◀



- 1 Unlocking and convenience opening
- 2 Locking and securing, turning on interior lamps,
- 3 Opening luggage compartment lid

To release



Press button to unlock the driver's door only.



Press the button twice in order to unlock the entire vehicle. ◀

Convenience opening mode

Press the button briefly and then keep it pressed. The windows and the fully-automatic convertible top open.

To lock and secure



Press button.

 As a confirmation that the vehicle's locks have engaged securely, the hazard warning flashers light up once. ◀

 You can have this confirmation signal deactivated. ◀

To switch on the interior lamps



After locking the vehicle, press button again.

With this function, you can also search for your vehicle when parked in an underground garage, for instance.

To open the luggage compartment lid



Press button briefly.

The lid will open slightly, no matter whether it was locked or unlocked.

 If the vehicle was previously locked, the luggage compartment is also locked again after it is closed. Before and after a trip, be sure that the luggage compartment lid has not been opened unintentionally. ◀

Panic mode* – trigger alarm



By pressing the button for more than 2 seconds, the alarm system* can be triggered in the event of danger, if the system is armed.

To switch off the alarm



Press button.

External systems

Malfunctions:

Local radio waves can impede the functioning of the remote control.

If this occurs, open and close the vehicle using a master key in the door lock.

For US owners only

The transmitter and receiver units comply with part 15 of the FCC Federal Communications Commission regulations. Operation is governed by the following:

FCC ID:

- ▷ LX8EWS
- ▷ LX8FZVS
- ▷ LX8FZVE.

Compliance statement:

This device complies with part 15 of the FCC Rules. Operation is subject to the following two conditions:

- ▷ This device may not cause harmful interference, and
- ▷ this device must accept any interference received, including interference that may cause undesired operation.

 Any unauthorized modifications to these devices could void the user's authority to operate the equipment. ◀

Opening and closing – via the door lock

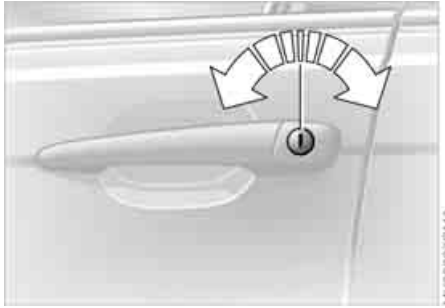

Convenience operation

With the door closed you can also operate the power windows and the convertible top with the door lock.

- ▷ To open: with the door closed after turning the key for the second time, hold the key in the Unlock position
- ▷ To fasten: with the door closed, hold the key in the Lock position.

 Whenever closing the windows or sliding/tilt sunroof you should always monitor their path and progress to ensure that no one is injured. Releasing the key stops the operation. ◀

Manual operation

If there is an electrical malfunction, you can unlock or lock the driver's door by turning the key in the lock all the way to the left or right.

Turning the key in the door lock once unlocks the driver's door, the fuel filler door and the glove compartment.

Turning the key a second time unlocks the passenger's door and the luggage compartment lid.

 As a confirmation that the vehicle's locks have engaged securely, the hazard warning flashers light up once. ◀

 You can have this confirmation signal deactivated. ◀

32 Opening and closing – from the inside



You can use this button to control the central locking system whenever the doors are closed. The doors and luggage compartment lid are unlocked or locked only. The anti-theft system is not activated.

 If only the driver's door was unlocked from the outside and you press the button, then, with the driver's door still open, the passenger's door, the luggage compartment lid, the fuel filler door and the glove compartment will unlock, too. If the driver's door is closed, it will be locked. ◀

 If you desire, the central locking system can be activated automatically as soon as you begin to drive. You may also have this adjusted so that it is specific to keys. ◀

To unlock and open the doors

1. Press the button for the central locking system
2. Pull the release handle above the armrest on the door you wish to open

or

pull the release handle for any door twice: to unlock and open the door.

To lock

- ▷ Either use the central locking button to lock both doors at once
- or
- ▷ press the individual door lock buttons down. As an added design feature to prevent the driver from being inadvertently locked out of the vehicle, the driver's door lock button will not engage as long as the door is open.

 Since passengers or animals remaining in the vehicle might be able to lock the doors from the inside, always take the vehicle's keys with you so that the vehicle can be opened again from the outside at any time. ◀

Luggage compartment lid

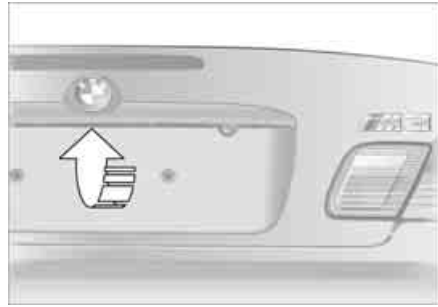
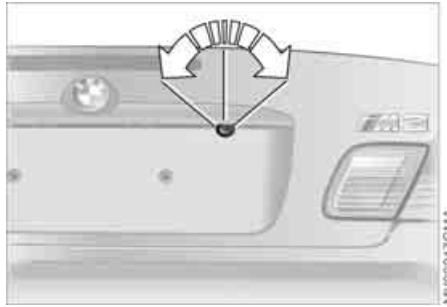

The lock

Only the master keys fit in the lock for the luggage compartment lid, refer to page 28.

To secure separately

Lock the glove compartment using the master key.

The luggage compartment lid is locked and disconnected from the central locking system. This feature can be used to prevent unauthorized access to the luggage compartment when you surrender the spare key only, refer to page 28. This can be advantageous for valet parking, for example.

To open from the outside

Press the button in the handle recess: the luggage compartment lid opens slightly.

The luggage compartment is lit when the luggage compartment lid is opened.

When the glove compartment is locked, refer to page 99, the luggage compartment lid cannot be opened using the button in the strip handle.

Manual operation

In the event of electrical malfunction
Turn the master key to the right as far as it will go, the luggage compartment lid will open slightly.

The luggage compartment lid is locked again as soon as you close the lid.

To open from inside the vehicle

If the luggage compartment lid has not been locked separately, you can open it with this button in the footwell on the driver's side when the vehicle is stationary.

34 Luggage compartment lid

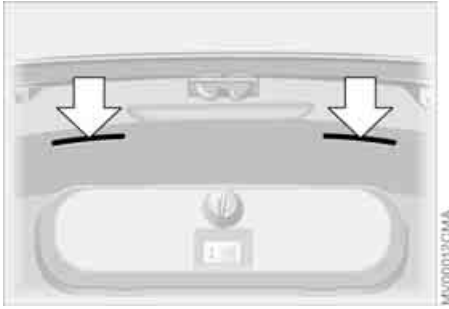



Should it be absolutely necessary to operate the vehicle with the luggage compartment lid open, with closed convertible top:

1. Close all windows
2. Greatly increase the quantity of air from the automatic climate control system, refer to page 96.

To close

The handle recesses in the interior trim panel of the luggage compartment lid make it easier to pull the lid down.

 To avoid injuries, be sure that the travel path of the luggage compartment lid is clear when it is closed, following the same precautions as with all closing procedures. ◀

 Operate the vehicle only when the luggage compartment lid is completely closed. Otherwise, exhaust fumes could penetrate the interior of the vehicle. ◀



Emergency release

This lever releases the luggage compartment lid from the luggage compartment's interior.

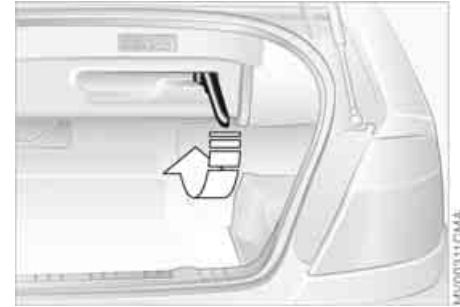
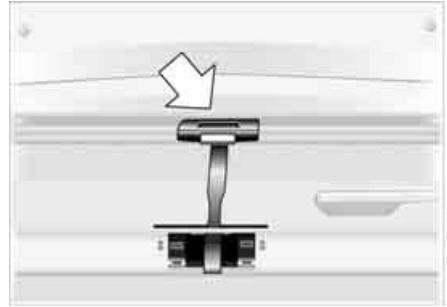
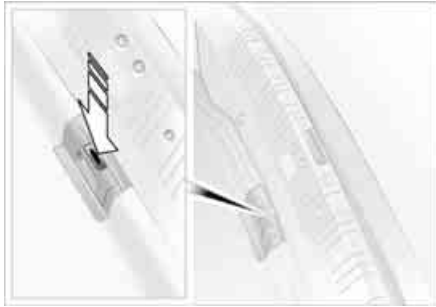

To fold up and secure the floor panel

1. Pull up at the handle and fold the panel up
2. Press the button to release the hanger from the handle

3. Hook the handle into the rubber seal of the drip rail.

 Carefully replace the hanger in its holder when lowering the floor panel back down. ◀

The fittings at the corners of the luggage compartment provide you with a convenient means of attaching luggage nets* and flexible straps for securing luggage.

Refer also to Cargo loading on page 104.

Enlarging luggage compartment

With the convertible top closed, you can enlarge the luggage compartment. To do this, flip the handle outward and press it down and toward the front of the vehicle. The convertible top compartment panel is now raised and secured.

To fold down the convertible top compartment panel

To open the convertible top, the convertible top compartment panel must be lowered. To do this, fold out the handle and pull opposite the direction of travel.



When opening the convertible top, refer to page 39, make sure that the convertible top compartment panel is folded down in the luggage compartment; otherwise you may damage something. ◀

The concept

The vehicle alarm system responds:

- ▷ When a door, the hood or the luggage compartment lid are opened
- ▷ To movement inside the vehicle – interior motion sensor
- ▷ To variations in the vehicle's tilt angle such as those occurring during attempts to steal the wheels or tow the vehicle – tilt alarm sensor
- ▷ To interruption of battery voltage.

The system responds to unauthorized vehicle entry and attempted theft by simultaneously activating the following:

- ▷ The acoustic alarm sounds for 30 seconds
- ▷ The hazard warning flashers are activated for approx. five minutes
- ▷ Flashing the high beams on and off in rhythm with the hazard warning flashers.

To arm and disarm the alarm system

When the vehicle is locked or unlocked via the remote control or the driver's door lock, the alarm system is also simultaneously armed or disarmed.



You can have a signal set as confirmation that the alarm system has been armed or disarmed. ◀



You can also open the luggage compartment lid when the system is armed by pressing the button of the remote control. When it is closed, the lid is once again secured.

Extended pressure on the button sets off the alarm – Panic mode, refer to page 30.

Alarm system*



Indicator lamp displays

- ▷ The indicator lamp below the interior rearview mirror flashes continuously: the system is armed
- ▷ The indicator lamp flashes immediately after the vehicle is locked: doors or luggage compartment lid are not completely closed. Even if you do not close the alerted area(s), the remaining areas are secured, and the indicator lamp will flash continuously after 10 seconds. However, the interior motion sensor is not activated
- ▷ The indicator lamp goes out immediately after the vehicle is unlocked: no manipulation or attempted intrusions have been detected in the period since the system was armed
- ▷ The indicator lamp flashes for 10 seconds immediately after the

vehicle is unlocked: an attempted entry has been detected in the period since the system was armed.

Following triggering of an alarm, the indicator lamp will flash continuously.

Tilt alarm sensor and interior motion sensor

Tilt alarm sensor:

The tilt of the vehicle is monitored. The alarm system reacts, for example, to attempts to steal the wheels or tow the vehicle.

Interior motion sensor:

The vehicle interior is monitored up to the height of the seat cushions. Even when the convertible top is open, the alarm system including the interior motion sensor is armed. Objects falling into the vehicle, e.g. leaves, can trigger unintentional alarms.

Avoiding unintentional alarms

The tilt alarm sensor and interior motion sensor may be switched off at the same time. You can do this to prevent a false alarm, e.g. in the following situations:

- ▷ In garages with elevator ramps

- ▷ When the vehicle is being transported by train
- ▷ When animals are to remain in the vehicle.

Deactivating the tilt alarm and interior motion sensors



- ▷ Press the button on the remote control twice.

The indicator lamp lights up briefly and then flashes continuously. The tilt alarm sensor and the interior motion sensor are deactivated until the vehicle is unlocked and locked again.



You can have the tilt alarm sensor and the interior motion sensor permanently deactivated. ◀



The system deactivates the tilt alarm sensor and the interior motion sensor if the convenience closing of windows and glass sunroof is interrupted within the first 10 seconds and then restarted. The vehicle must then be unlocked and relocked before the sensors will resume operation. ◀



To open and close windows

With the ignition key in position 1 or higher

- ▷ Press the switch until you feel resistance: the window continues to move as long as you continue to press the switch
- ▷ Press the switch briefly past the pressure point: the window moves automatically. Touching the switch again stops the opening cycle.

You can close the window in the same manner by pulling the switch. The rear windows do not close automatically.

Operating all windows at once

With the ignition key in position 1 or higher

- ▷ Press the switch until you feel resistance: all of the windows will continue to lower as long as you continue to press the switch
- ▷ Press the switch briefly past the pressure point: all windows will move automatically. Pressing the switch again stops the opening cycle.

You can close the windows in the same manner by pulling the switch. The windows cannot be closed automatically using this switch.

After the ignition has been switched off

You can still use the electric power windows for up to 15 minutes, as long as no one opens one of the doors.



When leaving the vehicle, always remove the ignition key from the lock and remember to close the doors to prevent children from operating the power windows and injuring themselves, etc. ◀

For the convenience mode via the remote control or the door lock, refer to page 29 or 31.

Trap protection

If the closing force of a front window exceeds a certain value as the window is being closed, the closing procedure is immediately interrupted and the window opens again slightly.

Electric power windows

 Despite trap protection, always make sure that the windows can close without obstruction, otherwise in some cases, e.g. with thin objects, it is not guaranteed that the closing operation will be interrupted. Trap protection is restricted when the switch is pulled and held beyond the pressure point. ◀

After a power loss

After the battery has been disconnected, the trap protection must be reinitialized. Perform the following procedure twice for each window:

- ▷ Open and close the window completely
- ▷ With the window closed, keep pulling the switch upward for approx. 1 second.

Convertible top

The completely automatically operated convertible top combines assured protection against the elements with simple and easy handling.

To gain maximum satisfaction from your convertible, please observe the following:

- ▷ It is advisable to close the convertible top when the vehicle is being parked. The closed convertible top not only protects the passenger compartment from unforeseeable damage from the weather, it also provides a certain degree of theft protection. In addition, keep valuables only in the locked luggage compartment, even when the convertible top is closed
- ▷ Never mount a roof-mounted luggage rack system on the convertible top.

 At temperatures below 14 °F / -10 °C do not operate the convertible top to prevent damage. Never store the convertible top in its compartment for more than one day while it is wet to avoid permanent damage from moisture. ◀

 Do not lay objects on the convertible top, as they could fall off when it moves, causing vehicle damage or personal injury. ◀

 Driving when the opening or closing process has not been completed can cause vehicle damage or personal injuries. Do not reach into the convertible top mechanism during opening and closing. Keep children away from the moving parts of the convertible top during operation. ◀

 If possible, only operate the convertible top with the vehicle stopped, as otherwise the process may be interrupted. If you set the convertible top in motion with the vehicle stationary and then have to start suddenly – for instance, at a traffic light – you can still complete the operation by driving as slowly as possible and again pressing and maintaining pressure on the button. ◀

 To close the electric power windows while driving, always be sure to first close either the rear windows, or all 4 windows at the same time, otherwise, at high speed, the windows may not close tightly. ◀

 At higher speeds, the ensuing vacuum in the passenger compartment can cause the convertible top to begin fluttering. Increase the air supply via the ventilation controls so that a vacuum does not occur in the vehicle. ◀

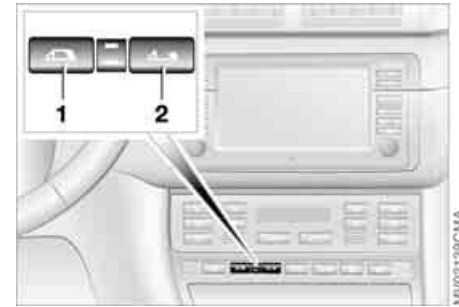

Opening and closing

- 1 To close
- 2 To open

 To avoid placing unnecessary loads on the battery, you should avoid operating the top when the engine is switched off. Before closing the convertible top, remove any objects from the windshield frame that could keep the convertible top from closing properly. ◀

With the ignition key in position 1 or higher, and with the vehicle stationary

1. Read and comply with the preceding safety precautions

Convertible top

2. Ensure that the convertible top compartment panel in the luggage compartment is folded down, refer to page 35; otherwise, it will not be possible to open the convertible top
3. Make sure that the luggage compartment lid is closed
4. Press and hold the corresponding button for convertible top operation. It can take a few seconds until the opening or closing procedure starts.

 The luggage compartment lid cannot be opened while the convertible top is in motion. ◀

 During convertible top operation the rear window moves toward the passenger compartment. To prevent injuries, make sure that the closing path of the convertible top is unobstructed. ◀

 After having been stored for an extended period of time in the convertible top compartment, e.g. during the winter months because the hardtop was being used, you may have to support the convertible top by hand when closing it for the first time. If the convertible top should halt right before the closing phase is completed, press against the front part of the convertible top frame from the outside to help the closing process along. Keep pressing the button while doing so until the top starts up again on its own. ◀

Indicator lamps

- ▷ The red indicator lamp is lit whenever the convertible top is in motion. It goes out as soon as the opening or closing operation has been completed
- ▷ If the red indicator lamp flashes after the button is released, the convertible top has not yet been opened or closed completely. You can resume operation in the desired direction by pressing the button again
- ▷ If the yellow indicator lamp lights up continuously with the button pressed, the convertible top compartment panel has been raised and the top cannot be moved.

The side windows move down slightly whenever the button for operating the convertible top is pressed.

They will go back up if you keep holding the button down for more than 2 seconds after the opening or closing process has been completed and the indicator lamp has gone out.

Interruption

The convertible top stops moving immediately when the button is released. You can resume operation in the desired direction by pressing the button again.

 Do not close the side windows using the power window switches if the convertible top has not been closed completely. Otherwise, the side windows may not seal properly with the rubber seals of the convertible top. ◀

If the opening or closing operation is interrupted by releasing the buttons, the convertible top remains in the respective position for 15 minutes before it slowly moves into a stable position. The operation can be continued by pressing the buttons.

42 Convertible top

 Do not repeatedly interrupt and resume the closing operation, as otherwise the fully-automatic convertible top mechanism could be damaged. ◀

In certain cases, the luggage compartment lid cannot be opened if the opening or closing operation has been interrupted.

 Operate the convertible top manually in emergency situations only to avoid causing damage due to incorrect operation. ◀

Convenience operation via remote control and driver's door lock

Refer to pages [29](#) and [31](#).



Closing manually in the event of an electrical malfunction

- 1 Emergency operation
- 2 Allen wrench
- 3 Recess

 Only operate the convertible top manually to close it. Never open it manually since the convertible top compartment lid cannot be locked and would open during driving. ◀

 Manual closing is best carried out by two persons from outside with the driver's door open and the driver's seat folded forward. No one is to be in the rear seat while you are doing this. ◀

1. Remove the center piece between the rear seats. Take the trim off of the guide rod and flip it forward
2. Press down hard on the emergency lock 1 – see previous illustration. After a brief pause, the mechanisms for the convertible top compartment lid will be released

 If the mechanism for the convertible top compartment lid does not unlock, then insert the Allen wrench 2 into the recess 3 and turn clockwise to release it. ◀

3. If the luggage compartment lid is closed, open the convertible top compartment lid up as far as the stop will allow



▶ Please consult your BMW center to have the defect corrected. ◀

4. Grasp the convertible top by the lateral guide section – see arrow 1 – and the front convertible top frame – see arrow 2. Lift out the top and swing forward until you encounter a perceptible resistance at a stop. Position the rear convertible top frame vertically and close the convertible top compartment lid. Fold down the rear convertible top frame

 To avoid damaging the side trim, always fold the convertible top forward before folding the rear frame brace up into its vertical position. ◀

5. Use a screwdriver to lift out the cover panel that is in the center of the front convertible top frame
6. Insert the Allen wrench 2 – refer to page 42 – into the recess – see arrow
7. Pull down on the front convertible top frame as far as possible. Close the convertible top further by turning the wrench in a clockwise direction; continue turning until the front convertible top frame is locked to the windshield frame. The rear convertible top frame will automatically be pressed down onto the convertible top compartment lid and, because of the tension, will close completely.

 The closing operation must be completed, as otherwise damage and/or injuries may result. ◀

44 Convertible top



Position for cleaning

To be able to access the convertible top compartment, lean the rear frame of the convertible top against the cover of the convertible top compartment.

▶ First, use the button for activating the convertible top to unlock the locks of the convertible top compartment. Refer to page 40. ◀

▶ For additional information on vehicle care, refer to the Caring for your vehicle brochure. ◀

Wind deflector*

With the convertible top open, the wind deflector keeps air movement in the passenger compartment to a minimum, thus providing you with a pleasant drive, even at higher speeds. The wind deflector comes in a protective sleeve, and because of its slim dimensions, can be easily stored in the luggage compartment.

Installation

1. Remove wind deflector from the protective sleeve

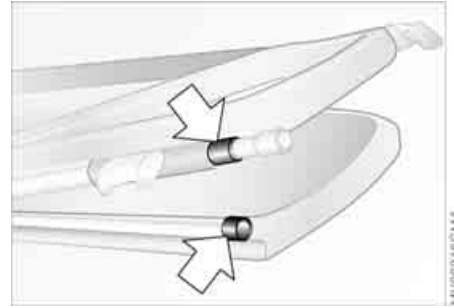

2. Flip out both sides and lock into place. It is essential for the two components marked in the illustration to mesh at this point

Wind deflector*



3. Hold the wind deflector so that the smaller half points toward the front and guide the mounting pin for the side piece into the proper opening
4. Pull back on the mounting pin for the other side piece by using a slide, so that the mounting pin can be guided into the opening provided
5. Unlock the convertible top compartment lid via the convertible top control button, refer to page 40, and open the convertible top compartment lid
6. Flip the back half of the wind deflector backward, so that the mounts are lying on the vehicle

7. Close the convertible top compartment lid via the convertible top control button. The wind deflector is now attached so that it is theft-proof.

 Operate the convertible top compartment lid from above only in order to avoid any pinching. With the wind deflector in place: to avoid damaging the wind deflector never push the front seats all the way back. ◀

Removal

Follow the same procedure as when installing, just reverse the steps.

46 Safe seating position

For driving that is relaxed and less likely to cause fatigue, you should select a sitting position that reflects your personal requirements. In combination with the safety belts and airbags, the correct seating position also plays an important role in enhancing occupant safety in the event of an accident. To ensure that the vehicle's safety systems provide you with optimal protection, we request that you direct your careful attention to the following section.

For supplementary information on transporting children, refer to page 58.

Airbags



Always maintain an adequate distance between yourself and the airbags. Always hold the steering wheel by the rim to keep any chance of injury to hands or arms to an absolute minimum should the airbag be deployed. Never allow any objects, individuals or animals to obstruct the areas between passengers and airbags. Never use the front airbag's cover as a storage tray or support for objects of any kind. Never allow front passengers to rest their feet or legs on the airbag cover. ◀

For airbag locations and additional information on airbags, refer to page 55.

Safety belt

Your vehicle is equipped with four seats, each of which is provided with a safety belt.



Never allow more than one person to wear a single safety belt. Never allow infants or small children to ride in a passenger's lap. Avoid twisting the belt while routing it firmly across the pelvis and shoulder, wear it as snugly against your body as possible. Do not allow the belt to rest against hard or fragile objects in your pockets. Do not route the belt across your neck, or run it across sharp edges. Be sure that the belt does not become caught or jammed. Avoid wearing bulky clothing and pull on the lap belt periodically to retension it over your shoulders. In the event of a frontal impact, a loose lap belt could slide over the hips, leading to abdominal injury. In addition, the safety belt's restraint effectiveness is reduced if the belt is worn loosely. Expectant mothers should always wear their safety belts, taking care to position the lap belt against the lower hips, where it will not exert pressure against the abdominal area. ◀

For information on using the safety belts, refer to page 50.

Seats

When adjusting your seat, always observe the following precautions

 Never try to adjust your seat while operating the vehicle. The seat could respond with an unexpected movement, and the ensuing loss of vehicle control could lead to an accident. Never ride with the backrest reclined to an extreme horizontal angle – important for front passengers to remember. If you do, there is a risk that you will slide under the safety belt in an accident, thus reducing the protection provided by the safety belt. With the wind deflector in place: Do not push the front seats all the way back, otherwise the wind deflector will be damaged. ◀

Adjusting the seats

- ▷ Power seat adjustment, refer to page [47](#)
- ▷ Head restraint, refer to page [48](#)
- ▷ Entering the rear, refer to page [49](#)

Power seat adjustment



Seat adjustment

- 1 Tilt angle
- 2 Forward/backward adjustment
- 3 Height
- 4 Backrest angle

You can manually adjust the thigh support.

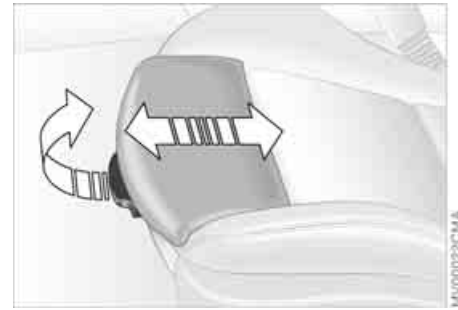

Thigh support

Pull the lever and adjust the position of the cushion for thigh support as desired.



Adjusting the lumbar support*

You can adjust the backrest's contour to support the lordosis of the spine, i.e. the curvature of its lumbar section.

The upper hips and spinal column receive supplementary support to help you maintain a relaxed, upright position.

- ▷ To increase or decrease the curvature: press front or rear of the switch.
- ▷ To shift the curvature up or down: press the upper or lower part of the switch.

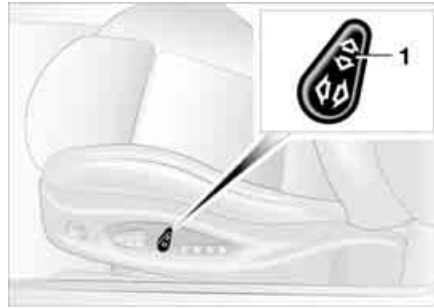

Front head restraints

1 Height

 Head restraints reduce the risk of spinal injury in the event of an accident.

Adjust the head restraint.

When moving the head restraints up or down, do not grab on between the head restraint and the upper edge of the backrest to avoid the possibility of injury. ◀



Tilt:

Position the head restraints manually in the preferred position.

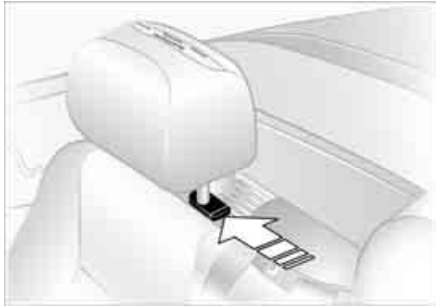

Rear head restraints

 The rear head restraints may only be lowered if there are no passengers in the rear seats. If you do so, you are in violation of the law. Raise the rear head restraints before taking on any passengers in the back. ◀

To completely lower the rear head restraints:

1. Press the button and hold it down
2. Push the head restraint down from above.

Raising the rear head restraints

Raise the head restraints until you hear them click into place.

 Do not remove the rear head restraints as this would damage them. ◀

For further information, please consult your BMW center.

 Do not use the rear head restraints as storage shelves. Always keep the travel path for the roll-over protection system free and clear. Under no circumstances should you put any kind of cover such as an antimacassar on the head restraints, refer also to the labeling on the head restraints. ◀

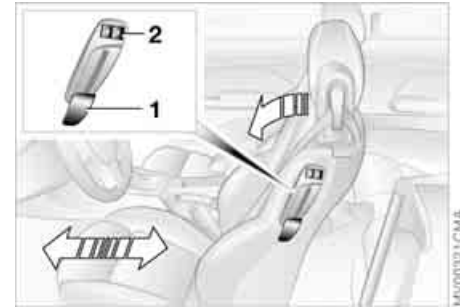

The seat-integrated safety belt system allows for easy access to the rear.

1. Lift lever 1 up and tilt the backrest forward until it engages
2. Press and hold button 2 in driving direction until the seat moves to the desired position
3. After entering the rear, fold back and lock the backrest
4. Press button 2 opposite the direction of travel and hold. The seat moves back into its previous position. If the button 2 is released beforehand, the seat stops in the respective position.

 The seat can be locked into position when it is tilted forward. This is particularly convenient when entering the vehicle on an incline, for example. Press against the backrest until you hear it snap into place. Lever 1 does not have to be released to fold the seat back. ◀

 Lock both backrests while driving, otherwise there is a danger of an unexpected movement causing an accident. ◀

 The indicator lamp in the instrument cluster flashes when the backrest is not locked, refer to page 18.

Safety belts



Always wear your safety belt

Always fasten your safety belt before starting off. As supplemental restraint devices, the airbags are designed to enhance the effectiveness of the safety belts, and not to replace them.

 Before putting your safety belts on in the rear, take them out of the holder. ◀

 Leave the rear safety belts in the holders if they are not needed, in order to avoid unwanted movement from the safety belts at high speeds. ◀

To close

Make sure you hear the lock engage in the belt buckle.

To release

1. Press the red button in the belt buckle
2. Hold the belt
3. Guide the belt back into its reel.

Safety belt height

The front safety belt automatically adapts to your body size via the setting of the head restraint height, refer to page 48.

 If the safety belt system has been subjected to the stresses involved in an accident or otherwise damaged: have the entire safety belt mechanism replaced by your BMW center, including the safety belt tensioner. In addition, have your BMW center inspect the safety belt anchors. If a child-restraint system was in the vehicle during an accident, consult the manufacturer's instructions regarding replacement. ◀

Seat and mirror memory

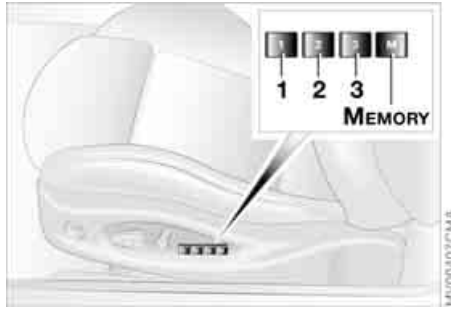

You can store and recall three different driver's seat and outside mirror positions.

 Memory will not retain the adjustment made to the lumbar support. ◀

To store

1. Ignition key in position 1 or 2
2. Adjust your seat and outside mirrors to the desired position
3. Press the MEMORY button: the indicator lamp in the button lights up
4. Press memory button 1, 2 or 3, as desired. The indicator lamp goes out.

To select a stored setting

 Do not select a memory position while the vehicle is moving. If you do so, there is a risk of accident from unexpected seat movement. ◀

Driver's door open after unlocking or ignition key in position 1:

- ▷ Briefly press memory button 1, 2 or 3, as desired.
- Movement stops immediately when one of the seat-adjustment or memory buttons is operated during the adjustment process.

With the driver's door closed and the ignition key either removed or in position 0 or 2:

- ▷ Press and hold the desired memory button – 1, 2 or 3 – until the adjustment process is completed.

If you press the MEMORY button accidentally: press the button again; the indicator lamp goes out.

 You can have this feature programmed so that when you use the remote control from your personalized key to unlock your door, your seat and the exterior mirrors will move into your own preferred positions. ◀

 Before activating the programmed adjustment feature, ensure that the footwell behind the driver's seat is empty and unobstructed. If you fail to do so, persons, animals or objects could be injured or damaged if the seat should move backward. ◀

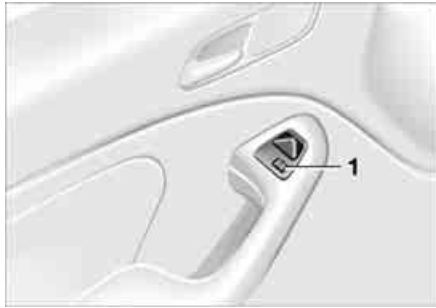

How far the passenger mirror tilts can be set individually for each ignition key. ◀

Passenger-side exterior mirror tilt function

Automatic curb monitor*

To activate:

1. Select the driver's mirror using the mirror selector switch 1
2. When shifting into Reverse or placing the selector lever in position R, the passenger-side mirror tilts downward. This allows the driver to see the area directly adjacent to the vehicle, e.g. the curb, during parking.

To deactivate:

Set the mirror selector switch to the passenger-side position.

Seat heating*

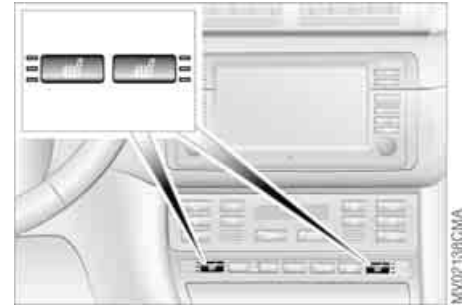



The seat cushion and backrest can be heated with the ignition key in position 2.

You can call up different heating modes by repeatedly pressing the buttons.

You can also switch the higher heating modes off directly:

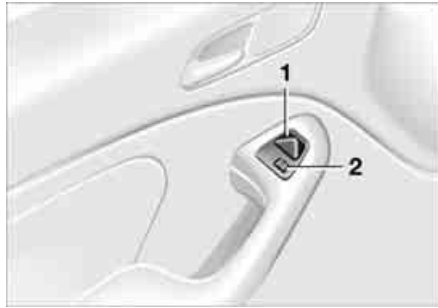
Press the button and hold it slightly longer.



 The mirror on the passenger's side is more convex than the driver's mirror. When estimating the distance between yourself and other traffic, bear in mind that the objects reflected in the mirror are closer than they appear. This means that when you are estimating the distance to following vehicles, the mirror is not necessarily a reliable aid. This also applies to the outer parts of each mirror. ◀

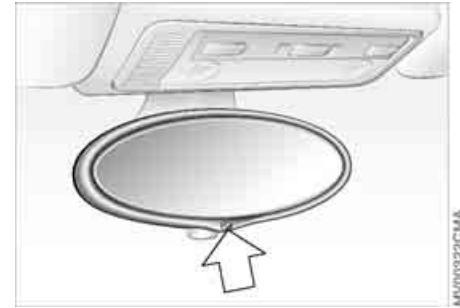

To adjust exterior mirrors

- 1 Switch for 4-way adjustment
- 2 Switch to select between mirrors

To adjust manually

The mirrors can also be adjusted manually:

Press the edges of the lens.

To store the mirror setting, refer to Seat and mirror memory on page 51.

Curved mirror

The outer part of each mirror conveys a slightly distorted, larger field of vision than the inner part of the mirror. This helps to extend your range of vision toward the rear and to reduce the size of the blind spot.

Electric defrosting

Both mirrors are heated automatically in ignition key position 2.

Interior rearview mirror with automatic dimming feature

While the vehicle is being driven forward, this mirror dims light through an infinitely variable range depending on the light's incidence. Two photocells in the interior rearview mirror serve this purpose. One is positioned in the mirror's frame, while the other is slightly offset on the opposite side of the mirror.

To ensure perfect functioning, keep the photocells clean and the area between the interior rearview mirror and the windshield free of any obstruction like stickers, etc.

54 Steering wheel

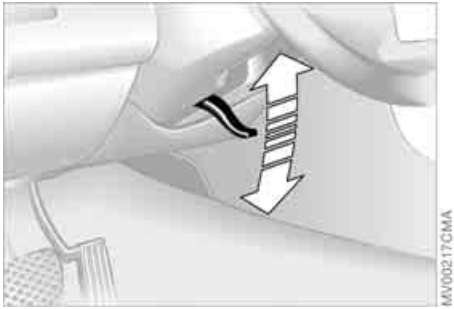

To adjust



Never attempt to adjust the steering wheel while driving the vehicle – it could respond with unexpected movement, posing a potential accident hazard. ◀

1. Push the locking lever downward
2. Adjust steering column reach and height for your selected seating position
3. Pull the lever back up.

Airbags

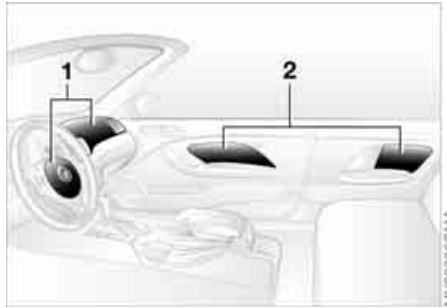

- 1 Front airbags on the driver and passenger sides
- 2 Side airbags on the driver and passenger sides – front and rear*

Protective effect

The front airbags protect the driver and passenger in the event of a head-on collision where the protection provided by the safety belt alone would not be adequate. The side airbags provide protection in the event of a collision from the side. They help support the respective seat occupant's upper body.

For information on the correct sitting position, refer to page 46.

▶ The side airbags in the rear passenger area* of your vehicle may already have been deactivated by a BMW center. You may have them activated if you desire to do so. Please contact your BMW center for additional information. ◀

▶ The airbags will not be triggered in the event of a minor accident, certain vehicle rollover situations or collisions from the rear. ◀

⚠ Do not apply adhesive materials to the cover panels of the airbags, cover them or modify them in any other way. Do not attempt to remove the airbag restraint system from the vehicle. In the event of a malfunction, deactivation or triggered activation – as a response to an accident – of the airbag restraint system, consult your BMW center for inspection, repair or disassembly. Modifications may not be made on either the wiring or the individual components in the airbag system. These include the upholstered covers on the steering wheel, instrument panel, side trim panels of the doors and front roof pillars and on the sides of the headliner. Do not attempt to remove or dismantle the steering wheel. Unprofessional attempts to service the system could lead to failure in an emergency or undesired airbag activation, either of which could result in personal injury. Do not touch the individual components directly after the system has been triggered, as otherwise there is a danger of burns. ◀



At all times, occupants should sit upright and be properly restrained – infants and small children in appropriate child-restraint systems; larger children and adults using the safety belts. Never let an occupant's head rest near or on a side airbag because the inflating airbag could cause a serious or fatal injury. Please note that the word Airbag imprinted on the door trim panel indicates the airbag's location.

Accident research shows that the safest place for children in an automobile is in the rear seat. However, a child sitting in the rear seat and not properly restrained may place his or her head on or near the side airbag, if so equipped. For example, a child – even though belted – may fall asleep with his or her head against the side airbag. It may be difficult for a driver to ensure that children in the rear seat will remain properly positioned at all times and not place their heads on or near the side airbag. Therefore, we recommend that the rear seat side airbags, if provided, be deactivated if you plan to transport children in the rear seat.

The rear seat side airbags may already have been deactivated by a BMW center. If you are uncertain of their status, or wish to have the airbags activated or

deactivated, please contact your BMW center. ◀

Even when all these guidelines are observed, there is still a small residual risk of injuries to the face, hands and arms occurring from airbag deployment in isolated instances.

In sensitive individuals, the ignition and inflation noise may induce a mild hearing loss that is temporary in most cases.

Airbag warning information is also provided on the sun visors.



This is the right way a child should sit in a child restraint when rear side airbags are provided.

Airbags



 If there is a system malfunction, there is a risk that the airbags will not be triggered within their normal response range, even if the level of impact would normally have triggered them. Have your BMW center inspect the airbag system immediately. ◀

This is the right way a larger child should sit wearing the seat belt when rear side airbags are provided.

Indicator lamp



The indicator lamp indicates the operational status of the airbag system when the ignition key is in position 1 or higher.

System operational:

- ▷ The indicator lamp comes on briefly when the ignition key is turned to position 1 or higher.

System malfunction:

- ▷ Indicator lamp does not come on or
- ▷ indicator lamp lights up continuously.

 Leave the rear safety belts in the holders if they are not needed to avoid unwanted movement from the safety belts at high speeds. ◀

Commercially available child seats complying with the legal standard are designed to be secured with a seat belt or with the seat belt portion of a combination lap/shoulder belt. Improperly or inadequately installed restraint systems can increase the risk of injury to children. Always read and follow the instructions that come with the system.

Correct location for installing

In your BMW, all seats equipped with a three-point safety belt – except for the driver's seat – are suitable for installing universal child-restraint systems of all age classes and which have been approved for the age group in question.

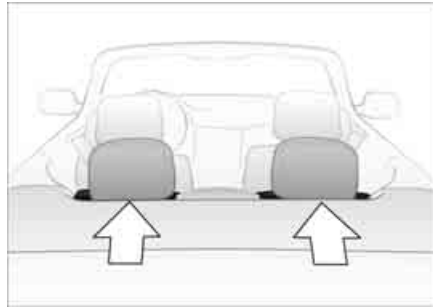

Child-restraint system with tether strap

If you use a child-restraint system with a tether strap, two additional tether anchorage points have been provided.

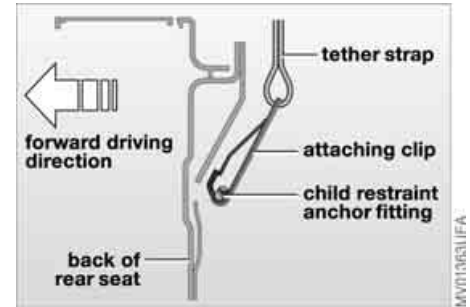

Depending on the location selected for seating in the rear passenger area, attach the tether strap to the corresponding anchorage point to secure the child-restraint system, as shown in the illustration.

1. Open the convertible top compartment lid, refer to page 39
2. Lift the headrest and pass the tether strap between the headrest and the seat back. It is recommended that you return the head restraint back to its lowest possible position
3. Adjust the tether strap according to the child-restraint manufacturer's instructions
4. Close the convertible top compartment panel.

It is recommended to cover the child-restraint attaching clip with a soft material to prevent damage to the stored soft top.

 Should a hard top be installed, the fitting of child harness tether strap/s – if child seat is required – is necessary before installation of the hard top. ◀



Before installing any child-restraint device or child seat, please read the following: Never install a rearward-facing child-restraint system in the front passenger seat of this vehicle.

Your vehicle is equipped with an airbag supplemental restraint system for the front passenger. Because the backrest on any rearward-facing child-restraint system – of the kind designed for infants under 1 year and 20 lbs/9 kg – would be within the airbag's deployment range, you should never mount such a device in the front passenger seat, as the impact of the airbag against the child restraint's backrest could lead to serious or fatal injuries.

If it is necessary for a child – not an infant – to ride in the front seat, certain precautions should be taken. First, move the passenger seat as far away from the instrument panel as possible. This important precaution is intended to maximize the distance between the airbag and the child. Older children should be tightly secured with the safety belt after they have outgrown a booster seat that is appropriate for their age, height, and weight.

Younger children should be secured in an appropriate forward-facing child-

restraint system that has first been properly secured with a safety belt. Never install a rearward-facing child-restraint system in the front passenger seat.

We strongly urge you to carefully read and comply with the instructions for installation and use provided by the child restraint's manufacturer whenever you use such a device.

Do not attempt to modify child-restraint systems. If you do this, the protection provided by these systems could be impaired.

Be sure that all occupants – of all ages – remain properly and securely restrained at all times. ◀

All rear seating positions in your vehicle meet the recommendations of SAE J1819, an industry-recommended practice for securing child-restraint systems in motor vehicles.

60 Transporting children safely



The belt cannot be extracted further. Always observe the installation instructions provided by the manufacturer of the child-restraint system.

To unlock the safety belt

Release the safety belt, remove the child seat and retract the safety belt to its end position on the belt retractor.

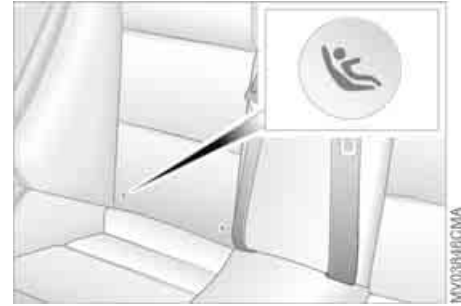

Securing child-restraint system

All of the rear belt retractors and the front passenger's safety belt can be locked for mounting and securing child-restraint systems.

A label with the appropriate instructions for this is located in the immediate vicinity of the buckle latch of each safety belt.

To lock the safety belt

Extract the entire length of the belt from the inertia reel mechanism. Allow the reel to retract the belt somewhat and engage the buckle, then tighten the belt against the child-restraint system. The retraction mechanism is now locked.

LATCH child-restraint mounting system

LATCH: Lower Anchors and Tether for Children

The left and right rear seats are both equipped with a LATCH child-restraint mounting system.

Transporting children safely

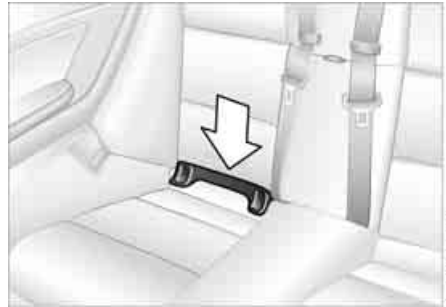
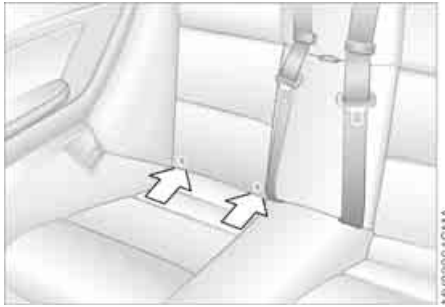

The LATCH anchorage points are identified by symbols.

The anchorage points for the LATCH child-restraint system installation are located behind the upholstery at the positions indicated by the arrows.

Carefully slide the brackets through the gaps in the upholstery at the indicated locations.

⚠ Always follow all manufacturer's instructions and observe all safety precautions when installing the LATCH child-restraint mounting system. Leave the rear safety belts in the holders if they are not needed to avoid unwanted movement from the safety belts at high speeds. ◀

To prevent damage to the upholstery, you can purchase an insertion aid* from your BMW center.

Firmly press the insertion aid into the gap between the seat cushion and backrest, continuing until the two guides snap into place on the LATCH brackets in the seat.

The illustration is an example showing the anchorages for a LATCH child-restraint system on the right rear seat.

62 Rollover protection system

In the event of an accident or some other critical driving situation – extreme tilting in the longitudinal or transverse axis, loss of contact with the ground – the rollover protection system will be automatically activated. The protective bars located in the rear head restraints extend within fractions of a second.

In addition to the integrated rollover bar in the windshield frame, the rollover protection system affords all the vehicle occupants necessary headroom.



Always keep the travel path for the rollover protection system free and clear. Under no circumstances should you cover the head restraints. In the event of less serious accidents, the safety belt will protect you and, depending on the severity of the accident, so will the safety belt tensioner and the multi-stage airbag restraint system as well. ◀

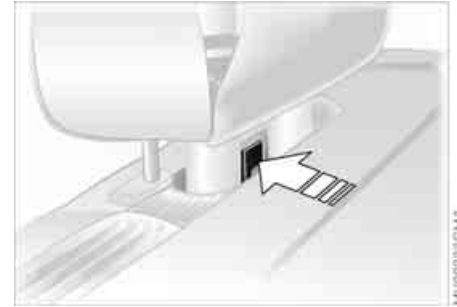
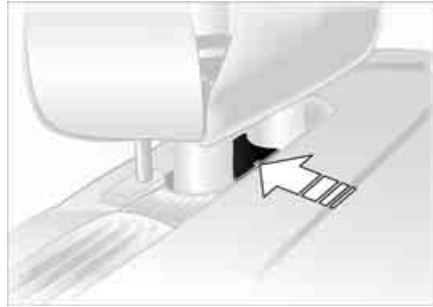

If, after being automatically triggered, the protective function is not needed, then the rollover protection system can be lowered back into place. No special tool is needed for this.

1. Using a screwdriver from the onboard tool kit, remove the cover panel; to do this, position the screwdriver under the notch

2. Push the lever toward the front of the vehicle and keep it in this position

Rollover protection system

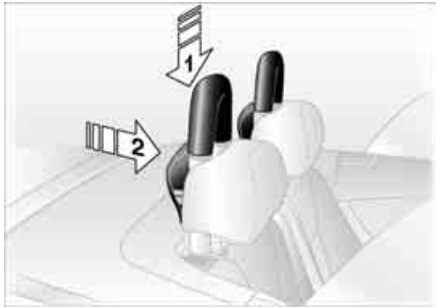

3. Keep pressing down on the protective bar from on top – see arrow 1 – until you hear it click into place
4. Put the cover panel back in place and press down firmly
5. Push the back panel of the head restraint closed – see arrow 2.

Do the same for the second protective bar. If you are not familiar with any of the procedures, consult your BMW center.

Have the rollover protection system checked out by your BMW center after it has been inadvertently triggered.



Do not move the convertible top under any circumstances if the rollover protection system has extended.

Do not use the rear head restraints as storage shelves.

Absolutely no modifications are to be made to any of the rollover protection system's individual components or any of its wiring.

Only your BMW center is to carry out any work on the rollover protection system.

Work done on the system that is carried out improperly could lead to failure in an emergency or accidental activation. Regarding having the system checked to ensure long-term operation: be scrupulous in adhering to the Service Interval Display for maintenance intervals. Every two years at the latest, the rollover protection system must be inspected by a BMW center. ◀

How the system functions

You have probably frequently wished that you could configure individual functions of your vehicles to reflect your own personal requirements. In engineering your vehicle, BMW has provided for a number of options for personal adjustment that can be programmed into your vehicle at your BMW center.

The available configuration data fall into two categories, according to whether their primary orientation is the vehicle – Vehicle Memory – or the individual – Key Memory. You can have up to four different basic settings adjusted for four different persons. The only requirement is that each person uses his or her own remote control key.

When your vehicle is unlocked with the remote control, the vehicle recognizes the individual user by means of a data exchange with the key, and makes adjustments accordingly.

**Distinguishing between keys**

In order for you to be able to distinguish between different keys, colored decals are supplied together with the keys.

What the system can do

Your BMW center can provide you with details on the possibilities that the Vehicle and Key Memory systems offer.



You will see this symbol throughout the Owner's Manual. It is to remind you at appropriate places of the settings that are available to you. ◀

Examples for Vehicle Memory:

- ▷ Various signals that can serve as acknowledgment for locking and

unlocking the vehicle, refer to page 29

- ▷ Activates/deactivates the 'Follow me home' lamps function, refer to 90
- ▷ Activates/deactivates daytime driving lamps, refer to page 90
- ▷ Sets the units of measure for displaying time, outside temperature, distance traveled and fuel consumption in the instrument cluster
- ▷ When you shift into Reverse, an acoustic signal indicates that PDC has been activated, refer to page 85
- ▷ Switches on rear window defroster automatically, refer to page 97
- ▷ After giving an ice warning, the onboard computer display returns to the previous setting, refer to page 83.

Examples for Key Memory:

- ▷ Locks the vehicle automatically after you start off, refer to page 32
- ▷ Automatically moves the seat and outside mirror into position for the programmed driver when unlocking the vehicle, refer to page 51
- ▷ Automatic tilting of the passenger-side mirror, refer to Automatic curb monitor, page 52
- ▷ After the engine is started, calls up the last selected driving program for each shifting mode, refer to page 73.

Ignition lock

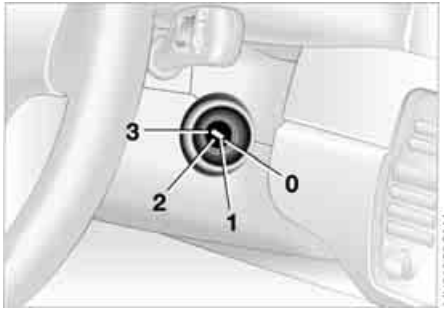

Steering unlocked

You will find that it is often easier to turn the ignition key from position 0 to position 1 when you move the steering wheel slightly to help disengage the lock.

Individual electrical accessories are ready for operation.

Ignition key positions

- 0 Steering locked
- 1 Steering unlocked
- 2 Ignition on
- 3 Start engine

Steering locked

The key can only be inserted and removed in this position.

After removing the key, turn the steering wheel slightly to the left or right until you hear the lock engage.

If the key is not removed, an acoustic signal sounds when the driver door is opened.

 Do not allow the engine to warm up by leaving it running while the vehicle remains stationary. Instead, drive off immediately at a moderate engine speed. ◀

 Do not allow the engine to run in enclosed spaces. Otherwise, breathing the exhaust fumes can lead to unconsciousness and death. The exhaust gases contain carbon monoxide, an odorless and colorless, but highly toxic gas. Do not leave the vehicle unattended with the engine running. An unattended vehicle with a running engine represents a safety hazard. If you leave the vehicle with the engine running, move the gearshift lever into the idling position or the selector lever into position N, as applicable, and apply the parking brake. If you fail to do this, the vehicle could move. ◀

- ▷ Do not press the accelerator pedal while starting the engine
- ▷ Do not end the starting procedure too early, but do not continue it for more than 20 seconds
- ▷ Release the ignition key immediately when the engine starts

- ▷ Do not let the engine warm up in idling position. Instead, begin to drive at moderate engine speeds.

If the engine does not start on the first attempt – if it is very hot or cold, for instance:

Press the accelerator pedal halfway down while engaging the starter.

Cold starts at very low temperatures below about +5 °F/–15 °C and at high altitudes above 3,300 ft/1,000 m:

- ▷ On the first attempt, engage the starter for approx. 10 seconds
- ▷ Press the accelerator pedal halfway down while engaging the starter.

 Extended starting attempts, characterized by excessively frequent or long periods with the starter engaged, can damage the catalytic converter. ◀

 When driving, standing at idle or parking the vehicle, take care to avoid contact between the hot exhaust system and flammable materials – grass, hay, leaves, etc. Such contact could lead to a fire, resulting in serious personal injury and property damage. ◀

Manual transmission

1. Engage the parking brake
2. Gearshift lever in idling position
3. Depress the clutch pedal.
If the clutch pedal is not depressed, the engine cannot be started
4. Start the engine. Do not press the accelerator pedal. Do not actuate the starter for too short a time. Do not turn it for more than approx. 20 seconds. Release the ignition key immediately when the engine starts.

Sequential M gearbox with Drivelogic

1. Depress footbrake
2. Move selector lever into position N
3. Start the engine. Do not actuate the starter for too short a time. Do not turn it for more than approx. 20 seconds. Release the ignition key immediately when the engine starts
4. Engage a driving position
5. Release footbrake and slowly depress accelerator pedal.

Starting the engine and driving off



With the engine running, the gear indicator in the SMG Drivelogic display flashes to indicate that a driving position is engaged with the driver's door open or if the hood is not closed properly, refer to page 71.

If neither the pedals, the shift paddles, nor the selector lever are actuated, then the gearbox is automatically taken out of gear after approx. four seconds. It will then be necessary to move the selector lever back to position N before engaging the desired driving position. Driving off is not possible with the hood open. ◀



Before exiting the vehicle with the engine running, move the selector lever into position N and apply the parking brake.

Never leave the vehicle unattended with the engine running. An unattended vehicle with a running engine represents a safety hazard. ◀

Engine idle speed is controlled by the engine computer system. Increased speeds at start-up are normal and should decrease as the engine warms up. If engine speed does not decrease, service is required.

To prevent the battery from discharging, always deactivate electrical devices that are not in use. Switch the ignition off when the vehicle is not being driven.

68 Switching off the engine

 You should never remove the ignition key when the vehicle is in motion, as the steering lock could engage. When you leave the vehicle, always remove the ignition key and engage the steering lock. ◀

 Always engage the parking brake when parking on downhill roads. Engaging a gear may not provide adequate resistance to rolling. ◀

Manual transmission

Turn the ignition key to position 1 or 0.

Sequential M gearbox with Drivelogic

If you turn the ignition key to position 1 or 0 with the selector lever in the forward or reverse position, a gear automatically remains engaged.

If you turn the ignition key to position 1 or 0 with the selector lever in position N, a warning tone and the flashing gear indicator in the SMG Drivelogic display remind you that no gear is engaged to secure the vehicle against rolling.

The warning stops after approx. ten seconds. If you move the selector lever into a forward or reverse position during this time, a gear is automatically engaged.

Parking brake

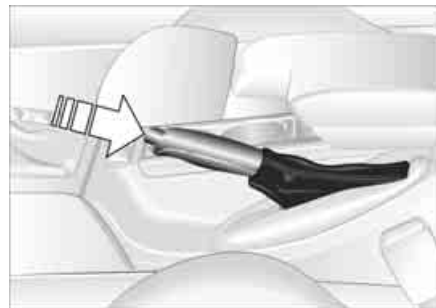

The parking brake is primarily designed to prevent the vehicle from rolling while parked. It operates on the rear wheels.

To engage

The detent engages automatically, and the indicator lamp in the instrument cluster comes on when the ignition key is in position 2, refer to page 18.

To release

Pull up slightly on the lever, press the button and lower the lever.

Parking brake

 If exceptional circumstances make it necessary to engage the parking brake while the vehicle is in motion, do not pull it with excessive pressure. Keep your thumb pressed against the release button while carefully pulling the lever up. Excessive pressure can lead to over-braking and loss of traction – fishtailing – at the rear axle. The brake lamps do not come on when the parking brake is engaged. Always engage the parking brake when parking on slopes and inclined surfaces. Engaging a gear may not provide adequate resistance to rolling. ◀

 To avoid corrosion and one-sided braking, apply the parking brake lightly from time to time when coasting to a standstill – at a traffic light, for example – provided that it is safe to do so. ◀

Manual transmission



 When shifting gears in the fifth/sixth gear plane, be sure to press the gearshift lever to the right in order to prevent inadvertent selection of a gear in the third/fourth gear plane. Do not hold the vehicle in place on slopes by slipping or 'riding' the clutch. Use the parking brake instead. Riding the clutch leads to severe and premature clutch wear. ◀

Reverse

Select only when the vehicle is stationary. Press the gearshift lever to the left to overcome the slight resistance.

When you select reverse the backup lamps will light up automatically when the ignition key is in position 2.

The concept

The sequential M gearbox with Drivelogic is an automated manual gearbox with which clutching and shifting is assumed by an electro-hydraulic system.

The SMG Drivelogic is operated via two shift paddles on the steering wheel and the selector lever in the center console.

It offers the following functions:

- ▷ Sequential and automated shifting mode
- ▷ Ability to choose between different driving programs – Drivelogic
- ▷ Gradient assistance, refer to page 73
- ▷ Upshift display and shift lights, refer to page 74
- ▷ RPM matching on downshifts
- ▷ Driving dependent functions:
The respective driving situation, e.g. cornering, mountain driving or braking, is detected by sensors and taken into account for shifting, e.g. to achieve optimum gear selection during deceleration and subsequent acceleration
- ▷ Slip recognition at the rear axle for increasing driving stability, e.g. during downshifting on slippery road surfaces

▷ Operating safety through protection against misshifting.

Under normal operating conditions, fuel consumption is lowest when driving in the first driving program of the automated shifting mode.

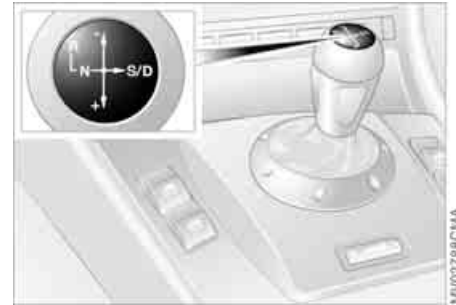

Selector lever positions

R: Reverse position

N: Neutral position

Forward position with one-touch mode:

▷ S: sequential mode

▷ D: automated mode

▷ +: upshifting in sequential mode

▷ -: downshifting in sequential mode.

The SMG Drivelogic is ready for operation from ignition key position two or higher.

For your safety, it is only possible to engage a driving position with the vehicle stopped approx. two seconds after engaging position N with the footbrake depressed – shift-lock function.

Sequential M gearbox with Drivelogic*

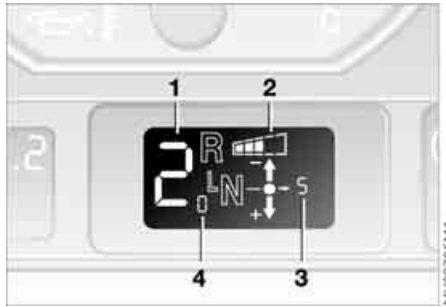

Display in instrument cluster

The selector lever position, currently engaged gear and selected driving program are displayed in the instrument cluster.

- 1 Engaged gear
- 2 Selected driving program, corresponds to the number of illuminated fields, refer to page 73
- 3 Tapping the selector lever to the right switches over into the displayed shift mode
- 4 'D' indicates an activated automated shift mode

R – Reverse position

Only engage with the vehicle stopped or at low speed, e.g. for rocking free in deep snow.

 An intermittent signal tone indicates that the reverse position has been engaged. ◀

N - Neutral

Always engage before starting the engine.

If the driving situation requires, e.g. when downshifting on slippery roads, the SMG Drivelogic automatically disengages and reengages the clutch, i.e. it is not necessary to manually engage position N.

S – Sequential mode

In the sequential mode all forward gears are to be shifted by the driver.

To switch from automated to sequential mode:

- ▷ Tap the selector lever to the right toward S or
- ▷ change gears with the selector lever or the shift paddles on the steering wheel.

You do not need to reduce the throttle for shifting.



Shifting gears with shift paddles on steering wheel:

- ▷ To upshift, briefly pull the right paddle +
- ▷ To downshift, briefly pull the left paddle -.

 Shift paddles with various widths matched to the shape of your hand are available from your BMW center. ◀

Shifting gears with selector lever:

- ▷ To upshift, pull the selector lever backward in the + direction
- ▷ To downshift, push the selector lever in the - direction.

No automatic upshifting is carried out in the sequential mode.

You accelerate from higher gears, e.g. during passing, by manually downshifting.

In the following situations the SMG Drivelogic anticipates your actions in the sequential mode:

- ▷ Upshifts and downshifts are only executed at appropriate combinations of engine rpm and vehicle speed. For instance, downshifts that would result in excessive engine speed are not executed
- ▷ During a stop the gearbox is automatically downshifted into the first gear so that, e.g. before a traffic light, it is only necessary to accelerate to continue driving
- ▷ As speed diminishes, the gearbox downshifts automatically, without you taking any action, just before the vehicle slows to below each gear's minimum speed.

D - Automated mode

Each time the engine is started, the automated mode is activated as soon as you move the selector lever into the forward driving position.

In the automated mode all forward gears are shifted automatically.

To switch from sequential to automated mode: tap the selector lever to the right toward D. Watch the display in the instrument cluster, refer to page 71.

For rapid acceleration, e.g. during passing, depress the accelerator pedal completely – kickdown. The gearbox now downshifts depending on the selected driving program.

Even in the automated mode, you can help specify the shifting point: if a gear-dependent minimum speed is exceeded, you can upshift by slowly reducing pressure on the accelerator pedal. In the process, the respective driving situation is detected by sensors and taken into account.



Drivelogic

Drivelogic makes various driving programs available to you.

Press the Drivelogic repeatedly until the desired driving program is shown in the SMG display of the instrument cluster, refer to page 71.

In the automated mode you can select from five driving programs ranging from convenience mode/winter operation to sporty and highly dynamic.

In the first automated driving program, starting off takes place in second gear, which is advisable under winter road conditions with ice and snow.

In the sequential mode you can choose from six driving programs ranging from balanced, dynamic driving – 1 – to sporty, puristic driving – 6. The sporty, puristic driving program can only be activated when Dynamic Stability Control DSC is switched off, refer to page 86.

 To maintain vehicle stability, always drive with the DSC activated on whenever possible. ◀

Following each change between the sequential and the automated mode, the last driving program selected in the respective mode is active. Exception: if program 6 had been the last selected sequential driving program, program 5 is activated instead.

 Your vehicle is set so that when the engine is started, the last selected driving program saved in your key is activated for each shifting mode. ◀

Gradient assistance

The gradient assistance enables starting off on grades with virtually no roll-back. It can be activated in the sequential and automated mode with the vehicle stopped and can be used for both forward and reverse driving.

 The vehicle may roll slightly before it is held by the gradient assistance after releasing the footbrake. Two seconds after the footbrake is released, the vehicle begins to roll, as it is no longer held with the gradient assistance. ◀

1. Depress footbrake with vehicle stopped
2. Activate the gradient assistance by pulling the left paddle for at least 0.5 seconds. An increase in the engine speed indicates that the gradient assistance is activated

 Briefly pulling the left paddle again deactivates the gradient assistance again. ◀

3. Release the footbrake and start off within two seconds.

The gradient assistance must be reactivated before each use.

Turn signal indicator/Headlamp flasher

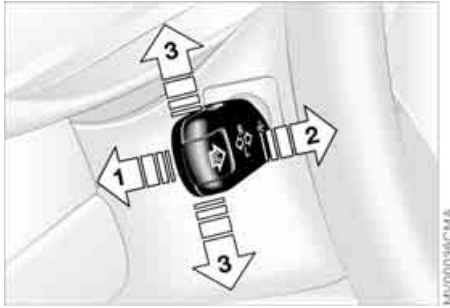

- 1 High beams
- 2 Headlamp flasher
- 3 Turn signal indicators

To signal briefly

Press the lever up to the detent but not beyond. It then returns to the center position when released.

 If the flashing of the indicator lamp and the clicking from the relay are both faster than usual, one of the turn signal indicators has failed. ◀



- 0 Wipers retracted
- 1 Intermittent mode or rain sensor
- 2 Normal wipe
- 3 Fast wipe
- 4 Brief wipe
- 5 Rotary dial for control of the wipe interval or the sensitivity of the rain sensor

Intermittent mode

Not on vehicles with rain sensor.

You can select any of four sweep intervals with rotary dial 5. In addition, the wipe interval varies automatically depending on road speed.

Rain sensor

The rain sensor is located on the windshield directly behind the rearview mirror.

To activate the rain sensor:

- ▷ With the ignition key in position 1 or higher, move the lever to position 1. The wipers travel once across the windshield, regardless of the weather
- ▷ You can leave the lever in position 1 at all times. With the ignition key in position 1 or higher, it is then only necessary to activate the rain sensor. To do this
- ▷ turn rotary dial 5 upward or
- ▷ clean windshield 1, refer to page 77.

To adjust the sensitivity of the rain sensor: turn rotary dial 5.

To switch off the rain sensor: place lever in position 0.



Turn the rain sensor off in automatic car washes. Failure to do so could result in damage caused by undesired wiper activation. ◀

Normal wiper speed

When the vehicle is stationary, the wipers switch automatically to intermittent wipe – not on vehicles with rain sensor.

Fast wiper speed

When the vehicle is stationary, the wipers operate at normal speed – not on vehicles with rain sensor.



0 Wipers retracted

1 Clean windshield and headlamps

Clean windshield and headlamps*

The system sprays washer fluid against the windshield and activates the wipers for a brief period.

When the vehicle's lighting system is switched on, the headlamps will also be cleaned at reasonable intervals.



Do not use the washers if there is any danger that the fluid will freeze on the windshield, as your vision could be obscured. Always use a windshield washer antifreeze in cold weather. Refer to page 126. Do not use the washers if the fluid reservoir is empty, as the washer pump will otherwise be damaged. ◀

Windshield washer nozzles

The windshield washer jets are warmed automatically when the ignition key is in position 2.

You can store and automatically maintain any desired vehicle speed above approx. 20 mph / 30 km/h.

The cruise control is available whenever the engine is running and the system has been activated.

To activate the system

I/O

In ignition key position 2:

Press the button in the steering wheel. The indicator lamp in the instrument cluster comes on, refer to page 21. You can now use the cruise control.



Do not use cruise control on twisting roads, when high traffic density prevents driving at a constant speed, or when the road surface is slick – snow, rain, ice – or loose – rocks or gravel, sand. ◀

To deactivate the system

I/O

Press the button as often as needed until the indicator lamp in the instrument cluster goes out.

Cruise control is also deactivated when the ignition key is in position 0.

The speed stored in memory is deleted.

To store and maintain speed or to accelerate



Press button + briefly:

The system maintains and stores the current vehicle speed. Every time you tap the button, the speed increases by approx. 0.6 mph / 1 km/h.

Press and hold button +:

The vehicle accelerates without pressure on the accelerator pedal. When you release the button, the system maintains and stores the current speed.

 If on a downhill gradient the engine braking effect is not sufficient, the controlled speed can be exceeded. Speed can drop on uphill grades if the engine output is insufficient. ◀

To decelerate



Press button – briefly:

If you are already driving with activated cruise control, the speed is decreased by approx. 0.6 mph / 1 km/h every time you tap the button.

Press and hold button –:

With the cruise control active, the system automatically reduces the throttle opening to slow the vehicle. When you release the button, the system maintains and stores the current speed.

To interrupt the cruise control



When the system is activated, press the button. The indicator lamp stays on. You can use the cruise control again whenever you want by calling up the speed that was stored last.

In addition, cruise control is interrupted automatically:

- ▷ When the brakes are applied
- ▷ When pressing down the clutch pedal
- ▷ If you exceed or fall below the programmed speed for an extended

period – by depressing the accelerator, for example

- ▷ Sequential M gearbox with Drivelogic, refer to page 70: when shifting in the sequential mode.

To recall the stored setting



Press the button:

The vehicle accelerates to and maintains the last speed stored.

Odometer



- 1 Odometer
- 2 Trip odometer

Odometer

You can activate the displays shown in the illustration with the ignition key in position 0 by pressing the left button in the instrument cluster.

Trip odometer

To reset the trip odometer to zero, press the left button with the ignition key in position 1 or higher.

Tachometer



Variable pre-warning zone

The yellow pre-warning zone displays current permissible engine speeds, depending on the engine temperature. As the engine temperature climbs, some of the sectors for this pre-warning zones will go out one after the other. Avoid engine speeds in the early warning zone if possible.

Never allow the engine to operate with the needle in the red overspeed zone of the gauge.

To protect the engine, the fuel supply is interrupted when you approach this sector.

Engine oil temperature

79



The general operating temperature lies between 175 °F/80 °C and 250 °F/120 °C. During high-performance driving, do not exceed a maximum value of 300 °F/150 °C.



Once the indicator lamp stays on continuously, there are still approx. 2 gallons/8 liters of fuel in the fuel tank. Fuel tank capacity approx. 16.6 gal./63 liters.

If the tilt of the vehicle varies – when you are driving in mountainous areas, for example – the needle may fluctuate slightly.



Fill the fuel tank before it is completely empty. Driving to the last drop of fuel can prevent the engine from operating properly and result in damage. ◀

When you switch on the ignition, the indicator lamp lights up briefly as an operation check.

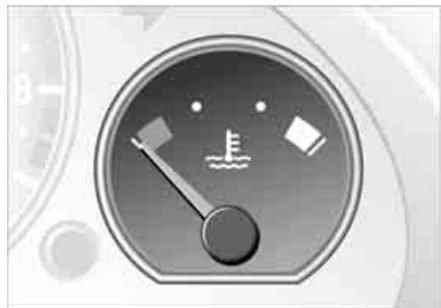

To check the coolant level, refer to page 128.

Blue

The engine is still cold. Drive at moderate engine and vehicle speeds.

Between the blue and red zones

Normal operating range. The needle may rise as far as the edge of the red sector during normal operation.

Red

When you switch on the ignition, the warning lamp comes on briefly as an operation check.

If the lamp comes on while operating the vehicle: the engine has overheated. Switch off the engine immediately and allow it to cool down.

Service interval display



A flashing message and a '-' in front of the number mean that the service interval has already been exceeded by the distance shown on the display. Please contact your BMW center for an appointment.

Remaining distance to next service

The displays shown in the illustration appear for a few seconds when the ignition key is in position 1 or higher or after the engine is started.

The next service due appears with the message OIL SERVICE or INSPECTION, together with the distance remaining in miles – in kilometers in Canada – before the next scheduled service.

The computer bases its calculations of the remaining distance on the preceding driving style.

Check Control

81

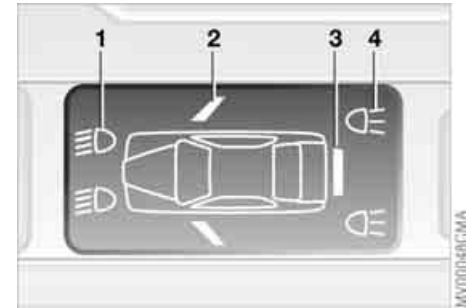

Display

When the ignition key is in position 2, the following information and/or conditions are indicated using symbols until the conditions have been corrected.

- 1 Inspect the low-beam and high-beam headlamps, as well as the parking lamps
- 2 Door open
- 3 Luggage compartment lid open
- 4 Check brake and tail lamps

When you open the driver's door after having turned the ignition key to position 0, you will hear an acoustic signal for a few seconds to remind you that the lamps have not been switched off.

82 Clock

If you wish to have a permanent time display, you can make this adjustment in the car radio display, refer to the Owner's Manual for Radio.

You can set the time of day, and the display for the car radio, as follows.



Every time you press the button, the clock display alternates between the 12-hour and 24-hour mode.

In ignition key position 0: the time is displayed for a few seconds after you press the left button, refer to Odometer on page 79.

Setting



Before the clock can be set, the time must be showing in the instrument cluster display. ◀

With the ignition key in position 1 or higher

To set ahead: turn the right button to the right.

To set back: turn the right button to the left.

The adjustment speed will increase the longer you continue to hold the right button.

To change the display mode: press the right button briefly.



After giving an ice warning, the display returns to the previous setting. ◀



The ice warning does not alter the fact that surface ice can form at temperatures above 37.5 °F/+3 °C, on bridges or shaded road surfaces, for instance. ◀



Average fuel consumption

If you press the onboard computer button BC in the turn signal lever for longer while the average fuel consumption is being displayed, a new consumption value is calculated from that point in time.



If you wish, you can have the average fuel consumption displayed in a different unit of measure. ◀

Range

The display shows a range estimate based on the available fuel. The amount of fuel remaining in the tank is measured, the estimated range is calculated taking into account the operating conditions over the last 20 miles/30 km.



It is important that you refuel when the cruising range falls below approx. 35 miles/50 kilometers. Otherwise, the engine cannot be guaranteed to operate properly and damage may result. ◀

Average speed

Any time spent when the vehicle is stationary and the engine is shut off is ignored for the calculation.

To reset the average speed: press the onboard computer button BC in the turn signal lever for approx. 2 seconds.

Park Distance Control (PDC)*

The concept

PDC assists you when you back into a parking space. Acoustic signals alert you to the momentary distance to an object behind your vehicle. To do this, four ultrasonic sensors in the rear bumper measure the distance to the nearest object. The range for the sensors located at both rear corners ends approx. 2 ft/60 cm behind the bumpers. The range for the two middle sensors is slightly less than 5 ft/1.50 m.

 PDC is a parking aid that can identify objects if they are approached slowly, as is generally the case when parking. Avoid driving towards objects rapidly; due to underlying physical principles, the system may otherwise alert you too late for you to take evasive steps. ◀

The system starts to operate automatically approx. one second after you shift into Reverse or move the selector lever into the R position with the ignition key in position 2.

 Let this short period elapse before driving backwards. ◀

PDC is deactivated when you shift back out of Reverse.



You can have a signal set to confirm that the PDC has been activated. The signal then sounds when you shift into Reverse or move the selector lever into the R position. ◀

Acoustic signals

The distance to the nearest object is indicated by a tone sounding at various intervals. As the distance between vehicle and object decreases, the intervals between the tones become shorter. A continuous tone indicates the presence of an object less than 1 ft/30 cm away.

The warning signal is canceled after approx. three seconds if the distance to the object remains constant during this time – if you are moving parallel to a wall, for instance.

System malfunctions will be indicated by a continuous high-pitched tone when the system is activated the first time. Please have your BMW center resolve the problem.



PDC does not remove the driver's personal responsibility for evaluating the distance between the vehicle and any objects. Even when sensors are involved, there is a blind spot in which objects cannot be detected. This applies especially in those cases where the system approaches the physical limits of ultrasonic measurement, as occurs with tow bars and trailer couplings, and in the vicinity of thin or wedge-shaped objects. Moreover, low objects that have already been detected – such as a curb edge – can disappear out of the detection range of the sensors before a continuous tone sounds.

Loud sources of sound from outside or inside the vehicle could drown out the PDC signal tone. ◀



Keep the sensors clean and free of ice or snow in order to ensure that they will continue to operate effectively.

Do not apply high pressure spray to the sensors for a prolonged period of time. Always maintain a distance of more than 4 in/10 cm. ◀

The concept

DSC supports vehicle stability, even in critical driving situations.

DSC optimizes driving stability and traction during acceleration and when you are starting from a standstill. In addition, it also recognizes unstable vehicle conditions, such as understeering and oversteering. By reducing engine power and applying brakes at the wheels, DSC helps to keep the vehicle on a steady course within physically feasible limits.

The system starts up automatically each time you start the engine.

 The laws of physics cannot be repealed, even with DSC. The driver remains responsible for the consequences of any inadequate driving style. Therefore, do not take any risks because of the additional safety provided. Do not make any modifications to the DSC system. Allow only authorized technicians to perform service procedures on the DSC. ◀

Indicator lamp for DSC

The indicator lamp in the instrument cluster will go out shortly after the ignition has been switched on, refer to page 20.

- ▷ The indicator lamp flashes: DSC is active and is controlling the drive torque based on driving conditions
- ▷ The indicator lamp does not go out after the engine is started or lights up continuously while you are driving: DSC has been deactivated via the button or is defective.

Please consult your BMW center for repairs.

You can continue to drive the vehicle normally without DSC. In the event of a malfunction, contact a BMW center or a workshop that works according to BMW requirements with appropriately trained personnel.

**To deactivate DSC**

Press the DSC button; the DSC indicator lamp lights up continuously. DSC is switched off.

When better traction is required, it is beneficial to deactivate the system in the following situations:

- ▷ When rocking the vehicle or starting off in deep snow or on loose surfaces
- ▷ When driving with snow chains.



To maintain vehicle stability, always drive with the system switched on whenever possible. ◀

To reactivate DSC

Press the DSC button again; the indicator lamp goes out.

Flat Tire Monitor

The concept

As you drive, the Flat Tire Monitor keeps track of pressure levels in all four tires. The system alerts you whenever the inflation pressure of a tire falls significantly below the pressure of another tire.

In the event of tire pressure loss, the rolling radius of the tire changes, and thereby the rotational speed of the wheel. This change is detected, and a flat tire warning is issued to the driver.

Functional requirements

To ensure a reliable flat tire warning, the system must be initialized with the correct tire inflation pressures.

▶ Initialize the system immediately after you have corrected a tire inflation pressure, or changed the tire or wheel. ◀

System limitations

⚠ The Flat Tire Monitor cannot provide you with advance warning of sudden and severe tire damage caused by external factors and does not detect the balanced and very gradual pressure loss that takes place in all four tires over an extended period of time. ◀

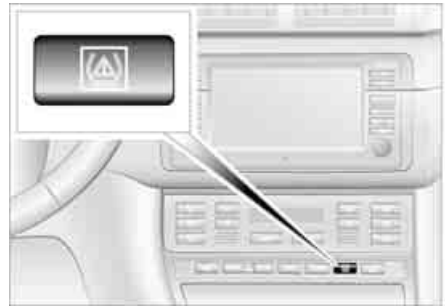

The system could issue a false warning or function in a delayed manner in the following situations:

- ▶ System was not initialized
- ▶ You are driving on a snow-covered or slippery road surface
- ▶ Performance-oriented driving: slip at the drive wheels, high levels of lateral acceleration
- ▶ You are driving with snow chains.

Initializing the system

▶ The initialization is completed while you are driving, and can be interrupted at any time. Initialization is automatically continued when you continue driving. When driving with snow chains, do not initialize the system. ◀

1. Before driving off, start the engine but do not start driving
2. Press the button as long as you need to, but no more than 8 seconds, until the indicator lamp in the instrument cluster lights up in yellow for several seconds
3. Drive off. Initialization is completed during the drive without any feedback issued.

▶ When driving with snow chains, do not initialize the system. ◀

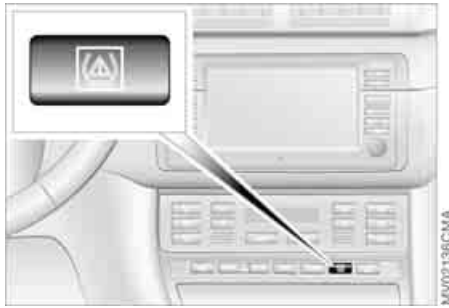

To activate/deactivate the system

The system is automatically activated in ignition key position 2 and consequently is on whenever the vehicle is operated.

To deactivate the system: tap the button; the indicator lamp will light up yellow.

To activate the system: tap the button again; the indicator lamp goes out.

Deactivate the system when snow chains are mounted, since false warnings and undetected losses in pressure are possible under these kinds of conditions.

Flat tire



The indicator lamp in the instrument cluster lights up red. In addition, an acoustic signal is sounded.

1. Carefully reduce speed and come to a stop. Avoid sudden braking and steering maneuvers
2. Determine which wheel is damaged



If this cannot be determined, contact your BMW center. ◀

3. Fix the flat tire using the M Mobility system, refer to page 141
4. Press the button for approx. 4 seconds. The red indicator lamp goes out.

After replacing the damaged tire, initialize the system.

System malfunction



The indicator lamp in the instrument cluster lights up yellow. The Flat Tire Monitor is malfunctioning or out of order. Please contact your BMW center.



The Sport mode is deactivated every time the engine is started.

The system – Sport mode – will cause the engine to respond more spontaneously to any motion of the accelerator pedal.

Activating/deactivating Sport mode

Activating: with the ignition key in position 2, press the SPORT button. The indicator lamp will come on.



When the system is activated, the vehicle may gain speed without any additional pressure on the accelerator pedal. ◀

Deactivating: press the SPORT button again; the indicator lamp will go out.

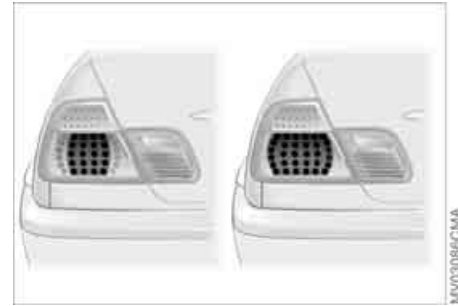

Brake force display indicates to the road users behind you how hard you are braking.

- ▷ Normal braking: the brake lamps among the rear lamps and the center brake lamp light up
- ▷ Hard braking or braking with ABS: in addition, the illuminated rear lamp surface is extended, refer to the picture.

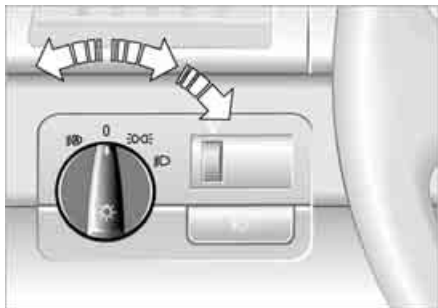

You can also have this function deactivated. ◀

LIGHTS ON warning

Whenever you open the driver's door after having turned the ignition key to position 0, you will hear an acoustic signal for a few seconds to remind you that the lamps have not been switched off.

Daytime driving lamps*

If you desire, the light switch can be left in the low-beam position: when the ignition is switched off, the external lighting is also switched off.

Observe the legal regulations regarding the use of daytime driving lamps.

When required, switch on the parking lamps as usual as described under Parking lamps.



You can have the activation settings for the daytime driving lamps programmed on your vehicle. ◀

Automatic headlamp control*



When the switch is in this position, the system automatically responds to changes in ambient light, for example in tunnels, at dusk and when it is raining or snowing, by switching the low beams on or off.



The low-beam headlamps remain on, regardless of the ambient light, when you switch on the fog lamps. ◀



Automatic headlamp control cannot serve as a substitute for your personal judgement in determining when the lamps should be switched on. For example, the sensors are not able to detect fog. In such situations switch on the lamp manually, as otherwise a safety hazard will result. ◀



You can have the sensitivity of your vehicle's automatic headlamp control adjusted. ◀

Parking lamps



The front, rear and side vehicle lighting is switched on. You can use this to signal the position of the vehicle when it is parked. For lighting on one side for parking as an additional feature, refer to page 91.

Low beams



When you switch the ignition off with the low-beam headlamps on, only the parking lamps will remain on.

Follow me home lamps

When you activate the headlamp flasher after parking the vehicle and switching off the lights, the low beams will come on for a brief period.

Instrument lighting

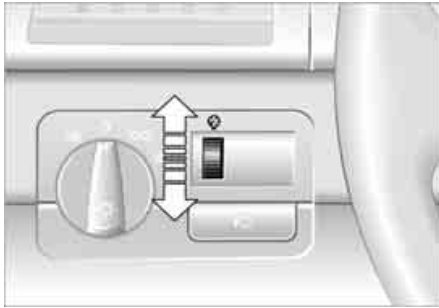

Turn the rotary dial to control the lighting when the parking or low beam lamps are on.

High beams/Standing lamps

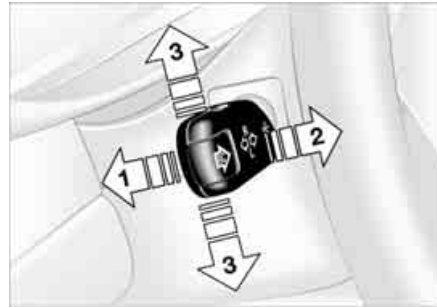

- 1 High beams
- 2 Headlamp flasher
- 3 Standing lamps

Standing lamps, left or right

As an additional feature, you can illuminate your vehicle on either side for parking, if you wish to do so:

With the ignition key in position 0, push the lever in the appropriate direction. The lever engages in the turn signal position.

 The standing lamps discharge the battery. Avoid using them for longer periods of time; otherwise, you may not be able to start the engine. ◀



Tap the button to switch on or off.

 The parking lamps or low-beam headlamps must be switched on. The green indicator lamp in the instrument cluster lights up to indicate that the front fog lamps are on.

 If the automatic headlamp control is on, the low beams will come on automatically whenever you activate the front fog lamps. ◀

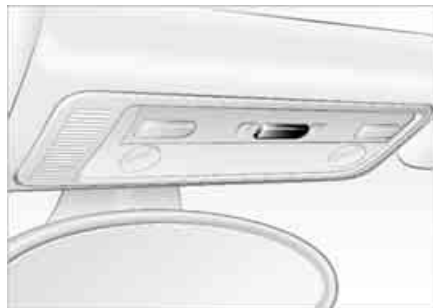

The interior lamps operate automatically.

To switch the interior lamps on and off manually

Press the button briefly.

If you want the interior lamps to remain off all the time, press and hold the button for approx. three seconds.

Press the button briefly to revert to normal operation.



Front reading lamps

Switch on and off with the button adjacent to each lamp.

Reading lamps



Rear reading lamps

With the hardtop reading lamps are also located in the rear, refer to page 113. Switch on and off with the button adjacent to each lamp.

 In order to prevent battery discharge, all of the lamps in the vehicle are automatically switched off approx. 15 minutes after you turn the ignition key to position 0. ◀

94 Automatic climate control

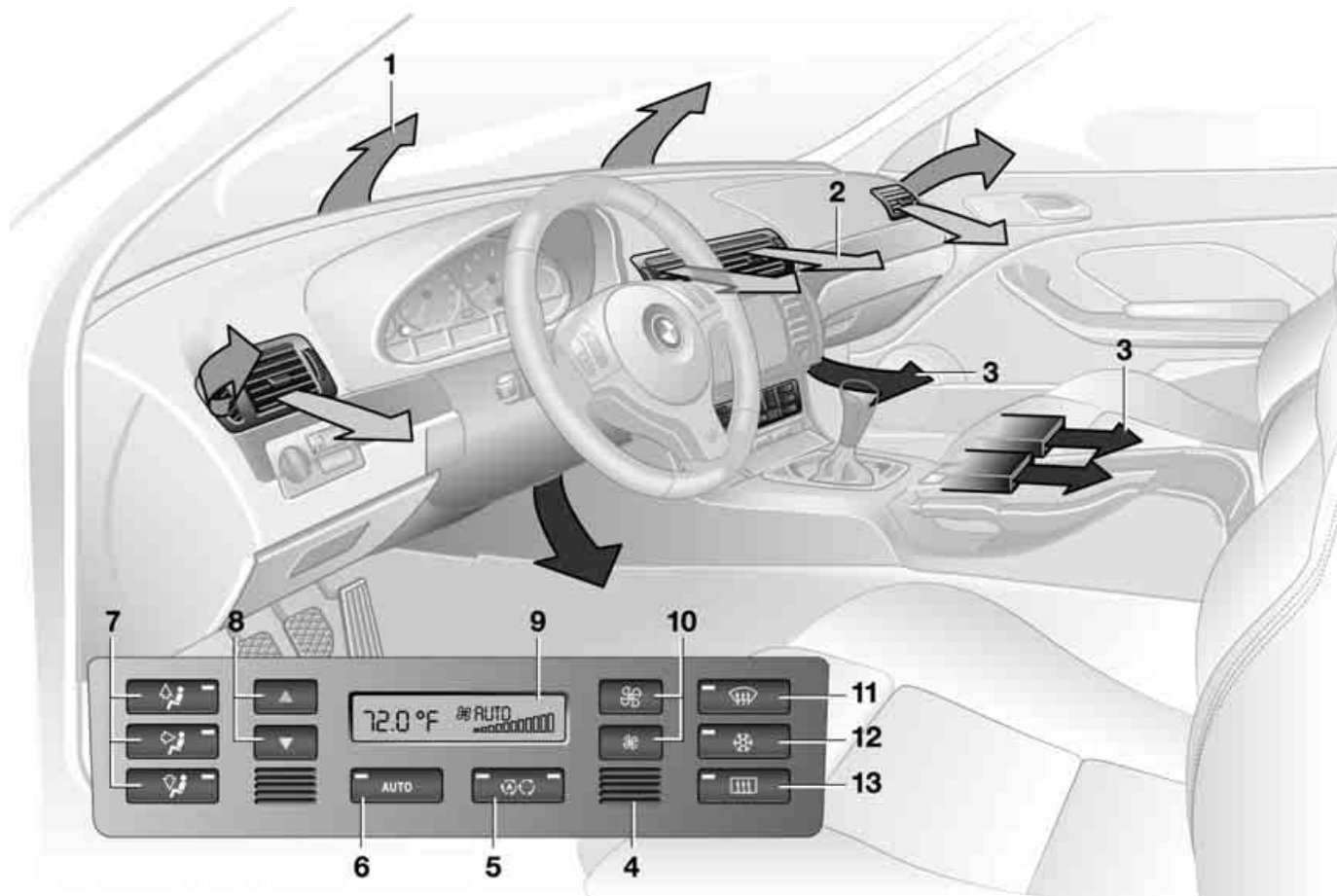

MV02144CMA

Automatic climate control

- 1 Air onto the windshield and the side windows
- 2 Air for the upper body area [97](#)
- 3 Air to the footwell
- 4 Interior temperature sensor – please keep clear and unobstructed
- 5 Outside air/Automatic recirculated-air control (AUC)/Recirculated air [97](#)
- 6 Automatic air distribution and supply [96](#)
- 7 Individual air distribution [96](#)
- 8 Temperature [96](#)
- 9 Display for temperature and air supply [96](#)
- 10 Air supply/Blower [96](#)
- 11 To defrost windows and remove condensation [96](#)
- 12 Air conditioning [96](#)
- 13 Rear window defroster [97](#)

Tips for pleasant driving

Use the automatic mode – switch on with AUTO button 6. Select the desired interior temperature.

Detailed setting options are described for you in the following sections.



You can make the settings of your vehicle in such a manner that, when you unlock the vehicle with the remote control of your personal key, your own personalized setting for the automatic climate control is initiated. ◀



AUTO program

The AUTO program adjusts the air supply and the air distribution to the windshield and the side windows, towards the upper body and to the footwells, and in addition adapts the temperature to external influences: e.g. summer, winter.

The cooling function is automatically switched on when you are using the AUTO program.

Individual air distribution

You can cancel the AUTO program by selecting specific distribution patterns to suit your own individual requirements.

While the AUTO program is then deactivated, the automatic airflow control remains in operation. Air flows onto the windows , toward the upper body , and into the footwell . You can reactivate the automatic air supply by pressing the AUTO button.

Temperature

The interior temperature that appears in the display panel is a general figure intended for reference purposes. We recommend 72 °F / +22 °C as a comfortable setting, even if the air conditioning is on. When you start the vehicle, the system ensures that the selected temperature is reached as quickly as possible. It then maintains this temperature, regardless of the season.

To select the units of measure °F / °C of the display, refer to page 83.

Air supply/Blower

By pressing the upper or lower button, you can vary the air supply. This deactivates the automatic air supply – the AUTO display disappears from the panel. Nevertheless,

the automatic air distribution remains unchanged. You can reactivate the automatic air supply by pressing the AUTO button.

When the lowest blower speed is set and you press the lower button, all of the displays are canceled: the blower, heating and air conditioner are switched off, and the air supply is stopped. You can reactivate the system by pressing any button for the automatic climate control.

To defrost windows and remove condensation

This program quickly removes ice and condensation from the windshield and the side windows.

Air conditioning

The air is cooled and dehumidified and – depending on the temperature setting – rewarmed.

Depending on the weather, the windshield may fog over briefly when the engine is started. Air conditioning helps prevent the windows from fogging up.

The cooling function is automatically switched on when you are using the AUTO program.

Automatic climate control

 Condensation forms during operation of the air conditioning system, which then exits under the vehicle. Traces of condensed water of this kind are thus normal. ◀

Outside air/Automatic recirculated-air control (AUC)/ Recirculated air

 You can respond to unpleasant external odors or pollutants by temporarily stopping the flow of outside air. The system then recirculates the air currently within the vehicle.

By repeatedly pressing the button, you can select one of three different operating modes.

- ▷ Indicator lamps off: outside air always flowing into the vehicle
- ▷ Left-hand indicator lamp on – automatic mode: the system detects pollutants in the outside air and responds by deactivating the outside airflow as required. The system then recirculates the air currently within the vehicle.

Depending on air quality requirements, the system automatically switches between outside air supply and recirculation of the air already within the vehicle

- ▷ Right-hand indicator lamp on: the flow of outside air is permanently blocked. The system recirculates the air already within the vehicle.

 If the windows fog over in the recirculated-air mode, switch the recirculated-air mode off and increase the air supply as required. ◀

Rear window defroster

 With the convertible top closed or with the hardtop* mounted, press the button. The indicator lamp remains on. The rear window defroster switches off automatically after a short while.

 You can have your vehicle programmed in such a way that the rear window defroster switches on automatically. This occurs within 5 minutes after starting the engine when outside temperatures are below approx. 39 °F / +4 °C. ◀

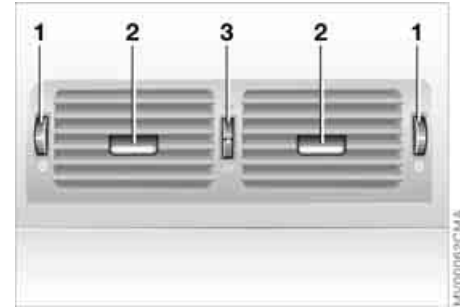

Draft-free ventilation

You can adjust the blower controls for the upper body area to obtain the optimum airflow rates and directions for your personal requirements:

- 1 Rotary dials for opening and closing the vents at any setting desired
- 2 Lever for adjusting airflow direction
- 3 With the rotary dial, you can add more or less cool air to the air coming from the outlets for the upper body area:
 - ▷ Turn toward blue – colder
 - ▷ Turn toward red – warmer.

Microfilter, activated-charcoal filter

The built-in microfilter removes dust and pollen from the incoming air. The activated-charcoal filter provides additional protection by filtering gaseous pollutants from the outside air. Your BMW center will replace the combined filter as a standard part of your scheduled maintenance. A substantial reduction in airflow indicates that the filter needs to be replaced early.

Glove compartment

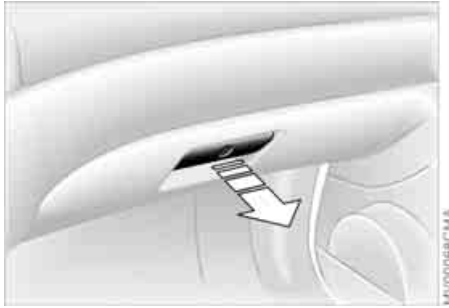

▶ If – for example for valet parking – you turn over only your spare key, refer to page 28, then access to the glove compartment and luggage compartment is not possible. ◀

To open

Pull the handle. The glove compartment will light up.

To close

Fold up cover.



To prevent injury in the event of an accident, close the glove compartment immediately after use. ◀

To lock

Lock with one of the master keys. A master key can also be used for unlocking. To open the luggage compartment lid when the glove compartment is locked, refer to the instructions on page 33.

Storage compartments 99

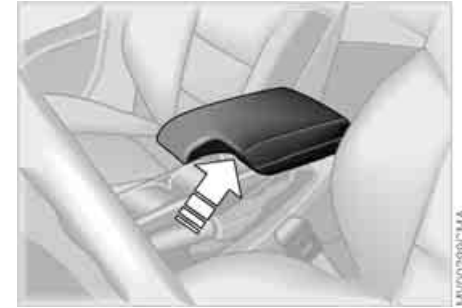

Front center armrest*

To open: press the button and fold up.

Additional compartments and nets

You will find additional storage areas in the doors and in the center console above the ashtray. Storage nets are located on the backrests of the front seats.

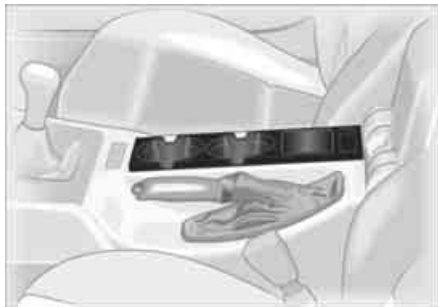

14V01005CUMA

Beverage holders, coin box

A coin box and two beverage holders are provided in the center console.

 Do not place any glass containers in the beverage holders, as this increases the risk of injury in the event of an accident. ◀

Microphone*

Hands-free system

On vehicles that are wired for a telephone* or equipped with a voice command system*, the hands-free microphone is located on the steering column.

For additional information on using your car phone, cellular phone or voice command system, refer to the respective separate Owner's Manual.

Ashtray, front*



14V007141CUMA

To empty

Press on the edge of the open cover. you can now pull the ashtray upward for removal.

Extinguishing cigarettes

Tap off the ash and gently press the tip into the funnel.

Cigarette lighter

 Hold or touch the hot cigarette lighter by the knob only. Holding or touching it in other areas could result in burns.

The cigarette lighter remains operational when the ignition key has been removed. For this reason, children should never be left in the vehicle unattended. ◀

Ashtray, front*

Press lighter 1 in. As soon as the lighter jumps back out, it can be removed.

Power socket

The cigarette lighter socket can be used as a power socket for a flashlight, car vacuum cleaner, etc., up to a rating of approx. 200 watts at 12 volts. Do not damage the socket by inserting plugs of the wrong shape or size. In vehicles with a non-smoker's equipment package, the socket is covered by a removable cap.

Ashtray, rear*

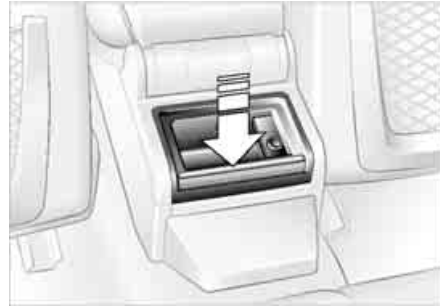

To empty

Press on the edge of the open cover in the opening direction: you can now pull the ashtray upward for removal.

102 Ski bag*

The ski bag allows the safe and clean transport of up to 3 pairs of standard skis or up to two snowboards.

The length of the ski bag and the additional space provided in the luggage compartment make it possible to carry skis up to 6 ft 10 in / 2.10 m long.

Because of the tapered shape of the bag, only two pairs of skis longer than 6 ft 10 in / 2.10 m can be carried.

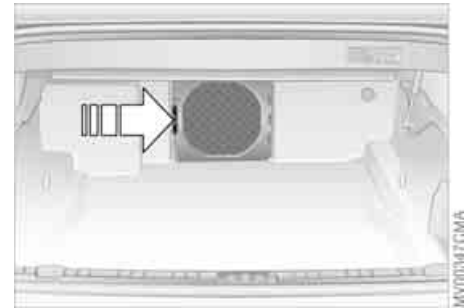
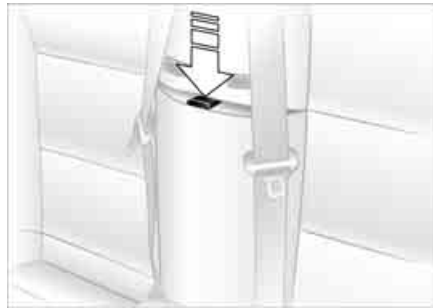

Loading

1. Release the safety belts from their holders
2. Press lever downward and remove the center piece by pulling it forward
3. Extend the ski bag between the front seats. The zipper provides convenient access to stored items. It may be opened to allow the ski bag to dry
4. Press the button in the luggage compartment

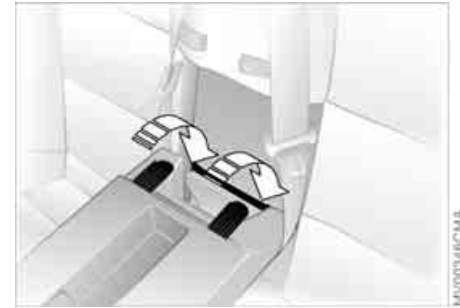
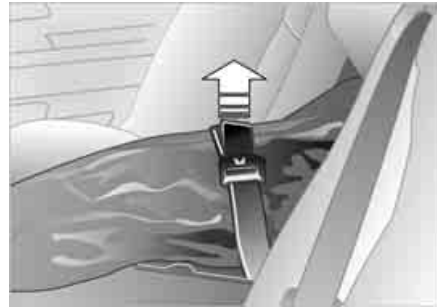
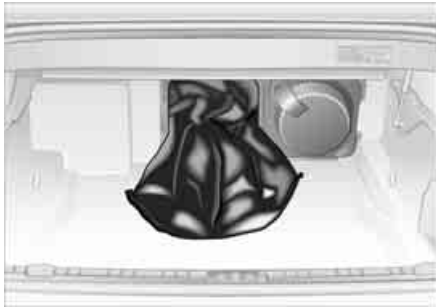

5. Secure the cover panel with the magnetic retainer on the rear wall, then pull out the ski bag.

Securing cargo

After loading, secure the ski bag and its contents. To do so, tighten the retaining strap at the tensioning buckle.



Be sure to secure the ski bag in this way, as it could otherwise injure occupants, for example during braking or evasive maneuvers. Be sure that the skis are clean before loading them into the bag. Be careful to avoid damage from sharp edges. ◀

Storing the ski bag

To store the ski bag, perform the above steps in reverse sequence.



When reattaching the center piece, guide both bars into the guide and press the center piece back into place. Secure the safety belts in their holders again. ◀



Avoid overloading the vehicle so that the permitted load on the tires is not exceeded. Overloading can lead to overheating and internal tire damage. This can result in a sudden loss of tire inflation pressure. ◀

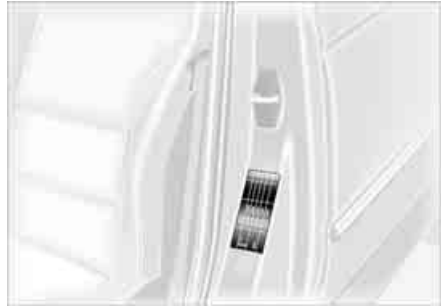

Determining the maximum load

1. Locate the following statement on your vehicle's placard*:



The combined weight of occupants and cargo should never exceed XXX kg or YYY lbs., as this could otherwise result in damage to the vehicle or unstable driving conditions. ◀

2. Determine the combined weight of the driver and passengers that will be riding in your vehicle
3. Subtract the combined weight of the driver and passengers from XXX kilograms or YYY pounds

4. The resulting figure equals the available amount of cargo and luggage load capacity.

For example, if the YYY amount equals 820 lbs. and there will be four 150 lbs. passengers in your vehicle, the amount of available cargo and luggage load capacity is 220 lbs.: 820 lbs. minus 600 lbs. = 220 lbs.

5. Determine the combined weight of luggage and cargo being loaded on the vehicle. That weight may not safely exceed the available cargo and luggage load capacity calculated in Step 4
6. If your vehicle will be towing a trailer, load from your trailer will be transferred to your vehicle. Consult the manual for transporting a trailer to determine how this may reduce the available cargo and luggage load capacity of your vehicle.

Cargo loading

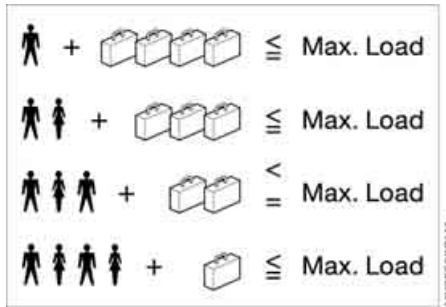

Load

The permissible load is the sum of the occupants' weights and the weight of the cargo. The greater the weight of the occupants, the less cargo can be transported.

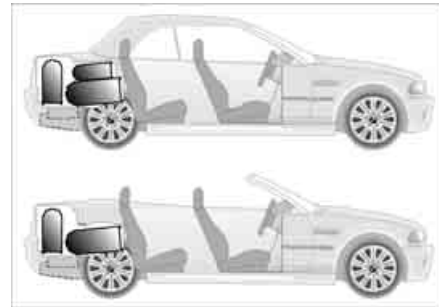

Stowing cargo

- ▷ Load heavy cargo as far forward as possible – directly behind the luggage compartment partition – and as low as possible
- ▷ Cover sharp edges and corners.

▶ You can enlarge the luggage compartment when the convertible top is closed, refer to page 35. To do this you have to fold the convertible top compartment panel up.

We recommend that you always fold the convertible top compartment panel down as soon as you have removed your cargo from the luggage compartment. This way, you can be sure that you can always operate you convertible top at any time.

At the same time, when the top is raised you should fold the convertible top compartment panel back up before stowing large objects in the luggage compartment; this precaution will help reduce the likelihood of damage to either the convertible top compartment or your luggage. ◀

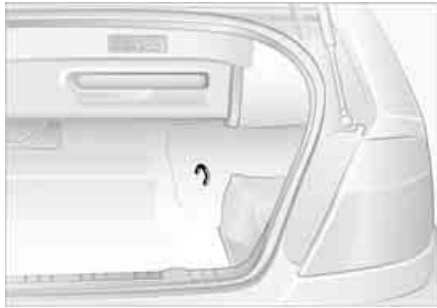

 Always position and secure the load correctly. If you do not, it can endanger the passengers during braking or evasive maneuvers. Do not exceed the approved gross vehicle weight or the approved axle loads, refer to page 156, otherwise the vehicle's operating safety is no longer assured and the vehicle will not be in compliance with the certification regulations.

Do not stow heavy or hard objects in the passenger compartment without first securing them. Otherwise they would be thrown around during braking and evasive maneuvers and endanger the occupants. ◀

Securing the cargo in the luggage compartment

- ▷ For small, light items, use the rubber-lined, non-skid side of the floor mat or secure using the luggage compartment net* or elastic straps, refer to page 35
- ▷ For large, heavy pieces, see your BMW center for load-securing devices*. Four anchorages located in the luggage compartment can be used for fastening these load-securing devices.

Comply with the information enclosed with the load-securing devices.

Roof-mounted luggage rack for the hardtop*

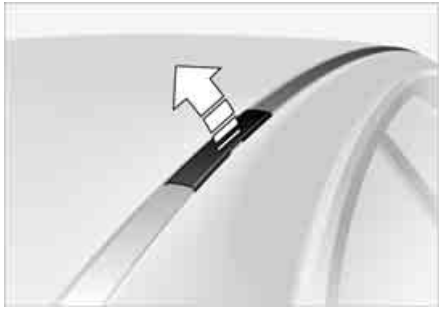

A special roof-rack system is available as an optional extra for your BMW. Please observe the precautions included with the installation instructions.

Anchorage

Access to the mounting points:

To fold up the covers, please use the tool provided with the roof-rack system.

Loading and driving notes

Because roof racks raise the center of gravity of the vehicle when loaded, they exercise a major effect on its handling and steering response.

When loading, be sure to remember not to exceed the approved roof weight or the approved gross vehicle weight or the axle loads. You will find the specifications under Technical data on page [156](#).

Make sure that the load is not too bulky, and attempt to distribute it evenly. Always load the heaviest pieces first so that they are at the bottom. Make sure that no objects get in the way when the luggage compartment lid is opening or closing.

Secure the roof-mounted luggage correctly and safely to prevent it from shifting or being lost during driving.

Drive smoothly and avoid sudden acceleration or braking. Do not corner at high speeds.



Overview

Controls and features

Operation, maintenance

Owner service procedures

Technical data

Index

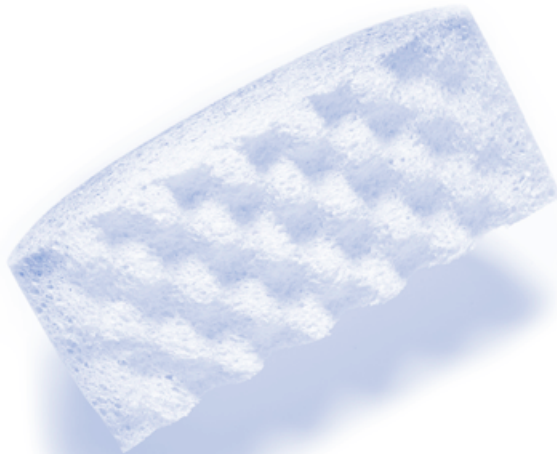

Overview

Controls

Maintenance

Repairs

Data

Index

To ensure that your vehicle continues to provide maximum economy throughout an extended service life, we request that you devote careful attention to the following instructions.

 Because of its engineering design, the BMW M3 Convertible is an especially high-quality vehicle. It is in your best interest to follow the break-in tips very closely. Doing this, you will create the basis for a long, optimum service life. ◀

Engine and differential

The first 1,250 miles/2,000 km:

Drive at varying engine and road speeds, but do not exceed an engine speed of 5,500 rpm or a road speed of 105 mph / 170 km/h.

Obey your local and state maximum speed limits.

Do not depress the accelerator pedal to the full-throttle position.

Vehicles with SMG Drivelogic, refer to page 73: do not use Drivelogic programs 5 or 6 or launch control during the break-in period.

▷ Following the break-in inspection at 1,250 miles/2,000 km, you can gradually increase engine or road speeds.

Transmission

The transmission will begin to function optimally after approx. 300 miles/500 km. Shift gears cautiously during this period and do not exceed an engine speed of 5,500 rpm.

Vehicles with SMG Drivelogic, refer to page 73: do not use Drivelogic programs 5 or 6 or launch control during the break-in period.

Tires

Owing to technical factors associated with their manufacture, tires do not achieve their full traction potential until an initial break-in period has elapsed. We thus ask you to drive with extra care during the first 200 miles/300 km.

Obey your local and state maximum speed limits.

Brake system

Approx. 300 miles/500 km must elapse before the brake pads and rotors achieve the optimal pad-surface and wear patterns required for trouble-free operation and an extended service life later on.

To break in the separate parking brake drums, apply the parking brake lightly when coasting to a standstill, e.g. at a traffic signal, provided that traffic conditions permit to do so.

To avoid corrosion repeat this procedure from time to time.

 The brake lamps do not come on when the parking brake is set. Vacuum for the brake system servo unit on your BMW is available only when the engine is running. When you move the vehicle with the engine off – when towing, for example – substantially higher levels of pedal force will be required to brake the vehicle. ◀

Clutch

The clutch will also begin to function optimally after about 300 miles/500 km. Drive cautiously during this break-in period and do not press the clutch or shift at high engine speeds.

After replacing parts

Follow the same break-in procedures if any of the components mentioned above have to be replaced in the future.

General driving notes

Hot exhaust system

 High temperatures occur with every vehicle equipped with a catalytic converter. Heat shields are installed adjacent to some sections of the exhaust system. Never remove these shields; do not apply undercoating to their surfaces. When driving, standing at idle and parking the vehicle, take care to avoid contact between the hot exhaust system and flammable materials, e.g. hay, leaves, grass, etc. Such contact could lead to a fire, resulting in serious personal injury and property damage. ◀

When the vehicle is parked

Condensation forms in the automatic climate control system during operation, which then exits under the vehicle. Traces of condensed water of this kind are thus normal.

Before driving through a car wash

Fold in the exterior mirrors manually because they could otherwise be damaged due to the width of the vehicle.

Hydroplaning

 When driving on wet or slushy roads, reduce vehicle speed. If you do not, a wedge of water may form between the tires and the road surface. This phenomenon is referred to as hydroplaning, and can lead to partial or complete loss of traction, vehicle control and braking effectiveness. ◀

The risk of hydroplaning increases as the tread depth of the tires decreases, refer also to Tire tread on page 120.

Driving through water

 Do not drive through water on the road if it is deeper than 1 ft/30 cm, and then only at walking speed. Otherwise, the vehicle's engine, the electrical systems and the transmission may be damaged. ◀

Braking safely

Your BMW is equipped with ABS as a standard feature. If you are in a situation which requires full braking, it is best to brake using maximum brake pressure: panic stop. Since the vehicle

maintains steering responsiveness, you can avoid possible obstacles with a minimum of steering effort, despite the full brake application.

Pulsation at the brake pedal combined with sounds from the hydraulic circuits indicates to the driver that ABS is in its active mode.

 Do not drive with your foot resting on the brake pedal. Otherwise, even light but consistent pedal pressure can lead to high temperatures, brake wear and possibly even brake failure. ◀

Wet roads:

if the roads are wet or if there is heavy rain, it is advisable to gently press the brakes for a brief moment every few miles/kilometers. Monitor traffic conditions to ensure that this maneuver does not pose a hazard to you or to other road users. The heat generated in this process helps dry the pads and rotors. Immediate braking force is then available if necessary.

Inclines:

 To prevent overheating and, as a result, diminished braking effectiveness, drive down long or steep downhill grades in a gear which requires the least braking. Otherwise, even light but consistent pedal pressure can lead to high temperatures, brake wear and possibly even brake failure. ◀

The braking power of the engine can be further enhanced by downshifting the automatic transmission in manual mode, if necessary, into first gear. This helps avoid placing excessive loads on the brake system.

 Do not coast with the clutch depressed or with the transmission or selector lever in Neutral. Do not coast with the engine switched off. Otherwise, the engine provides no braking effect while the transmission is in idling position, and there is no power-assist for braking or steering when the engine is off.

Floor mats, floor carpets or other objects must not be in the area near the brake or accelerator pedal, as this could impair the movement of the pedals. ◀

Corrosion on the brake rotors

Limited vehicle use, extended periods with the vehicle parked or in storage, and operating conditions in which braking is restricted to gentle, low-pressure applications will all increase the tendency for corrosion to form on the rotors and contamination to accumulate on the brake pads. This occurs because the minimal pressure which must be exerted by the pads to clean the rotors by brake applications is not reached.

If the brake rotors are corroded, they will tend to respond to braking with a pulsating effect that even extended brake applications will fail to cure.

Brake pads

 For your own safety: use only brake pads that BMW has released for your particular vehicle model. BMW cannot evaluate non-approved brake pads to determine if they are suitable for use, and therefore cannot ensure the operating safety of the vehicle if they are installed. ◀

Portable phone in the vehicle

 BMW advises against using mobile equipment, e.g. cellular phones, inside the vehicle without connecting them directly to an outside antenna. Otherwise, it cannot be ruled out that vehicle electronics and the mobile equipment interfere with one another. In addition, it is not ensured that the radio waves emitted during transmission are directed outside of the vehicle interior. ◀

The concept

ABS keeps the wheels from locking during braking, thereby enhancing active driving safety.

Braking with ABS

If you are in a situation that requires full braking, you will exploit the full benefits of ABS system if you apply maximum pedal pressure: panic stop. Since the vehicle maintains steering responsiveness, you can avoid possible obstacles with a minimum of steering effort, despite the full brake application.

Pulsation at the brake pedal combined with sounds from the hydraulic circuits indicates to the driver that ABS is in its active mode.

Dynamic Brake Control (DBC)

DBC is included in the DSC, refer to page 86.

If you apply the brakes rapidly, this system automatically generates maximum braking force boost and thus helps to achieve the shortest possible braking distance in panic braking situations. All of the benefits of the ABS are exploited under these circumstances.

Do not reduce the pressure on the brake pedal for the duration of the brake application. When the brake pedal is released, the DBC is deactivated.

Cornering Brake Control (CBC)

CBC is an advanced engineering development of ABS. When braking during cornering with high lateral acceleration, or when braking during a lane change, vehicle stability is improved and the steering response is enhanced.

It is not necessary to remove the fabric top even in the winter, when the hardtop is generally in constant use. But you can also remove it easily at any time. Before the fabric top is stored in the convertible top compartment, it must be absolutely dry in order to avoid water spots and mildew from forming. The hardtop offers reading lamps and clothes hooks that can be used just by pressing. It is also possible to mount a luggage rack on the roof. Please consult your BMW center.

 When hanging clothing from the hooks, be sure that they will not obstruct the driver's vision. Do not hang heavy objects on the hooks. If you do so, they could cause personal injury during braking or evasive maneuvers. ◀

Two people are required for installation or removal. Work with extreme caution in order to avoid paint damage and damage to the body or hardtop.

To facilitate hardtop installation or removal, you can obtain a specially designed hardtop lift* or hardtop rack* at your BMW center.

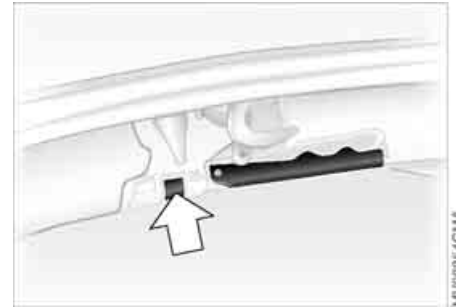
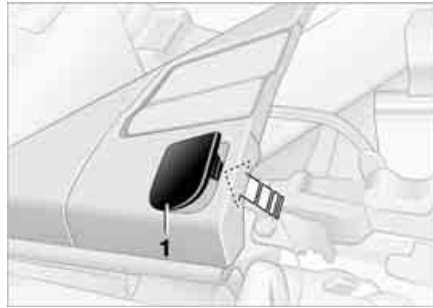
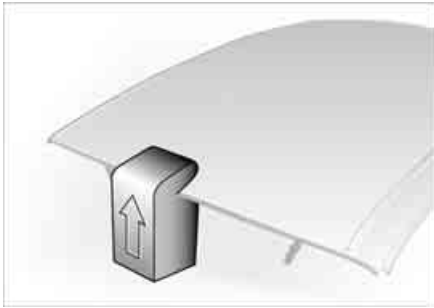

Storage

 Storing the hardtop on the floor: slide the styrofoam block that came with the hardtop onto its center. The arrow on top of the styrofoam block has to be pointing upward when you are doing this. ◀

3. Press trim piece 1 on each side of the car upwards and remove. Do so by pulling the tab on trim piece 1 in the direction of travel

4. Open the two front locking levers on the hardtop. Press on the buttons to do so. The levers will release slightly. Open the levers as far as possible

Installation

1. Lower the side windows completely and flip the sun blinds down. If necessary, remove the antenna rod to avoid any damage
2. Open the convertible top compartment lid slightly by pressing the button for the convertible top operation, refer to page [40](#)

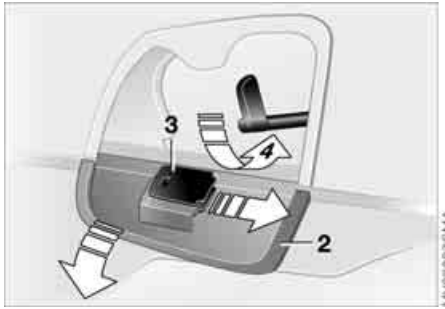

5. Before installing, first flip down the cover panels 2 that are located underneath the left and right interior lamps. To do this, press on the slight bump on cover panel 2. There is a holder in the cover panel to securely store the trim pieces that have been removed. Pull the adapter 3 out of the holder, clip the trim piece into the bottom and reinsert the adapter
6. Open the red locking levers as far as the stop will allow, see arrow 4

7. Position the hardtop onto the support brackets with the help of a second person. Be sure to put the mountings exactly into the proper brackets



Lift the hardtop carefully. Be extremely careful not to shift the seals. Seals that have been shifted out of place or actually pulled out cause leaks. ◀

8. In the back, close the red locking levers by turning to the inside as far as the stop located behind the trim will allow. Flip the cover panels back into place
9. To lock the hardtop in the front, close the front locking levers until you hear them engage
10. Check the seal between the windshield frame and the hardtop on both the left and right sides. If it is folded or bent out of place, you should smooth it back into position by hand to ensure secure and reliable sealing.

Removal

Follow the same procedure as when installing, just reverse the steps.

Information for your safety

It is not merely the tire's service life, but also driving comfort and, above all else, driving safety that depend on the condition of the tires and the maintenance of the specified tire pressure.

Checking tire pressures

Only check the tire inflation pressures of cold tires. This means after driving a maximum of 1.25 miles/2 km or after the vehicle has been parked for at least 2 hours. Warm tires have higher inflation pressures.

 Check tire inflation pressures regularly and correct them if necessary: at least twice a month and before beginning a longer trip. Otherwise, incorrect tire pressures can cause driving instability or tire damage, ultimately resulting in accidents. Do not drive on a deflated, i.e. flat, tire. A flat tire greatly impairs steering and braking response, and can lead to complete loss of control over the vehicle. ◀

After correcting the tire inflation pressure, reinitialize the Flat Tire Monitor, refer to page 87.

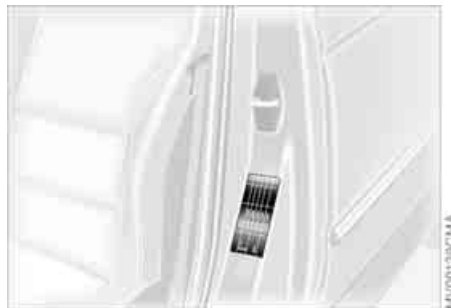

Inflation pressures for original tires

Tire pressures for the standard tires of your vehicle are shown on the driver's door post, visible when the door is open.

The inflation pressures apply to BMW-approved tire sizes and recommended tire brands. Your BMW center will be glad to supply this information.

Inflation pressures for other tire sizes

The following tire pressure table shows all tire pressures for the given tire sizes at ambient temperature.

BMW	Tires All pressure specifications in the table are indicated in psi/kilopascal with cold tires – cold = ambient temperature				
	225/45 ZR 18	33/230	–	41/280	–
	255/40 ZR 18	–	35/240	–	48/330
M3	225/40 ZR 19	33/230	–	41/280	–
	255/35 ZR 19	–	35/240	–	48/330
	225/45 R 17 91 H M+S	33/230	38/260	36/250	46/320
	225/40 R 18 92 V M+S	36/250	38/260	39/270	51/350

Knowing the tire code on the tire sidewall makes it easier to correctly choose and identify your tires.

Tire size

E.g. 205/60 R 15 91 W

205 = Nominal width in mm

60 = Cross-sectional ratio in %

R = Radial belt construction

15 = Rim diameter in inches

91 = Load index, not on ZR tires

W = Speed rating, in front of the R on ZR tires

Speed rating

Q = up to 100 mph (160 km/h)

T = up to 118 mph (190 km/h)

H = up to 130 mph (210 km/h)

V = up to 150 mph (240 km/h)

W = up to 167 mph (270 km/h)

Y = up to 186 mph (300 km/h)

Tire Identification Number

Tires with DOT codes comply with the guidelines of the U.S. Department of Transportation.

DOT code:

E.g. DOT xxxx xxx 3204

xxxx = Manufacturer's code for tire brand

xxx = Tire size and tire version

3204 = Tire age

Tire age

The date on which the tire was manufactured is indicated by the code on the sidewall:

DOT ... 3204 indicates that the tire was manufactured in week 32 of the year 2004.

BMW recommends the replacement of all tires when they are no more than 6 years old, even if a tire life of 10 years is possible.

Uniform Tire Quality Grading

Quality grades can be found where applicable on the tire sidewall between tread shoulder and maximum section width. For example:

Tread wear 200 Traction AA

Temperature A

DOT quality grades

Tread wear

Traction AA A B C

Temperature A B C



All passenger car tires must conform to Federal Safety Requirements in addition to these grades. ◀

Tread wear

The tread wear grade is a comparative rating based on the wear rate of the tire when tested under controlled conditions on a specified government test course.

For example, a tire graded 150 would wear one and one-half – 1 1/2 – times as well on the government course as a tire graded 100. The relative performance of tires depends upon the actual conditions of their use, however, and may depart significantly from the norm due to variations in driving habits, service practices and differences in road characteristics and climate.

Traction

The traction grades, from highest to lowest, are AA, A, B, and C.

Tire code

Those grades represent the tire's ability to stop on wet pavement as measured under controlled conditions on specified government test surfaces of asphalt and concrete. A tire marked C may have poor traction performance.

 The traction grade assigned to this tire is based on straight-ahead braking traction tests, and does not include acceleration, cornering, hydroplaning, or peak traction characteristics. ◀

Temperature

The temperature grades are A, the highest, B, and C, representing the tire's resistance to the generation of heat and its ability to dissipate heat when tested under controlled conditions on a specified indoor laboratory test wheel.

Sustained high temperature can cause the material of the tire to degenerate and reduce tire life, and excessive temperature can lead to sudden tire failure. The grade C corresponds to a level of performance which all passenger car tires must meet under the Federal Motor Vehicle Safety Standard No. 109.

Grades B and A represent higher levels of performance on the laboratory test wheel than the minimum required by law.

 The temperature grade for this tire is established for a tire that is properly inflated and not overloaded. Excessive speed, under-inflation, or excessive loading, either separately or in combination, can cause heat buildup and possible tire failure. ◀

M+S

Winter and all-season tires. These have better winter driving properties than summer tires.

Tire condition

Wheel/tire damage

Inspect your tires frequently for signs of damage, foreign objects and tread wear, and check tread depth.

 Due to low-profile tires, please note that wheels, tires and suspension parts are more susceptible to road hazard and consequential damages. Unusual vibrations encountered during normal vehicle operation can indicate tire failure or some other vehicle defect. This type of problem can be caused by contact with curbs, etc. This is also true for irregularities in the vehicle's handling characteristics, such as a pronounced tendency to pull to the left or right. Should this occur, respond by immediately reducing your speed. Proceed carefully to the nearest BMW center or professional tire center, or have the vehicle towed there. Tire damage, up to and including blowouts, can endanger the lives of both the vehicle occupants and other road users. ◀



TWI, Tread Wear Indicator. At a tread depth of 1/16 in/1.6 mm, the indicators signal that the legally permissible wear limit has been reached.

Tire tread

Tread depth should not be allowed to go below 1/8 in/3 mm, even though European legislation, for example, requires a minimum tread depth of only 1/16 in/1.6 mm. Below 1/8 in/3 mm tread depth, there is a great risk of hydroplaning, even at relatively moderate speeds and with only small amounts of water on the road.

At tread depths below approx. 3/16 in/4 mm, tire performance under winter driving conditions deteriorates noticeably. Worn tires should therefore be replaced for safety considerations.

Tread wear indicators in the tread-groove base, see arrow, are distributed around the wheel circumference and are labeled on the tire sidewall with

New wheels and tires

 Have new wheels and tires mounted only by a BMW center or specialized tire shop that works according to BMW requirements with appropriately trained personnel. Work that is improperly carried out could result in consequential damage and pose safety hazards. ◀

Ask your BMW center for details concerning the correct wheel and tire combination. Have the wheels balanced each time a wheel or tire has been replaced.

The correct wheel and tire combination also affects different systems such as ABS or DSC. The function of these systems is impaired if improper wheel and tire combinations are used.

 BMW advises against using retreaded tires, as driving safety could otherwise be impaired. The reason for this are the possibly different tire casing structures involved, some of which may be greatly aged, factors which can lead to a decrease in durability. ◀

New wheels and tires

The correct wheels and tires

 BMW recommends using only wheels and tires that have been tested and approved by BMW for the particular vehicle model, as otherwise body contact and serious accidents can result despite the use of the same nominal size, e.g. due to manufacturing tolerances. If non-approved wheels and tires are used, BMW cannot evaluate their suitability, and therefore cannot be held liable for driving safety. ◀

To maintain good handling characteristics, only use a full set of tires of the same brand and tread configuration. After a flat tire, have the previous wheel and tire combination restored as soon as possible.

Recommended tire sizes and brands

For each tire size, certain tire brands have been tested, classified as road-safe and approved by BMW. You can find out about these from a professional tire center, preferably your BMW center. Observe any country-specific regulations, e.g. on making a corresponding entry in the vehicle documents.

The factory-approved radial belt tires are matched to your vehicle and provide optimum safety and driving comfort when used properly.

Special characteristics of winter tires

BMW recommends the use of winter tires for operation under winter road conditions. While all-season tires with M+S designation provide better winter traction than summer tires, they generally do not achieve the full performance of winter tires.

Observing speed ratings

 Never exceed the maximum speed for which the winter tires are rated. Unprofessional attempts by laymen to service tires can lead to damage and accidents. Have this work performed by skilled professionals only. The technicians at your BMW center will be glad to assist you with the required professional knowledge and specialized equipment. ◀

Storage

Always store tires in a cool, dry place. Store them away from light whenever possible. Protect the tires against contact with oil, grease and fuel. Do not exceed the maximum tire inflation pressures specified on the tire sidewall.

Only certain snow chains have been tested by BMW and determined and approved as roadworthy. Consult your BMW center for more information. BMW recommends using only these approved fine-link snow chains. Use them in pairs on winter tires, but only on both rear wheels.

Comply with all manufacturer's safety precautions when mounting the chains. Do not exceed a speed of 30 mph / 50 km/h with snow chains.

After mounting or removing snow chains, always reinitialize the sequential M gearbox with Drivelogic, refer to page [87](#).



It is not possible to mount snow chains on tires with 18- and 19-inch wheels.

Deactivate the Flat Tire Monitor when using snow chains. Malfunction warnings and undetected losses in pressure are a possibility when driving with snow chains.

When driving with snow chains, it may be useful to deactivate DSC, refer to page [86](#). ◀

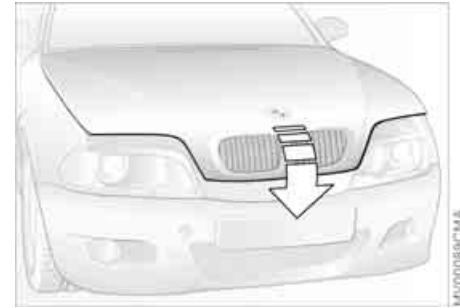
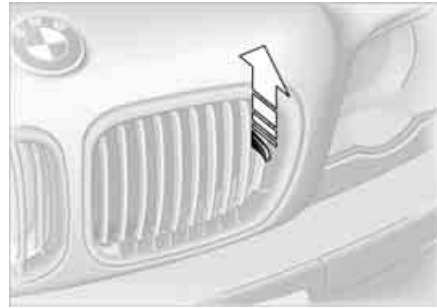
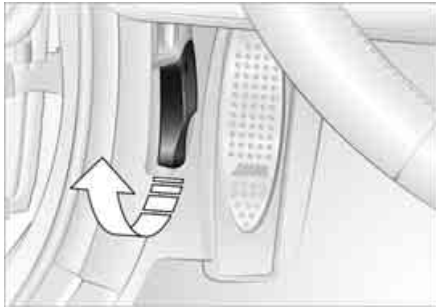

To release

Pull the lever located under the left-hand side of the instrument panel.

⚠ Do not attempt to service your vehicle if you do not have the required technical background. If you are not familiar with the regulations to be observed, have your vehicle serviced only by a BMW center or a shop that works according to BMW requirements with appropriately trained personnel. Work that is improperly carried out could result in consequential damage and pose safety hazards. ◀

To open

Pull the release handle and open the hood.

▶ It is not possible to drive off using SMG Drivelogic when the hood is open. ◀

To close

Pull the hood downwards and allow the hood to fall from a minimum height of 1 ft/30 cm so that it audibly engages. Check for proper locking by pulling on the hood at the left and right above the headlamps.

⚠ To avoid injuries, be sure that the travel path of the hood is clear when it is closed, following the same safety precautions used in all closing procedures. If you notice while driving that the hood is not completely closed, stop immediately and close it securely. ◀

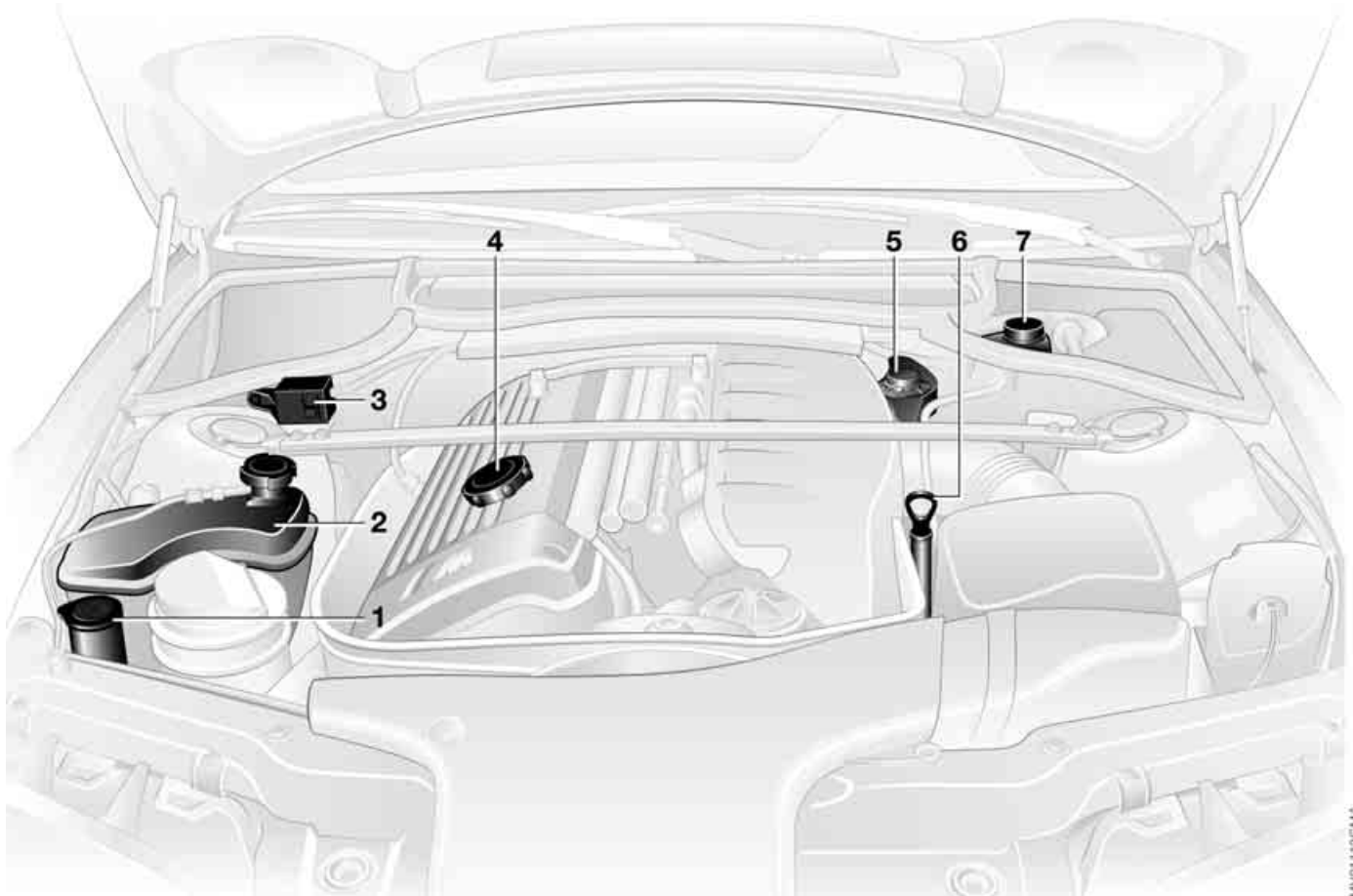

MV0141PCMA

- 1 Filler neck for windshield and headlamp washer cleaning system [126](#)
- 2 Coolant expansion tank [128](#)
- 3 Auxiliary terminal for jump-starting – positive terminal [147](#)
- 4 Engine oil filler neck [127](#)
- 5 Expansion tank for SMG Drivelogic hydraulic unit – checking and possible refilling by your BMW center [70](#)
- 6 Engine oil dipstick [126](#)
- 7 Filler neck for brake fluid [129](#)

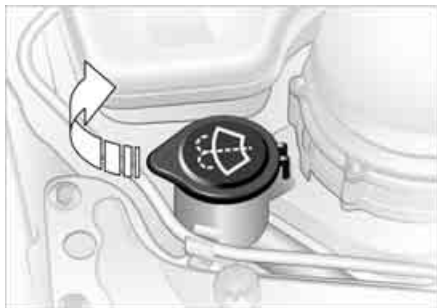

Headlamp* and windshield washer system

Capacity approx.
5.6 US quarts/5.3 liters.

Fill with water and, if required, with a washer antifreeze additive according to manufacturer's recommendations.

 We recommend that you mix the washer fluid before adding it to the reservoir. ◀

 Antifreeze agents for the washer fluid are highly flammable. For this reason, keep them away from sources of flame and store them only in their closed original containers, inaccessible to children. Comply with the instructions on the containers. ◀

Engine oil

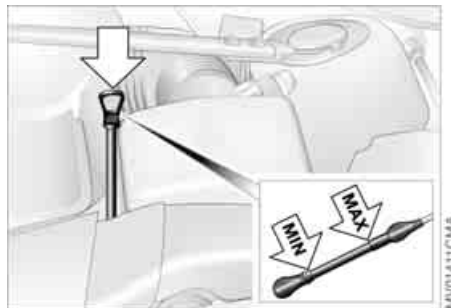

The oil volume between the two marks on the dipstick corresponds to approx. 1.4 US quarts/1.3 liters.

Checking the oil level

1. Park the vehicle on a level surface
2. Switch the engine off after it has reached normal operating temperature
3. After approx. 1 minute, pull the dipstick out and wipe it off with a clean lint-free cloth, paper towel, or similar material
4. Carefully push the dipstick all the way into the guide tube and pull it out again
5. The oil level should be between the two marks on the dipstick.

As with fuel economy, oil consumption is directly influenced by your driving style and vehicle operating conditions.

Engine oil

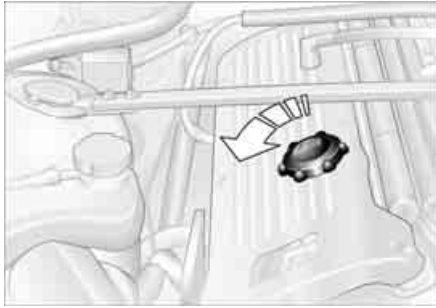



Adding engine oil

Only add engine oil when the oil level has dropped to just above the lower mark on the dipstick.

Do not fill beyond the upper mark on the dipstick. Excess oil will damage the engine.

Before checking the engine oil level after topping up, restart the engine and allow it to run to obtain a correct display. Then proceed as described under Checking the oil level.

 Continuous exposure to used oil has caused cancer in laboratory testing. For this reason, thoroughly wash any areas of skin that come into contact with oil using soap and water. Store oils, grease and similar materials so that they are inaccessible to children. Comply with warning labels and information on containers. ◀

 Comply with the applicable environmental laws regulating the disposal of used oil. ◀

Recommendation: have the oil changed by your BMW center.

Specified engine oils

The quality of the engine oil is extremely important for the function and life of an engine. Based on extensive testing, BMW has approved only certain grades of engine oil.

Use only oils approved for your vehicle model.

 Ask your BMW center for details concerning oils that have been approved. You can also call BMW of North America toll-free at 1-800-831-1117 or visit this website: www.bmwusa.com to obtain this information. ◀

 BMW engines are designed to operate without oil additives; the use of additives could even lead to damage in some cases. ◀

Alternative oil types

If a High Performance Synthetic Oil approved by BMW should be unavailable, you may use small volumes of other synthetic oils for topping up between oil changes. The following data must appear on the packaging:

- ▷ Viscosity
 - preferred: SAE 10W-60
 - alternative: SAE 5W-40 or SAE 10W-40
- ▷ Specifications
 - preferred: API SJ/CF
 - alternative: API SJ – also SK, SL, S etc.

Low ambient temperatures

The oils used by BMW at the factory for your vehicle model can be used at virtually any ambient temperature.

However, if the vehicle is exposed to temperatures below $-4^{\circ}\text{F}/-20^{\circ}\text{C}$ for extended periods, please have your BMW center recommend a suitable oil.

Coolant

 Do not open the cooling system when the engine is hot. If you do, escaping coolant can cause burns. ◀

Coolant consists of water and coolant additives. Not all commercially available additives are suitable for your BMW. Your BMW center knows which additives are appropriate.

 Only use approved additives, as the engine could otherwise be damaged. The additives are hazardous to health. ◀

 Comply with the applicable environmental laws regulating the disposal of coolant additives. ◀

**Checking the coolant level**

1. The engine must be at ambient temperature
2. Open the cap for the expansion tank by turning it slightly counterclockwise to allow accumulated pressure to escape. Then open
3. The coolant level is correct when the upper end of the red float is even with the upper edge of the filler neck, refer to the arrow in the illustration or to the schematic diagram next to the filler neck
4. If necessary, slowly add coolant until the correct level is reached; do not overfill
5. Close the cap by turning until it is well tight
6. Have the cause for the coolant loss removed as soon as possible.

Brake fluid

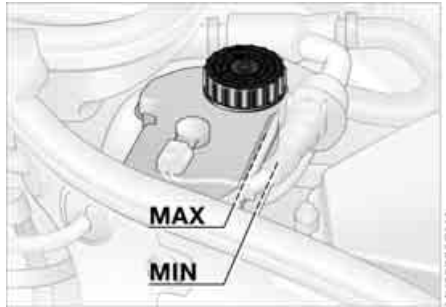

Adding brake fluid

For adding brake fluid or for determining and correcting the cause of brake fluid loss, consult your BMW center. Your BMW center is familiar with the specifications for factory-approved brake fluids – DOT 4.

Due to loss in brake fluid, pedal travel can lengthen and braking efficiency may be reduced.



Brake fluid is hygroscopic, that is, it absorbs moisture from the air over time.

In order to ensure the safety and reliability of the brake system, have the brake fluid changed every two years by a BMW center. Refer also to the Service and Warranty Information Booklet for US models or the Warranty and Service Guide Booklet for Canadian models. Brake fluid is toxic and damages the vehicle's paint. You should always store it in its closed original container and in a location inaccessible to children. Do not spill the brake fluid and do not fill the brake fluid reservoir beyond the MAX mark. The brake fluid could ignite upon contact with hot engine parts and cause serious burns. ◀



Comply with the applicable environmental laws regulating the disposal of brake fluid. ◀

Indicator lamp

BRAKE

The warning lamp comes on even though the parking brake is released:

The brake fluid level is too low, refer to page 18. At the same time, there may be significantly greater pedal travel. Have the system checked immediately.



Warning lamp for Canadian models.



If you continue driving, extended pedal travel may be necessary and braking distances may be significantly longer. Be sure to adapt your driving style accordingly. ◀

The BMW Maintenance System helps maintain your vehicle's road safety and operational safety. Comfort-related aspects, such as the timely change of filters for the air inside the vehicle, are taken into consideration. The goal is to optimize maintenance with respect to low total cost of ownership.

If you should sell your BMW one day, consistent service and maintenance will prove to your advantage.



Service interval display

The service interval display shows you when an oil service, an inspection – always alternating between I and II – or a brake fluid change is due. The special feature is that the service intervals are calculated according to your BMW's individual driving conditions instead of from fixed mileage increments.

The technology developed for this takes your personal driving style into account, as well as your BMW's driving conditions. After all, short-distance driving, i.e. frequent cold starts, or driving off at high engine speeds, affects your BMW differently from long-distance driving with the engine at consistent operating temperature.

▶ Have a break-in inspection performed at 1,250 miles/2,000 km regardless of the service interval indicated on the display. ◀

Special feature regarding engine oil change

The calculation of the service intervals covers practically every kind of operating situation. If you drive very rarely, however, you should have the oil changed at least every two years, since engine oil deteriorates over time regardless of use.

Service and Warranty Information Booklet for US models/Warranty and Service Guide Booklet for Canadian models

For additional information on required maintenance intervals and procedures, please refer to the Service and Warranty Information Booklet for US models, or the Warranty and Service Guide Booklet for Canadian models.

As a precaution against corrosion, it is advisable to have the body checked for damage from rocks or gravel at the same time, depending upon operating conditions.

BMW Maintenance System



Have your BMW center perform maintenance and repair.

Be sure that all maintenance work is recorded in the Service and Warranty Information Booklet for US models, or in the Warranty and Service Guide Booklet for Canadian models. These entries are your verification for the regular maintenance of your vehicle and are required for the performance of warranty repairs. ◀

Care

You can find everything you need to know on this topic by consulting the separate Caring for your vehicle brochure.



The Onboard Diagnostic OBD interface socket is located on the left of the driver's side under the instrument panel and under a cover.

The cover has the letters OBD on it.

The purpose of the OBD system is to ensure proper operation of the emission control system for the vehicle's lifetime. The system monitors emission-related components and systems for deterioration and malfunction.



An illuminated lamp informs you of the need for service, not of the need to stop the vehicle.

However, the systems should be checked by your BMW center at the earliest possible opportunity.



Display in Canadian models for the malfunction described above.

Under certain conditions, the indicator will blink or flash. This indicates a rather severe level of engine misfire. When this occurs, you should reduce speed and consult the nearest BMW center as soon as possible. Severe engine misfire over only a short period of time can seriously damage emission control components, especially the catalytic converter.



When the fuel filler cap is not properly tightened, the OBD system can detect the vapor leak and the indicator will light up. If the filler cap is subsequently tightened, the indicator should go out within a few days. ◀

Event data recorders

Your vehicle may be equipped with one or more sensing and diagnostic modules or a recording device capable of recording or transmitting certain vehicle data or information. In addition, if you have a Subscription Service Agreement for the BMW Assist system, certain vehicle information may be transmitted or recorded in order to provide such services.

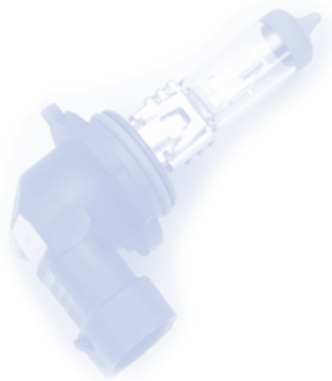
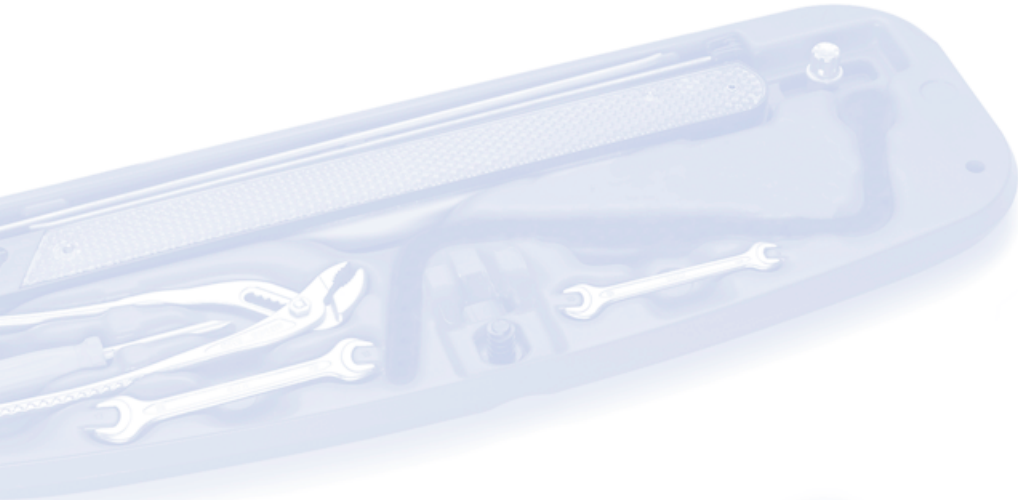



Overview

Controls and features

Operation, maintenance

Owner service procedures

Technical data

Index

Overview

Controls

Maintenance

Repairs

Data

Index



The onboard tool kit is located in the luggage compartment lid.

To open, loosen the wing nut. For storage place of towing eyelet, refer to page 149.

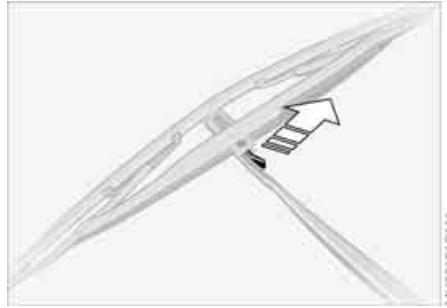

1. Switch off the engine
2. Fold the wiper arm completely out from the windshield
3. Position the wiper blade at an angle and pull the release spring – see arrow
4. Fold the wiper blade down and unhook it toward the windshield
5. Pull the wiper blade past the wiper arm toward the top
6. Insert a new wiper blade and apply pressure until you hear it engage.

Lamps and bulbs

The lamps and bulbs make essential contributions to the safety of your vehicle. Therefore, proceed carefully when handling bulbs. BMW recommends that you have such work performed by your BMW center if you are not familiar with the procedures.

 Do not touch the glass portion of a new bulb with your bare hands since even small amounts of impurities burn in to the surface and reduce the service life of the bulb. Use a clean cloth, paper napkin, or a similar material, or hold the bulb by its metallic base. ◀

A replacement bulb set is available from your BMW center.

 Before working on the electrical system, switch off the electrical accessory you are working on or disconnect the cable from the negative terminal of the battery. Failure to observe this precaution could result in short circuits. To prevent injuries and damage when changing a bulb, be sure to comply with any instructions provided by the bulb manufacturer. ◀

Low beams and high beams

- ▷ Low beams: H7 bulb, 55 watts
- ▷ High beams: H7 bulb, 55 watts

 The H7 bulb is pressurized. Therefore, wear safety glasses and protective gloves. Failure to comply with this precaution could lead to injury if the bulb is damaged. ◀

Please contact a BMW center in case of a malfunction.

Parking lamps

5 watt bulb

Please contact a BMW center in case of a malfunction.

When cleaning the headlamps, please follow the instructions in the Caring for your vehicle brochure.

Xenon lamps*

The service life of these bulbs is very long and the probability of a failure is very low, provided that they are not switched on and off an unusual number of times. If one of these bulbs should nevertheless fail, it is possible to continue driving with great caution using the fog lamps, provided traffic laws in your area do not prohibit this.



Because of the extremely high voltages involved, any work on the xenon lighting system, including bulb-changing, should be carried out by technically qualified personnel only. Otherwise, there is a risk of fatal injury. ◀

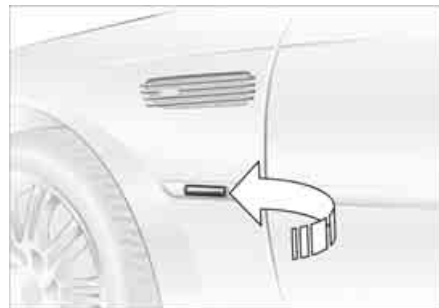
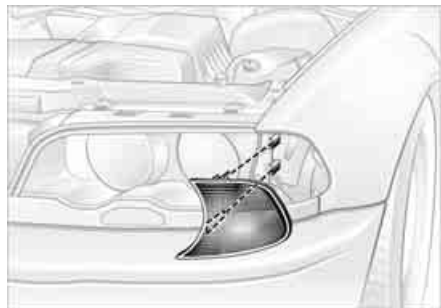

Front turn signal indicators

21 watt bulb

1. Extend a screwdriver through the upper opening, loosen the screw and remove it
2. Remove lamp by pulling it out toward the front
3. Applying light pressure, turn the bulb to the left. Remove and exchange the bulb

4. Insert the 2 pins on the lamp into the guides on the vehicle
5. Slide in the lamp and screw the bulb in place through the upper opening.

Side turn signal indicators

5 watt bulb

1. Press the back edge of the lamp toward the front with the tip of your finger and remove
2. Apply gentle pressure to the bulb while turning it to the left to remove.

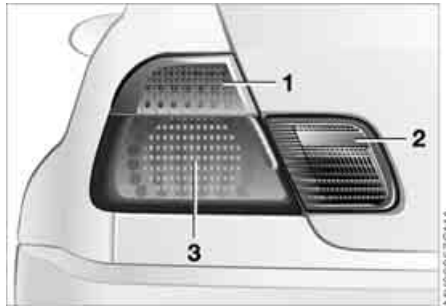

Rear lamps

- 1 Turn signal indicator LEDs
- 2 Backup lamp
21 watt bulb
- 3 Tail lamp/brake lamp LEDs

 Please contact a BMW center in case of a defect with the LED lamps. ◀



Bulbs in the luggage compartment lid
1. Using a screwdriver, loosen the clip

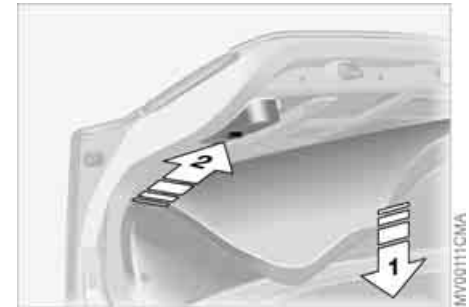

- 2. Fold the trim panel down – see arrow 1. Disengage the bulb holder – see arrow 2 – and remove it
- 3. Applying light pressure, turn the bulb to the left. Remove and exchange the bulb
- 4. Press the bulb holder into position until you hear it engage
- 5. Reinstall the trim with the clip.

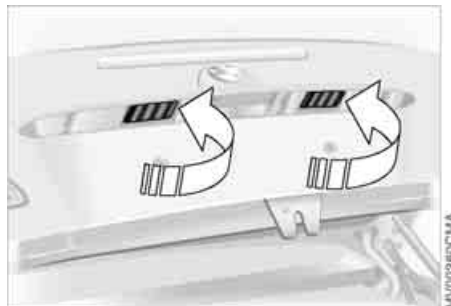
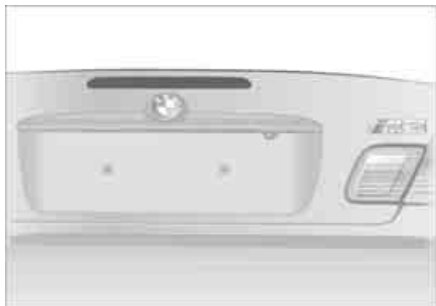

 Do not remove the protective lens, and avoid staring directly at the unfiltered beam for several hours, as inflammation of the retina could result. ◀

Center high-mount brake lamp

LED strip in luggage compartment lid.

Please contact a BMW center in case of a malfunction.

License plate lamps

5 watt bulb

1. Place a screwdriver in the slot and press toward the left to release the lens
2. Replace the bulb.

Light-emitting diodes

Light-emitting diodes (LEDs) installed behind translucent lenses serve as the light sources for many of the controls and displays in your vehicle. These light-emitting diodes are related to conventional lasers, and legislation defines them as light-emitting diodes, Class 1.

Tire repair with the M Mobility system

 Precautions in case of a flat tire:
Stop the vehicle as far as possible from passing traffic and position it on a firm surface. Turn on the hazard warning flashers.

Turn the steering wheel to the straight-ahead position and engage the steering lock. Engage the parking brake and shift into 1st or reverse gear.

All passengers should be outside the vehicle and well away from your immediate working area – behind a guardrail, for instance.

If necessary, set up your warning triangle or portable hazard warning lamp on the roadside at an appropriate distance from the rear of the vehicle. Comply with all safety guidelines and regulations. ◀

You will find an M Mobility system in the BMW M3 Convertible for repairing flat tires. With this system you can apply a sealant to the inside of the tire, thus seal off the damaged point, then reinflate the tire and continue driving.





 Please observe the expiration date on the sealant bottle. ◀

Preparing to repair a tire

The M Mobility system is located in the luggage compartment under the floor panel.

If possible, leave the foreign object in the tire.

 You will find corresponding instructions for using the M Mobility system on the device. ◀

 Before using the M Mobility system, read the warnings on the sealant bottle. ◀

Pull the sticker showing the speed limit from the sealant bottle and stick it onto the steering wheel.

142 Tire repair with the M Mobility system



Components of the M Mobility system

- 1 Sealant bottle and sticker showing the speed limit
- 2 Filler hose from the sealant bottle to the wheel



System version with manometer on the hose*

- 3 Plug and cable for the cigarette lighter socket
- 4 Connector for the sealant bottle
- 5 Compressor
- 6 On/Off switch
- 7 Manometer for indicating the tire pressure
- 8 Screw for reducing the filling pressure
- 9 Hose connecting compressor and sealant bottle, or compressor and wheel

Plug, cable and connecting hose are stored inside the compressor box.

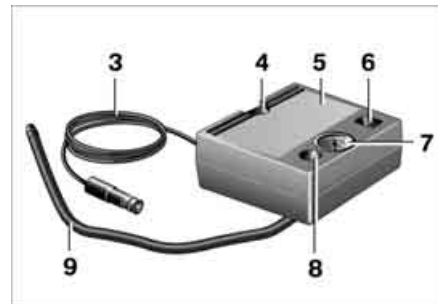

System version with manometer integrated in the box*

- 3 Plug and cable for the cigarette lighter socket
- 4 Connector for the sealant bottle
- 5 Compressor
- 6 On/Off switch
- 7 Manometer for indicating the tire pressure
- 8 Screw for reducing the filling pressure
- 9 Hose connecting compressor and sealant bottle, or compressor and wheel

Plug, cable and connecting hose are stored inside the compressor box.

Tire repair with the M Mobility system

Using the M Mobility system

To repair a flat tire using the M Mobility system, proceed as follows:

- ▷ Fill with sealant, refer to page 143
- ▷ Distribute the sealant, refer to page 143
- ▷ Restore tire inflation pressure, refer to page 143.

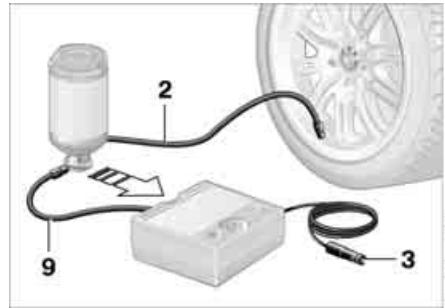

Filling with sealant

1. Shake the bottle of sealant
2. Screw hose 9 onto the opening of the sealant bottle
3. Twist the dust cap off of the valve on the flat tire and screw filler hose 2 connected to the sealant bottle onto the valve
4. Insert the sealant bottle into the connector on the compressor so that it is standing upright
5. Make sure that the system is switched off, position 0
6. Insert connector 3 into the cigarette lighter socket inside the vehicle, refer to page 101
7. When using the version with the manometer on the hose: make sure that screw 8 on the manometer is tightened down

8. With the ignition key in position 2: Switch on the compressor and keep it running for approx. 3 minutes to fill in the sealant. It does not matter afterward, what the tire's inflation pressure is
9. Turn the system off and disconnect the hose from the sealant bottle and the wheel valve. Stow the M Mobility system in the vehicle.

Distributing the sealant

Right afterward, drive at least about 2 miles / 3 km, so that the sealant is distributed evenly in the tire.

 Do not exceed a maximum speed of 35 mph / 60 km/h. If possible, keep the vehicle speed above 12 mph / 20 km/h. ◀

Inflating tire to correct pressure

1. After driving approx. 1.9 miles/3 km, pull over at a suitable location
2. Screw hose 9 connected to the compressor directly onto the tire valve
3. Insert connector 3 into the cigarette lighter socket inside the vehicle

4. Adjust the tire inflation pressure to 29 psi / 200 kilopascal. For this purpose, with the ignition key in position 2:

- ▷ Increase the tire pressure: switch on the compressor, position I. To check the current inflation pressure, turn off the device briefly
- ▷ Reduce the tire pressure: press button 8, or turn screw 8 on the manometer.

 Do not run the compressor for longer than 10 minutes, otherwise the unit may overheat and be damaged. ◀

 If the tire fails to hold the pressure, drive the vehicle again, see Distributing the sealant. Then repeat Steps 1 through 4.

The use of the M Mobility system may be ineffective if the damaged area in the tire is larger than approx. 1/8 in / 4 mm. If the tire cannot be temporarily repaired with the M Mobility system, please consult the nearest BMW center, or a workshop that has appropriately trained personnel working in accordance with BMW specifications. ◀

 The tire pressure must be at least 29 psi / 200 kilopascal. Otherwise, do not continue driving. ◀

Driving on

 Do not exceed the maximum speed limit of 45 mph / 80 km/h; otherwise, accidents may occur. ◀

 Have the damaged tire replaced as soon as possible. Reinitialize the Flat Tire Monitor, and refer to page 87 for further information. Have the sealant bottle of the M Mobility system replaced. ◀

Battery

 Battery posts, terminals, and related accessories contain lead and lead compounds. Wash hands after handling. ◀

Maintenance

The battery is completely maintenance-free. This means that the original battery acid will normally last for the service life of the battery under moderate climate conditions. Your BMW center will be glad to advise you if you have any questions concerning the battery.

 Please consult your BMW center whenever you have any questions concerning the battery. ◀

Charging the battery

Charge the battery in the vehicle only when the engine is not running. Use the connections provided in the engine compartment. For information on the connections, see Jump-starting, page 147.

Battery

Disposal



After changing the battery, have the old battery disposed of by your BMW center or bring it to a recycling point. Maintain the battery in an upright position for transport and storage. Secure the battery against tilting in transit. ◀

Power loss

After a temporary power loss, e.g. due to a discharged battery, some equipment will be limited in its use and will have to be reinitialized. Individual settings are also lost and must be reset:

- ▷ Seat and mirror memory
The position settings must be stored again, refer to page [51](#)
- ▷ The trap protection of the electric power windows must be re-initialized, refer to page [39](#)
- ▷ Clock
must be reset, refer to page [82](#)
- ▷ Radio
Stations must be reset, refer to the Owner's Manual for Radio/Onboard Computer
- ▷ Navigation system
The system will not be operable immediately, refer to the Owner's

Manual for Radio/Onboard Computer.

Fuses

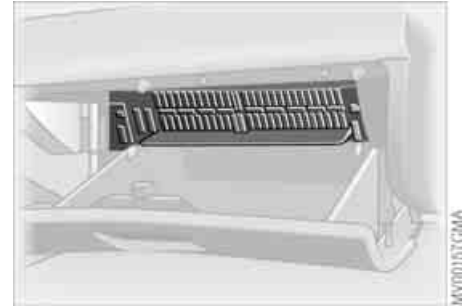

You will find the fuses and information on their respective allocation in the glove compartment behind a panel with two snap clips.



Do not attempt to repair a blown fuse or replace it with a fuse having a different color or amperage rating. To do this could cause a fire in the vehicle resulting from a circuit overload. ◀

The BMW Group's Mobile Service offers you 24-hour assistance in the event of a breakdown, even on weekends and holidays.

The telephone numbers of the Mobile Service control center in your country are listed in the Contact brochure.

If your vehicle has the necessary equipment, you can contact the Mobile Service or issue an emergency call using buttons in the interior rearview mirror.

When an emergency call is initiated, a telephone connection is established with the BMW Assist response center.

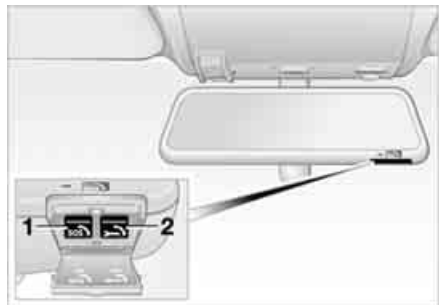

Fold down the cover.

1 Emergency call

2 Mobile Service

Requirements for initiating an emergency call or contacting Mobile Service:

- ▷ Ignition key in position 1 or higher
- ▷ The car phone must be registered with a mobile network
- ▷ The emergency call system must be operational.

Initiating an emergency call*

Press button 1 for at least 2 seconds.

The indicator lamp above the buttons lights up. As soon as a telephone connection has been set up to the BMW Assist response center, the indicator lamp flashes.

If the situation permits you to do so, wait in the vehicle until the voice connection is established. You can then provide detailed information to the response center.

If your vehicle is equipped with an activated BMW Assist and the current location of the vehicle can be determined, this location is transmitted to the BMW Assist response center.



If the navigation system has failed, the current location of the vehicle is not transmitted. ◀

If the indicator lamp is flashing but you cannot hear the BMW Assist response center over the hands-free system, it is possible that e.g. the hands-free system is malfunctioning. The BMW Assist response center can still hear you, however.

If certain requirements are met, an emergency call is automatically initiated after a serious accident. The automatic emergency call will not be hindered by pressing the button.



For technical reasons, the emergency call function cannot be guaranteed in certain unfavorable conditions. ◀

Receiving assistance

Mobile Service*

To establish contact with the BMW Group's Mobile Service:

Press button 2 for at least 2 seconds.

The indicator lamp above the buttons lights up. As soon as a telephone connection has been set up with the Mobile Service, the indicator lamp flashes.

Depending on the country you are in, your vehicle's current location will also be transmitted if your vehicle is equipped with an activated BMW Assist function.

Jump-starting

When your battery is discharged, you can use two jumper cables to start your vehicle with power from the battery in a second vehicle. You can also use the same method to help start another vehicle. Use only jumper cables with fully insulated handles on the terminal clamps.

 Do not touch high-voltage wiring and cables on a running engine. Contact with components carrying high voltage can be harmful or fatal. Carefully observe the following instructions to avoid personal injury and/or damage to one or both vehicles. ◀

Preparations

1. Check whether the battery of the support vehicle has 12 volts and approximately the same capacity – measured in Ah. This information is provided on the battery
2. Stop the engine of the support vehicle
3. Switch off all consumers in both vehicles.

 Make absolutely certain that there is no contact between the bodywork of the two vehicles, otherwise there is a short circuit hazard. ◀

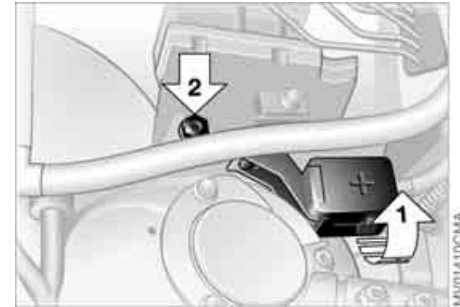

Connecting the jumper cables

 Be sure to connect the jumper cables in the right order; otherwise there is a risk of injury due to sparks being created near the battery. ◀

The jump-starting terminal located in your BMW's engine compartment serves as the positive battery terminal; refer also to the engine compartment overview on page 124. The cover of this auxiliary terminal is marked with a +.

1. Open the cover of the BMW jump-starting terminal. Do so by pulling the tab – see arrow 1
2. Connect one terminal clamp of the plus/+ jumper cable to the positive terminal of the battery or to a jump-starting terminal in the donor vehicle

3. Connect the second terminal clamp of the plus/+ jumper cable to the positive terminal of the battery or to a jump-starting terminal in the vehicle to be started
 4. Your BMW is equipped with a special nut – see arrow 2 – to serve as the ground or negative terminal. Attach a terminal clamp of the minus/- jumper cable to the negative terminal of the support vehicle's battery or to a suitable ground on its engine or bodywork
 5. Attach the second terminal clamp of the minus/- jumper cable to the negative terminal of the battery or to a suitable ground on the engine or bodywork of the vehicle to be started.
3. Allow the engines to run for several minutes
 4. Disconnect the jumper cables in reverse sequence.

Have the battery recharged at your BMW center as required.



Do not use spray starter fluids to start the engine. ◀

Starting the engine

1. Start the engine of the support vehicle and let it run for several minutes at a slightly elevated engine idle speed
2. Start the engine of the other vehicle as usual.
If the first start attempt is not successful, wait a few minutes before another attempt in order to allow the discharged battery to recharge

Towing and tow-starting the vehicle

 Always observe all applicable towing laws and regulations. ◀

Using the towing eyelet

The screw-in towing eyelet is in the luggage compartment under the floor panel and must remain with the vehicle at all times. It can be attached at the front or rear of your BMW.

 Observe the following instructions in order to avoid damaging the towing eyelet or the vehicle: use only the towing eyelet supplied with the vehicle, and screw it in firmly until it stops. Use the towing eyelet for towing on paved roads only. Avoid subjecting the towing eyelet to lateral loads, e.g. do not lift the vehicle using the towing eyelet. ◀

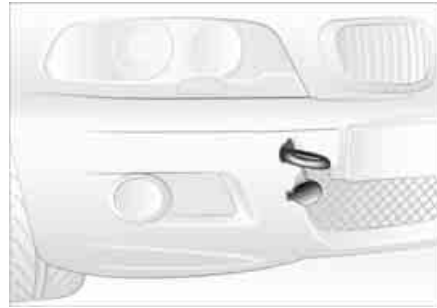

Access to the threaded socket

Press out the cover in the front or rear bumper with a screwdriver at the top of the recess.

Being towed

 Make sure that the ignition key is in position 1, even if the electrical system has failed, because the steering lock could otherwise engage and the vehicle could no longer be steered. There is no power assist while the engine is off. Therefore, you will need to exert more force to brake and steer the vehicle. ◀

Turn on the hazard warning flashers, if required by national regulations. If the electrical system has failed, clearly identify the vehicle being towed, e.g. by placing a sign or a warning triangle in the rear window.

Vehicles with manual transmission: gearshift lever in idling position.

Vehicles with sequential M gearbox with Drivelogic: selector lever in position N.

Towing methods

In some countries, it is not permitted to tow the vehicle with a tow bar or tow rope on public roads.

Familiarize yourself with the applicable towing regulations for the country in which you are driving.

With a tow bar

 The towing vehicle must not be lighter than the vehicle being towed; otherwise, vehicle handling can no longer be controlled. ◀

The towing eyelets of both vehicles should be on the same side.

150 Towing and tow-starting the vehicle

If the tow bar can only be used in a diagonal position, please note the following:

- ▷ Clearance is restricted while you are driving around corners
- ▷ The inclination of the tow bar produces lateral force.

 Only attach the tow bar to the towing eyelets. Other parts of the vehicles could otherwise be damaged. ◀

With a tow rope

When the towing vehicle is driving off, make sure that the tow rope is taut.

 Use nylon ropes or straps for towing because they prevent sudden jerking movements. Attach the tow rope only to the towing eyelets. Other parts of the vehicles could otherwise be damaged. ◀

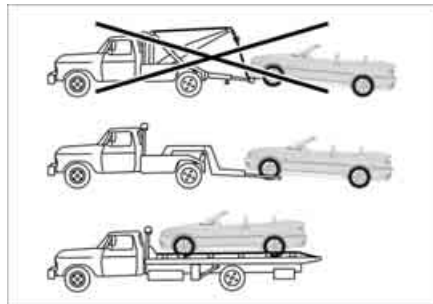

With a tow truck

Have the BMW transported by a tow truck with a lift sling, or on a flatbed.

 Never allow passengers to ride in a towed vehicle for any reason. ◀

 Do not lift the vehicle by the towing eyelet, nor by parts of the body or chassis. Otherwise damage could result. ◀

Tow-starting

Only tow-start vehicles with catalytic converters if the engine is cold. It is better to jump-start the engine, refer to page 147.

1. Turn on hazard warning flashers; comply with national regulations

2. Turn the ignition key to position 2
3. Engage the 3rd gear
4. Have the vehicle towed with the clutch pedal completely depressed and then slowly release the clutch pedal. After the engine has started, immediately depress the clutch pedal again completely
5. Pull over at a suitable location, remove the tow bar or tow rope, and turn on the hazard warning flashers
6. Have the vehicle checked.

Vehicles with sequential M gearbox with Drivelogic:

- ▷ Have the vehicle towed with the selector lever in position N
- ▷ Move the selector lever into position S and pull it toward + within 2 seconds. The correct gear will automatically be selected and engaged
- ▷ After the engine has started, move the selector lever into position N again.

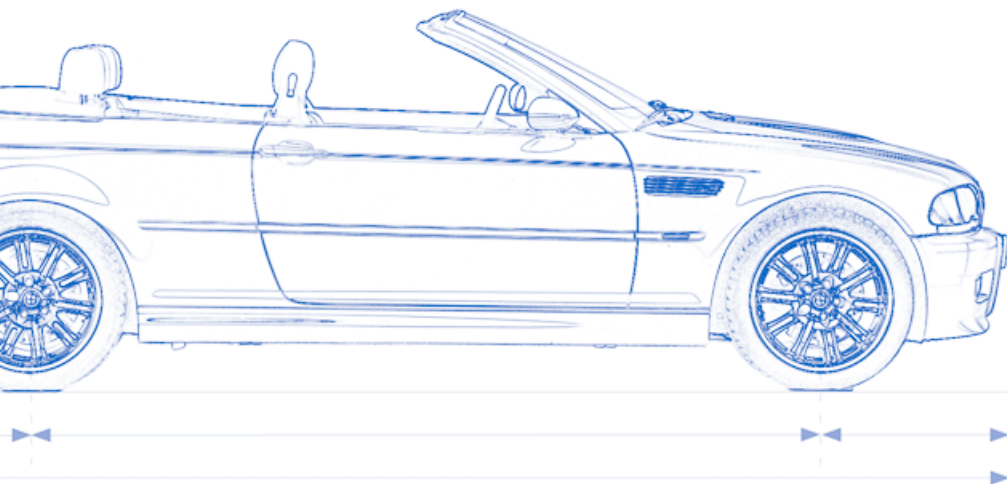

Overview

Controls and features

Operation, maintenance

Owner service procedures

Technical data

Index

Overview

Controls

Maintenance

Repairs

Data

Index

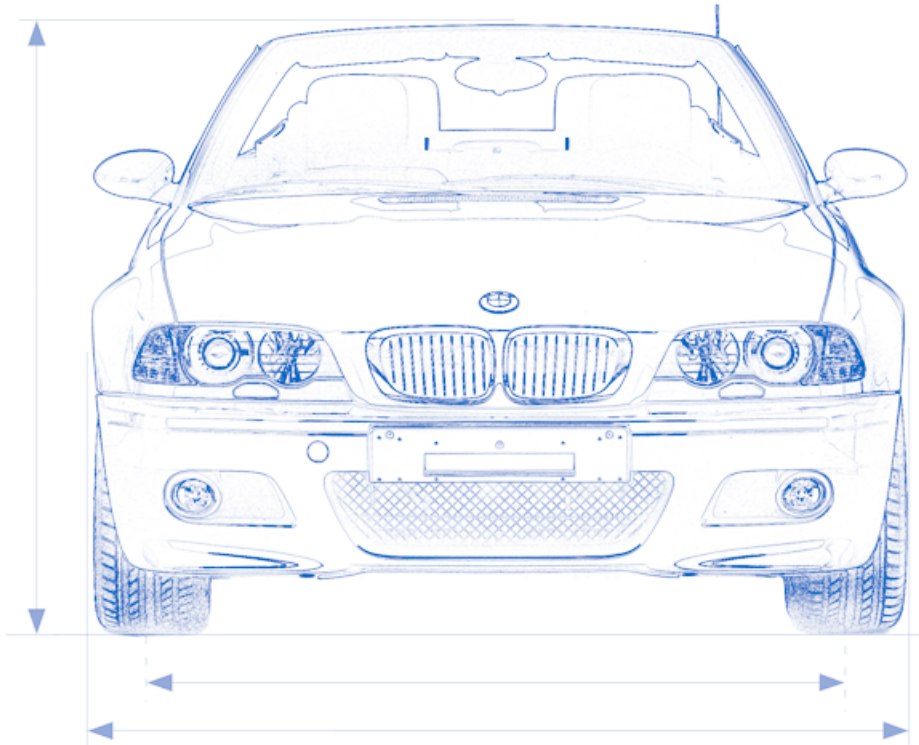

154 **Engine data**

Displacement	cu in/cm ³	198.1/3,246
Number of cylinders		6
Max. power output at engine speed	hp rpm	333 7,900
Maximum torque at engine speed	lb ft/Nm rpm	262/355 4,900
Compression ratio	ϵ	11.5
Stroke	in/mm	3.58/91
Bore	in/mm	3.43/87
Fuel mixture preparation		Digital electronic engine-management system

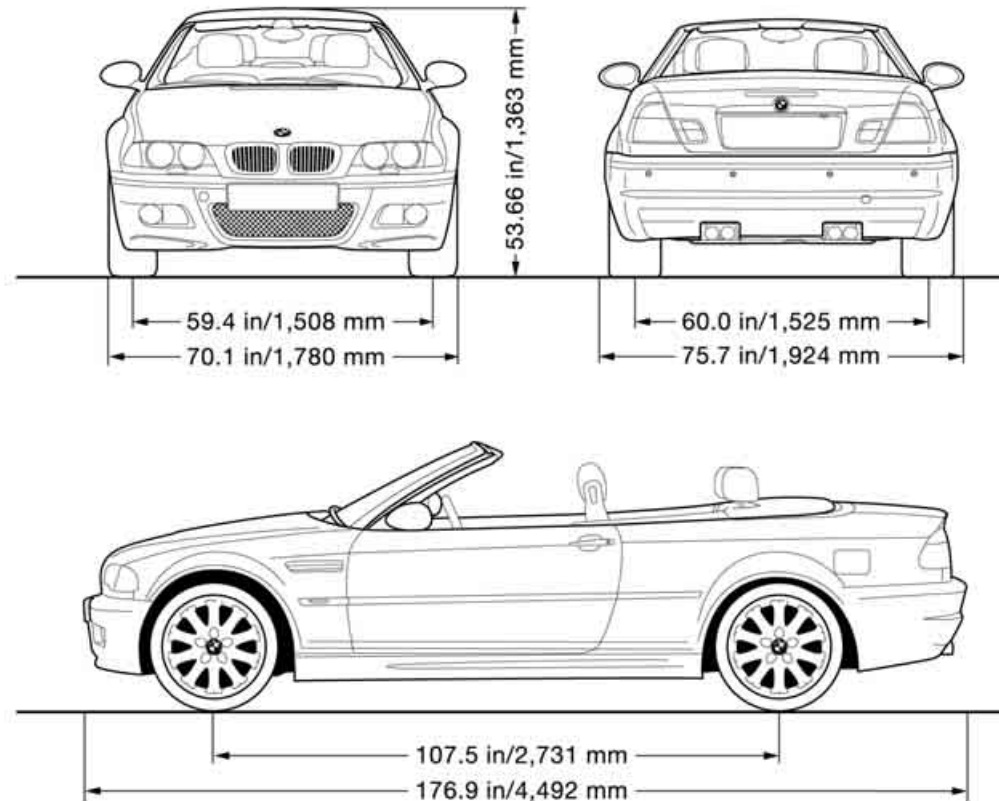

Minimum turning circle dia.: 36.1 feet/11.0 m.

156 **Weights**

Curb weight	lbs/kg	3,782/1,715
Approved gross vehicle weight	lbs/kg	4,608/2,090
Approved front axle load	lbs/kg	2,183/990
Approved rear axle load	lbs/kg	2,513/1,140
Permissible roof load for the hardtop	lbs/kg	165/75
Luggage compartment capacity	cu ft/l	9.2/260
with the convertible top compartment raised	cu ft/l	10.6/300

Approved axle loads and approved gross vehicle weight must never be exceeded.

			Notes
Fuel tank	gal./liters	approx. 16.6/63	Fuel specification, refer to page 25
Reserve	gal./liters	approx. 2.1/8	
Windshield washer system/ Headlamp cleaning system	quarts/liters	approx. 5.6/5.3	Specifications, refer to page 126
Engine with oil filter change	quarts/liters	approx. 5.8/5.5	Specifications, refer to page 127
Manual transmission	quarts/liters	approx. 1.9/1.8	Oil change during running-in check and during each inspection II
Differential	quarts/liters	approx. 1.2/1.1	Oil change during running-in check and during each inspection II

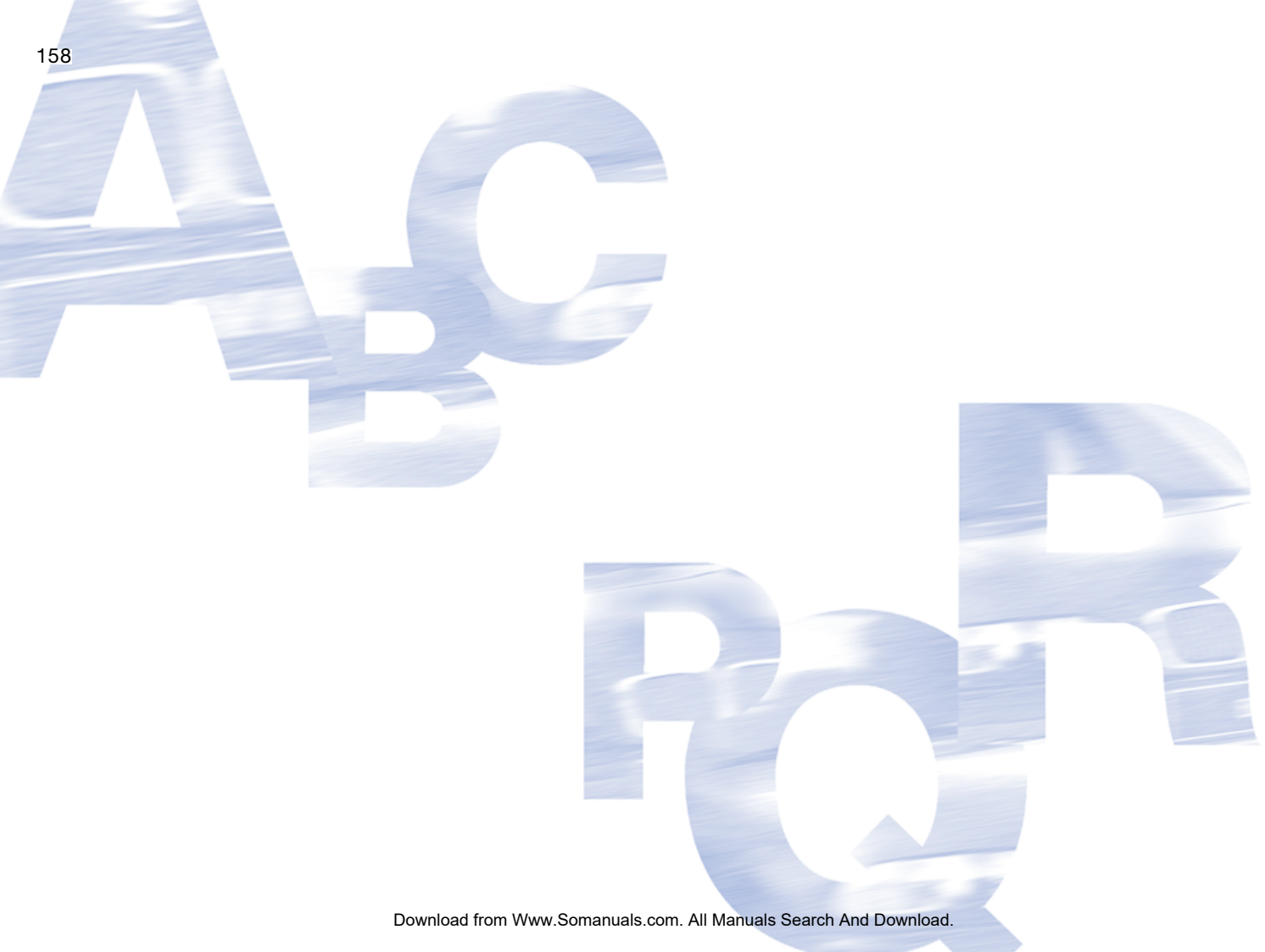



Overview

Controls and features

Operation, maintenance

Owner service procedures

Technical data

Index

Overview

Controls

Maintenance

Repairs

Data

Index

Everything from A to Z

A

ABS Antilock Brake System [113](#)
indicator lamp [19](#)
Accessories, refer to For your own safety [6](#)
Accident, refer to Emergency call [146](#)
Activated-charcoal filter [98](#)
Adaptive brake lamp, refer to Brake force display [89](#)
Adding brake fluid [129](#)
Additional sources of information [4](#)
Air conditioning mode
automatic climate control [96](#)
Air distribution
automatic climate control [96](#)
individual [96](#)
Air outlets, refer to Ventilation [94](#)
Air pressure, refer to Tire inflation pressure [116](#)
Air recirculation, refer to Recirculated-air mode [97](#)
Air supply
automatic climate control [96](#)
Air, drying, refer to Air conditioning mode [96](#)

Airbags [55](#)
deactivating [55](#)
indicator lamp [18](#), [57](#)
safe seating position [46](#)
Airing out, refer to Ventilation [94](#)
AKI, refer to Fuel specifications [25](#)
Alarm system [36](#)
avoiding unintentional alarms [37](#)
All-season tires, refer to Winter tires [120](#)
Alternative oils [127](#)
Antifreeze
coolant [128](#)
washer fluid [126](#)
Antilock Brake System (ABS) [113](#)
indicator lamp [19](#)
Anti-theft system [28](#)
Anti-theft warning system, refer to Alarm system [36](#)
Approved axle loads, refer to Weights [156](#)
Approved gross weight, refer to Weights [156](#)
Armrest [99](#)
Artificial leather, refer to the Caring for your vehicle brochure

Ashtray
front [100](#)
rear [101](#)
Assistant systems, refer to Dynamic Stability Control (DSC) [86](#)
AUC Automatic recirculated-air control [97](#)
AUTO program [96](#)
Automatic
cruise control [77](#)
headlamp control [90](#)
Automatic air distribution, refer to AUTO program [96](#)
Automatic air supply, refer to AUTO program [96](#)
Automatic car wash, refer to the Caring for your vehicle brochure
Automatic climate control [94](#)
Automatic curb monitor [52](#)
Automatic dimming, interior rearview mirror [53](#)
Automatic recirculated-air control (AUC) [97](#)
Automatic windshield washer, refer to Rain sensor [76](#)
Average fuel consumption [84](#)
Average speed [84](#)

Avoiding unintentional alarms [37](#)
Axle loads, refer to Weights [156](#)

B

Backrest
unlocking [49](#)
Backrest, refer to Seat adjustment [47](#)
Backup lamps [69](#)
bulb replacement [139](#)
Bandages, refer to First-aid kit [23](#)
Bar, for towing [149](#)
Battery [144](#)
charge [144](#)
disposal [145](#)
indicator lamp [18](#)
jump-starting [147](#)
remote control [28](#), [29](#)
Battery charge current [18](#)
Battery charge indicator lamp [18](#)
Belts, refer to Safety belts [50](#)
Beverage holders [100](#)
Blower
automatic climate control [96](#)
BMW Maintenance System [130](#)

BMW sports seat [47](#)
 Bore, refer to Engine data [154](#)
 Bottle holders, see Beverage holders [100](#)
 Brake fluid [129](#)
 indicator lamp [18](#), [129](#)
 level [129](#)
 Brake force display [89](#)
 Brake lamps
 bulb replacement [139](#)
 indicator lamp, defective lamp [81](#)
 Brake lamps, refer to Brake force display [89](#)
 Brake pads
 brake fluid level [18](#), [129](#)
 breaking in [110](#)
 Brake rotors
 breaking in [110](#)
 Brake system
 brake pads, indicator lamp [19](#)
 Brake wear warning indicator lamp [19](#)

Brakes
 ABS [113](#)
 brake fluid [129](#)
 brake force display [89](#)
 brake pads [112](#)
 breaking in [110](#)
 driving notes [111](#)
 indicator/warning lamp [18](#), [19](#)
 parking brake [68](#)
 Break-in procedures [110](#)
 Bridging, refer to Jump-starting [147](#)
 Bulb replacement [137](#)
 Bulb replacement, refer to Lamps and bulbs [137](#)
 Buttons in steering wheel [22](#)

C

California Proposition 65 warning [6](#)
 Can holders, see Beverage holders [100](#)
 Capacities [157](#)
 Car battery [144](#)
 Car care, refer to the Caring for your vehicle brochure
 Car keys, refer to Keys [28](#)
 Car phone hookup
 microphone [100](#)
 Car radio, refer to the Owner's Manual for Radio

Car telephone, refer to the separate Owner's Manual
 Car vacuum cleaner, connecting [101](#)
 Car wash, refer to the Caring for your vehicle brochure
 Carpet care, refer to the Caring for your vehicle brochure
 Cassette operation, refer to the Owner's Manual for Radio/Onboard Computer
 CBC Cornering Brake Control [113](#)
 warning lamp [19](#)
 CD changer, refer to the Owner's Manual for Radio/Onboard Computer
 CD operation, refer to the Owner's Manual for Radio/Onboard Computer
 Center armrest
 front [99](#)
 Center high-mount brake lamp
 bulb replacement [140](#)
 Central locking system [28](#)
 button [32](#)
 passenger compartment [32](#)
 Check Control [81](#)

Check Gas Cap indicator lamp [19](#)
 Child seats, refer to Child-restraint systems [58](#)
 Child-restraint mounting system LATCH [60](#)
 Child-restraint systems [58](#)
 Cigarette lighter [100](#)
 Cleaning chrome parts, refer to the Caring for your vehicle brochure
 Cleaning light alloy wheels, refer to the Caring for your vehicle brochure
 Cleaning position, convertible top [44](#)
 Cleaning the vehicle, refer to the Caring for your vehicle brochure
 Cleaning windshield [77](#)
 Clock [82](#)
 12-/24-hour mode [82](#)
 setting, refer also to the Owner's Manual for Radio/Onboard Computer
 Closing
 from inside [32](#)
 from outside [29](#)
 Clutch
 breaking in [110](#)
 Cockpit [14](#)

Everything from A to Z

Code, refer to the Owner's Manual for Radio/Onboard Computer

Coin box [100](#)

Cold start, refer to Starting the engine [66](#)

Compact disc operation, refer to the Owner's Manual for Radio/Onboard Computer

Compression ratio, refer to Engine data [154](#)

Computer [83](#)

Condensation, refer to Air conditioning mode [96](#)

Configuring settings, refer to Vehicle Memory, Key Memory [64](#)

Connecting a vacuum cleaner, refer to Power socket [101](#)

Consumption, refer to Average fuel consumption [84](#)

Control elements, refer to Cockpit [14](#)

Convenience operation from outside [31](#)
windows [29](#)

Convertible top [39](#)
cleaning position [44](#)
convenience operation [29, 31](#)

electrical malfunction [42](#)
emergency operation [42](#)
indicator lamps [41](#)
opening and closing [40](#)
remote control [29](#)

Coolant [128](#)
indicator lamp [19, 80](#)
level [128](#)
temperature gauge [80](#)

Coolant water, refer to Coolant [128](#)

Cooling, refer to Temperature [96](#)

Copyright [4](#)

Cornering Brake Control (CBC) [113](#)
warning lamp [19](#)

Cruise control [77](#)
indicator lamp [20](#)

Cup holders, see Beverage holders [100](#)

Curb weight, refer to Weights [156](#)

Cylinders, refer to Engine data [154](#)

D

Dashboard, refer to Cockpit [14](#)

Data
capacities [157](#)
dimensions [155](#)
engine [154](#)
technical [154](#)
weights [156](#)

Daytime driving lamps [90](#)

DBC Dynamic Brake Control [19, 113](#)

Deep water, refer to Driving through water [111](#)

Defrost position, refer to Defrosting windows [96](#)
Defrosting and demisting windows
automatic climate control [96](#)

Defrosting windows [96](#)

Defrosting windshield, refer to Defrosting windows [96](#)

Demisting windows
automatic climate control [96](#)

Differential
breaking in [110](#)

Digital clock [82](#)

Dimensions [155](#)

Dipstick, engine oil [126](#)

Displacement, refer to Engine data [154](#)

Display lighting, refer to Instrument lighting [91](#)

Displays, refer to Instrument cluster [16](#)

Disposal
oil [127](#)
vehicle battery [145](#)

Distance warning, refer to Park Distance Control (PDC) [85](#)

Door key [28](#)

Door lock [31](#)

Doors
emergency operation [31](#)
Draft-free ventilation [97](#)
Drivelogic [73](#)

Driving light, refer to Parking lamps/Low beams [90](#)

Driving notes [111](#)

Driving through water, deep water [111](#)

Dry air, refer to Air conditioning mode [96](#)

DSC Dynamic Stability Control [86](#)

indicator lamp [19, 86](#)

Dynamic Brake Control (DBC) [19, 113](#)

indicator lamp [19](#)

Dynamic Stability Control (DSC) [19](#), [86](#)

E

Easy entry, refer to Entering the rear [49](#)

Electric power windows [38](#)
power loss [39](#)

Electrical accessories, failure [145](#)

Electrical malfunction
door lock [31](#)
driver's door [31](#)
fuel filler door [24](#)
luggage compartment lid [33](#)

Electronic Stability Program (ESP), refer to Dynamic Stability Control (DSC) [86](#)

Emergency call [146](#)

Emergency operation
doors [31](#)
driver's door [31](#)
fuel filler door [24](#)
luggage compartment lid [33](#)

Emergency release
luggage compartment lid [34](#)

Engine
breaking in [110](#)
data [154](#)
electronics [19](#)
indicator lamp [19](#)
speed [79](#), [154](#)
starting [66](#)
switching off [68](#)

Engine compartment [124](#)
Engine coolant [128](#)
refilling [128](#)

Engine oil
adding [127](#)
additives, refer to Adding engine oil [127](#)
alternative oils [127](#)
capacity [157](#)
consumption [126](#)
dipstick [126](#)
indicator/warning lamp [19](#)
quality [127](#)
specified oils [127](#)
temperature gauge [79](#)
types [127](#)

Engine oil level [19](#)
check [126](#)
indicator/warning lamp [18](#)

Engine oil pressure
indicator/warning lamp [18](#)

Engine oil temperature [79](#)

Engine output, refer to
Engine data [154](#)

Engine speed [79](#), [154](#)

Entering the rear [49](#)

Equipment range, refer to the Service and Warranty Information Booklet for US models / Warranty and Service Guide Booklet for Canadian models

ESP Electronic Stability Program, refer to Dynamic Stability Control (DSC) [86](#)

Exterior mirrors [53](#)

Eyelet, towing [149](#)

F

False alarm, refer to
Avoiding unintentional alarms [37](#)

Fasten safety belts
indicator lamp [18](#)

Fastening the safety belts [50](#)

Fault displays [81](#)

Filling the windshield washer reservoir [157](#)

Filling with sealant
M Mobility system [143](#)

First aid, refer to First-aid kit [23](#)

First-aid kit [23](#)

Flat tire [141](#)

Flat Tire Monitor [87](#)
repairing [141](#)

Flat Tire Monitor [87](#)
activating/deactivating [88](#)
indicator lamp [18](#), [19](#), [88](#)

Floor panel, raising [35](#)

Fluid reservoir for washer systems [126](#)

Fog lamps
indicator/warning lamp [20](#)

Folding down convertible top compartment panel [35](#)

Follow me home lamps [90](#)

Footbrake, refer to Braking safely [111](#)

Front airbags [55](#)

Front fog lamps [92](#)
indicator/warning lamp [20](#)

Front seat adjustment [47](#)

Fuel
display [80](#)
specifications [25](#)
volume [157](#)

Fuel consumption
display [84](#)

Fuel display, refer to Fuel gauge [80](#)

Fuel filler door [24](#)
release following an electrical malfunction [24](#)

Fuel level indicator, refer to Fuel gauge [80](#)

Fuel mixture preparation [154](#)

Everything from A to Z

Fuel reserve indicator, refer to Fuel gauge [80](#)
Fuel tank capacity [157](#)
Fuses [145](#)

G

Gasoline consumption, refer to Average fuel consumption [84](#)
Gasoline, refer to Fuel specifications [25](#)
Gear indicator [71](#)
Gearbox
 manual transmission [69](#)
Gearbox malfunction
 sequential M gearbox with Drivelogic [74](#)
Gearbox, sequential [70](#)
Gearshift lever
 manual transmission [69](#)
 sequential M gearbox with Drivelogic [70](#)
General driving notes [111](#)
Glove compartment [99](#)
Gradient assistance [73](#)
Grills, refer to Ventilation [94](#)
Gross weight, refer to Weights [156](#)

H

Handbrake, refer to Parking brake [68](#)

Hands-free system [100](#)
Hardtop [113](#)
Hardtop preparation [113](#)
Hardtop, refer to the separate Owner's Manual [113](#)
Hazard warning flashers [14](#)
Hazard warning triangle [23](#)
Head restraints [48](#)
Headlamp cleaning system
 cleaning headlamps [77](#)
 washer fluid [126, 157](#)
Headlamp control, automatic [90](#)
Headlamp flasher [91](#)
 indicator lamp [21](#)
Headlamps
 bulb replacement [137](#)
 care, refer to the Caring for your vehicle brochure
 Heated mirrors [53](#)
 Heated rear window
 automatic climate control [97](#)
 Heated seats [52](#)
 Heating
 exterior mirrors [53](#)
 rear window [97](#)
 seats [52](#)
 Heating and ventilation [94](#)
 Heavy loads, refer to Cargo loading [105](#)

Height adjustment
 seats [47](#)
 steering wheel [54](#)
Height, refer to
 Dimensions [155](#)
High beams [75, 91](#)
 bulb replacement [137](#)
 headlamp flasher [91](#)
 indicator lamp [21](#)
Holder for beverages [100](#)
Hood release [123](#)
Horn [14](#)
Hydraulic brake assistant, refer to DBC [113](#)
Hydroplaning [111](#)

I

Ice warning [83](#)
Ignition [65](#)
Ignition key [28](#)
 positions [65](#)
Ignition lock [65](#)
Imprint [4](#)
Indicator lamps [18](#)

Indicator/warning lamp
 airbags [18](#)
 alarm system [37](#)
 brakes [18, 19](#)
 Check Gas Cap [19](#)
 convertible top [41](#)
 coolant [19, 80](#)
 DSC [19](#)
 Flat Tire Monitor [18, 19, 88](#)
 fog lamps [20](#)
 Please fasten safety belts [18](#)
 reserve [80](#)
 rollover protection system [19](#)
 Service Engine Soon [19](#)
 Individual air distribution [96](#)
 Individual settings, refer to Vehicle Memory, Key Memory [64](#)
 Inflation pressure monitoring, refer to Flat Tire Monitor [87](#)
 Inflation pressure, tires [116](#)
 INSPECTION [81](#)
 Instrument cluster [16](#)
 Instrument lighting [91](#)
 Instrument panel [14](#)
 Interface socket for onboard diagnostics (OBD) [132](#)
 event data recorders [132](#)

- Interior lamps [92](#)
 - remote control [30](#)
- Interior motion sensor [36, 37](#)
 - switching off [37](#)
- Interior rearview mirror
 - automatic dimming feature [53](#)
- Interior temperature adjusting [96](#)
- Intermittent mode, wipers [76](#)
- Interval display, service [81](#)
- J**
- Jump-starting [147](#)
- K**
- Key Memory [64](#)
- Keys [28](#)
 - with remote control [28](#)
- L**
- Lamp defect [137](#)
- Lamps
 - reading lamps [92](#)
- Lamps and bulbs [137](#)
- Lashing down loads, refer to
 - Cargo loading [104](#)
- Lashing eyelets, refer to
 - Securing cargo [106](#)
- Lashing fittings, refer to
 - Securing cargo [106](#)
- LATCH child-restraint mounting system [60](#)
- Leather care, refer to the
 - Caring for your vehicle brochure
- Leaving the vehicle [68](#)
- LEDs light-emitting diodes [140](#)
- Length, refer to
 - Dimensions [155](#)
- License plate lamp
 - bulb replacement [140](#)
- Light switch [90](#)
- Light-emitting diodes (LEDs) [140](#)
- Lighter [100](#)
- LIGHTS ON warning [90](#)
- Lights, refer to Parking lamps/Low beams [90](#)
- Load, determining the maximum [104](#)
- Load, refer to Cargo loading [104](#)
- Loading
 - vehicle [104](#)
- Load-securing devices [106](#)
- Lock buttons on doors, refer to Locking [32](#)
- Lock, steering wheel [65](#)
- Locking
 - from inside [32](#)
 - from outside [29, 31](#)
- Locking and unlocking doors
 - from inside [32](#)
 - from outside [29, 31](#)
- Low beams [90](#)
 - automatic [90](#)
 - bulb replacement [137](#)
 - indicator lamp, defective lamp [81](#)
- Luggage compartment [35](#)
 - capacity [156](#)
 - emergency operation, refer to Manual operation [33](#)
 - floor panel [35](#)
 - increase volume [35](#)
 - lid [33](#)
 - lighting [33](#)
 - opening from outside [33](#)
 - opening, remote control [30](#)
 - opening/closing, refer to Luggage compartment lid [33](#)
 - remote control [30](#)
 - securing separately [33](#)
 - volume [156](#)
- Luggage compartment lid [33](#)
 - emergency operation [33](#)
 - emergency release [34](#)
 - indicator lamp [81](#)
 - opening from inside the vehicle [33](#)
 - opening from outside [33](#)
 - remote control [30](#)
 - unlocking manually [33](#)
- Luggage rack, refer to Roof-mounted luggage rack [107](#)
- Lumbar support [48](#)
- M**
- M Engine dynamics control [89](#)
- M Mobility system [141](#)
- Maintenance [81, 130](#)
- Maintenance system [130](#)
- Malfunction
 - convertible top [42](#)
 - door lock [31](#)
 - fuel filler door [24](#)
- Malfunction displays [81](#)
- Manual operation
 - convertible top [42](#)
 - door lock [31](#)
 - driver's door [31](#)
 - fuel filler door [24](#)
 - luggage compartment lid [33](#)
 - power convertible top [42](#)

Everything from A to Z

Manual transmission [69](#)

Master keys
with remote control [28](#)

MC operation, refer to the
Owner's Manual for
Radio/Onboard Computer

MD operation, refer to the
Owner's Manual for
Radio/Onboard Computer

Memory, refer to Seat and
mirror memory [51](#)

Memory, refer to Vehicle
Memory, Key Memory [64](#)

Microfilter
automatic climate
control [98](#)

Microphone [100](#)

Mini disc operation, refer to
the Owner's Manual for
Radio/Onboard Computer

Mirrors [53](#)
automatic curb monitor [52](#)
heated [53](#)

memory, refer to Seat and
mirror memory [51](#)

Mobile Service [147](#)

Modifications, technical,
refer to For your own
safety [6](#)

Multifunction steering
wheel [22](#)

Multifunction switch
turn signal indicator/head-
lamp flasher [75](#)
washer/wiper system [76](#)

N

Navigation system, refer to
the Owner's Manual for
Radio/Onboard Computer

Neck restraints, refer to
Head restraints [48](#)

Nets [99](#)

Nozzles, refer to
Ventilation [94](#)

Nylon rope, refer to Towing
and tow-starting the vehi-
cle [149](#)

O

OBD interface socket [132](#)
Odometer [79](#)

Oil
additives, refer to Adding
engine oil [127](#)
alternative oils [127](#)
capacity [157](#)
dipstick [126](#)
quality [127](#)
specified engine oils [127](#)

Oil change interval, refer to
Service interval
display [130](#)

Oil change intervals, refer to
the Service and Warranty
Information Booklet for US
models / Warranty and
Service Guide Booklet for
Canadian models

Oil filter change [157](#)

Oil level
checking [126](#)
indicator lamp [18](#)

Oil pressure
indicator lamp [18](#)

OIL SERVICE [81](#)

Oil temperature [79](#)

Oil types [127](#)

Old batteries, refer to Dis-
posal [145](#)

Onboard computer [83](#)

Onboard computer, refer
also to the Owner's Man-
ual for Onboard Computer

Onboard tool kit [136](#)

Opening and closing
from inside [32](#)
from outside [29](#)
via door lock [31](#)
via remote control [29](#)

Outlets, ventilation [94](#)

Outside temperature dis-
play [83](#)
changing unit of
measure [83](#)

P

Paintwork care, refer to the
Caring for your vehicle
brochure

Panic mode, trigger
alarm [30](#)

Park Distance Control
(PDC) [85](#)

Parking aid, refer to Park
Distance Control (PDC) [85](#)

Parking brake [68](#)
indicator lamp [18](#)

Parking lamps [90](#)
bulb replacement [137](#)

Parking lamps/Low
beams [90](#)

Parts and accessories, refer
to Your individual vehicle [5](#)

Passenger-side exterior mir-
ror tilt function [52](#)

PDC Park Distance
Control [85](#)

Placing a telephone call,
refer to the Owner's Man-
ual for the telephone

Plastic, refer to the Caring
for your vehicle brochure

Pollen, refer to Microfilter/
activated-charcoal filter [98](#)

Power loss
electric power windows [39](#)

Power output, refer to
 Engine data [154](#)
 Power seat [47](#)
 Power socket [101](#)
 Power socket, cigarette
 lighter [101](#)
 Power windows
 electric [38](#)
 Pressure monitoring, tires
 Flat Tire Monitor [87](#)
 Pressure, tires [116](#)
 inflating with M Mobility
 system [143](#)
 Proposition 65 warning [6](#)
 Protective function
 electric power windows [38](#)
 Puncture
 M Mobility system [141](#)

R

Radio remote control key,
 refer to Master key with
 remote control [28](#)
 Radio, refer to the Owner's
 Manual for Radio
 Rain sensor [76](#)
 Range [84](#)
 Reading lamps
 hardtop [113](#)
 rear [93](#)

Rear lamps
 bulb replacement [139](#)
 indicator lamp, defective
 lamp [81](#)
 Rear window heating
 automatic climate
 control [97](#)
 Rear-entry assist [49](#)
 Rearview mirror [53](#)
 Receiving assistance [146](#)
 Recirculated-air mode
 automatic climate
 control [97](#)
 Recirculating the air, refer to
 Recirculated-air mode [97](#)
 Reclining seat, refer to Seat
 adjustment [47](#)
 Refueling [24](#)
 fuel filler door [24](#)
 Releasing
 hood [123](#)
 Remaining distance to ser-
 vice [81](#)
 Remaining distance, refer to
 Range [84](#)
 Remote control [29](#)
 luggage compartment
 lid [30](#)
 malfunction [30](#)
 Replacement key [29](#)
 Replacing lamps, refer to
 Lamps and bulbs [137](#)

Reporting safety defects [7](#)
 Restraint systems
 for children [58](#)
 Restraint systems, refer to
 Safety belts [50](#)
 Reverse gear
 manual transmission [69](#)
 Rollover protection
 system [62](#)
 indicator lamp [19](#)
 lowering [62](#)
 Roof load capacity [156](#)
 Roof-mounted luggage
 rack [107](#)
 Rope, refer to Towing and
 tow-starting the
 vehicle [149](#)

S

Safe seating position [46](#)
 airbags [46](#)
 safety belt [46](#)
 Safety belt
 safe seating position [46](#)
 Safety belt height adjust-
 ment [50](#)
 Safety belts [50](#)
 height adjustment [50](#)
 seat-integrated safety belt
 system [49](#)
 warning lamp [18](#)

Safety systems, refer to
 Antilock Brake
 System [113](#)
 Dynamic Stability Control
 (DSC) [86](#)
 Screwdriver, refer to
 Onboard tool kit [136](#)
 Seat adjustment [47](#)
 BMW sports seat [47](#)
 lumbar support [47, 48](#)
 power seats [47](#)
 Seat belt tensioner, refer to
 Safety belts [50](#)
 Seat heating [52](#)
 Seat memory, refer to Seat
 and mirror memory [51](#)
 Seat positions, storing [51](#)
 Seats [47](#)
 Securing cargo [106](#)
 Securing child-restraint sys-
 tem [60](#)
 Securing the vehicle
 from inside [32](#)
 from outside [29, 31](#)
 Selector lever
 sequential M gearbox with
 Drivelogic [70](#)
 Selector lever positions
 sequential M gearbox with
 Drivelogic [70](#)

Everything from A to Z

- Sequential M gearbox with Drivelogic [70](#)
 - indicator lamp [19, 74](#)
 - tow-starting [150](#)
- Service and Warranty Information Booklet [130](#)
- Service Engine Soon warning lamp [19](#)
- Service interval display [81, 130](#)
- Shift lights [74](#)
- Shift paddles [71](#)
- Side airbags [55](#)
- Side turn signal indicators
 - bulb replacement [138](#)
- Size [155](#)
- Ski bag [102](#)
- Slipstream deflector, refer to
 - Wind deflector [44](#)
- SMG Drivelogic [70](#)
- Smokers' package, refer to
 - Ashtray [100](#)
- Snow chains [122](#)
- SOS, refer to Emergency call [146](#)
- Spare key [28](#)
- Special oils [127](#)
- Special oils, refer to Specified engine oils [127](#)
- Specified engine oils [127](#)
- Specified oils [127](#)
- Speed gauge, refer to
 - Speedometer [16](#)
- Speedometer [16](#)
- Sport mode [89](#)
- Sports seat [47](#)
- Stability control, refer to
 - Dynamic Stability Control (DSC) [86](#)
- Standing lamps [91](#)
 - bulb replacement [137](#)
- Starting difficulties
 - jump-starting [147](#)
 - temperature [66](#)
- Starting the engine [66](#)
- Starting, refer to Starting the engine [66](#)
- Starting-off assistance
 - DSC [86](#)
 - gradient assistance [73](#)
- Status of the Owner's Manual [5](#)
- Steering wheel lock [65](#)
- Steering wheel, adjusting [54](#)
- Storage compartments [99](#)
- Storage nets [99](#)
- Storing seat positions, refer to Seat and mirror memory [51](#)
- Storing tires [121](#)
- Stroke, refer to Engine data [154](#)
- Surface ice, refer to Ice warning [83](#)
- Switches, refer to
 - Cockpit [14](#)
- Switching off
 - engine [68](#)
- Symbols [4](#)
- T**
- Tachometer [79](#)
- Tail lamps
 - bulb replacement [139](#)
- Tail lamps, refer to Rear lamps [139](#)
- Tank capacity, refer to Fuel tank capacity [157](#)
- Tank indicator, refer to Fuel gauge [80](#)
- Technical data [154](#)
- Technical modifications [6](#)
- Technical modifications, refer to For your own safety [6](#)
- Telephone hookup
 - microphone [100](#)
- Telephone, refer to the separate Owner's Manual
- Television, refer to the Owner's Manual for Onboard Computer
- Temperature
 - automatic climate control [96](#)
- Temperature adjustment [96](#)
- Temperature display
 - engine coolant [80](#)
 - ice warning [83](#)
 - outside temperature [83](#)
 - setting units [83](#)
- Temperature layering [97](#)
- Tempomat, refer to Cruise control [77](#)
- Thigh support area, adjusting [47](#)
- Third brake lamp, refer to
 - Center high-mount brake lamp [140](#)
- Threaded socket for towing eyelet [149](#)
- Three-point safety belt [50](#)
- Tilt alarm sensor [37](#)
 - switching off [37](#)
- Tilting passenger-side exterior mirror [52](#)
- Time [82](#)
- Tire inflation pressure [116](#)
- Tire pressure monitoring, refer to Flat Tire Monitor [87](#)

Tires

- age [118](#)
 - breaking in [110](#)
 - condition [119](#)
 - damage [119](#)
 - flat [141](#)
 - inflation pressure [116](#)
 - storing [121](#)
 - tread [119](#), [120](#)
 - tread wear indicators, refer to Tire tread [120](#)
 - winter tires [120](#)
- Tools, refer to Onboard tool kit [136](#)
- Torque
- engine [154](#)
- Tow bar [149](#)
- Tow rope [149](#)
- Towing [149](#)
- Towing eyelet [149](#)
- Towing the vehicle [149](#)
- Tow-starting [149](#)
- Track width, refer to Dimensions [155](#)
- Transmission
- breaking in [110](#)
- Transport securing devices, refer to Securing cargo [106](#)
- Transporting children safely [58](#)

Trap protection

- electric power windows [38](#)
- Tread depth, refer to Tire tread [120](#)
- Tread wear indicators in the tires, refer to Tire tread [120](#)
- Tread wear, tires [120](#)
- Trip distance recorder, refer to Trip odometer [79](#)
- Trip meter, refer to Trip odometer [79](#)
- Trip odometer [79](#)
- Trunk lid, refer to Luggage compartment lid [33](#)
- Trunk lighting, refer to Luggage compartment lighting [33](#)
- Turn signal indicator [75](#)
- bulb replacement [138](#)
 - indicator lamp [20](#)
- Turn signal indicator, side bulb replacement [138](#)
- Turning circle, refer to Dimensions [155](#)
- TV function, refer to the Owner's Manual for Onboard Computer

U

- Underbody protection, refer to the Caring for your vehicle brochure
- Units
- average fuel consumption [84](#)
 - temperature [83](#)
- Unlocking
- from inside [32](#)
 - from outside [29](#), [31](#)
- Upshift indicator, refer to Shift Lights [74](#)
- Using antifreeze [128](#)

V

- Vehicle
- battery [144](#)
 - break-in procedures [110](#)
 - dimensions [155](#)
 - leaving the vehicle [68](#)
 - loading [104](#)
 - starting [66](#)
 - washing, refer to the Caring for your vehicle brochure [76](#)
 - weight [156](#)
- Vehicle Memory [64](#)
- Vehicle weight [156](#)
- Ventilation [94](#)
- draft-free [97](#)
- Viscosity [127](#)

- Voice command system [22](#)
- microphone [100](#)
- Voice control, refer to separate Owner's Manual
- Volume
- luggage compartment [156](#)

W

- Warning and indicator lamps [18](#)
- Warning lamp 'Please fasten safety belts' [18](#)
- Warning messages [81](#)
- Warranty and Service Guide Booklet [130](#)
- Warranty, refer also to separate booklet [7](#)
- Washer fluid
- adding [126](#), [157](#)
- Washer fluid reservoir [126](#)
- volume [126](#)
- Washer jets, refer to Windshield washer jets [77](#)
- Washer/wiper system [76](#), [77](#)
- washer fluid [126](#)
- Waste tray, refer to Ashtray [100](#)
- Weights [156](#)
- Wheelbase, refer to Dimensions [155](#)
- Wheels and tires [116](#)
- Wheelslip control DSC [86](#)

Everything from A to Z

Width, refer to

Dimensions [155](#)

Wind deflector [44](#)

Window condensation
removing [96](#)

Windows

convenience operation

[29](#), [31](#)

remote control [29](#)

Windshield washer
nozzles [77](#)

Windshield washer reservoir
volume, see
Capacities [157](#)

Windshield wiper blades,
replacing [136](#)

Windshield wipers, refer to
Washer/wiper system [76](#)

Winter tires [120](#)
storing [121](#)

Wiper blades, replacing [136](#)

Work in the engine compart-
ment [123](#)

X

Xenon lamps

bulb replacement [137](#)

Refueling



To ensure that you always have convenient access to all essential information when you stop for fuel, we recommend that you take the time to fill out the adjoining chart by entering the data that apply to your vehicle. Consult the index for individual specifications.

Fuel

Designation	
-------------	--

Please enter your preferred fuel here.

Engine oil

Quality	
---------	--

The oil quantity between the two marks on the dipstick is approx. 1.4 US quarts/1.3 liters.

Tire inflation pressure

	Summer tires		Winter tires	
	front	rear	front	rear
Up to 2 persons				
4 persons plus luggage				

More about BMW

bmwusa.com



The Ultimate
Driving Machine

01 41 0 168 515 ue

Free Manuals Download Website

<http://myh66.com>

<http://usermanuals.us>

<http://www.somanuals.com>

<http://www.4manuals.cc>

<http://www.manual-lib.com>

<http://www.404manual.com>

<http://www.luxmanual.com>

<http://aubethermostatmanual.com>

Golf course search by state

<http://golfingnear.com>

Email search by domain

<http://emailbydomain.com>

Auto manuals search

<http://auto.somanuals.com>

TV manuals search

<http://tv.somanuals.com>