

Owner's Manual
for Vehicle



325Ci
330Ci

Congratulations, and thank you for choosing a BMW.

Thorough familiarity with your vehicle will provide you with enhanced control and security when you drive it. Therefore we have one request:

Please take the time to read this Owner's Manual and familiarize yourself with the information that we have compiled for you before starting off in your new BMW. The manual contains important data and instructions intended to assist you in obtaining maximum satisfaction from your BMW's unique array of advanced technical features. It also contains information on vehicle maintenance designed to enhance operating safety while simultaneously helping you to maintain your BMW's value throughout an extended service life. For additional information refer to the supplemental manuals.

This Owner's Manual should be considered a permanent part of this vehicle. It should stay with the vehicle when sold to provide the next owner with important operating, safety and maintenance information.

We wish you an enjoyable driving experience.

BMW AG

4 Notes

About this Owner's Manual

We have made every effort to ensure that you are able to find what you need in this Owner's Manual as quickly as possible. The fastest way to find specific topics is by using the detailed index at the end. If you wish to gain an initial overview of your vehicle, you will find this in the first chapter.

Should you wish to sell your BMW at some time in the future, please remember to hand over this Owner's Manual to the new owner; it is an important part of the vehicle.

Additional sources of information

If you have any additional questions, your BMW center will be glad to advise you.

You can find more information about BMW, for example on its technology, on the Internet at www.bmw.com.

Symbols used



Indicates precautions that must be followed precisely in order to avoid the possibility of personal injury and serious damage to the vehicle.



Contains information that will assist you in gaining the optimum benefit from your vehicle and enable you to care more effectively for your vehicle.



Refers to measures that can be taken to help protect the environment.

◀ Marks the end of a specific item of information.

* Indicates special equipment, country-specific equipment and optional extras when available.



Vehicle Memory, Key Memory, refer to page 70. Identifies functions that can be specifically adapted for a particular key or vehicle. These adjustments can be performed either by yourself or by your BMW center.

© 2003 Bayerische Motoren Werke
Aktiengesellschaft
Munich, Germany

Reprinting, including excerpts, only with the
written consent of BMW AG, Munich.

Order No. 01 41 0 157 599

US English VIII/03

Printed in Germany

Printed on environmentally friendly paper,
bleached without chlorine, suitable for recycling.

Notes

Your individual vehicle

On purchasing your BMW, you have decided in favor of a model with individualized equipment and features. This Owner's Manual describes all models and equipment that BMW offers within the same group.

We hope you will understand that equipment and features are included that you might not have chosen for your vehicle. You can easily identify any differences with the aid of the asterisk * used to identify all optional equipment and accessories.

If your BMW features equipment which is not described in this Owner's Manual, such as a car radio or telephone, supplementary Owner's Manuals are enclosed. We ask you to read these manuals as well.

Status at time of printing

BMW pursues a policy of continuous, ongoing development conceived to ensure that our vehicles continue to embody the highest quality and safety standards combined with advanced, state-of-the-art technology. For this reason, the features described in this Owner's Manual could differ from those in your vehicle. Nor can errors and omissions be entirely ruled out. You are therefore asked to appreciate that no claims can be recognized on the basis of the data, illustrations or descriptions in this Owner's Manual.

For your own safety

Fuels



Use unleaded gasoline only. Fuels containing up to and including 10% ethanol or other oxygenates with up to 2.8% oxygen by weight – that is, 15% MTBE or 3% methanol plus an equivalent amount of co-solvent – will not void the applicable warranties respecting defects in materials or workmanship. Field experience has indicated significant differences in fuel quality – volatility, composition, additives, etc. among gasolines offered for sale in the United States and Canada. The use of poor-quality fuels may result in driveability, starting and stalling problems, especially under certain environmental conditions, such as high ambient temperature and high altitude. Should you encounter driveability problems which you suspect could be related to the fuel you are using, we recommend that you respond by switching to a recognized high-quality brand. Failure to comply with these recommendations may result in unscheduled maintenance. Obey all applicable safety rules when handling gasoline. ◀

Maintenance and repair

 Advanced technology, e.g. the use of modern materials and high-performance electronics, requires specially adapted maintenance and repair methods. Therefore, only have corresponding work on your BMW carried out by a BMW center or a workshop that works according to BMW repair procedures with correspondingly trained personnel. If work is carried out improperly there is a danger of consequential damage and the related safety risks. ◀

Parts and accessories

 Important safety information! For your own safety, use genuine parts and accessories approved by BMW. When you purchase accessories tested and approved by BMW and Original BMW Parts, you simultaneously acquire the assurance that they have been thoroughly tested by BMW to ensure optimum performance when installed on your vehicle.

BMW warrants these parts to be free from defects in material and workmanship. BMW will not accept any liability for damage resulting from installation of parts and accessories not approved by BMW.

BMW cannot test every product on the market to determine whether it can be used on a BMW safely and without risk to either the vehicle, its operation, or its occupants.

Original BMW Parts, BMW Accessories and other products approved by BMW, together with professional advice on using these items, are available from all BMW centers.

Installation and operation of non-BMW approved accessories such as alarms, radios, amplifiers, radar detectors,

wheels, suspension components, brake dust shields, telephones – including operation of any portable cellular phone from within the vehicle without using an externally mounted antenna – or transceiver equipment, such as a CB, walkie-talkie, ham radio or similar accessories, may cause extensive damage to the vehicle, compromise its safety, interfere with the vehicle's electrical system or affect the validity of the BMW Limited Warranty. Contact your BMW center for additional information. Do not use key or remote control to lock doors or luggage compartment with anyone inside the vehicle. Refer to the Owner's Manual for more details. ◀

 Maintenance, replacement, or repair of the emission control devices and systems may be performed by any automotive repair establishment or individual using any certified automotive part. ◀

Symbol on vehicle parts

 Indicates that you should consult the relevant section of this Owner's Manual for information on a particular part or assembly.

Notes

Service and warranty

This manual is supplemented by a Service and Warranty Information Booklet for US models or a Warranty and Service Guide Booklet for Canadian models.

We recommend that you read this publication thoroughly.

Your BMW is covered by the following warranties:

- ▷ New Vehicle Limited Warranty
- ▷ Rust Perforation Limited Warranty
- ▷ Federal Emissions System Defect Warranty
- ▷ Federal Emissions Performance Warranty
- ▷ California Emission Control System Limited Warranty.

Detailed information about these warranties is listed in the Service and Warranty Information Booklet for US models or in the Warranty and Service Guide Booklet for Canadian models.

Reporting safety defects

The following only applies to vehicles owned and operated in the US.

If you believe that your vehicle has a defect which could cause a crash or could cause injury or death, you should immediately inform the National Highway Traffic Safety Administration NHTSA in addition to notifying BMW of North America, LLC, P.O. Box 1227, Westwood, New Jersey 07675-1227, telephone toll-free 1-800-831-1117.

If NHTSA receives similar complaints, it may open an investigation, and if it finds that a safety defect exists in a group of vehicles, it may order a recall and remedy campaign. However, NHTSA cannot become involved in individual problems between you, your dealer, or BMW of North America, LLC.

To contact NHTSA, you may either call the Auto Safety Hotline toll-free at 1-800-424-9393 or 366-0123 in the Washington, D.C. area, or write to: NHTSA, U.S. Department of Transportation, Washington, D.C. 20590. You can also obtain other information about motor vehicle safety from the Hotline.

Contents

Notes	About this Owner's Manual	4
	Additional sources of information	4
	Symbols used	4
	Your individual vehicle	5
	Status at time of printing	5
	For your own safety	5
	Symbol on vehicle parts	6
	Service and warranty	7
Reporting safety defects	7	

Overview	Cockpit	14
	Instrument cluster	16
	Indicator and warning lamps	18
	Buttons in steering wheel*	22
	Hazard warning triangle*	23
	First-aid kit*	23
	Refueling	24
	Fuel specifications	25
Tire inflation pressure	25	

Controls and features	Opening and closing:	
	Keys	30
	Central locking system	30
	Opening and closing – via the remote control	31
	Opening and closing – via the door lock	33
	Opening and closing – from the inside	34
	Luggage compartment lid	35
	Luggage compartment	37
	Alarm system*	38
	Electric power windows	40
	Manual convertible top	41
	Fully-automatic convertible top*	46
	Wind deflector*	50
	To adjust:	
	Safe seating position	52
	Seats	53
	Adjusting electric power seats	53
Lumbar support*	54	
Head restraints	54	
Entering the rear	55	
Safety belts	56	
Seat and mirror memory*	57	
Seat heating*	58	
Steering wheel	59	
Mirrors	59	

Contents

Controls and features	Passenger safety systems:	Everything under control:	Interior conveniences:
	Airbags 61	Odometer 86	Glove compartment 111
	Transporting children safely 64	Tachometer 86	Integrated universal remote control* 112
	Rollover protection system 68	Energy control 86	Storage compartments 114
	Vehicle Memory, Key Memory 70	Fuel gauge 87	Cellular phone* 115
	Driving:	Engine coolant temperature gauge 87	Ashtray, front* 115
	Ignition lock 71	Service interval display 88	Ashtray, rear* 116
	Starting the engine 71	Check Control 88	Loading and transporting:
	Switching off the engine 73	Clock 89	Ski bag* 117
	Parking brake 73	Computer 90	Cargo loading 118
Manual transmission 74	Technology for safety and driving convenience:	Roof-mounted luggage rack for the hardtop* 121	
Sequential manual gearbox SMG* 75	Park Distance Control (PDC)* 92		
Automatic transmission with Steptronic* 79	Dynamic Stability Control (DSC) 93		
Turn signal indicator/Headlamp flasher 82	Flat Tire Monitor* 94		
Washer/wiper system/Rain sensor* 83	Brake force display 96		
Cruise control* 84	Lamps:		
	Parking lamps/Low beams 97		
	Adaptive headlights* 98		
	Instrument lighting 98		
	High beams/Standing lamps 99		
	Fog lamps 99		
	Interior lamps 100		
	Controlling the climate for pleasant driving:		
	Air conditioning 102		
	Automatic climate control* 106		

Contents

Operation, maintenance

Special operating instructions:

- Break-in procedures [124](#)
- General driving notes [125](#)
- Antilock Brake System (ABS) [125](#)
- Brake system [126](#)
- Hardtop* [127](#)

Wheels and tires:

- Tire inflation pressure [129](#)
- Tire condition [129](#)
- Tire replacement [130](#)
- Wheel and tire combinations [132](#)
- Winter tires [132](#)

In the engine compartment:

- Hood [134](#)
- Engine compartment essentials [136](#)
- Washer fluid [138](#)
- Engine oil [138](#)
- Coolant [140](#)
- Brake fluid [141](#)

Maintenance:

- The BMW Maintenance System [142](#)

Laws and regulations:

- California Proposition 65 warning [143](#)
- OBD interface socket [143](#)

Owner service procedures

Replacement procedures:

- Onboard tool kit [148](#)
- Windshield wiper blades [148](#)
- Lamps and bulbs [149](#)
- Changing a wheel [153](#)
- Run Flat tires* [156](#)
- Battery [157](#)
- Fuses [157](#)

Giving and receiving assistance:

- Receiving assistance [158](#)
- Jump-starting [159](#)
- Towing the vehicle [160](#)

Technical data

- Engine data [166](#)
- Dimensions [167](#)
- Weights [168](#)
- Capacities [169](#)

Contents

Index

Everything from A to Z [172](#)

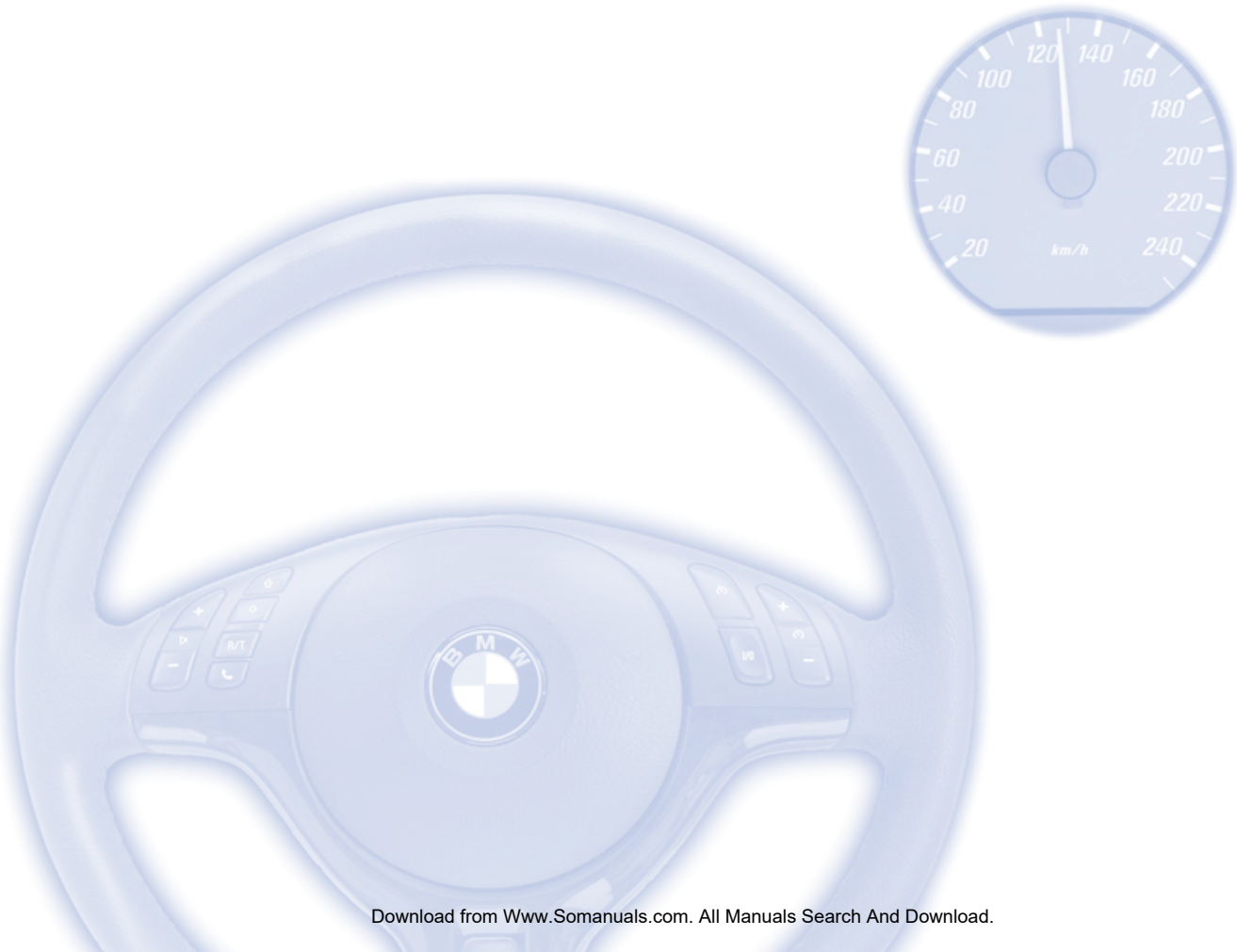

Overview

Controls and features

Operation, maintenance

Owner service procedures

Technical data

Index



Overview

Controls

Maintenance

Repairs

Data

Index

14 Cockpit

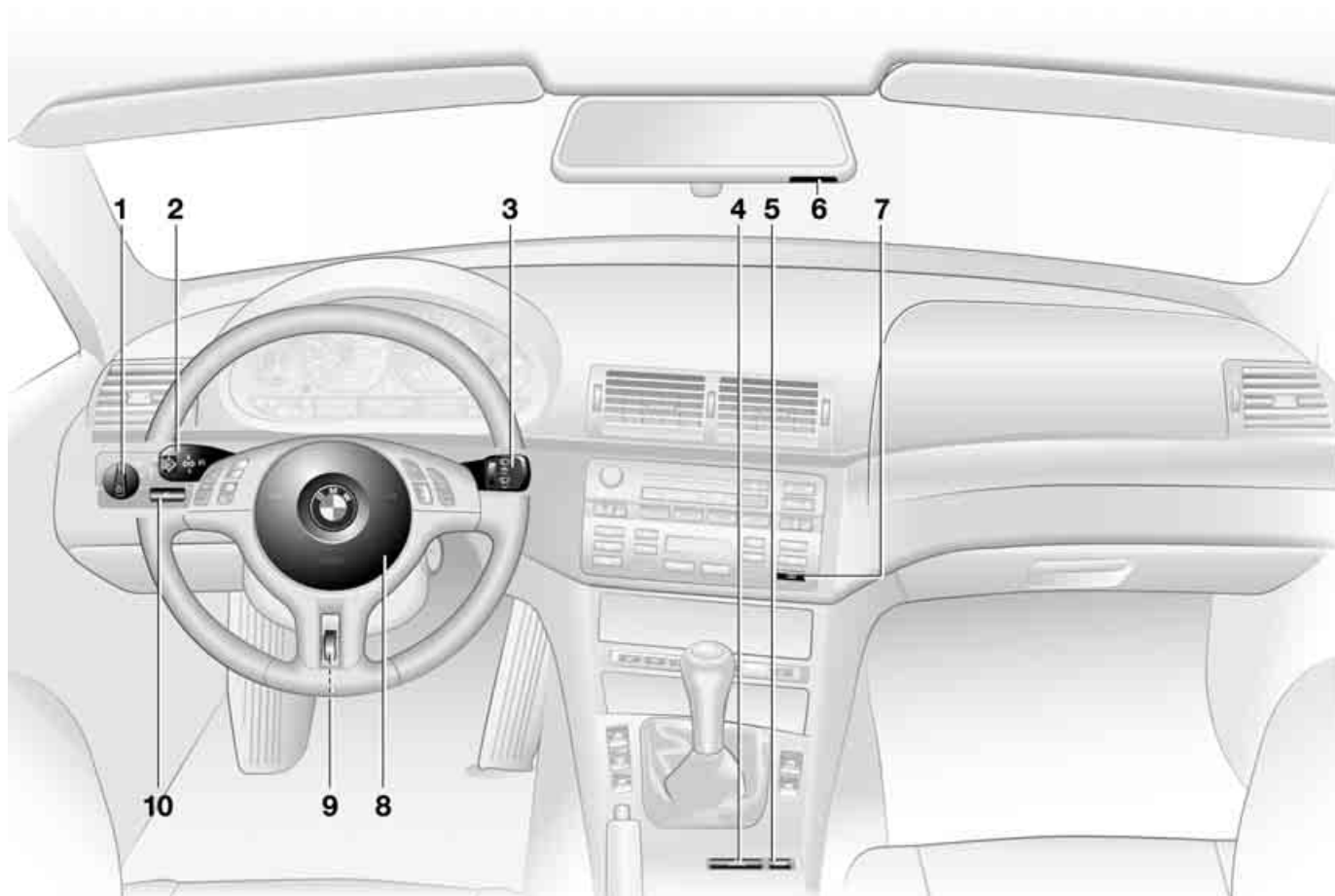

MV02086CMA

Cockpit

- 1 Parking lamps/Low beams 97
- 2 ▷ Turn signal indicators 82
 - ▷ Standing lamps 99
 - ▷ High beams 99
 - ▷ Headlamp flasher 82
 - ▷ Computer 90
- 3 Washer/wiper system/Rain sensor 83
- 4 Hazard warning flashers
- 5 Central locking system 30
- 6 ▷ Initiating an emergency call 158
 - ▷ Mobile Service 158
- 7 Rear window defroster 104, 109
- 8 Horn: the entire surface
- 9 Adjusting the steering wheel 59
- 10 Fog lamps 99

16 Instrument cluster



Instrument cluster

- 1 Fuel gauge 87
- 2 Indicator lamp for turn signals 20
- 3 Speedometer
- 4 Indicator and warning lamps 18 to 21
- 5 Tachometer and Energy Control 86
- 6 Engine coolant temperature gauge 87
- 7 Indicator and warning lamps 18 to 21
- 8 Control button for
 - ▷ Clock 89
 - ▷ Units of measure for exterior temperature display 90
- 9 Selector lever and program display for automatic transmission/sequential manual gearbox SMG 19, 75, 81
- 10 Display for
 - ▷ Trip odometer/Odometer 86
 - ▷ Clock 89
 - ▷ Service interval 88
 - ▷ Computer 90
- 11 Check Control 88
- 12 Trip odometer, reset to zero 86
- 13 Indicator and warning lamps 18 to 21

18 Indicator and warning lamps

Technology that monitors itself

Indicator and warning lamps that are identified by ● are tested for proper functioning whenever the ignition key is turned. They each light up once for different periods of time.

If a fault should occur in one of these systems, the corresponding lamp does not go out after the engine is started, or it lights up while the vehicle is moving. You will see how to react in the following section.

Red: stop immediately



Battery charge current ●
The battery is no longer being charged. Indicates a defective alternator drive belt or a problem with the alternator's charge circuit. Please contact the nearest BMW center.



If the drive belt is defective, stop and switch off the engine immediately to prevent overheating and serious engine damage. If the drive belt is defective, increased steering effort is also required. ◀



Engine oil pressure ●
Stop the vehicle immediately and switch off the engine. Check the engine oil level; top off as required. If the oil level is correct: please contact the nearest BMW center.



Do not continue driving, as the engine could sustain serious damage from inadequate lubrication. ◀



Flat Tire Monitor ●
In addition, an acoustic signal is sounded: there is a flat tire. Reduce speed and carefully come to a stop. Avoid sudden braking and steering maneuvers.

For additional information: refer to page 94



Brake warning lamp ●
If the lamp comes on when the parking brake is not engaged: check the brake fluid level. Before driving further, be sure to comply with the instructions on pages 126 and 141.



Brake warning lamp for Canadian models.

Red: an important reminder



Brake warning lamp
Comes on when the parking brake is engaged – an additional acoustic signal sounds when you start off.

For additional information: refer to page 73



Brake warning lamp for Canadian models.



Lock backrest/Fasten safety belts ●
Comes on together with an acoustic signal until the safety belts are fastened. Flashes if the backrest is not locked.

For additional information on locking the seat backrests, refer to page 55

For additional information on safety belts: refer to page 56



Airbags ●
Please have the system inspected at your BMW center.

For additional information: refer to page 61

Indicator and warning lamps

Red and yellow: continue driving cautiously

BRAKE The brake warning lamp comes on together with the yellow indicator lamps for ABS ● and DSC:

ABS The entire ABS, CBC and DSC control system has failed. Continue driving cautiously and defensively. Avoid full brake applications. Please have the system checked by your BMW center as soon as possible.

Additional information beginning on page [93](#)

 CBC, ABS and DSC and DBC indicator and warning lamps for Canadian models.



Orange: consult the nearest BMW center



Automatic transmission/sequential manual gearbox

The respective transmission has responded to a malfunction by reverting to operation in its emergency default program. Please consult the nearest BMW center.

For additional information: refer to page [77, 79](#)

Yellow: check as soon as possible



Engine oil level

If the lamp comes on during normal vehicle operation: the engine oil level has fallen to the absolute minimum; refill as soon as possible. Do not drive more than approx. 30 miles/50 km before refilling.

For additional information: refer to page [138](#)



Engine oil level

Comes on after the engine has been switched off: add engine oil at the earliest opportunity, such as the next time you stop to refuel.

For additional information: refer to page [138](#)



Brake pads ●

Have the brake pads checked. For additional information: refer to page [126](#)



Flat Tire Monitor ●

The Flat Tire Monitor is malfunctioning or out of order. Have the system checked by your BMW center. For additional information, refer to page [94](#)



Dynamic Stability Control (DSC) ●

Indicator lamp flashes:

The system is actively regulating drive torque and braking force. The indicator lamp stays lit: DSC has been switched off with the button; DTC is operational. Please contact a BMW center in case of a malfunction.

Additional information beginning on page [93](#)



Dynamic Stability Control (DSC) and brake warning lamp ●

The indicator lamps remain on: DSC/DTC have been switched off with the button or are faulty. Please consult the nearest BMW center.

Additional information beginning on page [93](#)



20 Indicator and warning lamps



DSC indicator and brake warning lamps for Canadian models.



Dynamic Brake Control (DBC) ●
Malfunction in DBC system. Conventional braking efficiency is available and unrestricted.

Have the system repaired at your BMW center as soon as possible. For additional information: refer to page 125



Dynamic Brake Control (DBC) warning lamp for Canadian models.



Add washer fluid
The washer fluid is too low. Top off the fluid at the earliest

opportunity. For additional information: refer to page 138



SERVICE ENGINE SOON ●
If the indicator lamp comes on either continuously or intermittently, this indicates a fault in the emissions-related electronic systems.

Although the vehicle remains operational, you should have the systems checked by your BMW center at the earliest possible opportunity. For additional information: refer to page 143



Service Engine Soon indicator lamp for Canadian models.



Engine electronics ●
There is a fault in the electronic engine-management system. You can continue to drive with reduced engine output or engine speed. Please have the system inspected at your BMW center.



Add coolant
The coolant level is too low. Add coolant at the earliest opportunity.

For additional information: refer to page 140



CHECK GAS CAP* ●
This indicator lamp comes on when the gas cap is loose or missing.

Close the gas cap tightly: refer to page 24



Rollover protection system ●
The rollover protection system has been deactivated due to a malfunction. Please have the system inspected by your BMW center at the earliest opportunity.

For additional information: refer to page 68

Green: for your information



Turn signal indicator
Flashes when the turn signal is operated.

Rapid flashing indicates a system malfunction.

For additional information: refer to page 82



Cruise control
Lights up when the cruise control is activated: ready for operation via the buttons in the steering wheel.

For additional information: refer to page 84



Front fog lamps
Lights up whenever you switch on the fog lamps.

For additional information: refer to page 99

Indicator and warning lamps

Blue: for your information



High beams

Comes on when the high beams are on or the headlamp flasher

is actuated.

For additional information: refer to pages [82](#), [99](#)

22 Buttons in steering wheel*

These buttons let you operate the following functions quickly and without being distracted from traffic conditions:

- ▷ Selected radio functions
- ▷ The cruise control
- ▷ Selected telephone functions.

 The controls are active only when the corresponding systems and accessories are switched on. ◀



Press briefly:

Receive a phone call, initiate dialing, terminate a call.



Switch between phone, radio, cassette and CD.



Forward:

- ▷ Radio
Press briefly: next station in station memory
Extended pressure: station search

- ▷ CD
Press briefly: jump to next track
Extended pressure: search function in track
- ▷ Cassette
Press briefly: jump to next track or stop fast forward
Extended pressure: fast forward
- ▷ Phone
Scan personal phone book.



Rewind/reverse: same functions as forward.



Volume.



Cruise control: select a stored setting.



Cruise control: store and accelerate + or decelerate and store -.



Cruise control: activate/interrupt/deactivate.

Hazard warning triangle*



The hazard warning triangle is stored in the luggage compartment lid inside the container for the onboard tools.

To open the container, loosen the wing nut.

 Always observe all legal regulations requiring a warning triangle to be carried in the vehicle. ◀

First-aid kit*

23





The first-aid kit is located under the passenger seat.

To open: pull the handle and fold the cover down.

To close: fold the cover up and press it until the tab engages.

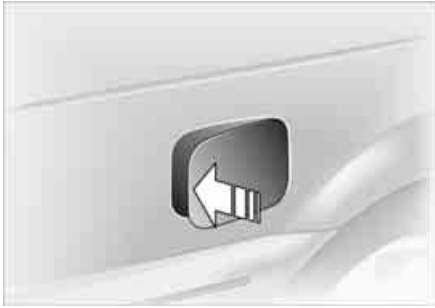
 Some of the articles in the first-aid kit have a limited period of use before expiration. For this reason, check the expiration dates of each of the items regularly and replace any whose expiration dates have passed. You can purchase replacements in any drugstore or pharmacy. Always observe all legal regulations requiring a first-aid kit to be carried in the vehicle. ◀



 Always observe all safety precautions posted at the service station when handling fuel. Never carry spare fuel containers in your vehicle. Whether empty or full, these containers can leak, cause an explosion, or lead to fire in the event of a collision. ◀

Fuel filler door

 Always switch off the engine before refueling, as it is not possible to add fuel with the engine running, and attempts may also trigger the SERVICE ENGINE SOON lamp. ◀

Press on the rear edge of the fuel filler door to open and close it.

Pull the knob with the fuel pump symbol, located on the right side wall of the luggage compartment.

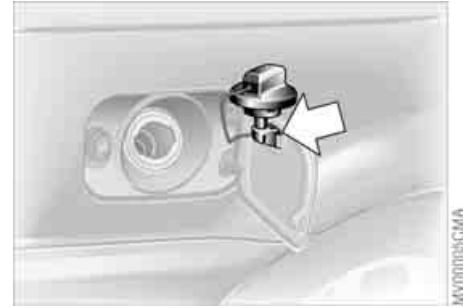

Simple and environmentally friendly

 Open the gas cap carefully to prevent fuel from spraying out. Fuel spray may cause injury. ◀

Keep the gas cap in the bracket attached to the fuel filler door.

When refueling, insert the filler nozzle completely into the filler pipe. Lifting the nozzle during refueling

- ▷ results in premature pump shutoff
- ▷ and will reduce the effectiveness of the vapor recovery system on the pump.

The fuel tank is full when the filler nozzle shuts off the first time.

Refueling

 Close the gas cap carefully after refueling until a click is heard. While closing, be sure not to squeeze the strap which is fastened to the cap. A loose or missing cap will activate the CHECK GAS CAP* lamp. ◀

Fuel tank capacity

▷ Approx. 16.6 gal./63 liters, of which
▷ approx. 2.1 gal./8 liters are reserve capacity.

 Do not drive to the last drop of fuel. This can prevent the engine from operating properly and result in damage. ◀

Fuel specifications

The engine uses lead-free gasoline only.

Required fuel:

▷ Premium Unleaded Gasoline, min. 91 AKI.
AKI = Anti Knock Index

 Never use leaded fuel, as it would cause permanent and irreversible damage to the oxygen sensor and the catalytic converter. ◀

Tire inflation pressure

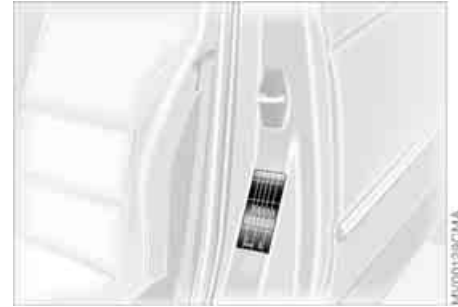

Checking tire pressures

Tire pressures in psi/kilopascal are shown on the driver's door post and are visible when the door is open.

Only check the tire inflation pressures of cold tires. This means after driving a maximum of 1.25 miles/2 km or after the vehicle has been parked for at least 2 hours. Warm tires have higher inflation pressures.

In the following tire inflation pressure table, all pressures are specified in the standard units of pressure, psi and kilopascal, and apply to cold tires, i.e. tires at ambient temperature.

26 **Tire inflation pressure**

Vehicles with Flat Tire Monitor:

After correcting the inflation pressures, reinitialize the system. Refer to page 94.



Check the tire pressures on a regular basis – at least twice a month – and before every extended journey. If this is not done, incorrect tire pressures can cause driving instability and tire damage, ultimately resulting in accidents.

Remember to check the inflation pressure in the space-saver or standard spare tire.

Inflate the spare tire to the highest inflation pressure specified for your vehicle. ◀

Comply with tire approval specifications

The inflation pressures in the table apply to BMW approved tire sizes and tire manufacturers. Your BMW center can provide you with more information about these. Other pressures may be required for tires made by other manufacturers.

Your vehicle is equipped with tires that not only meet US standards, but also European standards. We recommend the exclusive use of BMW approved tires.

Tire inflation pressure

BMW	Tires All pressure specifications in the table are indicated in psi/kilopascal with cold tires – cold = ambient temperature				
325Ci	205/55 R 16 91 H M+S 205/55 R 16 91 H 225/50 R 16 92 W 225/45 R 17 91 W	29/200	33/230	36/250	44/300
	225/45 ZR 17 245/40 ZR 17	29/200	–	36/250	–
	205/50 R 17 93 V M+S extra load 205/50 R 17 93 W extra load 205/55 R 16 91 Q M+S 225/50 R 16 92 Q M+S 205/50 R 17 93 Q M+S extra load 225/45 R 17 91 Q M+S	32/220	36/250	39/270	46/320
330Ci	225/45 R 17 91 W 225/45 ZR 17 245/40 ZR 17 225/40 ZR 18 255/35 ZR 18	32/220	36/250	39/270	46/320
	205/50 R 17 93 V M+S extra load 205/50 R 17 93 W extra load 205/50 R 17 93 Q M+S extra load 225/45 R 17 91 Q M+S	32/220	36/250	39/270	46/320
All	Space-saver spare tire	61/420			



Overview

Controls and features

Operation, maintenance

Owner service procedures

Technical data

Index

Overview

Controls

Maintenance

Repairs

Data

Index

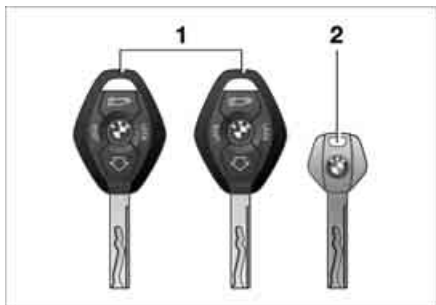

The key set

1 Master keys with remote control unit – these keys determine the functions of the Key Memory. Refer to page 70. You can mark the individual keys for subsequent identification by applying the colored decals that you received when accepting delivery of your vehicle

▷ In every master key with the remote control feature there is an extended-life battery that is charged automatically in the ignition lock as you drive.

For this reason, if you have master keys with the remote control feature that are not being used otherwise, use those keys at least once a year while driving for an extended period to charge the battery. ◀

2 Spare key – for storage in a safe place, such as in your wallet. This key is not intended for constant use. The luggage compartment lid and the glove compartment cannot be locked and unlocked with this key. This is useful for valet parking, for example

Central locking system

The concept

The central locking system engages and releases the following locks at the same time:

- ▷ doors
- ▷ luggage compartment lid
- ▷ fuel filler door
- ▷ glove compartment.

The central locking system is ready for operation whenever the driver's door is closed.

The central locking system can be operated

- ▷ from outside via the door lock as well as via the remote control
- ▷ from inside by pressing a button.

The fuel filler door is not locked when the central locking system is activated from the inside, refer to page 34.

When the system is actuated from the outside, the anti-theft system is also activated. This prevents the doors from being unlocked via the lock buttons or the release handle. The alarm system is also activated or deactivated.

The central locking system is automatically deactivated in the event of an accident. In addition, the hazard warning flashers and interior lamps come on.

Opening and closing – via the remote control

The concept

The remote control also provides two additional functions beyond the central locking feature:

- ▷ To switch on interior lamps, refer to page 32.
With this function you can also search for the vehicle when parked in an underground garage, for instance
- ▷ To open the luggage compartment lid, refer to page 32.
The luggage compartment lid will open slightly, regardless of whether it was previously locked or unlocked.

Whenever you unlock or lock the vehicle, you simultaneously deactivate/activate the anti-theft system, disarm/arm the alarm system and switch the interior lamps on/off.



You can have a signal set to confirm that the vehicle's locks have engaged securely. ◀

Master keys with remote control



Persons or animals inside the vehicle may be able to lock the doors from the inside. For this reason, you should always take the vehicle keys with you so that the vehicle can be opened again from the outside at any time. ◀



If it is no longer possible to lock the vehicle via the remote control, the battery is discharged. Use this key while driving for an extended period in order to recharge the battery. To prevent unauthorized use of the remote control, surrender only the spare key when leaving the vehicle for valet parking, for example. In the event of a system malfunction, please contact your BMW center. You can also obtain replacement keys there. ◀



- 1 Unlock, convenience opening mode, and disarm alarm system
- 2 Lock and secure, arm alarm system, activate interior lamps, disarm tilt alarm sensor and interior motion sensor
- 3 Open the luggage compartment lid, Panic mode – trigger alarm

To release



Press the button once to unlock the driver's door.



Press the button a second time to disengage all vehicle locks. ◀

32 Opening and closing – via the remote control

Convenience opening mode*

Press and hold button. The electric power windows and the fully-automatic convertible top open.

To lock and secure



Press the button.

To switch on the interior lamps



With the vehicle locked, press the button.

To deactivate the tilt alarm* and interior motion sensors*



Press the button a second time immediately after locking.

For additional information, refer to page 39.

To open the luggage compartment lid



Press the button.

The luggage compartment lid will open slightly, regardless of whether it was previously locked or unlocked.

 If the luggage compartment lid was locked, it will be locked again after it is reclosed.

Before and after a trip, be sure that the luggage compartment lid has not been opened unintentionally. ◀

Panic mode – trigger alarm



Provided that the alarm system is armed, you can respond to imminent danger by holding down the button for more than seconds.

To switch off the alarm:



Press the button.

External systems

The remote control system's operation may be affected by other units or equipment operating in the immediate vicinity of your vehicle.

If this should occur, you can still open and close the vehicle using the master key in either the door or luggage compartment lid locks.

For US owners only

The transmitter and receiver units comply with part 15 of the FCC Federal Communications Commission regulations. Operation is governed by the following:

FCC ID:

- ▷ LX8EWS
- ▷ LX8FZVS
- ▷ LX8FZVE.

Compliance statement:

This device complies with part 15 of the FCC Rules. Operation is subject to the following two conditions:

- ▷ This device may not cause harmful interference
- ▷ This device must accept any interference received, including interference that may cause undesired operation.

 Any unauthorized modifications to these devices could void the user's authority to operate the equipment. ◀

Opening and closing – via the door lock

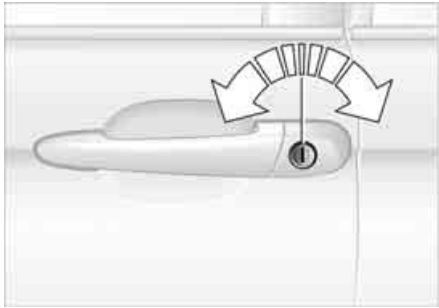

Whenever closing the windows or sliding/tilt sunroof you should always monitor their path and progress to ensure that no one is injured. Releasing the key stops the operation. ◀

Manual operation

In the event of electrical malfunction
Turn the key all the way to the left or right to unlock or lock the driver's door.

One turn of the key in the driver's door lock unlocks the driver's door, the fuel filler door and the glove compartment. Turning the key a second time unlocks the passenger-side door and the luggage compartment lid.



You can have a signal set to confirm that the vehicle's locks have engaged securely. ◀

Convenience operation

You can also operate the power windows and the fully-automatic convertible top via the door lock.

- ▷ To open: with the door closed, hold the key in the Unlock position
- ▷ To close: with the door closed, hold the key in the Lock position.

34 Opening and closing – from the inside



You can use this button to control the central locking system whenever the doors are closed. The doors and luggage compartment lid are unlocked or locked only. The anti-theft system is not activated.

 If only the driver's door was unlocked from the outside and you press the button, then, with the driver's door still open, the passenger-side door, the luggage compartment lid, the fuel filler door and the glove compartment will unlock, too. If the driver's door is closed, it will be locked. ◀



If you desire, the central locking system can be activated automatically as soon as you begin to drive. This can be adjusted to be key-specific. ◀

To unlock and open the doors

1. Press the button for the central locking system
2. Pull the release handle above the armrest on the door you wish to open

or

pull the release handle for any door twice: to unlock and open the door.

To lock

- ▷ Either use the central locking button to lock both doors at once or
- ▷ press down the individual door lock buttons. In this case, the fuel filler door will stay unlocked. To prevent the driver from being inadvertently locked out of the vehicle, the driver's door lock button will not engage as long as the door is open.



Persons or animals inside the vehicle may be able to lock the doors from the inside. You should always take the vehicle's keys with you so that you can open the vehicle again from the outside at any time. ◀

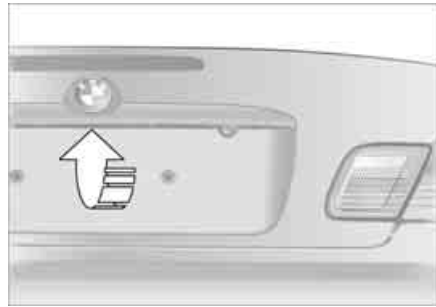
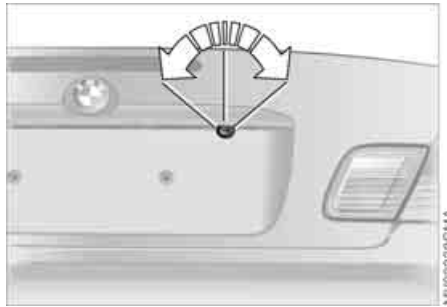

The lock

Only the master keys fit in the lock for the luggage compartment lid, refer to page 30.

To secure separately

Lock the glove compartment using the master key.

This locks the luggage compartment lid and disconnects it from the central locking system. This feature can be used to prevent unauthorized access to the luggage compartment when you surrender the spare key only, refer to page 30. This can be advantageous for valet parking, for example.

To open from the outside

Press the button in the handle recess: the luggage compartment lid opens slightly.

The luggage compartment is lit when the luggage compartment lid is opened.

Manual operation

In the event of electrical malfunction Turn the master key all the way to the left – the luggage compartment lid will open slightly.

The luggage compartment is locked again as soon as you close the lid.

To open from the inside*

If the luggage compartment lid has not been locked separately, you can open it with this button in the footwell on the driver's side when the vehicle is stationary.

36 Luggage compartment lid

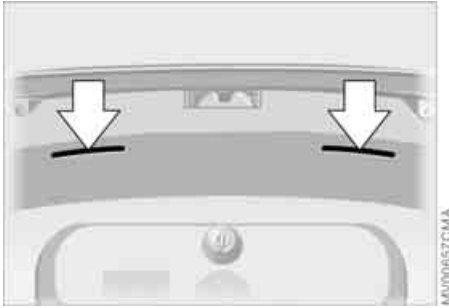



Should it be absolutely necessary to operate the vehicle with the luggage compartment lid open, with closed convertible top:

1. Close all windows
2. Greatly increase the quantity of air coming from the air conditioning or automatic climate control system, refer to page [102](#) or [106](#).

To close

The handle recesses in the interior trim panel of the luggage compartment lid make it easier to pull the lid down.

 To avoid injuries, be sure that the travel path of the luggage compartment lid is clear when it is closed, following the same precautions as with all closing procedures. ◀

 Operate the vehicle only when the luggage compartment lid is closed. Otherwise, exhaust fumes could penetrate the interior of the vehicle. ◀



Emergency release

This lever releases the luggage compartment lid from inside the luggage compartment.

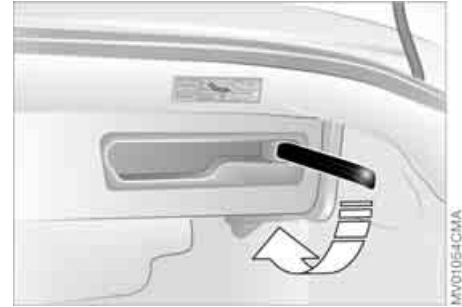
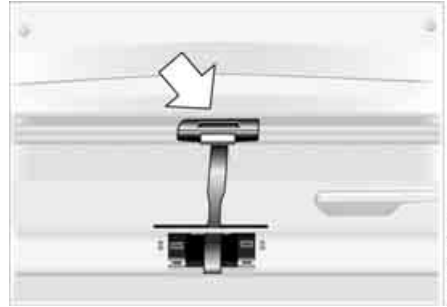
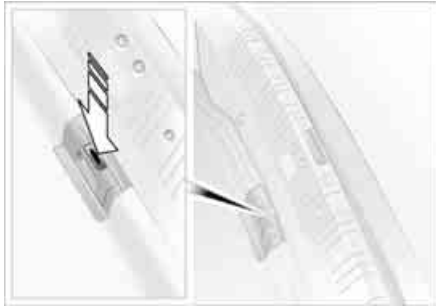

To fold up and secure the floor panel

1. Pull up at the handle and fold the panel up
2. Press the button to release the hanger from the handle

3. Hook the handle into the rubber seal of the drip rail.

 Carefully replace the hanger in its holder when lowering the floor panel back down. ◀

The fittings at the corners of the luggage compartment provide you with a convenient means of attaching luggage compartment nets* and flexible straps for securing luggage.

Refer also to Cargo loading on page 118.

To enlarge the luggage compartment

With the convertible top closed, you can enlarge the luggage compartment. To do this, flip the handle outward and press it down and toward the front of the vehicle. The convertible top compartment panel is now raised and secured.

To fold down the convertible top compartment panel

The convertible top compartment lid must be folded down to open the convertible top. Swing out the handle and pull toward the back of the vehicle.



Before lowering the convertible top, refer to page 41 or 46, always check to ensure that the luggage compartment panel is folded down. Otherwise damage could occur. ◀

The concept

The vehicle alarm system responds:

- ▷ When a door, the hood or the luggage compartment lid is opened
- ▷ To movements inside the vehicle – interior motion sensor
- ▷ To variations in the vehicle's tilt angle such as those occurring during attempts to steal the wheels or tow the vehicle – tilt alarm sensor
- ▷ To interruption of battery voltage.

The system responds to unauthorized vehicle entry and attempted theft by simultaneously activating the following:

- ▷ The acoustic alarm sounds for 30 seconds
- ▷ The hazard warning flashers are activated for approx. five minutes
- ▷ The high beams flash on and off in rhythm with the hazard warning flashers.

To arm and disarm the alarm system

When the vehicle is locked or unlocked via the driver's door lock or with the remote control, the alarm system is also simultaneously armed or disarmed.



You can have different acknowledgment signals set to confirm arming and disarming. ◀



You can open the luggage compartment lid when the system is armed by pressing the remote control button, refer to page 32. The lid is once again secured when it is closed.

Extended pressure on the button sets off the alarm – Panic mode, refer to page 32.

Alarm system*



Indicator lamp displays

- ▷ The indicator lamp below the interior rearview mirror flashes continuously: The system is armed
- ▷ The indicator lamp flashes during arming: the door(s), the hood or the luggage compartment lid are not completely closed. Even if you do not close the alerted area(s), the remaining areas are secured, and the indicator lamp will flash continuously after 10 seconds. However, the interior motion sensor is not activated
- ▷ The indicator lamp goes out when the system is disarmed: no manipulation or attempted intrusions have been detected in the period since the system was armed
- ▷ The indicator lamp flashes for 10 seconds when the system is dis-

armed: an attempted entry has been detected in the period since the system was armed.

Following triggering of an alarm, the indicator lamp will flash continuously.

Avoiding unintentional alarms

The tilt alarm sensor and interior motion sensor may be switched off at the same time. You can do this to prevent a false alarm from being triggered in garages with elevator ramps, for instance, or when the vehicle is transported by train:



Lock the vehicle twice to arm the system. Press the button on the remote control twice in succession or lock the vehicle twice with the key.

The indicator lamp lights up briefly and then flashes continuously. The tilt alarm sensor and the interior motion sensor are deactivated as long as the system is armed.



You can have the tilt alarm sensor and the interior motion sensor permanently deactivated. ◀

Interior motion sensor*

Deactivate the interior motion sensor – refer to Avoiding unintentional alarms – if persons or animals are to remain in the vehicle.



The system deactivates the tilt-alarm sensor and the interior motion sensor if the convenience closing of windows is interrupted in the first 10 seconds and then restarted. The alarm must then be disarmed and reactivated before it will resume operation. ◀

40 Electric power windows



You can close the windows in the same manner by pulling the switch. The rear windows do not close automatically.



To open and close windows



When leaving the vehicle, always remove the ignition key from the lock and remember to close the doors to prevent children from operating the power windows and injuring themselves, etc. ◀

With the ignition key in position 1 or higher

- ▷ Press the switch until you feel resistance: the window retracts as long as you maintain pressure on the switch
- ▷ Press the switch briefly past the pressure point: the windows move automatically. Pressing the switch again stops the opening cycle.

To operate all the side windows

With the ignition key in position 1 or higher

- ▷ Press the switch until you feel resistance: the windows retract as long as you maintain pressure on the switch
- ▷ Press the switch briefly past the pressure point: the windows move automatically. Pressing the switch again stops the opening cycle.

You can close all windows in the same manner by pulling the switch. The windows cannot be closed automatically using this switch.

For convenience operation via the remote control or the door lock, refer to page 32 or 33.

After the ignition has been switched off

You can still use the electric power windows for up to 15 minutes, as long as no one opens any of the doors.

Safety feature

If the closing force of a front window exceeds a certain value as the window is being closed, the closing procedure is immediately interrupted and the window opens again slightly.



Despite this protective function, you must still make sure that there are no obstacles within the closing range of the windows. Otherwise, it cannot be guaranteed that the closing procedure will be interrupted in certain cases, e.g. when very thin objects are in the closing range.

This protective function is deactivated when the switch is pulled past the resistance point and held there. ◀

After power loss

After the battery has been disconnected, the protective function must be reinitialized. Please refer the problem to your BMW center.

The fabric top offers the perfect protection against weather and one person can open and close it easily and simply.

To gain maximum satisfaction from your convertible, please observe the following: we strongly recommend that you close the convertible top before leaving the vehicle parked. When closed, the top not only guards the passenger compartment from unforeseeable damage from the weather, but also affords a degree of protection against theft.

However, even when the top is closed valuables should always be stored in the locked luggage compartment.

Never attempt to mount any kind of roof rack or luggage carrier on the convertible top.



Closing the electric power windows: to help ensure that the windows seal securely, you should either close the rear windows first or close all four windows at the same time. ◀

42 Manual convertible top

To open the convertible top

 Never attempt to open or close the convertible top unless the vehicle is completely stationary. To prevent vehicle damage the top compartment lid's lock will not disengage unless the luggage compartment lid is closed. ◀



1. Flip the locking handle out – refer to illustration – and turn it as far as the end stop will allow
2. Raise the convertible top a little bit, release the tension
3. To unlock, press the button with the ignition key in position 1 or higher. The top compartment lid's lock disengages and the lid itself rises a small distance. The side windows will lower slightly

 If the indicator lamp lights up when the button is pressed, the lid cannot be unlocked because the top compartment panel is raised, refer to page 37. Lower the top compartment panel and close the tailgate. ◀



4. Position the rear convertible top frame vertically and grip it firmly

 You can make it easier to raise the rear convertible top frame by pressing the area indicated by the arrow. ◀



5. Reach into the recess created when the convertible top compartment lid is lifted and pull it all the way by hand – see arrow 1
6. Lay the rear convertible top frame in the convertible top compartment – see arrow 2

 Let go of the rear convertible top frame before laying the convertible top down, otherwise, the side trim panel could be damaged. ◀

7. Raise the front of the top and pull it back for storage

 Now finish pushing the convertible top all the way down into the convertible top compartment. This makes it easier to close the convertible top compartment lid, especially at lower temperatures. ◀

44 Manual convertible top

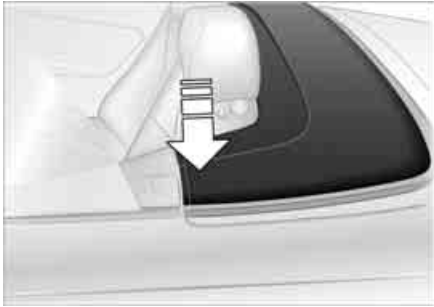

As soon as the convertible top compartment lid closes the central locking system will release the lock to allow renewed access to the luggage compartment.

 Never store the convertible top in its compartment for more than one day while it is wet to avoid permanent damage from moisture. ◀

8. Press down slightly on the convertible top compartment lid from above – see arrow. The closing process will then be carried out automatically
9. Either close the slightly lowered side windows or put them at the desired height.

 Operate the convertible top compartment lid from above only in order to avoid any pinching. An interlock device helps avoid damage to the vehicle by preventing the luggage compartment lid from opening unless the convertible top compartment lid is completely closed. ◀



To close the convertible top

1. Turn the ignition key to position 1
2. Press the button to unlock it. The convertible top will be unlocked and the side windows will lower slightly
3. Open the convertible top compartment lid all the way
4. Lift the convertible top out by the lateral guide section – see arrow 1, and the front convertible top frame – see arrow 2, swinging it forward until you encounter perceptible resistance – until it stops

 To avoid damaging the side trim, always fold the convertible top forward before folding the rear frame brace up into its vertical position. ◀

Manual convertible top

5. Either close the slightly lowered side windows or put them at the desired height
6. Press down slightly on the convertible top compartment lid from above. The top then closes automatically, refer to page 41

 Operate the convertible top compartment lid from above only in order to avoid any pinching. ◀

 As soon as the convertible top compartment lid closes the central locking system will release the lock to allow renewed access to the luggage compartment. ◀

7. Holding on to the locking handle, pull the front part of the convertible top frame up onto the windshield frame, and lock the convertible top by turning the handle until you hear the convertible top engage and lock.

The system automatically presses the top's rear frame against the convertible top compartment lid, pretensioning it to ensure that it seals tightly.

 At higher speeds, the ensuing vacuum in the passenger compartment can cause the convertible top to begin fluttering. Increase the air supply via the ventilation controls so that a vacuum does not occur in the vehicle. ◀



Position for cleaning

To be able to access the convertible top compartment, lean the rear frame of the convertible top against the cover of the convertible top compartment.

 First, use the button for activating the convertible top to unlock the locks of the convertible top compartment. Refer to page 42. ◀

 For additional information on vehicle care, refer to the Caring for your vehicle brochure. ◀

46 Fully-automatic convertible top*

The fully-automatic convertible top combines the benefits of effective protection against the elements with simple and convenient operation.

To gain maximum satisfaction from your convertible, please observe the following:

- ▷ We strongly recommend that you close the convertible top before leaving the vehicle parked. When closed, the top not only guards the passenger compartment from unforeseeable damage from the weather, but also affords a degree of protection against theft. In addition, keep valuables only in the locked luggage compartment, even when the convertible top is closed
- ▷ Never mount a roof-mounted luggage rack on the convertible top
- ▷ To avoid damaging the convertible top, do not activate it at temperatures below 14 °F / -10 °C.

 Never store the convertible top in its compartment for more than one day while it is wet to avoid permanent damage from moisture. ◀

 Do not lay objects on the convertible top, as they could fall off when it moves, causing vehicle damage or personal injury. ◀

 Driving when the opening or closing process has not been completed can cause vehicle damage or personal injury.

Always keep your hands and fingers well away from the top's mechanism while it is opening and closing. Ensure that children remain at a safe distance from the top's travel range while it is in motion. ◀

 Try to make sure that the vehicle is completely stationary before using the fully-automatic convertible top. Otherwise the opening or closing procedure could be interrupted. If you set the convertible top in motion while the vehicle is stationary and then have to start suddenly – for instance, at a traffic light – you can still complete the procedure by driving as slowly as possible and again holding the corresponding button pressed. ◀

 When closing the electric power windows while underway, always remember to either start by closing the rear windows or to close all of them at once. Failure to adhere to this sequence can prevent the windows from sealing tightly at high speeds. ◀

 At higher speeds, the ensuing vacuum in the passenger compartment can cause the convertible top to begin fluttering. Increase the air supply via the ventilation controls so that a vacuum does not occur in the vehicle. ◀

Fully-automatic convertible top*

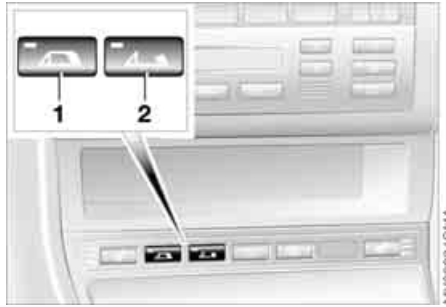

Opening and closing

- 1 To close
- 2 To open

▷ To avoid placing unnecessary loads on the battery, you should avoid operating the top when the engine is switched off.

Before closing the top, always ensure that the windshield frame is clear of any obstructions that could prevent the top from closing correctly. ◀

With the ignition key in position 1 or higher, and with the vehicle stationary

1. Read and comply with the preceding safety precautions

2. Ensure that the convertible top compartment panel in the luggage compartment is folded down, see page 37; otherwise, it will not be possible to open the convertible top
3. Ensure that the luggage compartment lid is closed
4. Maintain pressure on the corresponding button for the convertible top operation.

▷ The luggage compartment lid cannot be opened while the convertible top is in motion. ◀

⚠ While the convertible top is in motion, the rear window will move toward the passenger compartment. To avoid possible pinching, the area around the closing convertible top should be clear. ◀

▷ After having been stored for an extended period of time in the convertible top compartment, e.g. during the winter months because the hardtop was being used, you may have to support the convertible top by hand when closing it for the first time. If the convertible top should halt just before the closing phase is completed, press against the front section of the convertible top frame from the outside to help the closing process along. Continue pressing the switch while doing so until the top starts up again on its own. ◀

Indicator lamps

- ▷ The red indicator lamp is lit whenever the convertible top mechanism is in motion. It goes out as soon as the opening or closing operation has been completed
- ▷ If the red indicator lamp flashes after the control button is released, the convertible top has not yet been opened or closed completely. You can resume operation in the desired direction by pressing the button again
- ▷ If the yellow indicator lamp lights up continuously with the button pressed, the convertible top compartment

48 Fully-automatic convertible top*

panel has been raised and the top cannot be moved.

The side windows move down slightly whenever the button for operating the convertible top is pressed.

They will go back up if you keep holding the button down for more than 2 seconds after the opening or closing process has been completed and the indicator lamp has gone out.

Interruption

The convertible top stops moving immediately when the button is released. You can resume operation in the desired direction by pressing the button again

 Do not close the side windows using the power window switches if the convertible top has not been closed completely. Otherwise, the side windows may not seal properly with the rubber seals of the convertible top. ◀

If the opening or closing operation is interrupted by releasing the buttons, the convertible top remains in the respective position for 15 minutes before it slowly moves into a stable position. The operation can be continued by pressing the buttons.

 Do not repeatedly interrupt and resume the closing procedure, as otherwise the fully-automatic convertible top mechanism could be damaged. ◀

In certain cases, the luggage compartment lid cannot be opened if the opening or closing operation has been interrupted.

 Operate the convertible top manually in emergency situations only to avoid causing damage due to incorrect operation. ◀

Convenience operation via remote control and driver's door lock

Refer to pages [32](#) and [33](#).



Manual closing in the event of an electrical malfunction

- 1 Emergency operation
- 2 Allen wrench
- 3 Recess

 Only operate the convertible top manually when closing it. Never open it manually since the convertible top compartment lid cannot be locked, and would open while you are driving. ◀

 Manual closing is best carried out by two persons from outside with the driver's door open and the driver's seat folded forward. No one is to be in the rear seat while you are doing this. ◀

Fully-automatic convertible top*

1. Remove the insert between the rear seats. Take the trim off of the guide rod and flip it forward
2. Press down hard on the emergency lock 1 – see previous illustration. After a brief pause, the mechanism for the convertible top compartment lid will be released

 If the mechanism for the convertible top compartment lid does not unlock, then insert the Allen wrench 2 into the recess 3 and turn clockwise to release it. ◀

3. If the luggage compartment lid is closed, open the convertible top compartment lid up as far as the stop will allow



4. Grasp the convertible top by the lateral guide section – see arrow 1 – and the front convertible top frame – see arrow 2. Lift out the top and swing it forward until you encounter a perceptible resistance – until it stops. Position the rear convertible top frame vertically and close the convertible top compartment lid. Fold down the rear convertible top frame

 To avoid damaging the side trim, always fold the convertible top forward before folding the rear frame brace up into its vertical position. ◀

5. Use a screwdriver to lift out the cover panel that is in the center of the front convertible top frame
6. Insert the Allen wrench 2 – refer to page 48 – into the recess – see arrow
7. Pull down on the front convertible top frame as far as possible. Complete the closing process by continuing to turn the wrench in a clockwise direction. Turn until the front convertible top frame has locked onto the windshield frame. The system automatically presses the top's rear frame against the convertible top compartment lid, pretensioning it to ensure that it seals tightly.

 Always make sure the closing procedure is completed to prevent vehicle damage or personal injury. ◀

50 Fully-automatic convertible top*

▶ Please consult your BMW center to have the defect corrected. ◀



Position for cleaning

To be able to access the convertible top compartment, lean the rear frame of the convertible top against the cover of the convertible top compartment.

▶ First, use the button for activating the convertible top to unlock the locks of the convertible top compartment. Refer to page 47. ◀

▶ For additional information on vehicle care, refer to the Caring for your vehicle brochure. ◀

Wind deflector*

With the convertible top open, the wind deflector keeps air movement in the passenger compartment to a minimum, thus providing you with a pleasant drive, even at higher speeds. The wind deflector comes in a protective sleeve, and because of its slim dimensions, can be easily stored in the luggage compartment.

Installation

1. Remove wind deflector from the protective sleeve

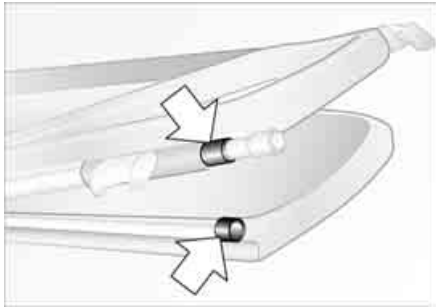

2. Flip out both sides and lock into place. It is essential for the two components marked in the illustration to mesh at this point

3. Hold the wind deflector so that the smaller half points toward the front and guide the mounting pin for the side piece into the proper opening
4. Pull back on the mounting pin for the other side piece by using a slide, so that the mounting pin can be guided into the opening provided
5. Unlock the convertible top compartment lid via the convertible top control button, refer to page 47, and open the convertible top compartment lid
6. Flip the back half of the wind deflector backward, so that the mounts are lying on the vehicle
7. Close the convertible top compartment lid via the convertible top control button. The wind deflector is now attached so that it is theft-proof.

 Operate the convertible top compartment lid from above only in order to avoid any pinching. With the wind deflector in place: to avoid damaging the wind deflector never push the front seats all the way back. ◀

Removal

Follow the same procedure as when installing, just reverse the steps.

52 Safe seating position

For driving that is relaxed and less likely to cause fatigue, you should select a sitting position that reflects your personal requirements. In combination with the safety belts and airbags, the correct seating position also plays an important role in enhancing occupant safety in the event of an accident. To ensure that the vehicle's safety systems provide you with optimal protection, we request that you direct your careful attention to the following section.

For supplementary information on transporting children, refer to page 64.

Sitting safely with airbags

 Always maintain an adequate distance between yourself and the airbags. Always hold the steering wheel by the rim to keep any chance of injury to hands or arms to an absolute minimum should the airbag be deployed. Never allow any objects, individuals or animals to obstruct the areas between passengers and airbags. Never use the front airbag's cover as a storage tray or support for objects of any kind. Never allow front passengers to rest their feet or legs on the airbag cover. ◀

For airbag locations and additional information on airbags, refer to page 61.

Sitting safely with safety belts

Your vehicle is equipped with four seats, each of which is provided with a safety belt.



Never allow more than one person to wear a single safety belt. Never allow infants or small children to ride in a passenger's lap. Avoid twisting the belt while routing it firmly across the hips and shoulder, wear it as snugly against your body as possible. Do not allow the belt to rest against hard or fragile objects. Do not route the belt across your neck, or run it across sharp edges. Be sure that the belt does not become caught or jammed. Avoid wearing bulky clothing and pull on the lap belt periodically to retension it over your shoulders. In the event of a frontal impact, a loose lap belt could slide over your hips, leading to abdominal injury. In addition, the safety belt's restraint effectiveness is reduced if it is worn loosely. Expectant mothers should always wear their safety belts, taking care to position the lap belt against the lower hips, where it will not exert pressure against the abdominal area. ◀

For information on using the safety belts, refer to page 56.

When adjusting your seat, always observe the following precautions

⚠ Never try to adjust your seat while operating the vehicle. The seat could respond with unexpected movement, and the ensuing loss of vehicle control could lead to an accident. Never ride with the backrest reclined to an extreme angle. This is especially important for the front passenger to remember. If you do so, there is a risk that you will slide under the safety belt in an accident, thus reducing the protection provided by the safety belt. With the wind deflector in place: Do not push the front seats all the way back, otherwise the wind deflector will be damaged. ◀

Seat adjustment

- ▷ Power seat adjustment, refer to page 53
- ▷ Head restraint, refer to page 54
- ▷ Entering the rear, refer to page 55.

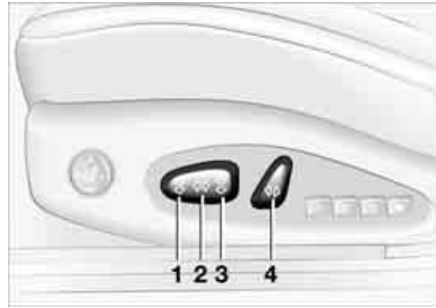

Seat adjustment

- 1 Tilt angle
- 2 Backward/forward adjustment
- 3 Height
- 4 Backrest angle

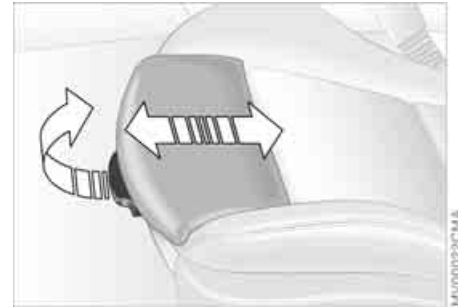

⚠ Please refer to the adjustment instructions on page 53 to reduce the risk of personal injury. ◀

With the BMW sports seat* you can also adjust the thigh support. To do so, pull the lever and adjust the position of the cushion for thigh support as desired.



To adjust

You can adjust the backrest's contour for additional support in the curvature of your spine's lumbar region.

The upper hips and spinal column receive supplementary support to help you maintain a relaxed, upright posture.

- ▷ Press front/rear of switch: increase/decrease curvature
- ▷ Press the upper/lower end of the switch: increase the upper/lower curvature.

Head restraints

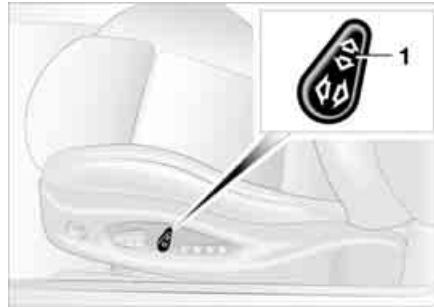

Front head restraints

1 Height

- ⚠ Head restraints reduce the risk of spinal injury in the event of an accident. Adjust the head restraint so that its center is approximately at the height of your ears. When moving the head restraints up or down, avoid placing hands and fingers between the head restraint and the upper edge of the backrest to avoid the possibility of injury. ◀



Tilt angle: position the head restraints manually in the preferred position.

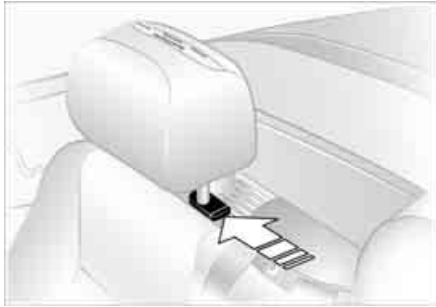

Rear head restraints

 To avoid possible violation of traffic laws, never retract the head restraints unless the rear seats are empty. Always ensure that the head restraints are raised before transporting passengers in the rear seat. ◀

To completely lower the rear head restraints:

1. Press the button and hold it down
2. Push the head restraint down from above.

Raising the rear head restraints

Raise the head restraints until you hear them click into place.

 Do not remove the rear head restraints, as this would damage them. ◀

For further information, please consult your BMW center.

 Do not use the rear head restraints as storage shelves. Always keep the travel path for the roll-over protection system free and clear. Never place protective covers or similar items on the head restraints. See also the labels on the head restraints. ◀

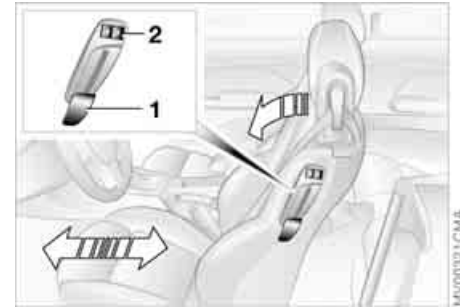

The seat-integrated safety belt system allows for easy access to the rear.

1. Lift lever 1 up and tilt the backrest forward
2. Press and hold button 2 in driving direction until the seat moves to the desired position
3. After entering the rear, fold back and lock the backrest
4. Press button 2 opposite the direction of travel and hold. The seat moves back into its previous position. If the button 2 is released beforehand, the seat stops in the respective position.

 You can lock a backrest that has been tilted forward. This makes sense when, for instance, someone is climbing into the rear on an incline. To do this, press against the backrest until you hear it click into place. To move it back into place, you do not need to first unlock it by moving the lever 1. ◀

 Lock both backrests while driving, otherwise there is a danger of an unexpected movement causing an accident. ◀

 The indicator lamp in the instrument cluster flashes when the backrest is not locked, refer to page 18.

Safety belts



Always wear your safety belt

Always fasten your safety belt before starting off. As supplemental restraint devices, the airbags are designed to enhance the effectiveness of the safety belts, and not to replace them.

 Always detach the rear safety belts from their retainers before wearing. ◀

 To avoid undesired movement at high speeds, always store the rear safety belts in their retainers when they are not in use. ◀

To close

Make sure you hear the lock engage in the belt buckle.

To release

1. Press the red button in the belt buckle
2. Hold the belt
3. Guide the belt back into its reel.

Safety belt height

The front belt system automatically adapts to your body size when the height of the head restraint is adjusted. Refer to page 54.

 If the safety belt system has been subjected to the stresses involved in an accident or otherwise damaged: have the entire safety belt mechanism replaced by your BMW center, including the safety belt tensioner. In addition, have your BMW center inspect the safety belt anchors. If a child-restraint system was in the vehicle during an accident, consult the manufacturer's instructions regarding replacement. ◀

Seat and mirror memory*

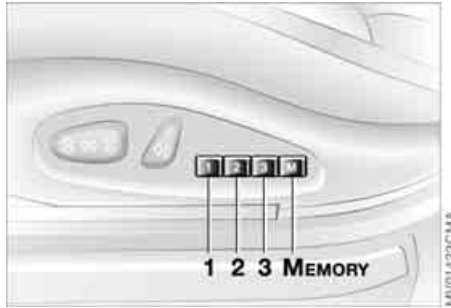

You can store and recall three different driver's seat and exterior mirror positions.

 The lumbar support settings are not stored in the memory. ◀

To store

1. Ignition key position 1 or 2
2. Select the desired seat and exterior mirror positions
3. Press the MEMORY button: the indicator lamp in the button lights up
4. Press memory button 1, 2 or 3, as desired: the indicator lamp goes out.

To select a stored setting

 Do not select a memory position while the vehicle is moving. If you do so, there is a risk of accident from unexpected seat movement. ◀

Ignition key in position 1:

- ▷ Briefly press memory button 1, 2 or 3, as desired.
Movement stops immediately when one of the seat-adjustment or memory buttons is activated during the adjustment process.

The driver's door is closed and the ignition key is either removed or in position 0 or 2:

- ▷ Maintain pressure on the desired memory button – 1, 2 or 3 – until the adjustment process is completed.

If you press the MEMORY button accidentally: press the button again; the indicator lamp goes out.

 You can have this feature programmed so that when you use the remote control from your personalized key to unlock your door, your seat and the exterior mirrors will move into your own preferred positions. ◀

 Before activating the programmed adjustment feature, ensure that the footwell behind the driver's seat is empty and unobstructed. If you fail to do so, persons, animals or objects could be injured or damaged if the seat should move backward. ◀



Passenger-side exterior mirror tilt function

Automatic curb monitor*

1. Move mirror selector switch 1 to the driver's mirror position
2. When shifting into Reverse, or placing the selector lever in position R, the passenger-side mirror tilts downward. This allows the driver to see the area directly adjacent to the vehicle during parking – curbs, etc.



How far the passenger mirror tilts can be set individually for each ignition key. ◀

You can deactivate this automatic feature by setting the mirror selection switch to the passenger side position.

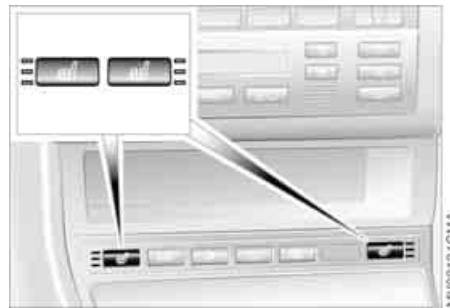

The seat cushion and backrest can be heated with the ignition key in position 2.

You can select different heating modes by repeatedly pressing the buttons.

You can also switch the higher heating modes off directly:

Press the button and hold it slightly longer.

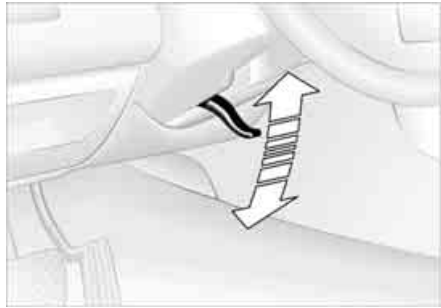

To adjust

! Never attempt to adjust the steering wheel while driving the vehicle – it could respond with unexpected movement, posing a potential accident hazard. ◀

1. Push the locking lever downward
2. Adjust steering column reach and height for your selected seating position
3. Pull the lever back up.

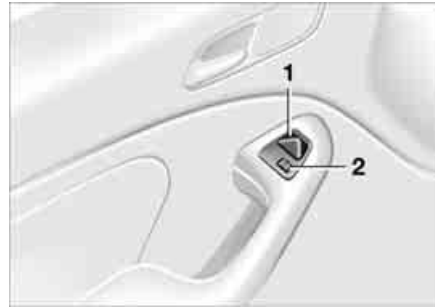

To adjust exterior mirrors

- 1 Switch for 4-way adjustment
- 2 Selection switch for changing between mirrors

To adjust manually

The mirrors can also be adjusted manually:

Press the edge of the lens.

For storing mirror settings, refer to Seat and mirror memory on page 57.

! The mirror on the passenger's side is convex. When estimating the distance between yourself and other traffic, bear in mind that the objects reflected in the mirror are closer than they appear. This means that estimates of the distance to following traffic should not be regarded as precise. ◀

Electric defrosting

Both mirrors are automatically heated when you turn the ignition key to position 2.



Interior rearview mirror

To reduce glare from vehicles behind you when you are driving at night, tilt the mirror by turning the button.

Vehicles without alarm system:

Tilt the small lever forward.

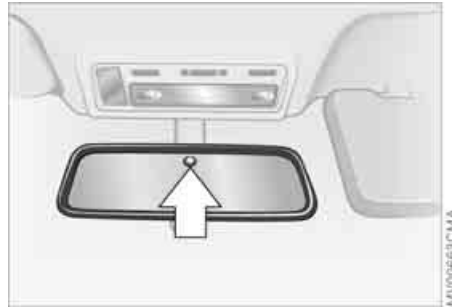

Interior rearview mirror with automatic dimming feature*

This mirror automatically responds to ambient light and headlamp glare from following vehicles by dimming through an infinitely variable range and automatically reverts to its clear, undimmed setting whenever you shift into Reverse or move the selector lever into position R.

To ensure that the mirror continues to operate efficiently, ensure that the photocells remain clear and unobstructed. One photocell is integrated in the mirror's lens – see arrow – while the other is located at an offset position on the

rear of the mirror. Refrain from attaching stickers or other objects to the windshield in the area immediately behind the rearview mirror.

Airbags

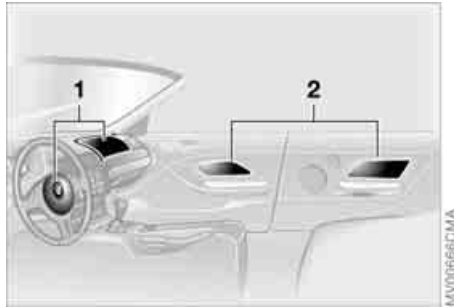

- 1 Front airbags on the driver and passenger sides
- 2 Side airbags on the driver and passenger sides – front and rear*

Protective effect

The front airbags supplement the three-point safety belts by providing additional protection in the event of a severe frontal collision in which the protection afforded by the belts alone may no longer be sufficient. The side airbags provide protection in the event of a collision from the side. They help support the respective seat occupant's upper body.

For information on the correct sitting posture, refer to page [52](#).

▶ The side airbags in the rear passenger area* of your vehicle may already have been deactivated by a BMW center. You may have them activated if you desire to do so. Please contact your BMW center for additional information. ◀

▶ The airbags do not deploy in response to minor collisions, rear impacts and certain kinds of vehicle rollover. ◀

⚠ Do not apply adhesive materials to the cover panels of the airbags, cover them or modify them in any other way. Do not remove the airbag restraint system. In the event of a malfunction, deactivation or triggered activation – as a response to an accident – of the airbag restraint system, consult your BMW center for inspection, repair or disassembly. Do not modify or tamper with either the wiring or the individual components in the airbag system. These include the upholstered covers on the steering wheel, instrument panel, side trim panels of the doors and front roof pillars and on the sides of the headliner. Also, do not attempt to remove the steering wheel. Unprofessional attempts to service the system could lead to failure in an emergency or undesired airbag activation, either of which could result in personal injury. Do not touch the individual components immediately after the system has been activated, as this could result in personal injury. ◀

62 Airbags



At all times, occupants should sit upright and be properly restrained – infants and small children in appropriate child-restraint systems; larger children and adults using the safety belts. Never let an occupant's head rest near or on a side airbag because the inflating airbag could cause a serious or fatal injury. Please note that the word Airbag imprinted on the door trim panel indicates the airbag's location.

Accident research shows that the safest place for children in an automobile is in the rear seat. However, a child sitting in the rear seat and not properly restrained could place his or her head on or near the airbag, if so equipped. For example, a child – even though belted in – may fall asleep with his or her head against the side airbag. It may be difficult for a driver to ensure that children in the rear seat will remain properly positioned at all times and not place their heads on or near the side airbag. Therefore, we recommend that the rear-seat side airbags, if installed in the vehicle, be deactivated if children will travel in the rear seat.

The rear seat side airbags may already have been deactivated by a BMW center. If you are uncertain of their status, or wish to have the airbags activated or

deactivated, please contact your BMW center. ◀

Even when all these guidelines are followed, there is still a small residual risk of injuries to the face, hands and arms occurring from airbag deployment in isolated instances.

In sensitive individuals, the ignition and inflation noise may induce a mild hearing loss that is temporary in most cases.

Corresponding airbag warning labels are located on both sun visors.



This is the right way a child should sit in a child restraint when rear side airbags are provided.

Airbags



 If there is a system malfunction, there is a risk that the airbags will not be triggered within their normal response range, even if the level of impact would normally have triggered them. Have your BMW center inspect the airbag system immediately. ◀

This is the right way a larger child should sit wearing the seat belt when rear side airbags are provided.

Indicator lamp



The indicator lamp indicates the operational status of the airbag system when the ignition key is in position 1 or higher.

System operational:

- ▷ The indicator lamp comes on briefly when you turn the ignition key to position 1 or higher.

System malfunction:

- ▷ Indicator lamp does not come on or
- ▷ indicator lamp lights up continuously.

 To avoid undesired movement at high speeds, always store the rear safety belts in their retainers when they are not in use. ◀

Commercially available child-restraint systems are designed to be secured with a lap belt or with the lap belt portion of a combination lap/shoulder belt. Improperly or inadequately installed restraint systems can increase the risk of injury to children. Always read and follow the instructions that come with the system.

Correct location for installing

In your BMW, all seats equipped with a three-point safety belt – except for the driver's seat – are suitable for installing universal child-restraint systems of all age classes and which have been approved for the age group in question.

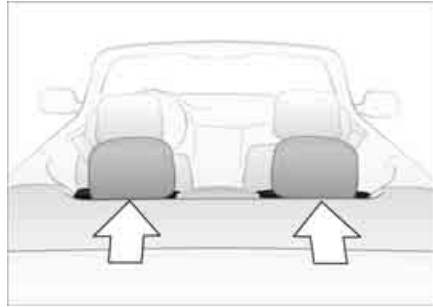

Child-restraint system with tether strap

If you use a child-restraint system with a tether strap, two additional tether anchorage points have been provided.

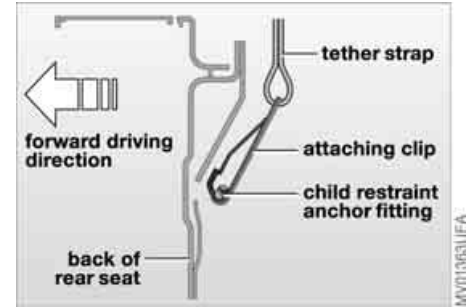

Depending on the location selected for seating in the rear passenger area, attach the tether strap to the corresponding anchorage point to secure the child-restraint system, as shown in the illustration.

1. Open the convertible top compartment lid, refer to page [41](#) or [46](#)
2. Lift the headrest and pass the tether strap between the headrest and the seat back. It is recommended that you return the head restraint back to its lowest possible position
3. Adjust the tether strap according to the child-restraint manufacturer's instructions
4. Close the convertible top compartment panel.

Transporting children safely

It is recommended to cover the child-restraint attaching clip with a soft material to prevent damage to the stored soft top.



Should a hard top be installed, the fitting of child harness tether strap/s – if child seat is required – is necessary before installation of the hard top. ◀



Before installing any child-restraint device or child seat, please read the following: Never install a rearward-facing child-restraint system in the front passenger seat of this vehicle. Your vehicle is equipped with an airbag supplemental restraint system for the front passenger. Because the backrest on any rearward-facing child-restraint system – of the kind designed for infants under 1 year and 20 lbs/9 kg – would be within the airbag's deployment range, you should never mount such a device in the front passenger seat, since the impact of the airbag against the child restraint's backrest could lead to serious or fatal injuries. If it is necessary for a child – not an infant – to ride in the front seat, certain precautions should be taken. First, move the passenger seat as far away from the dashboard as possible. This important precaution is intended to maximize the distance between the airbag and the child. Older children should be tightly secured with the safety belt after they have outgrown a booster seat that is appropriate for their age, height, and weight. Younger children should be secured in an appropriate forward-facing child-restraint sys-

tem that has first been properly installed with a safety belt. Never install a rearward-facing child-restraint system in the front passenger seat. We strongly urge you to carefully read and comply with the instructions for installation and use provided by the child restraint's manufacturer whenever you use such a device. Do not attempt to modify child-restraint systems. If you do this, the protection provided by these systems could be impaired. Be sure that all occupants – of all ages – remain properly and securely restrained at all times. ◀

All rear seating positions in your vehicle meet the recommendations of SAE J1819, an industry-recommended practice for securing child-restraint systems in motor vehicles.

66 Transporting children safely



The belt cannot be extracted further. Always observe the installation instructions provided by the manufacturer of the child-restraint system.

To unlock the safety belt

Release the safety belt, remove the child seat and retract the safety belt to its end position on the belt retractor.

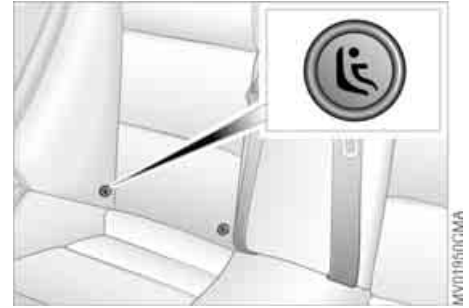

Securing child-restraint system

All of the rear belt retractors and the front passenger's safety belt can be locked for mounting and securing child-restraint systems.

A label with the appropriate instructions is located in the immediate vicinity of the buckle of each safety belt.

To lock the safety belt

Extract the entire length of the belt from the inertia reel mechanism. Allow the reel to retract the belt somewhat and engage the buckle, then tighten the belt against the child-restraint system. The retraction mechanism is now locked.

LATCH child-restraint mounting system

LATCH: Lower Anchors and Tethers for Children

The left and right rear seats are both equipped with a LATCH child-restraint mounting system.

Transporting children safely

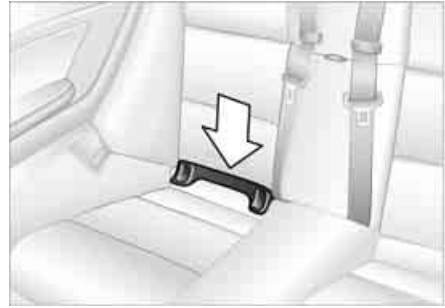
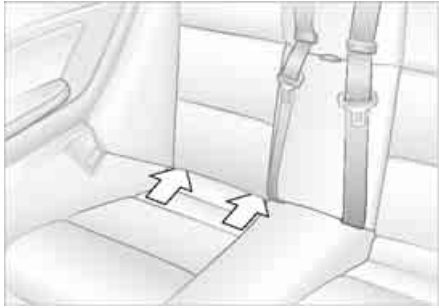

Canadian models only:

The LATCH anchorage points are identified by buttons.

The anchorage points for the LATCH child-restraint system are located behind the upholstery at the positions indicated by the arrows.

Carefully slide the brackets through the gaps in the upholstery at the indicated locations.

 Always follow all manufacturer's instructions and observe all safety precautions when installing the LATCH child-restraint mounting system.

To avoid undesired movement at high speeds, always store the rear safety belts in their retainers when they are not in use. ◀

Your BMW center can provide you with a special installation aid* that helps prevent damage to the upholstery.

Press the installation aid firmly in the crack between the seat and the backrest upholstery until both funnels click onto the LATCH system bars in the seat.

The illustration is an example showing the anchorages for a LATCH child seat system on the right rear seat.

68 Rollover protection system

In the event of an accident or some other critical driving situation – extreme tilting in the longitudinal or transverse axis, loss of contact with the ground – the rollover protection system will be automatically activated. The protective bars located in the rear head restraints extend within fractions of a second.

In addition to the integrated rollover bar in the windshield frame, the rollover protection system affords all the vehicle occupants necessary headroom.

 Always keep the travel path for the rollover protection system free and clear. Under no circumstances should you cover the head restraints. In the event of less serious accidents, the safety belt will protect you and, depending on the severity of the accident, so will the safety belt tensioner and the multi-stage airbag restraint system as well. ◀

If, after being automatically triggered, its protective function is not needed, then the rollover protection system can be lowered back into place. No special tool is needed for this.

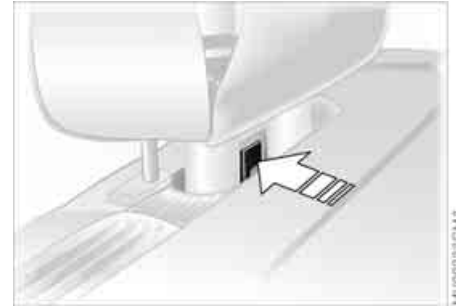
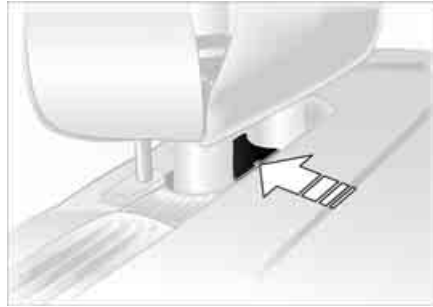

1. Using a screwdriver from the onboard tool kit, remove the cover panel; to do this, position the screwdriver under the notch
2. Push the lever toward the front of the vehicle and keep it in this position

Rollover protection system

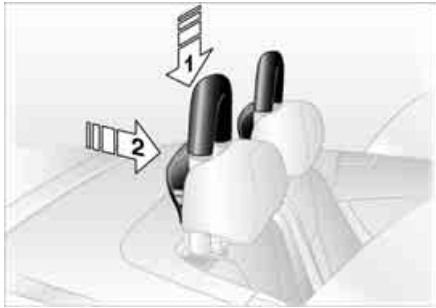

3. Keep pressing down on the protective bar – see arrow 1 – from on top until you hear it click into place
4. Put the cover panel back in place and press down firmly
5. Push the back panel of the head restraint closed – see arrow 2.

Do the same for the second protective bar. If you are not familiar with any of the procedures, consult your BMW center.

Have the rollover protection system checked out by your BMW center after it has been inadvertently triggered.



Do not move the convertible top under any circumstances if the rollover protection system has extended.

Do not use the rear head restraints as storage shelves.

Absolutely no modifications are to be made to any of the rollover protection system's individual components or any of its wiring.

Only your BMW center is to carry out any work on the rollover protection system.

Work done on the system that is carried out improperly could lead to failure in an emergency or accidental activation. Regarding having the system checked to ensure long-term operation: be scrupulous in adhering to the Service interval display for maintenance intervals. Every 2 years at the latest, the rollover protection system must be inspected at a BMW center. ◀

How the system functions

No doubt you have reflected at one time or another on how great it would be if you could permanently configure your vehicle's various features and adjustments to mirror your own individual preferences. In engineering your vehicle, BMW has provided for a number of options for personal adjustment that can be programmed into your vehicle at your BMW center.

The available configuration data fall into two categories, according to whether their primary orientation is the vehicle – Vehicle Memory – or the individual – Key Memory. Provided that each person has a separate remote-control key, you can have your BMW center enter basic adjustment data for up to four individuals in the system.

The system then relies on a bilateral data exchange to identify the individual user and executes the selected settings whenever the remote control unit is used to disengage the door locks.



Distinguishing between keys

Color-coded decals have been provided to help you distinguish individual keys with different settings.

What the system can do

Your BMW center can provide you with details on the capabilities of the Vehicle Memory and Key Memory systems.



You will see this symbol throughout the Owner's Manual. It is to remind you at appropriate places of the settings that are available to you. ◀

Examples for Vehicle Memory:

- ▷ Various signals as acknowledgment when locking or unlocking your vehicle, refer to pages 31, 33

- ▷ Activates/deactivates the 'Follow me home' function, refer to page 97
- ▷ Activates/deactivates daytime driving lamps, refer to page 97
- ▷ Sets the units of measure for displaying time, outside temperature, distance traveled and fuel consumption in the instrument cluster
- ▷ When you shift into Reverse, an acoustic signal indicates that PDC has been activated, refer to page 92
- ▷ Switches on rear window defroster automatically, refer to pages 104, 109
- ▷ Activates/deactivates various alarm system functions, refer to page 39
- ▷ After giving an ice warning, the onboard computer display returns to the previous setting, refer to page 90.

Examples for Key Memory:

- ▷ Unlocks driver's door first, then the vehicle's remaining locks, refer to page 33
- ▷ Locks the vehicle automatically after you start off, refer to page 34
- ▷ Automatically adjusts the driver's seat to the personal programmed settings when the vehicle is unlocked, refer to page 57
- ▷ Automatic tilting of the passenger-side mirror, refer to Automatic curb monitor, page 58.

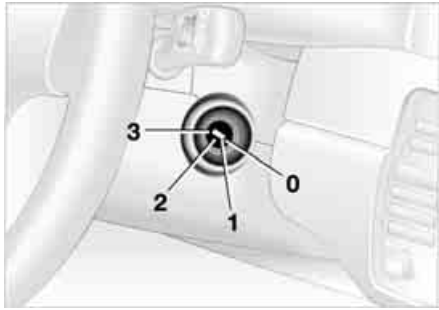

Ignition key positions

- 0 Steering locked
- 1 Steering unlocked
- 2 Ignition on
- 3 Start engine

Steering locked

The key can only be inserted and removed in this position.

After removing the key, turn the steering wheel slightly to the left or right until you hear the lock engage.

If the key is not removed, an acoustic signal sounds when the driver door is opened.

▶ Vehicles with automatic transmission:

Do not move the selector lever from position P until the engine is running, ignition key position 2.

Your vehicle is equipped with an interlock. Therefore, the ignition key cannot be turned to position 0 or removed until the selector lever is in position P. ◀

▶ Vehicles with manual transmission:

Step on the clutch when starting the vehicle. A lockout prevents the engine from starting if the clutch is not depressed. ◀

Steering unlocked

You will find that it is often easier to turn the ignition key from position 0 to position 1 when you move the steering wheel slightly to help disengage the lock.

Individual electrical accessories are ready for operation.

▶ Do not allow the engine to warm up by leaving it running while the vehicle remains stationary. Instead, drive off immediately at a moderate engine speed. ◀

⚠ Do not allow the engine to run in enclosed spaces. Otherwise, breathing the exhaust fumes can lead to unconsciousness and death. The exhaust gases contain carbon monoxide, an odorless and colorless, but highly toxic gas. Do not leave the vehicle unattended with the engine running. An unattended vehicle with a running engine represents a safety hazard. When driving, standing at idle or parking the vehicle, take care to avoid contact between the hot exhaust system and flammable materials – grass, hay, leaves, etc. Such contact could lead to a fire, resulting in serious personal injury and property damage. ◀

Start the engine. Do not press the accelerator pedal.

▶ Do not actuate the starter for too short a time, but do not actuate it for more than approx. 20 seconds. Release the ignition key immediately when the engine starts. ◀

If the engine does not start on the first attempt – if it is very hot or cold, for instance:

- ▷ Press the accelerator pedal halfway down while engaging the starter.

Cold starts at extremely low temperatures below approx. +5 °F/-15 °C and at altitudes over 3,300 ft/1,000 m:

- ▷ On the first start attempt, it may be necessary to engage the starter for a longer period – but no longer than 20 seconds
- ▷ Press the accelerator pedal halfway down while engaging the starter.

 Extended starting attempts, characterized by excessively frequent or long periods with the starter engaged can damage the catalytic converter. ◀

Engine idle speed is controlled by the engine computer system. Increased speeds at start-up are normal and should decrease as the engine warms up. If engine speed does not decrease, service is required.

To prevent the battery from discharging, always deactivate electrical devices that are not in use. Switch the ignition off when the vehicle is not being driven.

Manual transmission

1. Engage the parking brake
2. Gearshift lever in idling position
3. Start the engine.

Automatic transmission

1. Depress footbrake
2. Place the selector lever in position P or N
3. Start the engine.

 To prevent the vehicle from starting off on its own, always move the selector lever to position P and engage the parking brake before leaving your vehicle with the engine running.

Do not leave the vehicle unattended with the engine running. An unattended vehicle with a running engine represents a safety hazard. ◀

Sequential manual gearbox SMG

1. Depress footbrake
2. Move selector lever into position N

3. Start the engine.

 If the engine does not start, reengage the gear last selected, refer to the gear indicator in the display, and move the selector lever into neutral position N again.

The gearbox is automatically taken out of gear if the driver's door is opened while the engine is running and the driver does not actuate the pedals, the shift paddles or the selector lever. This is accompanied by a warning tone and the flashing gear indicator. The gear display N appears in the instrument cluster. ◀

 Before exiting the vehicle with the engine running, move the selector lever into position N and apply the parking brake.

Do not leave the vehicle unattended with the engine running. An unattended vehicle with a running engine represents a safety hazard. ◀

Switching off the engine



You should never remove the ignition key when the vehicle is in motion, as the steering lock could engage.

When you leave the vehicle, always remove the ignition key and engage the steering lock.

Always engage the parking brake when parking on slopes and inclined surfaces. Engaging a gear may not provide adequate resistance to rolling. ◀

Vehicles with manual transmission

Turn the ignition key to position 1 or 0.

Automatic transmission

Move the selector lever into position P, and turn the ignition key to position 1 or 0.

SMG gearbox

If you turn the ignition key to position 1 or 0 with the selector lever in position R, or in sequential mode, a gear automatically remains engaged.

If you turn the ignition key to position 1 or 0 with the selector lever in neutral position N, a warning tone and the flashing gear indicator in the display remind you that no gear is engaged to secure the vehicle against rolling.

The warning stops after approx. 9 seconds.

Parking brake

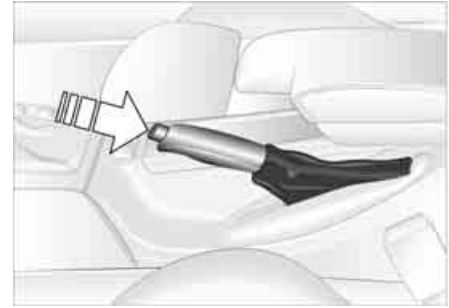

The parking brake is primarily designed to prevent the vehicle from rolling while parked. It operates on the rear wheels.

To engage

The detent engages automatically and the indicator lamp in the instrument cluster comes on when the ignition key is in position 2, refer to page 18.

To release

Pull up slightly on the lever, press the button and lower the lever.

 If exceptional circumstances make it necessary to engage the parking brake while the vehicle is in motion, do not pull it with excessive pressure. Keep your thumb pressed against the release button while carefully pulling the lever up.

Excessive pressure can lead to over-braking and loss of traction – fishtailing – at the rear axle.

The brake lamps do not come on when the parking brake is engaged.

Vehicles with manual or SMG gearbox: Engage the parking brake when parking on downhill roads, since engaging a gear may not provide adequate resistance to rolling, not even in first or reverse gear.

Vehicles with automatic transmission: place the selector lever in P. ◀

 To avoid corrosion and one-sided braking, apply the parking brake from time to time when coasting to a standstill – at a traffic signal, for example – provided that it is safe to do so. ◀

Manual transmission

 Do not hold the vehicle in place on slopes by slipping or 'riding' the clutch. Use the parking brake instead. Riding the clutch leads to severe and premature clutch wear. ◀

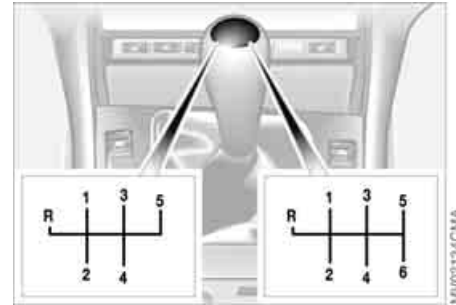

6-speed transmission*

When changing gear in the 5th/6th gear plane, be sure to press the gearshift lever to the right to prevent inadvertently shifting to a gear of the 3rd/4th gear plane.

Reverse

Select only when the vehicle is stationary. Press the gearshift lever to the left to overcome the slight resistance.

When you select reverse the backup lamps will light up automatically when the ignition key is in position 2.

Sequential manual gearbox SMG*

The concept

The sequential manual gearbox SMG is an automated manual gearbox with which clutching and shifting is assumed by an electro-hydraulic system.

The SMG is operated via the selector lever in the center console and two shift paddles on the steering wheel.

It offers the following functions:

- ▷ Sequential mode: manual mode
- ▷ Drive mode: automatic operation
- ▷ Ability to choose between two different driving programs: Standard, Sport
- ▷ Operating safety through protection against misshifting
- ▷ Automatic upshifts and downshifts in the drive mode
- ▷ Automatic downshifts at minimum engine rpm
- ▷ Kickdown function in the drive mode.
- ▷ Acceleration assistant, refer to page 78.



Selector lever positions

The current selector lever position is indicated by a light-emitting diode in the center console.

R: Reverse

N: Neutral

Position for forward driving with one-touch functions:

Sequential mode

+ : manual upshifts

- : manual downshifts

D: drive mode.

The SMG is ready for operation in ignition key position 2.

▶ The gearbox is automatically placed in neutral gear if the driver's door is opened while the engine is running and the driver does not actuate the pedals, the shift paddles or the selector lever.

This is accompanied by an acoustic signal and the flashing gear indicator. The gear display N appears in the instrument cluster.

A driving position can only be engaged when the driver's door is closed. When the vehicle is unlocked, a buzzer in the area of the transmission indicates that the system is ready for operation. ◀

Shiftlock

When the car is at a standstill, a safety function requires you to depress the brake pedal if you want to move the selector lever from the neutral position N to a driving position.

Driving precautions

⚠ Use enough acceleration to pull away speedily when moving off on an uphill gradient. Never try to prevent the car from rolling back on an uphill gradient by depressing the accelerator pedal; always apply the handbrake. Otherwise you could overheat the SMG gearbox. ◀

R Reverse

Select only when the vehicle is stationary.

N Neutral

Always engage before starting the engine, refer to Starting the engine on page 72.

Sequential mode

Each time the engine is started, the sequential mode is activated as soon as you move the selector lever into the forward driving position while the brake is depressed.

The gears are shifted via the shift paddles or the selector lever.

It is also possible to drive off in second gear, e.g. on snow-covered roads.

D Drive mode

In the drive mode all forward gears are shifted automatically.

To switch from sequential to drive mode: tap the selector lever to the right toward D.

For rapid acceleration, e.g. during passing, depress the accelerator pedal completely: kickdown.

To switch back to sequential mode: tap the selector lever again to the right toward D or change the current gear via the shift paddles or the selector lever.

Kickdown

You can achieve maximum acceleration using kickdown.

Depress the accelerator pedal past the increased resistance point at the full-throttle position.



Shifting gears

With the selector lever:

- ▷ To upshift, tap the selector lever toward +
- ▷ To downshift, tap the lever toward –.

With the shift paddles on the steering wheel:

- ▷ To upshift, pull one of the shift paddles
- ▷ To downshift, push the paddle.

You accelerate from higher gears, e.g. during passing, by manually downshifting.

In the following situations, the SMG in the sequential mode assists you:

- ▷ Upshifts and downshifts are only executed at appropriate combinations of engine rpm and vehicle speed. For

instance, downshifts that would result in excessive engine speed cannot be executed.

- ▷ When you brake the car to a stop, the transmission automatically shifts down to first gear
- ▷ As speed diminishes the transmission will shift down automatically, without any action on your part, just before the vehicle slows to below each gear's minimum speed.



For information on jump-starting and towing the vehicle, refer to page 159.

Warning tone

An acoustic signal sounds if the SMG gearbox overheats; if possible you should either stop or increase your pull-away speed so that the system can cool down.

Available displays

R N 1 2 3 4 5 6

D1 D2 D3 D4 D5 D6

The currently engaged gear, the selected mode, and any malfunctions are displayed in the instrument cluster.

Indicator lamp



If the indicator lamp comes on, there is a malfunction in the transmission system.

All selector lever positions can still be engaged, but in the forward driving positions only certain gears are actually available when the vehicle is driven.

Avoid extreme loads and proceed to the nearest BMW center.



1. Activate the Sport program
2. Press and hold the DSC button, refer to page 93, for more than three seconds
3. Quickly press the accelerator pedal down fully: kickdown. The optimum rpm for driving off will be adjusted.

 To maintain vehicle stability, always drive with the DSC activated whenever possible. ◀

Sport program

You can choose between two driving programs: smoothly dynamic or Sport. With the sport program, gearshifts are faster in sequential mode and the shift points are adapted in drive mode.

To activate the Sport program: press the SPORT button. The LED in the button lights up.

Acceleration assistant

The acceleration assistant permits optimum racing-style acceleration on roads with good grip.

 Do not use the acceleration assistant frequently as this could otherwise cause premature wear of the components. ◀

Automatic transmission with Steptronic*

You can drive as with a normal automatic transmission. In addition, you can also shift manually.

When you move the selector lever from the D position to the left into the M/S range, the performance-oriented shift programs of the automatic transmission are engaged. Steptronic enters the manual selection mode and executes the desired shift whenever you tap the selector lever in the direction indicated by + or -. Whenever you want to use automatic again, just move the selector lever toward the right to position D.

Under normal operating conditions, fuel consumption is lowest when driving in position D.

Selector lever positions

P R N D M/S + -

Starting the engine

The engine can only be started in selector lever positions P – for Park – or N – for Neutral.



Range selection

A catch prevents inadvertent movement of the selector lever to positions R and P. To deactivate the catch, press the button on the front of the selector lever knob, see arrow.



While the vehicle is stationary and before shifting out of Park or Neutral, depress the footbrake in order to disengage the selector lever's lock mechanism – Shiftlock. ◀



Hold the footbrake down until starting off. Otherwise the vehicle will 'creep' when a drive position is engaged. To prevent the vehicle from starting off on its own, always move the selector lever to position P and engage the parking brake before leaving your vehicle with the engine running. Do not leave the vehicle unattended with the engine running. An unattended vehicle with a running engine represents a safety hazard. ◀

P Park

Select only when the vehicle is stationary. Transmission locks to prevent rear wheels from turning.

R Reverse

Select only when the vehicle is stationary.

N Neutral

Select only when stopping for an extended period.

D Drive – automatic shift program

This position is designed for driving under all normal operating conditions. All forward gears are available.

Kickdown

In the kickdown mode, you achieve maximum acceleration and top speed in position D.

Depress the accelerator pedal past the increased resistance point at the full-throttle position.



The transmission will only execute upshifts and downshifts that will result in an appropriate combination of vehicle speed and engine rpm. For instance, downshifts that would result in excessive engine speed are not executed. The desired, then the actual gear, briefly appear in the instrument cluster.

 To accelerate quickly in the manual mode for maneuvers such as passing another vehicle, shift down manually or employ the kickdown mode. ◀

M/S manual operation and Sport program

Move the selector lever from D to M/S to activate the Sport program; SD appears in the display panel. The M/S mode is recommended for performance-oriented driving.

Once in the M/S mode, you can tap the selector lever to switch the automatic transmission from the Sport program to its manual selection mode.

This mode allows you to execute upshifts manually by tapping the lever toward +, while downshifts are selected by tapping in the – direction. The displays M1 through M5 appear in the display panel to indicate your current gear selection.

Shifting from M/S to the selector lever positions P, R and N is possible only by going through D.

Automatic transmission with Steptronic*



If the indicator lamp does not go out, you can place the selector lever in all positions. However, the vehicle will now only operate in 3rd and 4th gear.

If this happens, avoid extreme engine loads and consult the nearest authorized BMW center.



Never work in the engine compartment when a drive gear – forward or reverse – is engaged. If you do this, the vehicle could move. ◀

Available displays

P R N D SD M1 M2 M3 M4 M5

Electronic transmission control module



If the indicator lamp comes on, there is a malfunction in the transmission system.

Bring the vehicle to a stop. Move the transmission selector lever to P. Set the parking brake and turn the engine off – ignition key to position 0.

Wait a few seconds, then start the engine.

If the indicator lamp goes out after a few seconds, normal transmission performance has been restored. You may continue to drive as usual.

For towing or jump-starting, refer to the information beginning on page [159](#).

82 Turn signal indicator/Headlamp flasher

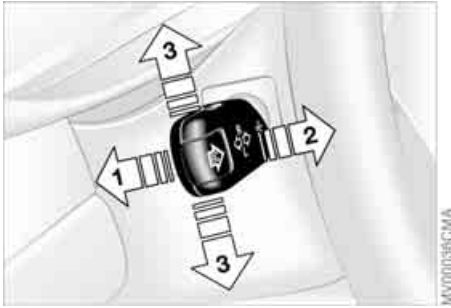

- 1 High beams – blue indicator lamp
- 2 Headlamp flasher – blue indicator lamp
- 3 Turn signal indicator – green indicator lamps accompanied by a periodic clicking sound from the relay

To signal briefly

Press the lever up to but not beyond the detent. It then returns to the center position when released.



If the flashing of the turn signal indicators and the clicking from the relay are both faster than normal, one of the turn signal indicators has failed. ◀

Washer/wiper system/Rain sensor*

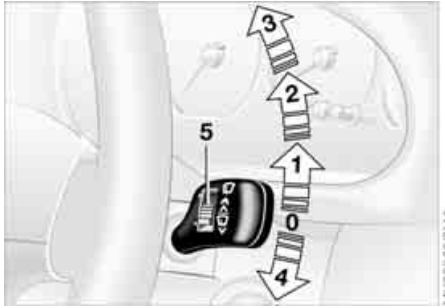

- 0 Wipers retracted
- 1 Intermittent mode or rain sensor
- 2 Normal wipe
- 3 Fast wipe
- 4 Brief wipe
- 5 Rotary dial for control of the wipe interval or the sensitivity of the rain sensor

Intermittent mode

Not on vehicles with rain sensor.

You can select any of four sweep intervals with rotary dial 5.

In addition, the wipe interval varies automatically depending on road speed.

Rain sensor*

The rain sensor is located on the windshield directly behind the rearview mirror.

To activate the rain sensor:

- ▷ With the ignition key in position 1 or higher, move the lever to position 1. The wipers will make at least one sweep across the windshield. You can leave the lever in position 1 at all times. With the ignition key in position 1 or higher, all you then need to do to activate the rain sensor is
 - ▷ briefly turn the rotary dial 5, or
 - ▷ clean windshield 1, refer to page 84.

To adjust the sensitivity of the rain sensor: turn rotary dial 5.

To switch off the rain sensor:

Return lever to position 0.



Turn the rain sensor off in automatic car washes. Failure to do so could result in damage caused by undesired wiper activation. ◀

Normal wiper speed

When the vehicle is stationary, the wipers switch automatically to intermittent wipe – not on vehicles with rain sensor.

Fast wiper speed

When the vehicle is stationary, the wipers operate at normal speed – not on vehicles with rain sensor.



When the vehicle's lighting system is switched on, the headlamps will also be cleaned at reasonable intervals.

Windshield washer nozzles

The windshield washer nozzles are heated automatically* when the ignition key is in position 2.

- 0 Wipers retracted
- 1 Clean windshield and headlamps

Cleaning windshield and headlamps*

 Do not use the washers if there is any danger that the fluid will freeze on the windshield, as your vision could be obscured. Always use a windshield washer antifreeze in cold weather. Refer to page 138. Do not use the washers when the reservoir is empty. This could cause damage to the washer pump. ◀

The system sprays washer fluid against the windshield and activates the wipers for a brief period.

Cruise control*

You can store and automatically maintain any desired vehicle speed above approx. 20 mph / 30 km/h.

The cruise control is available whenever the engine is running and the system has been activated.

To activate the system

I/O

In ignition key position 2:

Press the button in the steering wheel. The indicator lamp in the instrument cluster comes on, refer to page 20. You can now use the cruise control.

 Do not use cruise control on twist-ing roads, when high traffic density prevents driving at a constant speed, or when the road surface is slick – snow, rain, ice – or loose – rocks or gravel, sand. ◀

To deactivate the system

I/O

Press the button as often as needed until the indicator lamp in the instrument cluster goes out.

Cruise control is also deactivated when the ignition key is in position 0.

Cruise control*

The speed stored in memory is deleted.

To store and maintain speed or to accelerate



Press button + briefly:

The system maintains and stores the current vehicle speed. Every time you tap the button, the speed increases by approx. 0.6 mph / 1 km/h.

Press and hold button +:

The vehicle accelerates without pressure on the accelerator pedal. When you release the button, the system maintains and stores the current speed.



If on a downhill gradient the engine braking effect is not sufficient, the controlled speed can be exceeded. Speed can drop on uphill grades if the engine output is insufficient. ◀

To decelerate



Press button – briefly:

If you are already driving with activated cruise control, the speed is decreased by approx. 0.6 mph / 1 km/h every time you tap the button.

Press and hold button –:

With the cruise control active, the system automatically reduces the throttle opening to slow the vehicle. When you release the button, the system maintains and stores the current speed.

To interrupt the cruise control



When the system is activated, press the button. The indicator lamp stays on. You can use the cruise control again whenever you want by calling up the speed that was stored last.

In addition, cruise control is interrupted automatically:

- ▷ When the brakes are applied
- ▷ When you apply pressure to the clutch pedal, or when you move the automatic transmission selector lever from D to N

- ▷ If you exceed or fall below the programmed speed for an extended period – by depressing the accelerator, for example.

To recall the stored setting



Press the button:

The vehicle accelerates to and maintains the last speed stored.



- 1 Odometer
- 2 Trip odometer

Odometer

You can activate the displays shown in the illustration with the ignition key in position 0 by pressing the left button in the instrument cluster.

Trip odometer

To reset the trip odometer to zero, press the left button with the ignition key in position 1 or higher.



Do not operate the engine with the needle in the red overspeed zone of the gauge.

To protect the engine, the fuel supply is interrupted when you approach this sector.



Indicates the current fuel consumption in mpg – in liters/100 km on Canadian models. This allows you to see whether your current driving style is conducive to fuel economy with minimum exhaust emissions.

When the vehicle is stationary, the display goes to Maximum – zero on Canadian models.

Fuel gauge



Once the indicator lamp stays on continuously, there are still approx. 2.1 gallons/8 liters of fuel in the fuel tank.

Fuel tank capacity approx.
16.6 gallons/63 liters.

Certain operating conditions, such as those encountered in mountainous areas, may cause the needle to fluctuate slightly.

 Fill the fuel tank before it is completely empty. Driving to the last drop of fuel can prevent the engine from operating properly and result in damage. ◀

When you switch on the ignition, the indicator lamp lights up briefly as an operation check.

Engine coolant temperature gauge



To check coolant level, refer to page 140.

Blue

The engine is still cold. Drive at moderate engine and vehicle speeds.

Between the blue and red zones

Normal operating range. The needle may rise as far as the edge of the red sector during normal operation.

Red

When you switch on the ignition, the warning lamp comes on briefly as an operation check.

If the lamp comes on during normal vehicle operation: the engine has overheated. Shut off the engine immediately and allow it to cool down.

88 Service interval display



A flashing message and a "-" in front of the number mean that the service interval has already been exceeded by the distance shown on the display. Please contact your BMW center for an appointment.

Remaining distance to next service

The displays shown in the illustration appear for a few seconds when the ignition key is in position 1 or higher or after the engine is started.

The next service due appears with the message OIL SERVICE or INSPECTION, together with the distance remaining in miles – in kilometers in Canada – before the next scheduled service.

The computer bases its calculations of the remaining distance on the preceding driving style.

Check Control

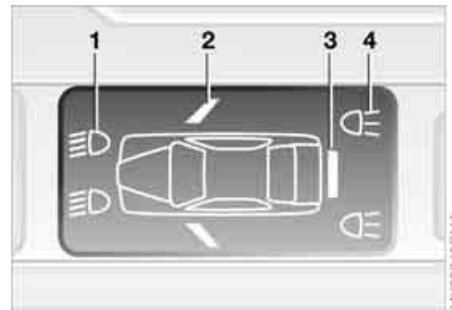

Display

When the ignition key is in position 2, the following information and/or conditions are indicated using symbols until the conditions have been corrected.

- 1 Check the low and high beams as well as the parking lamps
- 2 Door open
- 3 Luggage compartment lid open
- 4 Check tail or brake lamps

When you open the driver's door after having turned the ignition key to position 0, you will hear an acoustic signal for a few seconds to remind you that the lamps have not been switched off.

Clock

If you wish to have a permanent time display, you can make this setting in the radio display, refer to the Owner's Manual for Radio.

You can set the clock and the time display in the car radio as follows.



Every time you press the button, the clock display alternates between the 12-hour and 24-hour mode.

In ignition key position 0: the time is displayed for a few seconds after you press the left button, refer to Odometer on page 86.

Setting

 Before the clock can be set, the time must be showing in the instrument cluster display. ◀

With the ignition key in position 1 or higher

To set ahead: turn the right button to the right.

To set back: turn the right button to the left.

The adjustment speed will increase the longer you continue to hold the right button.

To change the display mode: press the right button briefly.

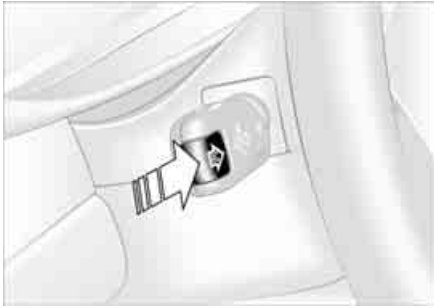

After giving an ice warning, the display returns to the previous setting. ◀



The ice warning does not alter the fact that surface ice can form at temperatures above 37.5 °F/+3 °C, on bridges or shaded road surfaces, for instance. ◀

Mode selection

With the ignition key in position 1 or higher, you can call up information from the computer using the button in the turn signal lever. The information is displayed in the instrument cluster. Each time you press the button briefly toward the steering column, a new function is called up in the display.

The displays appear in the following order:

Time of day, outside temperature, average fuel consumption, cruising range, average vehicle speed.

When the ignition key is turned to position 1 or higher, the last active setting is displayed.

Outside temperature

You can change the units of measure, °C/°F, for the outside temperature display by pressing the right-hand reset button in the instrument cluster while the temperature display is active. The units of measure, °C/°F, in the temperature display of the automatic climate control change automatically, refer to page 106.

Ice warning

If the outside temperature drops to about 37.5 °F/+3 °C, then the computer will automatically switch to a display of the outside temperature. In addition, a signal sounds as a warning and the display flashes for a brief period.

Computer



It is important that you refuel when the cruising range falls below approx. 35 miles / 50 kilometers. Otherwise, the engine cannot be guaranteed to operate properly and damage may result. ◀

Average speed

If you continue to press and hold the button on the turn signal lever, the average speed being displayed is recalculated from that point in time.

Any time spent when the vehicle is stationary and the engine is switched off is ignored for the calculation.

Average fuel consumption

If you continue to press and hold the button on the turn signal lever, the average fuel consumption being displayed is recalculated from that point in time.



If you wish, you can have the average fuel consumption displayed in a different unit of measure. ◀

Range

The computer bases its calculations for the cruising range on the operating conditions in the preceding period and on the remaining fuel in the tank.

The concept

PDC assists you when you back into a parking space. Acoustic signals alert you to the momentary distance to an object behind your vehicle. The system features four ultrasonic sensors mounted in your rear bumper. The monitoring range for the two corner sensors extends outward roughly 2 ft/60 cm, while two centrally located sensors detect objects at distances of up to approx. 5 ft/1.50 m.

 PDC is a parking aid that can identify objects if they are approached slowly, as is generally the case when parking. Avoid driving towards objects rapidly; due to underlying physical principles, the system may otherwise alert you too late for you to take evasive steps. ◀

The system starts to operate automatically approx. one second after you shift into Reverse or move the selector lever into the R position with the ignition key in position 2.

 Let this short period elapse before driving backwards. ◀

PDC is deactivated when you shift back out of Reverse.



You can have a signal set to confirm that the PDC has been activated. The signal then sounds when you shift into Reverse or move the selector lever into the R position. ◀

Acoustic signals

The distance to the nearest object is indicated by a tone sounding at various intervals. As the distance between vehicle and object decreases, the intervals between the tones become shorter. A continuous tone indicates the presence of an object less than 1 ft/30 cm away.

The warning signal is canceled after approx. three seconds if the distance to the object remains constant during this time – if you are moving parallel to a wall, for instance.

System malfunctions will be indicated by a continuous high-pitched tone when the system is activated the first time. Please have the problem fixed by your BMW center.



PDC does not replace the driver's personal responsibility for evaluating the distance between the vehicle and any objects. Always remember that the sensors can neither detect nor provide warnings of obstacles located within their blind angles. This applies especially in those cases where the system approaches the physical limits of ultrasonic measurement, as occurs with tow bars and trailer couplings, and in the vicinity of thin or wedge-shaped objects. Moreover, low objects that have already been detected – such as a curb edge – can disappear out of the detection range of the sensors before a continuous tone sounds.

Loud sources of sound from outside or inside the vehicle could drown out the PDC signal tone. ◀



Keep the sensors clean and free of ice or snow in order to ensure that they will continue to operate effectively.

Do not apply high pressure spray to the sensors for a prolonged period of time. Always maintain a distance of more than 4 in/10 cm. ◀

Dynamic Stability Control (DSC)

The concept

DSC maintains vehicle stability, even in critical driving situations.

DSC is operational every time you start the engine.

DSC contains the Dynamic Traction Control (DTC) and Cornering Brake Control (CBC) functions.

The vehicle will remain completely operational, however, without DSC. In the event of a fault, please consult your BMW center.



Indicator and warning lamps for Canadian models.



Indicator lamps



The indicator lamp in the instrument cluster goes out shortly after you switch on the ignition, refer to page 19.

- ▷ The indicator lamp flashes: DSC is actively controlling drive torque and braking intervention
- ▷ The indicator lamp stays lit: DSC has been switched off with the button; DTC and DBC are operational. DTC control intervention is not indicated.



The indicator lamp and the brake warning lamp continuously light up in yellow:

BRAKE

The DSC, DTC and DBC have been switched off manually or there is a system malfunction.



Deactivating the DSC/activating the DTC

Press the DSC button briefly; the indicator lamp comes on and stays on. DSC is deactivated; DTC is operational.

In the following rare situations, it may prove useful to activate the DTC for a brief period:

- ▷ When rocking the vehicle or starting off in deep snow or on loose surfaces
- ▷ When driving with snow chains
- ▷ When driving on snow-covered grades, in deep snow, or on a snow-covered surface that has been packed down from being driven on.

Under these special circumstances traction is increased by deactivating the control systems that enhance traction under normal conditions.

Deactivating the DSC and the DTC

Hold the DSC button down for at least 3 seconds. The indicator lamp and the yellow brake warning lamp light up and remain on continuously.

The systems for enhancing stability and traction are deactivated, and there is no active braking intervention or torque control.



To maintain vehicle stability, always drive with the DSC activated whenever possible. ◀

Reactivating the DSC

Press the button again; the indicator lamp or the indicator lamps will go out. DTC is deactivated.



The laws of physics cannot be repealed even with DSC. An appropriate driving style always remains the responsibility of the driver. We therefore urge you to avoid using the additional safety margin of the system as an excuse for taking risks. Whenever the DTC is activated, the DSC is switched off and performs minor stabilizing intervention. Do not make any modifications to the DSC system. Allow only authorized technicians to perform service procedures on the DSC. ◀

Flat Tire Monitor*

The concept

As you drive, the Flat Tire Monitor keeps track of pressure levels in all four tires. The system alerts you whenever the inflation pressure of a tire falls significantly below the pressure of another tire.

The system actually detects pressure loss by monitoring differences in the relative speeds of the four wheels. It interprets variations outside specified limits as severe pressure loss, and then responds by generating a warning.

Functional requirements

In order for the Flat Tire Monitor to learn the correct tire inflation pressure, please do the following:

1. Check the tire inflation pressures in all tires
2. Compare them with the tire inflation pressure table on page 25 and correct them, if necessary
3. Initialize the system.

Flat Tire Monitor*

System limitations

 The Flat Tire Monitor cannot provide you with advance warning of sudden and severe tire damage caused by external factors and does not detect the balanced and very gradual pressure loss that takes place in all four tires over an extended period of time. ◀

On the other hand, the following situations can lead to a delayed detection of pressure loss and even to the system not functioning:

- ▷ Driving on snow-covered or slippery roads
- ▷ Performance-oriented driving: slip at the drive wheels, high levels of lateral acceleration
- ▷ When driving with snow chains, false warnings and undetected pressure losses may occur
- ▷ When driving with a space-saver spare tire, the Flat Tire Monitor cannot function.



Initializing the system

 Each time you correct the pressure in a tire, or change a wheel or tire, reinitialize the system immediately afterwards. This requires a bit of driving. ◀

1. Before driving off, start the engine but do not start driving
2. Press the button as long as you need to until the yellow indicator lamp in the instrument cluster lights up for a few seconds
3. Drive off.

It takes a few minutes before the Flat Tire Monitor can detect a flat tire and issue a warning.

 When driving with snow chains or a space-saver spare tire, do not initialize the system. ◀

Flat tire

 The indicator lamp in the instrument cluster lights up red. This visual alert is accompanied by an acoustic warning signal.

1. Carefully reduce speed and come to a stop. Avoid sudden braking and steering maneuvers
 2. Determine which wheel is damaged
-  If this cannot be determined, contact your BMW center. ◀

3. Replace the damaged wheel, refer to Changing a wheel on page 153.

After replacing the damaged tire, initialize the system.

Vehicles with Run Flat tires:

1. Carefully reduce your speed to under 50 mph / 80 km/h. Avoid sudden braking and steering maneuvers. Do not exceed a speed of 50 mph / 80 km/h



Because the sides of Run Flat tires are reinforced, a drop in inflation pressure usually cannot be detected from the outside, refer to Run Flat tires, page 156. ◀

2. To continue driving, follow the instructions under Driving with a damaged tire on page 157.

System malfunction



The indicator lamp in the instrument cluster lights up yellow. The Flat Tire Monitor is malfunctioning or out of order. Please refer the problem to your BMW center.

Brake force display

The brake force display indicates to the driver of the vehicle behind you how hard you are braking your vehicle.

The display has two levels:

- ▷ Normal braking: the brake lamps among the rear lamps and the center brake lamp light up
- ▷ Hard braking or use of ABS: the tail lamps light up with the same brightness as the brake lamps and thereby intensify the visual effect of the brake lamps.

Parking lamps/Low beams

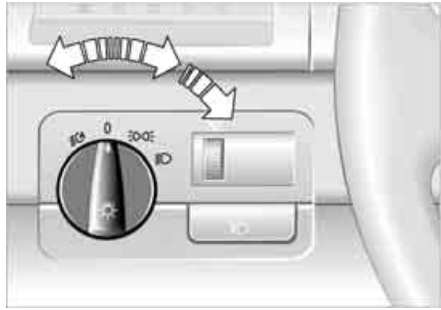

Parking lamps

 The front, rear and side vehicle lighting is switched on. You can use the parking lamps to signal the position of the vehicle when it is parked. For lighting on one side for parking as an additional feature, refer to page 99.

Low beams

 When the ignition is switched off while the low beams are on, the headlamps go out and only the parking lamps remain on.

Follow me home lamps

When you activate the headlamp flasher after parking the vehicle with the lamps turned off, the low-beam headlamps will come on for a short time.



You can also have this function deactivated. ◀

LIGHTS ON warning

When you open the driver's door after having turned the ignition key to position 0, you will hear an acoustic signal for a few seconds to remind you that the lamps have not been switched off.

Daytime driving lamps*

If you desire, the light switch can be left in the second position: when the ignition is switched off, the external lighting is also switched off.



You can have the activation settings for the daytime driving lamps programmed on your vehicle. ◀

Automatic headlamp control*

 When the switch is set to this position the system automatically activates and cancels the low beams in response to changes in

ambient light – in tunnels, at dusk, etc. – and in the event of rain and snow. If the low-beam headlamps are on, the LED next to the symbol lights up.



The vehicle's external lights remain on constantly when you switch on the front fog lamps after the headlamps have come on automatically. ◀



Automatic headlamp control cannot serve as a substitute for the driver's judgement in determining when the vehicle lights should be switched on. For example, the sensors are not able to detect fog. To avoid safety risks, you should respond to these kinds of low-visibility situations by switching the headlamps on manually. ◀



You can have the sensitivity of your vehicle's automatic headlamp control adjusted. ◀

The concept

Adaptive headlights is a variable headlamp control system for dynamically illuminating the road. Depending on the steering angle and other factors the light from the headlamps follows the course of the road.

Activating Adaptive headlights

With the ignition key in position 2, turn the light switch to the automatic headlamp control position, refer to page 97.



Adaptive headlights is not active while reversing, and only in one direction while at a standstill. ◀

System malfunction

The LED above the symbol for the automatic headlamp control flashes, refer to page 97. Please have the system inspected at your BMW center.

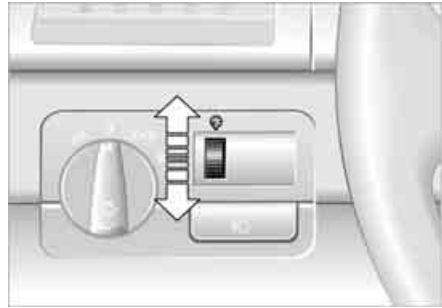

Turn the rotary dial with the parking/low beam lamps on to adjust the illumination intensity.

High beams/Standing lamps

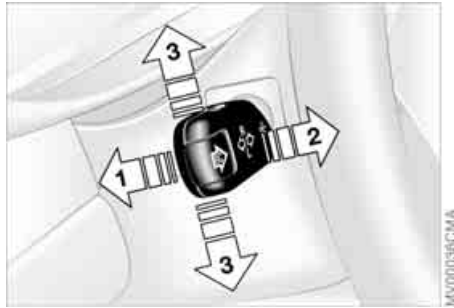

- 1 High beams – blue indicator lamp
- 2 Headlamp flasher – blue indicator lamp
- 3 Standing lamps

Standing lamps, left or right

As an additional feature, you can illuminate your vehicle on either side for parking:

With the ignition key in position 0, engage the lever in the appropriate turn-signal position.

Fog lamps

99



Front fog lamps



The green indicator lamp in the instrument cluster lights up to indicate that the front fog lamps are on.



If the automatic headlamp control is on, the low beams will come on automatically whenever you activate the front fog lamps. ◀

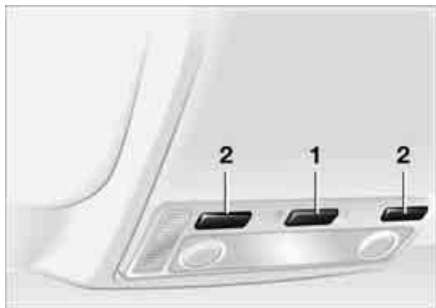

The interior lamps operate automatically.

To switch the interior lamps on and off manually

Press button 1 briefly:

If you want the interior lamps to remain off all the time, press and hold the button for approx. 3 seconds.

Press the button briefly to revert to normal operation.

Front reading lamps*

Switch on and off with the button 2 adjacent to each lamp.



Rear reading lamps*

Rear reading lamps are also provided for rear seat passengers when the hardtop is installed, refer to page 127. Switch on and off with the button adjacent to each lamp.

 In order to prevent battery discharge, all of the lamps in the vehicle are automatically switched off approx. 15 minutes after you turn the ignition key to position 0. ◀

Light-emitting diodes

Light-emitting diodes (LEDs) installed behind translucent lenses serve as the light sources for many of the controls and displays in your vehicle. These light-emitting diodes are related to conventional lasers, and legislation defines them as light-emitting diodes, Class 1.



Do not remove the protective lens and avoid staring directly at the unfiltered beam for several hours, as inflammation of the retina could result. ◀

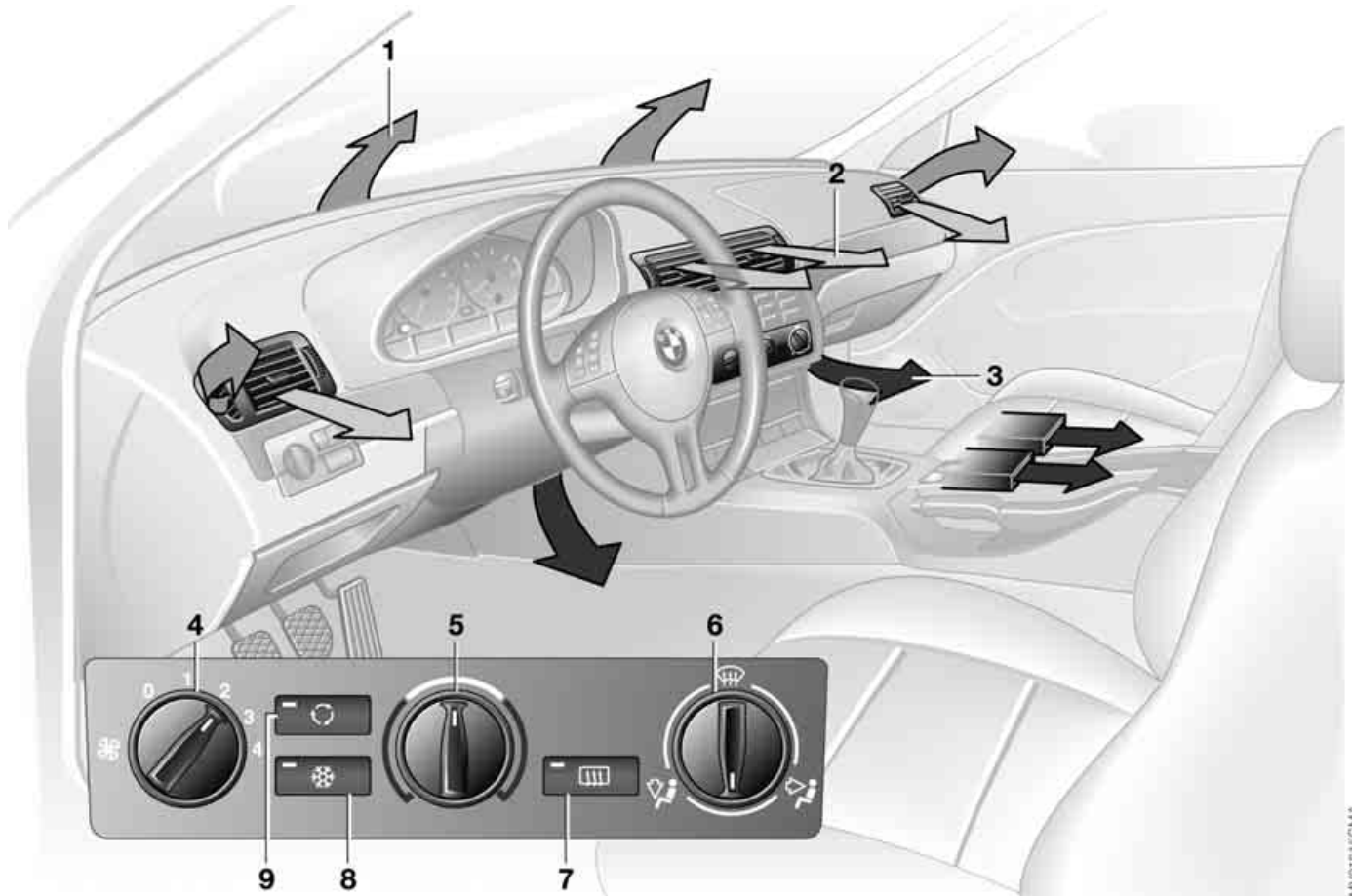

Air conditioning

- 1 Air onto the windshield and the side windows
- 2 Air for the upper body area [105](#)
- 3 Air to the footwell
- 4 Air supply/Blower [104](#)
- 5 Temperature [104](#)
- 6 Air distribution [104](#)
- 7 Rear window defroster [104](#)
- 8 Air conditioning [104](#)
- 9 Outside air/Recirculated-air mode [104](#)





Air supply/Blower

You can select blower speeds from 1 to 4. The heating and ventilation become more and more effective as the air supply settings are increased. In position 0, the blower and the heater are switched off. The outside air supply is blocked in position 0.

Temperature

In order to increase the temperature of the passenger compartment, turn to the right toward the red zone. The temperature of the incoming air is kept constant.

Air distribution

You can direct air to flow onto the windows , toward your upper body  or into the footwell . All intermediate settings are possible. In the setting , there is a low flow of air onto the windows to keep them free of condensation.

Rear window defroster

When the rear window defroster is activated, the indicator lamp comes on. The rear window defroster switches off automatically.



You can have your vehicle programmed in such a way that the rear window defroster switches on automatically. This occurs within 5 minutes after starting the engine when outside temperatures are below approx. 39 °F/+4 °C. ◀

Air conditioning

The air is cooled and dehumidified and – depending on the temperature setting – rewarmed.

Depending on the weather, the windshield may fog over briefly when the engine is started. Air conditioning helps prevent the windows from fogging up.



Condensation forms during operation of the air conditioning system, which then exits under the vehicle. It is thus not unusual for a small puddle to form under the car while the system is running. ◀

Outside air/Recirculated-air mode

You can respond to unpleasant external odors by temporarily blocking the supply of outside air. The system then recirculates the air currently within the vehicle.



If the windows should fog over in the recirculated-air mode, switch this mode off and increase the air supply as required. ◀

Air conditioning

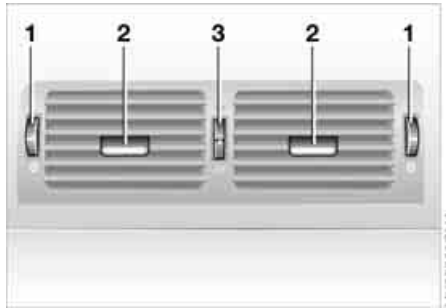

Microfilter

The built-in microfilter removes dust and pollen from the incoming air. Your BMW center will replace it during routine maintenance. A substantial reduction in airflow indicates that the filter needs to be replaced before scheduled maintenance.

Draft-free ventilation

You can adjust the blower controls for the upper body area to obtain the optimum airflow rates and directions for your personal requirements:

- 1 Rotary dials for infinitely variable opening and closing of the vent outlets
- 2 Levers for airflow direction
- 3 Rotary dial 3 allows you to control the temperature of the airflow from these outlets as desired



To defrost windows and remove condensation

1. Set the blower speed control for the airflow rate to position 4
2. Turn the rotary temperature control completely to the right, toward the red zone
3. Turn to the rotary control for air distribution to position 
4. Switch on the rear window defroster to defrost the rear window.

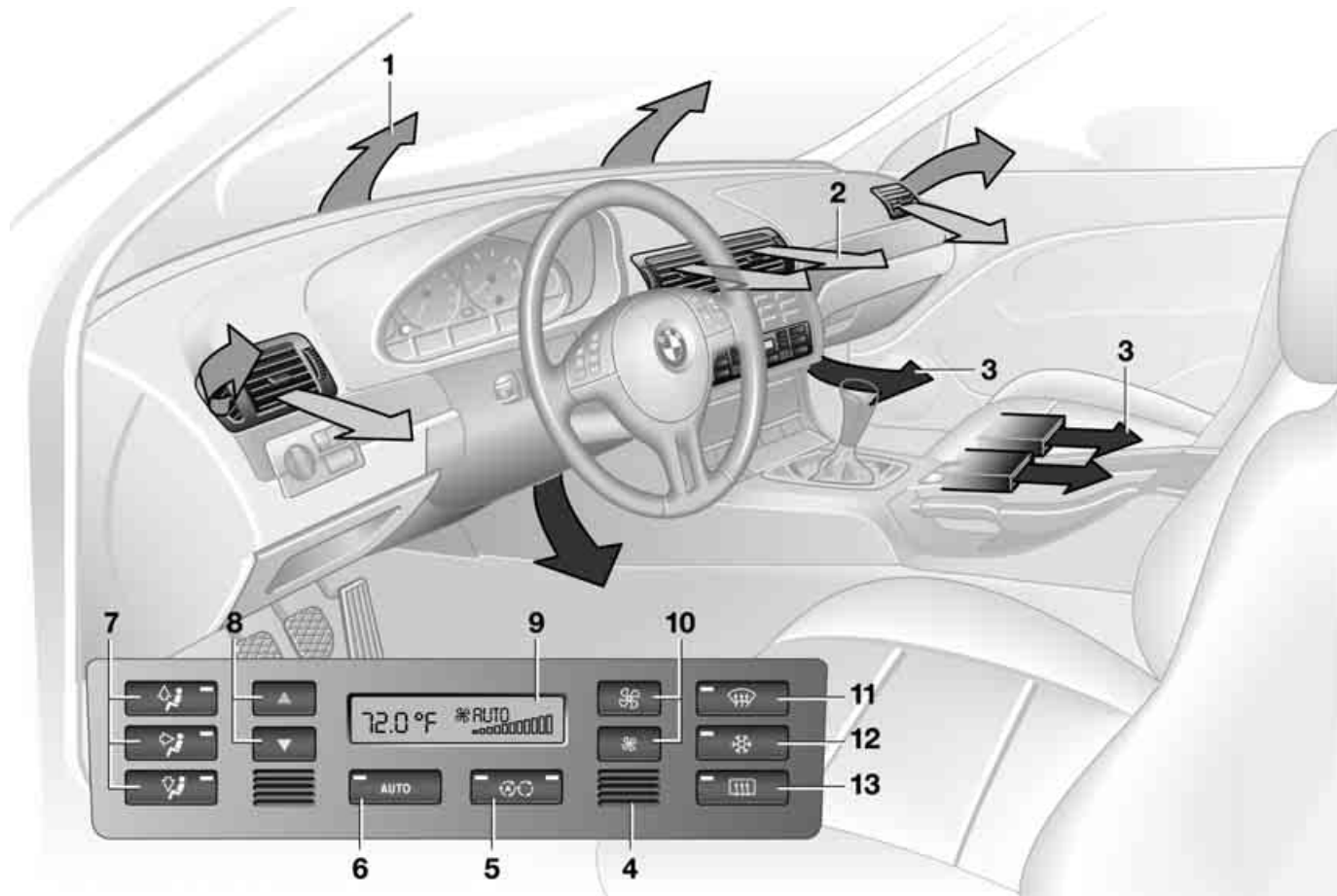

- 1 Air onto the windshield and the side windows
- 2 Air for the upper body area [109](#)
- 3 Air to the footwell
- 4 Air inlet for interior temperature sensor – please keep clear and unobstructed
- 5 Outside air/Automatic recirculated-air control (AUC)/Recirculated air [109](#)
- 6 Automatic air distribution and supply [108](#)
- 7 Individual air distribution [108](#)
- 8 Temperature [108](#)
- 9 Display for temperature [108](#) and air supply [108](#)
- 10 Air supply/Blower [108](#)
- 11 To defrost windows and remove condensation [108](#)
- 12 Air conditioning [108](#)
- 13 Rear window defroster [109](#)

Tips for pleasant driving

Use the automatic mode – switch on with AUTO button 6. Select the desired interior temperature.

Detailed setting options are described for you in the following section.





You can make the settings of your vehicle in such a manner that, when you unlock the vehicle with the remote control of your personal key, your own personalized setting for the automatic climate control is initiated. ◀

Automatic air distribution and supply

The AUTO program adjusts the air distribution and the air supply for you and in addition adapts the temperature to external influences – summer, winter – to meet preferences you can specify.

Individual air distribution

You can cancel the AUTO program by selecting specific distribution patterns to suit your own individual requirements. While the AUTO program is then deactivated, the automatic airflow control remains in operation. Air flows onto

the windows , toward the upper body , and into the footwell . You can reactivate the automatic air distribution mode by selecting the AUTO button.

Temperature

The interior temperature that appears in the display panel is a general figure intended for reference purposes. We recommend 72 °F / +22 °C as a comfortable setting, even if the air conditioning is on. When you start the vehicle, the system ensures that the selected temperature is achieved as quickly as possible. It then maintains this temperature, regardless of the season.

To select the units of measure °C/°F of the display, refer to page 90.

Air supply/Blower

By pressing the upper or lower button, you can vary the air supply. This deactivates the automatic control of the air supply, AUTO disappears from the display panel. Nevertheless, the automatic air distribution remains unchanged. You can reactivate the automatic air distribution mode by selecting the AUTO button.

When the lowest blower speed is set and you press the lower button, all of the displays are canceled: the blower, heating and air conditioning are switched off. The outside air supply is blocked. You can reactivate the system by pressing any button for the automatic climate control.

To defrost windows and remove condensation

This program quickly removes ice and condensation from the windshield and the side windows.

Air conditioning

The air is cooled and dehumidified and – depending on the temperature setting – rewarmed.

Depending on the weather, the windshield may fog over briefly when the engine is started. Air conditioning helps prevent the windows from fogging up.



Condensation forms during operation of the air conditioning system, which then exits under the vehicle. It is thus not unusual for a small puddle to form under the car while the system is running. ◀

Automatic climate control*

Outside air/Automatic recirculated-air control (AUC)/ Recirculated air



You can respond to unpleasant external odors or pollutants by temporarily stopping the flow of outside air. The system then recirculates the air currently within the vehicle.

Press the button repeatedly to select one of three different operating modes.

- ▷ Indicator lamps off: outside airflow is on
- ▷ Left indicator lamp on – automatic mode: the system recognizes pollutants in the outside air and blocks the flow of air when necessary. The system then recirculates the air currently within the vehicle. Depending on the air quality, the automatic system then switches back and forth between outside air supply and recirculation of the air within the vehicle
- ▷ Right indicator lamp on: the flow of outside air into the vehicle is permanently blocked. The system then recirculates the air currently within the vehicle.



If the windows should fog over in the recirculated-air mode, switch this mode off and increase the air supply as required. ◀

Rear window defroster



With the convertible top closed or with the hardtop* mounted, press the button. The indicator lamp comes on. The rear window defroster switches off automatically.



You can have your vehicle programmed in such a way that the rear window defroster switches on automatically. This occurs within 5 minutes after starting the engine when outside temperatures are below approx. 39 °F / +4 °C. ◀

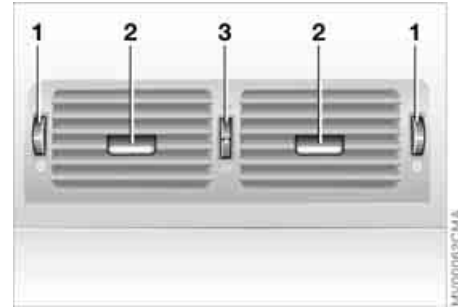

Draft-free ventilation

You can adjust the blower controls for the upper body area to obtain the optimum airflow rates and directions for your personal requirements:

- 1 Rotary dials for infinitely variable opening and closing of the vent outlets
- 2 Levers for airflow direction
- 3 Use the rotary dial to control the temperature of the airflow:
 - ▷ Rotate toward blue – colder
 - ▷ Turn toward red – warmer

Microfilter/activated-charcoal filter

The built-in microfilter removes dust and pollen from the incoming air. The activated-charcoal filter provides additional protection by filtering gaseous pollutants from the outside air. Your BMW center replaces this combined filter as a standard part of your scheduled maintenance. A substantial reduction in airflow indicates that the filter needs to be replaced before scheduled maintenance.

Glove compartment

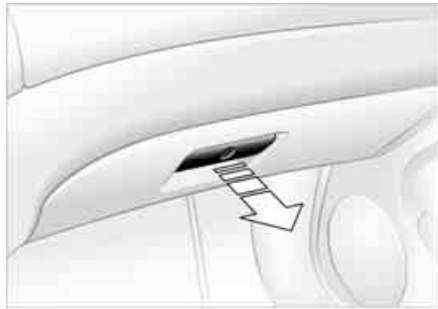

To open

Pull the handle. The lamp in the glove compartment comes on.

To close

Fold the cover back up.

 To prevent injury in the event of an accident, close the glove compartment immediately after use. ◀

To lock

Lock with one of the master keys. A master key will also be required to unlock the glove compartment.

 If – for example for valet parking – you turn over only your spare key, refer to page 30, then access to the glove compartment and luggage compartment is not possible. ◀

Rechargeable flashlight

The flashlight is located on the left-hand side of the glove compartment. It features integral overload-protection, so it can be left in its holder continuously.

 To avoid completely discharging and possibly damaging the flashlight, always ensure that it is switched off before inserting it in the socket. ◀

The concept

The integrated universal remote control takes the place of up to three different handheld transmitters belonging to various radio remote control devices, such as door openers and home alarm systems. The integrated universal remote control recognizes and learns the signal sent by each original control device.

The signal of an original control device can be programmed into one of the three memory buttons 1. Afterwards, the programmed memory button 1 can be used to operate the corresponding device. The signal transmission is indicated by the indicator lamp 2.

Before selling the vehicle, clear the memory buttons 1, refer to page 114.



While programming is in progress and before operating any programmed system by remote control using the integrated universal remote control, make sure that the area of movement of the system in question is clear of people, animals and inanimate obstructions, in order to avoid possible injury or damage. Also comply with the safety precautions issued for the original control device. ◀

Checking compatibility

If this symbol is depicted on the packaging or in the operating instructions of the original control device, it is safe to assume that the remote-controlled system is compatible with the integrated universal remote control.



If you have additional questions, please consult your BMW center or call 1-800-355-3515.

You can also visit these websites:
www.bmwusa.com or
www.homelink.com.
 HomeLink is a registered trademark owned by Johnson Controls, Inc. ◀

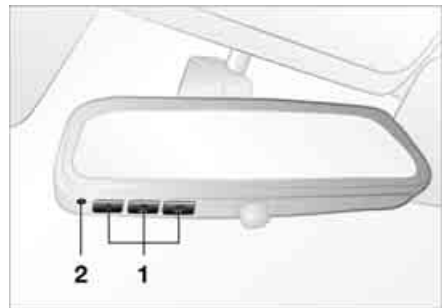

- 1 Memory buttons
- 2 Indicator lamp

Programming a fixed-code control device

Fixed-code control device

1. Turn the ignition key to position 2
2. Initial operation: press and hold down both outer buttons 1 for approx. 20 seconds until the indicator lamp 2 flashes. The three memory buttons 1 are cleared

Integrated universal remote control*

3. Hold the original control device approx. 2 to 8 in / 5 to 20 cm away from memory buttons 1.

 The required distance between the control device and the memory buttons 1 may vary, depending on the system of the original control device in question. ◀

4. Simultaneously press the command button of the original control device and the desired memory button 1 on the integrated universal remote control. Indicator lamp 2 starts to flash slowly. When indicator lamp 2 flashes rapidly, release both buttons. If the indicator lamp 2 does not flash rapidly after approx. 15 seconds, select a different distance between the two devices
5. To program other original control devices, repeat steps 3 and 4.

The corresponding memory button 1 is now programmed with the signal of the original control device.

The system can be operated from ignition key position 2.

 If the system cannot be operated after repeated attempts at programming, check whether the original control device is equipped with an alternating-code system. You can either check the operating instructions of the original control device for this information, or you can press and hold down the programmed memory button 1 of the integrated universal remote control. If indicator lamp 2 of the integrated universal remote control flashes rapidly for a brief period and then remains on for approx. 2 seconds, the original control device is equipped with an alternating-code system. In this case, you have to program the memory buttons 1 as described below for an alternating-code control device. ◀

Programming an alternating-code control device

You will need to follow the operating instructions of the system in question in order to program the integrated universal remote control. Read through the operating instructions for information

on synchronization. Comply with the following additional instructions when you program an alternating-code control device:

 You will find programming easier if you have the assistance of another person. ◀

1. Park the vehicle within range of the radio remote controlled device
2. Program the integrated universal remote control as described above in the section on fixed-code programming
3. Locate the button on the receiver of the target device, for example on the drive
4. Press the button on the receiver of the target device. Once you have completed step 4, you have approx. 30 seconds to complete step 5
5. Press the programmed memory button 1 of the integrated universal remote control three times.

The corresponding memory button 1 is now programmed with the signal of the original control device.

 Please contact your BMW center if you have any questions. ◀

114 Integrated universal remote control*

Deleting memory buttons

Press and hold down both outer buttons 1 of the integrated universal remote control for approx. 20 seconds until the indicator lamp 2 flashes: All three memory buttons are cleared.

It is not possible to delete individual memory buttons 1.

Storage compartments

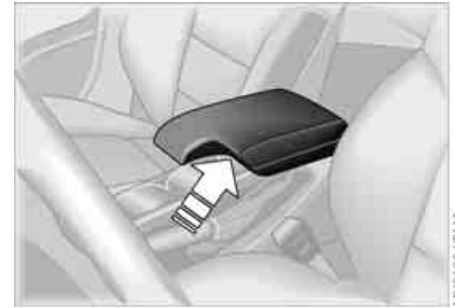

Front center armrest

To open: press the button and fold up.

Additional compartments and nets*

You will find additional storage compartments in the front doors and in the center console. Storage nets are on the front seat backrests.

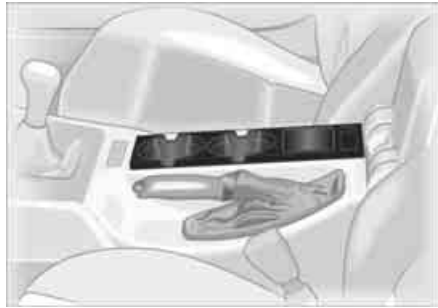

Beverage holders, coin box

A coin box and two beverage holders are provided in the center console.



Hands-free system

On vehicles that are wired for a telephone* or equipped with a communications package*, the cover for the hands-free microphone is located in the headliner near the interior lamp.

For further information on using your cellular phone, refer to the separate Owner's Manual.

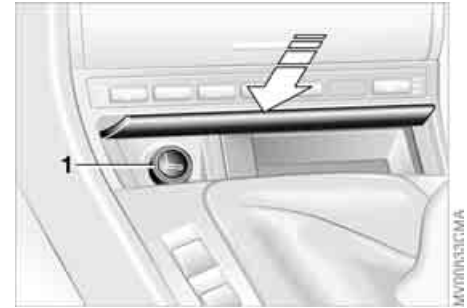

To empty

Press on the edge of the open cover. The ashtray moves up and can be removed.

Cigarette lighter

 Hold or touch the hot cigarette lighter by the knob only. Holding or touching it in other areas could result in burns.

The cigarette lighter remains operational when the ignition key has been removed. For this reason, children should never be left in the vehicle unattended. ◀

Press the lighter 1 in. You can remove the lighter from its socket for use as soon as it springs back out.

116 **Ashtray, front***

Cigarette lighter socket

Suitable for attaching power supplies for flashlights, car vacuum cleaners, etc., up to a rating of approx. 200 watts at 12 volts. Avoid damage to the socket caused by inserting plugs of different shapes or sizes.

Ashtray, rear*



To empty

Press on the edge of the open cover in the opening direction. The ashtray moves up and can be removed.

Ski bag*

The ski bag allows the safe and clean transport of up to 4 pairs of standard skis or up to two snowboards.

The length of the ski bag and the additional space provided in the luggage compartment make it possible to carry skis up to 6 ft 10 in / 2.10 m long. Because of the tapered shape of the bag, only two pairs of skis longer than 6 ft 10 in / 2.10 m can be carried.

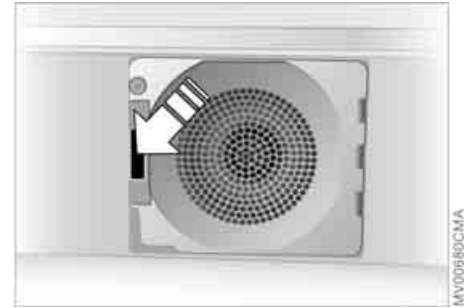
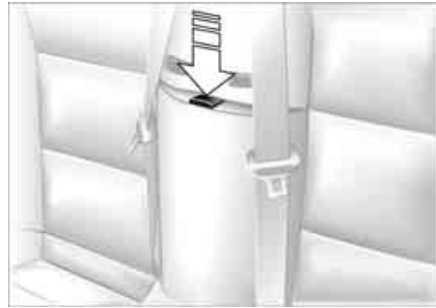

Loading

1. Take the safety belts out of their holders
2. Press button downward and remove the filler piece by pulling it forward
3. Extend the ski bag between the front seats. The zipper provides convenient access to stored items. It may be opened to allow the ski bag to dry

4. Press the button in the luggage compartment
5. Use the magnetic holder to fasten the cover panel to the back wall.

To store the ski bag, perform the above steps in reverse sequence.

Securing cargo

 Secure skis and any other objects stored in the bag by tightening the retaining strap at the buckle. ◀

 Be sure that your skis are clean before loading them into the bag. Avoid damage from sharp edges during loading. ◀

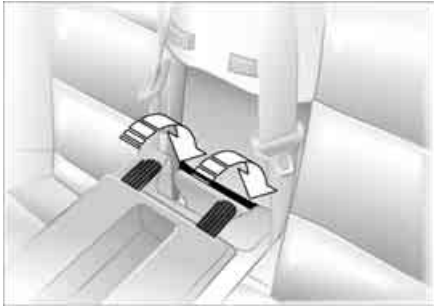

MV000346CMA

▶ When reattaching the cover, guide both bars into the guide and press the cover back into place. Secure the safety belts in their holders again. ◀

Cargo loading

⚠ Avoid overloading the vehicle so that the permitted load on the tires is not exceeded. Overloading can lead to overheating and internal tire damage. The ultimate result can assume the form of a sudden air loss. ◀

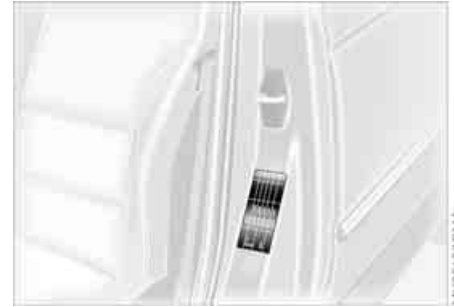

MV000129CMA

Determining the maximum load

1. Locate the following statement on your vehicle's placard*:
 - ⚠ The combined weight of occupants and cargo should never exceed XXX kg or YYY lbs., as this could otherwise result in damage to the vehicle or unstable driving conditions. ◀
2. Determine the combined weight of the driver and passengers that will be riding in your vehicle
3. Subtract the combined weight of the driver and passengers from XXX kilograms or YYY pounds

Cargo loading

4. The resulting figure equals the available amount of cargo and luggage load capacity.
For example, if the XXX amount equals 1,400 lbs. and there will be five 150 lbs. passengers in your vehicle, the amount of available cargo and luggage load capacity is 650 lbs.:
 $1,400 \text{ lbs.} - 750 \text{ lbs.} = 650 \text{ lbs.}$
5. Determine the combined weight of luggage and cargo being loaded on the vehicle. That weight may not safely exceed the available cargo and luggage load capacity calculated in Step 4
6. If your vehicle will be towing a trailer, load from your trailer will be transferred to your vehicle. Consult the manual for transporting a trailer to determine how this may reduce the available cargo and luggage load capacity of your vehicle.

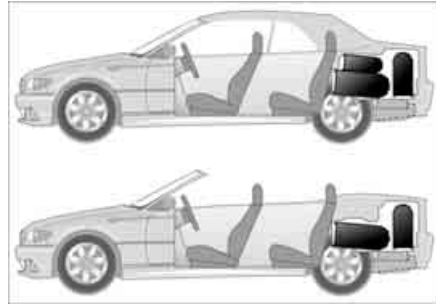

Stowing cargo

- ▷ Load heavy cargo as far forward as possible – directly behind the luggage compartment partition – and as low as possible
- ▷ Cover sharp edges and corners.

▶ With the convertible top closed, you can increase the space in the luggage compartment – refer to page 37 – by folding back the convertible top compartment panel.

We recommend that you always fold the convertible top compartment panel down as soon as you have removed your cargo from the luggage compartment. This way, you can be sure that you can always operate your convertible top at any time.

At the same time, when the top is raised you should fold the convertible top compartment panel back up before stowing large objects in the luggage compartment; this precaution will help reduce the likelihood of damage to either the convertible top compartment or your luggage. ◀

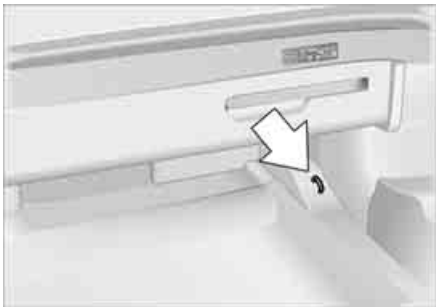

Securing cargo

- ▷ For small, light items, use the rubber-lined, non-skid side of the floor mat or secure using the luggage compartment net* or elastic straps
- ▷ For large, heavy pieces, see your BMW center for load-securing devices*. Anchorages located in the luggage compartment can be used for fastening the load-securing devices.

Read and comply with the information enclosed with the load-securing devices.

 Always position and secure loads correctly. If you do not, the load can endanger the passengers during braking or evasive maneuvers. Do not exceed the approved gross vehicle weight or the approved axle loads, refer to page 168, otherwise the vehicle's operating safety is no longer assured and the vehicle will not be in compliance with the certification regulations.

Do not stow heavy or hard objects in the passenger compartment without securing them. Otherwise they could be thrown around during braking and evasive maneuvers and could endanger the passengers. ◀

Roof-mounted luggage rack for the hardtop*

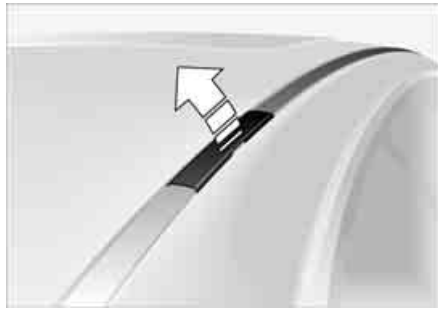

A special roof-rack system is available as an optional extra for your BMW. Please observe the precautions included with the installation instructions.

Anchorage

Access to the anchorages:

To fold up the covers, please use the tool provided with the roof-rack system.

Loading and driving notes

Roof-mounted luggage racks raise the center of gravity of the vehicle when they are loaded. For this reason, they exercise a major effect on the vehicle's handling and steering response.

You should therefore always remember not to exceed the approved roof load capacity, the approved gross vehicle weight or the maximum axle loads when loading the rack. These weights are listed under Technical data on page 168.

Make sure that the load is not too bulky, and attempt to distribute it evenly. Always load the heaviest pieces first so that they are at the bottom. Make sure that no objects will be in the way when the luggage compartment lid is opening or closing.

Secure the roof-mounted luggage correctly and securely to prevent it from shifting or being lost during driving.

Drive smoothly and avoid sudden acceleration or braking. Do not corner at high speeds.

The roof-mounted luggage rack and the roof load increase the aerodynamic resistance: increased fuel consumption and additional stress on the vehicle's body are the result.



Overview

Controls and features

Operation, maintenance

Owner service procedures

Technical data

Index



Overview

Controls

Maintenance

Repairs

Data

Index

To ensure that your vehicle continues to provide maximum economy throughout an extended service life, we request that you devote careful attention to the following instructions.

Engine and differential

The first 1,250 miles/2,000 km:

Constantly vary both vehicle and engine speeds, remembering not to exceed 4,500 rpm or vehicle speeds of over 100 mph / 160 km/h:

Always obey all official speed limits.

Do not use full throttle, and avoid pressing the accelerator beyond the kickdown point during these initial miles.

You can then proceed to increase engine or vehicle speeds once the initial 1,250 miles/2,000 km have elapsed. Please remember to observe the same break-in procedures if either the engine or the differential should have to be replaced later in the course of the vehicle's service life.

Tires

Owing to technical factors associated with their manufacture, tires do not achieve their full traction potential until an initial break-in period has elapsed. We thus ask you to drive with extra care during the first 200 miles/300 km.

Always obey all official speed limits.



When the vehicle is operated on wet or slushy roads, a wedge of water may form between the tire and the road surface. This phenomenon is referred to as hydroplaning, and can lead to partial or complete loss of traction, vehicle control and braking effectiveness. Reduce your speed on wet roads. ◀

Brake system

Approx. 300 miles/500 km must elapse before the brake pads and rotors achieve the optimal pad-surface and wear patterns required for trouble-free operation and an extended service life later on.

To break in the separate parking brake drums, apply the parking brake lightly when coasting to a standstill – at a traffic signal, for instance; use caution to avoid posing a danger to other road users.

You can prevent corrosion in the drums by periodically repeating this procedure.



The brake lamps do not come on when the parking brake is set. Vacuum for the brake system servo unit on your BMW is available only when the engine is running. When you move the vehicle with the engine off – when towing, for example – substantially higher levels of pedal force will be required to brake the vehicle. ◀

Clutch

Approx. 300 miles/500 km must elapse before the clutch starts to operate at optimum efficiency. Remember to engage the clutch carefully during this initial period.



Brakes: do not drive with your foot resting on the brake pedal. Even light but consistent pedal pressure can lead to high temperatures, brake wear and possibly even brake failure.

Hydroplaning: when driving on wet or slushy roads, reduce vehicle speed. If you do not, a wedge of water may form between the tires and the road surface. This phenomenon can lead to partial or complete loss of contact between the tires and road surface, as well as loss of vehicle control and braking ability.

Driving through water: do not drive through water on the road if it is deeper than 1 ft/30 cm, and then only at walking speed. Otherwise, the vehicle's engine, the electrical systems and the transmission may be damaged.

Clothes hooks, with hardtop: when hanging clothing from the hooks, be sure that they will not obstruct the driver's vision. Do not hang heavy objects on the hooks. If you do so, they could cause personal injury during braking or evasive maneuvers. ◀

The concept

ABS keeps the wheels from locking during braking, thereby enhancing active driving safety.

Braking with ABS

If you are in a situation that requires full braking, you will exploit the full benefits of ABS system if you apply maximum pedal pressure – panic stop.

Since the vehicle maintains steering responsiveness, you can avoid possible obstacles with a minimum of steering effort, despite the full brake application.

Pulsation at the brake pedal combined with sounds from the hydraulic circuits indicates to the driver that ABS is in its active mode.

Dynamic Brake Control (DBC)

DBC is included in the DSC, refer to page 93. The system responds to sudden, high-intensity applications of force to the brake pedal by automatically braking the vehicle with maximum boost to achieve the shortest possible braking distances during panic stops. This system also exploits the benefits of ABS. Do not reduce the pressure

exerted against the brake pedal until the braking maneuver has been completed. DBC is deactivated when you release the brake pedal.

Cornering Brake Control (CBC)

CBC is an advanced engineering development of ABS. When braking during cornering with high lateral acceleration, or when braking during a lane change, vehicle stability is improved and the steering response is enhanced.

Brake fluid level

If the brake fluid level is too low and brake pedal travel has become longer, there may be a defect in one of the brake system's hydraulic circuits.

 Proceed to the nearest authorized BMW center. It may be necessary to apply higher levels of pressure to the pedal when stopping and braking distances may also be longer. Please remember to adapt your driving style accordingly. ◀

Disc brakes

Limited vehicle use, extended periods with the vehicle parked or in storage, and operating conditions in which braking is restricted to gentle, low-pressure applications will all increase the tendency for corrosion to form on the rotors; this is often accompanied by a simultaneous accumulation of contamination on the brake pads. The pads must exert a certain minimal level of pressure against the rotors for the disc brakes' inherent self-cleaning effect to remain effective.

If the brake rotors are corroded, they will tend to respond to braking with a pulsating effect that even extended brake applications will fail to cure.

When driving in heavy rain and on wet roads it is useful to apply light pressure to the brake pedal every few miles. Monitor traffic conditions to ensure that this maneuver does not pose a hazard to you or to other road users. The heat generated in this process helps dry the pads and rotors to ensure that your brake system will respond with undiminished efficiency when you need it.

When descending steep hills and extended grades, downshift to a gear that will allow you to continue safely with only a minimal amount of braking. By minimizing the loads placed on the brake system, this strategy helps ensure that optimal brake system response will remain available at all times. Use care to avoid exceeding the approved engine-speed range, refer to page 86.



Do not coast with the clutch depressed or with the transmission or selector lever in Neutral. Do not coast with the engine shut off. The engine provides no braking effect when the clutch is depressed and there is no power-assist for braking or steering when the engine is not running. Never allow floor mats, carpets or any other objects to protrude into the area around the accelerator, clutch and brake pedals and obstruct their movement. ◀

Brake pads

For your own safety: use only brake pads that BMW has released for your particular vehicle model. BMW cannot evaluate non-approved brake pads to determine if they are suitable for use, and therefore cannot ensure the operating safety of the vehicle if they are installed. ◀

Portable phone in the vehicle

BMW recommends using mobile communications devices, e.g. portable phones, inside the vehicle with a suitable outside antenna. Otherwise, it cannot be ruled out that the vehicle electronics and portable phone may interfere with each other.

Hardtop*

It is not necessary to remove the fabric top even in the winter, when the hardtop is generally in constant use. But you can also remove it easily at any time. Before the fabric top is stored in the convertible top compartment, it must be absolutely dry in order to avoid water spots and mildew from forming. The hardtop offers reading lamps and clothes hooks that can be used just by pressing. It is also possible to mount a luggage rack on the roof. Please consult your BMW center.

 When hanging clothing from the hooks, be sure that they will not obstruct the driver's vision. Do not hang heavy objects on the hooks. If you do so, they could cause personal injury during braking or evasive maneuvers. ◀

Two people are required for installation or removal. Work with extreme caution in order to avoid paint damage and damage to the body or hardtop.

To facilitate hardtop installation or removal, you can obtain a specially designed hardtop lift* or hardtop rack* at your BMW center.

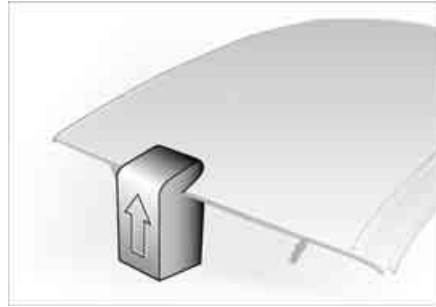

Storage

 Storing the hardtop on the floor: slide the styrofoam block that came with the hardtop onto its center. The arrow on top of the styrofoam block has to be pointing upward when you are doing this. ◀

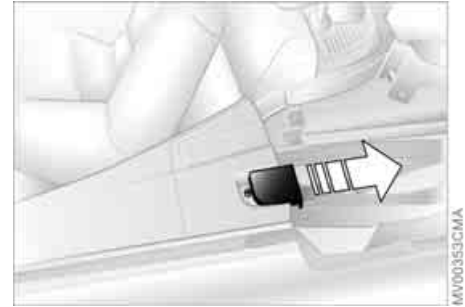

Installation

1. Lower the side windows completely and flip the sun blinds down. If necessary, remove the antenna rod to avoid any damage
2. On vehicles with manual convertible top operation, first release the convertible top compartment lid, and, if necessary, open it somewhat. On vehicles with fully-automatic convertible top operation, open the convertible top compartment lid slightly by pressing the button for the operation of the convertible top
3. Remove the trim pieces on both sides by pulling them off toward the back and reclose the convertible top compartment lid

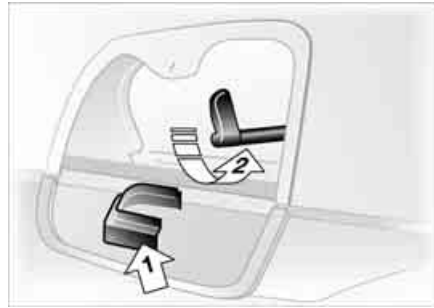
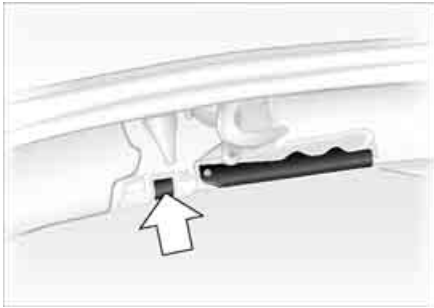

4. Open the two locking levers at the front. Press on the buttons to do so. The levers will release slightly. Open the levers as far as possible

5. Before installing, first flip the cover panels that are located underneath the left and right interior lamps down. To do this, press on the slight bump on the cover panel. There is a holder in the cover panel to securely store the trim pieces that have been removed – see arrow 1

6. Open the red release levers as far as the stop will allow – see arrow 2

7. Position the hardtop onto the supports with the help of a second person. Be sure to put the mountings exactly into the proper brackets

 Lift the hardtop carefully. Be extremely careful not to shift the seals. Seals that have been shifted out of place or actually pulled out cause leaks. ◀

8. In the back, close the red locking levers by turning to the inside as far as the stop located behind the trim will allow. Flip the cover panels back into place

9. To lock the hardtop in the front, keep pressing on the front locking levers until you hear them engage

10. Check the rubber weather-striping between the windshield frame and the hardtop on both the left and right sides. If it is folded or bent out of place, you should smooth it back into position by hand to ensure secure and reliable sealing.

Removal

Follow the same procedure as when installing, just reverse the steps.

Tire inflation pressure

Information for your safety

The factory-approved tires are matched to your vehicle and have been selected to provide optimum safety and driving comfort when used properly.

It is not merely the tire's service life, but also driving comfort and – above all else – driving safety that depend on the condition of the tires and the maintenance of the specified tire inflation pressure.

 Incorrect tire inflation pressure is a frequent cause of tire damage. Tire pressure also has a major effect on your BMW's handling response. Be sure to check the tire inflation pressure, including the space-saver spare tire or the spare tire, on a regular basis, at least twice a month and before every extended journey, refer to page 25. If this is not done, incorrect tire pressures can cause driving instability and tire damage, ultimately resulting in accidents. ◀

Tire condition



wall with TWI – Tread Wear Indicator. At a tread depth of 1/16 in / 1.6 mm, the indicators signal that the legally permissible wear limit has been reached.

Tire tread – tire damage

Inspect your tires frequently for tread wear, signs of damage and for foreign objects lodged in the tread. Check the tread depth.

Tread depth should not be allowed to go below 1/8 in / 3 mm, even though the legally specified minimum tread depth is 1/16 in / 1.6 mm.

Below 1/8 in / 3 mm tread depth, there is a great risk of hydroplaning, even at relatively moderate speeds and with only small amounts of water on the road. Tread wear indicators in the tread-groove base – see arrow – are distributed around the wheel circumference and are labeled on the tire side-



Do not drive on a deflated – flat – tire unless your vehicle is equipped with Run Flat tires. A flat tire greatly impairs steering and braking response, and can lead to complete loss of control over the vehicle. Avoid overloading the vehicle so that the permitted load on the tires is not exceeded. Overloading can lead to overheating and internal tire damage. The ultimate result can assume the form of a sudden air loss. Unusual vibrations encountered during normal vehicle operation can indicate a flat tire or some other vehicle malfunction. This type of problem can be caused by contact with curbs, etc. This is also true for irregularities in the vehicle's handling characteristics, such as a pronounced tendency to pull to the left or right. Should this occur, respond by immediately reducing your speed. Proceed carefully to the nearest BMW center or professional tire center, or have the vehicle towed in to have it, its wheels or its tires inspected. Tire damage up to and including sudden and complete air loss can endanger the lives of both the vehicle occupants and other road users. ◀

Tire replacement

To maintain good handling and vehicle response, use only tires of a single tread configuration from a single manufacturer.

Comply with the specified tire inflation pressures – and be sure to have the wheel and tire assembly balanced every time you change a tire or wheel.

DOT quality grades

Tread wear

Traction AA A B C

Temperature A B C



All passenger car tires must conform to Federal Safety Requirements in addition to these grades. ◀

Tread wear

The tread wear grade is a comparative rating based on the wear rate of the tire when tested under controlled conditions on a specified government test course.

For example, a tire graded 150 would wear one and one-half – $1\frac{1}{2}$ – times as well on the government course as a tire graded 100. The relative performance of tires depends upon the actual conditions of their use, however, and may

depart significantly from the norm due to variations in driving habits, service practices and differences in road characteristics and climate.

Traction

The traction grades, from highest to lowest, are AA, A, B and C.

Those grades represent the tire's ability to stop on wet pavement as measured under controlled conditions on specified government test surfaces of asphalt and concrete. A tire marked C may have poor traction performance.



The traction grade assigned to this tire is based on straight-ahead braking traction tests, and does not include acceleration, cornering, hydroplaning, or peak traction characteristics. ◀

Temperature

The temperature grades are A – the highest – B and C, representing the tire's resistance to the generation of heat and its ability to dissipate heat when tested under controlled conditions on a specified indoor laboratory test wheel.

Tire replacement

Sustained high temperature can cause the material of the tire to degenerate and reduce tire life, and excessive temperature can lead to sudden tire failure. The grade C corresponds to a level of performance which all passenger car tires must meet under the Federal Motor Vehicle Safety Standard No. 109. Grades B and A represent higher levels of performance on the laboratory test wheel than the minimum required by law.

 The temperature grade for this tire is established for a tire that is properly inflated and not overloaded. Excessive speed, underinflation, or excessive loading, either separately or in combination, can cause heat buildup and possible tire failure. ◀

Uniform Tire Quality Grading

Quality grades can be found where applicable on the tire sidewall between tread shoulder and maximum section width. For example:

Tread wear 200
Traction AA
Temperature A



BMW advises against using retreaded tires, since driving safety may be impaired. This is due to the possible variations in casing structures and, in some cases, to their extreme age, which can lead to a decrease in their durability. ◀

Tire age

The date on which the tire was manufactured is indicated by the code on the sidewall:

DOT... 3603 indicates that the tire was manufactured in week 36 of the year 2003.

BMW recommends the replacement of all tires – including the spare tire* – when the tires are no more than 6 years old, even if a tire life of 10 years is possible.

Run Flat tires*

Before purchasing tires, check if your BMW is equipped with Run Flat tires. These are indicated by a circular symbol containing the letters RSC on the tire sidewall, refer to Changing a wheel. In this case, use only Run Flat tires, since no spare wheel is available in the event of a flat.

For more information on Run Flat tires, refer to page 156.

The right choice

 BMW recommends using only wheels and tires that have been approved by BMW for your particular vehicle model, as otherwise body contact and serious accidents can result despite the use of the same nominal size, e.g. due to manufacturing tolerances. BMW cannot evaluate all tires and wheels on the market, and is thus unable to guarantee that the vehicle will continue to perform safely if unapproved tires and/or wheels are mounted. ◀

For each tire size, BMW has assessed the safe performance of specific tire brands and approved them for use. Consult any BMW center for details. Comply with any local/national regulations, for example by recording the tire type in the vehicle documents.

 The correct wheel and tire combination affects various systems that would otherwise be impaired, for example ABS, DSC and DBC. For this reason, use only tires of the same manufacture and tread configuration. In the event of a flat tire, for example, remount the approved wheel and tire combination as soon as possible. ◀

Storage

Always store tires in a cool, dry place. Store them away from light whenever possible. Protect the tires against contact with oil, grease and fuel.

Do not exceed the maximum tire inflation pressures specified on the tire sidewall.

Winter tires**Choosing the right tire**

BMW recommends the use of winter tires for operation under winter road conditions. While all-season tires – with M+S designation – provide better winter traction than the corresponding summer tires, they generally do not achieve the performance of winter tires.

In the interest of safe tracking and steering response, install winter tires made by the same manufacturer and with the same tread configuration on all four wheels.

 Never exceed the maximum speed for which the winter tires are rated.

Unprofessional attempts by laymen to service tires can lead to damage and accidents.

Have this work performed by trained professionals only. Any BMW center has the required technical knowledge and the proper equipment and will be happy to assist you. ◀

Run Flat tires

Before purchasing winter tires, check if your BMW is equipped with Run Flat tires. These are indicated by a circular symbol containing the letters RSC on

Winter tires

the tire sidewall, refer to Changing a wheel. In this case, use only Run Flat winter tires, since no spare tire is provided in the event of a flat tire.

Tire condition, tire pressure

At tread depths below approx. 3/16 in / 4 mm, winter tires display a perceptible decrease in their ability to cope with winter driving conditions, and should be replaced in the interest of safety.

Comply with the specified tire inflation pressures – and be sure to have the wheel and tire assembly balanced every time you change a tire or wheel.

Snow chains*

Only certain snow chains have been tested by BMW and determined and approved as roadworthy. Consult any BMW center for details. BMW recommends using only these approved fine-link snow chains. Use them in pairs on either summer or winter tires, but only on both rear wheels.

Comply with all manufacturer's safety precautions when mounting the chains. Do not exceed a speed of 30 mph / 50 km/h when using snow chains.

You cannot mount snow chains with the following tires:

225/50 R 16

225/45 R 17

225/40 R 18

245/40 R 17

255/35 R 18



Do not initialize the Flat Tire Monitor after mounting snow chains to the tires.

When driving with snow chains, it may be useful to turn off the DSC for a short time, refer to page 94. ◀

**To release**

Pull the lever located under the left-hand side of the instrument panel.

 Do not attempt to service your vehicle if you do not have the required technical background. Failure to work in an informed, professional manner when servicing components and materials constitutes a safety hazard for vehicle occupants and other road users. If you are not familiar with the guidelines, BMW recommends that you have the operations performed by your BMW center. ◀

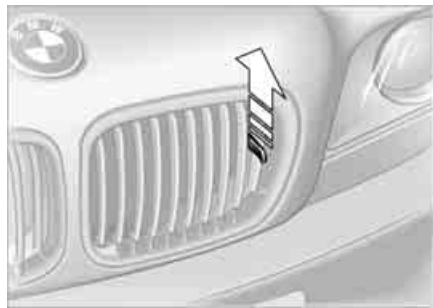
**To open**

Pull the release handle and open the hood.

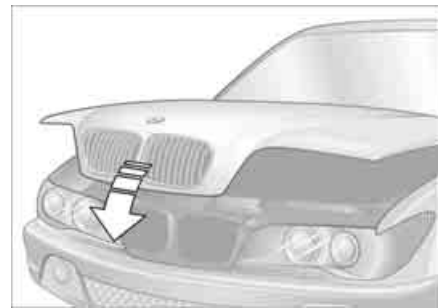
**To close**

Allow the hood to fall from a height of about 1 ft/30 cm so that it audibly engages.

 To avoid injuries, be sure that the travel path of the hood is clear when it is closed, following the same safety precautions used in all closing procedures.

If you notice while driving that the hood is not completely closed, stop immediately and close it securely. ◀

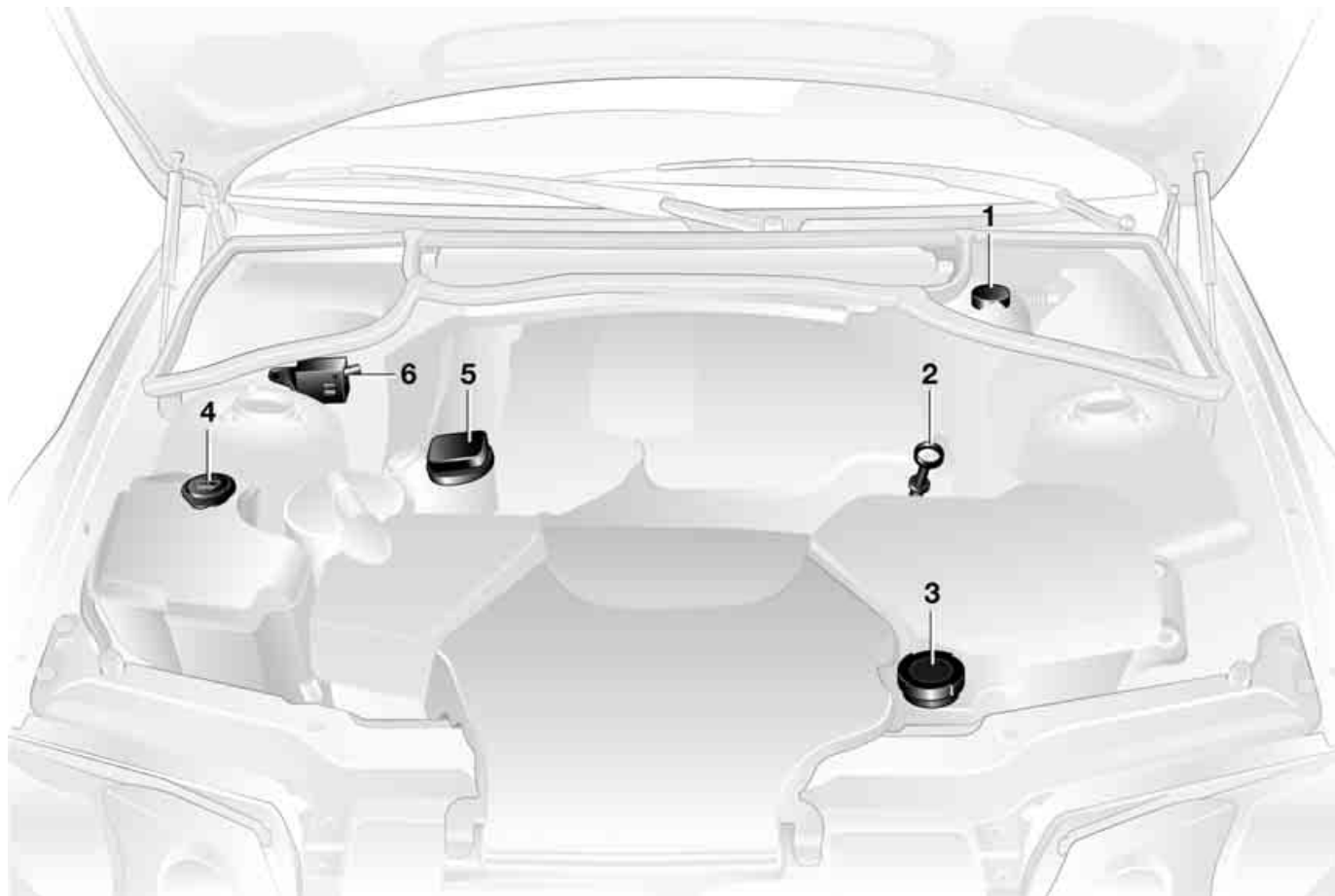

MU01625C3MA

- 1 Brake fluid reservoir [141](#)
- 2 Engine oil dipstick [138](#)
- 3 Coolant expansion tank [140](#)
- 4 Reservoir for the headlamp and windshield washer system [138](#)
- 5 Engine oil filler neck [139](#)
- 6 Auxiliary terminal for jump-starting [159](#)

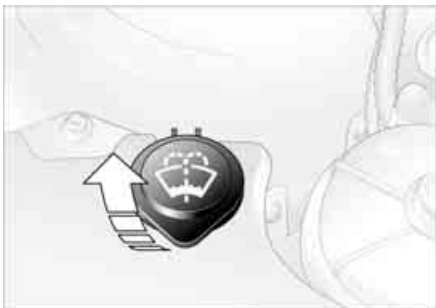

Headlamp* and windshield washer system

Approximate capacity is 5.6 US quarts/5.3 liters.

Fill with water and, if required, with a washer antifreeze additive according to manufacturer's recommendations.



We recommend that you mix the washer fluid before adding it to the reservoir. ◀



Antifreeze agents for the washer fluid are highly flammable. For this reason, keep them away from sources of flame and store them only in closed original containers, inaccessible to children. Comply with the instructions on the containers. ◀

Engine oil

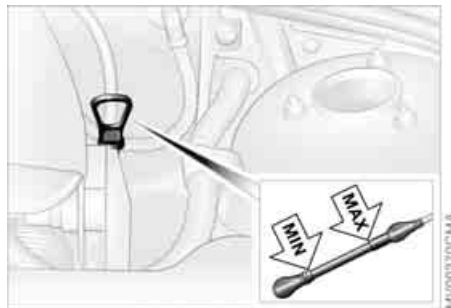

The oil volume between the two marks on the dipstick corresponds to approx. 1.1 US quarts/1 liter. Do not fill beyond the upper mark on the dipstick. Excess oil will damage the engine.

Checking the oil level

1. Park the vehicle on a level surface
2. Switch the engine off after it has reached normal operating temperature
3. After approx. 5 minutes, pull the dipstick out and wipe it off with a clean lint-free cloth, paper towel, or similar material
4. Carefully push the dipstick all the way into the guide tube and pull it out again
5. The oil level should be between the two marks on the dipstick.

As with fuel economy, oil consumption is directly influenced by your driving style and vehicle operating conditions.

Engine oil

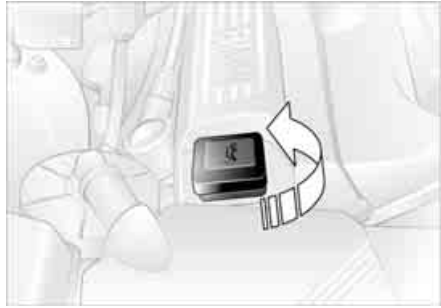

Adding engine oil

Only add engine oil when the oil level has dropped to just above the lower mark on the dipstick.

! BMW engines are designed to operate without oil additives; the use of additives could lead to damage in some cases. This also applies to the manual transmission, the automatic transmission, the differential, and the power steering system. ◀

Recommendation: have the oil changed at your BMW center.

! Continuous exposure to used oil has caused cancer in laboratory testing. For this reason, any skin areas that come into contact with oil should be thoroughly washed with soap and water. Store oils, grease and similar materials so that they are inaccessible to children. Comply with warning labels and information on containers. ◀

♻️ Comply with the applicable environmental laws regulating the disposal of used oil. ◀

Specified engine oils

The quality of the engine oil is extremely important for the operation and service life of an engine. Based on extensive testing, BMW has approved only certain grades of engine oil.

Use only approved BMW High Performance Synthetic Oil.

If an approved BMW High Performance Synthetic Oil should be unavailable, you may use small amounts of other synthetic oils for topping up between oil changes. Use only oils with the specification API SH or higher.

▶ Ask your BMW center for details concerning the specific BMW High Performance Synthetic Oil or synthetic oils that have been approved. ◀

You can also call BMW of North America toll-free at 1-800-831-1117 or visit this website: www.bmwusa.com to obtain this information.

Viscosity ratings

Viscosity is the oilflow rating as established in SAE classes.

The selection of the correct SAE class depends on the climatic conditions in the area where you drive your BMW.

▶ Approved oils are in SAE classes 5W-40 and 5W-30. ◀

These kinds of oil may be used for driving in all ambient temperatures.



Do not add coolant to the cooling system when the engine is hot. If you attempt to do so, escaping coolant can cause burns.

Antifreeze and anti-corrosion agents are hazardous to health. You should always store them in their closed original containers and in a location which is out of reach of children. Antifreeze and anti-corrosion agents are inflammable. For this reason, do not spill them on hot engine parts. They could ignite and cause serious burns. Comply with the instructions on the containers. ◀



Comply with the applicable environmental laws regulating the disposal of antifreeze with corrosion inhibitor. ◀



Checking the coolant level and adding coolant

Check the coolant level when the engine is cold, approx. 68 °F / +20 °C.

1. Open the cap for the expansion tank by turning it slightly counterclockwise to allow accumulated pressure to escape, then open
2. The coolant level is correct when the upper end of the red float rod – see arrow – is at least even with the upper edge of the filler neck, is at least even with the upper edge of the filler neck; see arrow. The end of the float may stick out by a maximum of 3/4 in / 2 cm – that is, up to the second mark on the float

3. If necessary, add coolant. If the coolant is low, slowly add coolant until the correct level is reached – do not overfill.

Brake fluid



Indicator lamp

BRAKE The brake warning lamp comes on when the parking brake is not engaged: the brake fluid level is too low, refer to page 18.

 Brake warning lamp for Canadian models.

Adding brake fluid

For adding brake fluid or for determining and correcting the cause of brake fluid loss, consult your BMW center. Your BMW center is familiar with the specifications for factory-approved brake fluids – DOT 4.

Brake fluid loss results in extended pedal travel. Refer to the information on page 126.

 Brake fluid is hygroscopic, that is, it absorbs moisture from the air over time.

In order to ensure the brake system's safety and reliability, have the brake fluid changed every two years by a BMW center. Refer also to page 88 and to the Service and Warranty Information Booklet for US models or the Warranty and Service Guide Booklet for Canadian models.

Brake fluid is toxic and damages the vehicle's paint. You should always store it in its closed original container and in a location which is out of reach of children.

Do not spill the brake fluid and do not fill the brake fluid reservoir beyond the MAX mark. The brake fluid could ignite upon contact with hot engine parts and cause serious burns. ◀

 Comply with the applicable environmental laws regulating the disposal of brake fluid. ◀



The BMW Maintenance System has been designed as a reliable means of providing maximum driving and operating safety – and as cost-effectively for you as possible.

Please keep in mind that regular maintenance is not only necessary for the safety of your vehicle, but also plays a significant role in maintaining its resale value.

Service interval display

While conventional systems rely on mileage alone to determine when service is due, the BMW Maintenance System reflects the actual conditions under which the vehicle is operated: some miles are more strenuous than others.

From a maintenance point of view, 62,000 miles/100,000 km accumulated in short-distance urban driving are not the equivalent of the same distance covered at moderate cruising speeds in long-distance highway travel.

The BMW Maintenance System includes the Engine Oil Service and Inspections I and II.

This service strategy accurately reflects your own vehicle's specific needs by defining maintenance intervals according to individual operating conditions. Minimal use drivers – those who drive significantly fewer than 6,200 miles/10,000 km annually – should have the engine oil changed at least every 2 years since oil deteriorates over time, regardless of use.

Service and Warranty Information Booklet for US models/Warranty and Service Guide Booklet for Canadian models

For additional information on required maintenance intervals and procedures, please refer to the Service and Warranty Information Booklet for US models, or the Warranty and Service Guide Booklet for Canadian models.

As a precaution against corrosion, if your vehicle is exposed to potential damage from unimproved road surfaces we suggest that you have the body checked for damage from stone chips and gravel at the same time.



Have your BMW center perform maintenance and repair.

Be sure that all maintenance work is recorded in the Service and Warranty Information Booklet for US models, or in the Warranty and Service Guide Booklet for Canadian models. These entries confirm that your vehicle has benefitted from regular maintenance, and are also required for warranty claims. ◀

Care

You can find everything you need to know on this topic by consulting the separate Caring for your vehicle brochure.

California Proposition 65 warning

California laws require us to state the following warning:

 Engine exhaust and a wide variety of automobile components and parts, including components found in the interior furnishings in a vehicle, contain or emit chemicals known to the State of California to cause cancer and birth defects and reproductive harm. In addition, certain fluids contained in vehicles and certain products of component wear contain or emit chemicals known to the State of California to cause cancer and birth defects or other reproductive harm. Battery posts, terminals and related accessories contain lead and lead compounds. Wash your hands after handling. Used engine oil contains chemicals that have caused cancer in laboratory animals. Always protect your skin by washing thoroughly with soap and water. ◀

OBD interface socket 143



The interface socket for onboard diagnostics is located on the left-hand side of the driver's side, behind a specially marked cover located beneath the instrument panel. The cover has the letters OBD on it.

This interface makes it possible to access data on emissions-related components using special equipment.

 An illuminated indicator informs you of the need for service, not that you need to stop the vehicle. However, the systems should be checked by your BMW center at the next opportunity.

If the indicator blinks or flashes, this indicates a high level of engine misfire. Reduce speed and contact the nearest BMW center immediately. Severe

144 OBD interface socket

engine misfiring for even a short period of time can seriously damage emission control system components, especially the catalytic converter.



SERVICE ENGINE SOON warning lamp for Canadian models.



If the gas cap is not on tight enough, the OBD system can detect leaking vapor and the indicator will light up. If the gas cap is then tightened, the indicator will usually go out after a short period of time. ◀

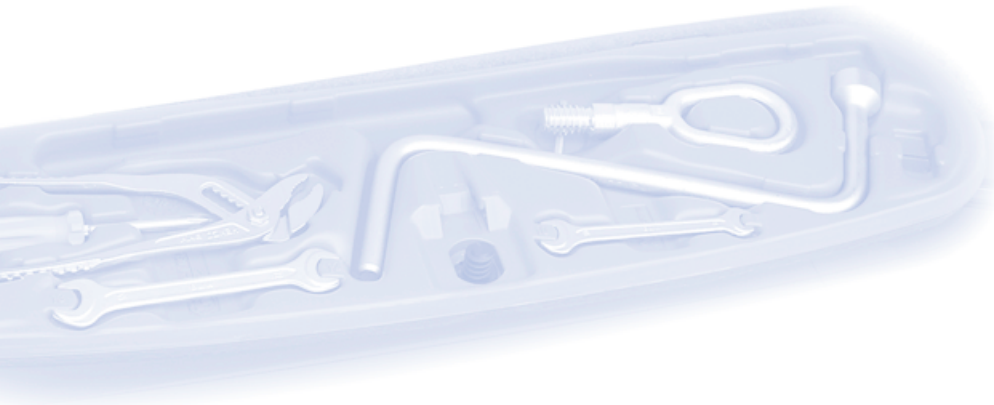



Overview

Controls and features

Operation, maintenance

Owner service procedures

Technical data

Index

Overview

Controls

Maintenance

Repairs

Data

Index



The onboard tool kit is located in the luggage compartment lid.

Loosen the wing nut to open.

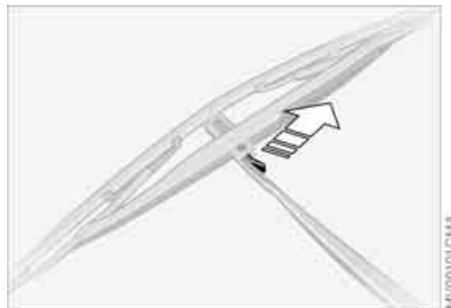

1. Switch off the engine
2. Fold the wiper arm completely out from the windshield
3. Position the wiper blade at an angle and pull the release spring – see arrow
4. Fold the wiper blade down and unhook it toward the windshield
5. Pull the wiper blade past the wiper arm toward the top
6. Insert a new wiper blade and apply pressure until you hear it engage.

Lamps and bulbs

The lamps and bulbs make essential contributions to the safety of your vehicle. Therefore, proceed carefully when handling bulbs. BMW recommends that you have such work performed by your BMW center if you are not familiar with the procedures.

 Do not touch the glass portion of a new bulb with your bare hands since even small amounts of impurities burn in to the surface and reduce the service life of the bulb. Use a clean cloth, paper napkin, or a similar material, or hold the bulb by its metallic base. ◀

A replacement bulb set is available from your BMW center.

 Before working on the electrical system, switch off the electrical accessory you are working on or disconnect the cable from the negative terminal of the battery. Failure to observe this precaution could result in short circuits. To prevent injuries and damage, comply with any instructions provided by the bulb manufacturer. ◀

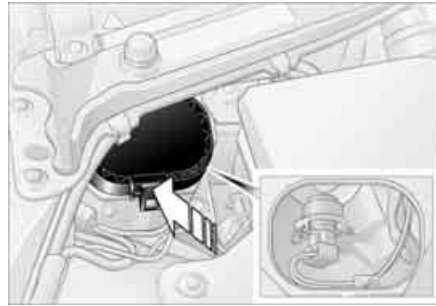

Low beams

H7 bulb, 55 watts

Engine compartment, left side:

 The H7 bulb is pressurized. Therefore, wear safety glasses and protective gloves. Failure to comply with this precaution could lead to injury if the bulb is damaged. ◀

1. Remove the cover of the headlamp by pressing the tab and lifting the cover off
2. Pull off the plug
3. Release the retaining wire
4. Remove and replace the bulb.

 When cleaning the headlamps, please follow the instructions in the Caring for your vehicle brochure. ◀

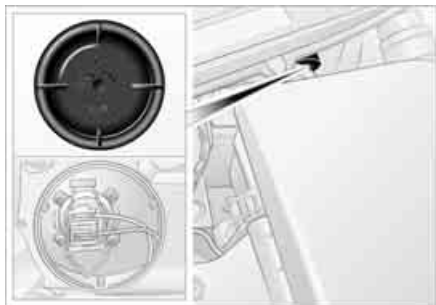

High beams

H7 bulb, 55 watts

Engine compartment, left side:

 The H7 bulb is pressurized. Therefore, wear safety glasses and protective gloves. Failure to comply with this precaution could lead to injury if the bulb is damaged. ◀

1. Turn the cover to the left and remove
2. Pull off the plug
3. Release the retaining wire
4. Remove and replace the bulb.

 Note the letters TOP when putting the cover in place. ◀

 When cleaning the headlamps, please follow the instructions in the Caring for your vehicle brochure. ◀

Xenon lamps*

The service life of these bulbs is very long and the probability of a failure is very low, provided that they are not switched on and off an unusual number of times. If one of these bulbs should nevertheless fail, it is possible to continue driving with great caution using the fog lamps, provided local traffic laws do not prohibit this.

 Because of the extremely high voltages involved, any work on the xenon lighting system, including bulb-changing, should be carried out by technically qualified personnel only. Otherwise, there is a risk of fatal injury. ◀

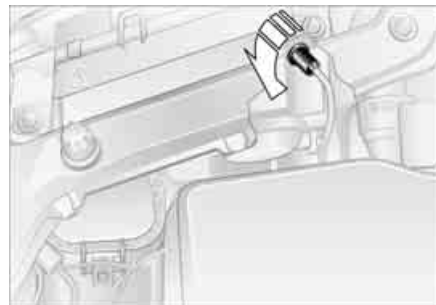

Parking lamps

5 watt bulb

Engine compartment, left side:

1. Turn the bulb holder to the left and remove
2. Pull the bulb off and replace it.

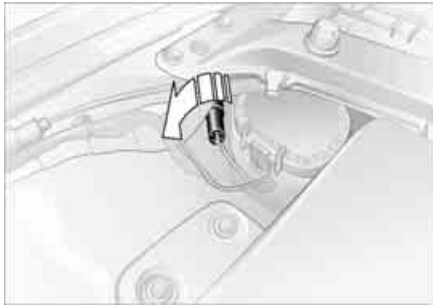

Front turn signal indicators

21 watt bulb

1. Turn the bulb holder with the plug to the left and remove
2. Pull the bulb off and replace it.

 When replacing the bulb on the right, loosen and lift the reservoir for the headlamp and windshield washer system if necessary. ◀



Side turn signal indicators

1. Press the front edge of the lamp toward the back with the tip of your finger and remove
2. Pull off the plug and replace the entire lamp.

 The side turn signal indicator is designed using LED technology. If faulty, the entire side turn signal indicator must be replaced. ◀

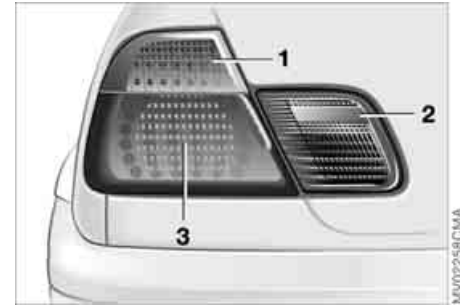

Rear lamps

- 1 Turn signal indicator
- 2 Backup lamp
21 watt bulb
- 3 Tail lamp/brake lamp

 All bulbs in the fender are designed using LED technology. Please contact your BMW center in case of a malfunction. ◀

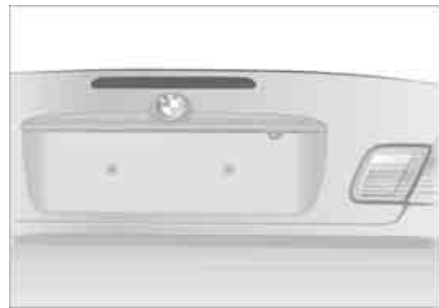
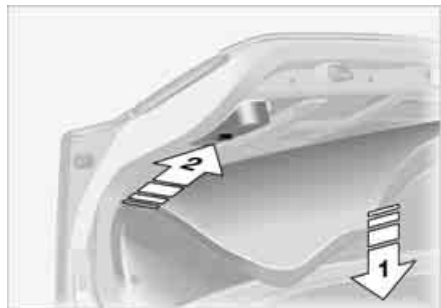

Bulbs in the luggage compartment lid:
1. Using a screwdriver, loosen the clip

2. Swing trim panel down – see arrow 1. Unlock bulb holder – see arrow 2 – and remove
3. Applying light pressure, turn the bulb to the left. Remove and exchange the bulb
4. Press the bulb holder into place continuing until you hear it engage
5. Reinstall the trim panel with the clip.

Center high-mount brake lamp

LED strip on the rear window.

Please contact your BMW center in case of a malfunction.

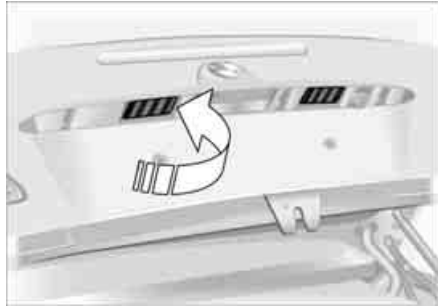

License plate lamps

5 watt bulb

1. Place a screwdriver in the slot and press toward the left to release the lens
2. Replace the bulb.

 Safety precautions in the event of a flat tire or wheel change: Stop the vehicle as far as possible from passing traffic. Park on a firm, flat, surface. Switch on the hazard warning flashers. Turn the steering wheel to the straight-ahead position and engage the steering lock. Shift into 1st or Reverse, or if you have an automatic transmission position the selector lever in Park, and engage the parking brake.

All passengers should be outside the vehicle and well away from your immediate working area – behind a guardrail, for example.

If a warning triangle or portable hazard warning lamp is available, set it up on the roadside at an appropriate distance from the rear of the vehicle. Comply with all safety guidelines and regulations.

Change the wheel only on a level, firm surface which is not slippery. Avoid jacking the vehicle on a soft or slippery support surface – snow, ice, loose gravel, etc. – as either the vehicle or the jack could slip sideways.

Position the jack on a firm support surface.

Do not place wooden blocks or similar objects under the jack. They could prevent the jack from extending to its full

height and reduce its support capacity. Do not lie under the vehicle or start the engine when the vehicle is supported by the jack. There is otherwise a risk of fatal injury. ◀

Your BMW is equipped with a space-saver spare tire designed for temporary use in maintaining the vehicle's mobility in an emergency.

 To remove the space-saver spare tire, lift the floor panel in the luggage compartment completely out, refer to page 37. ◀

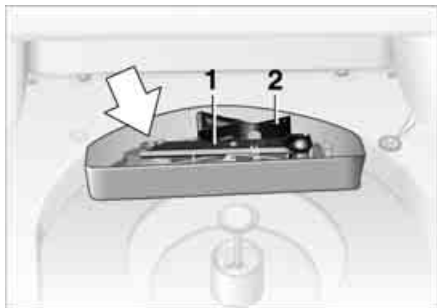

What you will need

In order to avoid rattling noises later, note the position of the tools when you remove them and return them to their original position when you are through using them.

▷ Jack 1

Raise the floor panel in the luggage compartment, refer to page 37, and undo the jack.

When you have completed work, fold the handle back and insert it in its holder

▷ Chock 2

Located behind the jack on the wall in the luggage compartment. Loosen the wingnut to remove it

- ▷ Space-saver spare tire – next to jack
Loosen the wing nut by hand, remove the storage shelf and take the wheel out
- ▷ Lug wrench – in the onboard tool kit on the underside of the luggage compartment lid, refer to page 148.

Procedure

1. Read and comply with the safety precautions provided on the previous page
2. Secure the vehicle to prevent it from rolling:
Place the chock against the rear surface of the front tire on the side opposite the side being raised. If the vehicle is parked on a downward slope, place the chock securely in front of the tire. If the

- wheel must be changed on a surface with a more severe slope, take additional precautions to secure the vehicle from rolling
3. Wheels with full wheel covers*: reach into the ventilation openings and pull the cover off
 4. Loosen the lug bolts by rotating half a turn

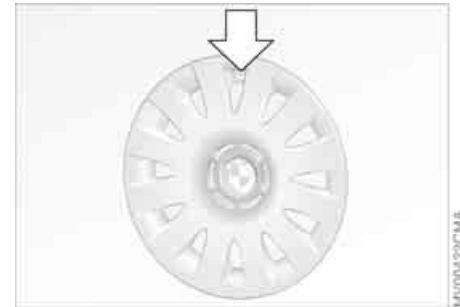
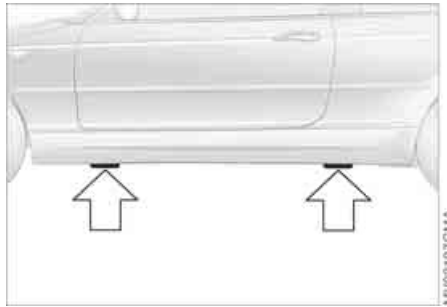

5. Position the jack at the jacking point closest to the flat tire with the jack base vertically below the jacking point. The entire surface of the head of the jack moves into the square recess of the jacking point – refer to the detail in the next illustration – when the jack is cranked
6. Continue raising the vehicle up until the wheel you are changing is raised from the ground
7. Unscrew the lug bolts and remove the wheel
8. Remove accumulations of mud and dirt from the mounting surfaces of the wheel and hub. Clean the lug bolts
9. Position the new wheel or the space-saver spare tire on the hub and screw at least two lug bolts finger-tight into opposite bolt holes
10. Screw in the remaining lug bolts. Screw in all the bolts in a diagonal pattern
11. Lower the jack and remove it from beneath the vehicle
12. Tighten the lug bolts securely in a diagonal pattern
13. Wheels with full wheel covers*: place the wheel cover with the valve opening over the valve. Use both hands to press the cover securely onto the rim
14. Check and correct the tire inflation pressure at the earliest opportunity. Vehicles with Flat Tire Monitor: After mounting the spare tire or correcting the tire inflation pressure, reinitialize the system, refer to page 95.

Protect valve stems and valves from dirt using screw-on valve stem caps. Dirty valve stems frequently lead to slow pressure loss.

 Do not place the full wheel cover on the space-saver spare tire, since this could damage the cover. ◀

 The vehicle jack is designed for changing wheels only. Do not attempt to raise another vehicle model with it or to raise any other type of load. To do so could cause accidents and personal injury. To ensure continued safety, have the tightness of the torque bolts checked with a calibrated lug wrench – torque specification: 88.5 lb ft/120 Nm – at the earliest opportunity. ◀

When storing a wheel in the spare tire recess, take care to avoid bending the threaded rod.

If light-alloy wheels other than original BMW light-alloy wheels have been mounted, it may be necessary to use different lug bolts for those wheels.

Replace the defective tire as soon as possible and have the new wheel/tire balanced.

Driving with the space-saver spare tire

Drive cautiously. Do not exceed a speed of 45 mph / 80 km/h.

Be aware that vehicle handling may be altered. Anticipate, e.g., reduced tracking during braking, longer braking distances and changed steering charac-

teristics when approaching limit conditions. These handling characteristics will be even more pronounced if winter tires are mounted.

 Only one space-saver spare tire may be mounted at one time. Mount a wheel and tire of the original size at the earliest possible opportunity. ◀

Run Flat tires*



Run Flat tires are labeled on the sidewall with a circular symbol containing the letters RSC. Run Flat tires consist of self-supporting tires and special rims. The tire reinforcement ensures that driving remains possible to a restricted degree in the event of pressure drop or even if the tire is deflated.

 When mounting or replacing summer tires with winter tires, or vice versa, use Run Flat tires since no spare wheel is available in the event of a flat. In this event, BMW recommends consulting your BMW center. Your BMW center has the information needed for working with Run Flat tires and is equipped with the necessary special tools. ◀

Run Flat tires*

Driving with a damaged tire

Depending on the cargo load, Run Flat tires allow you to continue driving at a maximum speed of 50 mph / 80 km/h. If there is a total loss of tire inflation pressure, 0 psi/0 kPa, or obvious tire damage, you can determine the distance you may continue driving based on the following values:

- ▷ With a light load:
 - 1 to 2 persons without luggage:
approx. 150 miles/250 km
- ▷ With a medium load:
 - 2 persons, luggage compartment full;
or 4 persons without luggage:
approx. 100 miles/150 km
- ▷ With a full load:
 - 4 persons, luggage compartment full:
approx. 30 miles/50 km.

 Drive cautiously. Do not exceed a speed of 45 mph / 80 km/h. Be aware that vehicle handling will be altered when there is a loss in inflation pressure. Anticipate, e.g., reduced tracking during braking, longer braking distances and changed steering characteristics.

For safety reasons, BMW recommends not having damaged Run Flat tires repaired. In this case, consult your BMW center. ◀

Battery

Maintenance

The battery is maintenance-free, that is, the original electrolyte will normally last for the service life of the battery under moderate climatic conditions.

 Please consult your BMW center whenever you have any questions concerning the battery. ◀

Charging the battery

When charging the battery in the vehicle, leave the engine off at all times. Connect the charge cables to the terminals in the engine compartment. For terminal locations, refer to Jump-starting on page 159.

Disposal

 Return used batteries to a recycling point or your BMW center. Maintain the battery in an upright position for transport and storage. Secure the battery against tilting during transport. ◀

Fuses

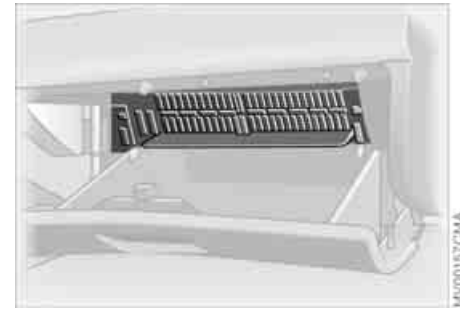

You will find the fuses and information on their respective allocation in the glove compartment behind a panel with two snap clips.

 Do not attempt to repair a blown fuse or replace it with a fuse having a different color or amperage rating. To do this could cause a fire in the vehicle resulting from a circuit overload. ◀

The BMW Group's Mobile Service offers you 24-hour assistance in the event of a breakdown, even on weekends and holidays.

The telephone numbers of the Mobile Service control center in your country are listed in the BMW Dealer Directory.

If your vehicle has the necessary equipment, you can contact the Mobile Service or issue an emergency call using buttons in the interior rearview mirror.

When an emergency call is initiated, a telephone connection is established with the general emergency call center.

In vehicles with activated BMW Assist function, a telephone connection is set up to the BMW Assist emergency call center. If the current location of your vehicle can be determined, this location is transmitted to the BMW Assist emergency call center.

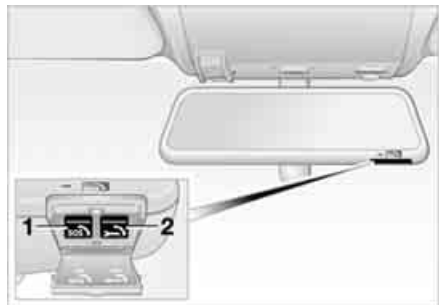

Fold down the cover.

- 1 Emergency call
- 2 Mobile Service

Requirements for initiating an emergency call or contacting Mobile Service:

- ▷ The car phone is registered with a mobile network
- ▷ The emergency call system is operational.

Initiating an emergency call*

Press button 1 for at least 2 seconds.

The indicator lamp above the buttons lights up. As soon as a telephone connection has been set up to the main emergency call center, the indicator lamp flashes.

If the indicator lamp is flashing but you cannot hear the emergency call center, you may still be heard by the emergency call center.



For technical reasons, the emergency call function cannot be guaranteed in certain unfavorable conditions. ◀

If certain requirements are met, an emergency call is automatically initiated after a serious accident. The automatic emergency call will not be hindered by pressing the button.

Mobile Service*

To establish contact with the BMW Group's Mobile Service:

Press button 2 for at least 2 seconds.

The indicator lamp above the buttons lights up. As soon as a telephone connection has been set up with the Mobile Service, the indicator lamp flashes.

Depending on the country you are in, your vehicle's current location will also be transmitted if your vehicle is equipped with an activated BMW Assist function.

Jump-starting

When your battery is discharged you can use two jumper cables to start your vehicle with power from the battery in a second vehicle. You can also use the same method to help start another vehicle. Only use jumper cables with fully insulated handles on the terminal clamps.

 Do not touch high-voltage wiring and cables on a running engine. Contact with components carrying high voltage can be harmful or fatal. Carefully observe the following instructions to avoid personal injury and/or damage to one or both vehicles. ◀

Preparations

1. Check whether the battery of the support vehicle has 12 volts and approximately the same capacity – measured in Ah. This information is provided on the battery
2. Stop the engine of the support vehicle
3. Switch off all electrical components in both vehicles.

 Make absolutely certain that there is no contact between the bodywork of the two vehicles, otherwise there is a short circuit hazard. ◀

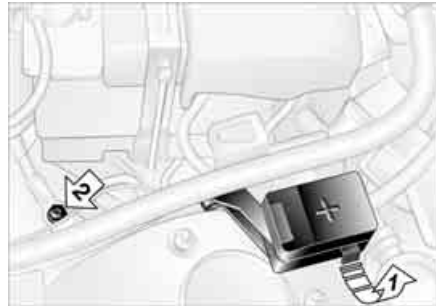

Connecting the jumper cables

 Always adhere to this sequence when connecting jumper cables; failure to observe this procedure can lead to sparks at the battery terminals and pose an injury hazard. ◀

The auxiliary jump-starting terminal located in your BMW's engine compartment acts as the positive battery terminal. Refer to the engine compartment overview on page, 136. The cover of this auxiliary terminal is marked with a +.

1. Open the cover of the BMW auxiliary jump-starting terminal. Do so by pulling the tab – see arrow 1

2. Connect one terminal clamp of the plus/+ jumper cable to the positive terminal of the battery or to an auxiliary jump-starting terminal of the support vehicle
3. Connect the second terminal clamp of the plus/+ jumper cable to the positive terminal of the battery or to an auxiliary jump-starting terminal of the vehicle to be started
4. Your BMW is equipped with a special nut – see arrow 2 – to serve as the ground or negative terminal. Attach a terminal clamp of the minus/- jumper cable to the negative terminal of the support vehicle's battery or to a suitable ground on its engine or bodywork
5. Attach the second terminal clamp of the minus/- jumper cable to the negative terminal of the battery or to a suitable ground on the engine or bodywork of the vehicle to be started.

Starting the engine

1. Start the engine of the support vehicle and let it run for several minutes at a slightly elevated engine idle speed

2. Start the engine of the other vehicle as usual.

If the first start attempt is not successful, wait a few minutes before another attempt in order to allow the discharged battery to recharge

3. Allow the engines to run for several minutes
4. Disconnect the jumper cables in reverse sequence.

Depending on the cause of the fault, have the battery checked and recharged by your BMW center.

 Do not use spray starter fluids to start the engine. ◀

Towing the vehicle



Always comply with all applicable towing laws and regulations. ◀

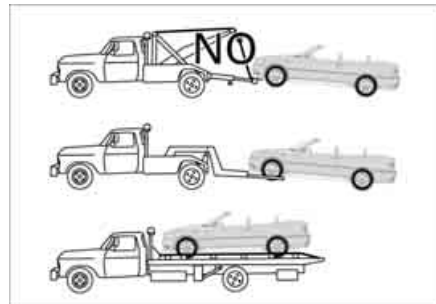

Towing with a commercial tow truck

- ▷ Use wheel lift or flat bed carrier
- ▷ Do not tow with sling-type equipment.



Never allow passengers to ride in a towed vehicle for any reason. Never attach tie-down hooks, chains, straps, or tow hooks to tie rods, control arms, or any other part of the vehicle suspension, as severe damage to these components will occur, possibly leading to accidents. ◀

Towing the vehicle

Towing the vehicle with the front axle raised

Vehicles with automatic transmission:

1. Towing speed: maximum 45 mph / 70 km/h
2. Towing distance: maximum 90 miles/150 km.

Vehicles with sequential manual gear-box SMG:

While the ignition is on, move the selector lever to position N, then turn off the ignition.

Towing eyelet

The screw-in towing eyelet is stored in the onboard tool kit; be sure that it remains in the vehicle at all times. It can be attached at the front or rear of the vehicle. It should not be used to pull a vehicle out of deep snow, mud, sand, etc.

Always observe all applicable towing laws and regulations.



Access to tow sockets

Front:

Press out the cover panel with a screwdriver inserted in the recess at the top.

Rear:

Press out the cover panel with a screwdriver inserted in the recess at the top.



Use only the towing eyelet supplied with the vehicle and screw it in firmly until it stops. Use the towing eyelet for towing on paved roads only. If you do not follow these instructions, the towing eyelet could be torn out and vehicle damage could occur. Never attach tie-down hooks, chains, straps, or tow hooks to tie rods, control arms, or any other part of the vehicle suspension, as severe damage to these components will occur, possibly leading to accidents. ◀

162 **Towing the vehicle**



Avoid staggered towing and be careful that the towing strap is taut before starting to drive the vehicle doing the towing. ◀

Use only a nylon towing strap to tow the vehicle, since the inherent resilience of this material helps protect both vehicles from sudden jerking movements.



The towed vehicle should always be the lighter of the two vehicles. If this is not the case, it will not be possible to control vehicle handling. ◀

Tow-starting

For instructions on jump-starting, refer to page [159](#).

Never attempt to use your vehicle to push another car, since damage to the energy-absorbing bumpers could result.

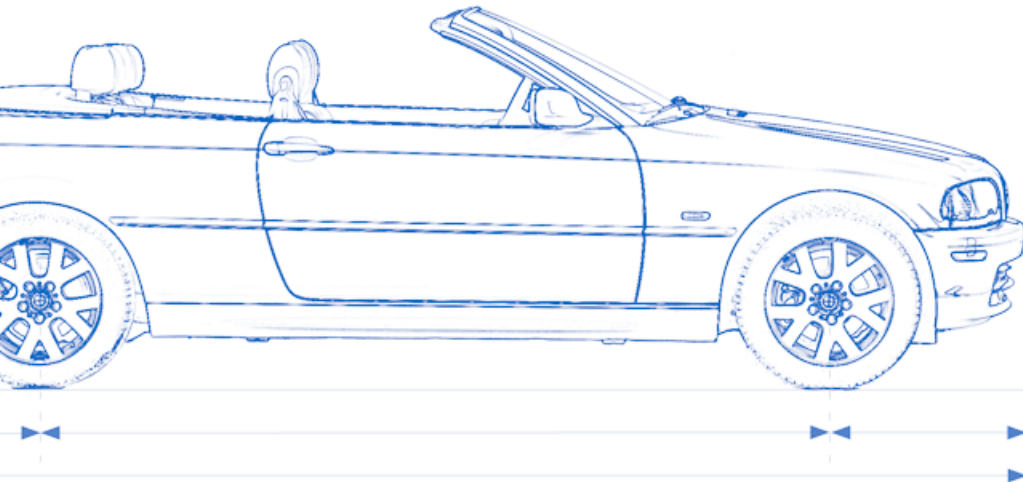
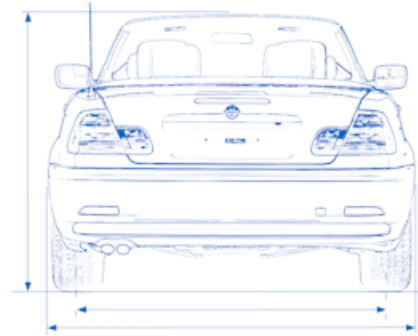

Overview

Controls and features

Operation, maintenance

Owner service procedures

Technical data

Index

Overview

Controls

Maintenance

Repairs

Data

Index

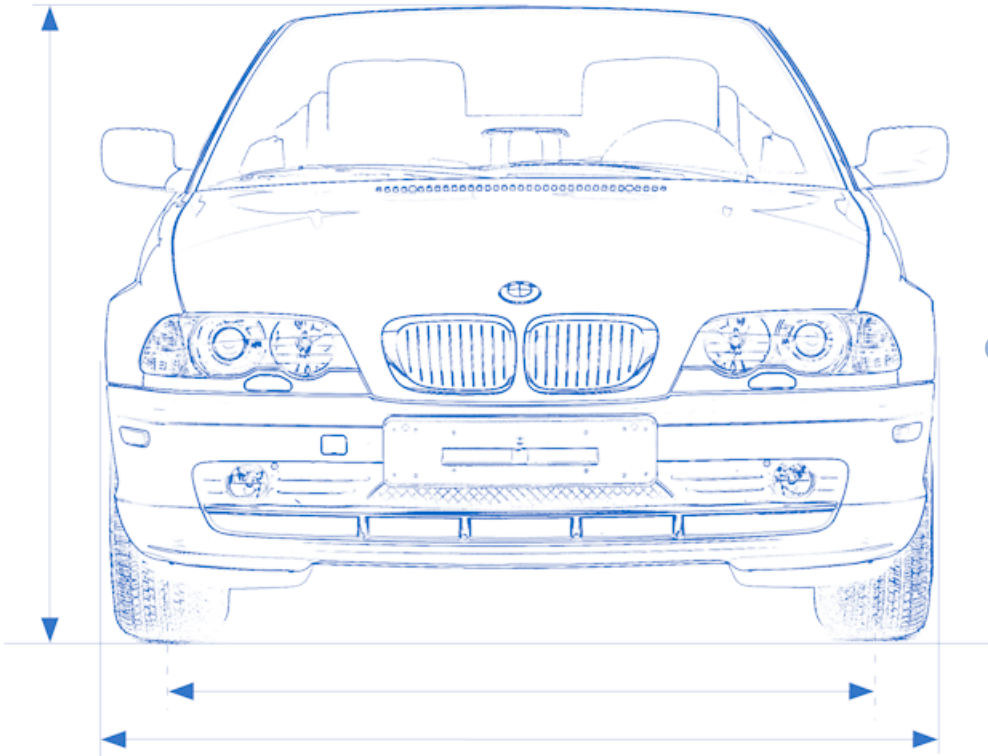

166 **Engine data**

		325Ci	330Ci
Displacement	cu in/cm ³	152.2/2,494	181.8/2,979
Number of cylinders		6	6
Maximum power output at engine speed	hp rpm	184 6,000	225 5,900
Maximum torque at engine speed	lb ft/Nm rpm	175/237 3,500	214/290 3,500
Compression ratio	ϵ	10.5	10.2
Stroke	in/mm	2.95/75	3.53/89.6
Bore	in/mm	3.31/84	3.31/84
Fuel mixture preparation		Digital electronic engine-management system (DME)	

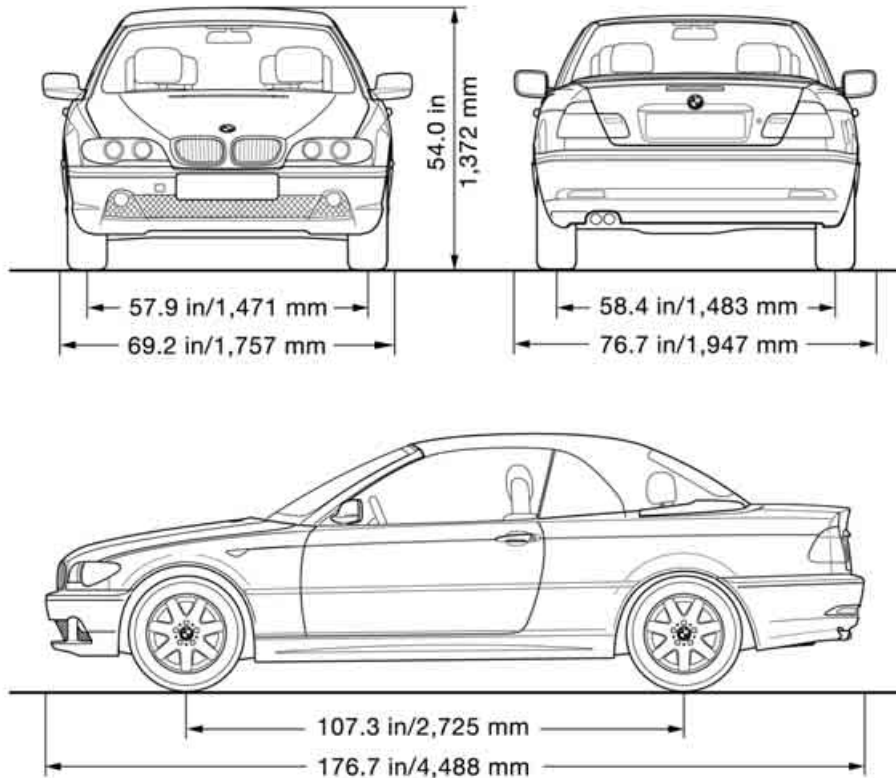

Minimum turning circle dia.: 34.4 feet/10.5 m.

		325Ci	330Ci
Curb weight			
with manual transmission/SMG	lbs/kg	3,560/1,615	3,616/1,640
with automatic transmission	lbs/kg	3,627/1,645	3,704/1,675
Approved gross vehicle weight			
with manual transmission/SMG	lbs/kg	4,442/2,015	4,497/2,040
with automatic transmission	lbs/kg	4,509/2,045	4,575/2,075
Approved front axle load	lbs/kg	2,083/945	2,094/950
Approved rear axle load	lbs/kg	2,546/1,155	2,579/1,170
Approved maximum roof load for the hardtop	lbs/kg	165/75	165/75
Luggage compartment capacity	cu ft/l	9.2/260	9.2/260
with the convertible top compartment raised	cu ft/l	10.6/300	10.6/300

Approved axle loads and approved gross vehicle weight must never be exceeded.

			Notes
Fuel tank	gal./liters	approx. 16.6/63	Fuel specification, refer to page 25
Reserve	gal./liters	approx. 2.1/8	
Windshield/ Headlamp washer reservoir	quarts/liters	approx. 5.6/5.3	Specifications, refer to page 138
Engine oil and filter change	quarts/liters	approx. 6.9/6.5	BMW High Performance Synthetic Oil Specifications, refer to page 138
Manual and automatic transmission and differential		-	Lifetime lubricant, no oil change required

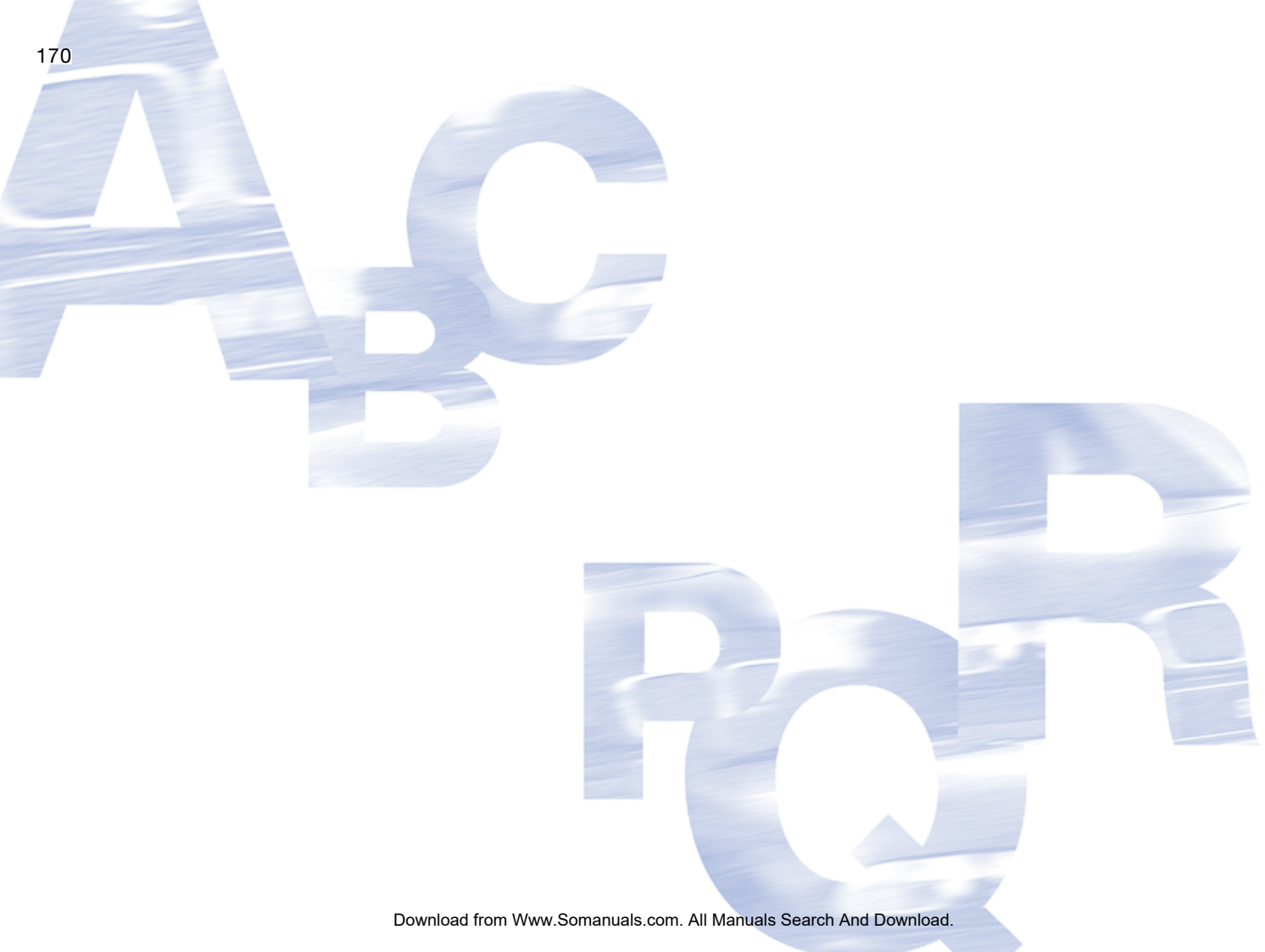



Overview

Controls and features

Operation, maintenance

Owner service procedures

Technical data

Index

Overview

Controls

Maintenance

Repairs

Data

Index

Everything from A to Z

A

ABS Antilock Brake System 125
indicator lamp 19
Acceleration assistant 78
Accessories, refer to For your own safety 5
Accident, refer to Emergency call 158
Activated-charcoal filter 110
Adaptive headlights 98
Adding brake fluid 141
Additional sources of information 4
Air conditioning 102
Air conditioning mode 104
automatic climate control 108
Air distribution
air conditioning 104
automatic climate control 108
Air distribution, individual 108
Air outlets, refer to Ventilation 102, 106
Air pressure, refer to Tire inflation pressure 25, 129
Air recirculation, refer to Recirculated-air mode 104, 109

Air supply
air conditioning 104
automatic climate control 108
Air, drying, refer to Air conditioning mode 104, 108
Airbags 61
deactivating 64
indicator lamp 18, 63
sitting safely 52
Airing out, refer to Ventilation 102, 106
AKI, refer to Fuel specifications 25
Alarm system 38
avoiding unintentional alarms 39
All-season tires, refer to Winter tires 132
Antifreeze 140
coolant 140
washer fluid 138
Antilock Brake System (ABS) 125
indicator lamp 19
Anti-theft system 30
Anti-theft warning system, refer to Alarm system 38
Approved axle loads, refer to Weights 168
Approved gross weight, refer to Weights 168

Armrest 114
Artificial leather, refer to the Caring for your vehicle brochure
Ashtray
front 115
rear 116
Assistant systems, refer to Dynamic Stability Control (DSC) 93
AUC Automatic recirculated-air control 109
AUTO program, refer to Automatic air distribution 108
Automatic
air distribution 108
air supply 108
cruise control 84
headlamp control 97
Automatic car wash, refer to the Caring for your vehicle brochure
Automatic climate control 106
Automatic curb monitor 58
Automatic dimming, interior rearview mirror 60
Automatic recirculated-air control (AUC) 109

Automatic transmission with Steptronic 79
indicator lamp 19, 81
interlock 71
selector lever lock 79
shiftlock 79
Automatic windshield washer, refer to Rain sensor 83
Average fuel consumption 91
Average speed 91
Avoiding unintentional alarms 39
Axle loads, refer to Weights 168

B

Backrest
unlock 55
Backrest, refer to Seat adjustment 53
Backup lamps 74
bulb replacement 151
Bandages, refer to First-aid kit 23
Bar, towing 161

- Battery 157
 - charge 157
 - disposal 157
 - indicator lamp 18
 - jump-starting 159
 - remote control 30, 31
- Battery charge current 18
- Belts, refer to Safety belts 56
- Beverage holders 115
- Blower
 - air conditioning 104
 - automatic climate control 108
- BMW High Performance Synthetic Oils 139
- BMW Maintenance System 142
- BMW sports seat 53
- Bore, refer to Engine data 166
- Bottle holders, see Beverage holders 115
- Brake fluid 141
 - indicator lamp 18, 141
 - level 141
- Brake force display 96
- Brake hydraulic system 126
- Brake lamps
 - bulb replacement 151
 - indicator lamp, defective lamp 88
- Brake lights
 - brake force display 96
- Brake pads 126
 - brake fluid level 18, 126, 141
 - breaking in 124
 - disc brakes 126
 - indicator lamp 19
- Brake rotors
 - brake system 126
 - breaking in 124
- Brake wear warning indicator lamp 19
- Brakes
 - ABS 125
 - brake fluid 141
 - breaking in 124
 - indicator/warning lamp 18, 19
 - parking brake 73
- Break-in procedures 124
- Bulb replacement, refer to Lamps and bulbs 149
- Bulb, replacing 149
- Buttons in steering wheel 22
- C**
- California Proposition 65 warning 143
- Can holders, see Beverage holders 115
- Capacities 169
- Car battery 157
- Car care, refer to the Caring for your vehicle brochure
- Car keys, refer to Keys 30
- Car radio, refer to the Owner's Manual for Radio
- Car telephone
 - preparation 115
- Car telephone, refer to the separate Owner's Manual
- Car vacuum cleaner, connecting 116
- Car wash, refer to the Caring for your vehicle brochure
- Carpet care, refer to the Caring for your vehicle brochure
- Cassette operation, refer to the Owner's Manual for Radio/Onboard Computer
- CBC Cornering Brake Control 125
 - warning lamp 19
- CD changer, refer to the Owner's Manual for Radio/Onboard Computer
- CD operation, refer to the Owner's Manual for Radio/Onboard Computer
- Cellular phone 115
- Center armrest
 - front 114
- Center high-mount brake lamp
 - bulb replacement 152
- Central locking system 30
 - button 34
 - passenger compartment 34
- Changing a wheel 153
- Charge indicator lamp 18
- Check Control 88
- Check Gas Cap
 - indicator lamp 19
- Child seats, refer to Child-restraint systems 64
- Child-restraint mounting system (LATCH) 66
- Child-restraint system 64
- Chock 154
- Cigarette lighter 115
- Cigarette lighter socket 116
- Cleaning chrome parts, refer to the Caring for your vehicle brochure
- Cleaning light alloy wheels, refer to the Caring for your vehicle brochure
- Cleaning position, convertible top 45, 50
- Cleaning the vehicle, refer to the Caring for your vehicle brochure
- Cleaning windshield 84

Everything from A to Z

- Clock [89](#)
 - 12-/24-hour mode [89](#)
 - setting, refer also to the Owner's Manual for Radio/Onboard Computer
- Closing
 - from inside [34](#)
 - from outside [31](#)
- Clothes hooks [125](#)
- Clutch
 - breaking in [124](#)
- Cockpit [14](#)
- Code, refer to the Owner's Manual for Radio/Onboard Computer
- Coin box [115](#)
- Cold start, refer to Starting the engine [71](#)
- Compact disc operation, refer to the Owner's Manual for Radio/Onboard Computer
- Compartments [114](#)
- Compression ratio, refer to Engine data [166](#)
- Computer [90](#)
- Condensation, refer to Air conditioning mode [104](#), [108](#)
- Configuring settings, refer to Vehicle Memory, Key Memory [70](#)
- Connecting a vacuum cleaner, refer to Cigarette lighter [116](#)
- Consumption
 - display [86](#)
- Consumption, refer to Average fuel consumption [91](#)
- Control elements, refer to Cockpit [14](#)
- Convenience operation
 - from outside [33](#)
 - windows [32](#)
- Convertible top
 - cleaning position [45](#), [50](#)
 - closing in an emergency [48](#)
 - electrical fault [48](#)
 - indicator lamps [47](#)
 - remote control [31](#)
- Convertible top activation
 - fully automatic top [46](#)
 - manual top [41](#)
- Convertible top compartment panel [37](#)
- Coolant [140](#)
 - indicator lamp [19](#), [87](#)
 - level [140](#)
 - temperature gauge [87](#)
- Coolant water, refer to Coolant [140](#)
- Cooling, refer to Temperature [104](#), [108](#)
- Copyright [4](#)
- Cornering Brake Control (CBC) [125](#)
 - warning lamp [19](#)
- Correct tires [132](#)
- Cruise control [84](#)
 - indicator lamp [20](#)
- Cup holders, see Beverage holders [115](#)
- Curb weight, refer to Weights [168](#)
- Current consumption, refer to Energy control [86](#)
- Curve lighting, refer to Adaptive headlights [98](#)
- Cylinders, refer to Engine data [166](#)
- D**
- Dashboard, refer to Cockpit [14](#)
- Data
 - capacities [169](#)
 - dimensions [167](#)
 - engine [166](#)
 - technical [166](#)
 - weights [168](#)
- Daytime driving lamps [97](#)
- DBC Dynamic Brake Control [19](#), [125](#)
- Deep water, refer to Water on roadways [125](#)
- Defrost position, refer to Defrosting windows [105](#), [108](#)
- Defrosting and demisting windows
 - air conditioning [105](#)
 - automatic climate control [108](#)
- Defrosting windows [105](#), [108](#)
- Defrosting windshield, refer to Defrosting windows [105](#), [108](#)
- Demisting windows
 - air conditioning [105](#)
 - automatic climate control [108](#)
- Determining the maximum load [118](#)
- Differential
 - breaking in [124](#)
- Digital clock [89](#)
- Dimensions [167](#)
- Dipstick, engine oil [138](#)
- Disc brakes [126](#)
- Displacement, refer to Engine data [166](#)
- Display lighting, refer to Instrument lighting [98](#)
- Displays, refer to Instrument cluster [16](#)

Disposal
oil 139
vehicle battery 157

Distance warning, refer to
Park Distance Control
(PDC) 92

Door key 30

Door lock 33

Doors
emergency operation 33

Draft-free ventilation
105, 109

Driving light, refer to Parking
lamps/Low beams 97

Driving notes 125

Dry air, refer to Air condi-
tioning mode 104, 108

DSC Dynamic Stability Con-
trol 93
indicator lamp 19, 93

DTC Dynamic Traction Con-
trol 93
indicator lamp 19, 93

Dynamic Brake Control
(DBC) 19, 125
indicator lamp 19

Dynamic Stability Control
(DSC) 19, 93

Dynamic Traction Control
(DTC) 93
indicator lamp 19, 93

E

Easy entry, refer to Entering
the rear 55

Electric power windows 40

Electrical accessories, fail-
ure 157

Electrical malfunction
automatic transmission
with Steptronic 81
door lock 33
driver's door 33
fuel filler door 24
luggage compartment
lid 35

Electronic Stability Program
(ESP), refer to Dynamic
Stability Control (DSC) 93

Emergency call 158

Emergency operation
closing the convertible
top 48
doors 33
driver's door 33
fuel filler door 24

Emergency release
luggage compartment lid
35, 36

Emissions, minimum, refer
to Energy control 86

Energy control 86

Engine
breaking in 124
data 166
electronics 19
indicator lamp 19
speed 86, 166
starting 71
switching off 73

Engine compartment 136

Engine coolant 140
adding 140

Engine oil
adding 139
additives, refer to Adding
engine oil 139
capacity 169
consumption 138
indicator/warning lamp 19
quality 139
specified oils 139
viscosity 139

Engine oil level 19
check 138
indicator/warning lamp 18

Engine oil pressure
indicator/warning lamp 18

Engine oil types 139

Engine output, refer to
Engine data 166

Engine speed 86, 166

Entering the rear 55

Environmentally-friendly
driving, refer to Energy
control 86

Equipment range, refer to
the Service and Warranty
Information Booklet for US
models / Warranty and
Service Guide Booklet for
Canadian models

ESP Electronic Stability Pro-
gram, refer to Dynamic
Stability Control (DSC) 93

Exterior mirrors 59

Eyelets, towing 161

F

False alarm, refer to
Avoiding unintentional
alarms 39

Fasten safety belts
warning lamp 18, 56

Fault displays 88

Filling the windshield washer
reservoir 169

First aid, refer to First-aid
kit 23

First-aid kit 23

Flashlight 111

Flashlight, refer to
Rechargeable
flashlight 111

Everything from A to Z

- Flat tire [153](#)
 - Flat Tire Monitor [94](#)
 - space-saver spare tire [153](#)
- Flat Tire Monitor [94](#)
 - indicator lamp [18](#), [19](#), [95](#)
- Flat tire, refer to Tire condition [129](#)
- Fluid reservoir for washer systems [138](#)
- Fog lamps [99](#)
 - indicator lamp [20](#)
- Follow me home lamps [97](#)
- Footbrake, refer to General driving notes [125](#)
- Front airbags [61](#)
- Front fog lamps [99](#)
- Front seat adjustment [53](#)
- Fuel
 - display [87](#)
 - quality [25](#)
 - volume [169](#)
- Fuel consumption
 - display [91](#)
- Fuel display, refer to Fuel gauge [87](#)
- Fuel economy, refer to Energy control [86](#)
- Fuel filler door [24](#)
 - release following an electrical malfunction [24](#)
- Fuel level indicator, refer to Fuel gauge [87](#)
- Fuel mixture preparation [166](#)
- Fuel reserve indicator, refer to Fuel gauge [87](#)
- Fuel tank capacity [169](#)
- Fully-automatic convertible top [46](#)
 - activation [46](#)
 - convenience operation [32](#), [33](#)
 - opening, closing [47](#)
 - remote control [32](#)
- Fuses [157](#)
- G**
- Garage door opener, refer to Integrated universal remote control [112](#)
- Gasoline consumption, refer to Average fuel consumption [91](#)
- Gasoline, refer to Fuel specifications [25](#)
- Gear indicator [77](#), [81](#)
- Gear lever
 - automatic transmission with Steptronic [79](#)
 - sequential manual gearbox SMG [75](#)
- Gearbox
 - manual transmission [74](#)
- Gearshift lever
 - manual transmission [74](#)
- General driving notes [125](#)
- Glove compartment [111](#)
- Grills, refer to Ventilation [102](#), [106](#)
- Gross weight, refer to Weights [168](#)
- H**
- Handbrake, refer to Parking brake [73](#)
- Hardtop [127](#)
- Hardtop preparation [127](#)
- Hardtop, refer to the separate Owner's Manual [127](#)
- Hazard warning flashers [14](#)
- Hazard warning triangle [23](#)
- Head restraints [54](#)
- Headlamp cleaning system
 - cleaning headlamps [84](#)
 - washer fluid [138](#), [169](#)
- Headlamp control, automatic [97](#)
- Headlamp flasher [99](#)
 - indicator lamp [21](#)
- Headlamps
 - bulb replacement [149](#)
 - care, refer to the Caring for your vehicle brochure
- Heated mirrors [59](#)
- Heated rear window
 - air conditioning [104](#)
 - automatic climate control [109](#)
- Heated seats [58](#)
- Heating
 - exterior mirrors [59](#)
 - rear window [104](#), [109](#)
 - seats [58](#)
- Heating and ventilation [102](#), [106](#)
- Heavy loads, refer to Cargo loading [119](#)
- Height adjustment
 - seats [53](#)
 - steering wheel [59](#)
- Height, refer to Dimensions [167](#)
- High beams [82](#), [83](#), [99](#)
 - bulb replacement [150](#)
 - headlamp flasher [99](#)
 - indicator lamp [21](#)
- Holder for beverages [115](#)
- Hood release [134](#)
- Horn [14](#)
- Hub cap [154](#)
- Hydraulic brake assistant, refer to DBC [125](#)
- Hydraulic system
 - brakes [126](#)
- Hydroplaning [125](#)

I

Ice warning 90
Ignition 71
Ignition key 30
 positions 71
Ignition lock 71
Imprint 4
Indicator lamps 18
Indicator/warning lamp
 airbags 18
 alarm system 39
 brakes 18, 19
 Check Gas Cap 19
 coolant 19, 87
 DSC 19
 Fasten safety belts 18
 Flat Tire Monitor
 18, 19, 95
 fog lamps 20
 reserve 87
 rollover protection
 system 19
 Service Engine Soon 19
Individual air distribution 108
Individual settings, refer to
 Vehicle Memory, Key
 Memory 70
Inflation pressure monitor-
 ing, refer to Flat Tire Moni-
 tor 94
Inflation pressure, tires
 25, 129

INSPECTION 88

Instrument cluster 16
Instrument lighting 98
Instrument panel 14
Integrated universal remote
 control 112
Interface socket for onboard
 diagnostics (OBD) 143
Interior lamps 100
 remote control 32
Interior motion sensor 38
 switching off 32, 39
Interior rearview mirror 60
 automatic dimming
 feature 60
Interior temperature, adjust-
 ment 104, 108
Interlock, refer to Steering
 wheel lock 71
Intermittent
 mode, wipers 83
Interval
 display, service 88

J

Jack 153
Jacking points 154
Jump-starting 159

K

Key Memory 70

Keys 30

 with remote control 30
Kickdown 76, 80

L

Lamp defect 149
Lamps and bulbs 149
Lashing down loads, refer to
 Cargo loading 118
 Lashing eyelets, refer to
 Securing cargo 120
Lashing fittings, refer to
 Securing cargo 120
LATCH child-restraint
 mounting system 66
Leather care, refer to the
 Caring for your vehicle
 brochure
LEDs light-emitting
 diodes 100
Length, refer to
 Dimensions 167
License plate lamp
 bulb replacement 153
Light switch 97
Light-emitting diodes
 (LEDs) 100
Lighter 115
LIGHTS ON warning 97
Lights, refer to Parking
 lamps/Low beams 97
Load, refer to Cargo
 loading 118
Loading
 vehicle 118
Load-securing devices 120
Lock buttons on doors, refer
 to Locking 34
Lock, steering wheel 71
Locking
 from inside 34
 from outside 31, 33
Locking and unlocking
 doors
 from inside 34
 from outside 31, 33
Low beams 97
 automatic 97
 bulb replacement 149
 indicator lamp, defective
 lamp 88
Lug bolts
 key 154
 torque 154

Everything from A to Z

Luggage compartment
capacity [168](#)
emergency operation,
refer to Manual
operation [35](#)
enlarge volume [37](#)
floor panel [37](#)
lid [35](#)
opening from outside [35](#)
opening, remote
control [32](#)
opening/closing, refer
to Luggage compartment
lid [35](#)
remote control [32](#)
volume [168](#)

Luggage compartment lid [35](#)
emergency operation [35](#)
emergency release [36](#)
indicator lamp [88](#)
opening from inside the
vehicle [35](#)
opening from outside [35](#)
remote control [32](#)
securing separately [35](#)
unlocking manually [35](#)

Luggage compartment light-
ing [35](#)

Luggage rack, refer to Roof-
mounted luggage rack [121](#)

Lumbar support [54](#)

M

Maintenance [88](#), [142](#)
Maintenance system [142](#)
Making telephone calls,
refer to the telephone
Owner's Manual

Malfunction
convertible top [48](#)
door lock [33](#)
fuel filler door [24](#)

Malfunction displays [88](#)

Manual convertible top [41](#)
closing [44](#)
opening [42](#)
operation [41](#)

Manual operation
door lock [33](#)
driver's door [33](#)
fuel filler door [24](#)
luggage compartment
lid [35](#)
power convertible top [48](#)

Manual transmission [74](#)

Master keys [30](#)

MC operation, refer to the
Owner's Manual for
Radio/Onboard Computer

MD operation, refer to the
Owner's Manual for
Radio/Onboard Computer

Memory, refer to Seat and
mirror memory [57](#)

Memory, refer to Vehicle
Memory, Key Memory [70](#)

Microfilter
air conditioning [105](#)
automatic climate
control [110](#)

Microphone, refer to Cellular
phone [115](#)

Mini disc operation, refer to
the Owner's Manual for
Radio/Onboard Computer

Mirrors [59](#)
heated [59](#)
memory, refer to Seat and
mirror memory [57](#)

Mobile Service [158](#)

Modifications, technical,
refer to For your own
safety [5](#)

Multifunction steering
wheel [22](#)

Multifunction switch
turn signal indicator/head-
lamp flasher [82](#), [83](#)

N

Navigation system, refer to
the Owner's Manual for
Radio/Onboard Computer

Neck restraints, refer to
Head restraints [54](#)

Nets [114](#)

Nozzles, refer to Ventilation
[102](#), [106](#)

Nylon rope, refer to Towing
the vehicle [161](#)

O

OBD interface socket [143](#)

Odometer [86](#)

Oil
additives, refer to Adding
engine oil [139](#)
capacity [169](#)
dipstick [138](#)
quality [139](#)
specified engine oils [139](#)
viscosity [139](#)

Oil change intervals, refer
to Service interval
display [142](#)

Oil change intervals, refer to
the Service and Warranty
Information Booklet for US
models/Warranty and Ser-
vice Guide Booklet for
Canadian models

Oil consumption [138](#)

Oil dipstick [138](#)

Oil filter change [169](#)

Oil level
checking [138](#)
indicator lamp [18](#)

Oil pressure indicator lamp [18](#)
OIL SERVICE [88](#)
Oil types [139](#)
Old batteries, refer to Disposal [157](#)
Onboard computer [90](#)
Onboard computer, refer to the Owner's Manual for Onboard Computer
Onboard tool kit [148](#)
Opening and closing from outside [31](#)
from the inside [34](#)
via the door lock [33](#)
via the remote control [31](#)
Outlets, ventilation [102](#), [106](#)
Outside temperature display [90](#)
changing unit of measure [90](#)

P

Paintwork care, refer to the Caring for your vehicle brochure
Panic mode, trigger alarm [32](#)
Park Distance Control (PDC) [92](#)
Parking aid, refer to Park Distance Control (PDC) [92](#)

Parking brake [73](#)
indicator lamp [18](#)
Parking lamps [97](#)
bulb replacement [150](#)
Parking lamps/Low beams [97](#)
Parts and accessories, refer to Your individual vehicle [5](#)
Passenger-side exterior mirror tilt function [58](#)
PDC Park Distance Control [92](#)
Plastic, refer to the Caring for your vehicle brochure
Pollen, refer to Microfilter [105](#)
Pollen, refer to Microfilter/activated-charcoal filter [110](#)
Power output, refer to Engine data [166](#)
Power seat [53](#)
Power socket, cigarette lighter [116](#)
Pressure monitoring, tires Flat Tire Monitor [94](#)
Pressure, tires [25](#), [129](#)
Protective function electric power windows [41](#)

R

Radio remote control key, refer to Master key with remote control [30](#)
Radio, refer to the Owner's Manual for Radio
Rain sensor [83](#)
Raising the floor panel [37](#)
Range [91](#)
Reading lamps front [100](#)
rear [100](#)
Rear lamps bulb replacement [151](#)
indicator lamp, defective lamp [88](#)
Rear window defroster air conditioning [104](#)
Rear window heating automatic climate control [109](#)
Rear-entry assist [55](#)
Rearview mirror [59](#)
Receiving assistance [158](#)
Recirculated-air mode air conditioning [104](#)
automatic climate control [109](#)
Recirculating the air, refer to Recirculated-air mode [104](#), [109](#)

Reclining seat, refer to Seat adjustment [53](#)
Refueling [24](#)
fuel filler door [24](#)
Releasing hood [134](#)
Remaining distance to service [88](#)
Remaining distance, refer to Range [91](#)
Remote control [31](#)
garage door opener [112](#)
luggage compartment lid [32](#)
malfunction [32](#)
Replacement key [31](#)
Replacing lamps, refer to Lamps and bulbs [149](#)
Replacing tires [130](#)
Reporting safety defects [7](#)
Restraint systems for children [64](#)
Restraint systems, refer to Safety belts [56](#)
Reverse automatic transmission with Steptronic [79](#)
SMG gearbox [76](#)
Reverse gear manual transmission [74](#)

Everything from A to Z

Rollover protection
system [68](#)
indicator lamp [19](#)
lowering [68](#)
Roof load capacity [168](#)
Roof-mounted luggage
rack [121](#)
Rope, refer to Towing the
vehicle [161](#)
Run Flat tires [131](#), [156](#)

S

Safe seating position [52](#)
Safety belt height adjust-
ment [56](#)
Safety belts [56](#)
seat-integrated safety belt
system [55](#)
sitting safely [52](#)
warning lamp [18](#)
Safety systems, refer to
Antilock Brake
System [125](#)
Dynamic Stability Control
(DSC) [93](#)
Screwdriver, refer to
Onboard tool kit [148](#)
Seat adjustment [53](#)
BMW sports seat [53](#)
power [53](#)
Seat belt tensioner, refer to
Safety belts [56](#)

Seat heating [58](#)
Seat memory, refer to Seat
and mirror memory [57](#)
Seat positions, storing [57](#)
Seats [53](#)
Securing cargo [120](#)
Securing child-restraint sys-
tem [66](#)
Securing the vehicle
from inside [34](#)
from outside [31](#), [33](#)
Selector lever
automatic transmission [79](#)
sequential manual gear-
box SMG [75](#)
Selector lever lock, refer to
Shiftlock [75](#), [79](#)
Selector lever positions
automatic transmission [79](#)
sequential manual gear-
box SMG [75](#)
Sequential manual gearbox
SMG [75](#)
indicator lamp [19](#)
Service and Warranty Infor-
mation Booklet [142](#)
Service Engine Soon
warning lamp [19](#)
Service interval display
[88](#), [142](#)
Shift paddles [76](#)

Shifting gears
automatic transmission
with Steptronic [79](#)
sequential manual gear-
box SMG [76](#)
Shiftlock [75](#)
Shiftlock, refer to Range
selection [79](#)
Side airbags [61](#)
Side turn signal indicators
bulb replacement [151](#)
Sitting safely
with airbags [52](#)
with safety belts [52](#)
Size [167](#)
Ski bag [117](#)
Slipstream deflector, refer to
Wind deflector [50](#)
SMG sequential manual
gearbox [75](#)
indicator lamp [19](#)
Smokers' package, refer to
Ashtray [115](#)
Snow chains [133](#)
SOS, refer to Emergency
call [158](#)
Space-saver spare tire
changing a wheel [153](#)
Spare key [30](#)
Spare tire [153](#)
Spare wheel [156](#)
Special oils [139](#)

Specified oils [139](#)
Speed gauge, refer to
Speedometer [16](#)
Speedometer [16](#)
SPORT button [78](#)
Sport program
automatic transmission
with Steptronic [80](#)
Sports seat [53](#)
Stability control, refer to
Dynamic Stability Control
(DSC) [93](#)
Standing lamps [99](#)
Starting difficulties
jump-starting [159](#)
temperature [71](#)
Starting help DSC [93](#)
Starting the engine [71](#)
Starting, refer to Starting the
engine [71](#)
Status of the Owner's Man-
ual [5](#)
Steering wheel lock [71](#)
Steering wheel, adjusting [59](#)
Steptronic, refer to Manual
operation [80](#)
Storage compartments [114](#)
Storage nets [114](#)
Storing seat positions,
refer to Seat and mirror
memory [57](#)
Storing tires [132](#)

Stroke, refer to Engine data [166](#)
Surface ice, refer to Ice warning [90](#)
Switches, refer to Cockpit [14](#)
Switching off engine [73](#)
vehicle [73](#)
Symbols [4](#)
Synthetic oils [139](#)

T
Tachometer [86](#)
Tail lamps bulb replacement [151](#)
Tail lamps, refer to Rear lamps [151](#)
Tank capacity, refer to Fuel tank capacity [169](#)
Tank indicator, refer to Fuel gauge [87](#)
Technical data [166](#)
Technical modifications [5](#)
Technical modifications, refer to For your own safety [5](#)
Telephone hookup [115](#)
Telephone, refer to the separate Owner's Manual

Television, refer to the Owner's Manual for Onboard Computer
Temperature air conditioning [104](#)
automatic climate control [108](#)
Temperature adjustment [104](#), [108](#)
Temperature display engine coolant [87](#)
ice warning [90](#)
outside temperature [90](#)
setting units [90](#)
Temperature layering [105](#), [109](#)
Tempomat, refer to Cruise control [84](#)
Thigh support area, adjusting [53](#)
Third brake lamp, refer to Center high-mount brake lamp [152](#)
Three-point safety belt [56](#)
Tilt alarm sensor [32](#)
remote control [32](#)
switching off [32](#), [39](#)
Tilting passenger-side exterior mirror [58](#)
Time [89](#)

Tire pressure monitoring, refer to Flat Tire Monitor [94](#)
Tire replacement [130](#), [153](#)
Tires age [131](#)
breaking in [124](#)
changing [153](#)
damage [129](#)
flat [153](#)
inflation pressure [25](#), [129](#)
replacing [130](#)
size, refer to Wheel and tire combinations [132](#)
storing [132](#)
tread [129](#)
tread wear indicator, refer to Tire tread – tire damage [129](#)
winter tires [132](#)
Tools, refer to Onboard tool kit [148](#)
Torque engine [166](#)
lug bolts [154](#)
Tow sockets for towing eyelet [161](#)
Towing bar [161](#)
Towing eyelet [161](#)
Towing rope [161](#)
Towing the vehicle [161](#)

Track width, refer to Dimensions [167](#)
Transmission automatic transmission with Steptronic [79](#)
sequential manual gearbox SMG [75](#)
Transmission lock, refer to P Park [79](#)
Transmission malfunction automatic transmission with Steptronic [81](#)
sequential manual gearbox SMG [77](#)
Transport securing devices, refer to Securing cargo [120](#)
Transporting children safely [64](#)
Trap protection electric power windows [41](#)
Tread depth, refer to Tire tread [129](#)
Tread depth, tires [129](#)
Tread wear indicator in the tires, refer to Tire tread – tire damage [129](#)
Trip distance recorder, refer to Trip odometer [86](#)
Trip meter, refer to Trip odometer [86](#)
Trip odometer [86](#)

Everything from A to Z

Trunk lid, refer to Luggage compartment lid [35](#)

Trunk lighting, refer to Luggage compartment lighting [35](#)

Turn signal indicator [82](#), [83](#)
bulb replacement [151](#)
indicator lamp [20](#)

Turn signal indicator, side
bulb replacement [151](#)

Turning circle, refer to
Dimensions [167](#)

TV function, refer to the
Owner's Manual for
Onboard Computer

U

Underbody protection, refer
to the Caring for your vehicle
brochure

Uniform Tire Quality
Grading [131](#)

Units

average fuel
consumption [91](#)
temperature [90](#)

Universal garage door control,
refer to Integrated universal
remote control [112](#)

Universal remote control
[112](#)

Unlocking

from inside [34](#)

from outside [31](#), [33](#)

V

Valve

screw caps [154](#)

Vehicle

battery [157](#)

break-in procedures [124](#)

dimensions [167](#)

loading [118](#)

starting [71](#)

switching off [73](#)

washing, refer to the Caring
for your vehicle brochure
[83](#)

weight [168](#)

Vehicle Memory [70](#)

Vehicle weight [168](#)

Ventilation [102](#), [106](#)

draft-free [105](#), [109](#)

Voice Input System [22](#)

Voice recognition, refer to
separate Owner's Manual

Volume

luggage compartment [168](#)

W

Warning and indicator

lamps [18](#)

Warning lamp 'Fasten safety
belts' [18](#)

Warning messages [88](#)

Warranty and Service Guide
Booklet [142](#)

Warranty, refer also to separate
booklet [7](#)

Washer fluid

adding [138](#), [169](#)

Washer fluid reservoir [138](#)

volume [138](#)

Washer jets, refer to Windshield
washer jets [84](#)

Washer/wiper system [84](#)

washer fluid [138](#)

Waste tray, refer to
Ashtray [115](#)

Water on roadways, deep

water [125](#)

Weights [168](#)

Wheel and tire

combinations [132](#)

Wheelbase, refer to Dimensions
[167](#)

Wheels and tires [132](#)

Wheelslip control DSC [93](#)

Width, refer to

Dimensions [167](#)

Wind deflector [50](#)

Window condensation

removing [105](#), [108](#)

Windows

convenience operation

[32](#), [33](#)

power [40](#)

remote control [31](#), [32](#)

Windshield washer

nozzles [84](#)

Windshield washer reservoir

volume, see

Capacities [169](#)

Winter tires [132](#)

storing [132](#)

Wiper blades, replacing [148](#)

Work in the engine compartment
[134](#)

Wrench, refer to Onboard
tool kit [148](#)

X

Xenon lamps

bulb replacement [150](#)

Refueling



To ensure that you always have convenient access to all essential information when you stop for fuel, we recommend that you fill out the adjoining chart by entering the data that apply to your vehicle. Consult the index for individual specifications.

Fuel

Designation	
-------------	--

Please enter your preferred fuel here.

Engine oil

Quality	
---------	--

The oil volume between the two marks on the dipstick corresponds to approx. 1.1 US quarts/1 liter.

Tire inflation pressure

	Summer tires		Winter tires	
	Front	Rear	Front	Rear
Up to 2 persons				
4 persons plus luggage				

More about BMW

bmwusa.com



The Ultimate
Driving Machine

01 41 0 157 599 ue

Free Manuals Download Website

<http://myh66.com>

<http://usermanuals.us>

<http://www.somanuals.com>

<http://www.4manuals.cc>

<http://www.manual-lib.com>

<http://www.404manual.com>

<http://www.luxmanual.com>

<http://aubethermostatmanual.com>

Golf course search by state

<http://golfingnear.com>

Email search by domain

<http://emailbydomain.com>

Auto manuals search

<http://auto.somanuals.com>

TV manuals search

<http://tv.somanuals.com>