

Owner's Manual  
for Vehicle



**320i**  
**325i**  
**325xi**  
**330i**  
**330xi**

Congratulations, and thank you for choosing a BMW.

Thorough familiarity with your vehicle will provide you with enhanced control and security when you drive it. Therefore we have one request:

Please take the time to read this Owner's Manual and familiarize yourself with the information that we have compiled for you before starting off in your new BMW. The manual contains important data and instructions intended to assist you in obtaining maximum satisfaction from your BMW's unique array of advanced technical features. It also contains information on vehicle maintenance designed to enhance operating safety while simultaneously helping you to maintain your BMW's value throughout an extended service life. For additional information refer to the supplemental manuals.

This Owner's Manual should be considered a permanent part of this vehicle. It should stay with the vehicle when sold to provide the next owner with important operating, safety and maintenance information.

We wish you an enjoyable driving experience.

BMW AG

## 4 Notes

### About this Owner's Manual

We have made every effort to ensure that you are able to find what you need in this Owner's Manual as quickly as possible. The fastest way to find specific topics is by using the detailed index at the end. If you wish to gain an initial overview of your vehicle, you will find this in the first chapter.

Should you wish to sell your BMW at some time in the future, please remember to hand over this Owner's Manual to the new owner; it is an important part of the vehicle.

If you have any additional questions, your BMW center will be glad to advise you.

© 2002 Bayerische Motoren Werke  
Aktiengesellschaft  
Munich, Germany

Reprinting, including excerpts, only with the  
written consent of BMW AG, Munich.

Order No. 01 41 0 156 804

US English VIII/02

Printed in Germany

Printed on environmentally friendly paper –  
bleached without chlorine, suitable for recycling.

### Symbols used



Indicates precautions that must be followed precisely in order to avoid the possibility of personal injury and serious damage to the vehicle.



Contains information that will assist you in gaining the optimum benefit from your vehicle and enable you to care more effectively for your vehicle.



Refers to measures that can be taken to help protect the environment.

▣ Marks the end of a specific item of information.

\* Indicates special equipment, country-specific equipment and optional extras.



Identifies systems or components which can be activated or adapted to suit an individual driver's requirements – Vehicle Memory, Key Memory. Refer to page 59. Activation and adjustments on some of these systems can be performed at your BMW center.

### Your individual vehicle

On purchasing your BMW, you have decided in favor of a model with individualized equipment and features. This Owner's Manual describes all models and equipment that BMW offers within the same group.

We hope you will understand that equipment and features are included that you might not have chosen for your vehicle. You can easily identify any differences with the aid of the asterisk \* used to identify all optional equipment and accessories.

If your BMW features equipment which is not described in this Owner's Manual such as a car radio or telephone, Supplementary Owner's Manuals are enclosed. We ask you to read these manuals as well.

### Status at time of printing

BMW pursues a policy of continuous, ongoing development conceived to ensure that our vehicles continue to embody the highest quality and safety standards combined with advanced, state-of-the-art technology. For this reason, the features described in this Owner's Manual could differ from those on your vehicle. Nor can errors and omissions be entirely ruled out. You are therefore asked to appreciate that no claims can be recognized on the basis of the data, illustrations or descriptions in this Owner's Manual.

### For your own safety



Use unleaded gasoline only. Fuels containing up to and including 10% ethanol or other oxygenates with up to 2.8% oxygen by weight – that is, 15% MTBE or 3% methanol plus an equivalent amount of co-solvent – will not void the applicable warranties respecting defects in materials or workmanship. Field experience has indicated significant differences in fuel quality – volatility, composition, additives, etc. among gasolines offered for sale in the United States and Canada. The use of poor-quality fuels may result in driveability, starting and stalling problems, especially under certain environmental conditions, such as high ambient temperature and high altitude. Should you encounter driveability problems which you suspect could be related to the fuel you are using, we recommend that you respond by switching to a recognized high-quality brand.

Failure to comply with these recommendations may result in unscheduled maintenance.

Obey all applicable safety rules when handling gasoline. ◀



**Important safety information!** For your own safety, use genuine parts and accessories approved by BMW. When you purchase accessories tested and approved by BMW and Original BMW Parts, you simultaneously acquire the assurance that they have been thoroughly tested by BMW to ensure optimum performance when installed on your vehicle. BMW warrants these parts to be free from defects in material and workmanship. BMW will not accept any liability for damage resulting from installation of parts and accessories not approved by BMW. BMW cannot test every product on the market to determine whether it can be used on a BMW safely and without risk to either the vehicle, its operation, or its occupants. Original BMW Parts, BMW Accessories and other products approved by BMW, together with professional advice on using these items, are available from all BMW centers. Installation and operation of non-BMW approved accessories such as alarms, radios, amplifiers, radar detectors, wheels, suspension components, brake

## 6 Notes

dust shields, telephones – including operation of any portable cellular phone from within the vehicle without using an externally mounted antenna – or transceiver equipment such as a CB, walkie-talkie, ham radio or similar, may cause extensive damage to the vehicle, compromise its safety, interfere with the vehicle's electrical system or affect the validity of the BMW Limited Warranty. See your BMW center for additional information.

Do not use key or remote control to lock doors or luggage compartment with anyone inside the vehicle. Refer to the Owner's Manual for more details. ◀



Maintenance, replacement, or repair of the emission control devices and systems may be performed by any automotive repair establishment or individual using any certified automotive part. ◀

### Symbol on vehicle parts



Indicates that you should consult the relevant section of this Owner's Manual for information on a particular part or assembly.

### Service and warranty

This manual is supplemented by a Service and Warranty Information Booklet for US models or a Warranty and Service Guide Booklet for Canadian models.

We recommend that you read this publication thoroughly.

Your BMW is covered by the following warranties:

- ▷ New Vehicle Limited Warranty
- ▷ Rust Perforation Limited Warranty
- ▷ Federal Emissions System Defect Warranty
- ▷ Federal Emissions Performance Warranty
- ▷ California Emission Control System Limited Warranty.

Detailed information about these warranties is listed in the Service and Warranty Information Booklet for US models or in the Warranty and Service Guide Booklet for Canadian models.

### Reporting safety defects

The following only applies to vehicles owned and operated in the US.

If you believe that your vehicle has a defect which could cause a crash or could cause injury or death, you should immediately inform the National Highway Traffic Safety Administration NHTSA in addition to notifying BMW of North America, LLC, P.O. Box 1227, Westwood, New Jersey 07675-1227, Telephone toll-free 1-800-831-1117.

If NHTSA receives similar complaints, it may open an investigation, and if it finds that a safety defect exists in a group of vehicles, it may order a recall and remedy campaign. However, NHTSA cannot become involved in individual problems between you, your dealer, or BMW of North America, LLC.

To contact NHTSA, you may either call the Auto Safety Hotline toll-free at 1-800-424-9393 or 366-0123 in the Washington, D.C. area, or write to: NHTSA, U.S. Department of Transportation, Washington, D.C. 20590. You can also obtain other information about motor vehicle safety from the Hotline.



# Contents

## Notes

- About this Owner's Manual 4
- Symbols used 4
- Your individual vehicle 4
- Status at time of printing 5
- For your own safety 5
- Symbol on vehicle parts 6
- Service and warranty 6
- Reporting safety defects 6

## Overview

- Cockpit 14
- Instrument cluster 16
- Indicator and warning lamps 18
- Steering wheel with multifunction buttons\* 22
- Hazard warning triangle\* 23
- First-aid kit\* 23
- Refueling 24
- Fuel specifications 25
- Tire inflation pressure 25

## Controls and features

### Opening and closing:

- Keys 30
- Central locking system 30
- Opening and closing – via the remote control 31
- Opening and closing – via the door lock 33
- Opening and closing – from the inside 34
- Luggage compartment lid 35
- Luggage compartment 37
- Alarm system\* 38
- Electric power windows 40
- Sliding/tilt sunroof\* 41

### To adjust:

- Safe seating position 44
- Seats 44
- Manual seat adjustment 45
- Power seat adjustment\* 46
- Lumbar support\* 46
- Head restraints 47
- Safety belts 47
- Seat and mirror memory\* 49
- Seat heating\* 50
- Steering wheel 51
- Mirrors 51

### Passenger safety systems:

- Airbags 53
- Transporting children safely 55
- Vehicle Memory, Key Memory 59



# Contents

<b>Controls and features</b>	<b>Driving:</b>			
	Ignition lock	60		
	Starting the engine	60		
	Switching off the engine	62		
	Parking brake	62		
	Manual transmission	63		
	Automatic transmission with Steptronic*	64		
	Turn signal indicator/Headlamp flasher	67		
	Washer/wiper system/Rain sensor*	68		
	Cruise control*	69		
	<b>Everything under control:</b>			
	Odometer	71		
	Tachometer	71		
	Energy control	71		
	Fuel gauge	72		
	Engine coolant temperature gauge	72		
	Service interval display	73		
	Check Control	73		
	Clock	74		
	Computer*	75		
	<b>Technology for safety and driving convenience:</b>			
	Park Distance Control (PDC)*	77		
	Automatic Stability Control plus Traction (ASC+T)*	78		
	Dynamic Stability Control (DSC)*	80		
	Dynamic Stability Control (DSC) – BMW 325xi, 330xi	82		
	Hill Descent Control (HDC)*	84		
	Tire Pressure Monitor (TPM)*	85		
	Flat Tire Monitor*	86		
	<b>Lamps:</b>			
	Parking lamps/Low beams	89		
	Instrument lighting	90		
	High beams/Standing lamps	90		
	Fog lamps*	91		
	Interior lamps	91		
	<b>Controlling the climate for pleasant driving:</b>			
	Air conditioning	92		
	Automatic climate control*	96		
	Roller sun blind*	100		
	<b>Interior conveniences:</b>			
	Premium sound system*	101		
	Glove compartment	101		
	Storage compartments	102		
	Cellular phone*	104		
	Ashtray, front*	104		
	Ashtray, rear*	105		
	<b>Loading and transporting:</b>			
	Through-loading system*	106		
	Ski bag*	107		
	Cargo loading	108		
	Roof-mounted luggage rack*	110		

# Contents

## Operation, maintenance

### Special operating instructions:

- Break-in procedures 114
- Driving notes 115
- Antilock Brake System (ABS) 115
- Brake system 116

### Wheels and tires:

- Tire inflation pressure 117
- Tire condition 117
- Tire replacement 118
- Wheel and tire combinations 120
- Winter tires 120

### In the engine compartment:

- Hood 122
- Engine compartment essentials 124
- Washer fluids 126
- Engine oil 126
- Coolant 128
- Brake fluid 129

### Maintenance:

- The BMW Maintenance System 130

### Laws and regulations:

- California Proposition 65 warning 131
- OBD interface socket 131

## Owner service procedures

### Replacement procedures:

- Onboard tool kit 136
- Windshield wiper blades 136
- Lamps and bulbs 137
- Changing a wheel 141
- Run Flat tires\* 145
- Battery 146
- Fuses 146

### Giving and receiving assistance:

- Jump-starting 147
- Towing the vehicle 148

## Technical data

- Engine data 152
- Dimensions 153
- Weights 154
- Capacities 155

# Contents

<b>Index</b>	Everything from A to Z	158
--------------	------------------------	-----

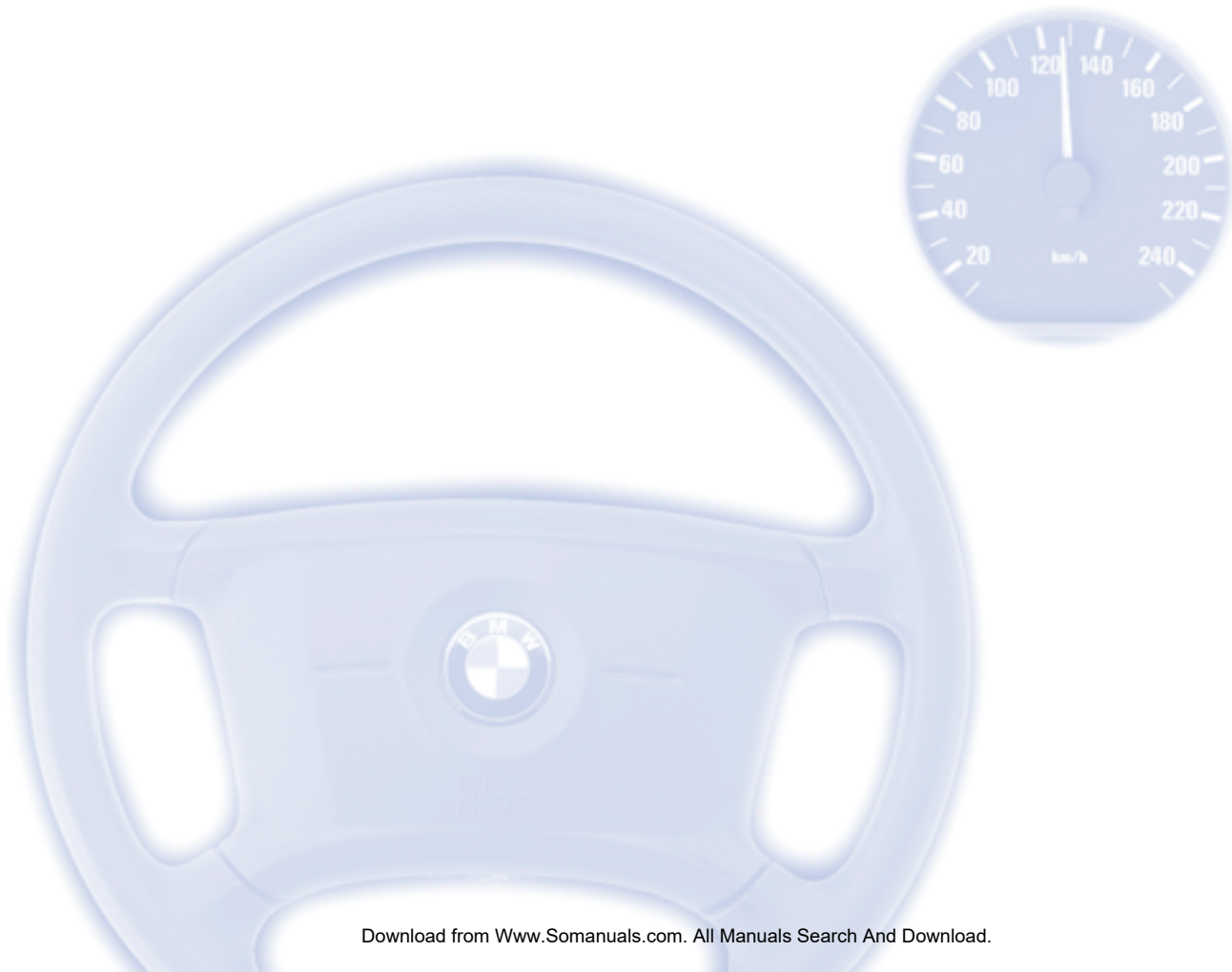

## Overview

Controls and features

Operation, maintenance

Owner service procedures

Technical data

Index



Overview

Controls

Maintenance

Repairs

Data

Index

## 14 Cockpit

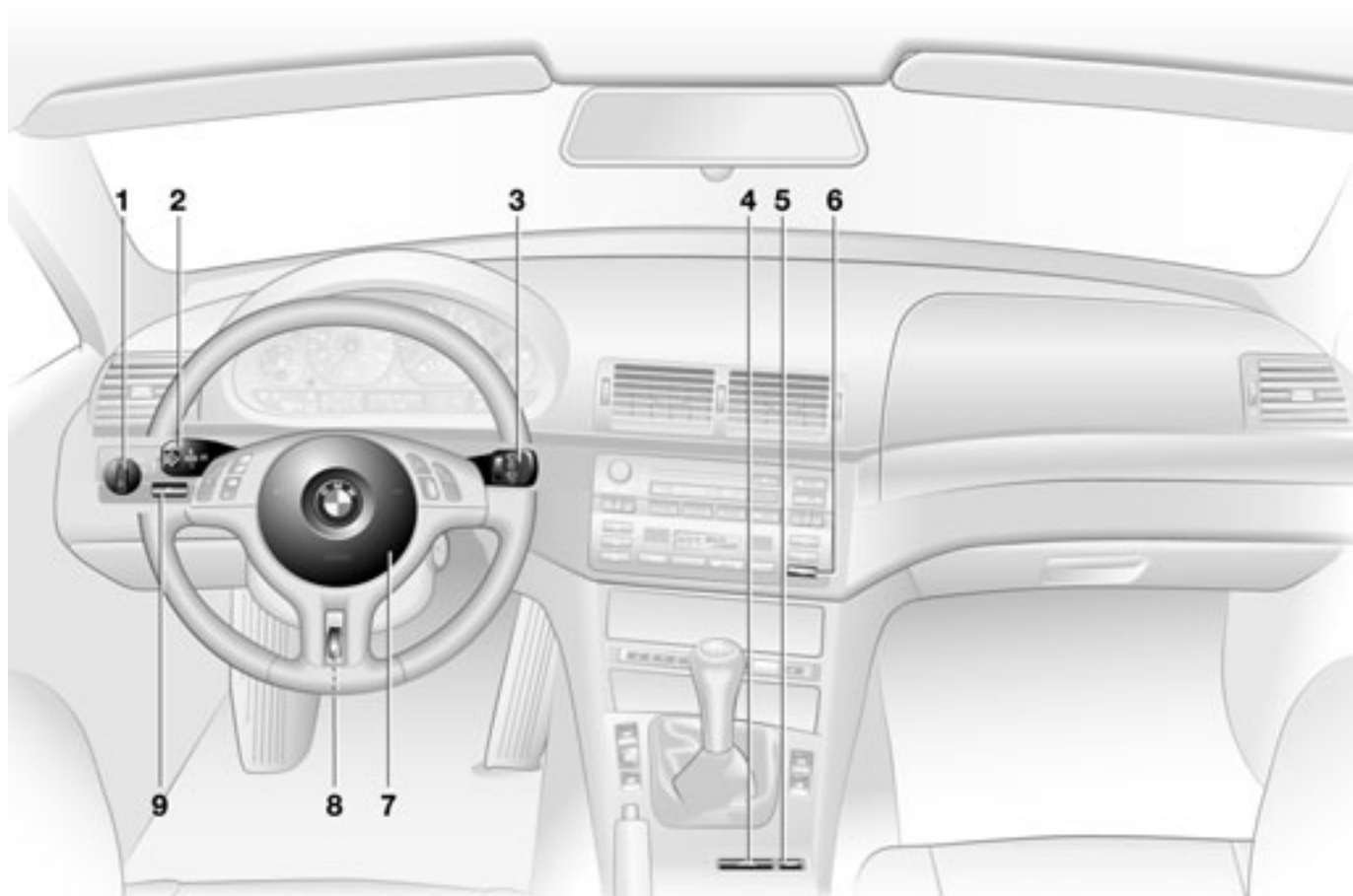

# Cockpit

- 1 Parking lamps/Low beams 89
- 2 ▷ Turn signal indicators 67
  - ▷ Standing lamps 90
  - ▷ High beams 90
  - ▷ Headlamp flasher 67
  - ▷ Computer 75
- 3 Washer/wiper system/Rain sensor 68
- 4 Hazard warning flashers
- 5 Central locking system 30
- 6 Rear window defroster 94, 99
- 7 Horn: the entire surface
- 8 Adjusting the steering wheel 51
- 9 Fog lamps 91

## 16 Instrument cluster





# Instrument cluster

- 1 Fuel gauge 72
- 2 Indicator lamp for turn signals 21
- 3 Speedometer
- 4 Indicator and warning lamps 18 to 21
- 5 Tachometer and Energy Control 71
- 6 Engine coolant temperature gauge 72
- 7 Indicator and warning lamps 18 to 21
- 8 Control button for the clock 74
- 9 Selector lever and program display for automatic transmission 19, 66
- 10 Display for
  - ▷ Trip odometer/Odometer 71
  - ▷ Clock 74
  - ▷ Service interval 73
  - ▷ Computer 75
- 11 Check Control 73
- 12 Trip odometer, reset to zero 71
- 13 Indicator and warning lamps 18 to 21

## 18 Indicator and warning lamps

### Technology that monitors itself

Indicator and warning lamps that are identified by ● are tested for proper functioning whenever the ignition key is turned. They each light up once for different periods of time.

If a fault should occur in one of these systems, the corresponding lamp does not go out after the engine is started, or it lights up while the vehicle is moving. You will see how to react to this below.

### Red: stop immediately

 Battery charge current ●  
The battery is no longer being charged. Indicates a defective alternator drive belt or a problem with the alternator's charge circuit. Please contact the nearest BMW center.

 If the drive belt is defective, stop and switch off the engine immediately to prevent overheating and serious engine damage. If the drive belt is defective, increased steering effort is also required. ◀

 Engine oil pressure ●  
Stop the vehicle immediately and switch off the engine.

Check the engine oil level; top off as required. If the oil level is correct: Please contact the nearest BMW center.



 Do not continue driving, as the engine could sustain serious damage from inadequate lubrication. ◀

 Brake warning lamp ●  
If the lamp comes on when the parking brake is not engaged: check the brake fluid level. Before driving further, be sure to comply with the instructions on pages [116](#) and [129](#)

 Parking brake warning lamp for Canadian models.

 Tire Pressure Monitor (TPM)/Flat Tire Monitor ●  
In addition, an acoustic signal is sounded: a tire failure has occurred. Reduce vehicle speed immediately and stop the vehicle. Avoid hard brake applications. As you steer the vehicle, use caution and avoid overcorrecting. For additional information: refer to pages [85](#), [86](#)

### Red and yellow: continue driving cautiously

 The brake warning lamp comes on together with the yellow indicator lamps for ABS ● and ASC+T/DSC:  
 The entire ABS, CBC, ASC+T/DSC and ADB/ADB-X/DBC control system has failed.  
 Continue driving cautiously and defensively. Avoid hard brake applications. Please have the system checked by your BMW center as soon as possible.

Additional information beginning on page [78](#)

 CBC, ABS and ASC+T/DSC and ADB/ADB-X/DBC indicator and warning lamps for Canadian models.





# Indicator and warning lamps

## Red: an important reminder

 Brake warning lamp  
Comes on when the parking brake is engaged – an additional acoustic signal sounds when starting off.

For additional information: refer to page [62](#)

 Parking brake warning lamp for Canadian models.

 Please fasten safety belts ●  
Comes on together with an acoustic signal until the safety belts are fastened.

For additional information on safety belts: refer to page [47](#)

 Airbags ●  
Please have the system inspected by your BMW center.

For additional information: refer to page [53](#)

## Orange: consult the nearest BMW center

 Automatic transmission  
The transmission has responded to a malfunction by reverting to operation in its emergency default program. Please consult the nearest BMW center.

For additional information: refer to page [64](#)

## Yellow: check as soon as possible

 Engine oil level  
If the lamp comes on during normal vehicle operation: the engine oil level has fallen to the absolute minimum; refill as soon as possible. Do not drive more than approx. 30 miles/50 km before refilling.  
For additional information: refer to page [126](#)

 Engine oil level  
Comes on after the engine has been switched off: add engine oil at your earliest opportunity, such as when you next stop to refuel.  
For additional information: refer to page [126](#)



Brake pads ●  
Have the brake pads checked.  
For additional information: refer to page [116](#)



Tire Pressure Monitor (TPM)/Flat Tire Monitor ●  
Check tire inflation pressures.  
Refer to pages [25](#), [85](#), [86](#)

## 20 Indicator and warning lamps



Automatic Stability Control plus Traction (ASC+T)/Dynamic Stability Control (DSC) ●

Indicator lamp flashes:

The system is actively regulating drive torque and braking force.

The indicator lamp stays lit:

The ASC+T has been switched off via the button, ADB is operational; or DSC has been switched off using the button, DTC is operational.

Please consult the nearest BMW center in case of a malfunction.

Additional information beginning on page [78](#)

BMW 325xi, 330xi:

DSC has been switched off manually or there is a system malfunction.

ADB-X is operational in its standby mode. If the warning lamp fails to go out when you press the DSC button again, this indicates a system malfunction affecting both DSC and ADB-X. Please consult the nearest BMW center.

For additional information: refer to page [82](#)



Automatic Stability Control plus Traction (ASC+T)/Dynamic Stability Control (DSC) and brake warning lamp ●



The indicator lamps remain on: The ASC+T/ADB or DSC/DTC

have been switched off manually or there is a system malfunction.

Please consult the nearest BMW center.

Additional information beginning on page [78](#)

BMW 325xi, 330xi:

DSC and ADB-X system malfunction. There is no provision for deactivating ADB-X.

Please consult the nearest BMW center.

For additional information: refer to page [82](#)



DSC and ADB indicator and warning lamps for Canadian models.



Dynamic Brake Control (DBC) ● Malfunction in DBC system.

Conventional braking efficiency is available and unrestricted.

Have the system repaired at your BMW center as soon as possible.

For additional information: refer to page [115](#)



Dynamic Brake Control (DBC) warning lamp for Canadian models.



Add washer fluid

The washer fluid level is too low. Top off the fluid at the earliest

opportunity.

For additional information: refer to page [126](#)



CHECK FILLER CAP ●

This indicator lamp comes on when the fuel filler cap is loose or missing.

Close the filler cap tightly: refer to page [24](#)



SERVICE ENGINE SOON ●

If the indicator lamp comes on either continuously or intermittently, this indicates a fault in the emissions-related electronic systems.

## Indicator and warning lamps

Although the vehicle remains operational, you should have the systems checked by your BMW center at the earliest possible opportunity. For additional information: refer to page [131](#)



SERVICE ENGINE SOON warning lamp for Canadian models.



Engine electronics ● There is a fault in the electronic engine-management system.

You can continue to drive with reduced engine output or engine speed. Please have the system inspected by your BMW center.



Add coolant  
The coolant level is too low. Add coolant at the earliest opportunity.

For additional information: refer to page [128](#)

### Green: for your information



Turn signal indicator  
Flashes when the turn signals are on.

Rapid flashing indicates a system malfunction.

For additional information: refer to page [67](#)



Cruise control  
Lights up when the cruise control is activated: ready for operation via the steering wheel with multi-function buttons.

For additional information: refer to page [69](#)



Front fog lamps  
Lights up whenever you switch on the fog lamps.

For additional information: refer to page [91](#)

### Blue: for your information



High beams  
Comes on when the high beams are on or the headlamp flasher is actuated.

For additional information: refer to pages [67](#), [90](#)

## 22 Steering wheel with multifunction buttons\*

These buttons let you operate the following functions quickly and without being distracted from traffic conditions:

- ▷ Selected radio functions
- ▷ The cruise control
- ▷ Selected telephone functions
- ▷ The voice recognition system.

 The controls are active only when the corresponding systems and accessories are switched on. ◀



Press briefly: receive a phone call, initiate dialing, terminate a call.

Extended pressure:

Switch voice recognition on and off.



Switch between phone, radio, cassette and CD.



Forward:

- ▷ Radio

Press briefly: station scan in FM band  
Extended pressure: station search

- ▷ CD

Press briefly: jump to next track  
Extended pressure: search function in track

- ▷ Cassette

Press briefly: jump to the next track or stop fast forward  
Extended pressure: fast forward

- ▷ Phone

Scan personal phone book.



Rewind: same functions as forward.



Volume.



Cruise control: select a stored setting.



Cruise control: store and accelerate + or decelerate and store -.

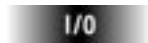

Cruise control: activate/interrupt/deactivate.

## Hazard warning triangle\*

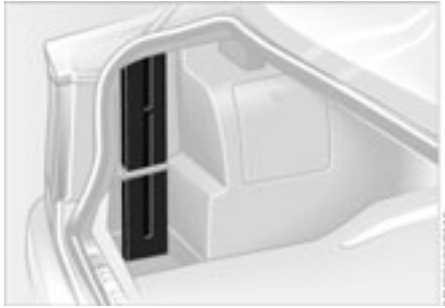

The hazard warning triangle is stored in a storage case on the left side of the luggage compartment.

 Always observe all legal regulations requiring a warning triangle to be carried in the vehicle. ◀

## First-aid kit\*

23



The first-aid kit is located under the passenger seat.

To release: pull the handle and fold the cover down.

To close: fold the cover up and press it until the tab engages.

 Some of the articles in the first-aid kit have a limited period of use before expiration. For this reason, check the expiration dates of each of the items regularly and replace any whose expiration dates have passed. You can purchase replacements in any drugstore or pharmacy. Always observe all legal regulations requiring a first-aid kit to be carried in the vehicle. ◀

Overview

Controls

Maintenance

Repairs

Data

Index



 Always observe all safety precautions posted at the service station when handling fuel. Never carry spare fuel containers in your vehicle. Whether empty or full, these containers can leak, cause an explosion, or lead to fire in the event of a collision. ◀



### **Fuel filler door**

 Always switch off the engine before refueling, as it is not possible to add fuel with the engine running, and attempts may also trigger the SERVICE ENGINE SOON lamp. ◀

Press on the rear edge of the fuel filler door to open and close it.

If an electrical malfunction occurs, you can unlock the fuel filler door manually:

1. Undo the trim panel on the right side of the luggage compartment
2. Pull the knob with the fuel pump symbol.

### **Simple and environmentally friendly**

 Open the filler cap carefully to prevent fuel from spraying out. Fuel spray may cause injury. ◀

Keep the filler cap in the bracket – see arrow – attached to the fuel filler door.

When refueling, insert the filler nozzle completely into the filler pipe. Pulling the nozzle out of the pipe during refueling

- ▷ results in premature pump shutoff
- ▷ and will reduce the effectiveness of the vapor recovery system on the pump.

The fuel tank is full when the filler nozzle shuts off the first time.



## Refueling

 Close the fuel filler cap carefully after refueling until a click is heard. While closing, be sure not to squeeze the strap which is fastened to the cap. A loose or missing cap will activate the CHECK FILLER CAP lamp. ◀

### Tank capacity

- ▷ Approx. 16.6 gal./63 liters, of which
- ▷ approx. 2.1 gal./8 liters are reserve capacity.

 Do not drive to the last drop of fuel. This can prevent the engine from operating properly and result in damage. ◀

## Fuel specifications

The engine uses lead-free gasoline only.

Required fuel:

- ▷ Premium Unleaded Gasoline, min. 91 AKI.  
AKI = Anti Knock Index

 Never use leaded fuel, as it would cause permanent and irreversible damage to the oxygen sensor and the catalytic converter. ◀

## Tire inflation pressure

25



The specified inflation pressures are provided on a sticker attached to the B-pillar and are visible with the driver's door open.

### Checking tire pressures

All pressures are specified in the standard units of pressure, psi and kilopascal, and apply to cold tires – tires at ambient temperature – refer to tire pressure table at the end of this chapter.

Vehicles with Tire Pressure Monitor (TPM)/Flat Tire Monitor:

After correcting the inflation pressures, reinitialize the system, refer to pages [85](#), [86](#).

## 26 **Tire inflation pressure**

Another instruction plate regarding inflation pressures on the door pillar indicates which system your vehicle is equipped with.



Check the tire pressures on a regular basis – at least twice a month – and before every extended journey. Otherwise, incorrect tire pressure can lead to poor handling, to tire damage and accidents.

Remember to check the inflation pressure in the space-saver or standard spare tire.

Inflate the spare tire to the highest inflation pressure specified for your vehicle. ◀

### **Comply with tire approval specifications**

The inflation pressures in the table apply to BMW approved tire sizes and tire manufacturers. Your BMW center can provide you with more information about these. Higher pressures may be required for tires made by other manufacturers.

Your vehicle is equipped with tires that not only meet US standards, but also European standards. We recommend the exclusive use of BMW approved tires.

## BMW Tires

All pressure specifications in the table are indicated in psi/kilo-pascal with cold tires – cold = ambient temperature



320i	205/55 R 16 91 H M+S, 205/55 R 16 91 H, 225/50 R 16 92 W, 225/45 R 17 91 W	29/200	33/230	33/230	41/280
	225/45 ZR 17	29/200	–	33/230	–
	245/40 ZR 17	–	33/230	–	41/280
	205/50 R 17 93 V M+S extra load, 205/50 R 17 93 W extra load, 195/65 R 15 91 Q M+S, 205/60 R 15 91 Q M+S, 205/55 R 16 91 Q M+S, 225/50 R 16 92 Q M+S, 205/50 R 17 93 Q M+S extra load, 225/45 R 17 91 Q M+S	32/220	36/250	36/250	44/300
325i	205/55 R 16 91 H M+S, 205/55 R 16 91 H,	30/210	35/240	35/240	42/290
325xi	225/50 R 16 92 W – not 325xi, 225/45 R 17 91 W				
	225/45 ZR 17	30/210	–	35/240	–
	245/40 ZR 17	–	35/240	–	42/290
	205/50 R 17 93 V M+S extra load, 205/50 R 17 93 W extra load, 205/55 R 16 91 Q M+S, 225/50 R 16 92 Q M+S – not 325xi, 205/50 R 17 93 Q M+S extra load, 225/45 R 17 91 Q M+S	33/230	38/260	38/260	45/310
330i	225/40 ZR 18	32/220	–	39/270	–
	255/35 ZR 18	–	38/260	–	46/320
330i	225/45 R 17 91 W	30/210	35/240	35/240	42/290
330xi	225/45 ZR 17	30/210	–	35/240	–
	245/40 ZR 17	–	35/240	–	42/290
	205/50 R 17 93 V M+S extra load, 205/50 R 17 93 W extra load, 205/50 R 17 93 Q M+S extra load, 225/45 R 17 91 Q M+S	33/230	38/260	38/260	45/310
All	Space-saver spare tire			61/420	



Overview

**Controls and features**

Operation, maintenance

Owner service procedures

Technical data

Index

Overview

Controls

Maintenance

Repairs

Data

Index

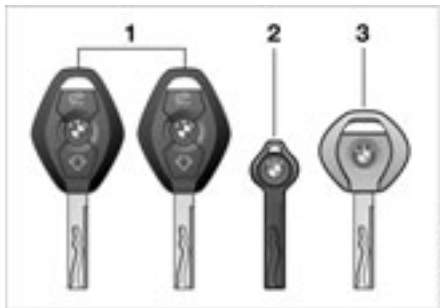

### The key set

- 1 Master key with remote control unit – determine the functions of the Key Memory, refer to page 59.

You can mark the individual keys for subsequent identification by applying the colored decals that you received when accepting delivery of your vehicle

▶ There is an extended-life battery in every master key that is charged automatically in the ignition lock as you drive.

For this reason, if you have master keys that are not being used otherwise, use those keys approximately once a year while driving for an extended period to charge the battery. ◀

- 2 Spare master key – for storage in a safe place, such as in your wallet. This key is not intended for constant use
- 3 Door and ignition key – the locks for the luggage compartment lid and the glove compartment cannot be operated with this key. This is useful for valet parking, for instance

## Central locking system

### The concept

The central locking system is ready for operation when the driver's door is closed. The system simultaneously engages and releases the locks on the

- ▷ doors
- ▷ luggage compartment lid
- ▷ fuel filler door.

The central locking system can be operated

- ▷ from outside via the remote control as well as via the driver's door lock
- ▷ from inside by pressing a button.

The fuel filler door is not locked when the central locking system is activated from the inside, refer to page 34. When the system is actuated from the outside, the anti-theft system is also activated. This prevents the doors from being unlocked via the lock buttons or the release handle. The alarm system is also activated or deactivated.

If locked from the inside, the central locking system unlocks automatically in the event of an accident, except on doors that have been locked individually using the lock buttons, refer to page 36. In addition, the hazard warning flashers and interior lamps come on.

# Opening and closing – via the remote control

## The concept

The remote control gives you an exceptionally convenient method for unlocking and locking your vehicle. Furthermore, it provides two additional functions:

▷ To switch on interior lamps, refer to page 32.

With this function you can also search for your vehicle when parked in an underground garage, for instance

▷ To open the luggage compartment lid, refer to page 32.

The luggage compartment lid will open slightly, regardless of whether it was previously locked or unlocked.

Whenever you unlock or lock the vehicle, you simultaneously deactivate/activate the anti-theft system, disarm/arm the alarm system and switch the interior lamps on/off.



You can have a signal set to confirm that the vehicle's locks have engaged securely. ◀

## Master keys with remote control



Persons or animals inside the vehicle may be able to lock the doors from the inside. For this reason, always take the vehicle keys with you so that the vehicle can be opened again from the outside at any time. ◀



If it is no longer possible to lock the vehicle via the remote control, the battery is discharged. Use this key while driving for an extended period in order to recharge the battery.

To prevent unauthorized use of the remote control, surrender only the door and ignition key or the spare key when leaving the vehicle for valet parking, for example.

In the event of a system malfunction, please contact your BMW center. You can also obtain replacement keys there. ◀



- 1 Unlock, convenience opening mode, and disarm alarm system
- 2 Lock and secure, arm alarm system, activate interior lamps, disarm tilt alarm sensor and interior motion sensor
- 3 Open the luggage compartment lid, panic mode – trigger alarm

## To release



Press the button once to unlock the driver's door.

Press the button a second time to disengage all vehicle locks.

## 32 Opening and closing – via the remote control

### Convenience opening mode



Press and hold button: the power windows and sliding/tilt sunroof are opened.

### To lock and secure



Press button.

### To switch on the interior lamps



With the vehicle locked, press button.

### To deactivate the tilt alarm\* and interior motion sensors\*



Press button a second time immediately after locking.

For additional information, refer to page [39](#).

### To open the luggage compartment



Press button.

The luggage compartment lid will open slightly, regardless of whether it was previously locked or unlocked.

 Before and after a trip, be sure that the luggage compartment lid has not been opened unintentionally. ◀

### Panic mode – trigger alarm



Provided that the alarm system is armed, you can respond to imminent danger by holding down the button for more than 2 seconds.

To switch off the alarm:



Press button.

### External systems

The remote control system's operation may be affected by other units or equipment operating in the immediate vicinity of your vehicle.

If this should occur, you can still open and close the vehicle using the master key in either the door or luggage compartment lid locks.

### For US owners only

The transmitter and receiver units comply with part 15 of the FCC Federal Communications Commission regulations. Operation is governed by the following:

FCC ID:

- ▷ LX8EWS
- ▷ LX8FZVS
- ▷ LX8FZVE.

Compliance statement:

This device complies with part 15 of the FCC Rules. Operation is subject to the following two conditions:

- ▷ This device may not cause harmful interference, and
- ▷ this device must accept any interference received, including interference that may cause undesired operation.

 Any unauthorized modifications to these devices could void the user's authority to operate the equipment. ◀



## Opening and closing – via the door lock



Whenever closing the windows or sliding/tilt sunroof you should always monitor their path and progress to ensure that no one is injured. Release the key to stop the windows or sliding/tilt sunroof. ◀

### Manual operation

In the event of electrical malfunction Turn the key to the extreme left or right to unlock/lock the driver's door.

One turn of the key in the driver's door lock unlocks the driver's door only. Turning the key a second time unlocks all of the remaining doors, the luggage compartment lid and the fuel filler door.



You can have a signal set to confirm that the vehicle's locks have engaged securely. ◀

### Convenience operation

You can also operate the power windows and the sliding/tilt sunroof via the door lock.

- ▷ To open: with the door closed, hold the key in the Unlock position
- ▷ To close: with the door closed, hold the key in the Lock position.

## 34 Opening and closing – from the inside



You can use this button to control the central locking system whenever the doors are closed. The doors and luggage compartment lid are unlocked or locked only. The anti-theft system is not activated.

 If only the driver's door was unlocked from the outside and you press the button, then, with the driver's door still open, the passenger-side door, the luggage compartment lid and the fuel filler door will unlock, too. If the driver's door is closed, it will be locked. ◀

 If you desire, the central locking system can be activated automatically as soon as you begin to drive. This can be adjusted to be key-specific. ◀

### To unlock and open the doors

- ▷ Either unlock the doors together with the button for the central locking system and then pull each of the release handles above the armrests or
- ▷ pull the release handle for each door twice: the first pull unlocks the door, and the second one opens it.

### To lock

- ▷ Either use the central locking button to lock all doors at once or
- ▷ press down the individual door lock buttons. The fuel filler door remains unlocked. To prevent the driver from being inadvertently locked out of the vehicle, the driver's door lock button will not engage as long as the door is open.



Persons or animals inside the vehicle may be able to lock the doors from the inside. For this reason, always take the vehicle keys with you so that you can open the vehicle again from the outside at any time. ◀



## The lock

Only the master keys fit in the lock for the luggage compartment lid, refer to page 30.

## To secure separately

Turn the master key to the right past the resistance point and then pull it out in the horizontal position.

This locks the luggage compartment lid and disconnects it from the central locking system. This feature can be used to prevent unauthorized access to the luggage compartment when you surrender the door and ignition key only, refer to page 30. This can be advantageous for valet parking, for example.

## To open from the outside

Press the button in the handle recess – see arrow: the luggage compartment lid opens slightly.

The luggage compartment is lit when the luggage compartment lid is opened.

## Manual operation

In the event of electrical malfunction  
Turn the master key all the way to the left – the luggage compartment lid will open slightly.

The luggage compartment lid is locked again as soon as you close the lid.

Refer also to "To open from the inside" on page 36.

## 36 Luggage compartment lid

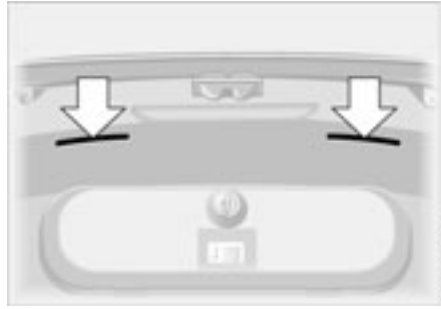



### To open from the inside\*

If the luggage compartment lid has not been locked separately, you can open it with this button in the footwell on the driver's side when the vehicle is stationary.

### To close

The handle recesses in the interior trim panel of the luggage compartment lid – see arrows – make it easier to pull the lid down.

 To avoid injuries, be sure that the travel path of the luggage compartment lid is clear when it is closed, following the same precautions as with all closing procedures. ◀

 Operate the vehicle only when the luggage compartment lid is closed. Otherwise, exhaust fumes could penetrate the interior of the vehicle. ◀

Should it be absolutely necessary to operate the vehicle with the luggage compartment lid open:

1. Close all windows. Shut the sliding/tilt sunroof
2. Greatly increase the quantity of air coming from the air conditioning or automatic climate control system, see page [92](#) or [96](#).

## Luggage compartment lid



### Emergency release

This lever releases the luggage compartment lid from the luggage compartment's interior.

## Luggage compartment 37



### Floor panel

Lift the floor panel with the ring, then use the tab to suspend it from the weather-stripping on the drip rail – see arrow.

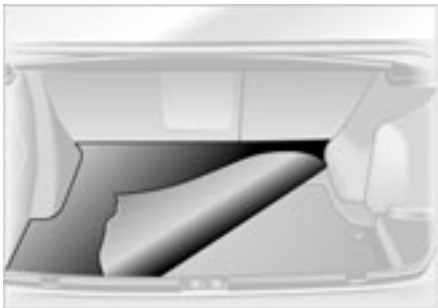

### Floor mat

You can turn the floor mat over to transport soiled objects, etc. The rubber-coated side is suitable for washing and is also designed to inhibit sliding.

The fittings at the corners of the luggage compartment provide you with a convenient means of attaching luggage nets\* and flexible straps for securing luggage.

Refer also to Cargo loading on page 108.

## Alarm system\*

### The concept

The vehicle alarm system responds:

- ▷ When a door, the hood or the luggage compartment lid is opened
- ▷ To movement inside the vehicle – interior motion sensor
- ▷ To variations in the vehicle's tilt angle such as those occurring during attempts to steal the wheels or tow the vehicle – tilt alarm sensor
- ▷ To interruption of battery voltage.

The system responds to unauthorized vehicle entry and attempted theft by simultaneously activating the following:

- ▷ The acoustic alarm sounds for 30 seconds
- ▷ The hazard warning flashers are activated for approx. five minutes
- ▷ The high beams flash on and off in rhythm with the hazard warning flashers.

### To arm and disarm the alarm system

When the vehicle is locked or unlocked via the driver's door lock or with the remote control, the alarm system is also simultaneously armed or disarmed.



You can have different acknowledgment signals set to confirm arming and disarming. ◀



You can also open the luggage compartment lid when the system is armed by pressing the remote control button, refer to page 32. The lid is once again secured when it is closed.

## Alarm system\*



### Indicator lamp displays

- ▷ The indicator lamp below the interior rearview mirror flashes continuously: the system is armed
- ▷ The indicator lamp flashes during arming: the door(s), the hood or luggage compartment lid are not completely closed. Even if you do not close the alerted area(s), the remaining areas are secured, and the indicator lamp will flash continuously after 10 seconds. However, the interior motion sensor is not activated
- ▷ If the indicator lamp goes out when the system is disarmed: no manipulation or attempted intrusions have been detected in the period since the system was armed
- ▷ If the indicator lamp flashes for 10 seconds when the system is dis-

armed: an attempted entry has been detected in the period since the system was armed.

Following triggering of an alarm, the indicator lamp will flash continuously.

### Avoiding unintentional alarms

The tilt alarm sensor and interior motion sensor may be switched off at the same time. You can do this to prevent a false alarm from being triggered in garages with elevator ramps, for instance, or when the vehicle is transported by train:



Lock the vehicle twice, i.e. arm the system. Press button on the remote control twice in succession or lock the vehicle twice with the key.

The indicator lamp lights up briefly and then flashes continuously. The tilt alarm sensor and interior motion sensor are deactivated for as long as the system remains armed.

### Interior motion sensor

In order for the interior motion sensor to function properly, the windows and the sliding/tilt sunroof must be completely closed.

Nevertheless, you should deactivate the interior motion sensor, refer to previous column, if

- ▷ persons or animals are left in the vehicle
- ▷ the windows or the sliding/tilt sunroof are being left open.

▶ The system deactivates the tilt-alarm sensor and the interior motion sensor if the convenience closing of windows is interrupted in the first 10 seconds and then restarted. The alarm must then be disarmed and reactivated before it will resume operation. ◀



▷ Press the switch briefly past the pressure point: the window moves automatically. Pressing the switch again stops the opening cycle.

You can close the windows in the same manner by pulling the switch.

Separate switches are located under the windows in the rear passenger area.

For the convenience mode via the remote control or the door lock, refer to page [32](#) or [33](#).

### To open and close windows

 When leaving the vehicle, always remove the ignition key from the lock and remember to close the doors to prevent children from operating the power windows and injuring themselves, etc. ◀

After the ignition has been switched off: You can still operate the electric power windows for up to 15 minutes, as long as no one opens either of the front doors.

With the ignition key in position 1 or higher:

▷ Press the switch until you feel resistance: the window retracts as long as you maintain pressure on the switch



Despite this safety feature, be extremely careful to ensure that the closing path of the window is not obstructed. Some types of objects might fail to trigger the contact strip in some situations – very thin objects, for instance.

You can override this safety feature by pressing the switch beyond the resistance point and holding it. ◀

### Safety feature

A contact strip is located on the inside upper frame of each of the front windows. If pressure is exerted against this contact strip while a window is being raised, the system will respond by stopping the window and then retracting it a small distance.



## Electric power windows



### Safety switch

With the safety switch, you can prevent the rear windows from being opened or closed via the switch in the rear passenger area – by children, for example.

 Press the safety switch whenever children are riding in the rear of the vehicle. Careless use of the power windows can lead to injury. ◀

## Sliding/tilt sunroof\*

41

 To prevent injuries, exercise care when closing the sliding/tilt sunroof and keep it in your field of vision until it is shut. When leaving the vehicle, always extract the ignition key from the lock and remember to close the doors to prevent children from operating the sliding/tilt sunroof and injuring themselves, etc. ◀



### Opening and closing

With the ignition key in position 1 or higher

- ▷ Slide the switch until you feel resistance: the sunroof opens and closes as long as you hold the switch
- ▷ Slide the switch past the pressure point: the sunroof moves automatically.

Tapping the switch again stops the motion immediately.

The headliner retracts with the sunroof while it is opening.

After the ignition has been switched off: you can still operate the sunroof for up to 15 minutes, as long as no one opens either of the front doors.

To use the convenience mode via the remote control or the door lock, refer to page 32 or 33.

### Raising the sunroof

With the ignition key in position 1 or higher: tap the switch.

Tapping the switch again stops the motion immediately.

If you briefly press the switch in the raise direction while the sunroof is open, the sunroof will rise to its uppermost position.

After the ignition has been switched off: you can still operate the sunroof for up to 15 minutes, as long as no one opens either of the front doors.

The headliner insert slides back somewhat when you raise the roof.

 Do not use force to close the headliner insert with the sunroof in its raised position, as damage to the mechanism could result. ◀

### Safety feature

If the sliding/tilt sunroof encounters resistance

- ▷ when it is closing from the raised position

▷ when it is closing from a point roughly past the middle of its travel the closing cycle is interrupted and the sliding/tilt sunroof will open again slightly.

 Despite this safety feature, be extremely careful that the travel path of the sunroof is not obstructed whenever it is closed. Remember that the safety mechanism may not be able to detect obstructions under all circumstances – with very thin objects, for instance.

You can disable this safety feature by pressing the switch beyond the pressure point and holding it. ◀

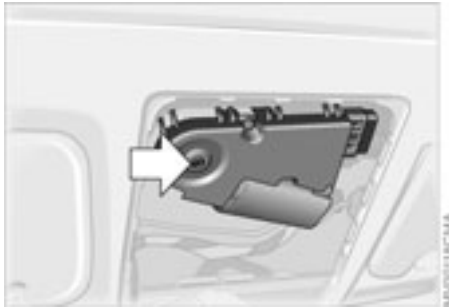

### Manual operation

In the event of an electrical malfunction, you can also operate the sliding/tilt sunroof manually:

1. Remove the interior lamp, then reach into the exposed opening and press out the cover
2. Use the Allen key from the onboard tool kit, refer to page 136, to turn the sliding/tilt sunroof in the desired direction.

## 44 Safe seating position

For relaxed and fatigue-free driving you should select a sitting position that reflects your personal requirements. In combination with the safety belts and airbags, the correct seating position plays an important role in enhancing occupant safety in the event of an accident. To ensure that the vehicle's safety systems provide you with optimal protection, we request that you direct your careful attention to the following section.

For supplementary information on transporting children, refer to page 55.

### Sitting safely with airbags

 Always maintain an adequate distance between yourself and the airbags. Always hold the steering wheel by the rim to keep any chance of injury to hands or arms to an absolute minimum should the airbag be deployed. Never allow any objects, individuals or animals to obstruct the areas between passengers and airbags. Never use the front airbag's cover as a storage tray or support for objects of any kind. Never allow front passengers to rest their feet or legs on the airbag cover. ◀

For airbag locations and additional information on airbags, refer to page 53.

### Sitting safely with safety belts

 Never allow more than one person to wear a single safety belt. Never allow infants or small children to ride in a passenger's lap. Avoid twisting the belt while routing it firmly across the hips and shoulder, wear it as snugly against your body as possible. Do not allow the belt to rest against hard or fragile objects. Do not route the belt across your neck, or run it across sharp edges. Be sure that the belt does not become caught or jammed. Avoid wearing bulky clothing and pull on the lap belt periodically to retension it over your shoulders. In the event of a frontal impact, a loose lap belt could slide over your hips, leading to abdominal injury. In addition, the safety belt's restraint effectiveness is reduced if it is worn loosely. Expectant mothers should always wear their safety belts, taking care to position the lap belt against the lower hips, where it will not exert pressure against the abdominal area. ◀

For information on using the safety belts, refer to page 47.

## Seats

### When adjusting your seat, always observe the following precautions

 Never try to adjust your seat while operating the vehicle. The seat could respond with unexpected movement, and the ensuing loss of vehicle control could lead to an accident. Never ride with the backrest reclined to an extreme angle. This is especially important for the front passenger to remember. If you do so, there is a risk that you will slide under the safety belt in an accident, thus reducing the protection provided by the safety belt. ◀

### Seat adjustment

- ▷ Manual seat adjustment, refer to page 45
- ▷ Power seat adjustment, refer to page 46
- ▷ Head restraint, refer to page 47.

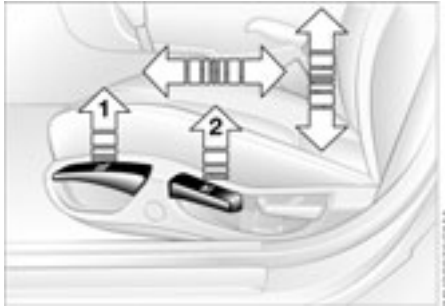

## Seat adjustment

### 1 Backward/Forward adjustment

Pull the lever and slide the seat to the desired position.

After you release the lever, move the seat forward or backward slightly so that it engages fully

### 2 Height

Pull the lever and apply weight to or remove weight from the seat as required

### 3 Backrest angle

Pull the lever and apply weight to or remove weight from the backrest as required

## BMW sports seat\* adjustment

You can also adjust the tilt angle and the thigh support:

### 1 To tilt up:

Pull the lever up repeatedly, continuing until the seat reaches the desired tilt angle

### 2 To tilt down:

Push the lever down repeatedly, continuing until the seat reaches the desired tilt angle

### 3 Thigh support:

Pull the lever and adjust the position of the thigh support for your personal comfort

## 46 Power seat adjustment\*

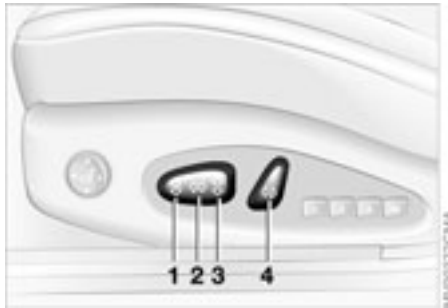

### Seat adjustment

- 1 Tilt angle
- 2 Backward/Forward adjustment
- 3 Height
- 4 Backrest angle

The head restraint is adjusted manually, refer to page 47.

With the BMW sports seat you can also adjust the thigh support, refer to page 45.



Please refer to the adjustment instructions on page 44 to reduce the risk of personal injury. ◀

## Lumbar support\*



### To adjust

You can adjust the backrest's contour for additional support in the curvature of your spine's lumbar region.

The upper hips and spinal column receive supplementary support to help you maintain a relaxed, upright posture.

- ▷ Press the front/rear of the switch: increase/decrease curvature
- ▷ Press the upper/lower end of the switch: increase the upper/lower curvature.

## Head restraints



2. Press button – see arrow 1 – and remove the head restraint.

### Installation – front

Slide the head restraint into the sockets.

### To adjust

Height: pull the head restraint up or push it down.



Press button to retract to the lowest position – see arrow 1. ◀

Adjust the angle of the front head restraints by tilting them manually.



You can reduce the risk of spinal injury and whiplash by adjusting the head restraint to a height at which it is centered roughly at ear level. ◀

### Removal – front

1. Pull up the head restraint, continuing until it is at maximum extension

## Safety belts



### Always wear your safety belt

Always fasten your safety belt before starting off. As supplemental restraint devices, the airbags are designed to enhance the effectiveness of the safety belts, and not to replace them.

### To close

Make sure you hear the catch engage in the belt buckle.

### To release

1. Press red button in the belt buckle
2. Hold end of the belt
3. Guide belt back into the inertia reel.

## 48 Safety belts

 The rear belt buckle with the word CENTER is intended exclusively for the passenger sitting in the middle. ◀



### Adjusting safety belt height

Use the height adjustment mechanism to adapt the shoulder strap to the ideal level for your own body:

▷ Slide the button up or down.

Please refer to the seat adjustment instructions on page 44.



If the safety belt system has been subjected to the stresses involved in an accident or otherwise damaged: have the entire safety belt mechanism replaced by your BMW center, including the safety belt tensioner. In addition, have your BMW center inspect the safety belt anchors. If a child-restraint system was in the vehicle during an accident, consult the manufacturer's instructions regarding replacement. ◀



## Seat and mirror memory\*

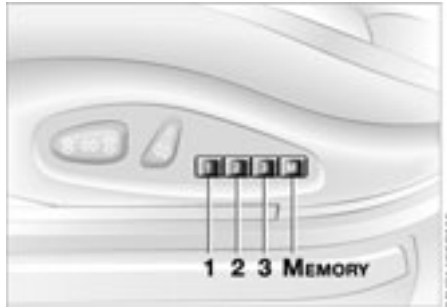

You can store and recall three different driver's seat and exterior mirror positions.

 Memory will not retain the adjustment made to the lumbar support. ◀

### To store

1. Ignition key position 1 or 2
2. Adjust your seat and exterior mirrors to the desired position
3. Press the MEMORY button: the indicator lamp in the button lights up
4. Press memory button 1, 2 or 3, as desired: indicator lamp goes out.

### To select a stored setting

 Do not select a memory position while the vehicle is moving. If you do so, there is a risk of accident from unexpected seat movement. ◀

Ignition key in position 1:

- ▷ Briefly press memory button 1, 2 or 3, as desired.  
Movement stops immediately when one of the seat-adjustment or memory buttons is activated during the adjustment process.

The driver's door is closed and the ignition key is either removed or in position 0 or 2:

- ▷ Maintain pressure on the desired memory button – 1, 2 or 3 – until the adjustment process is completed.

 If you press the MEMORY button accidentally: press the button again; the indicator lamp goes out. ◀

 Your BMW center can adjust your vehicle's systems in such a manner that your personalized settings are automatically set for the seat and exterior mirror positions when you unlock the vehicle with your personal remote control. ◀

 Before activating the programmed adjustment feature, ensure that the footwell behind the driver's seat is empty and unobstructed. If you fail to do so, persons, animals or objects could be injured or damaged if the seat should move backward. ◀



### **Passenger-side exterior mirror tilt function**

Automatic curb monitor\*

1. Move mirror selector switch 1 to the driver's mirror position
2. When shifting into Reverse or placing the selector lever in position R, the passenger-side mirror tilts downward to help the driver monitor the area directly adjacent to the vehicle during parking – curbs, etc.



How far the passenger mirror tilts can be set individually for each ignition key. ◀

You can deactivate this automatic feature by setting the mirror selection switch to the passenger side position.



The seat cushion and backrest can be heated with the ignition key in position 2.

You can select different heating modes by repeatedly pressing the buttons.

You can also switch the higher heating modes off directly:

Press the button and hold it slightly longer.

## Steering wheel

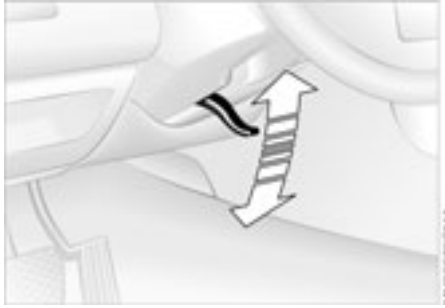

### To adjust

 Never attempt to adjust the steering wheel while driving the vehicle – it could respond with unexpected movement, posing a potential accident hazard. ◀

1. Push the locking lever downward
2. Adjust the steering column's rake and reach to suit your seat position
3. Pull the lever back up to clamp the steering wheel in the new position.

## Mirrors



### To adjust exterior mirrors

- 1 Mirror switch for 4-way adjustment
- 2 Selection switch for changing between mirrors

### To adjust manually

The mirrors can also be adjusted manually:

Press against the edges of the lens.

For storing mirror settings, refer to Seat and mirror memory on page 49.

 The mirror on the passenger's side is convex. When estimating the distance between yourself and other traffic, bear in mind that the

objects reflected in the mirror are closer than they appear. This means that estimates of the distance to following traffic should not be regarded as precise. ◀

### Electric defrosting\*

Both mirrors are automatically heated when you turn the ignition key to position 2.



### **Interior rearview mirror**

To reduce glare from vehicles behind you when you are driving at night, tilt the lens by turning the button.

Vehicles without alarm system:  
Tilt the small lever forward.



### **Interior rearview mirror with automatic dimming feature\***

This mirror automatically dims through an infinitely variable range. It returns to its clear, undimmed mode whenever you engage reverse.

To ensure that the mirror continues to operate efficiently, ensure that the photocells remain clear and unobstructed. One photocell is integrated in the mirror's lens – see arrow – while the other is located at an offset position on the rear of the mirror. Refrain from attaching stickers or other objects to the windshield in the area immediately behind the rearview mirror.

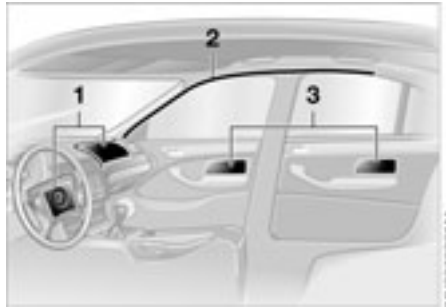



- 1 Front driver and passenger-side airbags
- 2 Head airbags for driver and front passenger
- 3 Side airbags on the driver and passenger sides – front and rear\*

## Protective effect

The front airbags supplement the three-point safety belts by providing additional protection in the event of a severe frontal collision in which the protection afforded by the belts alone may no longer be sufficient. The Head Protection System and side airbags help provide protection in the event of a collision from the side. Each of the side airbags is designed to help support the seat occupant's upper body.

For information on the correct sitting posture, refer to page 44.

 The side airbags in the rear passenger area\* of your vehicle may already have been deactivated either at the time of manufacture or by a BMW center. You may have them activated if you desire to do so. Please contact your BMW center for additional information. ◀

 The airbags do not deploy in response to minor collisions, rear impacts and certain kinds of vehicle rollover. ◀

 Do not apply adhesive materials to the cover panels of the airbags, cover them or modify them in any other way. Do not remove the airbag restraint system. In the event of a malfunction, deactivation or triggered activation – as a response to an accident – of the airbag restraint system, consult your BMW center for inspection, repairs or disassembly. Do not modify or tamper with either the wiring or the individual components in the airbag system. These include the upholstered covers on the steering wheel, the instrument panel, side panels on doors and the roof struts

as well as down the sides of the roof liners. Also, do not attempt to remove the steering wheel. Unprofessional attempts to service the system could lead to failure in an emergency or undesired airbag activation, either of which could result in personal injury. Do not touch the individual components immediately after the system has been activated, as this could result in personal injury. ◀

 All vehicle occupants should always sit upright and be properly restrained – infants and small children in appropriate child-restraint systems; larger children and adults using the safety belts. Never let an occupant's head rest near or on a side airbag because the inflating airbag could cause a serious or fatal injury. Please note that the word Airbag imprinted on the door trim panel indicates the airbag's location.

Accident research shows that the safest place for children in an automobile is in the rear seat. However, a child sitting in the rear seat and not properly restrained could place his or her head on or near the airbag, if so equipped. For example, a child – even though belted in – may fall asleep with his or

her head against the side airbag. It may be difficult for a driver to ensure that children in the rear seat will remain properly positioned at all times and not place their heads on or near the side airbag. Therefore, we recommend that the rear-seat side airbags, if installed in the vehicle, be deactivated if children will travel in the rear seat.

The rear seat side airbags may already have been deactivated, either at the time of manufacture or by a BMW center. Labels in the door opening should indicate the status of your rear-seat side airbags. If you are uncertain of their status, or wish to have the airbags activated or deactivated, please contact your BMW center. ◀

Even when all these guidelines are followed, there is still a small residual risk of injuries to the face, hands and arms occurring from airbag deployment in isolated instances.

The ignition and inflation noise may induce a mild temporary hearing loss in sensitive individuals.

Corresponding airbag warning labels are found on both sun visors.



This is the right way a child should sit in a child restraint when rear side airbags, see arrow, are provided.



This is the right way a larger child should sit wearing the seat belt when rear side airbags, see arrow, are provided.

### Indicator lamp



The indicator lamp indicates the operational status of the airbag system with the ignition key in position 1 or higher.

System operational:

- ▷ The indicator lamp comes on briefly when you turn the ignition key to position 1 or higher.

System malfunction:

- ▷ Indicator lamp does not come on or
- ▷ indicator lamp lights up continuously.

If there is a system malfunction, there is a risk that the airbags will not be triggered within their normal response range, even if the level of impact would normally have triggered them.

Have your BMW center inspect the system immediately.

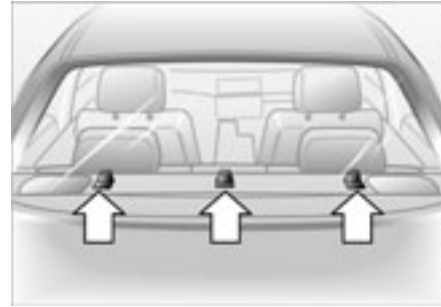

Commercially available child-restraint systems are designed to be secured with a lap belt or with the lap belt portion of a combination lap/shoulder belt. Improperly or inadequately installed restraint systems can increase the risk of injury to children. Always read and follow the instructions that come with the system.

### Child-restraint system with tether strap

If you use a child-restraint system with a tether strap, three additional tether anchorage points have been provided – refer to the arrows in the illustration.

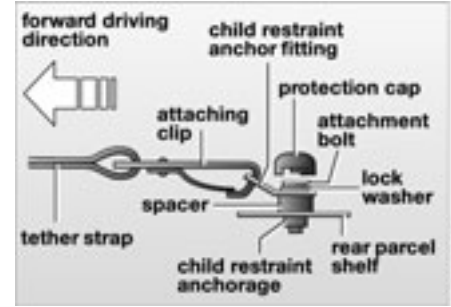

Depending on the location selected for seating in the rear passenger area, attach the tether strap to the corresponding anchorage point to secure the child-restraint system, as shown in the illustration.

If the respective seating position is fitted with a head restraint, lift the head restraint and pass the tether strap between the head restraint and the seat back.

It is recommended to readjust the head restraint in the lowest possible position.

Adjust the tether strap according to the child-restraint manufacturer's instructions.



Before installing any child-restraint device or child seat, please read the following: Never install a rear-facing child-restraint system in the front passenger seat of this vehicle. Your vehicle is equipped with an airbag supplemental restraint system for the front passenger. Because the backrest on any rear-facing child-restraint system – of the kind designed for infants under 1 year and 20 lbs/9 kg – would be within the airbag's deployment range, you should never mount such a device in the front passenger seat, since the impact of the airbag against the child-restraint's backrest could lead to serious or fatal injuries. If it is necessary for a child – not an infant – to ride in the front seat, certain precautions should be taken. First, move the passenger seat as far away from the dashboard as possible. This important precaution is intended to maximize the distance between the airbag and the child. Older children should be tightly secured with a safety belt after they have outgrown a booster seat that is appropriate for their age, height, and weight. Younger children

should be secured in an appropriate forward-facing child-restraint system that has first been properly installed with a safety belt. Never install a rear-facing child-restraint system in the front passenger seat. We strongly urge you to carefully read and comply with the instructions for installation and use provided by the child-restraint's manufacturer whenever you use such a device. Do not attempt to modify child-restraint systems. If you do this, the protection provided by these systems could be impaired. Always ensure that all occupants – of all ages – remain properly and securely restrained at all times. ◀

All rear seating positions in your vehicle meet the recommendations of SAE J1819, an industry-recommended practice for securing child-restraint systems in motor vehicles.



### Securing child-restraint system

All of the rear belt retractors and the front passenger's safety belt can be locked for mounting and securing child-restraint systems.

A label with the appropriate instructions for this is located in the immediate vicinity of the buckle latch of each safety belt.

### To lock the safety belt

Extract the entire length of the belt from the inertia reel mechanism. Allow the reel to retract the belt somewhat and engage the buckle, then tighten the belt against the child-restraint system. The retraction mechanism is now locked.



## Transporting children safely

The belt cannot be extracted further. Always observe the installation instructions provided by the manufacturer of the child-restraint system.

### To unlock the safety belt

Release the safety belt, remove the child seat and retract the safety belt to its end position on the belt retractor.

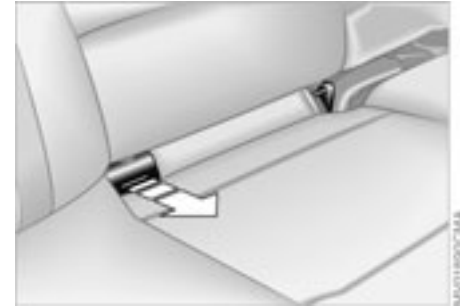

### LATCH child-restraint mounting system

LATCH: Lower Anchors and Tethers for CHildren

Canadian models only:

The LATCH anchorage points are identified by buttons.

The left and right rear seats are both equipped with a LATCH child-restraint mounting system.

Remove the cover from the outside mount by pulling forward. When reinstalling ensure that the recess is on the top.

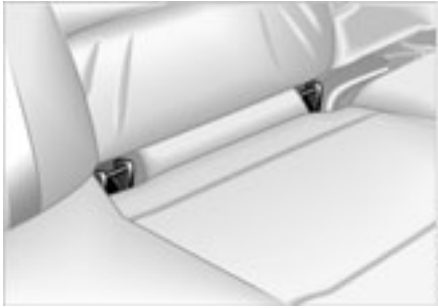

With through-loading system: tilt the backrest halfway forward to make the cover easier to remove, refer to page 106.

The illustration is an example showing the anchorages for a LATCH child-restraint mounting system at the right rear seat.

 Always follow all manufacturer's instructions and observe all safety precautions when installing the LATCH child-restraint mounting system. ◀

### **Child safety locks**

Slide down the lever located in the rear door:

The door can now be opened from the outside only.

# Vehicle Memory, Key Memory



## How the system functions

No doubt you have reflected at one time or another on how great it would be if you could permanently configure your vehicle's various features and adjustments to mirror your own individual preferences. In engineering your vehicle, BMW has provided for a number of options for personal adjustment that can be programmed into your vehicle at your BMW center.

The available configuration data fall into two categories, according to whether their primary orientation is the vehicle – Vehicle Memory – or the individual – Key Memory. Provided that each per-

son has a separate remote-control key, you can have your BMW center enter basic adjustment data for up to four individuals in the system.

The system then relies on a bilateral data exchange to identify the individual user and executes the selected settings whenever the remote control unit is used to disengage the door locks.

Color-coded decals have been provided to help you distinguish individual keys with different settings.

## What the system can do

You can learn about the entire array of features this system offers at your BMW center.

Examples for Vehicle Memory:

- ▷ Various signals as acknowledgment when locking or unlocking your vehicle, refer to pages [31](#), [33](#)
- ▷ Activating/deactivating the "Follow me home" function, refer to page [89](#)
- ▷ Activating/deactivating daytime driving lamps, refer to page [89](#)
- ▷ Selecting units of measure for displaying time, outside temperature, distance traveled and fuel consumption in the instrument panel

- ▷ Indicating via an acoustic tone that PDC has been activated, refer to page [77](#)
- ▷ Switching on the rear window defroster automatically, refer to pages [94](#), [99](#)
- ▷ Having the display – after giving an ice warning – return to its previous setting, refer to page [75](#).

Examples for Key Memory:

- ▷ Unlocking the driver's door first, then the vehicle's remaining locks, refer to page [31](#)
- ▷ Locking the vehicle after pulling away, refer to page [34](#)
- ▷ Automatically repositioning of the driver's seat for the corresponding driver when the vehicle is unlocked, refer to page [49](#)
- ▷ Automatic tilting of the passenger-side mirror, refer to page [50](#).



You will see this symbol throughout the Owner's Manual. It is to remind you at appropriate places of the settings that are available to you. ◀



- 0 Steering locked
- 1 Steering unlocked
- 2 Ignition switched on
- 3 Starting engine

 Vehicles with automatic transmission:

Do not move the selector lever from position P until the engine is running – ignition key position 2.

Your vehicle is equipped with an interlock. Therefore, the ignition key cannot be turned to position 0 or removed until the selector lever is in position P. ◀

 Vehicles with manual transmission:

Step on the clutch when starting the vehicle. A lockout prevents the engine from starting if the clutch is not depressed. ◀

### Steering locked

The key can only be inserted and removed in this position.

After removing the key, turn the steering wheel slightly to the left or right until you hear the lock engage.

If the key is not removed, an acoustic signal is sounded after the driver's door has been opened.

The sound system remains operational for approx. 20 minutes after you switch off the ignition – ignition key in position 0 or key extracted. Simply switch it back on.

### Steering unlocked

You will find that it is often easier to turn the ignition key from position 0 to position 1 when you move the steering wheel slightly to help disengage the lock.

Individual electrical accessories are ready for operation.

## Starting the engine

### Before starting

- ▷ Engage the parking brake
- ▷ Ensure that the shift lever is in neutral, or, with an automatic transmission, that the selector lever is in position P
- ▷ Depress the clutch pedal.



Do not allow the engine to run in enclosed spaces. Otherwise, breathing the exhaust fumes can lead to unconsciousness and death. The exhaust gases contain carbon monoxide, an odorless and colorless, but highly toxic gas. Do not leave the vehicle unattended with the engine running. An unattended vehicle with a running engine represents a safety hazard. ◀



When driving, standing at idle, and parking the vehicle, take care to avoid contact between the hot exhaust system and flammable materials – grass, hay, leaves, etc. Such contact could lead to a fire, resulting in serious personal injury and property damage. ◀

- ▷ Start the engine. Do not press the accelerator pedal.

## Starting the engine

 Do not actuate the starter for too short a time, but do not actuate it for more than approx. 20 seconds. Release the ignition key immediately when the engine starts.

Do not allow the engine to warm up by leaving it running while the vehicle remains stationary. Instead, drive off immediately at a moderate engine speed. ◀

If the engine does not start on the first attempt – if it is very hot or cold, for instance:

▷ Press the accelerator pedal halfway down while engaging the starter.

Cold starts at extremely low temperatures below approx. +5 °F/-15 °C and at altitudes over 3,300 ft/1,000 m:

▷ On the first start attempt, it may be necessary to engage the starter for a longer period, but no longer than 20 seconds

▷ Press the accelerator pedal halfway down while engaging the starter.

Engine idle speed is controlled by the engine computer system. Increased speeds at startup are normal and should decrease as the engine warms up. If engine speed does not decrease, service is required.

To prevent the battery from discharging, always deactivate electrical devices that are not in use. Switch the ignition off when the vehicle is not being driven.

 Extended starting attempts, characterized by excessively frequent or long periods with the starter engaged, can damage the catalytic converter. ◀

## 62 Switching off the engine

Turn the ignition key to position 1 or 0.



You should never remove the ignition key when the vehicle is in motion, as the steering lock could engage.

When you leave the vehicle, always remove the ignition key and engage the steering lock.

Vehicles with manual transmission:

Always engage the parking brake when parking on slopes and inclined surfaces. Placing the lever in gear may not provide adequate resistance to rolling.

Vehicles with automatic transmission:

Place the selector lever in Park. ◀

## Parking brake

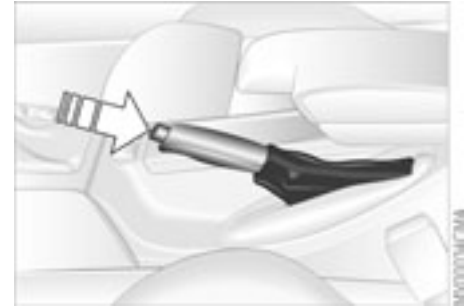

The parking brake is primarily designed to prevent the vehicle from rolling while parked. It operates on the rear wheels.

### To engage

The detent engages automatically, and the indicator lamp in the instrument cluster comes on when the ignition key is in position 2, refer to page 18.

### To release

Pull up slightly on the lever, press the button – see arrow – and lower the lever.

## Parking brake

 If exceptional circumstances make it necessary to engage the parking brake while the vehicle is in motion, do not pull it with excessive pressure. Keep your thumb pressed against the release button while carefully pulling the lever up. Excessive pressure can lead to over-braking and loss of traction – fishtailing – at the rear axle. The brake lamps do not come on when the parking brake is engaged.

Vehicles with manual transmission:  
Always engage the parking brake when parking on slopes and inclined surfaces. Placing the lever in gear may not provide adequate resistance to rolling.  
Vehicles with automatic transmission:  
Place the selector lever in Park. ◀

 To avoid corrosion and one-sided braking, apply the parking brake lightly from time to time when coasting to a standstill – at a traffic signal, for example – provided that it is safe to do so. ◀

## Manual transmission



 Do not hold the vehicle in place on slopes by slipping or "riding" the clutch. Use the parking brake instead. Riding the clutch leads to severe and premature clutch wear. ◀

### Reverse

Select only when the vehicle is stationary. Press the shift lever to the left to overcome the slight resistance.

As you do this, the backup lamps will light up automatically when the ignition key is in position 2.

You can drive as with a normal automatic transmission. In addition, you can also shift manually.

When you move the selector lever from the D position to the left into the M/S range, the performance-oriented shift programs of the automatic transmission are engaged. Steptronic enters the manual selection mode and executes the desired shift whenever you tap the selector lever in the direction indicated by + or -. Whenever you want to use the automatic transmission mode again, move the selector lever to the right into the D position.

Under normal operating conditions, fuel consumption is lowest when driving in position D.

### Selector lever positions

P R N D M/S + -

### Starting the engine

The engine can only be started in selector lever positions P – for Park – or N – for Neutral.



### Range selection

A detent prevents inadvertent shifts to the Reverse or Park selector lever positions. To disengage the detent, press the button on the front side of the selector lever button – see arrow.

 While the vehicle is stationary and before shifting out of Park or Neutral, depress the footbrake in order to disengage the selector lever's lock mechanism – Shiftlock. Hold the footbrake down until starting off. The vehicle will otherwise "creep" when a drive position is engaged. ◀

 To prevent the vehicle from starting off on its own, always move the selector lever to position P and engage the parking brake before leaving your vehicle with the engine running.

Do not leave the vehicle unattended with the engine running. An unattended vehicle with a running engine represents a safety hazard. ◀

### P Park

Select only when the vehicle is stationary. Transmission locks to prevent rear wheels from turning.

### R Reverse

Select only when the vehicle is stationary.

### N Neutral

Select only when stopping for an extended period.

### D Drive – automatic shift program

This position is designed for driving under all normal operating conditions. All forward gears are available.



# Automatic transmission with Steptronic\*

## Kickdown

In the kickdown mode, you achieve maximum acceleration and top speed in position D.

Depress the accelerator pedal past the increased resistance point at the full-throttle position.



## M/S manual operation and Sport Program

Move the selector lever from D to M/S to activate the Sport Program; SD appears in the display panel. The M/S mode is recommended for performance-oriented driving.

Once in the M/S mode you can tap the selector lever to switch the automatic transmission from the Sport Program to its manual selection mode.

This mode allows you to execute upshifts manually by tapping the lever toward +, while downshifts are selected by tapping in the – direction. The displays M1 through M5 appear in the display panel to indicate your current gear selection.

The Adaptive Transmission Control (ATC) executes upshifts and downshifts only when the new gear will provide a suitable combination of engine and road speed, i.e., ATC will not execute downshifts if the engine speed is too high. The desired, then the actual gear, briefly appear in the instrument cluster.

 To accelerate quickly in the manual mode for maneuvers such as passing another vehicle, shift down manually or employ the kickdown mode. ◀

Shifting from M/S to the selector lever positions P, R and N is possible only by going through D.

## 66 Automatic transmission with Steptronic\*



If the indicator lamp does not go out, you can place the selector lever in all positions. However, the vehicle will now only operate in 3rd and 4th gear.

If this happens, avoid extreme engine loads and consult the nearest authorized BMW center.



Never work in the engine compartment when a drive gear – forward or reverse – is engaged. If you do this, the vehicle could move. ◀

### Available displays

P R N D SD M1 M2 M3 M4 M5

### Electronic transmission control module



If the indicator lamp comes on, there is a malfunction in the transmission system.

Bring the vehicle to a stop. Move the transmission selector lever to P. Set the parking brake and turn the engine off – ignition key to position 0.

Wait a few seconds, then start the engine.

If the indicator lamp goes out after a few seconds, normal transmission performance has been restored. You may continue to drive as usual.

For towing or jump-starting, refer to the information beginning on page [147](#).

## Turn signal indicator/Headlamp flasher



- 1 High beams – blue indicator lamp
- 2 Headlamp flasher – blue indicator lamp
- 3 Turn signal indicator – green indicator lamp accompanied by periodic clicking sound from the relay

### To signal briefly

Press the lever up to but not beyond the detent. It then returns to the center position when released.

 If the flashing of the turn signal indicators and the clicking from the relay are both faster than normal, one of the turn signal indicators has failed. ◀



- 0 Wipers retracted
- 1 Intermittent mode or rain sensor
- 2 Normal wipe
- 3 Fast wipe
- 4 Brief wipe
- 5 Rotary dial for control of the wipe interval or the sensitivity of the rain sensor

### Intermittent mode

Not on vehicles with rain sensor.

You can select any of four sweep intervals with rotary dial 5.

In addition, the wipe interval varies automatically depending on road speed.

### Rain sensor\*

The rain sensor is positioned on the windshield, directly behind the interior rearview mirror.

To activate the rain sensor:

- ▷ With the ignition key in position 1 or 2, move the lever to position 1. The wipers will make at least one sweep across the windshield. You can leave the lever in position 1 at all times. With the ignition key position in position 1 or higher, all you then need to do to activate the rain sensor is
  - ▷ briefly turn the rotary dial 5, or
  - ▷ clean windshield 1, refer to page 69.

To adjust the sensitivity of the rain sensor: turn rotary dial 5.

To switch off the rain sensor:

Return lever to position 0.



Turn the rain sensor off in automatic car washes. Failure to do so could result in damage caused by undesired wiper activation. ◀

### Normal wiper speed

When the vehicle is stationary, the wipers switch automatically to intermittent wipe – not on vehicles with rain sensor.

### Fast wiper speed

When the vehicle is stationary, the wipers revert to operate at normal speed – not on vehicles with rain sensor.



When the vehicle's lighting system is switched on, the headlamps will also be cleaned at reasonable intervals.

### Windshield washer nozzles

The windshield washer nozzles are heated automatically\* when the ignition key is in position 2.

### Cleaning windshield and headlamps\*

0 Wipers retracted

1 Clean windshield and headlamps\*

 Do not use the washers if there is any danger that the fluid will freeze on the windshield, as your vision could be obscured. Always use a windshield washer antifreeze in cold weather. Refer to page 126. Do not use the washers when the reservoir is empty as this could cause damage to the washer pump. ◀

The system sprays washer fluid against the windshield and activates the wipers for a brief period.

You can store and automatically maintain any desired vehicle speed above approx. 20 mph / 30 km/h.

The cruise control is available whenever the engine is running and the system has been activated.

### To activate the system

I/O

From ignition key position 2:

Press the button. The indicator lamp in the instrument cluster comes on, refer to page 21. You can now use the cruise control.

 Do not use cruise control on twisting roads, when high traffic density prevents driving at a constant speed, or when the road surface is slick – snow, rain, ice – or loose – rocks or gravel, sand. ◀

### To deactivate the system

I/O

Press button as often as needed until the indicator lamp in the instrument cluster goes out.

Cruise control is also deactivated when the ignition key is in position 0.

The speed stored in memory is deleted.

### To store and maintain speed or to accelerate



Press button + briefly:

The system registers and maintains the current vehicle speed. Every time you tap the button, the speed increases by approx. 0.6 mph / 1 km/h.

Press and hold button +:

The vehicle accelerates without pressure on the accelerator pedal. When you release the button, the system registers and maintains the current speed.

 If on a downhill gradient the engine braking effect is not sufficient, the controlled speed can be exceeded. Speed can drop on uphill grades if the engine output is insufficient. ◀

### To decelerate



Press button – briefly:

If you are already driving with activated cruise control, the speed is decreased by approx. 0.6 mph / 1 km/h every time you tap the button.

Press and hold button –:

With the cruise control active, the system automatically reduces the throttle opening to slow the vehicle. When you release the button, the system registers and maintains the current speed.

### To interrupt the cruise control



When the system is activated, press the button. The indicator lamp stays on. You can use the cruise control again whenever you want by calling up the speed that was stored last.

In addition, cruise control is interrupted automatically:

- ▷ When the brakes are applied
- ▷ When you apply pressure to the clutch pedal, or when you move the automatic transmission selector lever from D to N

- ▷ If you exceed or fall below the programmed speed for an extended period – by depressing the accelerator, for example.

### To recall the stored setting



Press button:

The vehicle accelerates to and maintains the last speed stored.



- 1 Odometer
- 2 Trip odometer

### Odometer

You can activate the displays shown in the illustration with the ignition key in position 0 by pressing the left button in the instrument cluster – see arrow.

### Trip odometer

To reset the trip odometer to zero, press the left button – see arrow – with the ignition key in position 1 or higher.



Never allow the engine to operate with the needle in the red overspeed zone of the gauge – see arrow.

To protect the engine, the fuel supply is interrupted when you approach this sector.



Indicates the current fuel consumption in mpg – in liters/100 km on Canadian models. This allows you to see whether your current driving style is conducive to fuel economy with minimum exhaust emissions.

When the vehicle is stationary, the display goes to Maximum – zero on Canadian models.



Once the indicator lamp stays on continuously, there are still approx. 2 gallons/8 liters of fuel in the fuel tank. Fuel tank capacity approx. 16.6 gallons/63 liters.

Certain operating conditions, such as those encountered in mountainous areas, may cause the needle to fluctuate slightly.



Fill the fuel tank before it is completely empty. Driving to the last drop of fuel can prevent the engine from operating properly and result in damage. ◀

When you switch on the ignition, the indicator lamp lights up briefly as an operation check.

**Blue**

The engine is still cold. Drive at moderate engine and vehicle speeds.

**Red**

When you switch on the ignition, the warning lamp comes on briefly as an operation check.

If the lamp comes on during normal vehicle operation: the engine has overheated. Shut off the engine immediately and allow it to cool down.

To check coolant level, refer to page [128](#).

**Between the blue and red zones**

Normal operating range. The needle may rise as far as the edge of the red sector during normal operation.



## Service interval display



A flashing message and a "-" in front of the number mean that the service interval has already been exceeded by the distance shown on the display. Please contact your BMW center for an appointment.

### Remaining distance to next service

The displays shown in the illustration appear for a few seconds when the ignition key is in position 1 or higher or after the engine is started.

The next service due appears with the message OIL SERVICE or INSPECTION, together with the distance remaining in miles – in kilometers in Canada – before the next scheduled service.

The computer bases its calculations of the remaining distance on the preceding driving style.

## Check Control

73

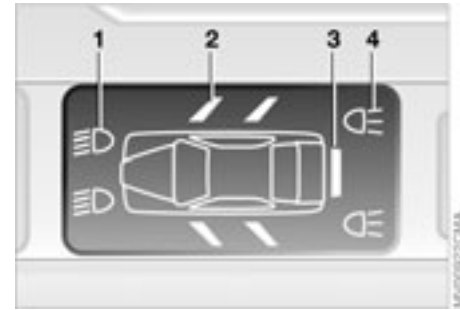

The following information and/or conditions are indicated using symbols, with the ignition key in position 2 or higher, until the condition has been corrected.

- 1 Check the low beam and high beam headlamps, as well as the parking lamps
- 2 Door open
- 3 Luggage compartment lid open
- 4 Check brake and tail lamps

When you open the driver's door after completing a journey, an acoustic warning signal will sound if you have forgotten to turn off the headlamps.

## 74 Clock

If you wish to have a permanent time display, you can make this adjustment in the radio display, refer to the Owner's Manual for Radio.

You can adjust the clock and the time display in the car radio as follows.



In ignition key position 0: the time is displayed for a few seconds after you press the left button, refer to Odometer on page 71.

### To adjust

With the ignition key in position 1 or higher and the time displayed in the instrument cluster.

To set ahead: turn the right button to the right.

To set back: turn the right button to the left.

The adjustment speed will increase the longer you continue to hold the right button.

To change the display mode: press the right button briefly.

Every time you press the button, the clock display alternates between the 12-hour and 24-hour mode.



 After giving an ice warning, the display returns to the previous setting. ◀

 The ice warning does not alter the fact that surface ice can form at temperatures above 37.5 °F/+3 °C, on bridges or shaded road surfaces, for instance. ◀

## Mode selection

With the ignition key in position 1 or higher, you can use the button in the turn signal lever to request information from the computer. Each time you press the button briefly toward the steering column, a new function is called up in the display.

The displays appear in the following order:

Time of day, outside temperature, average fuel consumption, cruising range, average vehicle speed.

With the ignition key in position 1 or higher, the last active setting is displayed.

## Outside temperature

You can change the units of measure °C/°F for the outside temperature display by pressing the right-hand reset button in the instrument cluster while the temperature display is active. The units of measure °C/°F in the temperature display of the automatic climate control change automatically, see page 96.

## Ice warning

If the outside temperature drops to about 37.5 °F/+3 °C, then the computer will automatically switch to a display of the outside temperature. In addition, a signal sounds as a warning and the display flashes for a brief period.



 It is important that you refuel when the cruising range falls below approx. 35 miles/50 km. Otherwise, the engine cannot be guaranteed to operate properly and damage may result. ◀

### **Average speed**

If you continue to press and hold the button, the average speed last displayed is recalculated from that point in time.

Any time spent when the vehicle is stationary and the engine is shut off is ignored for the calculation.

### **Average fuel consumption**

If you continue to press and hold the button on the turn signal lever, the average fuel consumption last displayed is recalculated from that point in time.

 If you wish, you can have the average fuel consumption displayed in a different unit of measure. ◀

### **Range**

The computer bases its calculations for the cruising range on the operating conditions in the preceding period and on the remaining fuel in the tank.

## Park Distance Control (PDC)\*

### The concept

PDC provides extra safety and convenience during parking maneuvers. Acoustic signals alert you to the momentary distance to an object behind your vehicle. The system features four ultrasonic sensors mounted in your rear bumper. The monitoring range for the two corner sensors extends outward roughly 2 ft/60 cm behind the bumpers, while two centrally located sensors detect objects at distances of up to approx. 5 ft/1.50 m.

 PDC is a parking aid that can identify objects if they are approached slowly, as is generally the case when parking. Avoid driving towards objects rapidly; due to underlying physical principles, the system may otherwise alert you too late for you to take evasive steps. ◀

The system starts to operate automatically approx. one second after you select reverse or move the selector lever into the R position with the ignition key in position 2.

 Let this short period elapse before driving backwards. ◀

PDC is deactivated when you shift back out of Reverse.



You can have a signal set to confirm that the PDC has been activated. ◀

### Acoustic signals

The distance to the nearest object is indicated by a tone sounding at various intervals. As the distance between vehicle and object decreases, the intervals between the tones become shorter. A continuous tone indicates the presence of an object less than 1 ft/30 cm away.

The warning signal is canceled after approx. three seconds if the distance to the object remains constant during this time – if you are moving parallel to a wall, for instance.

System malfunctions will be indicated by a continuous high-pitched tone when the system is activated the first time. Please have the problem fixed by your BMW center.

 PDC does not remove the driver's personal responsibility for evaluating the distance between the vehicle and any objects. Even when sensors

are involved, there is a blind spot in which objects cannot be detected. This applies especially in those cases where the system approaches the physical limits of ultrasonic measurement, as occurs with tow bars and trailer couplings, and in the vicinity of thin or wedge-shaped objects. Moreover, low objects that have already been detected – such as a curb edge – can disappear out of the detection range of the sensors before a continuous tone sounds.

Loud sources of sound from outside or inside the vehicle could drown out the PDC signal tone. ◀

 Keep the sensors clean and free of ice or snow in order to ensure that they will continue to operate effectively.

Do not apply high pressure spray to the sensors for a prolonged period of time. Always maintain a distance of more than 4 in/10 cm. ◀

**The concept**

ASC+T optimizes vehicle stability and traction, especially when just starting off, when accelerating or when going through curves.

ASC+T is ready each time you start the engine.

ASC+T incorporates the Automatic Differential Brake (ADB) and Cornering Brake Control (CBC) functions.

Additional information on ASC+T is found in the "Technology" brochure.

**Indicator lamp**



The indicator lamp in the instrument cluster goes out shortly after the ignition has been switched on; refer to page 20.

- ▷ The indicator lamp flashes: ASC+T is actively controlling drive torque and braking intervention
- ▷ The indicator lamp stays lit: ASC+T has been switched off with the button; ADB is operational. ADB control intervention is not indicated.



The indicator and the brake warning lamps will remain on continuously yellow:



The ASC+T and ADB have been switched off manually or there is a system malfunction.

You can still drive the vehicle as normal without ASC+T.

In the event of a fault, please consult your BMW center.



Indicator and warning lamps for Canadian models.



**Switching off the ASC+T/activating the ADB**

Press the ASC button briefly; the indicator lamp comes on and stays on. ASC+T has been switched off; ADB is operational.

In the following rare situations, it may be effective to activate the ADB for a brief period:

- ▷ When rocking the vehicle or starting off in deep snow or on loose surfaces
- ▷ When driving with snow chains.



To maintain vehicle stability, always drive with the ASC+T activated whenever possible. ◀

# Automatic Stability Control plus Traction (ASC+T)\*

## Deactivating the ASC+T and ADB

Press the ASC button for at least 3 seconds; the indicator lamps and the yellow brake warning lamp come on and stay on.

The systems for enhancing stability and traction are deactivated, and there is no active braking intervention or torque control.



To maintain vehicle stability, always drive with the ASC+T activated whenever possible. ◀

## Reactivating the ASC+T

Press the button again briefly; the indicator lamp or the indicator lamps will go out. ADB is deactivated.



The laws of physics cannot be repealed even with ASC+T. An appropriate driving style always remains the responsibility of the driver. We therefore urge you to avoid using the additional safety margin of the system as an excuse for taking risks. ◀

### The concept

DSC maintains vehicle stability, even in critical driving situations.

The DSC is operational every time you start the engine.

DSC incorporates the Dynamic Traction Control (DTC) and Cornering Brake Control (CBC) functions.

Additional information on DSC is found in the "Technology" brochure.

### Indicator lamp



The indicator lamp in the instrument cluster goes out shortly after the ignition has been switched on; refer to page 20.

- ▷ The indicator lamp flashes: DSC is actively controlling drive torque and braking intervention
- ▷ The indicator lamp stays lit: DSC has been switched off with the button; DTC and DBC are operational. DTC control intervention is not indicated.



The indicator and the brake warning lamps will remain on continuously yellow:



The DSC, DTC and DBC have been switched off manually or there is a system malfunction.

The vehicle will remain completely operational, however, without DSC. In the event of a fault, please consult your BMW center.



Indicator and warning lamps for Canadian models.



### Deactivating the DSC/activating the DTC

Press the DSC button briefly; the indicator lamp comes on and stays on.

DSC is deactivated; DTC is operational.

In the following rare situations, it may prove useful to activate the DTC for a brief period:

- ▷ When rocking the vehicle or starting off in deep snow or on loose surfaces
- ▷ When driving on snow-covered grades, in deep snow, or on a snow-covered surface that has been packed down from being driven on
- ▷ When driving with snow chains.



## Dynamic Stability Control (DSC)\*

Under these special circumstances traction is increased by deactivating the control systems that enhance traction under normal conditions.

### Deactivating the DSC and the DTC

Press the DSC button down for at least 3 seconds; the indicator lamp and the yellow brake warning lamp will remain on continuously.

The systems for enhancing stability and traction are deactivated, and there is no active braking intervention or torque control.



To maintain vehicle stability, always drive with the DSC activated whenever possible. ◀

### Reactivating the DSC

Press the button again briefly; the indicator lamp or the indicator lamps will go out. DTC is deactivated.



The laws of physics cannot be repealed, even with DSC. An appropriate driving style always remains the responsibility of the driver. We therefore urge you to avoid using the additional safety margin of the system as an excuse for taking risks. Whenever the DTC is activated, the DSC is switched off and DTC performs minor stabilizing intervention. Do not make any modifications to the DSC system. Allow only authorized technicians to perform service procedures on the DSC. ◀

### The concept

DSC maintains vehicle stability, even in critical driving situations.

The DSC is operational every time you start the engine.

DSC includes the Automatic Differential Brake (ADB-X) and Cornering Brake Control (CBC) functions.

Additional information on DSC is found in the "Technology" brochure.

### Indicator lamp



The indicator lamp in the instrument cluster goes out shortly after the ignition has been switched on; refer to page 20.

- ▷ The indicator lamp flashes: DSC is actively controlling drive torque and braking intervention
- ▷ The indicator lamp stays lit: DSC has been switched off with the button; ADB-X is operational. ADB-X control intervention is not indicated.



If the indicator lamp fails to go out when you press the DSC button, this indicates a malfunction in the DSC and ADB-X systems; the system is deactivated, and the stability enhancement functions are no longer available. ◀

The vehicle will remain completely operational, however, without DSC. In the event of a fault, please consult your BMW center.



### To deactivate DSC

Press the DSC button; the indicator lamp comes on and stays on.

DSC is now off, and ADB-X reverts to its maximum torque-transfer mode.

In the following exceptional circumstances, it may be effective to deactivate the DSC for a short period:

- ▷ When rocking the vehicle or starting off in deep snow or on loose surfaces
- ▷ When driving with snow chains.



To maintain vehicle stability, always drive with the DSC activated whenever possible. ◀

# Dynamic Stability Control (DSC) – BMW 325xi, 330xi

## Reactivating the DSC

press the button again; the indicator lamp goes out.



The laws of physics cannot be repealed, even with DSC. An appropriate driving style always remains the responsibility of the driver. We therefore urge you to avoid using the additional safety margin of the system as an excuse for taking risks. The system does not intervene to enhance vehicle stability when switched off. Do not make any modifications to the DSC system. Allow only authorized technicians to perform service procedures on the DSC. ◀

### The concept

By reducing the vehicle's speed on steep downhill stretches, HDC maintains predictable vehicle handling response to provide you with control of your BMW during extreme descents.

The vehicle slows to a pace just slightly faster than walking speed.

HDC is available for activation at vehicle speeds below approx. 22 mph / 35 km/h. When driving down steep hills, the vehicle reduces speed automatically down to about double walking speed – approx. 7.5 mph / 12 km/h – and then maintains this speed at a constant.

You can use the accelerator or brakes to vary this speed within a range from approx. 3 mph / 5 km/h to approx. 15 mph / 25 km/h.

In conjunction with the steering wheel with multifunction buttons you can use the +/- button to set the cruise control to a target speed in the range from approx. 3 mph / 5 km/h to approx. 15 mph / 25 km/h.

HDC is automatically deactivated once vehicle speed again exceeds approx. 37 mph / 60 km/h.



### To activate the system

Press the HDC button; the green indicator lamp integrated within the button comes on.

The indicator lamp flashes whenever the system is actively intervening to control your speed with automatic brake applications.

### To deactivate the system

Press the button again, the indicator lamp goes out.

HDC is automatically deactivated once the vehicle accelerates to more than 37 mph / 60 km/h, as well as whenever you switch off the ignition.

### To use HDC

Vehicles with manual transmission:

You should always ensure that either reverse or first gear is engaged before using HDC, as the engine's braking effect is most pronounced in these gears, and only reduced engine braking is available in higher gears.

Vehicles with automatic transmission: HDC is available for use in all ranges.

### System malfunctions

Are signaled by the indicator lamp, which responds to problems by going out while HDC is in operation or by failing to come on when you activate the system:

HDC has been temporarily deactivated as a result of high brake temperatures.



If the DSC indicator lamp comes on at the same time:

Malfunction in HDC and DSC system. Refer the problem to your BMW center.

# Tire Pressure Monitor (TPM)\*

## The concept

TPM monitors the tire pressures at all four tires even while the vehicle is moving. The system provides an alert whenever the inflation pressure drops significantly below the specified pressure in one or more tires.



This indicator lamp in the instrument cluster informs you when the tire pressure deviates from the target values.



## Initializing the system

Initializing is necessary to familiarize the system with the correct inflation pressures.

Repeat this process after tire replacement, tire rotation or any changes in tire inflation pressure.

1. Check the tire inflation pressures in all the tires, comparing them with the inflation pressure chart on page 25 and adjusting their pressure if necessary
2. Turn ignition key to position 2, do not start the engine
3. Press the button long enough for the yellow indicator lamp in the instrument cluster to light up for a few seconds

4. After a few minutes' driving time, TPM sets the current inflation pressures in the tires as the target values to be monitored.

## In the event of loss in inflation pressure

If the inflation pressure has dropped significantly over a long period of time, which is normal for any tire, the yellow indicator lamp will come on.

This alerts you to have the tires inflated to the specified pressures as soon as possible.

 If you are prompted to check the tire pressure shortly after a correction has been made, this indicates that the corrected values were not valid. Please check the inflation pressure again and make corrections according to the inflation pressure table. Then reinitialize the system. ◀

## Flat tire

If there is a tire failure with loss of pressure, a red light will appear in the indicator lamp. This visual alert is accompanied by an acoustic warning signal.

If this occurs, reduce vehicle speed immediately and stop the vehicle in a safe location. Avoid hard brake applications. Do not oversteer. Replace the defective tire, refer to page 141.



The space-saver spare tire is provided for temporary use only in the case of a tire failure. It does not have TPM electronics and is not monitored. The spare tire that has the same dimensions as the tires already mounted on the vehicle is equipped with the necessary TPM electronics and will also be monitored once the tire has been mounted and the system initialized. ◀



The TPM cannot alert you to severe and sudden tire damage caused by external factors. ◀



Have the tires changed by your BMW center. Your BMW center has the information needed for working with TPM and is equipped with the necessary special tools. ◀

### **System interference**

Local devices using the same radio frequency can interfere with TPM.

### **The concept**

As you drive, the Flat Tire Monitor keeps track of pressure levels in all four tires in order to detect and warn of any substantial pressure loss.

The system actually detects pressure loss by monitoring differences in the relative speeds of the four wheels. It interprets variations outside specified limits as severe pressure loss, and then responds by generating a warning.

The yellow indicator lamp will come on during the malfunction.

The indicator lamp also comes on

- ▷ in the event of a system fault
- ▷ if a wheel is mounted without the appropriate electronics
- ▷ if, in addition to the spare tire, additional wheels with TPM electronics are on board.

Please refer the problem to your BMW center.

## Flat Tire Monitor\*



3. Press button as long as you need to until the indicator lamp in the instrument cluster lights up. After a little while, the indicator lamp will go out by itself
4. After a few minutes' driving time, the Flat Tire Monitor adopts the current pressure levels as the reference, and from that point on, can detect and report a flat tire.



### Initializing the system

Initializing is necessary to familiarize the system with the correct inflation pressure.

Repeat this process after any changes in tire inflation pressure, tire rotation or replacement. Do not carry out further system initialization after adjusting the inflation pressure and letting the system "learn" the correct pressures.

1. Check the tire inflation pressures in all the tires, comparing them with the inflation pressure chart on page 25 and adjusting their pressure if necessary
2. Turn the ignition key to position 2

### To activate/deactivate the system

The Flat Tire Monitor automatically assumes operation whenever you turn the ignition key to position 2. Unless manually deactivated, it is always on during normal vehicle operation.

To deactivate the system: press the button, the yellow indicator lamp comes on.

To activate the system: press the button again, the indicator lamp goes out.

You should deactivate the system before driving with snow chains, as the chains can generate spurious warnings and/or prevent the system from detecting actual pressure loss.

**Flat tire**

The red warning lamp in the instrument cluster lights up to warn of pressure loss and tire failure. This visual alert is accompanied by an acoustic warning signal. Reduce your speed immediately, and steer and brake gently as you bring the vehicle to a stop.

To reset the warning lamp: after replacing the damaged tire you will need to reset the red warning lamp manually: maintain pressure on the Flat Tire Monitor button until the warning lamp goes out. Then reinitialize the system.



The Flat Tire Monitor cannot provide you with advance warning of sudden and severe tire damage caused by external factors.

The system also does not detect the gradual and minor loss of pressure that all tires display over extended periods of time. ◀



Check tire inflation pressures on a regular basis, correcting them as necessary; refer to page 25.

The system may respond to operation on slippery or snow-covered road surfaces with false warnings or delays in detecting actual pressure loss.

Performance-oriented driving – slip at the drive wheels, high rates of lateral acceleration – can also increase the time that the Flat Tire Monitor requires to detect a flat. ◀

**System malfunctions**

The yellow indicator lamp in the instrument cluster lights up and remains on until the problem is corrected.

Please refer the problem to your BMW center.



## Parking lamps/Low beams



### Parking lamps

 The front, rear and side vehicle lighting is switched on. You can use the parking lamps to signal the position of the vehicle when it is parked. For lighting on one side for parking as an additional feature, refer to page 90.

### Low beams

 When the ignition is switched off while the low beams are on, the headlamps go out and only the parking lamps remain on.

### Follow me home lamps

When you activate the headlamp flasher after parking the vehicle with the lamps turned off, the low-beam headlamps will come on for a short time.



You can also have this function deactivated. ◀

### LIGHTS ON warning

When you open the driver's door after having turned the ignition key to position 0, you will hear an acoustic signal for a few seconds to remind you that the lamps have not been switched off.

### Daytime driving lamps\*

If you desire, the light switch can be left in the second position: when the ignition is switched off, the external lighting is also switched off.



You can have the activation settings for the daytime driving lamps programmed on your vehicle. ◀

### Automatic headlamp control\*



When the switch is set to this position, the system automatically activates and cancels the low beams in response to changes in ambient light – in tunnels, at dusk, etc. – and in the event of rain and snow.



The vehicle's external lights remain on constantly when you switch on the front fog lamps after the headlamps have come on automatically. ◀



Automatic headlamp control cannot serve as a substitute for the driver's judgement in determining when the vehicle lights should be switched on. For example, the sensors are not able to detect fog. To avoid safety risks, you should respond to these kinds of low-visibility situations by switching the headlamps on manually. ◀



You can have the sensitivity of your vehicle's automatic headlamp control adjusted. ◀

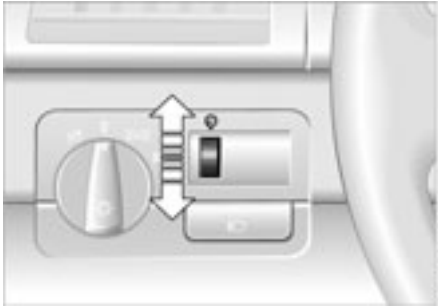

Turn the rotary dial to adjust the illumination intensity.

- 1 High beams – blue indicator lamp
- 2 Headlamp flasher – blue indicator lamp
- 3 Parking lamps

**Standing lamps, left or right**

As an additional feature, you can illuminate your vehicle on either side for parking:

With the ignition key in position 0, engage the lever in the appropriate turn-signal position.

## Fog lamps\*



### Front fog lamps



The green indicator lamp in the instrument cluster lights up to indicate that the front fog lamps are on.



If the automatic headlamp control is on, the low beams will come on automatically whenever you activate the front fog lamps. ◀

## Interior lamps



The interior lamps operate automatically.

### To switch the interior lamps on and off manually

Press button 1 briefly:

If you want the interior lamps to remain off all the time, press and hold the button for approx. 3 seconds.

Press the button briefly to revert to normal operation.

### Front reading lamps\*

Switch on and off with the button 2 adjacent to each lamp.



### Rear reading lamps

Switch on and off with the button adjacent to each lamp.



In order to prevent battery discharge, all of the lamps in the vehicle are automatically switched off approx. 15 minutes after you turn the ignition key to position 0. ◀

## 92 Air conditioning

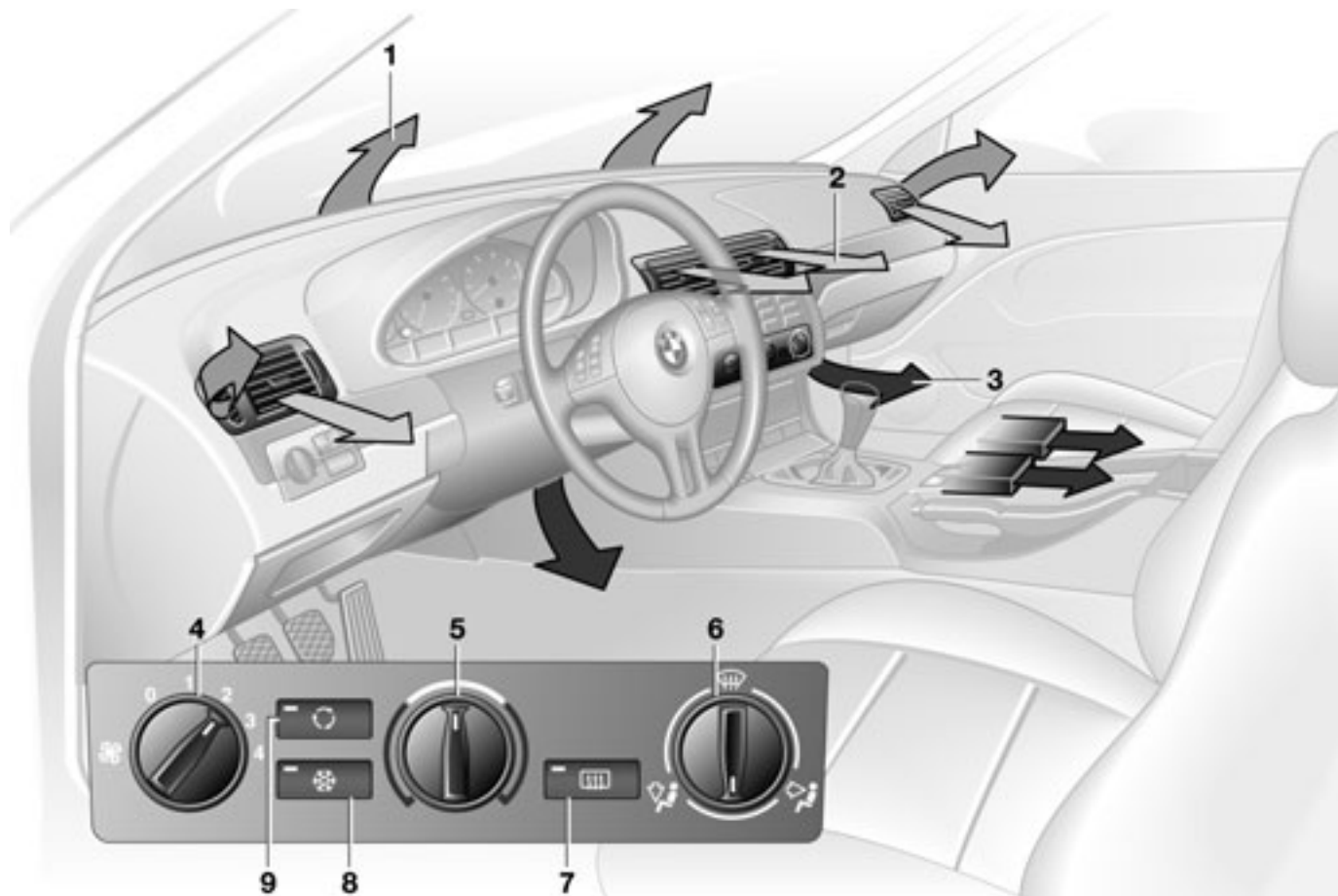

# Air conditioning

- 1 Air onto the windshield and the side windows
- 2 Air for the upper body area [95](#)
- 3 Air to the footwell
- 4 Air supply/Blower [94](#)
- 5 Temperature [94](#)
- 6 Air distribution [94](#)
- 7 Rear window defroster [94](#)
- 8 Air conditioning [94](#)
- 9 Outside air/Recirculated-air mode [94](#)





**Air supply/Blower**

You can select blower speeds from 1 to 4. The heating and ventilation become more and more effective as the air supply settings are increased. In position 0, the blower and the heater are switched off. The outside air supply is blocked in position 0.

**Temperature**

In order to increase the temperature of the passenger compartment, turn to the right toward the red zone. The temperature of the incoming air is kept constant.

**Air distribution**

You can direct air to flow onto the windows , toward your upper body  or into the footwell . All intermediate settings are possible. In the setting , there is a low flow of air onto the windows to keep them free of condensation.

**Rear window defroster**

When the rear window defroster is activated, the indicator lamp comes on. The rear window defroster switches off automatically.



You can have your vehicle programmed in such a way that the rear window defroster switches on automatically. This occurs within 5 minutes after starting the engine when outside temperatures are below approx. 39 °F / +4 °C. ◀

**Air conditioning**

The air is cooled and dehumidified and – depending on the temperature setting – rewarmed.

Depending on the weather, the windshield may fog over briefly when the engine is started. Air conditioning helps prevent the windows from fogging up.



Condensation forms during operation of the air conditioning system, which then exits under the vehicle. Traces of condensed water of this kind are thus normal. ◀

**Outside air/Recirculated-air mode**

You can respond to unpleasant external odors by temporarily blocking the supply of outside air. The system then recirculates the air currently within the vehicle.



If the windows should fog over in the recirculated-air mode, switch this mode off and increase the air supply as required. ◀

# Air conditioning

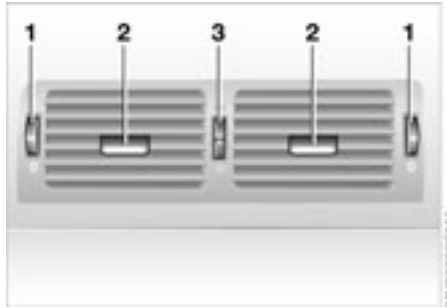

## Draft-free ventilation

You can adjust the blower controls for the upper body area to obtain the optimum airflow rates and directions for your personal requirements:

- 1 Rotary dials for infinitely variable opening and closing of the vent outlets
- 2 Levers for airflow direction
- 3 Rotary dial allows you to control the temperature of the airflow from these outlets as desired

## Microfilter

The built-in microfilter removes dust and pollen from the incoming air. Your BMW center will replace it during routine maintenance. A substantial reduction in airflow indicates that the filter needs to be replaced before scheduled maintenance.



## To defrost windows and remove condensation

1. Set the blower speed control for the air supply to position 4
2. Turn the rotary temperature control completely to the right to the red zone
3. Turn the rotary control for air distribution to position 
4. Switch on the rear window defroster to defrost the rear window.

96 Automatic climate control\*

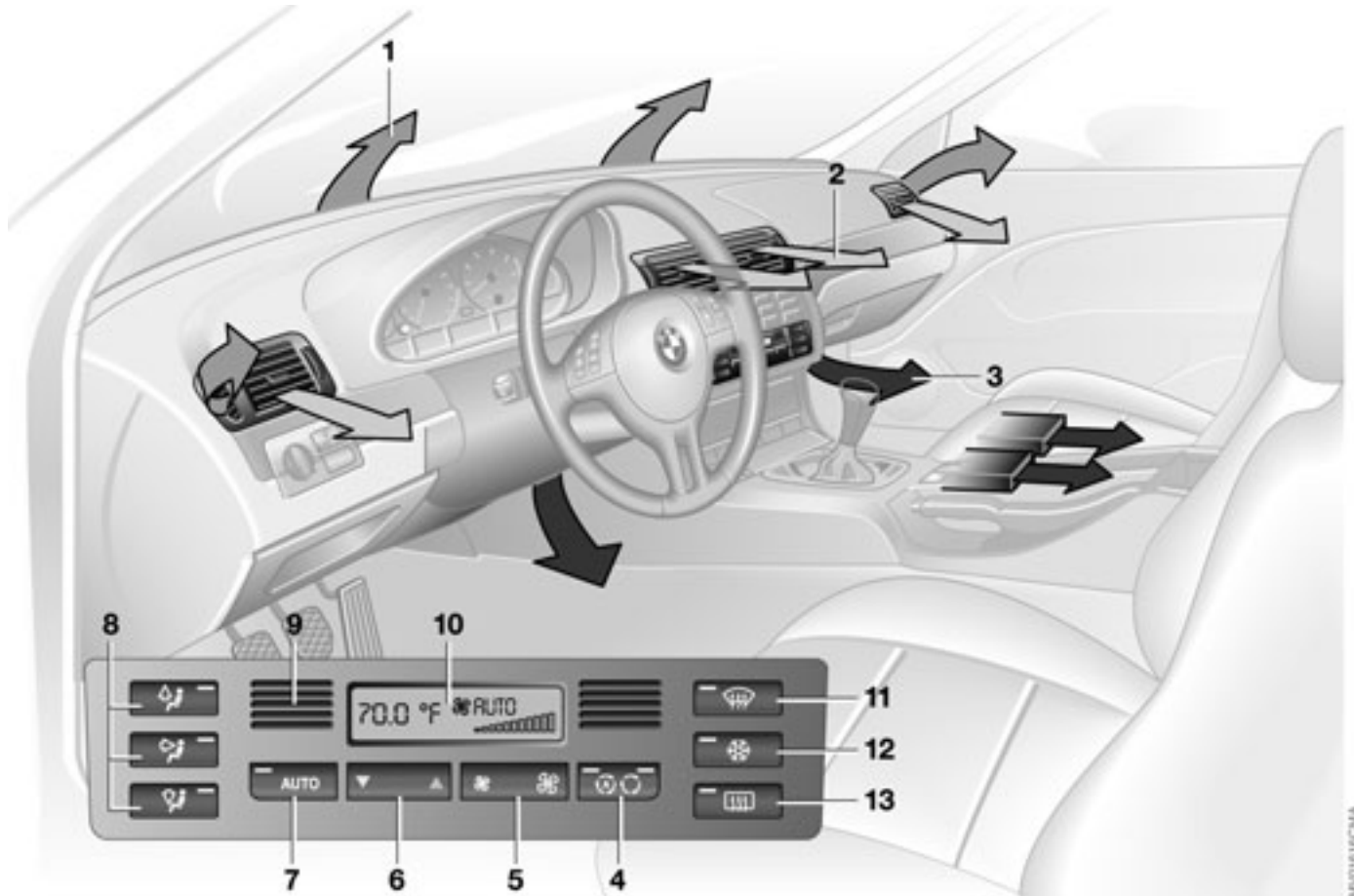



## Automatic climate control\*

- 1 Air onto the windshield and the side windows
- 2 Air for the upper body area [99](#)
- 3 Air to the footwell
- 4 Outside air/Automatic recirculated-air control (AUC)/Recirculated air [99](#)
- 5 Air supply/Blower [98](#)
- 6 Temperature [98](#)
- 7 Automatic air distribution and supply [98](#)
- 8 Individual air distribution [98](#)
- 9 Interior temperature sensor – please keep clear and unobstructed
- 10 Temperature display [98](#),  
air supply [98](#)
- 11 To defrost windows and remove condensation [98](#)
- 12 Air conditioning [98](#)
- 13 Rear window defroster [99](#)

**Tips for pleasant driving**

Use the automatic mode – switch on with AUTO button 7. Select the desired interior temperature.

Detailed setting options are described for you in the following section.





You can make the settings of your vehicle in such a manner that, when you unlock the vehicle with the remote control of your personal key, your own personalized setting for the automatic climate control is initiated. ◀

**Automatic air distribution and supply**

The AUTO program adjusts the air distribution and the air supply for you and in addition adapts the temperature to external influences – summer, winter – to meet preferences you can specify.

**Individual air distribution**

You can cancel the AUTO program by selecting specific distribution patterns to suit your own individual requirements. While the AUTO program is then deacti-

vated, the automatic airflow control remains in operation. Air flows onto the windows , toward the upper body , and into the footwell .

You can reactivate the automatic air distribution mode by selecting the AUTO button.

**Temperature**

The interior temperature that appears in the display panel is a general figure intended for reference purposes. We recommend 72 °F / +22 °C as a comfortable setting, even if the air conditioning is on. When you start the vehicle, the system ensures that the selected temperature is achieved as quickly as possible. It then maintains this temperature, regardless of the season.

To select the units of measure, °C or °F, for the display, refer to page 75.

**Air supply/Blower**

By pressing the left or right half of the button, you can vary the air supply. This deactivates the automatic control of the air supply, AUTO disappears from the display panel. Nev-

ertheless, the automatic air distribution remains unchanged. You can reactivate the automatic air distribution mode by selecting the AUTO button.

When the lowest blower speed is set and you press the left half of the button, all of the displays are canceled: the blower, heating and air conditioning are switched off. The outside air supply is blocked. You can reactivate the system by pressing any button for the automatic climate control.

**To defrost windows and remove condensation**

This program quickly removes ice and condensation from the windshield and the side windows.

**Air conditioning**

The air is cooled and dehumidified and – depending on the temperature setting – rewarmed.

Depending on the weather, the windshield may fog over briefly when the engine is started. Air conditioning helps prevent the windows from fogging up.

## Automatic climate control\*

 Condensation forms during operation of the air conditioning system, which then exits under the vehicle. Traces of condensed water of this kind are thus normal. ◀

### Outside air/Automatic recirculated-air control (AUC)/ Recirculated air

 You can respond to unpleasant external odors or pollutants by temporarily stopping the flow of outside air. The system then recirculates the air currently within the vehicle.

Press the button repeatedly to select one of three different operating modes.

- ▷ Indicator lamps off: outside airflow is on
- ▷ Left indicator lamp on – AUC mode: the system recognizes pollutants in the outside air and blocks the flow of air when necessary. The system then recirculates the air currently within the vehicle. Depending on the air quality, the automatic system then switches back and forth between outside air supply and recirculation of the air within the vehicle
- ▷ Right indicator lamp on: the flow of external air into the vehicle is permanently blocked. The system then

recirculates the air currently within the vehicle.

 If the windows should fog over in the recirculated-air mode, switch this mode off and increase the air supply as required. ◀

### Rear window defroster

 When the rear window defroster is activated, the indicator lamp comes on. The rear window defroster switches off automatically.

 You can have your vehicle programmed in such a way that the rear window defroster switches on automatically. This occurs within 5 minutes after starting the engine when outside temperatures are below approx. 39°F/+4°C. ◀

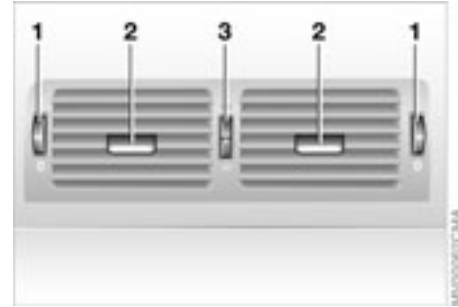

### Draft-free ventilation

You can adjust the blower controls for the upper body area to obtain the optimum airflow rates and directions for your personal requirements:

- 1 Rotary dials for infinitely variable opening and closing of the vent outlets
- 2 Levers for airflow direction
- 3 Rotary dial allows you to control the temperature of the airflow from these outlets as desired

### **Microfilter/activated-charcoal filter**

The built-in microfilter removes dust and pollen from the incoming air. The activated-charcoal filter provides additional protection by filtering gaseous pollutants from the outside air. Your BMW center replaces this combined filter as a standard part of your scheduled maintenance. A substantial reduction in airflow indicates that the filter needs to be replaced before scheduled maintenance.

### **Roller sun blind\***



To actuate, press the button briefly with the ignition key in position 1 or higher.

The illustration depicts the arrangement of the buttons if the vehicle is fully equipped. The arrangement varies depending on the equipment actually installed.

## Premium sound system\*



### Harman Kardon premium sound system

Press the button to activate and deactivate the acoustic enhancement.

The system creates the acoustic impression of a much larger passenger compartment accompanied by improved stereophonic sound at all seating positions.

The system responds to poor reception conditions by repeatedly alternating between the stereo and monophonic modes. You should then switch the system off.

## Glove compartment

101



### To open

Pull the handle. The lamp in the glove compartment comes on.

### To close

Fold the cover up.

 To prevent injury in the event of an accident, close the glove compartment immediately after use. ◀

### To lock

Lock with one of the master keys. A master key will also be required to unlock the glove compartment.

Overview

Controls

Maintenance

Repairs

Data

Index

 If – for example for valet parking – you turn over only your door and ignition key, refer to page 30, then access to the glove compartment is not possible. ◀

### Rechargeable flashlight

The flashlight is located on the left side of the glove compartment.

It features integral overload-protection, so it can be left in its holder continuously.

 To avoid completely discharging and possibly damaging the lamp, always ensure that it is switched off before inserting it in the socket. ◀

## Storage compartments



### Front center armrest

To release: press the button – see arrow – and lift upward.

### Additional compartments and nets\*

You will find additional storage compartments in the front doors and in the center console. Storage nets are on the front seat backrests.

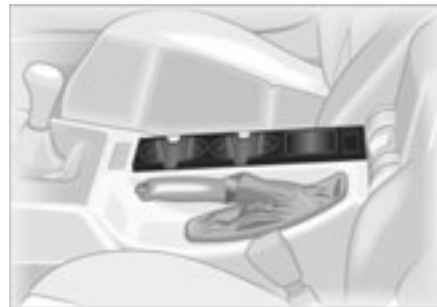

### Beverage holder, coin box

A coin box and two beverage holders are provided in the center console.



## Rear center armrest\*

Without through-loading system:

The rear center armrest includes a storage compartment, a beverage holder and a litter bag holder.

- 1 Storage compartment: pull up
- 2 Beverage holder: press



## Rear center armrest\*

With through-loading system:

The rear center armrest includes a beverage holder and a litter bag holder.

- ▷ Beverage holder: press.



## Storage package\*

For your convenience, there are:

- ▷ Two flip-out sockets on the rear center console
- ▷ An eyeglass compartment\*, not shown, in the front center console.



### Hands-free system

On vehicles that are wired for a telephone\* or equipped with a communication package\*, the cover for the hands-free microphone is located in the headliner near the interior lamp.

For further information on using your cellular phone, refer to the separate Owner's Manual for the telephone.

### Ashtray, front\*



### To empty

Press on the edge of the open cover – see arrow: the ashtray moves up and can be removed.

### Cigarette lighter



Hold or touch the hot cigarette lighter by the knob only. Holding or touching it in other areas could result in burns.

The cigarette lighter remains operational when the ignition key has been removed. For this reason, children should never be left in the vehicle unattended. ◀

Press lighter 1 in. You can remove the lighter from its socket for use as soon as it springs back out.

### Cigarette lighter socket

Suitable for attaching power supplies for flashlights, car vacuum cleaners, etc., up to a rating of approx. 200 watts at 12 volts. Avoid damage to the socket caused by inserting plugs of different shapes or sizes.



## Ashtray, rear\*



### To empty

Press on the edge of the raised cover to open – see arrow: the ashtray moves up and can be removed.



1. Pull the corresponding lever to release – see arrow



2. The backrest moves forward slightly when released. Reach into the gap and fold it down.

 When folding the backrest back into its original position always ensure that the detent engages securely. A loose backrest might fail to prevent cargo from entering the passenger compartment during sudden braking or evasive maneuvers, posing a potential hazard to occupants. ◀

The fittings at the corners of the luggage compartment provide you with a convenient means of attaching luggage nets\* and flexible straps for securing luggage.

Refer also to Cargo loading on page [108](#).

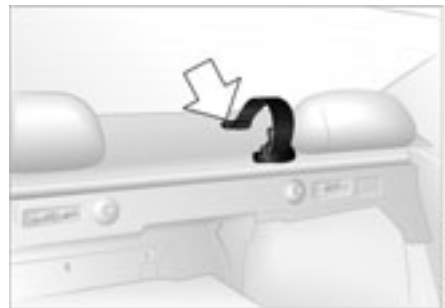

### **Rear center 3-point safety belt\***

You can roll up the rear 3-point belt before folding back the through-loading system:

- ▷ Release the belt and insert its latch in the recess provided for this purpose in the rear tray – see arrow.

## Ski bag\*

The ski bag allows the safe and clean transport of up to 4 pairs of standard skis or up to two snowboards.

The length of the ski bag and the additional space provided in the luggage compartment make it possible to carry skis up to 6 ft 10 in / 2.10 m long.

Because of the tapered shape of the bag, only two pairs of skis longer than 6 ft 10 in / 2.10 m can be carried.

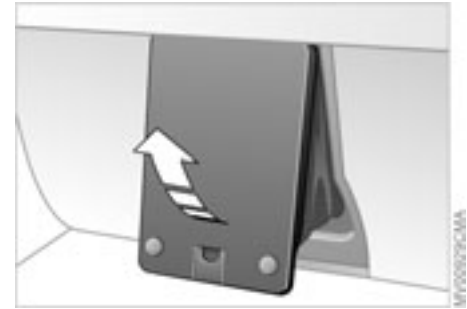
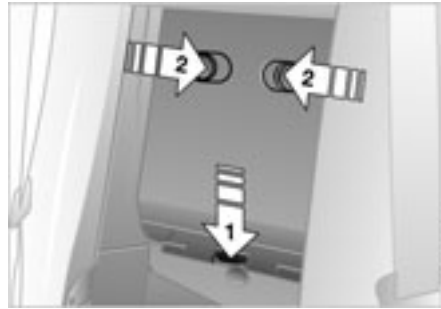

### Loading

Vehicles without through-loading system:

1. Fold the center armrest outward.  
Loosen the trim from the upper Velcro® fastener and place it on the armrest
2. Press the button – see arrow 1, from inside the passenger compartment: this releases the cover panel in the luggage compartment
3. Press the detent levers inward – see arrows 2 – and fold the cover to the front
4. Extend the ski bag between the front seats. The zipper provides convenient access to stored items. It may be opened to allow the ski bag to dry

5. Use the magnetic retainers to attach the cover panel to the upper surface – metal surface below rear tray – of the luggage compartment.

To store the ski bag, perform the above steps in reverse sequence.

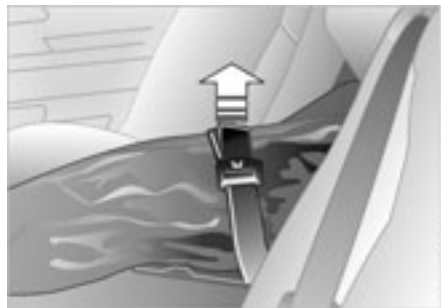

### Loading

Vehicles with through-loading system:

1. Fold the center armrest outward. Loosen the trim from the upper Velcro® fastener and place it on the armrest
2. Press the button downward – see arrow 1 – and swing the cover forward
3. Extend the ski bag between the front seats. The zipper provides convenient access to stored items. It may be opened to allow the ski bag to dry
4. Press the button – see arrow 2: the cover in the luggage compartment is unlocked.

To store the ski bag, perform the above steps in reverse sequence.

### Securing cargo

 Secure skis and any other objects stored in the bag by tightening the retaining strap at the buckle. ◀

 Be sure that your skis are clean before loading them into the bag. Avoid damage from sharp edges during loading. ◀

## Cargo loading

 Always position and secure loads correctly. If you do not, the load can endanger the passengers during braking or evasive maneuvers. Do not exceed the approved gross weight or the approved maximum axle loads, refer to page 154, otherwise the vehicle's operating safety is no longer assured and you are in violation of the law.

Do not stow heavy or hard objects in the passenger compartment without securing them. Otherwise they would be thrown around during braking and evasive maneuvers and could endanger the passengers. ◀

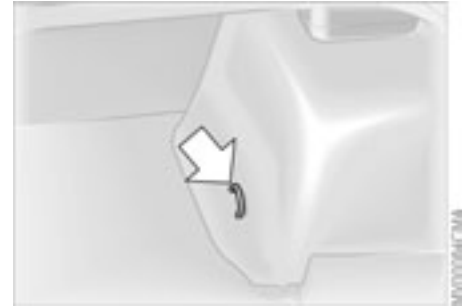
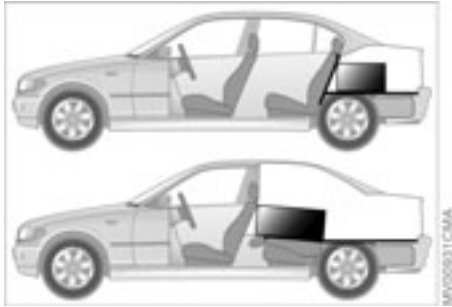

## Stowing cargo

- ▷ Load heavy cargo as far forward as possible – directly behind the backrests or the luggage compartment partition – and as low as possible
- ▷ Cover sharp edges and corners
- ▷ Do not pile objects higher than the top edge of the backrest

- ▷ For transporting very heavy loads when the rear seat is not occupied, secure the outer safety belts in the opposite buckles, refer to the illustration.

## Securing cargo

- ▷ For small, light items, use the rubber-lined, non-skid side of the floor mat or secure using the luggage compartment net\* or elastic straps, refer to page 37
- ▷ For large, heavy pieces, see your BMW center for load-securing devices\*. Lashing fittings located in the luggage compartment can be used for fastening the load-securing devices; see arrow.

Read and comply with the instructions enclosed with the load-securing devices.



A special roof-rack system is available as an optional extra for your BMW. Please observe the precautions included with the installation instructions.

### **Anchorage**

Access to the anchorages:

To fold up the cover – see arrow – please use the tool provided with the roof-rack system.

### **Loading and driving notes**

Roof-mounted luggage racks raise the center of gravity of the vehicle when they are loaded. For this reason, they exercise a major effect on the vehicle's handling and steering response.

You should therefore always remember not to exceed the approved roof load capacity, the approved gross vehicle weight or the axle loads when loading the rack. These weights are listed under Technical data on page 154.

Make sure that the load is not too heavy, and attempt to distribute it evenly. Always load the heaviest pieces first so that they are at the bottom. Be sure that adequate clearance is maintained for raising the sliding/tilt sunroof, and that objects do not project into the opening path of the luggage compartment lid.

Secure the roof-mounted luggage correctly and securely to prevent it from shifting or being lost during driving.

Drive smoothly and avoid sudden acceleration and braking. Do not corner at high speeds.

The roof-mounted luggage rack and the roof load increase the aerodynamic resistance: increased fuel consumption and additional stress on the vehicle's body are the result.







Overview

Controls and features

Operation, maintenance

Owner service procedures

Technical data

Index



Overview

Controls

Maintenance

Repairs

Data

Index

To ensure that your vehicle continues to provide maximum economy throughout an extended service life, we request that you devote careful attention to the following instructions.

### **Engine and differential**

The first 1,250 miles/2,000 km:

Attempt to constantly vary both vehicle and engine speeds during these initial miles while remembering to avoid engine speeds in excess of 4,500 rpm and/or vehicle speeds of over 100 mph / 160 km/h:

Always obey all official speed limits.

Refrain from using full throttle and avoid pressing the accelerator beyond the kickdown point.

You can then proceed to increase both engine and vehicle speeds once the initial 1,250 miles/2,000 km have elapsed.

Please remember to observe these same break-in procedures if either the engine or the differential should have to be replaced later in the course of the vehicle's service life.

### **Tires**

Owing to technical factors associated with their manufacture, tires do not achieve their full traction potential until an initial break-in period has elapsed. We thus ask you to drive with extra care during the first 200 miles/300 km.

Always obey all official speed limits.



When the vehicle is operated on wet or slushy roads, a wedge of water may form between the tire and the road surface. This phenomenon is referred to as hydroplaning and can lead to partial or complete loss of traction, vehicle control and braking effectiveness. Reduce your speed on wet roads. ◀

### **Brake system**

Approx. 300 miles/500 km must elapse before the brake pads and rotors achieve the optimal pad-surface and wear patterns required for trouble-free operation and an extended service life later on.

To break in the separate parking brake drums, apply the parking brake lightly when coasting to a standstill – at a traffic signal, for instance; use caution to avoid posing a danger to other road users.

You can prevent corrosion in the drums by periodically repeating this procedure.



The brake lamps do not come on when the parking brake is set. Vacuum for the brake system servo unit on your BMW is available only when the engine is running. When you move the vehicle with the engine off – when towing, for example – substantially higher levels of pedal force will be required to brake the vehicle. ◀

### **Clutch**

Approx. 300 miles/500 km must elapse before the clutch starts to operate at optimum efficiency. Remember to engage the clutch carefully during this initial period.

## Driving notes



**Brakes:** do not drive with your foot resting on the brake pedal. Even light but consistent pedal pressure can lead to high temperatures, brake wear and possibly even brake failure.

**Hydroplaning:** when driving on wet or slushy roads, reduce vehicle speed. If you do not, a wedge of water may form between the tires and the road surface. This phenomenon can lead to partial or complete loss of contact between the tires and road surface, as well as loss of vehicle control and braking ability.

**Driving through water:** do not drive through water on the road if it is deeper than 1 ft/30 cm, and then only at walking speed. Otherwise, the vehicle's engine, the electrical systems and the transmission may be damaged.

**Rear tray:** never use it to store heavy or hard objects, as otherwise occupants could be injured during braking maneuvers.

**Clothes hooks:** when hanging clothing from the hooks, be sure that they will not obstruct the driver's vision. Do not hang heavy objects on the hooks. If you do so, they could cause personal injury during braking or evasive maneuvers. ◀

## Antilock Brake System (ABS)

### The concept

ABS keeps the wheels from locking during braking, thereby enhancing active driving safety.

### Braking with ABS

If you are in a situation that requires full braking, you will exploit the full benefits of the ABS system if you apply maximum pedal pressure – panic stop. Since the vehicle maintains steering responsiveness, you can avoid possible obstacles with a minimum of steering effort, despite the full brake application.

Pulsation at the brake pedal combined with sounds from the hydraulic circuits indicates to the driver that ABS is in its active mode.

### Dynamic Brake Control (DBC)

DBC is included in the DSC, refer to page 80.

The system responds to sudden, high-intensity applications of force to the brake pedal by automatically braking the vehicle with maximum boost to achieve the shortest possible braking distances during "panic stops". This system exploits all the benefits of ABS.

Do not reduce the pressure exerted against the brake pedal until the braking maneuver has been completed. DBC is deactivated when you release the brake pedal.

### Cornering Brake Control (CBC)

CBC is an advanced engineering development of ABS. When braking during cornering with high lateral acceleration, or when braking during a lane change, vehicle stability is improved and the steering response is enhanced.

**Brake fluid level**

If the brake fluid level is too low and brake pedal travel has become longer, there may be a defect in one of the brake system's hydraulic circuits.

 Proceed to the nearest BMW center. It may be necessary to apply higher levels of pressure to the pedal when stopping and braking distances may also be longer. Please remember to adapt your driving style accordingly. ◀

**Disc brakes**

Limited vehicle use, extended periods with the vehicle parked or in storage, and operating conditions in which braking is restricted to gentle, low-pressure applications will all increase the tendency for corrosion to form on the rotors; this is often accompanied by a simultaneous accumulation of contamination on the brake pads. The pads must exert a certain minimal level of pressure against the rotors for the disc brakes' inherent self-cleaning effect to remain effective; the pressure available under the above conditions may not provide adequate cleansing.

If the brake rotors are corroded, they will tend to respond to braking with a pulsating effect that even extended brake applications will fail to cure.

When driving in heavy rain and on wet roads it is a good idea to apply light pressure to the brake pedal every few miles. Monitor traffic conditions to ensure that this maneuver does not pose a hazard to you or to other road users. The heat generated in this process helps dry the pads and rotors to ensure that your brake system will respond with undiminished efficiency when you need it.

When descending steep hills and extended grades, downshift to a gear that will allow you to continue safely with only a minimal amount of braking. By minimizing the loads placed on the brake system, this strategy helps ensure that optimal brake system response will remain available at all times. Use care to avoid exceeding the approved engine-speed range, refer to page 71.

 Do not coast with the clutch depressed or with the transmission or selector lever in Neutral. Do not coast with the engine shut off. The

engine provides no braking effect when the clutch is depressed and there is no power-assist for braking or steering when the engine is not running. BMW 325xi, 330xi: always refer all brake inspection and service work to your BMW center, as failure to observe the special procedures could result in damage to components of the all-wheel drive.

Never allow floor mats, carpets or any other objects to protrude into the area around the accelerator, clutch and brake pedals and obstruct their movement. ◀

**Brake pads**

 For your own safety: use only brake pads that BMW has released for your particular vehicle model. BMW cannot evaluate non-approved brake pads to determine if they are suitable for use, and therefore cannot ensure the operating safety of the vehicle if they are installed. ◀

## Tire inflation pressure

### Information for your safety

The factory-approved tires are matched to your vehicle and have been selected to provide optimum safety and driving comfort when used properly.

It is not merely the tire's service life, but also driving comfort and – above all else – driving safety that depend on the condition of the tires and the maintenance of the specified tire inflation pressure.

Incorrect tire inflation pressure is a frequent cause of tire damage. Tire pressure also has a major effect on your BMW's handling response.

 Be sure to check the tire inflation pressure, including the pressure of the space-saver spare tire or the spare tire, on a regular basis, at least twice a month and before every extended journey, refer to page 25. Otherwise, incorrect tire pressure can lead to poor handling, to tire damage and accidents. ◀

## Tire condition



### Tire tread – tire damage

Inspect your tires frequently for tread wear, signs of damage and for foreign objects lodged in the tread. Check the tread depth.

Tread depth should not be allowed to go below 1/8 in / 3 mm, even though the legally specified minimum tread depth is 1/16 in / 1.6 mm.

Below 1/8 in / 3 mm tread depth, there is a great risk of hydroplaning, even at relatively moderate speeds and with only small amounts of water on the road. Tread wear indicators in the tread-groove base – see arrow – are distributed around the wheel circumference and are labeled on the tire side-

wall with TWI – Tread Wear Indicator. At a tread depth of 1/16 in / 1.6 mm, the indicators signal that the legally permissible wear limit has been reached.

 Do not drive on a deflated – flat – tire. A flat tire greatly impairs steering and braking response, and can lead to complete loss of control over the vehicle. Avoid overloading the vehicle so that the permitted load on the tires is not exceeded. Overloading can lead to overheating and internal tire damage.

The ultimate result can assume the form of a sudden air loss. Unusual vibrations encountered during normal vehicle operation can indicate a flat tire or some other vehicle malfunction. This type of problem can be caused by contact with curbs, etc. This is also true for irregularities in the vehicle's handling characteristics, such as a pronounced tendency to pull to the left or right. Should this occur, respond by immediately reducing your speed. Pro-

ceed carefully to the nearest BMW center or professional tire center, or have the vehicle towed in to have it, its wheels or its tires inspected.

Tire damage up to and including sudden and complete air loss can endanger the lives of both the vehicle occupants and other road users. ◀

## Tire replacement

To maintain good handling and vehicle response, use only tires of a single tread configuration from a single manufacturer.

### DOT quality grades

Tread wear

Traction AA A B C

Temperature A B C



All passenger car tires must conform to Federal Safety Requirements in addition to these grades. ◀

### Tread wear

The tread wear grade is a comparative rating based on the wear rate of the tire when tested under controlled conditions on a specified government test course.

For example, a tire graded 150 would wear one and one-half –  $1\frac{1}{2}$  – times as well on the government course as a tire graded 100. The relative performance of tires depends upon the actual conditions of their use, however, and may depart significantly from the norm due to variations in driving habits, service practices and differences in road characteristics and climate.

### Traction

The traction grades, from highest to lowest, are AA, A, B, and C.

Those grades represent the tire's ability to stop on wet pavement as measured under controlled conditions on specified government test surfaces of asphalt and concrete. A tire marked C may have poor traction.



The traction grade assigned to this tire is based on straight-ahead braking traction tests, and does not include acceleration, cornering, hydroplaning, or peak traction characteristics. ◀

### Temperature

The temperature grades are A – the highest – B, and C, representing the tire's resistance to the generation of heat and its ability to dissipate heat when tested under controlled conditions on a specified indoor laboratory test wheel.

Sustained high temperature can cause the material of the tire to degenerate and reduce tire life, and excessive temperature can lead to sudden tire failure. The grade C corresponds to a level of performance which all passenger car

# Tire replacement

tires must meet under the Federal Motor Vehicle Safety Standard No. 109. Grades B and A represent higher levels of performance on the laboratory test wheel than the minimum required by law.



The temperature grade for this tire is established for a tire that is properly inflated and not overloaded. Excessive speed, underinflation, or excessive loading, either separately or in combination, can cause heat buildup and possible tire failure. ◀

## Uniform Tire Quality Grading

Quality grades can be found where applicable on the tire sidewall between tread shoulder and maximum section width. For example:

Tread wear 200

Traction AA

Temperature A



BMW advises against using retreaded tires, since driving safety may be impaired. This is due to the possible variations in casing structures and, in some cases, to their extreme age, which can lead to a decrease in their durability. ◀

## Tire age

The date on which the tire was manufactured is indicated by the code on the sidewall:

DOT... 3502 indicates that the tire was manufactured in week 35 of the year 2002.

BMW recommends the replacement of all tires – including the spare tire\* – when the tires are no more than 6 years old, even if a tire life of 10 years is possible.

## Run Flat tires\*

Run Flat tires consist of self-supporting tires and special rims. The tire reinforcement ensures that the tire retains some residual safety in the event of pressure drop and driving remains possible to a restricted degree. The vehicle is equipped with a Tire Pressure Monitor (TPM) or Flat Tire Monitor, which indicate a flat tire.

For additional information on the Tire Pressure Monitor (TPM) or Flat Tire Monitor, refer to page [85](#) or [86](#).



Run Flat tires are only possible in conjunction with the Tire Pressure Monitor (TPM) or Flat Tire Monitor. ◀

**The right choice**

 BMW recommends using only wheels and tires that have been approved by BMW for use on your particular model. Although other wheels and tires may theoretically have the same dimensions, variations in factors such as manufacturing tolerances can result in contact between tire and bodywork, ultimately leading to serious accidents. BMW cannot evaluate all tires and wheels on the market, and is thus unable to guarantee that the vehicle will continue to perform safely if unapproved tires and/or wheels are mounted. ◀

For each tire size, BMW has assessed the safe performance of specific tire brands and approved them for use. Consult any BMW center for details. Comply with any local/national regulations, for example by recording the tire type in the vehicle documents.



The correct wheel-tire combination affects various systems such as ABS, ASC+T/DSC and ADB/ADB-X/DBC. The function of these systems is impaired if improper wheel-tire combinations are used. For this reason, use only tires of the same manufacture and tread configuration. In the event of a flat tire, for example, remount the approved wheel and tire combination as soon as possible. ◀

**Storage**

Store tires in a cool, dry place, protecting them against light whenever possible. Protect the tires against contact with oil, grease and fuel.

**Winter tires****Choosing the right tire**

BMW recommends winter tires – M+S tires – for operation under inclement winter driving conditions. While all-season tires – M+S designation – provide better winter traction than the corresponding summer tires, they generally do not achieve the performance of winter tires.

In the interest of safe tracking and steering response, install winter tires made by the same manufacturer and having the same tread configuration on all four wheels.



Never exceed the maximum speed for which the winter tires are rated.

Unprofessional attempts by laymen to service tires can lead to damage and accidents.

Have this work performed by trained professionals only. Any BMW center has the required technical knowledge and the proper equipment and will be happy to assist you. ◀



## Winter tires

### Tire condition, tire pressure

At tread depths below approx. 3/16 in / 4 mm, winter tires display a perceptible decrease in their ability to cope with winter driving conditions, and should be replaced in the interest of safety.

Comply with the specified tire inflation pressures – and be sure to have the wheel and tire assembly balanced every time you change a tire or wheel.

You cannot mount snow chains on the following tires:

225/50 R 16

225/45 R 17

225/40 R 18

245/40 R 17

255/35 R 18

### Snow chains\*

Only certain snow chains have been tested by BMW and determined and approved as roadworthy. Consult any BMW center for details. BMW recommends using only these approved fine-link snow chains. Use them in pairs on either summer or winter tires, but only on both rear wheels.

BMW 325xi, 330xi: only in an emergency – for instance, with the vehicle stuck on one side, or when obstructions make it impossible to reach one tire – a chain may also be mounted on just one tire for the limited period needed to resolve the problem.

Comply with all manufacturer's safety precautions when mounting the chains. Do not exceed a speed of 30 mph / 50 km/h when using snow chains.

**To release**

Pull the lever located under the left-hand side of the instrument panel.

 Do not attempt to service your vehicle if you do not have the required technical background. Failure to work in an informed, professional manner when servicing components and materials constitutes a safety hazard for vehicle occupants and other road users. If you are not familiar with the guidelines, please have the operations performed by your BMW center. ◀

**To open**

Pull the release handle and open the hood.

**To close**

Allow the hood to fall from a height of about 1 ft/30 cm so that it audibly engages.

 To avoid injuries, be sure that the travel path of the hood is clear when it is closed, following the same safety precautions used in all closing procedures. If you notice while driving that the hood is not completely closed, stop immediately and close it securely. ◀



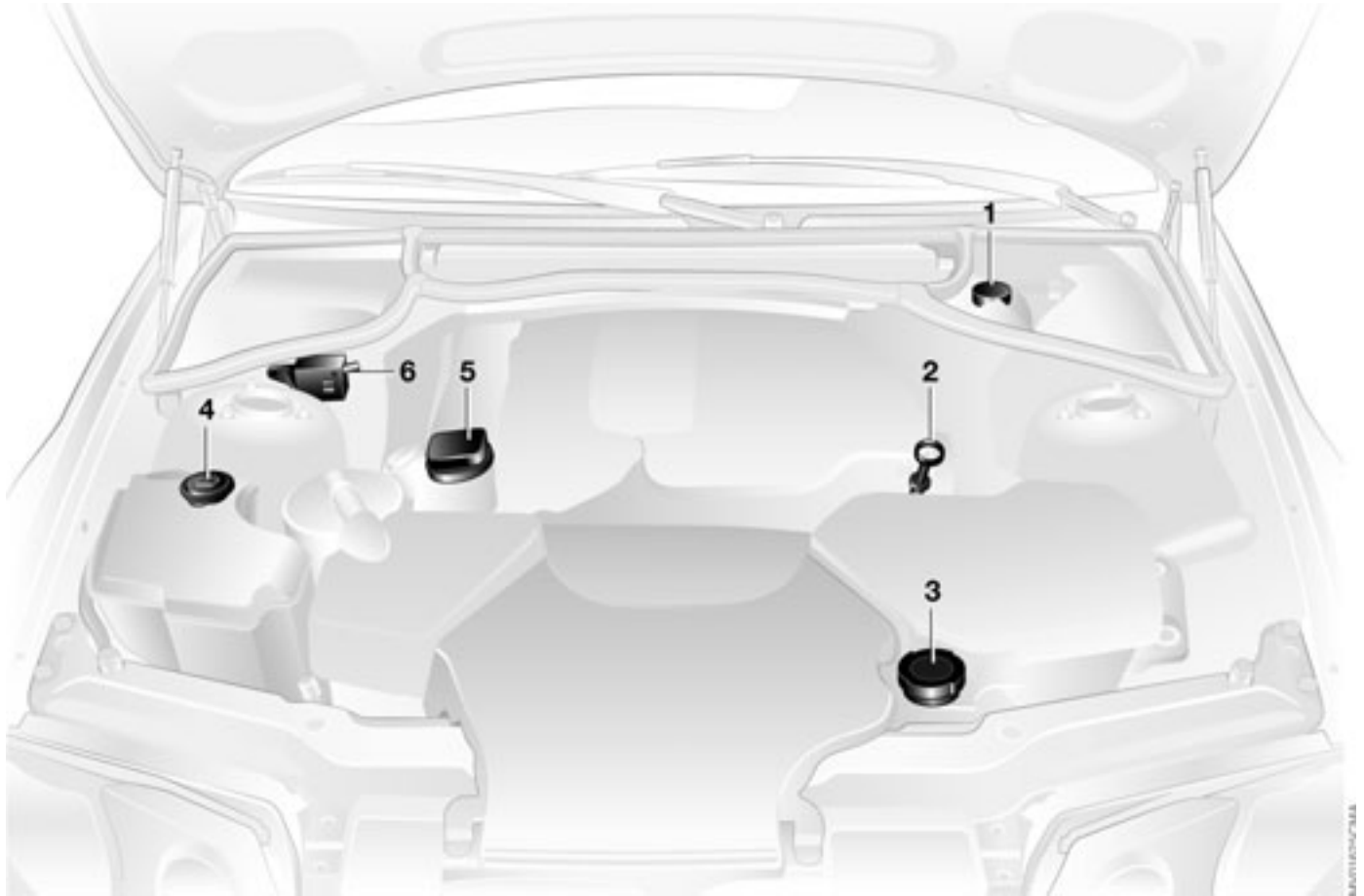

- 1 Brake fluid reservoir [129](#)
- 2 Engine oil dipstick [126](#)
- 3 Coolant expansion tank [128](#)
- 4 Reservoir for the headlamp and windshield washer system [126](#)
- 5 Engine oil filler neck [127](#)
- 6 Auxiliary terminal for jump-starting [147](#)



### Headlamp\* and windshield washer system

Capacity approx.  
5.6 US quarts/5.3 liters

Fill with water and – if required – with a washer antifreeze additive according to manufacturer's recommendations.



We recommend that you mix the washer fluid before adding it to the reservoir. ◀



Antifreeze agents for the washer fluid are highly flammable. For this reason, keep them away from sources of flame and store only in original containers. Store them inaccessible to children. Comply with the instructions on the containers. ◀

### Engine oil

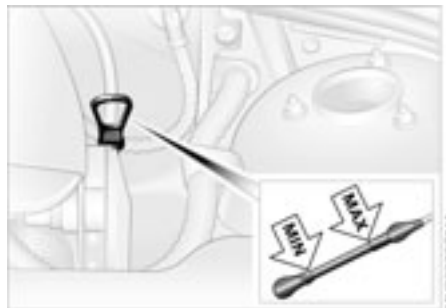

The oil volume between the two marks on the dipstick corresponds to approx. 1.1 US quarts/1 liter. Do not fill beyond the upper mark on the dipstick. Excess oil will damage the engine.

### Checking the oil level

1. Park the vehicle on a level surface
2. Switch the engine off after it has reached normal operating temperature
3. After approx. 5 minutes, pull the dipstick out and wipe it off with a clean lint-free cloth, paper towel, or similar material
4. Carefully push the dipstick all the way into the guide tube and pull it out again
5. The oil level should be between the two marks on the dipstick.

As with fuel economy, oil consumption is directly influenced by your driving style and vehicle operating conditions.

# Engine oil

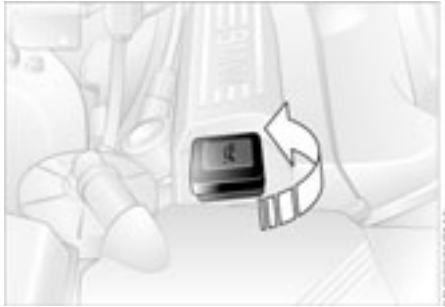



## Adding engine oil

Wait until the level has dropped to just above the lower mark before adding oil. However, you should never let the oil drop below the lower mark.

 BMW engines are designed to operate without oil additives; the use of additives could lead to damage in some cases. This also applies to the manual transmission, the automatic transmission, the differential, and the power steering system. ◀

Recommendation: have the oil changed at your BMW center.

 Continuous exposure to used oil has caused cancer in laboratory testing. For this reason, any skin areas that come into contact with oil should be thoroughly washed with soap and water. Always store oil, grease, etc., out of reach of children. Comply with all warning labels and information on lubricant containers. ◀

 Comply with the applicable environmental laws regulating the disposal of used oil. ◀

## Specified engine oils

The quality of the engine oil is extremely important for the operation and service life of an engine. Based on extensive testing, BMW has approved only certain grades of engine oil.

Use only approved BMW High Performance Synthetic Oil.

If an approved BMW High Performance Synthetic Oil should be unavailable, you may use small volumes of other synthetic oils for topping up between oil changes. Use only oils with the specification API SH or higher.

 Ask your BMW center for details concerning the specific BMW High Performance Synthetic Oil or synthetic oils that have been approved. ◀

You can also call BMW of North America toll-free at 1-800-831-1117 or visit this website: [www.bmwusa.com](http://www.bmwusa.com) to obtain this information.

## Viscosity ratings

Viscosity is the oilflow rating as established in SAE classes.

The selection of the correct SAE class depends on the climatic conditions in the area where you drive your BMW.

 Approved oils are in SAE classes 5W-40 and 5W-30. ◀

These kinds of oil may be used for driving in all ambient temperatures.

 Do not add coolant to the cooling system when the engine is hot. If you attempt to do so, escaping coolant can cause burns.

Antifreeze and anti-corrosion agents are hazardous to health. You should always store them in original containers and in a location which is out of reach of children. Antifreeze and anti-corrosion agents are inflammable. For this reason, do not spill them on hot engine parts. They could ignite and cause serious burns. Comply with the instructions on the containers. ◀



### **Checking the coolant level and adding coolant**

Check the coolant level when the engine is cold, approx. 68 °F / +20 °C.

1. Open the cap for the expansion tank by turning it slightly counterclockwise to allow accumulated pressure to escape, then open
2. The coolant level is correct when the upper end of the red float is at least even with the upper edge of the filler neck; see arrow. The end of the float may stick out by a maximum of 3/4 in / 2 cm – that is, up to the second mark on the float
3. If necessary, add coolant. If the coolant is low, slowly add coolant until the correct level is reached – do not overfill.

 Comply with the applicable environmental laws regulating the disposal of antifreeze agents with corrosion inhibitor. ◀



## Brake fluid



### Indicator lamp



The brake warning lamp comes on when the parking brake is not engaged: the brake fluid level is too low, refer to page 18.



Parking brake warning lamp for Canadian models.

### Adding brake fluid

For adding brake fluid or for determining and correcting the cause of brake fluid loss, consult your BMW center. Your BMW center is familiar with the specifications for factory-approved brake fluids – DOT 4.

Brake fluid loss results in extended pedal travel. Refer to the information on page 116.



Brake fluid is hygroscopic, that is, it absorbs moisture from the air over time.

In order to ensure the brake system's safety and reliability, have the brake fluid changed every two years by a BMW center. Refer to the Service and Warranty Information Booklet for US models or the Warranty and Service Guide Booklet for Canadian models. Brake fluid is toxic and damages the vehicle's paint. You should always store them in original containers and in a location which is out of reach of children.

Do not spill the brake fluid and do not fill the brake fluid reservoir beyond the MAX mark. The brake fluid could ignite upon contact with hot engine parts and cause serious burns. ◀



Comply with the applicable environmental laws regulating the disposal of brake fluid. ◀



The BMW Maintenance System has been designed as a reliable means of providing maximum driving and operating safety – and as cost-effectively as possible for you.

Please keep in mind that regular maintenance is not only necessary for the safety of your vehicle, but also plays a significant role in maintaining the resale value of the vehicle.

### **Service interval display**

While conventional systems rely on mileage alone to determine when service is due, the BMW Maintenance System reflects the actual conditions under which the vehicle is operated: some miles are more strenuous than others.

From a maintenance point of view, 62,000 miles/100,000 km accumulated in short-distance urban driving are not the equivalent of the same distance covered at moderate cruising speeds in long-distance highway travel.

The BMW Maintenance System includes the Engine Oil Service and Inspections I and II.

This service strategy accurately reflects your own vehicle's specific needs by defining maintenance intervals according to individual operating conditions. Minimal use drivers – significantly fewer than 6,200 miles/10,000 km annually – should have the engine oil changed at least every 2 years since oil deteriorates over time, regardless of use.

### **Service and Warranty Information Booklet for US models/ Warranty and Service Guide Booklet for Canadian models**

For additional information on required maintenance intervals and procedures, please refer to the Service and Warranty Information Booklet for US models, or the Warranty and Service Guide Booklet for Canadian models.

As a precaution against corrosion, if your vehicle is exposed to potential damage from unimproved road surfaces we suggest that you have the body checked for damage from stone chips and gravel at the same time.

 Have your BMW center perform maintenance and repair.

Be sure that all maintenance work is recorded in the Service and Warranty Information Booklet for US models, or in the Warranty and Service Guide Booklet for Canadian models. These entries confirm that your vehicle has benefitted from regular maintenance, and are also required for warranty claims. ◀

### **Care**

You can find everything you need to know on this topic by consulting the separate Caring for your vehicle brochure.

## California Proposition 65 warning

California laws require us to state the following warning:

 Engine exhaust, some of its constituents, and certain vehicle components contain or emit chemicals known to the State of California to cause cancer and birth defects and reproductive harm. In addition, certain fluids contained in vehicles and certain products of component wear contain or emit chemicals known to the State of California to cause cancer and birth defects or other reproductive harm. Battery posts, terminals and related accessories contain lead and lead compounds. Wash your hands after handling.

Used engine oil contains chemicals that have caused cancer in laboratory animals. Always protect your skin by washing thoroughly with soap and water. ◀

## OBD interface socket 131



The interface socket for onboard diagnostics is located on the left-hand side of the driver's side, behind a specially marked cover located beneath the instrument panel. The cover has the letters OBD on it.

This interface makes it possible to access data on emissions-related components using special equipment.

 An illuminated indicator informs you of the need for service, not that you need to stop the vehicle. However, the systems should be checked by your BMW center at the earliest possible opportunity.

If the indicator blinks or flashes, this indicates a high level of engine misfire. Reduce speed and contact the nearest BMW center immediately. Severe

## 132 **OBD interface socket**

engine misfiring for even a short period of time can seriously damage emission control system components, especially the catalytic converter.



SERVICE ENGINE SOON warning lamp for Canadian models.



If the fuel filler cap is not on tight enough, the OBD system can detect leaking vapor and the indicator will light up. If the fuel filler cap is then tightened, the indicator will usually go out after a short period of time. ◀







Overview

Controls and features

Operation, maintenance

**Owner service procedures**

Technical data

Index

Overview

Controls

Maintenance

Repairs

Data

Index

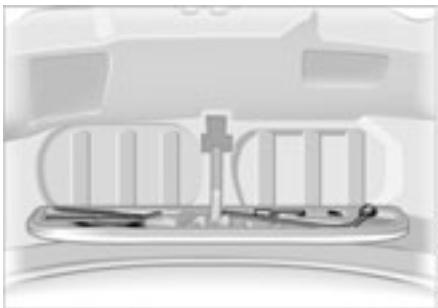

The onboard tool kit is located in the luggage compartment lid.

Loosen the wingnut to open.



1. Switch off the engine
2. Fold the wiper arm completely out from the windshield
3. Position the wiper blade at an angle and pull the release spring – see arrow
4. Fold the wiper blade down and unhook it toward the windshield
5. Pull the wiper blade past the wiper arm toward the top
6. Insert a new wiper blade and apply pressure until you hear it engage.



## Lamps and bulbs

The lamps and bulbs make essential contributions to the safety of your vehicle. Therefore, comply fully with the following instructions during bulb replacement. If you are not familiar with any of the procedures, consult your BMW center.

 Do not touch the glass portion of a new bulb with your bare hands since even small amounts of impurities burn in to the surface and reduce the service life of the bulb. Use a clean cloth, paper napkin, or a similar material, or hold the bulb by its metallic base. ◀

A replacement bulb set is available from your BMW center.

 Before working on the electrical system, switch off the electrical accessory you are working on or disconnect the cable from the negative terminal of the battery. Failure to observe this precaution could result in short circuits. To prevent injuries and damage, comply with any instructions provided by the bulb manufacturer. ◀

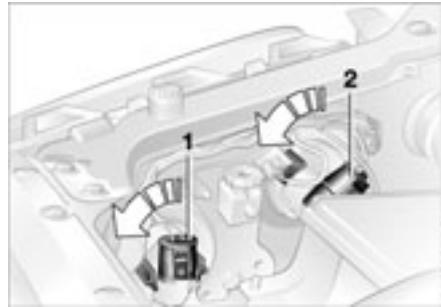

### Low beams and high beams

Engine compartment, left side:

- 1 Low beams
  - 2 High beams
- H7 bulb, 55 watts

 The H7 bulb is pressurized. Therefore, wear safety glasses and protective gloves. Failure to comply with this precaution could lead to injury if the bulb is damaged. ◀

1. Turn the two release catches at the front to the left – see arrow – to remove the bulb holder
2. Remove and replace the bulb.

 When cleaning the headlamps, please follow the instructions in the Caring for your vehicle brochure. ◀

### Xenon lamps\*

The service life of these bulbs is very long and the probability of a failure is very low, provided that they are not switched on and off an unusual number of times. If one of these bulbs should nevertheless fail, it is possible to continue driving with great caution using the fog lamps, provided local traffic laws do not prohibit this.

 Because of the extremely high voltages involved, any work on the xenon lighting system, including bulb-changing, should be carried out by technically-qualified personnel only. Otherwise, there is a risk of fatal injury. ◀

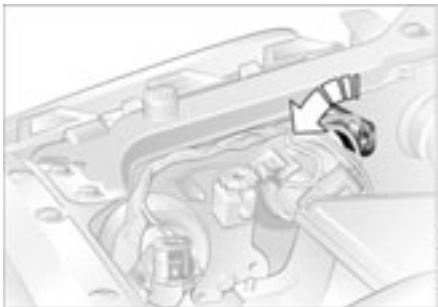

### **Parking lamps**

5 watt bulb

Engine compartment, left side:

1. Turn the bulb holder to the left – see arrow – and remove
2. Remove and replace the bulb.



### **Front turn signal indicators**

21 watt bulb

1. Extend a screwdriver through the upper opening and loosen the screw, continuing until you can extract the bulb by removing it from the front
2. Disconnect the plug
3. Apply gentle pressure and turn the bulb toward the letters AUF – refer to the marking on the housing – then remove it for replacement
4. Connect the plug



5. Align the lamp assembly's two ridges and the centering pin with the guides on the vehicle when installing
6. Slide in the lamp, applying gentle pressure to seat it firmly
7. Tighten the screw.



## Side turn signal indicators

5 watt bulb

1. Use finger pressure against the rear end of the lamp – see arrow – to press it forward for removal
2. Apply gentle pressure to the bulb while turning it to the left to remove.

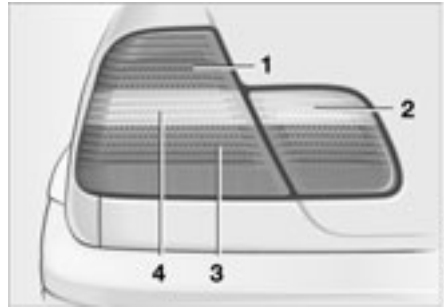

## Tail lamps

- 1 Brake lamp
  - 2 Backup lamp
  - 3 Tail lamp
  - 4 Turn signal indicator
- Bulbs: 21 watt

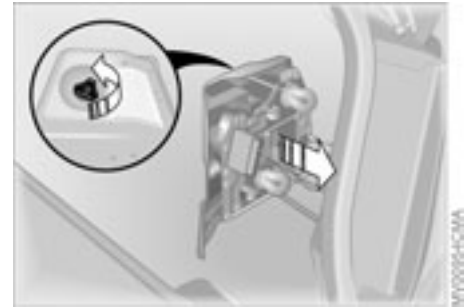

Right-hand luggage compartment opening:

Bulbs in the fender:

All of the bulbs are integrated in a central bulb holder.

1. Unscrew the bulb holder – see arrow in close-up view – to remove
2. Unplug the power supply plug. Set the bulb holder aside – on the luggage compartment floor, for example
3. Applying light pressure, turn the bulb to the left. Remove and replace the bulb
4. Plug in the power supply fitting
5. Screw the bulb holder back on – see arrow in close-up view.



Bulbs in the luggage compartment lid:  
1. Use a screwdriver to release the two clips

2. Swing trim panel down – see arrow 1. Release the bulb holder – see arrow 2 – and remove it
3. Applying light pressure, turn the bulb to the left. Remove and replace the bulb
4. Press the bulb holder into place, continuing until you hear it engage
5. Reinstall the trim panel with the clips.

**Center high-mount brake lamp**

LED strip on the rear window.

Please contact your BMW center in case of malfunction.



### License plate lamps

5 watt bulb

1. Place a screwdriver in the slot and press toward the left – see arrow – to release the lens
2. Replace the bulb.

 Safety precautions in the event of a flat tire or wheel change:  
Stop the vehicle as far as possible from passing traffic. Park on a firm, flat, surface. Switch on the hazard warning flashers. Turn the steering wheel to the straight-ahead position and engage the

steering lock. Shift into 1st or Reverse, or if you have an automatic transmission, position the selector lever in Park, and engage the parking brake.

All passengers should be outside the vehicle and well away from your immediate working area, behind a guardrail, for example.

If a warning triangle or portable hazard warning lamp is available, set it up on the roadside at an appropriate distance from the rear of the vehicle. Comply with all safety guidelines and regulations.

Change the wheel only on a level, firm surface which is not slippery. Avoid jacking the vehicle on a soft or slippery support surface – snow, ice, loose gravel, etc. – as either the vehicle or the jack could slip sideways.

Position the jack on a firm support surface.

Do not place wooden blocks or similar objects under the jack. They could prevent the jack from extending to its full height and reduce its support capacity. Do not lie under the vehicle or start the engine when the vehicle is supported by the jack. There is otherwise a risk of fatal injury. ◀

## 142 Changing a wheel

Your BMW is equipped with a spare tire or a space-saver spare tire designed for temporary use in maintaining the vehicle's mobility in an emergency.

 To remove the spare tire, lift the floor panel in the luggage compartment completely out, refer to page 37. ◀

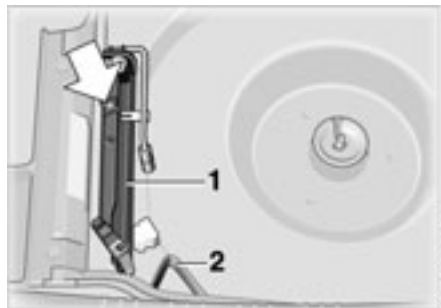

### What you will need

In order to avoid rattling noises later, note the position of the tools when you remove them and return them to their original position when you are done using them.

#### ▷ Jack 1

Lift the floor panel within the luggage compartment, refer to page 37, and undo the red wingnut – see arrow. When you have completed work, screw the jack all the way back down. Fold the handle back and insert it in its holder

#### ▷ Chock 2

Located behind the jack on the wall in the luggage compartment. Loosen the wing nut to remove it

- ▷ Spare tire or space-saver spare tire – located next to the jack
- Loosen the wing nut – see arrow – by hand, remove the storage shelf and take the wheel out
- ▷ Lug wrench – in the onboard tool kit on the underside of the luggage compartment lid, refer to page 136.

### Procedure

1. Read and comply with the safety precautions provided on the previous page
2. Secure the vehicle to prevent it from rolling:  
Place the wedge against the rear surface of the front tire on the side opposite the side being raised. If the vehicle is parked on a downward slope, place the wedge

securely in front of the tire. If the wheel must be changed on a surface with a more severe slope, take additional precautions to secure the vehicle from rolling

3. Wheels with full wheel covers\*: Reach into the ventilation openings and pull the cover off
4. Loosen the lug bolts by rotating half a turn

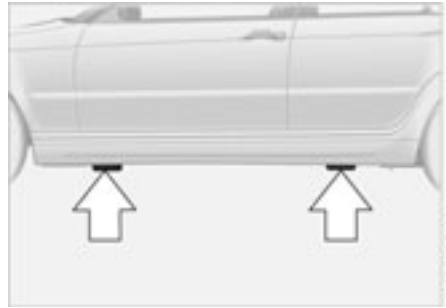



5. Position the jack at the jacking point closest to the flat tire – see arrows – with the jack base vertically below the jacking point and the entire surface of the head of the jack moves into the right-hand corner of the square recess of the jacking point – refer to the detail in the next illustration – when the jack is cranked
6. Jack the vehicle up until the wheel you are changing is raised from the ground
7. Unscrew the lug bolts and remove the wheel
8. Remove accumulations of mud or dirt from the mounting surfaces of the wheel and hub. Clean the lug bolts
9. Position the new wheel or the space saver spare tire on the hub and screw at least two lug bolts finger-tight into opposite bolt holes
10. Screw in the remaining lug bolts. Screw in all the bolts in a diagonal pattern
11. Lower the jack and remove it from beneath the vehicle
12. Tighten the lug bolts securely in a diagonal pattern



13. Wheels with full wheel covers\*: place the wheel cover with the valve opening – see arrow – over the valve. Use both hands to press the cover securely onto the rim
14. Check and correct the tire inflation pressure at the earliest opportunity. Vehicles with Tire Pressure Monitor (TPM)/Flat Tire Monitor: after mounting the spare tire or correcting the tire inflation pressure, reinitialize the system, refer to pages 85 and 86.

Protect valve stems and valves from dirt using screw-on valve stem caps. Dirty valve stems frequently lead to slow pressure loss.

 Do not attempt to install the full wheel cover on the space-saver spare tire, since this could damage the cover. ◀

 The vehicle jack is designed for changing wheels only. Do not attempt to raise another vehicle model with it or to raise any other type of load. To do so could cause accidents and personal injury. To ensure continued safety, have the tightness of the torque bolts checked with a calibrated lug wrench – torque specification: 88.5 lb ft/120 Nm – at the earliest opportunity. ◀

When storing a wheel in the spare tire recess, take care to avoid bending the threaded rod.

If light-alloy wheels other than original BMW light-alloy wheels have been mounted, it may be necessary to use different lug bolts for those wheels.

Replace the defective tire as soon as possible and have the new wheel/tire balanced.

### **Driving with the space-saver spare tire**

Drive cautiously. Do not exceed a speed of 50 mph / 80 km/h.

Be aware that vehicle handling may be altered. Anticipate, e.g., reduced tracking during braking, longer braking distances, and changed steering characteristics when approaching limit conditions. These handling characteristics will be even more pronounced if winter tires are mounted.

 Only one space-saver spare tire may be mounted at one time. Mount a wheel and tire of the original size at the earliest possible opportunity. ◀

### **Driving with a spare tire\***

 For certain wheel/tire combinations, the size of the spare tire will differ from that of the remaining tires. The spare tire is fully functional at all loads and speeds. However, the spare tire should be replaced at the earliest possible opportunity in order to achieve the original operating conditions. ◀



## Run Flat tires\*



Run Flat tires are labeled on the sidewall with a circular symbol containing the letters RSC. Run Flat tires consist of self-supporting tires and special rims. The tire reinforcement ensures that the tire retains some residual safety in the event of pressure drop and driving remains possible to a restricted degree. The vehicle is equipped with Tire Pressure Monitor (TPM) or Flat Tire Monitor, which indicate a flat tire.

▶ Because the sides of Run Flat tires are reinforced, a drop in inflation pressure usually cannot be detected on the outside. ◀

### Flat tire

If there is a tire failure, the red warning lamp symbol lights up. This visual alert is accompanied by an acoustic warning signal.

Additional information on the Tire Pressure Monitor (TPM) or Flat Tire Monitor is found beginning on page 85.

Reduce vehicle speed carefully to under 50 mph / 80 km/h, avoiding hard brake applications and steering maneuvers.

If the defective wheel is not immediately recognizable on the outside, check the tire pressure on all four wheels.

⚠ Have Run Flat tires replaced by your BMW center. In the interest of safety, Run Flat tires should not be repaired. Your BMW center has the information needed for working with Run Flat tires and is equipped with the necessary special tools. ◀

▶ If appropriate, please consult your BMW center to reequip your vehicle from summer to winter tires – or vice versa. ◀

### Driving with a damaged tire

Run Flat tires allow you to continue driving to a restricted degree at a maximum speed of 50 mph / 80 km/h depending on the cargo load and the extent of tire damage. You can determine the distance you may continue driving on the basis of the following values:

- ▶ Tire inflation pressure of 0 psi/0 kilopascal (kPa): approx. 100 miles/150 km
- ▶ Tire inflation pressure of approx. 7-15 psi/50-100 kPa: approx. 300 miles/500 km
- ▶ Tire inflation pressure greater than 15 psi/100 kPa: approx. 600 miles/1,000 km.

⚠ Drive cautiously. Do not exceed a speed of 50 mph / 80 km/h. Be aware that vehicle handling will be altered when there is a loss in inflation pressure. Anticipate, e.g., reduced tracking during braking, longer braking distances, and changed steering characteristics. ◀

**Maintenance**

The battery is maintenance-free, that is, the original electrolyte will normally last for the service life of the battery under moderate climatic conditions.

 Please consult your BMW center whenever you have any questions concerning the battery. The battery is completely maintenance-free; the following section is provided for your information only. ◀

 Never disconnect the battery when the engine is running; the ensuing voltage surge would seriously damage the vehicle's onboard electronic systems. ◀

**Charging the battery**

When charging the battery in the vehicle, leave the engine off at all times. Connect the charge cables to the terminals in the engine compartment. For terminal locations, refer to Jump-starting on page 147.

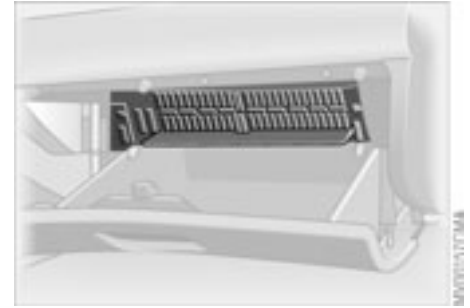

Return used batteries to a recycling point or your BMW center. Maintain the battery in an upright position for transport and storage. Secure the battery against tilting during transport. ◀

**Fuses**

You will find the fuses and information on their respective allocation in the glove compartment behind a panel with two snap clips.

 Do not attempt to repair a blown fuse or replace it with a fuse having a different color or amperage rating. To do this could cause a fire in the vehicle resulting from a circuit overload. ◀

## Jump-starting

When your battery is discharged you can use two jumper cables to start your vehicle with power from the battery in a second vehicle. You can also use the same method to help start another vehicle. Only use jumper cables with fully insulated handles on the terminal clamps.

 Do not touch high-voltage wiring and cables on a running engine. Contact with components carrying high voltage can be harmful or fatal. Carefully observe the following instructions to avoid personal injury and/or damage to one or both vehicles. ◀

1. The battery in the support vehicle must also be rated at 12 volts. This information is provided on the battery label
2. Stop the engine of the support vehicle and switch off all electrical components in both vehicles – except for the hazard warning flashers of the support vehicle
3. Make absolutely certain that there is no contact between the bodywork of the two vehicles – short circuit hazard



4. The auxiliary jump-starting terminal located in your BMW's engine compartment acts as the positive battery terminal. The cover of this auxiliary terminal is marked with a + sign. Remove by pulling the tab – see arrow 1. Start by connecting the jumper cable from the positive terminal of the discharged battery to the positive terminal of the support battery
5. Then connect the negative terminals with the other jumper cable. First connect one end to the negative battery terminal or to a suitable ground on

the support vehicle. Then connect the other end to the negative battery terminal or a suitable ground on the vehicle being started. Your BMW is equipped with a special nut for this purpose – see arrow 2

 Always adhere to this sequence when connecting jumper cables; failure to observe this procedure can lead to sparks at the battery terminals and pose an injury hazard. ◀

6. Start the engine of the support vehicle and let it run for several minutes at a slightly elevated engine idle speed
7. Start the engine of the other vehicle as usual. If the first start attempt is not successful, wait a few minutes before another attempt in order to allow the discharged battery to recharge
8. Before disconnecting the jumper cables, let the engines run for a few minutes
9. Then disconnect the jumper cables in reverse sequence.

Depending on the cause of the fault, have the battery checked and recharged by your BMW center.



Do not use spray starter fluids to start the engine. ◀

## **Towing the vehicle**

### **Towing eyelet**

The screw-in towing eyelet is stored in the onboard tool kit; be sure that it remains in the vehicle at all times. It is designed for installation in the tow sockets located at the front and rear of the vehicle, and is intended for towing on paved road surfaces only. The towing eyelet should not be used to pull a vehicle out of deep snow, mud, sand, etc.

Always comply with all applicable towing laws and regulations.



### **Access to tow sockets**

Front:

Press out the cover panel with a screwdriver inserted in the recess at the top.

## Towing the vehicle



Rear:

Press out the cover panel with a screwdriver inserted in the recess at the top.

 Make sure the towing eyelet is firmly screwed all the way in, otherwise the thread could be damaged. Never attach tie-down hooks, chains, straps, or tow hooks to tie rods, control arms, or any other part of the vehicle suspension, as severe damage to these components will occur, possibly leading to accidents. ◀

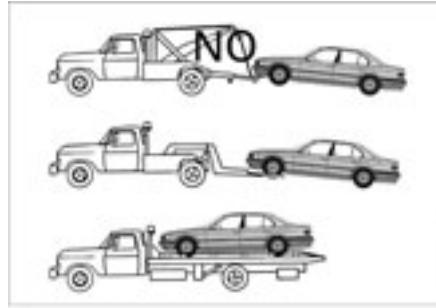

### Towing with a commercial tow truck

- ▷ Do not tow with sling-type equipment
- ▷ Use wheel-lift or flatbed equipment
- ▷ Please comply with applicable state towing laws.

 Never allow passengers to ride in a towed vehicle for any reason. Never attach tie-down hooks, chains, straps, or tow hooks to tie rods, control arms, or any other part of the vehicle suspension, as severe damage to these components will occur, possibly leading to accidents. ◀

### BMW 325xi, 330xi: towing the vehicle with one axle raised

1. Place the transmission in Neutral

2. Switch off the engine
3. Maximum towing speed:  
30 mph / 50 km/h
4. Maximum towing distance:  
95 miles/150 km.

 Remove the rear driveshaft for longer towing distances with the front axle lifted; remove the front driveshaft for towing over longer distances with the rear axle lifted. Failure to comply with this will result in damage to the transfer box. ◀

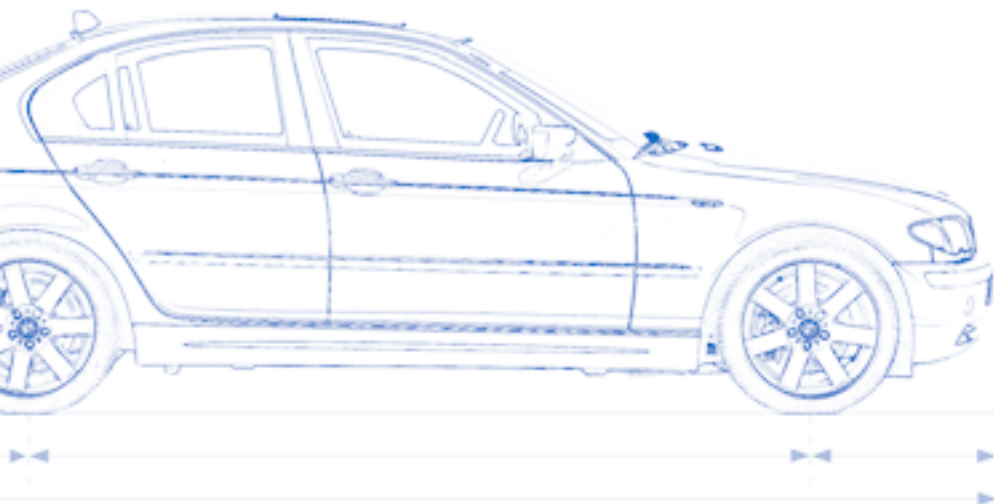

**Overview****Controls and features****Operation, maintenance****Owner service procedures****Technical data****Index**

Overview

Controls

Maintenance

Repairs

Data

Index

## 152 Engine data

		BMW 320i	BMW 325i, 325xi	BMW 330i, 330xi
Displacement	cu in/cm <sup>3</sup>	132.5/2,171	152.2/2,494	181.8/2,979
Number of cylinders		6	6	6
Maximum power output at engine speed	hp/kW rpm	168/124 6,100	184/135 6,000	225/165 5,900
Max. torque at engine speed	lb ft/Nm rpm	155/210 3,500	175/237 3,500	214/290 3,500
Compression ratio	$\epsilon$	10.8	10.5	10.2
Stroke	in/mm	2.83/72	2.95/75	3.53/89.6
Bore	in/mm	3.15/80	3.31/84	3.31/84
Fuel-injection system			Digital electronic engine-management system (DME)	

BMW 325xi, 330xi: power can be tested only on a suitable dynamometer.



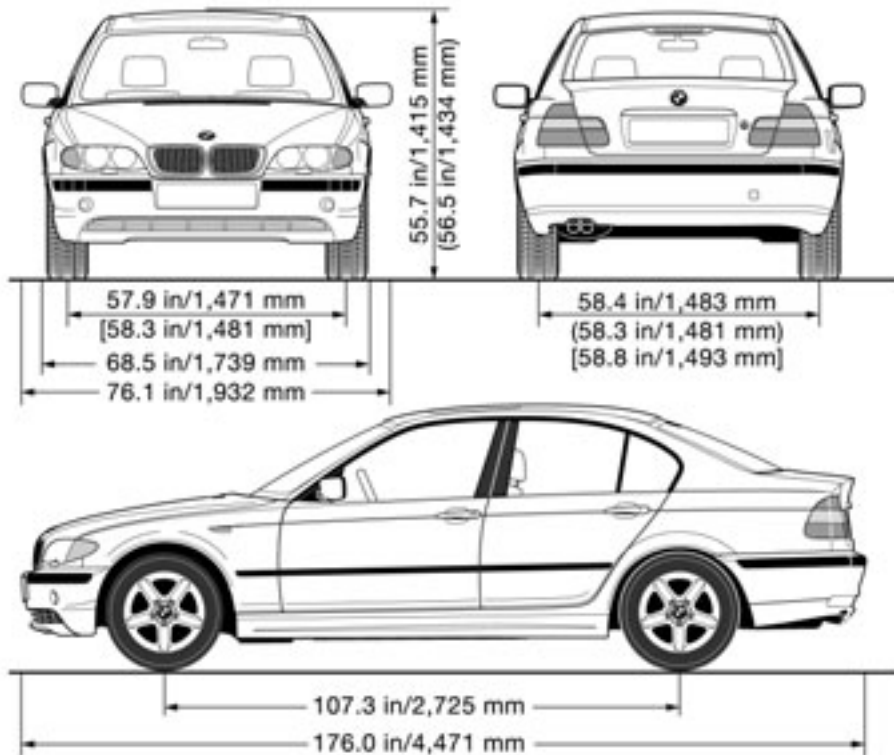

Dimensions in ( ) apply to 325xi/330xi.  
 Dimensions in [ ] apply to 320i.  
 Minimum turning circle dia.: 34.4 feet/10.5 m (35.8 feet/10.9 m).

		BMW 320i	BMW 325i	BMW 325xi	BMW 330i	BMW 330xi
Curb weight						
with manual transmission	lbs/kg	3,142/1,425	3,219/1,460	3,461/1,570	3,285/1,490	3,483/1,580
with automatic transmission	lbs/kg	3,219/1,460	3,307/1,500	3,527/1,600	3,362/1,525	3,538/1,605
Approved gross vehicle weight						
with manual transmission	lbs/kg	4,200/1,905	4,277/1,940	4,520/2,050	4,343/1,970	4,541/2,060
with automatic transmission	lbs/kg	4,277/1,940	4,365/1,980	4,586/2,080	4,420/2,005	4,597/2,085
Approved front axle load	lbs/kg	1,973/895	1,984/900	2,183/990	2,006/910	2,161/980
Approved rear axle load	lbs/kg	2,359/1,070	2,425/1,100	2,469/1,120	2,469/1,120	2,491/1,130
Approved roof load capacity	lbs/kg	165/75	165/75	165/75	165/75	165/75
Luggage compartment capacity	cu ft/l	15.5/440	15.5/440	15.5/440	15.5/440	15.5/440

Never exceed either the approved axle loads or the approved gross vehicle weight.

			Notes
Fuel tank	gal./liters	approx. 16.6/63	Fuel specification, refer to page <a href="#">25</a>
Reserve	gal./liters	approx. 2.1/8	
Windshield/ Headlamp washer reservoir	quarts/liters	approx. 5.6/5.3	Specifications, refer to page <a href="#">126</a>
Cooling system including heater circuit	quarts/liters	approx. 8.9/8.4	Specifications, refer to page <a href="#">128</a>
Engine oil and filter change	quarts/liters	320i, 325i, 330i: approx. 6.9/6.5 325xi, 330xi: approx. 6.6/6.2	BMW High Performance Synthetic Oil Specifications, refer to page <a href="#">126</a>
Manual and automatic transmission, transfer box and differential		–	Lifetime lubricant, no oil change required

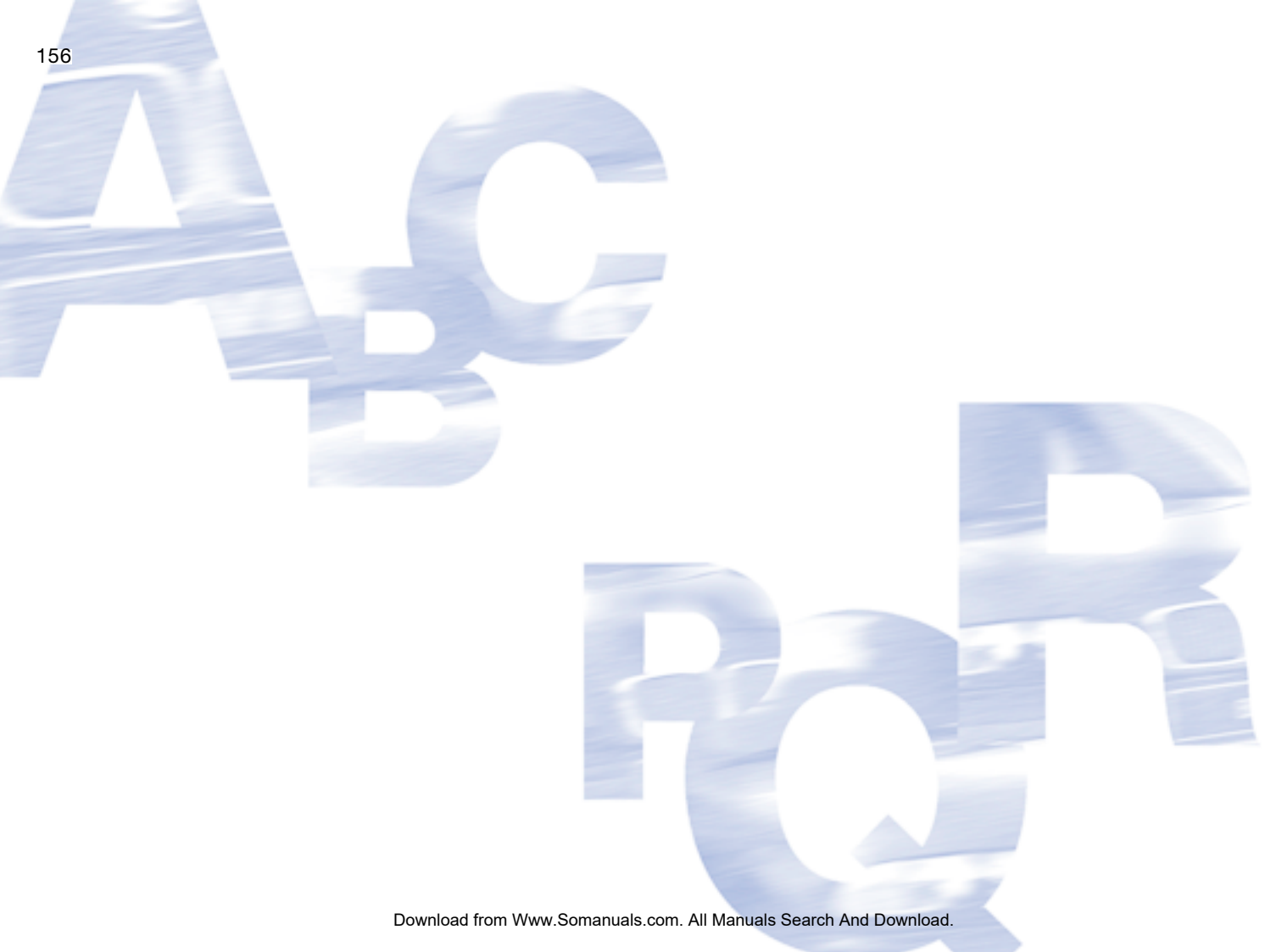



Overview

Controls and features

Operation, maintenance

Owner service procedures

Technical data

Index

Overview

Controls

Maintenance

Repairs

Data

Index

# Everything from A to Z

## A

ABS Antilock Brake System  
18, 115

Accessories 5

Activated-charcoal filter 100

ADB Automatic Differential Braking 78

Adding brake fluid 129

Air conditioning 92, 98

Air distribution 94, 98

Air nozzles 92, 96

Air outlets 92, 96

Air pressure 117  
check 25

Air supply 94, 98

Airbags 19, 53

Alarm system 38

Antifreeze 128

Antilock Brake System (ABS)  
18, 115

Anti-theft system 38

Armrest 102

ASC+T Automatic Stability Control plus Traction 18, 19, 78

Ashtray  
front 104  
rear 105

AUC Automatic recirculated-air control 99

Automatic car wash, refer to the Caring for your vehicle brochure

Automatic climate control 96

Automatic cruise control 69

Automatic Differential Braking (ADB) 78

Automatic dimming, interior rearview mirror 52

Automatic headlamp control 89

Automatic recirculated-air control (AUC) 99

Automatic Stability Control plus Traction (ASC+T) 18, 19, 78

Automatic transmission with Steptronic 19, 64

Average fuel consumption 76

Average speed 76

Avoiding unintentional alarms 39

Axle loads 154

## B

Backrest, adjusting 45

Backup lamps 63  
replacing bulb 139

Battery  
charge 146  
discharged 146

Battery charge current 18

Belts 47

Beverage holder 102, 103

Blower 94, 98

BMW High Performance Synthetic Oils 127

BMW sports seat 45

Bore 152

Bottle holder, see Beverage holder 102

Brake hydraulic system 18

Brake lamps  
replacing bulb 139

Brake pads 19

Brake, parking 62

Brakes  
malfunctions 116

Break-in procedures 114

Bulb, replacing 137

## C

California Proposition 65 warning 131

Can holder, see Beverage holder 102

Capacities 155

Car care, refer to the Caring for your vehicle brochure

Car radio  
refer to the Owner's Manual for Radio

Car telephone  
refer to the separate Owner's Manual

Car vacuum cleaner, connecting 104

Car wash, refer to the Caring for your vehicle brochure

Cargo loading 108

Cassette player operation, refer to the Owner's Manual for Radio

Cassette player operation, see Owner's Manual for Radio

CBC Cornering Brake Control 18, 115

CD player operation, refer to the Owner's Manual for Radio

Cellular phone 104

Center armrest 102

Center high-mount brake lamp 140

Central locking system 30  
button 34

Changing a wheel 141

Charge indicator lamp 18

Check Control 73

Child-restraint mounting system (LATCH) 57

Cigarette lighter 104

Cleaning windshield 69

# Everything from A to Z

Clock [74](#)  
 setting, refer also to the radio or onboard computer Owner's Manual

Cockpit [14](#)

Code, refer to the Owner's Manual for Radio

Coin box [102](#)

Compartments [102](#)

Compression ratio [152](#)

Computer [75](#)

Condensation, removing from windows [95, 98](#)

Consumption [76](#)  
 display [72](#)

Coolant [128, 155](#)

Cooling system [155](#)

Copyright [4](#)

Cornering Brake Control (CBC) [18, 115](#)

Cruise control [69](#)

Cup holder, see Beverage holder [102](#)

Curb weight [154](#)

Cushion height [153](#)

## D

Data  
 dimensions [153](#)  
 engine [152](#)  
 technical [152](#)  
 weights [154](#)

Daytime driving lamps [89](#)

DBC Dynamic Brake Control [115](#)

Defrost position [95, 98](#)

Defrosting  
 rear window [94, 99](#)  
 windows [95, 98](#)

Digital clock [74](#)

Dimensions [153](#)

Dipstick, engine oil [126](#)

Displacement [152](#)

Display lighting [90](#)

Displays [16](#)

Distance warning [77](#)

Divided rear backrest [106](#)

Door key [30](#)

Door lock buttons [34](#)

Doors  
 emergency operation [33](#)  
 unlocking and locking [31](#)

Driving notes [115](#)

DSC Dynamic Stability Control [18, 19, 80](#)

DTC Dynamic Traction Control [80](#)

Dynamic Brake Control (DBC) [115](#)

Dynamic Stability Control (DSC) [18, 19, 80](#)

Dynamic Traction Control (DTC) [80](#)

## E

Electric power windows [40](#)

Electrical accessories, failure [146](#)

Electrical malfunction  
 fuel filler door [24](#)  
 sliding/tilt sunroof [43](#)

Emergency operation  
 doors [33](#)  
 fuel filler door [24](#)  
 sliding/tilt sunroof [43](#)

Emergency release  
 luggage compartment lid [37](#)

Emissions, minimum, refer to Energy control [71](#)

Energy control [71](#)

Engine  
 starting [60](#)  
 switching off [62](#)

Engine compartment [124](#)

Engine coolant [155](#)  
 adding [128](#)  
 temperature gauge [72](#)

Engine data [152](#)

Engine oil  
 adding [126](#)  
 capacity [155](#)  
 consumption [126](#)  
 pressure [18](#)  
 quality [127](#)  
 types [127](#)  
 viscosity [127](#)

Engine oil level [19](#)  
 check [126](#)

Engine speed [152](#)

Environmentally-friendly driving, refer to Energy control [71](#)

Exterior mirrors [11](#)

Eyelet, towing [148](#)

## F

Failure messages [73](#)

False alarm, avoiding [39](#)

Fault displays [73](#)

First-aid kit [23](#)

Flashlight [102](#)

Flat tire [117, 141](#)

Flat Tire Monitor [86](#)

Fog lamps [91](#)

Folding rear backrest [106](#)

Follow me home lamps [89](#)

Front fog lamps [91](#)

Front seat adjustment [44](#)

Frost protection  
 radiator [128](#)

# Everything from A to Z

Fuel consumption [76](#)  
display [72](#)  
Fuel economy, refer to  
Energy control [71](#)  
Fuel filler door [24](#)  
release following an electrical malfunction [24](#)  
Fuel gauge [72](#)  
Fuel specifications [25](#)  
Fuel tank capacity [155](#)  
Fuel tank display [72](#)  
Fuel tank gauge [72](#)  
Fuel-injection system [152](#)  
Fuses, replacing [146](#)

## G

Gasoline [25](#)  
Gasoline gauge [72](#)  
Glove compartment [101](#)  
Grills [92](#), [96](#)  
Gross vehicle weight [154](#)

## H

Hands-free system [104](#)  
Harman Kardon premium sound system [101](#)  
Hazard warning flashers [14](#)  
Hazard warning triangle [23](#)  
HDC Hill Descent Control [84](#)  
Head airbags [53](#)  
Head restraints [47](#)  
Headlamp flasher [90](#)

Headlamp washer system [126](#), [155](#)  
Headlamps [89](#)  
automatic control [89](#)  
Heated seats [50](#)  
Heating and ventilation [96](#)  
Heavy loads [108](#)  
High beams [21](#), [67](#), [90](#)  
replacing bulb [137](#)  
Hill Descent Control (HDC) [84](#)  
Holder for  
beverages [102](#)  
litter bag [103](#)  
Hood release [122](#)  
Horn [14](#)  
Hydraulic brake assistant, see DBC  
Hydroplaning [115](#), [117](#)

## I

Ice warning [75](#)  
Icy roads [75](#)  
Ignition key [30](#)  
Ignition lock [60](#)  
Imprint [4](#)  
Indicator lamps [18](#)  
Inflation pressure [25](#), [117](#)  
monitoring [85](#)  
INSPECTION [73](#)  
Instrument cluster [16](#)  
Instrument lighting [90](#)

Instrument panel [14](#), [16](#)  
Interface socket for onboard diagnostics [131](#)  
Interior lamps [32](#), [91](#)  
remote control [32](#)  
Interior motion sensor [38](#)  
switching off [39](#)  
Interior rearview mirror [52](#)  
automatic dimming feature [52](#)  
Interlock [60](#)  
Intermittent mode [68](#)

## J

Jack [141](#)  
Jump-starting [147](#)

## K

Key Memory [59](#)  
Keys [30](#)  
with remote control [30](#)

## L

Lamp, replacing [137](#)  
Lashing fittings [109](#)  
LATCH child-restraint mounting system [57](#)  
Length [153](#)  
License plate lamp replacing bulb [141](#)  
Light switch [89](#)  
Lighter [104](#)

LIGHTS ON warning [89](#)  
Litter bag holder [103](#)  
Load-securing devices [109](#)  
Lock, steering wheel [60](#)  
Low beams [89](#)  
automatic [89](#)  
replacing bulb [137](#)  
Lug wrench [141](#)  
Luggage compartment [35](#)  
capacity [154](#)  
floor mat [38](#)  
floor panel [37](#)  
lighting [35](#)  
Luggage compartment lid [35](#)  
emergency operation [35](#)  
emergency release [37](#)  
remote control [32](#)  
securing separately [35](#)  
Luggage rack [110](#)  
Lumbar support [46](#)

## M

M+S tires [120](#)  
Maintenance [73](#), [130](#)  
Malfunction displays [73](#)  
Manual transmission [63](#)  
MC operation, refer to the Owner's Manual for Radio  
MD operation, refer to the Owner's Manual for Radio  
Memory [49](#)  
Memory settings [59](#)



# Everything from A to Z

Microfilter [95](#), [100](#)  
 Microphone [104](#)  
 Mirror  
   automatic curb monitor [50](#)  
 Mirror defrosting [51](#)  
 Mirror memory [49](#)  
 Mirrors [51](#)  
 Modifications, technical [5](#)  
 Multifunction switch [67](#)

## N

Navigation system, refer to  
 the separate Owner's  
 Manual  
 Neckrest [47](#)

## O

OBD interface socket [131](#)  
 Obstruction protection [40](#)  
 Odometer [71](#)  
 Oil  
   capacity [155](#)  
   quality [127](#)  
   viscosity [127](#)  
 Oil additives [127](#)

Oil change intervals, refer to  
 the Service and Warranty  
 Information Booklet for US  
 models/Warranty and Ser-  
 vice Guide Booklet for  
 Canadian models  
 Oil consumption [126](#)

Oil dipstick [126](#)  
 Oil filter change [155](#)  
 Oil level  
   checking [126](#)  
   indicator lamp [18](#)  
 Oil pressure  
   indicator lamp [18](#)  
 OIL SERVICE [73](#)  
 Oil types [127](#)  
 Onboard computer, refer to  
 the Owner's Manual for  
   Onboard Computer  
 Onboard tool kit [136](#)  
 Operating elements [14](#)  
 Outlets, ventilation [92](#), [96](#)  
 Outside temperature dis-  
   play [75](#)

## P

Panel lighting [90](#)  
 Panic mode – trigger  
   alarm [32](#)  
 Park Distance Control  
   (PDC) [77](#)  
 Parking aid [77](#)  
 Parking brake [62](#)  
 Parking lamps [89](#)  
   replacing bulb [138](#)  
 PDC Park Distance  
   Control [77](#)  
 Pocket flashlight [102](#)  
 Pollen [95](#), [100](#)

Power output [152](#)  
 Power seat [46](#)  
 Power windows  
   safety switch [41](#)  
 Pressure, tires [25](#), [85](#), [117](#)  
   monitoring [85](#)

## R

Radiator [155](#)  
 Radio, refer to the Owner's  
   Manual for Radio  
 Rain sensor [68](#)  
 Range [76](#)  
 Reading lamps  
   front [91](#)  
   rear [91](#)  
 Rear backrest, folding [106](#)  
 Rear center 3-point safety  
   belt [106](#)  
 Rear lamps [139](#)  
 Rear window defroster  
   [94](#), [99](#)  
 Rearview mirror [51](#)  
 Recirculated-air mode  
   [94](#), [99](#)  
 Reclining seat [44](#)  
 Refueling [24](#)  
 Remote control [31](#)  
 Remote control keys [30](#)  
 Replacement key [30](#)  
 Reporting safety defects [6](#)  
 Reserve indicator lamp [72](#)

Reverse [63](#)  
 Roller sun blind [100](#)  
 Roof load capacity [154](#)  
 Roof-mounted luggage  
   rack [110](#)  
 Run Flat tires [119](#), [145](#)

## S

Safe seating position [44](#)  
 Safety belt height adjust-  
   ment [48](#)  
 Safety feature [40](#)  
 Seat adjustment [44](#)  
   mechanical [45](#)  
   power [46](#)  
 Seat heating [50](#)  
 Seat memory [49](#)  
 Securing cargo [109](#)  
 Securing devices [109](#)  
 Selector lever, automatic  
   transmission [64](#)  
 Service and Warranty Infor-  
   mation Booklet [130](#)  
 Service interval display  
   [73](#), [130](#)  
 Shiftlock [64](#)  
 Side airbags [53](#)  
 Size [153](#)  
 Ski bag [107](#)

# Everything from A to Z

Sliding/tilt sunroof 41  
  closing following an electrical malfunction 43  
  convenience operation 31  
  remote control 32

Snow chains 121

Socket 104

Spare key 30

Spare tire 141

Speedometer 16

Sports seat 45

Standing lamps 90

Starting problems 60

Starting the engine 60

Steering wheel lock 60

Steering wheel with multi-function buttons 22

Steering wheel, adjusting 51

Steptronic 64

Storage compartments 102

Storage, refer to the Caring for your vehicle brochure

Stroke 152

Switching off the engine 62

Symbols 4

Synthetic oils 127

## T

Tachometer 16, 71

Tail lamps  
  replacing bulb 139

Tank capacity 155

Technical data 152

Technical modifications 5

Telephone hookup 104

Telephone, refer to the separate Owner's Manual

Temperature adjustment 94, 98

Temperature display  
  engine coolant 72  
  outside temperature 75

Temperature layering 95, 99

Thigh support area, adjusting 45

Third brake lamp 140

Through-loading system 106

Tilt alarm sensor  
  switching off 39

Time 74

Tire damage 117

Tire inflation pressure 25, 117

Tire Pressure Monitor (TPM) 85

Tire replacement 118

Tire tread 117

Tools 136

Torque 152

Towing eyelet 148

Towing the vehicle 148

TPM Tire Pressure Monitor 85

Track 153

Transmission 63

Transporting children safely 55

Tread depth, tires 117

Tread wear indicator 117

Trigger alarm – Panic mode 32

Trip odometer 71

Trunk 35  
  capacity 154

Trunk lid, see Luggage compartment lid 35

Turn signal indicator 21, 67  
  replacing bulb 138

Turning circle 153

## U

Uniform Tire Quality Grading 119

## V

Vacuum cleaner, connecting 104

Vehicle  
  break-in procedures 114  
  starting 62  
  switching off 62

Vehicle Memory 59

Vehicle storage, refer to the Caring for your vehicle brochure

Vehicle weight 154

Ventilation 92, 96  
  draft-free 95, 99

Viscosity 127

Voice Control System, refer to the separate Owner's Manual

Voice recognition 22

## W

Warning lamp "Please fasten safety belts" 19

Warning lamps 18

Warning messages 73

Warranty and Service Guide Booklet 130

Warranty, refer also to separate booklet 6

Washer fluid  
  refilling 126, 155

Washer reservoir  
  filling 126, 155

Washer/wiper system 68

Water on roads  
  deep water 115

Wear indicator for tires 117

Weights 154

Wheel, changing 141

Wheelbase 153

Wheels and tires 120

Wheelslip control, see DSC 80

Width 153

# Everything from A to Z

Window condensation  
removing [95](#), [98](#)

Windows  
convenience operation [31](#)  
defrosting [95](#), [98](#)  
power [40](#)  
remote control [32](#)

Windshield washer reser-  
voir, filling [126](#), [155](#)

Windshield wiper blades  
replacing [136](#)

Windshield wipers [68](#)

Winter tires [120](#)

Work in the engine compart-  
ment [122](#)

## X

Xenon lamps [137](#)



# Refueling

To ensure that you always have convenient access to all essential information when you stop for fuel, we recommend that you fill out the adjoining chart by entering the data that apply to your vehicle. Consult the index for individual specifications.

## Fuel

Designation	
-------------	--

Please enter your preferred fuel here.

## Engine oil

Quality	
---------	--

The oil volume between the two marks on the dipstick corresponds to approx. 1.1 US quarts/1 liter.

## Tire inflation pressure

	Summer tires		Winter tires	
	Front	Rear	Front	Rear
Up to 4 persons				
5 persons or 4 plus luggage				

More about BMW

[bmwusa.com](http://bmwusa.com)



The Ultimate  
Driving Machine

01 41 0 156 804 ue

## Free Manuals Download Website

<http://myh66.com>

<http://usermanuals.us>

<http://www.somanuals.com>

<http://www.4manuals.cc>

<http://www.manual-lib.com>

<http://www.404manual.com>

<http://www.luxmanual.com>

<http://aubethermostatmanual.com>

Golf course search by state

<http://golfingnear.com>

Email search by domain

<http://emailbydomain.com>

Auto manuals search

<http://auto.somanuals.com>

TV manuals search

<http://tv.somanuals.com>