

Owner's Manual
for Vehicle



325i
325xi

Congratulations, and thank you for choosing a BMW.

Thorough familiarity with your vehicle will provide you with enhanced control and security when you drive it. Therefore we have one request:

Please take the time to read this Owner's Manual and familiarize yourself with the information that we have compiled for you before starting off in your new BMW. The manual contains important data and instructions intended to assist you in obtaining maximum satisfaction from your BMW's unique array of advanced technical features. It also contains information on vehicle maintenance designed to enhance operating safety while simultaneously helping you to maintain your BMW's value throughout an extended service life. For additional information refer to the supplemental manuals.

This Owner's Manual should be considered a permanent part of this vehicle. It should stay with the vehicle when sold to provide the next owner with important operating, safety and maintenance information.

We wish you an enjoyable driving experience.

BMW AG

4 Notes

About this Owner's Manual

We have made every effort to ensure that you are able to find what you need in this Owner's Manual as quickly as possible. The fastest way to find specific topics is by using the detailed index at the end. If you wish to gain an initial overview of your vehicle, you will find this in the first chapter.

Should you wish to sell your BMW at some time in the future, please remember to hand over this Owner's Manual to the new owner; it is an important part of the vehicle.

Additional sources of information

If you have any additional questions, your BMW center will be glad to advise you.

You can find more information about BMW, for example on its technology, on the Internet at www.bmw.com.

Symbols used



Indicates precautions that must be followed precisely in order to avoid the possibility of personal injury and serious damage to the vehicle.



Contains information that will assist you in gaining the optimum benefit from your vehicle and enable you to care more effectively for your vehicle.



Refers to measures that can be taken to help protect the environment.

◀ Marks the end of a specific item of information.

* Indicates special equipment, country-specific equipment and optional extras when available.



Vehicle Memory, Key Memory, refer to page 61. Identifies functions that can be specifically adapted for a particular key or vehicle. These adjustments can be performed either by yourself or by your BMW center.

© 2003 Bayerische Motoren Werke
Aktiengesellschaft
Munich, Germany

Reprinting, including excerpts, only with the
written consent of BMW AG, Munich.

Order No. 01 41 0 157 605

US English VIII/03

Printed in Germany

Printed on environmentally friendly paper,
bleached without chlorine, suitable for recycling.

Notes

Your individual vehicle

On purchasing your BMW, you have decided in favor of a model with individualized equipment and features. This Owner's Manual describes all models and equipment that BMW offers within the same group.

We hope you will understand that equipment and features are included that you might not have chosen for your vehicle. You can easily identify any differences with the aid of the asterisk * used to identify all optional equipment and accessories.

If your BMW features equipment, such as a car radio or telephone, which is not described in this Owner's Manual, supplementary Owner's Manuals are enclosed. We ask you to read these manuals as well.

Status at time of printing

BMW pursues a policy of continuous, ongoing development designed to ensure that our vehicles continue to embody the highest quality and safety standards combined with advanced, state-of-the-art technology. For this reason, the features described in this Owner's Manual could differ from those in your vehicle. Nor can errors and omissions be entirely ruled out. You are therefore asked to appreciate that no claims can be recognized on the basis of the data, illustrations or descriptions in this Owner's Manual.

For your own safety

Fuels



Use unleaded gasoline only. Fuels containing up to and including 10% ethanol or other oxygenates with up to 2.8% oxygen by weight – that is, 15% MTBE or 3% methanol plus an equivalent amount of co-solvent – will not void the applicable warranties respecting defects in materials or workmanship. Field experience has indicated significant differences in fuel quality – volatility, composition, additives, etc. – among gasolines offered for sale in the United States and Canada. The use of poor-quality fuels may result in driveability, starting and stalling problems especially under certain environmental conditions, such as high ambient temperature and high altitude. Should you encounter driveability problems which you suspect could be related to the fuel you are using, we recommend that you respond by switching to a recognized high-quality brand. Failure to comply with these recommendations may result in unscheduled maintenance. Obey all applicable safety rules when you are handling gasoline. ◀

Maintenance and repair

 Advanced technology, e.g. the use of modern materials and high-performance electronics, requires specially adapted maintenance and repair methods. Therefore, only have corresponding work on your BMW carried out by a BMW center or a workshop that works according to BMW repair procedures with correspondingly trained personnel. If work is carried out improperly there is a danger of consequential damage and the related safety risks. ◀

Parts and accessories

 Important safety information! For your own safety, use genuine parts and accessories approved by BMW.

When you purchase accessories tested and approved by BMW and Original BMW Parts, you simultaneously acquire the assurance that they have been thoroughly tested by BMW to ensure optimum performance when installed on your vehicle.

BMW warrants these parts to be free from defects in material and workmanship. BMW will not accept any liability for damage resulting from installation of parts and accessories not approved by BMW.

BMW cannot test every product made by other manufacturers to ascertain whether it can be used on a BMW safely and without risk to either the vehicle, its operation, or its occupants. Original BMW Parts, BMW Accessories and other products approved by BMW, together with professional advice on using these items, are available from all BMW centers.

Installation and operation of non-BMW approved accessories such as alarms, radios, amplifiers, radar detectors,

wheels, suspension components, brake dust shields, telephones – including operation of any portable cellular phone from within the vehicle without using an externally mounted antenna – or transceiver equipment such as a CB, walkie-talkie, ham radio or similar, may cause extensive damage to the vehicle, compromise its safety, interfere with the vehicle's electrical system or affect the validity of the BMW Limited Warranty. See your BMW center for additional information.

Do not use key or remote control to lock doors or cargo area with anyone inside the vehicle. Refer to the Owner's Manual for more details. ◀

 Maintenance, replacement, or repair of the emission control devices and systems may be performed by any automotive repair establishment or individual using any certified automotive part. ◀

Symbol on vehicle parts

 Indicates that you should consult the relevant section of this Owner's Manual for information on a particular part or assembly.

Notes

Service and warranty

This manual is supplemented by a Service and Warranty Information Booklet for US models or a Warranty and Service Guide Booklet for Canadian models.

We recommend that you read this publication thoroughly.

Your BMW is covered by the following warranties:

- ▷ New Vehicle Limited Warranty
- ▷ Rust Perforation Limited Warranty
- ▷ Federal Emissions System Defect Warranty
- ▷ Federal Emissions Performance Warranty
- ▷ California Emission Control System Limited Warranty.

Detailed information about these warranties is listed in the Service and Warranty Information Booklet for US models or in the Warranty and Service Guide Booklet for Canadian models.

Reporting safety defects

The following only applies to vehicles owned and operated in the US.

If you believe that your vehicle has a defect which could cause a crash or could cause injury or death, you should immediately inform the National Highway Traffic Safety Administration NHTSA in addition to notifying BMW of North America, LLC, P.O. Box 1227, Westwood, New Jersey 07675-1227, telephone toll-free 1-800-831-1117.

If NHTSA receives similar complaints, it may open an investigation, and if it finds that a safety defect exists in a group of vehicles, it may order a recall and remedy campaign. However, NHTSA cannot become involved in individual problems between you, your dealer, or BMW of North America, LLC.

To contact NHTSA, you may either call the Auto Safety Hotline toll-free at 1-800-424-9393 or 366-0123 in the Washington, D.C. area, or write to: NHTSA, U.S. Department of Transportation, Washington, D.C. 20590. You can also obtain other information about motor vehicle safety from the Hotline.

Contents

Notes

- About this Owner's Manual 4
- Additional sources of information 4
- Symbols used 4
- Your individual vehicle 5
- Status at time of printing 5
- For your own safety 5
- Symbol on vehicle parts 6
- Service and warranty 7
- Reporting safety defects 7

Overview

- Cockpit 14
- Instrument cluster 16
- Indicator and warning lamps 18
- Buttons in steering wheel* 22
- Hazard warning triangle* 23
- First-aid kit* 23
- Refueling 24
- Fuel specifications 25
- Tire inflation pressure 25

Controls and features

- Opening and closing:**
- Keys 30
- Central locking system 30
- Opening and closing – via the remote control 31
- Opening and closing – via the door lock 34
- Opening and closing – from the inside 35
- Tailgate 35
- Rear window 36
- Cargo area 37
- Alarm system* 38
- Electric power windows 40
- Glass sunroof, electric* 41

To adjust:

- Safe seating position 44
- Seats 45
- Manual seat adjustment 45
- Power seat adjustment* 47
- Lumbar support* 47
- Head restraints 48
- Safety belts 48
- Seat and mirror memory* 50
- Seat heating* 51
- Steering wheel 52
- Mirrors 52

Contents

Controls and features	Passenger safety systems:			
	Airbags	54		
	Transporting children safely	57		
	Vehicle Memory, Key Memory	61		
	Driving:			
	Ignition lock	63		
	Starting the engine	63		
	Switching off the engine	65		
	Parking brake	65		
	Manual transmission	66		
Sequential manual gearbox SMG*	67			
Automatic transmission with Steptronic*	71			
Turn signal indicator/Headlamp flasher	74			
Washer/wiper system/Rain sensor*	75			
Cruise control*	77			
Everything under control:				
Odometer	79			
Tachometer	79			
Energy control	79			
Fuel gauge	80			
Engine coolant temperature gauge	80			
Service interval display	81			
Check Control	81			
Clock	82			
Computer*	83			
	Technology for safety and driving convenience:			
	Park Distance Control (PDC)*	85		
	Dynamic Stability Control (DSC)	86		
	Dynamic Stability Control (DSC) – 325xi	88		
	Hill Descent Control (HDC)*	90		
	Flat Tire Monitor*	91		
	Brake force display	92		
	Lamps:			
	Parking lamps/Low beams	93		
	Instrument lighting	94		
	High beams/Standing lamps	94		
	Fog lamps*	95		
	Interior lamps	95		
	Controlling the climate for pleasant driving:			
	Air conditioning	96		
	Automatic climate control*	100		
	Interior conveniences:			
	Premium sound system*	105		
	Glove compartment	105		
	Storage compartments	106		
	Cellular phone*	107		
	Ashtray, front*	108		
	Ashtray, rear*	108		
	Socket	109		
	Loading and transporting:			
	Ski bag*	110		
	Cargo area	111		
	Cargo loading	113		
	Roof-mounted luggage rack*	116		

Contents

Operation, maintenance

Special operating instructions:

- Break-in procedures [120](#)
- General driving notes [121](#)
- Antilock Brake System (ABS) [121](#)
- Brake system [122](#)

Wheels and tires:

- Tire inflation pressure [124](#)
- Tire condition [124](#)
- Tire replacement [125](#)
- Wheel and tire combinations [127](#)
- Winter tires [127](#)

In the engine compartment:

- Hood [129](#)
- Engine compartment essentials [130](#)
- Washer fluids [132](#)
- Engine oil [132](#)
- Coolant [134](#)
- Brake fluid [135](#)

Maintenance:

- The BMW Maintenance System [136](#)

Laws and regulations:

- California Proposition 65 warning [138](#)
- OBD interface socket [138](#)

Owner service procedures

Replacement procedures:

- Onboard tool kit [142](#)
- Windshield wiper blades [142](#)
- Lamps and bulbs [143](#)
- Changing a wheel [147](#)
- Run Flat tires* [150](#)
- Battery [151](#)
- Fuses [151](#)

Giving and receiving assistance:

- Receiving assistance [152](#)
- Jump-starting [153](#)
- Towing the vehicle [154](#)

Technical data

- Engine data [160](#)
- Dimensions [161](#)
- Weights [162](#)
- Capacities [163](#)

Contents

Index

Everything from A to Z [166](#)

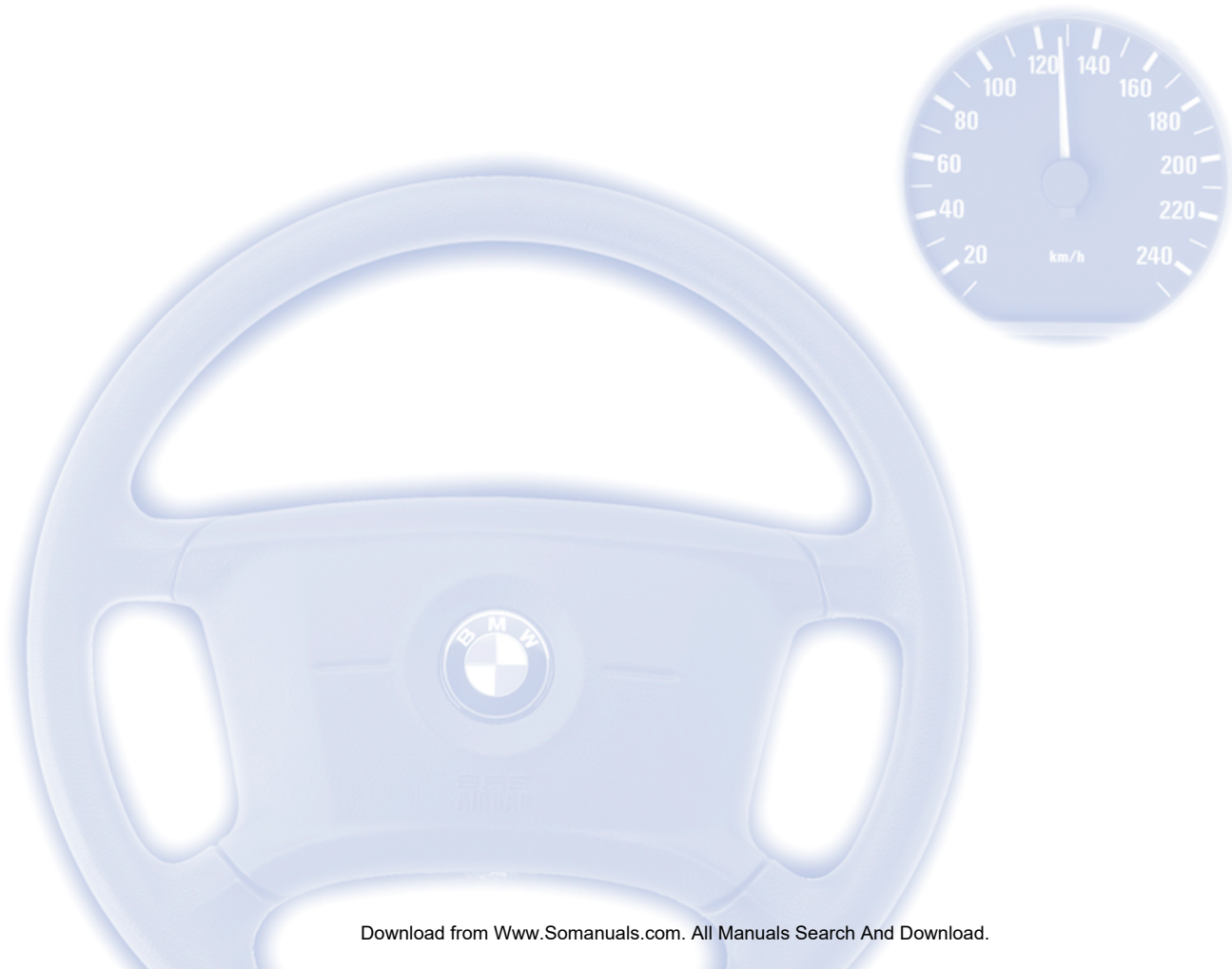

Overview

Controls and features

Operation, maintenance

Owner service procedures

Technical data

Index



Overview

Controls

Maintenance

Repairs

Data

Index

14 Cockpit

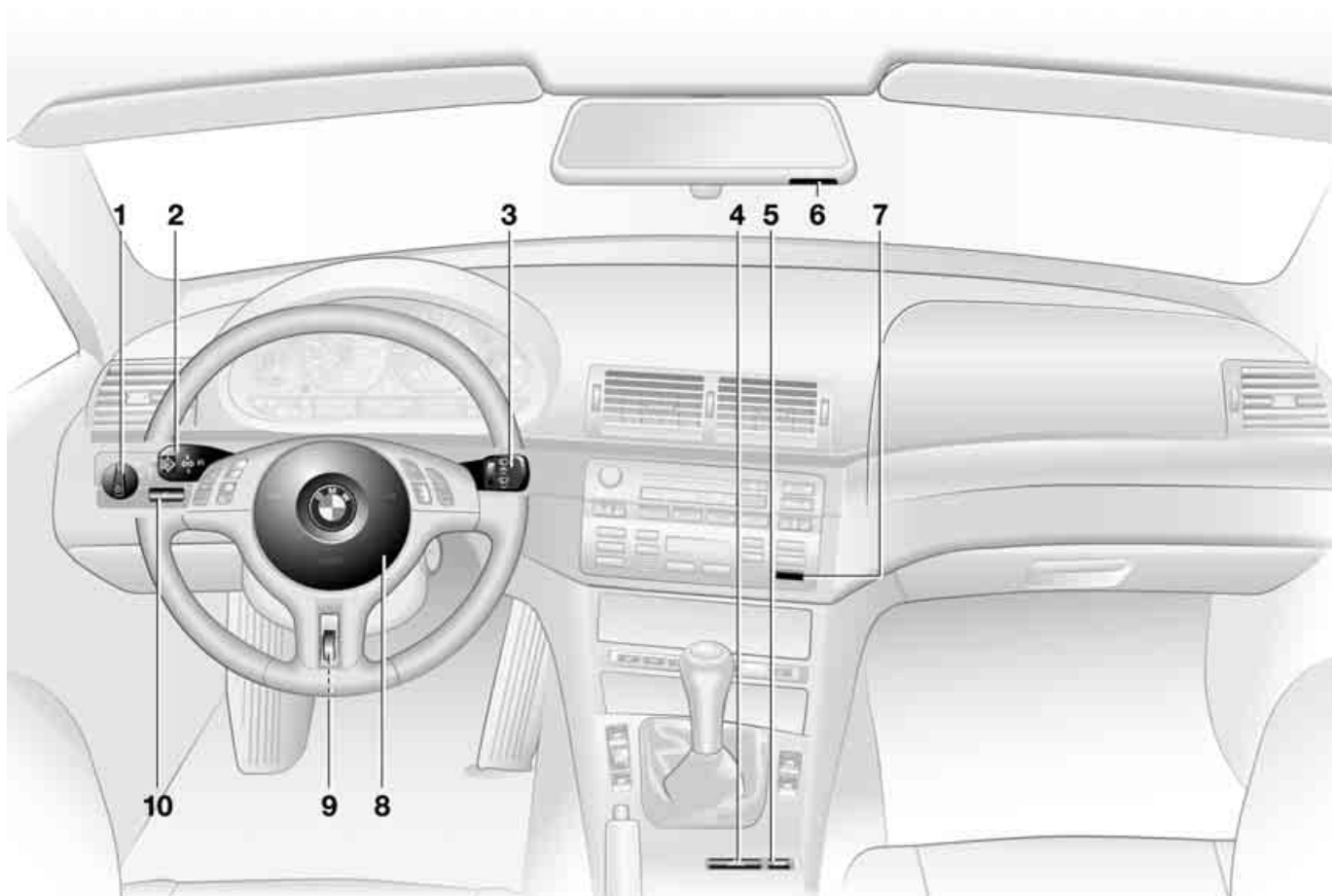

MV02058CMA

Cockpit

- 1 Parking lamps/Low beams [93](#)
- 2 ▷ Turn signal indicators [74](#)
 - ▷ Standing lamps [94](#)
 - ▷ High beams [94](#)
 - ▷ Headlamp flasher [74](#)
 - ▷ Computer [83](#)
- 3 Washer/wiper system/Rain sensor [75](#)
- 4 Hazard warning flashers
- 5 Central locking system [30](#)
- 6 ▷ Initiating an emergency call [152](#)
 - ▷ Mobile Service [152](#)
- 7 Rear window defroster [98](#), [103](#)
- 8 Horn: the entire surface
- 9 Adjusting the steering wheel [52](#)
- 10 Fog lamps [95](#)

16 Instrument cluster

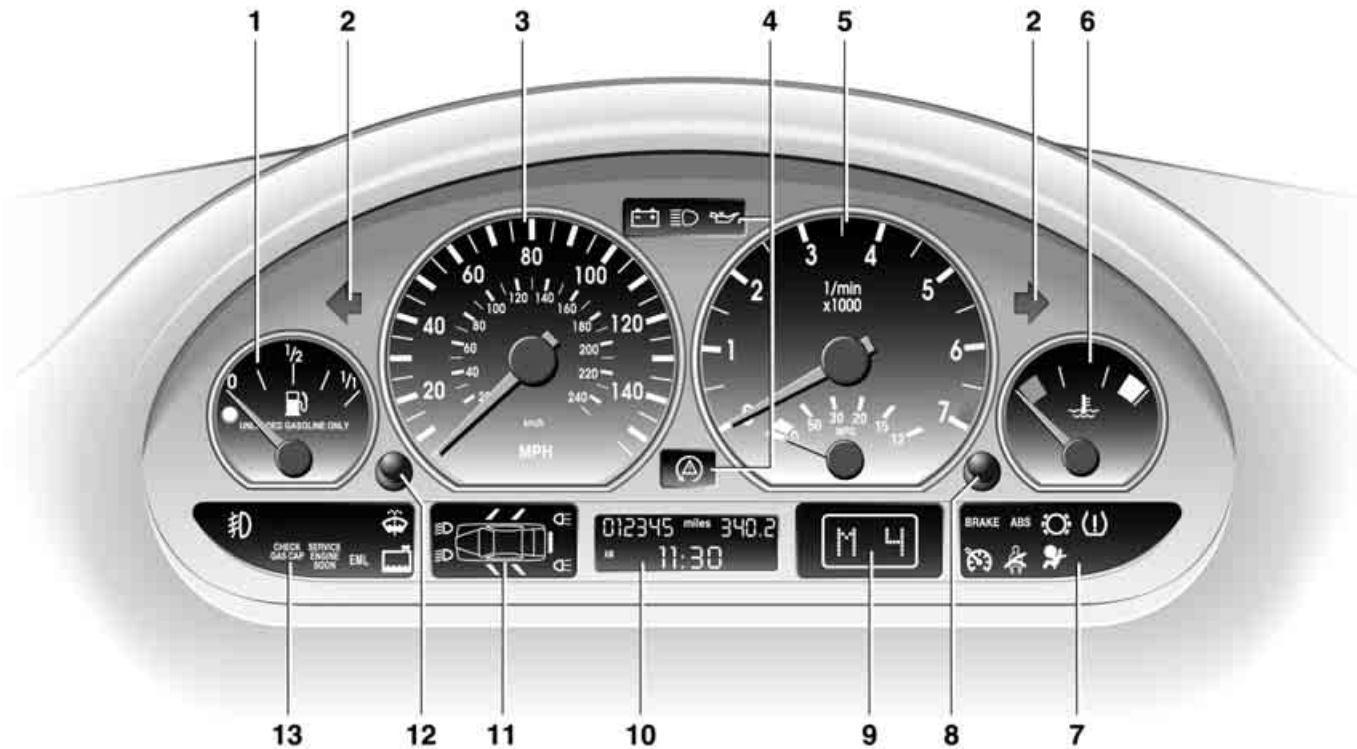

Instrument cluster

- 1 Fuel gauge 80
- 2 Indicator lamp for turn signals 20
- 3 Speedometer
- 4 Indicator and warning lamps 18 to 21
- 5 Tachometer and Energy Control 79, 79
- 6 Engine coolant temperature gauge 80
- 7 Indicator and warning lamps 18 to 21
- 8 Control button for
 - ▷ Time 82
 - ▷ Service interval display 81
 - ▷ Outside temperature display 83
- 9 Selector lever and program display for automatic transmission/sequential manual gearbox 19, 67, 73
- 10 Display for
 - ▷ Trip odometer/Odometer 79
 - ▷ Clock 82
 - ▷ Service interval 81
 - ▷ Computer 82
- 11 Check Control 81
- 12 Trip odometer, reset to zero 79
- 13 Indicator and warning lamps 18 to 21

18 Indicator and warning lamps

Technology that monitors itself

Indicator and warning lamps that are identified by ● are tested for proper functioning whenever the ignition key is turned. They each light up once for different periods of time.

If a fault should occur in one of these systems, the corresponding lamp does not go out after the engine is started, or it lights up while the vehicle is moving. You will see how to react to this in the following section.

Red: stop immediately



Battery charge current ●
The battery is no longer being charged. Indicates a defective alternator drive belt or a problem with the alternator's charge circuit. Please contact the nearest BMW center.



If the drive belt is defective, stop and switch off the engine immediately to prevent overheating and serious engine damage. If the drive belt is defective, increased steering effort is also required. ◀



Engine oil pressure ●
Stop the vehicle immediately and switch off the engine.

Check the engine oil level and top off as required. If the oil level is correct: please contact the nearest BMW center.



Do not continue driving, as the engine could sustain serious damage from inadequate lubrication. ◀



Brake warning lamp ●
If the lamp comes on when the parking brake is not engaged: check the brake fluid level. Before driving further, be sure to comply with the instructions on pages 122 and 135.



Brake warning lamp for Canadian models.



Flat Tire Monitor ●
In addition, an acoustic signal is sounded: there is a flat tire.

Reduce speed and carefully come to a stop. Avoid sudden braking and steering maneuvers.
For additional information: refer to page 91

Red and yellow: continue driving cautiously

BRAKE

The brake warning lamp comes on together with the yellow indicator lamps for ABS ● and DSC:

ABS

The entire ABS, CBC, DSC and ADB-X/DBC control system has failed. Continue driving cautiously and defensively. Avoid full brake applications. Please have the system checked by your BMW center as soon as possible.

Additional information beginning on page 86



CBC, ABS, DSC and ADB-X/DBC indicator and warning lamps for Canadian models.



Red: an important reminder

BRAKE

Brake warning lamp ●
Comes on when the parking brake is engaged – an additional acoustic signal sounds when starting off. For additional information: refer to page 65

Indicator and warning lamps



Brake warning lamp for Canadian models.



Please fasten safety belts ●

Comes on together with an acoustic signal until the safety belts are fastened.

For additional information on safety belts: refer to page [48](#)



Airbags ●

Please have the system inspected at your BMW center.

For additional information: refer to page [54](#)

Orange: consult the nearest BMW center



Automatic transmission/sequential manual gearbox

The respective transmission has responded to a malfunction by reverting to operation in its emergency default program. Please consult the nearest BMW center.

For additional information: refer to pages [67](#), [71](#)

Yellow: check as soon as possible



Engine oil level

If the lamp comes on during normal vehicle operation: the engine oil level has fallen to the absolute minimum; refill as soon as possible. Do not drive more than approx. 30 miles/50 km before refilling. For additional information: refer to page [132](#)



Engine oil level

Comes on after the engine has been switched off: add engine oil at the earliest opportunity – next time you stop to refuel. For additional information: refer to page [132](#)



Brake pads ●

Have the brake pads checked. For additional information: refer to page [122](#)



Flat Tire Monitor ●

The Flat Tire Monitor is malfunctioning or out of order. Please have the system inspected at your BMW center. For additional information: refer to page [91](#)



Dynamic Stability Control (DSC) ●

Indicator lamp flashes:

The system is actively regulating drive torque and braking force. The indicator lamp stays lit: DSC has been switched off with the button; DTC is operational. Please contact the nearest BMW center in case of a malfunction.

Additional information beginning on page [86](#)

325xi:

DSC has been switched off manually or there is a system malfunction. ADB-X is operational. If the indicator lamp fails to go out when you press the DSC button again, this indicates a system malfunction affecting both DSC and ADB-X.

Please consult the nearest BMW center.

For additional information: refer to page [88](#)

20 Indicator and warning lamps



Dynamic Stability Control (DSC) and brake warning lamp ●

The indicator lamps remain on: DSC/DTC have been switched off with the button or are faulty. Please consult the nearest BMW center.

BRAKE

Additional information beginning on page [86](#)
325xi:

DSC and ADB-X system malfunction. There is no provision for switching off ADB-X. Please consult the nearest BMW center.



DSC indicator and brake warning lamps for Canadian models.



Dynamic Brake Control (DBC) ●
Malfunction in DBC system.

Conventional braking efficiency is available and unrestricted. Have the system repaired at your BMW center as soon as possible. Additional information beginning on page [121](#)



Dynamic Brake Control (DBC) warning lamp for Canadian models.



Add washer fluid
The washer fluid level is too low. Top off the fluid at the earliest opportunity.

For additional information: refer to page [132](#)



CHECK GAS CAP* ●
This indicator lamp comes on when the gas cap is loose or missing.

Close the gas cap tightly: refer to page [24](#)



SERVICE ENGINE SOON ●
If the indicator lamp comes on either continuously or intermittently, this indicates a fault in the emissions-related electronic systems.

Although the vehicle remains operational, you should have the systems checked by your BMW center at the earliest possible opportunity. For additional information: refer to page [138](#)



Service Engine Soon indicator lamp for Canadian models.



Engine electronics ●
There is a fault in the electronic engine-management system.

You can continue to drive with reduced engine output or engine speed. Please have the system inspected at your BMW center.



Add coolant
The coolant level is too low. Add coolant at the earliest opportunity.

For additional information: refer to page [134](#)

Green: for your information



Turn signal indicator
Flashes when the turn signals are on.

Rapid flashing indicates a system malfunction.

For additional information: refer to page [74](#)



Cruise control
Lights up when the cruise control is activated: ready for operation via the buttons in the steering wheel.

For additional information: refer to page [77](#)

Indicator and warning lamps



Front fog lamps

Lights up whenever you switch on the fog lamps.

For additional information: refer to page [95](#)

Blue: for your information



High beams

Comes on when the high beams are on or the headlamp flasher

is actuated.

For additional information: refer to pages [74](#), [94](#)

22 Buttons in steering wheel*

These buttons let you operate the following functions quickly and without being distracted from traffic conditions:

- ▷ Selected radio functions
- ▷ The cruise control
- ▷ Selected telephone functions
- ▷ The voice recognition system.

 The controls are active only when the corresponding systems and accessories are switched on. ◀



Press briefly:

Receive a phone call, initiate dialing, terminate a call.

Extended pressure:

Switch voice recognition on and off.



Switch between phone, radio, cassette and CD.



Forward:

- ▷ Radio
Press briefly: next station in station memory
Extended pressure: station search
- ▷ CD
Press briefly: jump to next track
Extended pressure: search function in track
- ▷ Cassette
Press briefly: jump to next track or stop fast forward
Extended pressure: fast forward
- ▷ Phone
Scan personal phone book.



Rewind/reverse: same functions as forward.



Volume.



Cruise control: select a stored setting.



Cruise control: store and accelerate + or decelerate and store -.



Cruise control: activate/interrupt/deactivate.

Hazard warning triangle*



The warning triangle is located on the left side of the cargo area behind the cover panel.

To open: press the button and remove the cover.

 Always observe all legal regulations requiring a warning triangle to be carried in the vehicle. ◀

First-aid kit*

23



The first-aid kit is located under the passenger seat.

To open: pull the handle and fold the cover down.

To close: fold the cover up and press it until the tab engages.

 Some of the articles in the first-aid kit have a limited period of use before expiration. For this reason, check the expiration dates of each of the items regularly and replace any whose expiration dates have passed. You can purchase replacements in any drugstore or pharmacy. Always observe all legal regulations requiring a first-aid kit to be carried in the vehicle. ◀



 Always observe all safety precautions posted at the service station when handling fuel. Never carry spare fuel containers in your vehicle. Whether empty or full, these containers can leak, cause an explosion, or lead to fire in the event of a collision. ◀



Fuel filler door

 Always switch off the engine before refueling, as it is not possible to add fuel with the engine running, and attempts may also trigger the SERVICE ENGINE SOON lamp. ◀

Press on the rear edge of the fuel filler door to open and close it.

If an electrical malfunction occurs, you can unlock the fuel filler door manually:

1. Release the side trim on the right-hand sidewall of the cargo area
2. Pull the knob with the fuel pump symbol.

Simple and environmentally friendly

 Open the gas cap carefully to prevent fuel from spraying out. Fuel spray may cause injury. ◀

Keep the gas cap in the bracket attached to the fuel filler door.

When refueling, insert the filler nozzle completely into the filler pipe. Lifting the nozzle during refueling

- ▷ results in premature pump shutoff
- ▷ and will reduce the effectiveness of the vapor recovery system on the pump.

The fuel tank is full when the filler nozzle shuts off the first time.

Refueling

 Close the gas cap carefully after refueling until a click is heard. While closing, be sure not to squeeze the strap which is fastened to the cap. A loose or missing cap will activate the CHECK GAS CAP* lamp. ◀

Fuel tank capacity

▷ Approx. 16.6 gal./63 liters, of which
▷ approx. 2.1 gal./8 liters are reserve capacity.

 Do not drive to the last drop of fuel. This can prevent the engine from operating properly and result in damage. ◀

Fuel specifications

The engine uses lead-free gasoline only.

Required fuel:

▷ Premium Unleaded Gasoline, min. 91 AKI.
AKI = Anti Knock Index

 Never use leaded fuel, as it would cause permanent and irreversible damage to the oxygen sensor and the catalytic converter. ◀

Tire inflation pressure

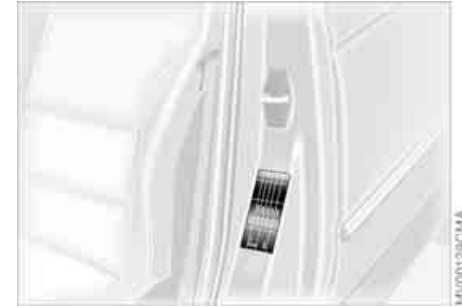

Checking tire pressures

Tire pressures in psi/kilopascal are shown on the driver's door post and are visible when the door is open.

Only check the tire inflation pressures of cold tires. This means after driving a maximum of 1.25 miles/2 km or after the vehicle has been parked for at least 2 hours. Warm tires have higher inflation pressures.

In the following tire inflation pressure table, all pressures are specified in the standard units of pressure, psi and kilopascal, and apply to cold tires, i.e. tires at ambient temperature.

26 **Tire inflation pressure**

Vehicles with Flat Tire Monitor:

After correcting the inflation pressures, reinitialize the system. Refer to page [91](#).



Check the tire pressures on a regular basis – at least twice a month – and before every extended journey. If this is not done, incorrect tire pressures can cause driving instability and tire damage, ultimately resulting in accidents.

Remember to check the inflation pressure in the space-saver or standard spare tire, refer to page [147](#).

Inflate the spare tire to the highest inflation pressure specified for your vehicle. ◀

Comply with tire approval specifications

The inflation pressures in the table apply to BMW approved tire sizes and tire manufacturers. Your BMW center can provide you with more information about these. Other pressures may be required for tires made by other manufacturers.

Your vehicle is equipped with tires that not only meet US standards, but also European standards. We recommend the exclusive use of BMW approved tires.

Tire inflation pressure

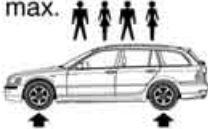
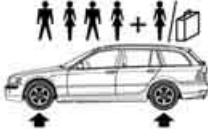
BMW	Tires All pressure specifications in the table are indicated in psi/kilopascal with cold tires cold = ambient temperature	max. 			
		Front	Rear	Front	Rear
325i	205/55 R 16 91 H M+S	32/220	38/260	38/260	45/310
325xi	205/55 R 16 91 H				
	225/50 R 16 92 W – not 325xi				
	225/45 R 17 91 W				
	225/45 ZR 17	32/220	–	38/260	–
	245/40 ZR 17	–	38/260	–	45/310
	205/50 R 17 93 V M+S extra load	35/240	41/280	41/280	48/330
	205/50 R 17 93 W extra load				
	205/55 R 16 91 Q M+S				
	225/50 R 16 92 Q M+S – not 325xi				
	205/50 R 17 93 Q M+S extra load				
	225/45 R 17 91 Q M+S				
	Space-saver spare tire in cargo area			61/420	

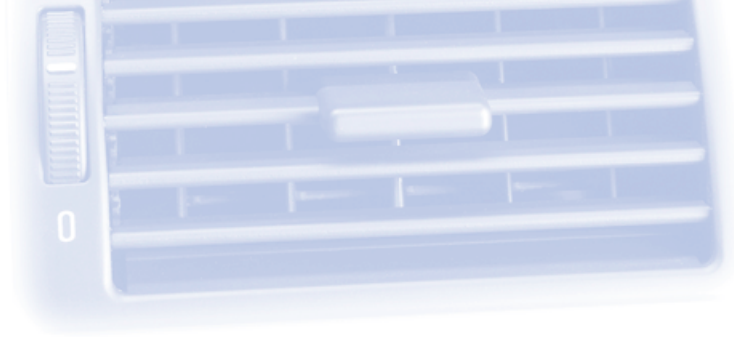

Overview

Controls and features

Operation, maintenance

Owner service procedures

Technical data

Index

Overview

Controls

Maintenance

Repairs

Data

Index

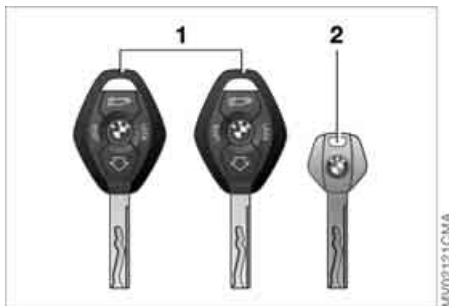

2 Spare key – for storage in a safe place, such as in your wallet. This key is not intended for constant use. The glove compartment cannot be locked and unlocked with this key – which is useful for valet parking, for example

The key set

1 Master keys with remote control unit – these keys determine the functions of the Key Memory. Refer to page 61. You can mark the individual keys for subsequent identification by applying the colored decals that you received when accepting delivery of your vehicle

▶ In every master key there is an extended-life battery that is charged automatically in the ignition lock as you drive.

For this reason, if you have master keys that are not being used, you should use those keys at least once a year while driving for an extended period to charge the battery, refer also to page 31. ◀

Central locking system

The concept

The central locking system is ready for operation whenever the driver's door is closed. The system simultaneously engages and releases the locks on the

- ▷ doors
- ▷ tailgate and rear window
- ▷ fuel filler door.

The central locking system can be operated

- ▷ from outside via the remote control as well as via the driver's door lock
- ▷ from inside by pressing a button.

The fuel filler door is not locked when the central locking system is activated from the inside, refer to page 35. When the system is actuated from the outside, the anti-theft system is also activated. This prevents the doors from being unlocked via the lock buttons or the release handle. The alarm system is also activated or deactivated.

If locked from the inside, the central locking system unlocks automatically in the event of an accident, except on doors that have been locked individually using the lock buttons, refer to page 35. In addition, the hazard warning flashers and interior lamps come on.

Opening and closing – via the remote control

The concept

The remote control also provides two additional functions beyond the central locking feature:

▷ To switch on interior lamps, refer to page 32.

With this function you can also search for the vehicle when parked in an underground garage, for instance

▷ Opening the rear window, refer to page 32.

The rear window will open slightly, regardless of whether it was previously locked or unlocked.

Whenever you unlock or lock the vehicle, you simultaneously deactivate/activate the anti-theft system, disarm/arm the alarm system and switch the interior lamps on/off.



You can have a signal set to confirm that the vehicle's locks have engaged securely. ◀

Master keys with remote control



Persons or animals inside the vehicle may be able to lock the doors from the inside. For this reason, always take the vehicle keys with you so that the vehicle can be opened again from the outside at any time. ◀



If it is no longer possible to lock the vehicle via the remote control, the battery is discharged. Use this key while driving for an extended period in order to recharge the battery. To prevent unauthorized use of the remote control, surrender only the spare key when leaving the vehicle for valet parking, for example.

In the event of a system malfunction, please contact your BMW center. You can also obtain replacement keys there. ◀



- 1 Unlock, convenience opening mode, and disarm alarm system
- 2 Lock and secure, arm alarm system, activate interior lamps, disarm tilt alarm sensor and interior motion sensor
- 3 Open the rear window, Panic mode – trigger alarm

To release



Press the button once to unlock the driver's door.

Press the button a second time to unlock all vehicle locks.

32 Opening and closing – via the remote control

Convenience opening mode



Press and hold button: to open the electric power windows and glass sun-roof.

To lock and secure



Press button.

To switch on the interior lamps



After locking the vehicle, press button again.

To deactivate the tilt alarm* and interior motion sensors*



Press button a second time immediately after locking.

For additional information, refer to page [39](#).

To open the rear window



Press button.
the rear window opens slightly. It can now be tilted up.



If the vehicle is locked, the rear window will be locked again after it is closed.

Before and after a trip, be sure that the rear window has not been opened unintentionally. ◀



If you prefer, the tailgate will open instead of the rear window. ◀

Panic mode – trigger alarm



By pressing the button for more than 2 seconds, the alarm system can be triggered in the event of danger, if it is armed.

To switch of the alarm:



Press button.

External systems

The remote control system's operation may be affected by other units or equipment operating in the immediate vicinity of your vehicle.

If this should occur, you can still open and close the vehicle using the master key in the door lock.

For US owners only

The transmitter and receiver units comply with part 15 of the FCC/Federal Communications Commission regulations. Operation is governed by the following:

FCC ID:

- ▷ LX8EWS
- ▷ LX8FZVS
- ▷ LX8FZVE.

Compliance statement:

This device complies with part 15 of the FCC Rules. Operation is subject to the following two conditions:

- ▷ This device may not cause harmful interference, and
- ▷ this device must accept any interference received, including interference that may cause undesired operation.

Opening and closing – via the remote control

 Any unauthorized modifications to these devices could void the user's authority to operate the equipment. ◀

34 Opening and closing – via the door lock

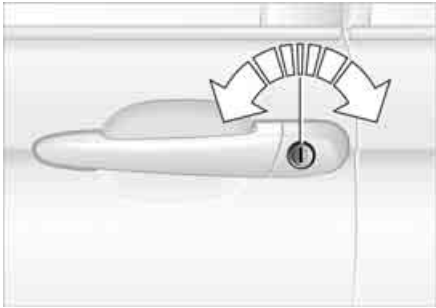

 Whenever closing the windows or sliding/tilt sunroof you should always monitor their path and progress to ensure that no one is injured. Releasing the key stops the operation. ◀

Manual operation

In the event of electrical malfunction
Turn the key all the way to the left or right to unlock or lock the driver's door.

One turn of the key in the driver's door lock unlocks the driver's door only. Turning the key a second time unlocks all of the remaining doors, the tailgate and the fuel filler door.



You can have a signal set to confirm that the vehicle's locks have engaged securely. ◀

Convenience operation

You can also operate the power windows and the glass sunroof via the door lock.

- ▷ To open: with the door closed, hold the key in the Unlock position
- ▷ To close: with the door closed, hold the key in the Lock position.



To unlock and open the doors

1. Press the button for the central locking system
 2. Pull the release handle above the armrest on the door you wish to open
- or
- pull the release handle for any door twice: to unlock and open the door.

To lock

- ▷ Either use the central locking button to lock all doors at once or
- ▷ press the individual door lock buttons down. To prevent the driver from being inadvertently locked out of the vehicle, the driver's door lock button will not engage as long as the door is open.

 Persons or animals inside the vehicle may be able to lock the doors from the inside. For this reason, always take the vehicle's keys with you so that you can open the vehicle again from the outside at any time. ◀

You can use this button to operate the central locking system when the front doors are closed. With this button, only the doors, the tailgate and rear window are unlocked or locked. The anti-theft system is not activated.

 If only the driver's door was unlocked from the outside and you press the button, then, with the driver's door still open, the passenger-side door, the tailgate and the fuel filler door will unlock, too. If the driver's door is closed, it will be locked. ◀

 If you desire, the central locking system can be activated automatically as soon as you begin to drive. This can be adjusted to be key-specific. ◀



To open from the outside

 To avoid damage, check to ensure that you have adequate clearance before opening the tailgate. ◀

Press the button in the handle recess: the tailgate opens slightly.

The cargo area is illuminated when the tailgate is open.

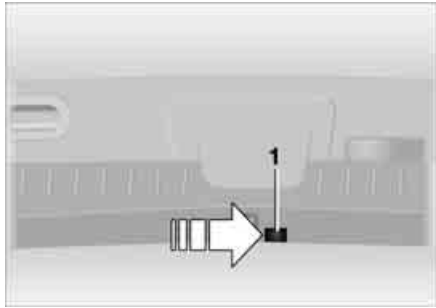

MV01032CMA



MV00980CMA

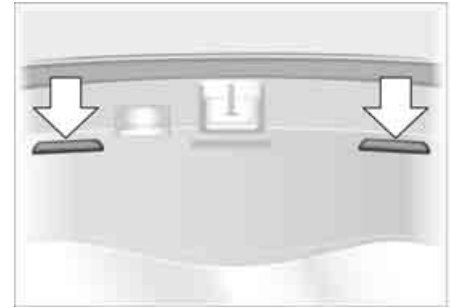

MV00980CMA

Manual operation

- ▷ Fold rear center armrest or rear backrest forward
- ▷ Remove cover 1 – this operation is easy to carry out with the aid of the ignition key
- ▷ Press the lever – see arrow – to the right.

The tailgate is locked again as soon as you close the lid.

To open from the inside*

If the tailgate has not been locked separately, you can open it with this button in the footwell on the driver's side when the vehicle is stationary.

To close

The handle recesses in the interior trim panel of the tailgate make it easier to pull the tailgate down.

▷ Both before starting off and after completing every journey, check to ensure that neither the rear window nor the tailgate has been opened inadvertently. ◀

⚠ To avoid injuries, be sure that the travel path of the tailgate is clear when it is closed, following the same precautions as with all closing procedures. ◀

Rear window

 Always drive with both the tailgate and the rear window securely closed, as exhaust gases might otherwise be drawn into the interior of the vehicle. ◀

Should it be absolutely necessary to operate the vehicle with the tailgate or the rear window open:

1. Close all windows and the glass sun-roof
2. Greatly increase the quantity of air coming from the air conditioning or automatic climate control system, refer to page 96 or 100.

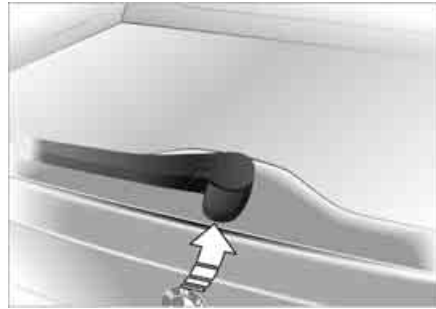

To open from the outside

Small items can be loaded or unloaded quickly if the rear window is opened separately.

Press button – see arrow: the rear window opens slightly. It can now be tilted up.

Opening with the remote control, refer to page 32.

Push the window down to close it.

 If pointed or sharp-edged objects could strike the rear window while driving, be sure to provide protection around all edges. If you do not do this, the heating conductors of the rear window could be damaged. ◀

Cargo area

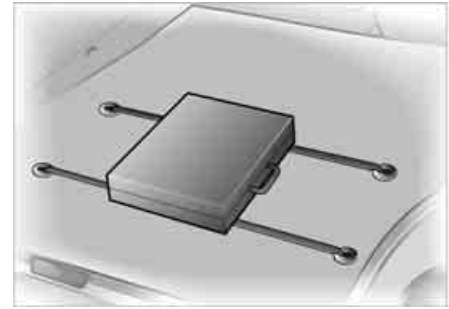

Luggage straps

Use the retaining straps on the cargo area floor to secure smaller items of luggage.

Movement is reduced when objects are placed on the straps.

To secure your luggage, use the luggage compartment nets* or flexible straps that you can attach to the fittings at the inner corners of the cargo area.

Refer also to Cargo loading on page 113.

For additional details in the cargo area and for the cargo area cover, please refer to Cargo area beginning on page 111.

The concept

The vehicle alarm system responds:

- ▷ When a door, the hood, the tailgate or the rear window is opened
- ▷ To movement inside the vehicle – interior motion sensor
- ▷ To variations in the vehicle's tilt angle such as those occurring during attempts to steal the wheels or tow the vehicle
- ▷ To interruption of battery voltage.

The system responds to unauthorized vehicle entry and attempted theft by simultaneously activating the following:

- ▷ Sounding an acoustic alarm for 30 seconds
- ▷ The hazard warning flashers are activated for approx. five minutes
- ▷ Flashing the high beams on and off in rhythm with the hazard warning flashers.

To arm and disarm the alarm system

When the vehicle is locked or unlocked via the driver's door lock or with the remote control, the alarm system is also simultaneously armed or disarmed.



You can have different acknowledgment signals set to confirm arming and disarming. ◀



You can also open the rear window when the system is armed by pressing the remote control button, refer to page 32. The window is once again secured when it is closed.

Extended pressure on the button sets off the alarm – Panic mode, refer to page 32.



Indicator lamp displays

- ▷ The indicator lamp below the interior rearview mirror flashes continuously: The system is armed
- ▷ The indicator lamp flashes while the system is armed: a door, the hood, the tailgate or rear window is not completely closed. Even if you do not close the alerted area(s), the remaining areas are secured, and the indicator lamp will flash continuously after 10 seconds. However, the interior motion sensor is not activated
- ▷ The indicator lamp goes out when the system is disarmed: no manipulation or attempted intrusions have been detected in the period since the system was armed
- ▷ The indicator lamp flashes for 10 seconds when the system is dis-

Alarm system*

armed: an attempted entry has been detected in the period since the system was armed.

Following triggering of an alarm, the indicator lamp will flash continuously.

Avoiding unintentional alarms

The tilt alarm sensor and interior motion sensor may be switched off at the same time. You can do this to prevent a false alarm from being triggered in garages with elevator ramps, for instance, or when the vehicle is transported by train:



Lock the vehicle twice to arm the system. Press the button on the remote control twice in succession or lock the vehicle twice with the key.

The indicator lamp lights up briefly and then flashes continuously. The tilt alarm sensor and the interior motion sensor are deactivated as long as the system is armed.



You can have the tilt alarm sensor and the interior motion sensor permanently deactivated. ◀

Interior motion sensor

In order for the interior motion sensor to function properly, the windows and the glass sunroof must be completely closed.

Nevertheless, you should deactivate the interior motion sensor, refer to Avoiding unintentional alarms, if

- ▷ persons or animals are left in the vehicle
- ▷ the windows or the glass sunroof are being left open.



The system deactivates the tilt-alarm sensor and the interior motion sensor if the convenience closing of windows and the glass sunroof is interrupted in the first 10 seconds and then restarted. The alarm must then be disarmed and reactivated before it will resume operation. ◀



▷ Press the switch briefly past the pressure point: the windows move automatically. Pressing the switch again stops the opening cycle.

You can close the windows in the same manner by pulling the switch.

If your vehicle is equipped with optional electric power windows in the rear* separate switches will be located below the windows.

For convenience operation via the door lock, refer to page 34.

To open and close windows

 When leaving the vehicle, always remove the ignition key from the lock and remember to close the doors to prevent persons or animals from operating the power windows and injuring themselves, etc. ◀

After the ignition has been switched off: You can still operate the electric power windows for up to 15 minutes, as long as no one opens either of the front doors.

With the ignition key in position 1 or higher

▷ Press the switch until you feel resistance: the window retracts as long as you maintain pressure on the switch

 Despite this safety feature, be extremely careful to ensure that the closing path of the window is not obstructed. Some types of objects might fail to trigger the contact strip in some situations – very thin objects, for instance.

You can override this safety feature by pressing the switch beyond the resistance point and holding it. ◀

Safety feature

The front windows are each equipped with contact strips located in the upper window frames. If pressure is exerted against this contact strip while a window is being raised, the system will respond by stopping the window and then retracting it a small distance.

Electric power windows



Safety switch

With the safety switch, you can prevent the rear windows from being opened or closed via the switches in the rear passenger area, for example by children.

 Press the safety switch whenever persons or animals are riding in the rear of the vehicle. Careless use of the power windows can lead to injury. ◀

Glass sunroof, electric* 41

 To prevent injuries, exercise care when closing the glass sunroof and keep it in your field of vision until it is shut. When leaving the vehicle, always remove the ignition key from the lock and remember to close the doors to prevent persons or animals from operating the sunroof and injuring themselves, etc. ◀

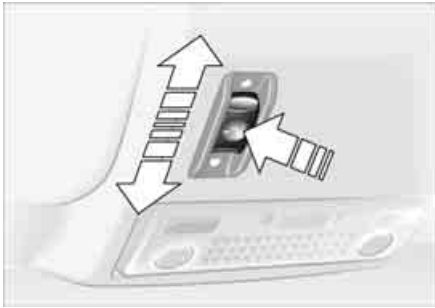

Opening and closing

With the ignition key in position 1 or higher

- ▷ Slide the switch until you feel resistance: the sunroof opens and closes as long as you hold the switch
- ▷ Slide the switch briefly past the pressure point: the sunroof moves automatically.
Tapping the switch again stops the motion immediately.

The headliner insert retracts with the sunroof while it is opening.

After the ignition has been switched off: You can still operate the sunroof for up to 15 minutes, as long as no one opens either of the front doors.

For convenience operation via the door lock, refer to page 32 or 34.

Raising the glass sunroof

With the ignition key in position 1 or higher: tap the switch.

Tapping the switch again stops the motion immediately.

If you briefly press the switch in the raise direction while the sunroof is open, the sunroof will rise to its uppermost position.

After the ignition has been switched off: You can still operate the sunroof for up to 15 minutes, as long as no one opens either of the front doors.

The headliner insert slides back somewhat when you raise the sunroof.

 Do not use force to close the headliner insert with the sunroof in its raised position, as damage to the mechanism could result. ◀

Safety feature

If the glass sunroof encounters resistance

- ▷ when it is closing from the raised position

▷ when it is closing from a point roughly past the middle of its travel, the closing cycle is interrupted and the glass sunroof will open again slightly.

 Despite this safety feature, be extremely careful that the travel path of the sunroof is not obstructed whenever it is closed. Remember that the safety mechanism may not be able to detect obstructions under all circumstances – with very thin objects, for instance.

You can disable this safety feature by pressing the switch beyond the pressure point and holding it. ◀

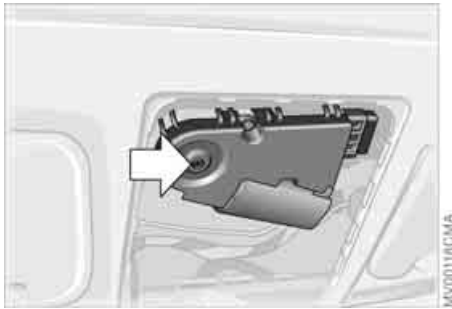

Manual operation

In the event of an electrical malfunction, you can also operate the glass sunroof manually

1. Remove the interior lamp, then reach into the exposed opening and press out the cover
2. Use the Allen key from the onboard tool kit, refer to page 142, to turn the glass sunroof in the desired direction.

44 Safe seating position

For driving that is relaxed and less likely to cause fatigue, you should select a sitting position that reflects your personal requirements. In combination with the safety belts and airbags, the correct seating position also plays an important role in enhancing occupant safety in the event of an accident. To ensure that the vehicle's safety systems provide you with optimal protection, we request that you direct your careful attention to the following section.

For additional information on transporting children refer to page 57.

Sitting safely with airbags

 Always maintain an adequate distance between yourself and the airbags. Always hold the steering wheel by the rim to keep any chance of injury to hands or arms to an absolute minimum should the airbag be deployed. Never allow any objects, individuals or animals to obstruct the areas between passengers and airbags. Never use the front airbag's cover as a storage tray or support for objects of any kind. Never allow front passengers to rest their feet or legs on the airbag cover. ◀

For airbag locations and additional information on airbags, refer to page 54.

Sitting safely with safety belts

Your vehicle offers five sitting positions, each of which is provided with a safety belt.



Never allow more than one person to wear a single safety belt. Never allow infants or small children to ride in a passenger's lap. Avoid twisting the belt while routing it firmly across the hips and shoulder, wear it as snugly against your body as possible. Do not allow the belt to rest against hard or fragile objects. Do not route the belt across your neck, or run it across sharp edges. Be sure that the belt does not become caught or jammed. Avoid wearing loose or bulky clothing. You should remember to retension the lap belt periodically by pulling the shoulder strap to take up any slack in the mechanism. In the event of a frontal impact, a loose lap belt could slide over your hips, leading to abdominal injury. In addition, the safety belt's restraint effectiveness is reduced if the belt is worn loosely. Expectant mothers should always wear their safety belts, taking care to position the lap belt against the lower hips, where it will not exert pressure against the abdominal area. ◀

For information on using the safety belts, refer to page 48.

Seats

When adjusting your seat, always observe the following precautions

! Never try to adjust your seat while operating the vehicle. The seat could respond with unexpected movement, and the ensuing loss of vehicle control could lead to an accident. Never ride with the backrest reclined to an extreme horizontal angle. This is especially important for front passengers to remember. Keep the backrest relatively upright to minimize the risk of sliding under the safety belt and sustaining injury in an accident. ◀

Seat adjustment

- ▷ Manual seat adjustment, refer to page 45
- ▷ Power seat adjustment, refer to page 47
- ▷ Head restraint, refer to page 48.

Manual seat adjustment

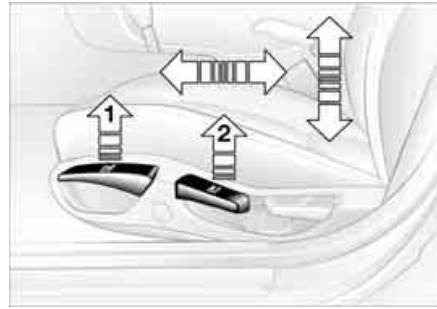

Seat adjustment

- 1 Backward/forward adjustment
Pull the lever and slide the seat to the desired position.
After you release the lever, move the seat forward or backward slightly so that it engages fully
- 2 Cushion height
Pull the lever and apply weight to or remove weight from the seat as required

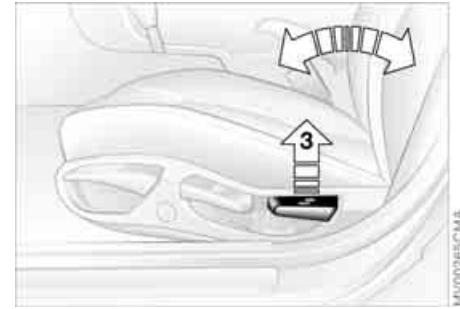

- 3 Backrest angle
Pull the lever and apply weight to or remove weight from the backrest as required

46 Manual seat adjustment

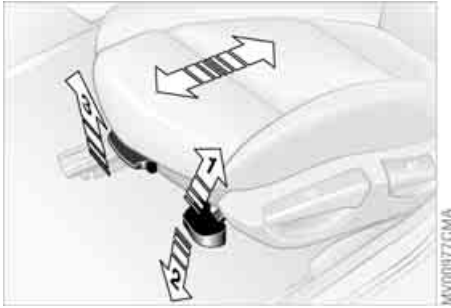

BMW sport seat* adjustment

You can also adjust the tilt angle and the thigh support:

1 To raise:

Pull the lever repeatedly, continuing until the seat is at the desired tilt angle

2 To lower:

Push the lever repeatedly, continuing until the seat is at the desired tilt angle

3 Thigh support:

Pull the lever and adjust the position of the thigh support for your personal comfort

Power seat adjustment*

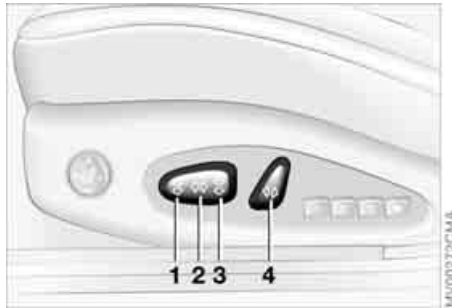

Seat adjustment

- 1 Tilt angle
- 2 Backward/forward adjustment
- 3 Cushion height
- 4 Backrest angle

The head restraint is adjusted manually, refer to page 48.

The thigh support and the head restraint are adjusted manually, refer to pages 46, 48.



Please refer to the adjustment instructions on page 45 to reduce the risk of personal injury. ◀

Lumbar support*

47



To adjust

You can adjust the backrest's contour for additional support in the curvature of your spine's lumbar region.

The upper hips and spinal column receive supplementary support to help you maintain a relaxed, upright posture.

- ▷ Press front/rear of switch: increase/decrease curvature
- ▷ Press the upper/lower end of the switch: increase the upper/lower curvature.

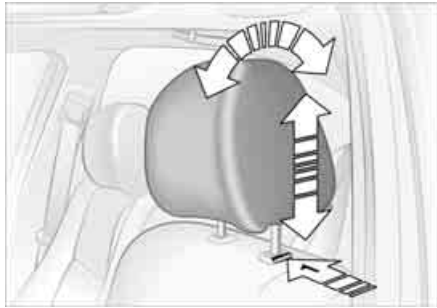

2. Press button – see arrow 1 – and remove the head restraint.

Installation – front

Slide the head restraint into its guides.

To adjust

To adjust height: pull the head restraint up or push it down.

-  Press button – see arrow 1 – to retract to the lowest position. ◀

To adjust tilt angle of front head restraints: tilt them to the desired angle.

-  You can reduce the risk of spinal injury and whiplash by adjusting the head restraint to a height at which it is centered roughly at ear level. ◀

Removal – front

1. Pull the head restraint up to the end of its travel



Always wear your safety belt

Always fasten your safety belt before starting off. As supplemental restraint devices, the airbags are designed to enhance the effectiveness of the safety belts, and not to replace them.

To close

Make sure you hear the lock engage in the belt buckle.

To release

1. Press the red button in the buckle
2. Hold the belt
3. Guide belt into its inertia reel.

Safety belts

 The rear belt buckle with the word CENTER is intended exclusively for the passenger sitting in the middle. ◀

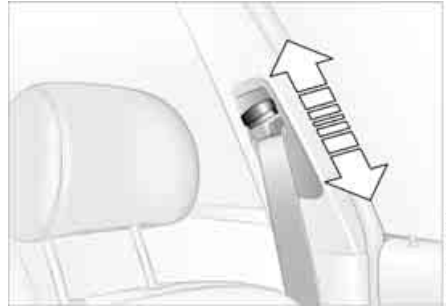

Adjusting safety belt height

Use the height adjustment mechanism to adapt the shoulder strap to the ideal level for your own body:

▷ Slide the button up or down.

Please refer to the seat adjustment instructions on page 44.

 If the safety belt system has been subjected to the stresses involved in an accident or otherwise damaged: have the entire safety belt mechanism replaced by your BMW center, including the safety belt tensioner. In addition, have your BMW center inspect the safety belt anchors. If a child-restraint system was in the vehicle during an accident, consult the manufacturer's instructions regarding replacement. ◀

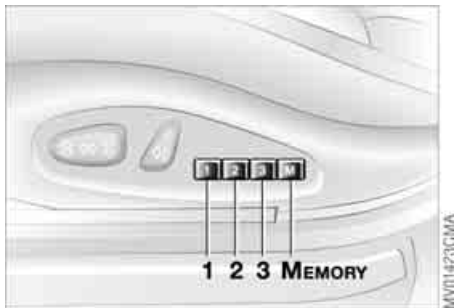

You can store as many as three different driver's seat and mirror adjustment settings into the system for later selection.



Memory will not retain the adjustment made to the lumbar support. ◀

To store

1. In ignition key position 1 or 2
2. Adjust the seat and door mirrors to the desired position
3. Press the MEMORY button: indicator lamp in the button comes on
4. Press memory button 1, 2 or 3, as desired: indicator lamp goes out.

To select a stored setting



Do not select a memory position while the vehicle is moving. If you do so, there is a risk of accident from unexpected seat movement. ◀

Ignition key in position 1:

- ▷ Briefly press memory button 1, 2 or 3, as desired. Movement stops immediately when one of the seat-adjustment or memory buttons is activated during the adjustment process.

The driver's door is closed and the ignition key is either removed or in position 0 or 2:

- ▷ Maintain pressure on the desired memory button – 1, 2 or 3 – until the adjustment process is completed.

If you press the MEMORY button accidentally: press the button again; the indicator lamp goes out.



Your BMW center can adjust your vehicle's systems in such a manner that your personalized settings are automatically set for the seat and exterior mirror positions when you unlock the vehicle with your personal remote control. ◀



Before activating the programmed adjustment feature, ensure that the footwell behind the driver's seat is empty and unobstructed. If you fail to do so, persons, animals or objects could be injured or damaged if the seat should move backward. ◀

Seat and mirror memory*

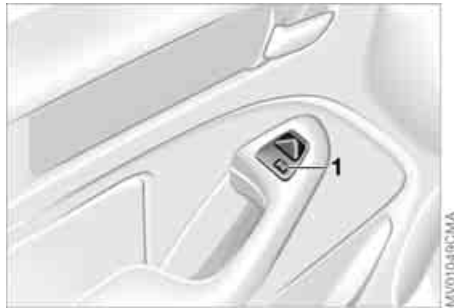

Passenger-side exterior mirror tilt function

Automatic curb monitor*

1. Set the mirror selection switch 1 to the driver's door mirror position
2. When shifting into Reverse or placing the selector lever in position R, the passenger-side mirror tilts downward to help the driver monitor the area directly adjacent to the vehicle during parking – curbs, etc.



How far the passenger mirror tilts can be set individually for each ignition key. ◀

You can deactivate this automatic feature by setting the mirror selection switch to the passenger side position.

Seat heating*

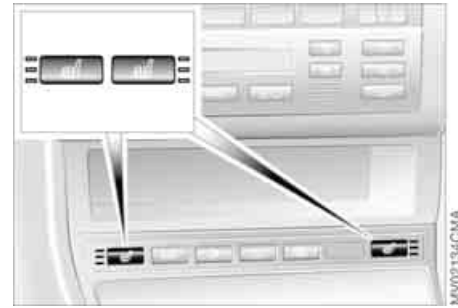



The seat cushion and backrest can be heated with the ignition key in position 2.

You can call up different heating modes by repeatedly pressing the button.

You can also switch the higher heating modes off directly:

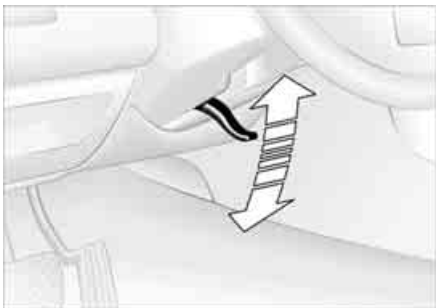
Press the button and hold it slightly longer.

**To adjust**

 Never attempt to adjust the steering wheel while driving the vehicle – it could respond with unexpected movement, posing a potential accident hazard. ◀

1. Fold down the detent lever
2. Adjust steering column reach and height for your selected seating position
3. Fold the detent lever back up to engage the lock.

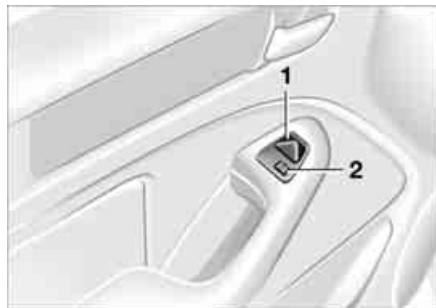
Mirrors**To adjust exterior mirrors**

- 1 Switch for 4-way adjustment
- 2 Selection switch for changing between mirrors

To adjust manually

You can also adjust the mirrors manually:

Press against the edges of the lens.

For storing mirror settings, refer to Seat and mirror memory on page 50.

 The mirror on the passenger's side features a lens with a more convex surface than the mirror installed on the driver's side. When estimating the distance between yourself and other traffic, bear in mind that the objects reflected in the mirror are closer than they appear. This means that estimations of the distance to following traffic should not be regarded as precise. ◀

Electric defrosting*

Both mirrors are automatically heated when you turn the ignition key to position 2.



Interior rearview mirror

To reduce glare from vehicles behind you when you are driving at night, tilt the mirror by turning the knob.

Vehicles not equipped with an alarm system:

Fold the small lever forward.



Interior rearview mirror with automatic dimming feature*

This mirror automatically responds to ambient light and headlamp glare from following vehicles by dimming through an infinitely variable range and automatically reverts to its clear, undimmed setting whenever you shift into Reverse or move the selector lever into position R.

To ensure that the mirror continues to operate efficiently, ensure that the area adjacent to the photocells remains clean and unobstructed. One photocell is integrated within the mirror's lens – see arrow – while the other is located at an offset position on the rear of the mir-

ror. Refrain from attaching stickers or other objects to the windshield in the area immediately behind the rearview mirror.

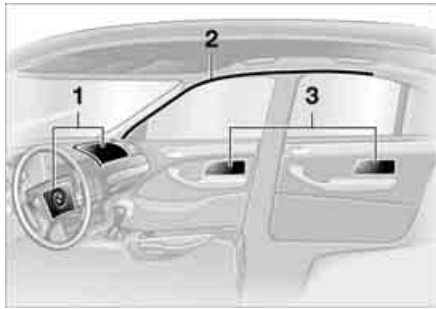

- 1 Front airbags on the driver and passenger sides
- 2 Head airbags for driver and front passenger
- 3 Side airbags on the driver and passenger sides – front and rear*

Protective effect

The front airbags supplement the three-point safety belts by providing additional protection in the event of a severe frontal collision in which the protection afforded by the belts alone may no longer be sufficient. The head and side airbags help provide protection in the event of a collision from the side. The respective side airbag helps support the seat occupant's upper body.

For information on the correct sitting posture, refer to page 44.

▶ The side airbags in the rear passenger area* of your vehicle may already have been deactivated by a BMW center. You may have them activated if you desire to do so. Please contact your BMW center for additional information. ◀

▶ The airbags do not deploy in response to minor collisions, rear impacts and certain kinds of vehicle rollover. ◀



Do not apply adhesive materials to the cover panels of the airbags, cover them or modify them in any other way. Do not remove the airbag restraint system. In the event of a malfunction, deactivation or triggered activation – as a response to an accident – of the airbag restraint system, consult your BMW center for inspection, repair or disassembly. Do not modify or tamper with either the wiring or the individual components in the airbag system. These include the upholstered covers on the steering wheel, instrument panel, side trim panels of the doors and front roof pillars and on the sides of the headliner. Also, do not attempt to remove the steering wheel. Unprofessional attempts to service the system could lead to failure in an emergency or undesired airbag activation, either of which could result in personal injury. Do not touch the individual components immediately after the system has been activated, as this could result in personal injury. ◀

Airbags



At all times, occupants should sit upright and be properly restrained – infants and small children in appropriate child-restraint systems; larger children and adults using the safety belts. Never let an occupant's head rest near or on a side airbag because the inflating airbag could cause a serious or fatal injury. Please note that the word Airbag imprinted on the door trim panel indicates the airbag's location.

Accident research shows that the safest place for children in an automobile is in the rear seat. However, a child sitting in the rear seat and not properly restrained may place his or her head on or near the airbag, if so equipped. For example, a child – even though belted in – may fall asleep with his or her head against the side airbag. It may be difficult for a driver to ensure that children in the rear seat will remain properly positioned at all times and not place their heads on or near the side airbag. Therefore, we recommend that the rear seat side airbags, if installed in the vehicle, be deactivated if children will travel in the rear seat.

The rear seat side airbags may already have been deactivated by a BMW center. If you are uncertain of their status, or wish to have the airbags activated or

deactivated, please contact your BMW center. ◀

Even when all these guidelines are followed, there is still a small residual risk of injuries to the face, hands and arms occurring from airbag deployment in isolated instances.

In sensitive individuals, the ignition and inflation noise may induce a mild hearing loss that is temporary in most cases.

Corresponding airbag warning labels are found on both sun visors.



This is the right way a child should sit in a child-restraint when rear side airbags are provided.



If there is a system malfunction, there is a risk that the airbags will not be triggered within their normal response range, even if the level of impact would normally have triggered them.

Have your BMW center inspect the airbag system immediately.

This is the right way a larger child should sit wearing the seat belt when rear side airbags are provided.

Indicator lamp



The indicator lamp indicates the operational status of the airbag system with the ignition key in position 1 or higher.

System operational:

- ▷ The indicator lamp comes on briefly when you turn the ignition key to position 1 or higher.

System malfunction:

- ▷ The indicator lamp does not come on or
- ▷ the indicator lamp lights up continuously.

Transporting children safely

Commercially available child-restraint systems are designed to be secured with a lap belt or with the lap belt portion of a combination lap/shoulder belt. Improperly or inadequately installed restraint systems can increase the risk of injury to children. Always read and follow the instructions that come with the system.

Correct location for installing

In your BMW, all seats equipped with a three-point safety belt – except for the driver's seat – are suitable for installing universal child-restraint systems of all age classes and which have been approved for the age group in question.

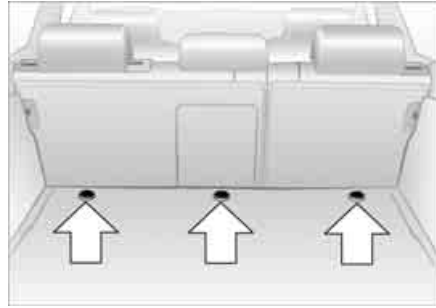

Child-restraint system with tether strap

If you use a child-restraint system with a tether strap, three additional tether anchorage points have been provided.

To gain access to this anchor fitting lift the plastic plug with the help of a screwdriver.

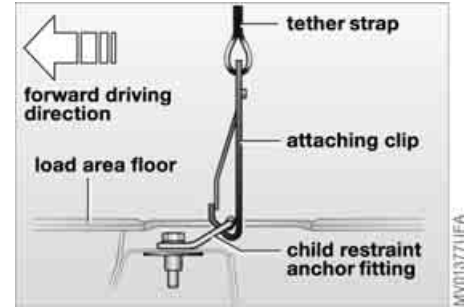

Depending on the location selected for seating in the rear passenger area, attach the tether strap to the corresponding anchorage point to secure the child-restraint system, as shown in the illustration.

If the respective seating position is fitted with a head restraint lift the head restraint and pass the tether strap between the head restraint and the seat back.

It is recommended to readjust the head restraint in the lowest possible position.

Adjust the tether strap according to the child-restraint manufacturer's instructions.



Before installing any child-restraint device or child seat, please read the following: Never install a rearward-facing child-restraint system in the front passenger seat of this vehicle. Your vehicle is equipped with an airbag supplemental restraint system for the front passenger. Because the backrest on any rearward-facing child-restraint system – of the kind designed for infants under 1 year and 20 lbs/9 kg – would be within the airbag's deployment range, you should never mount such a device in the front passenger seat, since the impact of the airbag against the child-restraint's backrest could lead to serious or fatal injuries. If it is necessary for a child – not an infant – to ride in the front seat, certain precautions should be taken. First, move the passenger seat as far away from the instrument panel as possible. This important precaution is intended to maximize the distance between the airbag and the child. Older children should be tightly secured with a safety belt after they have outgrown a booster seat that is appropriate for their age, height, and weight. Younger children should be secured in an appropriate forward-facing child-restraint system

that has first been properly secured with a safety belt.

Never install a rearward-facing child-restraint system in the front passenger seat.

We strongly urge you to carefully read and comply with the instructions for installation and use provided by the child-restraint's manufacturer whenever you use such a device. Do not attempt to modify child-restraint systems. If you do this, the protection provided by these systems could be impaired.

Be sure that all occupants – of all ages – remain properly and securely restrained at all times. ◀

All rear seating positions in your vehicle meet the recommendations of SAEJ1819, an industry-recommended practice for securing child-restraint systems in motor vehicles.



Securing child-restraint system

All of the rear belt retractors and the front passenger's safety belt can be locked for mounting and securing child-restraint systems.

A label with the appropriate instructions for this is located in the immediate vicinity of the buckle latch of each safety belt.

To lock the safety belt

Extract the entire length of the belt from the inertia reel mechanism. Allow the reel to retract the belt somewhat and engage the buckle, then tighten the belt against the child-restraint system. The retraction mechanism is now locked.

Transporting children safely

The belt cannot be extracted further. Always observe the installation instructions provided by the manufacturer of the child-restraint system.

To unlock the safety belt

Release the safety belt, remove the child seat and retract the safety belt to its end position on the belt retractor.

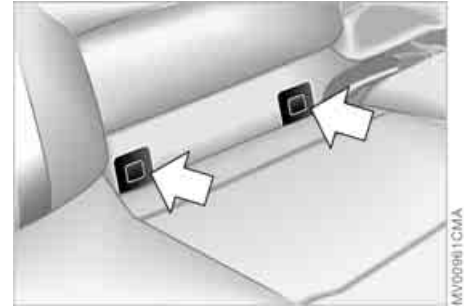
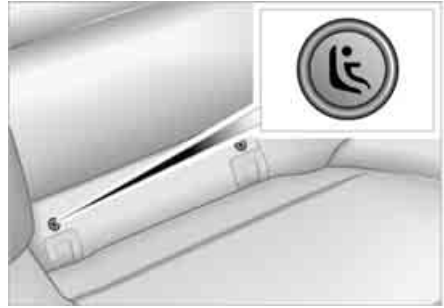

LATCH child-restraint mounting system

LATCH: Lower Anchors and Tethers for Children

The left and right rear seats are both equipped with a LATCH child-restraint mounting system.

Canadian models only:

The LATCH anchorage points are identified by buttons.

The illustration is an example showing the anchorages for a LATCH child seat system on the right rear seat.

The anchorages for the LATCH child seat system are concealed behind plastic covers that reclose when the LATCH child seat is removed.

 Always follow all manufacturer's instructions and observe all safety precautions when installing the LATCH child-restraint mounting system. ◀

60 **Transporting children safely**

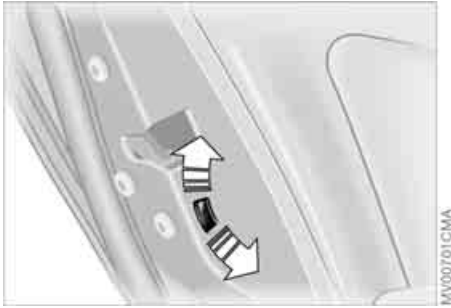

Child safety locks

Slide down the safety lever on the rear door:

The door can now be opened from the outside only.

Vehicle Memory, Key Memory

How the system functions

No doubt you have often reflected on how great it would be if you could permanently configure your vehicle's various features and adjustments to mirror your own personal preferences. In engineering your vehicle, BMW has included a number of options for storing personal adjustment data. These can be programmed at your BMW center.

The available configuration data fall into two categories, according to whether their primary orientation is the vehicle – Vehicle Memory – or the individual – Key Memory. Provided that each person has a separate remote-control key, you can have your BMW center enter basic adjustment data for up to four individuals in the system.

The system relies on a bilateral data exchange to identify the individual user and executes the selected settings whenever the remote control unit is used to disengage the locks.



Distinguishing between keys

Color-coded decals have been provided to help you distinguish the different keys with their individual settings.

What the system can do

You can learn about the entire array of features this system offers at your BMW center. Here are just a few examples:



You will see this symbol throughout the Owner's Manual. It is to remind you at appropriate places of the settings that are available to you. ◀

Examples for Vehicle Memory:

- ▷ Various signals as acknowledgment when locking or unlocking your vehicle, refer to pages 31, 34

- ▷ Activates/deactivates the 'Follow me home' function, refer to page 93
- ▷ Activates/deactivates daytime driving lamps, refer to page 93
- ▷ Sets the units of measure for displaying time, outside temperature, distance traveled and fuel consumption in the instrument cluster
- ▷ When you shift into Reverse, an acoustic signal indicates that PDC has been activated, refer to page 85
- ▷ Switches on rear window defroster automatically, to pages 98, 103
- ▷ Activates/deactivates various alarm system functions, refer to page 39
- ▷ After giving an ice warning, the onboard computer display returns to the previous setting, to page 83.

Examples for Key Memory:

- ▷ Locks the vehicle automatically after starting off, refer to page 35
- ▷ Unlocks the driver's door first, then the vehicle's remaining locks, refer to page 35
- ▷ Opens the tailgate instead of the rear window with the remote control, refer to page 32
- ▷ Automatically adjusts the driver's seat to the personal programmed settings when the vehicle is unlocked, refer to page 50

62 **Vehicle Memory, Key Memory**

- ▷ Determines how far the passenger mirror will tilt, refer to Automatic curb monitor, page [51](#).

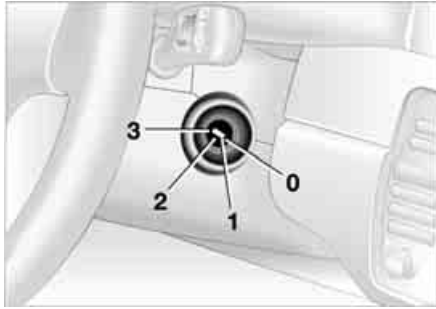

Ignition key positions

- 0 Steering locked
- 1 Steering unlocked
- 2 Ignition switched on
- 3 Starting engine

 Vehicles with automatic transmission:

Do not move the selector lever from position P until the engine is running, ignition key position 2.

Your vehicle is equipped with an interlock. Therefore, the ignition key cannot be turned to position 0 or removed until the selector lever is in position P. ◀

 Vehicles with manual transmission:

Step on the clutch when starting the vehicle. A lockout prevents the engine from starting if the clutch is not depressed. ◀

Steering locked

The key can only be inserted and removed in this position.

After removing the key, turn the steering wheel slightly to the left or right until the lock engages.

If the key is not removed, an acoustic signal is sounded after the driver's door has been opened.

Steering unlocked

You will find that it is often easier to turn the ignition key from position 0 to position 1 when you move the steering wheel slightly to help disengage the lock.

Individual electrical accessories are ready for operation.

 Do not allow the engine to warm up by leaving it running while the vehicle remains stationary. Instead, drive off immediately at a moderate engine speed. ◀

 Do not allow the engine to run in enclosed spaces. Otherwise, breathing the exhaust fumes can lead to unconsciousness and death. The exhaust gases contain carbon monoxide, an odorless and colorless, but highly toxic gas. Do not leave the vehicle unattended with the engine running. An unattended vehicle with a running engine represents a safety hazard. When driving, standing at idle or parking the vehicle, take care to avoid contact between the hot exhaust system and flammable materials – grass, hay, leaves, etc. Such contact could lead to a fire, resulting in serious personal injury and property damage. ◀

Start the engine. Do not press the accelerator pedal.

 Do not actuate the starter for too short a time, but do not actuate it for more than approx. 20 seconds. Release the ignition key immediately when the engine starts. ◀

64 Starting the engine

If the engine does not start on the first attempt – if it is very hot or cold, for instance:

- ▷ Press the accelerator pedal halfway down while engaging the starter.

Cold start at very low temperatures of under approx. +5 °F/–15 °C at high altitudes of over 3,300 ft/1,000 m:

- ▷ On the first start attempt, it may be necessary to engage the starter for a longer period, but no longer than 20 seconds
- ▷ Press the accelerator pedal halfway down while engaging the starter.

 Extended starting attempts, characterized by excessively frequent or long periods with the starter engaged, can damage the catalytic converter. ◀

Engine idle speed is controlled by the engine computer system. Increased speeds at start-up are normal and should decrease as the engine warms up. If engine speed does not decrease, service is required.

To prevent the battery from discharging, always deactivate electrical devices that are not in use. Switch the ignition off when the vehicle is not being driven.

Manual transmission

1. Engage the parking brake
2. Gearshift lever in idling position
3. Start the engine.

Automatic transmission

1. Depress footbrake
2. Place the selector lever in position P or N
3. Start the engine.

 To prevent the vehicle from starting off on its own, always move the selector lever to position P and engage the parking brake before leaving your vehicle with the engine running.

Do not leave the vehicle unattended with the engine running. An unattended vehicle with a running engine represents a safety hazard. ◀

Sequential manual gearbox SMG

1. Depress footbrake

2. Place the selector lever in neutral position N
3. Start the engine.

 If the engine does not start, reengage the gear last selected, refer to the gear indicator in the display, and move the selector lever into neutral position N again.

The gearbox is automatically taken out of gear if the driver's door is opened while the engine is running and the driver does not actuate the pedals, the shift paddles or the selector lever. This is accompanied by a warning tone and the flashing gear indicator. The gear display N appears in the instrument cluster. ◀

 Before exiting the vehicle with the engine running, move the selector lever into position N and apply the parking brake.

Do not leave the vehicle unattended with the engine running. An unattended vehicle with a running engine represents a safety hazard. ◀

Switching off the engine



You should never remove the ignition key when the vehicle is in motion, as the steering lock could engage.

When you leave the vehicle, always remove the ignition key and engage the steering lock.

Always engage the parking brake when parking on downhill roads. Engaging a gear may not sufficiently secure the vehicle against rolling. ◀

Manual transmission

Turn the ignition key to position 1 or 0.

Automatic transmission

Move the selector lever into position P, and turn the ignition key to position 1 or 0.

SMG gearbox

If you turn the ignition key to position 1 or 0 with the selector lever in position R, or in sequential mode, a gear automatically remains engaged.

If you turn the ignition key to position 1 or 0 with the selector lever in neutral position N, a warning tone and the flashing gear indicator in the display remind you that no gear is engaged to secure the vehicle against rolling.

The warning stops after approx. 9 seconds.

Parking brake

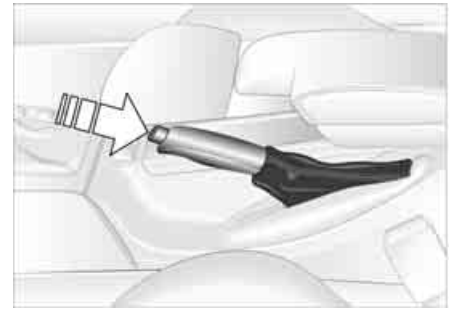

The parking brake is designed primarily to prevent the vehicle from rolling when it is parked. It operates against the rear wheels.

To engage

The detent engages automatically, and the indicator lamp in the instrument cluster comes on when the ignition key is in position 2, refer to page 18.

To release

Pull up slightly on the lever, press the button and lower the lever.

 If exceptional circumstances make it necessary to engage the parking brake while the vehicle is in motion, do not pull it with excessive pressure. Keep your thumb pressed against the release button while carefully pulling the lever up.

Excessive pressure can lead to over-braking and loss of traction – fishtailing – at the rear axle.

The brake lamps do not come on when the parking brake is engaged.

Vehicles with manual or SMG gearbox: Engage the parking brake when parking on downhill roads, since engaging a gear may not provide adequate resistance to rolling, not even in first or reverse gear.

Vehicles with automatic transmission: place the selector lever in P. ◀

 To avoid corrosion and one-sided braking, apply the parking brake lightly from time to time when coasting to a standstill – at a traffic signal, for example – provided that it is safe to do so. ◀

Manual transmission

 Do not hold the vehicle in place on slopes by slipping or 'riding' the clutch. Use the parking brake instead. Riding the clutch leads to severe and premature clutch wear. ◀

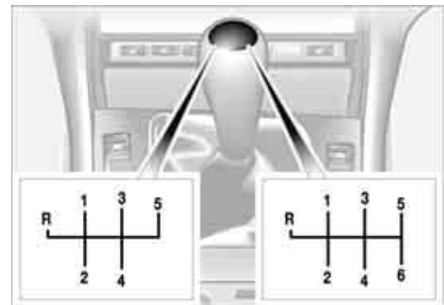

6-speed transmission*

When changing gear in the 5th/6th gear plane, be sure to press the gearshift lever to the right to prevent inadvertently shifting to a gear of the 3rd/4th gear plane.

Reverse

Select only when the vehicle is stationary. Press the shift lever to the left to overcome the resistance.

As you do this, the backup lamps will light up automatically when the ignition key is in position 2.

Sequential manual gearbox SMG*

The concept

The sequential manual gearbox SMG is an automated manual gearbox with which clutching and shifting is assumed by an electro-hydraulic system.

The SMG is operated via the selector lever in the center console and two shift paddles on the steering wheel.

It offers the following functions:

- ▷ Sequential mode: manual mode
- ▷ Drive mode: automatic operation
- ▷ Ability to choose between two different driving programs: Standard, Sport
- ▷ Operating safety through protection against misshifting
- ▷ Automatic upshifts and downshifts in the drive mode
- ▷ Automatic downshifts at minimum engine rpm
- ▷ Kickdown function in the drive mode.
- ▷ Acceleration assistant, refer to page 70.



Selector lever positions

The current selector lever position is indicated by a light-emitting diode in the center console.

R: Reverse

N: Neutral

Position for forward driving with one-touch functions:

Sequential mode

+ : manual upshifts

- : manual downshifts

D: drive mode.

The SMG is ready for operation in ignition key position 2.

▶ The gearbox is automatically placed in neutral gear if the driver's door is opened while the engine is running and the driver does not actuate the pedals, the shift paddles or the selector lever.

This is accompanied by an acoustic signal and the flashing gear indicator. The gear display N appears in the instrument cluster.

A driving position can only be engaged when the driver's door is closed. When the vehicle is unlocked, a buzzer in the area of the transmission indicates that the system is ready for operation. ◀

Shiftlock

When the car is at a standstill, a safety function requires you to depress the brake pedal if you want to move the selector lever from the neutral position N to a driving position.

Driving precautions

⚠ Use enough acceleration to pull away speedily when moving off on an uphill gradient. Never try to prevent the car from rolling back on an uphill gradient by depressing the accelerator pedal; always apply the handbrake. Otherwise you could overheat the SMG gearbox. ◀

R Reverse

Select only when the vehicle is stationary.

N Neutral

Always engage before starting the engine, refer to Starting the engine on page 64.

Sequential mode

Each time the engine is started, the sequential mode is activated as soon as you move the selector lever into the forward driving position while the brake is depressed.

The gears are shifted via the shift paddles or the selector lever.

It is also possible to drive off in second gear, e.g. on snow-covered roads.

D Drive mode

In the drive mode all forward gears are shifted automatically.

To switch from sequential to drive mode: tap the selector lever to the right toward D.

For rapid acceleration, e.g. during passing, depress the accelerator pedal completely: kickdown.

To switch back to sequential mode: tap the selector lever again to the right toward D or change the current gear via the shift paddles or the selector lever.

Kickdown

You can achieve maximum acceleration using kickdown.

Depress the accelerator pedal past the increased resistance point at the full-throttle position.



Shifting gears

With selector lever:

- ▷ To upshift, tap the selector lever toward +
- ▷ To downshift, tap the lever toward –.

With shift paddles on steering wheel:

- ▷ To upshift, pull one of the shift paddles
- ▷ To downshift, push the paddle.

You accelerate from higher gears, e.g. during passing, by manually downshifting.

In the following situations, the SMG in the sequential mode assists you:

- ▷ The transmission will only execute upshifts and downshifts that will result in an appropriate combination of vehicle speed and engine rpm. For

instance, downshifts that would result in excessive engine speed cannot be executed

- ▷ When you brake the car to a stop, the transmission automatically shifts down to first gear
- ▷ As speed diminishes, the transmission will shift down automatically, without any action on your part, just before the vehicle slows to below each gear's minimum speed.



For information on jump-starting and towing the vehicle, refer to page 153.

Warning tone

An acoustic signal sounds if the SMG gearbox overheats; if possible you should either stop or increase your pull-away speed so that the system can cool down.

Available displays

R N 1 2 3 4 5 6

D1 D2 D3 D4 D5 D6

The currently engaged gear, the selected mode, and any malfunctions are displayed in the instrument cluster.

Indicator lamp



If the indicator lamp comes on, there is a malfunction in the transmission system.

All selector lever positions can still be engaged, but in the forward driving positions only certain gears are actually available when the vehicle is driven.

Avoid extreme loads and proceed to the nearest BMW center.

70 Sequential manual gearbox SMG*



1. Activate the Sport program
2. Press and hold the DSC button, refer to page 86, for more than three seconds
3. Quickly press the accelerator pedal down fully: kickdown. The optimum rpm for driving off will be adjusted.

 To maintain vehicle stability, always drive with the DSC activated whenever possible. ◀

Sport program

You can choose between two driving programs: smoothly dynamic or Sport. With the Sport program, gearshifts are faster in sequential mode and the shift points are adapted in drive mode.

To activate the Sport program: press the SPORT button. The LED in the button lights up.

Acceleration assistant

The acceleration assistant permits optimum racing-style acceleration on roads with good grip.

 Do not use the acceleration assistant frequently as this could otherwise cause premature wear of the components. ◀

You can drive as with a normal automatic transmission. In addition, you can also shift manually.

When you move the selector lever from the D position to the left into the M/S range, the performance-oriented shift programs of the automatic transmission are engaged. Steptronic enters the manual selection mode and executes the desired shift whenever you tap the selector lever in the direction indicated by + or -. Whenever you want to use automatic again, just move the selector lever toward the right to position D. Under normal operating conditions, fuel consumption is lowest when driving in position D.



Selector lever positions

P R N D M/S + -

Starting the engine

The engine can only be started in selector lever positions P – for Park – or N – for Neutral.

Range selection

A catch prevents inadvertent movement of the selector lever to positions R and P. To deactivate the catch, press the button on the front of the selector lever knob, see arrow.

 While the vehicle is stationary and before shifting out of Park or Neutral, depress the footbrake in order to disengage the selector lever's lock mechanism – Shiftlock. ◀

 Hold the footbrake down until starting off. The vehicle will otherwise 'creep' when a drive position is engaged. To prevent the vehicle from starting off on its own, always move the selector lever to position P and engage the parking brake before leaving your vehicle with the engine running. Do not leave the vehicle unattended with the engine running. An unattended vehicle with a running engine represents a safety hazard. ◀

P Park

Select only when the vehicle is stationary. Transmission locks to prevent rear wheels from turning.

R Reverse

Select only when the vehicle is stationary.

N Neutral

Select only when stopping for an extended period.

D Drive – automatic shift program

This position is designed for driving under all normal operating conditions. All forward gears are available.

Kickdown

In the kickdown mode, you achieve maximum acceleration and top speed in position D.

Depress the accelerator pedal past the increased resistance point at the full-throttle position.



AV000941CMA

M/S manual operation and Sport program

Move the selector lever from D to M/S to activate the Sport program; SD appears in the display panel. The M/S mode is recommended for performance-oriented driving.

Once in the M/S mode, you can tap the selector lever to switch the automatic transmission from the Sport program to its manual mode.

This mode allows you to execute upshifts manually by tapping the lever toward +, while downshifts are selected by tapping in the – direction. The displays M1 through M5 appear in the display panel to indicate your current gear selection.

The transmission will only execute upshifts and downshifts that will result in an appropriate combination of vehicle speed and engine rpm. For instance, downshifts that would result in excessive engine speed are not executed. The desired, then the actual gear, briefly appear in the instrument cluster.



To accelerate quickly in the manual mode for maneuvers such as passing another vehicle, shift down manually or employ the kickdown mode. ◀

Shifting from M/S to the selector lever positions P, R and N is possible only by going through D.

Automatic transmission with Steptronic*



If the indicator lamp does not go out, you can place the selector lever in all positions. However, the vehicle will now only operate in 3rd and 4th gear.

If this happens, avoid extreme engine loads and consult the nearest authorized BMW center.



Never work in the engine compartment when a drive gear – forward or reverse – is engaged. If you do this, the vehicle could move. ◀

Available displays

P R N D SD M1 M2 M3 M4 M5

Electronic transmission control module



If the indicator lamp comes on, there is a malfunction in the transmission system.

Bring the vehicle to a stop. Move the transmission selector lever to P. Set the parking brake and turn the engine off – ignition key to position 0.

Wait a few seconds, then start the engine.

If the indicator lamp goes out after a few seconds, normal transmission performance has been restored. You may continue to drive as usual.

For towing or jump-starting, refer to the information beginning on page [153](#).

74 Turn signal indicator/Headlamp flasher

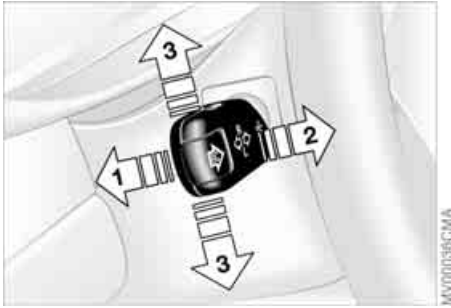

- 1 High beams – blue indicator lamp
- 2 Headlamp flasher – blue indicator lamp
- 3 Turn signal indicator – green indicator lamps accompanied by a periodic clicking sound from the relay

To signal briefly

Press the lever up to but not beyond the resistance point. It then returns to the center position when released.

 If the flashing indicator lamp and the clicking from the relay are both faster than normal, one of the turn signal indicators has failed. ◀



- 0 Wipers retracted
- 1 Intermittent operation or rain sensor
- 2 Normal wiper speed
- 3 Fast wiper speed
- 4 Brief wipe
- 5 Rotary dial for control of the wipe interval or the sensitivity of the rain sensor

Intermittent mode

Not on vehicles with rain sensor.

You can set the wipe interval at four stages with rotary dial 5.

In addition, the wipe interval is varied automatically depending on road speed.

Rain sensor

The rain sensor is positioned on the windshield, directly behind the interior rearview mirror.

To activate the rain sensor:

- ▷ With the ignition key in position 1 or higher, move the lever to position 1. The wipers will make at least one sweep across the windshield. You can leave the lever permanently in position 1. With the ignition key in position 1 or higher, all you then need to do to activate the rain sensor is
 - ▷ briefly turn the rotary dial 5, or
 - ▷ clean the windshield 1, refer to page 76.

To adjust the sensitivity of the rain sensor: turn rotary dial 5.

To deactivate the rain sensor: put lever in position 0.



Turn the rain sensor off in automatic car washes. Failure to do so could result in damage caused by undesired wiper activation. ◀

Normal wiper speed

When the vehicle is stationary, the wipers switch automatically to intermittent wipe – not on vehicles with rain sensor.

Fast wiper speed

When the vehicle is stationary, the wipers revert to operation at normal speed – not on vehicles with rain sensor.

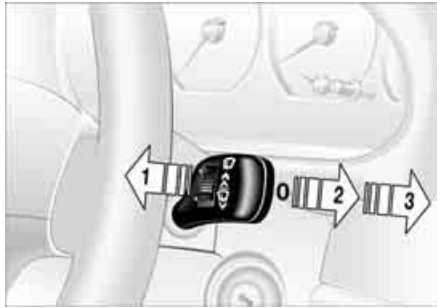

Cleaning windshield and headlamps*

- 0 Wipers retracted
- 1 Clean windshield and headlamps
- 2 Rear window wiper intermittent mode
- 3 Clean the rear window



Do not use the washers if there is any danger that the fluid will freeze on the windshield, as your vision could be obscured. Always use a windshield washer antifreeze in cold weather. Refer to page 132. Do not use the washers when the reservoir is empty. This could cause damage to the washer pump. ◀

The system sprays washer fluid against the windshield and activates the wipers for a brief period. When the vehicle's lighting system is switched on, the headlamps will also be cleaned at reasonable intervals.

Rear window wiper

Rear window wiper in intermittent mode. When reverse gear is engaged, continuous operation is switched on automatically.

You can also program the interval:

- ▷ Briefly move the wiper lever from position 0 to position 2
- ▷ The period that elapses until the wipers again start to move – from position 0 to 2 – is the programmed interval for intermittent operation – max. 30 seconds.

Cleaning the rear window

The system sprays washer fluid onto the rear window.

To change the wiper blades refer to page 142.

Windshield washer nozzles

The windshield washer nozzles are heated automatically* when the ignition key is in position 2.

Cruise control*

Starting at about 20 mph / 30 km/h, you can maintain and store any vehicle speed that you specify.

The cruise control is operational whenever the engine is running and the system has been activated.

To activate the system

I/O

In ignition key position 2: press the button in the steering wheel. The indicator lamp in the instrument cluster comes on, refer to page 20. You can now use the cruise control.



Do not use cruise control on twisting roads, when high traffic density prevents driving at a constant speed, or when the road surface is slick – snow, rain, ice – or loose – rocks or gravel, sand. ◀

To deactivate the system

I/O

Press button as often as you need to until the indicator lamp in the instrument cluster goes out.

Cruise control is also deactivated when the ignition key is in position 0.

The speed stored in memory is deleted.

To store and maintain speed or to accelerate



Press button + briefly:

The system stores and maintains the current vehicle speed. Every time you tap the button, the speed increases by approx. 0.6 mph / 1 km/h.

Press and hold button +:

The vehicle accelerates without pressure on the accelerator pedal. When you release the button, the system stores and maintains the current speed.



If on a downhill gradient the engine braking effect is not sufficient, the controlled speed can be exceeded. Speed can drop on uphill grades if the engine output is insufficient. ◀

To decelerate



Press button – briefly:

When cruise control is active, every tap of the button reduces the speed by approx. 0.6 mph / 1 km/h.

Press and hold button –:

With the cruise control active, the system automatically reduces the throttle opening to slow the vehicle. When you release the button, the system stores and maintains the current speed.

To interrupt the cruise control

I/O

When the system is activated, press the button. The indicator lamp stays on. You can use the cruise control again whenever you want by calling up the speed that was stored last.

In addition, cruise control is interrupted automatically:

- ▷ When the brakes are applied
- ▷ When you apply pressure to the clutch pedal, or when you move the automatic transmission selector lever from D to N
- ▷ If you exceed or fall below the preset speed for an extended period – by depressing the accelerator, for example.

78 **Cruise control***

To recall the stored setting



Press button:

The vehicle accelerates to and maintains the last speed stored.



- 1 Odometer
- 2 Trip odometer

Odometer

You can activate the displays shown in the illustration with the ignition key in position 0 by pressing the left button in the instrument cluster.

Trip odometer

To reset the trip odometer to zero, press the left button with the ignition key in position 1 or higher.



Do not operate the engine with the needle in the red overspeed zone of the gauge.

To protect the engine, the fuel supply is interrupted when you approach this sector.



Indicates the current fuel consumption in mpg – in liters/100 km on Canadian models. You can check your current driving style to see whether it is conducive to economy and minimum exhaust emissions.

When the vehicle is stationary, the display goes to Maximum – zero on Canadian models.



Once the indicator lamp stays on continuously, there are still approx. 2 gallons/8 liters of fuel in the fuel tank. Fuel tank capacity approx. 16.6 gallons/63 liters

Certain operating conditions, such as those encountered in mountainous areas, may cause the needle to fluctuate slightly.

⚠ Fill the fuel tank before it is completely empty. Driving to the last drop of fuel can prevent the engine from operating properly and result in damage. ◀

When you switch on the ignition, the indicator lamp lights up briefly as an operation check.



To check coolant level, refer to page 134.

Blue

The engine is still cold. Drive at moderate engine and vehicle speeds.

Between the blue and red zones

Normal operating temperature. The needle may rise as far as the edge of the red sector in normal operation.

Red

When you switch on the ignition, the warning lamp comes on briefly to confirm that the system is operational.

If the lamp comes on during normal vehicle operation: the engine has overheated. Switch off the engine immediately and allow it to cool down.

Service interval display



A flashing message and a "-" in front of the number mean that the service interval has already been exceeded by the distance shown on the display. Please contact your BMW center for an appointment.

Remaining distance to service

The displays shown in the illustration appear for a few seconds when the ignition key is in position 1 or higher or after the engine is started.

The next service due appears with the message OIL SERVICE or INSPECTION, together with the distance remaining in miles – in kilometers in Canada – before the next scheduled service.

The computer bases its calculations of the remaining distance on the preceding driving style.

Check Control

81

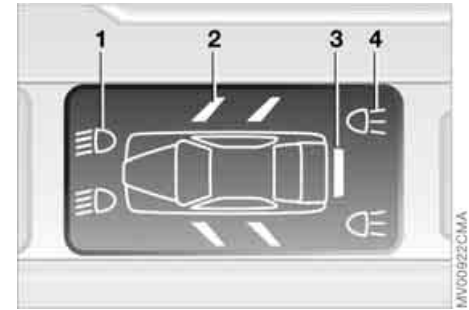

When the ignition key is in position 2, the following information and/or conditions are indicated using symbols until the conditions have been corrected.

- 1 Check the low beams and high beams, as well as the parking lamps
- 2 Door open
- 3 Tailgate open
- 4 Check brake and tail lamps

When you open the driver's door, after having turned the ignition key to position 0, you will hear an acoustic signal for a few seconds to remind you that the lamps have not been switched off.

82 Clock

If you wish to have a permanent time display, you can make this setting in the radio display, refer to the Owner's Manual for Radio.

You can set the clock and the time display in the car radio as follows.



Every time you press the button, the clock display alternates between the 12-hour or 24-hour mode.

In ignition key position 0: the time is displayed for a few seconds after you press the left button, refer to Odometer on page 79.

Setting



Before the clock can be set, the time must be showing in the instrument cluster display. ◀

With the ignition key in position 1 or higher

To set ahead: turn the right button to the right.

To set back: turn the right button to the left.

The adjustment speed will increase the longer you continue to hold the right button.

To change the display mode: press the right button briefly.

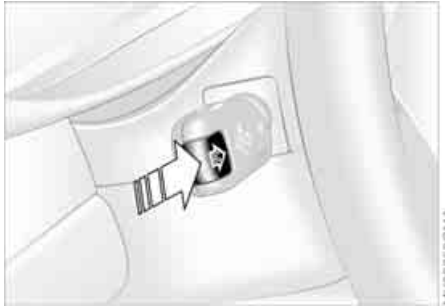

After giving an ice warning, the display returns to the previous setting. ◀



The ice warning does not alter the fact that surface ice can form at temperatures above 37.5 °F/+3 °C, on bridges or shaded road surfaces, for instance. ◀

Mode selection

With the ignition key in position 1 or higher, you can call up information from the computer using the button in the turn signal lever. By pressing the button briefly toward the steering column, you can call up a new function for display.

The displays appear in the following order:

Time of day, outside temperature, average fuel consumption, cruising range, average vehicle speed.

With the ignition key in position 1 or higher, the last active setting is displayed.

Outside temperature

You can change the units of measure °C/°F for the outside temperature display by pressing the right-hand reset button in the instrument cluster while the temperature display is active. The units of measure °C/°F in the temperature display of the automatic climate control change automatically, refer to page 100.

Ice warning

If the outside temperature drops to about 37.5 °F/+3 °C, then the computer will automatically switch to a display of the outside temperature. In addition, a signal sounds as a warning and the display flashes for a brief period.



 It is important that you refuel when the cruising range falls below approx. 35 miles/50 kilometers. Otherwise, the engine cannot be guaranteed to operate properly and damage may result. ◀

Average speed

If you continue to hold the button on the turn signal lever, the average speed being displayed is recalculated from that point in time.

Any time spent when the vehicle is stationary and the engine is switched off is ignored for the calculation.

Average fuel consumption

If you continue to hold the button on the turn signal lever, the average fuel consumption last displayed is recalculated from that point in time.

 If you wish, you can have the average fuel consumption displayed in a different unit of measure. ◀

Range

The computer bases its calculations for the cruising range on operating conditions in the preceding period and on the remaining fuel in the tank.

Park Distance Control (PDC)*

The concept

PDC assists you when you back into a parking space. Acoustic signals alert you to the momentary distance to an object behind your vehicle. The system features four ultrasonic sensors mounted in your rear bumper. The monitoring range for the two corner sensors extends outward roughly 2 ft/60 cm, while two centrally located sensors detect objects at distances of up to approx. 5 ft/1.50 m.

 PDC is a parking aid that can identify objects if they are approached slowly, as is generally the case when parking. Avoid driving towards objects rapidly; due to underlying physical principles, the system may otherwise alert you too late for you to take evasive steps. ◀

The system starts to operate automatically approx. one second after you shift into Reverse or move the selector lever into the R position with the ignition key in position 2.

 Let this short period elapse before driving backwards. ◀

PDC is deactivated when you shift back out of reverse.



You can have a signal set to confirm that the PDC has been activated. The signal then sounds when you shift into Reverse or move the selector lever into the R position. ◀

Acoustic signals

The distance to the nearest object is indicated by a tone sounding at various intervals. As the distance between vehicle and object decreases, the intervals between the tones become shorter. A continuous tone indicates the presence of an object less than 1 ft/30 cm away.

The warning signal is canceled after approx. three seconds if the distance to the object remains constant during this time – if you are moving parallel to a wall, for instance.

System malfunctions will be indicated by a continuous high-pitched tone when the system is activated the first time. Please refer the problem to your BMW center.



PDC does not remove the driver's personal responsibility for evaluating the distance between the vehicle and any objects. Even when sensors are involved, there is a blind spot in which objects cannot be detected. This applies especially in those cases where the system approaches the physical limits of ultrasonic measurement, as occurs with tow bars and trailer couplings, and in the vicinity of thin or wedge-shaped objects. Moreover, low objects that have already been detected – such as a curb edge – can disappear out of the detection range of the sensors before a continuous tone sounds.

Loud sources of sound from outside or inside the vehicle could drown out the PDC signal tone. ◀



Keep the sensors clean and free of ice or snow in order to ensure that they will continue to operate effectively.

Do not apply high pressure spray to the sensors for a prolonged period of time. Always maintain a distance of more than 4 in/10 cm. ◀

The concept

DSC maintains vehicle stability, even in critical driving situations.

DSC is operational every time you start the engine.

DSC incorporates the Dynamic Traction Control (DTC) and Cornering Brake Control (CBC) functions.

For information on vehicles with all-wheel drive, refer to page 88 ff.

The vehicle will remain completely operational, however, without DSC. In the event of a fault, please consult your BMW center.



Indicator and warning lamp for Canadian models.



Indicator lamps



The indicator lamp in the instrument cluster goes out shortly after you switch on the ignition, refer to page 19.

- ▷ The indicator lamp flashes: DSC controls the drive and braking forces
- ▷ The indicator lamp stays lit: DSC has been switched off with the button; DTC and DBC are operational. DTC control intervention is not indicated.



The indicator lamp and the brake warning lamp continuously light up in yellow:



The DSC, DTC and DBC have been switched off manually or there is a system malfunction.



Deactivating the DSC/activating the DTC

Press the DSC button briefly, the indicator lamp comes on and remains lit.

DSC is deactivated; DTC is operational.

In the following rare situations, it may prove useful to activate the DTC for a brief period:

- ▷ When rocking the vehicle or starting off in deep snow or on loose surfaces
- ▷ When driving on snow-covered grades, in deep snow, or on a snow-covered surface that has been packed down from being driven on
- ▷ When driving with snow chains.

Traction is increased by deactivating the control systems that enhance traction under normal conditions.

Dynamic Stability Control (DSC)

Deactivating the DSC and the DTC

Hold the DSC button down for at least 3 seconds. The indicator lamp and the yellow brake warning lamp will remain on continuously.

The systems for enhancing stability and traction are deactivated, and there is no active braking intervention or torque control.



To maintain vehicle stability, always drive with the DSC activated whenever possible. ◀

Reactivating the DSC

Press the button again briefly; the indicator lamp or the indicator lamps will go out. DTC is deactivated.



The laws of physics cannot be repealed, even with DSC. It will always be the driver's responsibility to drive in a manner that matches road conditions. This is why you should not use the additional safety margin the system provides as an excuse to take risks.

Whenever the DTC is activated, the DSC is switched off and performs minor stabilizing intervention.

Do not make any modifications to the DSC system. Allow only authorized technicians to perform service procedures on the DSC. ◀

The concept

DSC maintains vehicle stability, even in critical driving situations.

DSC is operational every time you start the engine.

DSC incorporates the Automatic Differential Brake (ADB-X) and Cornering Brake Control (CBC) functions.

Indicator lamps



The indicator lamp in the instrument cluster goes out shortly after you switch on the ignition, refer to page 19.

- ▷ The indicator lamp flashes: DSC controls the drive and braking forces
- ▷ The indicator lamp stays lit: DSC has been switched off with the button; ADB-X is operational. ADB-X control intervention is not indicated.



If the indicator lamp fails to go out when you press the DSC button again, this indicates a malfunction in the DSC and ADB-X systems; the stability enhancement functions are no longer available. ◀

The vehicle will remain completely operational, however, without DSC. In the event of a fault, please consult your BMW center.



To deactivate DSC

Press the DSC button; the indicator lamp comes on and remains lit.

DSC is switched off, and ADB-X reverts to its maximum torque-transfer mode.

In the following rare situations, it may be effective to deactivate the DSC for a brief period:

- ▷ When rocking the vehicle or starting off in deep snow or on loose surfaces
- ▷ When driving with snow chains.



To maintain vehicle stability, always drive with the DSC activated whenever possible. ◀

Dynamic Stability Control (DSC) – 325xi

Reactivating the DSC

Press the button again; the indicator lamp goes out.



The laws of physics cannot be repealed, even with DSC. It will always be the driver's responsibility to drive in a manner that matches road conditions. This is why you should not use the additional safety margin the system provides as an excuse to take risks.

The system does not intervene to enhance vehicle stability when switched off.

Do not make any modifications to the DSC system. Allow only authorized technicians to perform service procedures on the DSC. ◀

The concept

By reducing the vehicle's speed on steep downhill stretches, HDC maintains predictable vehicle handling response to provide you with control of your BMW during extreme descents.

The vehicle slows to a pace just slightly faster than walking speed.

HDC is available for activation at vehicle speeds below approx. 22 mph / 35 km/h. When driving down steep hills, the vehicle reduces speed automatically down to about double walking speed – approx. 7.5 mph / 12 km/h – and then maintains this speed at a constant.

You can use the accelerator or brakes to vary this speed within a range from approx. 3 mph / 5 km/h to approx. 15 mph / 25 km/h.

In conjunction with the multifunction steering wheel you can use the +/- button to set the cruise control to a target speed in the range from approx. 3 mph / 5 km/h to approx. 15 mph / 25 km/h.

HDC is automatically deactivated once vehicle speed again exceeds approx. 37 mph / 60 km/h.

**To activate the system**

Press the HDC button; the green indicator lamp integrated within the button comes on.

The indicator lamp flashes whenever the system is actively intervening to control your speed with automatic brake applications.

To deactivate the system

Press the button again, the indicator lamp goes out.

HDC is automatically deactivated once the vehicle accelerates to more than 37 mph / 60 km/h, as well as whenever you switch off the ignition.

To use HDC

With manual transmission:

You should always ensure that either reverse or first gear is engaged before using HDC, as the engine's braking effect is most pronounced in these gears, and only reduced engine braking is available in higher gears.

With automatic transmission: HDC is available for use in all ranges.

System malfunctions

Signaled by the indicator lamp, which responds to problems by going out while HDC is in operation or by failing to come on when you activate the system:

HDC is temporarily not available if brake temperature is too high.



If the DSC indicator lamp comes on at the same time:

There is a fault in the HDC and DSC systems. Have your BMW center inspect this system as soon as possible.

Flat Tire Monitor*

The concept

As you drive, the Flat Tire Monitor keeps track of pressure levels in all four tires. The system alerts you whenever the inflation pressure of a tire falls significantly below the pressure of another tire.

The system actually detects pressure loss by monitoring differences in the relative speeds of the four wheels. It interprets variations outside specified limits as severe pressure loss, and then responds by generating a warning.

Functional requirements

In order for the Flat Tire Monitor to learn the correct tire inflation pressure, please do the following:

1. Check the tire inflation pressures in all tires
2. Compare them with the tire inflation pressure table on page 26 and correct them, if necessary
3. Initialize the system.

System limitations

 The Flat Tire Monitor cannot provide you with advance warning of sudden and severe tire damage caused by external factors and does not detect the balanced and very gradual pressure loss that takes place in all four tires over an extended period of time. ◀

On the other hand, the following situations can lead to a delayed detection of pressure loss and even to the system not functioning:

- ▷ Driving on snow-covered or slippery roads
- ▷ Performance-oriented driving: slip at the drive wheels, high levels of lateral acceleration
- ▷ When driving with snow chains, false warnings and undetected pressure losses may occur
- ▷ When driving with a space-saver spare tire, the Flat Tire Monitor cannot function.



Initializing the system

 Each time you correct the pressure in a tire, or change a wheel or tire, reinitialize the system immediately afterwards. This requires a bit of driving. ◀

1. Before driving off, start the engine but do not start driving
2. Press the button as long as you need to until the yellow indicator lamp in the instrument cluster lights up for a few seconds
3. Drive off.

It takes a few minutes before the Flat Tire Monitor can detect a flat tire and issue a warning.

 When driving with snow chains or a space-saver spare tire, do not initialize the system. ◀

Flat tire

 The indicator lamp in the instrument cluster lights up red. This visual alert is accompanied by an acoustic warning signal.

1. Carefully reduce speed and come to a stop. Avoid sudden braking and steering maneuvers
2. Determine which wheel is damaged

 If this cannot be determined, contact your BMW center. ◀

3. Replace the damaged wheel, refer to Changing a wheel on page 147.

After replacing the damaged tire, initialize the system.

Vehicles with Run Flat tires:

1. Carefully reduce your speed to under 50 mph / 80 km/h. Avoid strong braking and steering maneuvers. Do not exceed a speed of 50 mph / 80 km/h.

 Because the sides of Run Flat tires are reinforced, a drop in inflation pressure usually cannot be detected from the outside, refer to Run Flat tires, page 150. ◀

2. To continue driving, follow the instructions under Driving with a damaged tire on page 151.

System malfunction

 The indicator lamp in the instrument cluster lights up yellow. The Flat Tire Monitor is malfunctioning or out of order. Please refer the problem to your BMW center.

Brake force display

The brake force display indicates to the driver of the vehicle behind you how hard you are braking your vehicle.

The display has two levels:

- ▷ Normal braking: the brake lamps among the rear lamps and the center brake lamp light up
- ▷ Hard braking or use of ABS: the tail lamps light up with the same brightness as the brake lamps and thereby intensify the visual effect of the brake lamps.

Parking lamps/Low beams

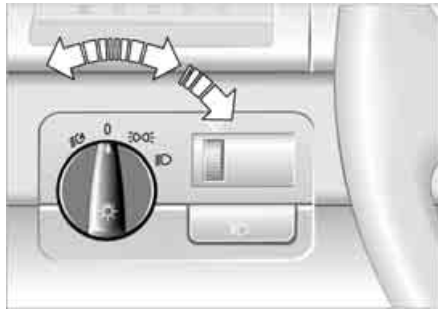

Parking lamps

 The front, rear and side vehicle lighting is switched on. You can use the parking lamps to signal the position of the vehicle when it is parked. For lighting on one side for parking as an additional feature, refer to page 94.

Low beams

 When the ignition is switched off while the low beams are on, the headlamps go out and only the parking lamps remain on.

Follow me home lamps

When you activate the headlamp flasher after parking the vehicle with the lamps turned off, the low-beam headlamps will come on for a short time.

 You can also have this function deactivated. ◀

LIGHTS ON warning

When you open the driver's door, after having turned the ignition key to position 0, you will hear an acoustic signal for a few seconds to remind you that the lamps have not been switched off.

Daytime driving lamps*

If you desire, the lamp switch can be left in the second position: when the ignition is switched off, the external lighting is also switched off.

 You can have the activation settings for the daytime driving lamps programmed on your vehicle. ◀

Automatic headlight control*

 When the switch is set to this position the system automatically activates and cancels the low beams in response to changes in ambient light – in tunnels, at dusk, etc. – and in the event of rain and snow.

 The vehicle's external lights remain on constantly when you switch on the front fog lamps after the headlights have come on automatically. ◀

 Automatic headlight control cannot serve as a substitute for the driver's judgement in determining when the vehicle lights should be switched on. For example, the sensors are not able to detect fog. To avoid safety risks, you should respond to these kinds of low-visibility situations by switching the headlights on manually. ◀

 You can have the sensitivity of your vehicle's automatic headlight control adjusted. ◀

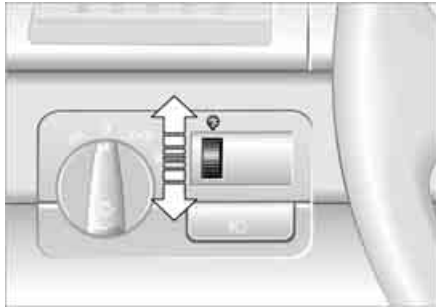

Turn the rotary dial to adjust the illumination intensity.

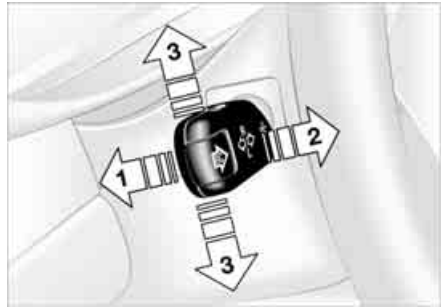

- 1 High beams – blue indicator lamp
- 2 Headlamp flasher – blue indicator lamp
- 3 Standing lamps

Standing lamps, left or right

As an additional feature, you can illuminate your vehicle on either side for parking:

In ignition key position 0, engage the lever in the appropriate turn-signal position.

Fog lamps*



Front fog lamps



The green indicator lamp in the instrument cluster lights up to indicate that the front fog lamps are on.



If the automatic headlight control is on, the low beams will come on automatically whenever you activate the front fog lamps. ◀

Interior lamps

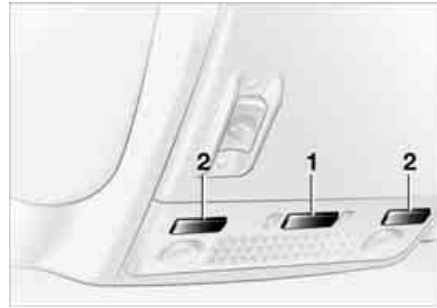

The interior lamps operate automatically.

To switch the interior lamps on and off manually

Press button 1 briefly:

If you want the interior lamps to remain off all the times, press and hold the button for approx. 3 seconds.

Press the button briefly to revert to normal operation.

Front reading lamps*

Switch on and off with the button 2 adjacent to each lamp.

Rear reading lamps

Switch on and off with the button adjacent to each lamp.



In order to prevent battery discharge, all of the lamps in the vehicle are automatically switched off approx. 15 minutes after you turn the ignition key to position 0. ◀

Light-emitting diodes

Light-emitting diodes (LEDs) installed behind translucent lenses serve as the light sources for many of the controls and displays in your vehicle. These light-emitting diodes are related to conventional lasers, and legislation defines them as light-emitting diodes, Class 1.



Do not remove the protective lens and avoid staring directly at the unfiltered beam for several hours, as inflammation of the retina could result. ◀

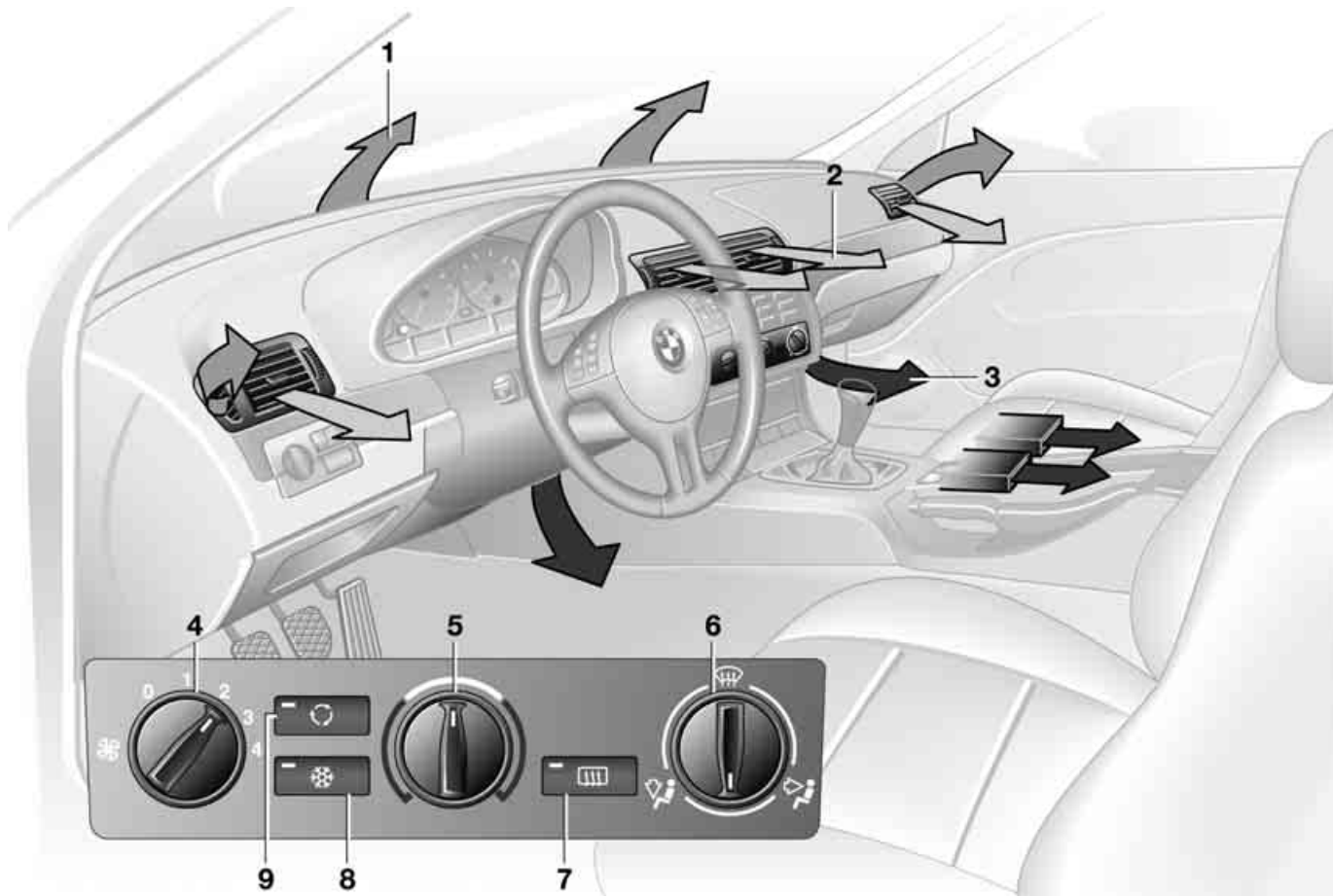

MY011113CMA

Air conditioning

- 1 Air onto the windshield and the side windows
- 2 Air for the upper body area [99](#)
- 3 Air to the footwell
- 4 Air supply/Blower [98](#)
- 5 Temperature [98](#)
- 6 Air distribution [98](#)
- 7 Rear window defroster [98](#)
- 8 Air conditioning [98](#)
- 9 Outside air/Recirculated-air mode [98](#)





Air supply/Blower

You can select blower speeds from 1 to 4. The heating and ventilation become more and more effective as the air supply settings are increased. In position 0, the blower and the heater are switched off. The outside air supply is blocked in position 0.

Temperature

In order to increase the temperature of the passenger compartment, turn to the right, red. The temperature of the incoming air is kept constant.

Air distribution

You can direct air to flow onto the windows , toward your upper body  or into the footwell . All intermediate settings are possible. In the setting , there is a low flow of air onto the windows to keep them free of condensation.

Rear window defroster

When the rear window defroster is activated, the indicator lamp comes on. The rear window defroster switches off automatically.



You can have your vehicle programmed in such a way that the rear window defroster switches on automatically. This occurs within 5 minutes after starting the engine when outside temperatures are below approx. 39 °F / +4 °C. ◀

Air conditioning

The air is cooled and dehumidified and – depending on the temperature setting – rewarmed.

Depending on the weather, the windshield may fog over briefly when the engine is started. Switching on the air conditioning will reduce condensation forming on the windows.



Condensation forms during operation of the air conditioning system, which then exits under the vehicle. It is thus not unusual for a small puddle to form under the car while the system is running. ◀

Outside air/Recirculated-air mode

You can respond to unpleasant external odors by temporarily excluding the supply of outside air. The system then recirculates the air currently within the vehicle.



If the windows should fog over in the recirculated-air mode, switch this mode off and increase the air supply as required. ◀

Air conditioning

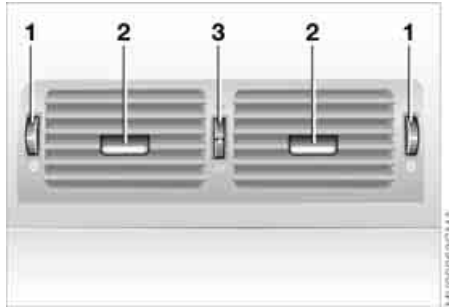

Microfilter

The built-in microfilter removes dust and pollen from the incoming air. Your BMW center will replace it during regularly scheduled maintenance. A substantial reduction in airflow indicates that the filter needs to be replaced before scheduled maintenance.

Draft-free ventilation

You can adjust the blower controls for the upper body area to obtain the optimum airflow rates and directions for your personal requirements:

- 1 Rotary dials for infinitely variable opening and closing of the vent outlets
- 2 Selector levers for airflow direction
- 3 Rotary dial allows you to control the temperature of the airflow from these outlets as desired



To defrost windows and remove condensation

1. Set the blower speed control for the air supply to position 4
2. Turn the rotary temperature control completely to the right – red
3. Rotary control for air distribution to position 
4. Switch on the rear window defroster to defrost the rear window.

100 Automatic climate control*

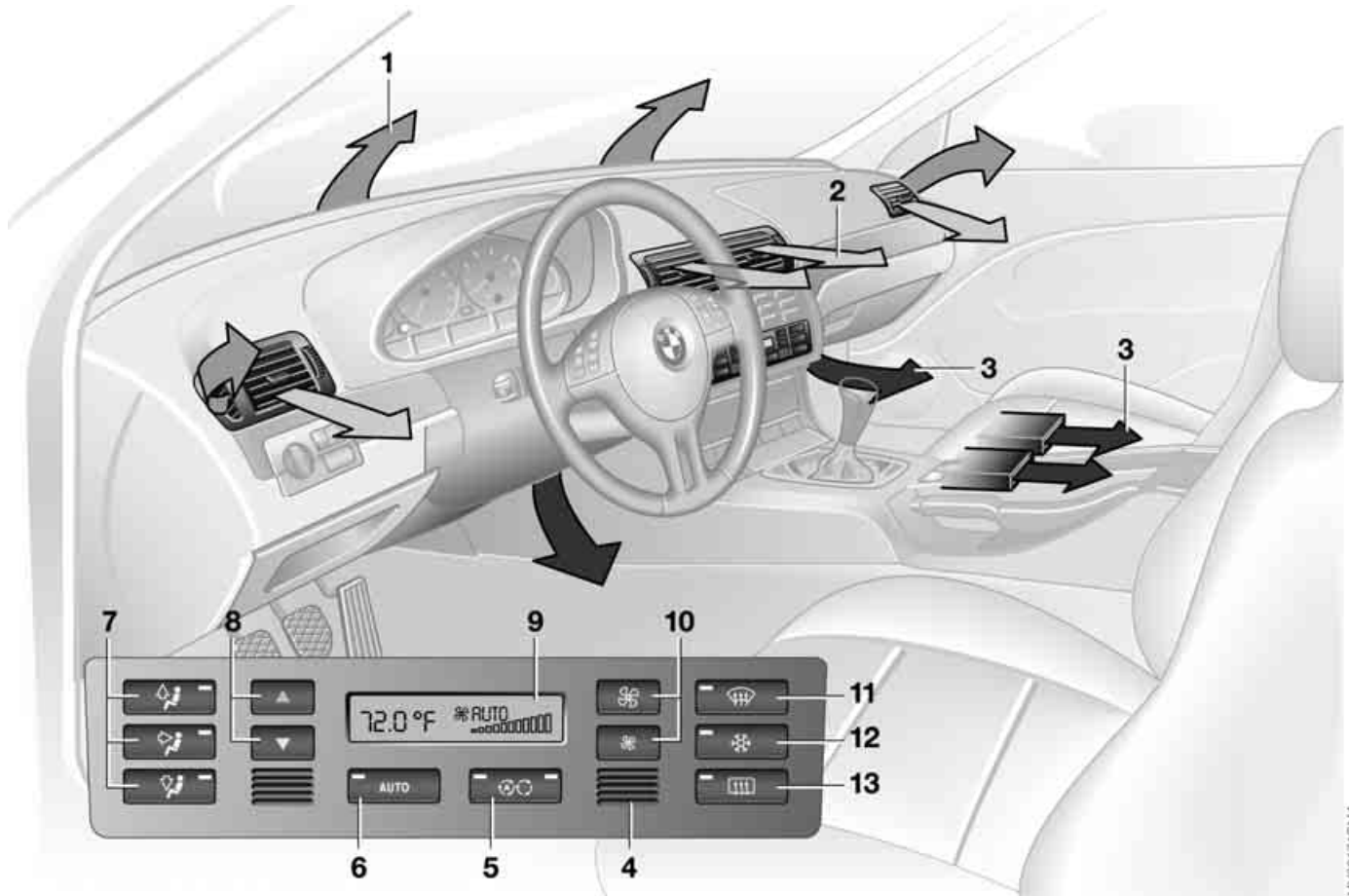

MV02178CMA

- 1 Air onto the windshield and the side windows
- 2 Air for the upper body area [103](#)
- 3 Air to the footwell [103](#)
- 4 Air inlet for interior temperature sensor – please keep clear and unobstructed
- 5 Outside air/Automatic recirculated-air control (AUC)/Recirculated air [103](#)
- 6 Automatic air distribution [102](#)
- 7 Individual air distribution [102](#)
- 8 Temperature [102](#)
- 9 Display for temperature [102](#) and air supply [102](#)
- 10 Air supply/Blower [102](#)
- 11 To defrost windows and remove condensation [102](#)
- 12 Air conditioning [102](#)
- 13 Rear window defroster [103](#)

Tips for pleasant driving

Use the automatic mode by pressing AUTO button 6. Select an interior temperature that is comfortable for you.

Detailed setting options are described for you in the following section.



You can make the settings of your vehicle in such a manner that when you unlock the vehicle with the remote control of your personal key, your own personalized setting for the automatic climate control is initiated. ◀



Automatic air distribution and supply

The AUTO program adjusts the air distribution and the air supply for you and in addition adapts the temperature to external influences – summer, winter – to meet preferences you can specify.

Individual air distribution

You can cancel the AUTO program by selecting specific distribution patterns to suit your own individual requirements.

While the AUTO program is then deactivated, the automatic airflow control remains in operation. Air flows onto

windows , toward the upper body , and into the footwell . You can switch the automatic distribution of air back on by selecting the AUTO button.

Temperature

The interior temperature that appears in the display panel is a general figure intended for reference purposes. We recommend 72 °F / +22 °C as a comfortable setting, even if the air conditioning is on. When you start the vehicle, the system ensures that the selected temperature is achieved as quickly as possible regardless of the season. It then maintains this temperature.

To select the units of measure °C/°F of the display, refer to page 83.

Air supply/Blower

By pressing the upper or lower button, you can vary the air supply. This deactivates the automatic control of the air supply, AUTO disappears from the display panel. Nevertheless, the automatic air distribution remains unchanged. You can reactivate the automatic air distribution mode by selecting the AUTO button.



When the lowest blower speed is set and you press the lower button, all of the displays are canceled: the blower, heating and air conditioning are switched off. The outside air supply is blocked. You can reactivate the system by pressing any button for the automatic climate control.

To defrost windows and remove condensation

This program quickly removes ice and condensation from the windshield and the side windows.

Air conditioning

The air is cooled and dehumidified and – depending on the temperature setting – rewarmed.

Depending on the weather, the windshield may fog over briefly when the engine is started. Air conditioning helps prevent the windows from fogging up.



Condensation forms during operation of the air conditioning system, which then exits under the vehicle. It is thus not unusual for a small puddle to form under the car while the system is running. ◀

Automatic climate control*

Outside air/Automatic recirculated-air control (AUC)/ Recirculated air



You can respond to unpleasant external odors or pollutants by temporarily stopping the flow of outside air. The system then recirculates the air currently within the vehicle.

Press the button repeatedly to select one of three different operating modes.

- ▷ Indicator lamps off: outside air supply is on
- ▷ Left indicator lamp on – AUC mode: the system recognizes pollutants in the outside air and blocks the flow of air when necessary. The system then recirculates the air currently within the vehicle. Depending on the air quality, the automatic system then switches back and forth between outside air supply and recirculation of the air within the vehicle
- ▷ Right indicator lamp on: the flow of external air into the vehicle is permanently blocked. The system then recirculates the air currently within the vehicle.



If the windows should fog over in the recirculated-air mode, switch this mode off and increase the air supply as required. ◀

Rear window defroster



When the rear window defroster is activated, the indicator lamp comes on. The rear window defroster switches off automatically.



You can have your vehicle programmed in such a way that the rear window defroster switches on automatically. This occurs within 5 minutes after starting the engine when outside temperatures are below approx. 39 °F / +4 °C. ◀

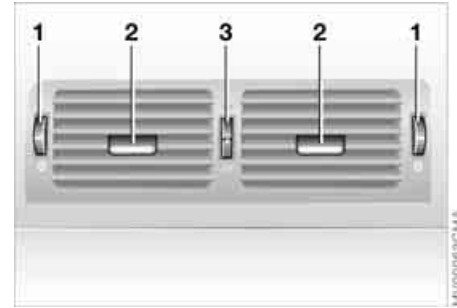

Draft-free ventilation

You can adjust the blower controls for the upper body area to obtain the optimum airflow rates and directions for your personal requirements:

- 1 Rotary dials for infinitely variable opening and closing of the vent outlets
- 2 Selector levers for airflow direction
- 3 Rotary dial allows you to control the temperature of the airflow from these outlets as desired

Microfilter/activated-charcoal filter

The built-in microfilter removes dust and pollen from the incoming air. The activated-charcoal filter provides additional protection by filtering gaseous pollutants from the outside air. Your BMW center replaces this combined filter as a standard part of your scheduled maintenance. A substantial reduction in airflow indicates that the filter needs to be replaced before scheduled maintenance.

Premium sound system*



Harman Kardon premium sound system

Press the button to activate and deactivate the acoustic enhancement.

The system creates the acoustic impression of a much larger passenger compartment accompanied by improved stereophonic sound at all seating positions.

The system responds to poor reception conditions by repeatedly alternating between the stereo and monophonic modes. You should then switch the system off.

Glove compartment

105

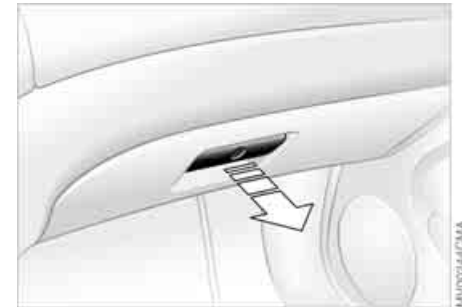

To open

Pull the handle. The lamp in the glove compartment will come on.

To close

Fold the cover up.

 To prevent injury in the event of an accident, close the glove compartment immediately after use. ◀

To lock

Lock with one of the master keys. A master key will also be required to unlock the glove compartment.

Overview

Controls

Maintenance

Repairs

Data

Index

 If – for example for valet parking – you turn over only your spare key, refer to page 30, then access to the locked glove compartment is not possible. ◀

Rechargeable flashlight

The flashlight is located on the left side of the glove compartment.

It features integral overload protection, so it can be left in its holder continuously.

 To avoid completely discharging and possibly damaging the flashlight, always ensure that it is switched off before inserting it in the socket. ◀

Storage compartments



MV01004CMAA

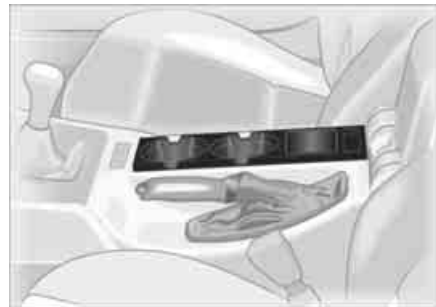

MV01005CMAA

Front center armrest

To open: press the button and fold up.

Additional compartments and nets*

You will find additional storage compartments in the front doors and in the center console. Storage nets are on the front seat backrests.

Beverage holders, coin box

A coin box and two beverage holders are provided in the center console.

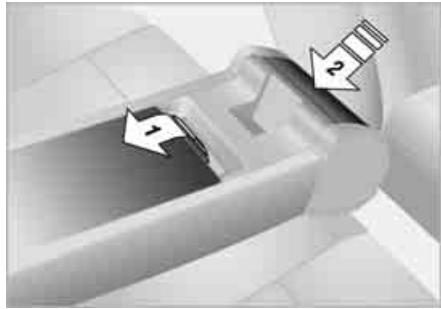

Rear center armrest

The rear center armrest includes a storage compartment, a beverage holder and a litter bag holder.

- 1 Storage compartment: pull up
- 2 Beverage holder: press



Storage package*

For your convenience, there are:

- ▷ Two flip-out sockets on the rear center console
- ▷ An eyeglasses compartment*, not shown, in the front center console.



Hands-free system

On vehicles that are wired for a telephone* or equipped with a communications package*, the cover for the handsfree microphone is located in the headliner near the interior lamp.

For further information on using your cellular phone, refer to the Owner's Manual for the telephone.

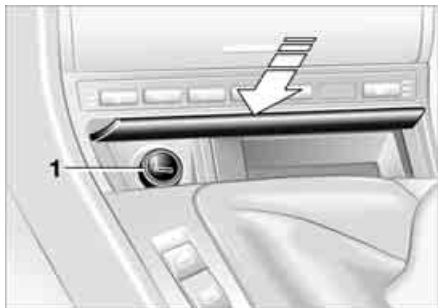
**Cigarette lighter socket**

Suitable for attaching power supplies for flashlights, car vacuum cleaners, etc., up to a rating of approx. 200 watts at 12 volts. Avoid damage to the socket caused by inserting plugs of different shapes or sizes.

To empty

Press on the edge of the open cover: the ashtray moves up and can be removed.

Cigarette lighter

 Hold or touch the hot cigarette lighter by the knob only. Holding or touching it in other areas could result in burns.

The cigarette lighter remains operational when the ignition key has been removed. For this reason, children should never be left in the vehicle unattended. ◀

Press the lighter 1 in. You can remove the lighter from its socket for use as soon as it snaps back out.

**To empty**

Press on the edge of the open cover in the opening direction. The ashtray moves up and can be removed.

Socket



A fold-out power socket – 12 volts – is located in the cargo area.

110 Ski bag*

The ski bag allows the safe and clean transport of up to 4 pairs of standard skis or up to two snowboards.

The length of the ski bag and the additional space provided in the cargo area make it possible to carry skis up to 6 ft 10 in / 2.10 m long. Because of the tapered shape of the bag, only two pairs of skis longer than 6 ft 10 in / 2.10 m can be carried.

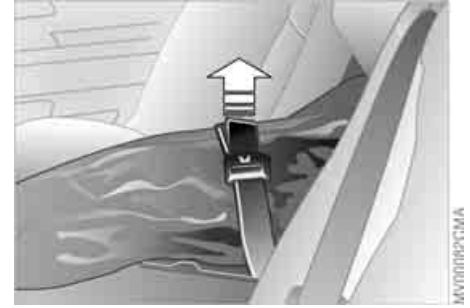
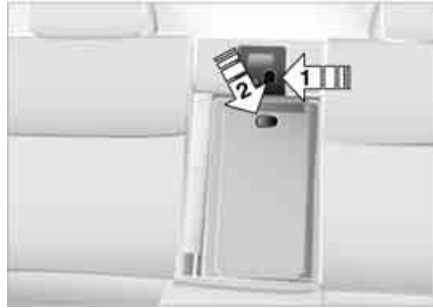



Loading

1. Fold the center armrest outward. Loosen the trim from the upper Velcro® fastener and place it on the armrest
2. Press the button – see arrow 1, from inside the passenger compartment: the cargo hatch drops onto the floor of the cargo area
3. Press down the detent lever – see arrow 2 – and fold the cover forward
4. Extend the ski bag between the front seats. The zipper provides convenient access to stored items. It may be opened to allow the ski bag to dry.

To store the ski bag, perform the above steps in reverse sequence.

Securing cargo

-  Secure skis and any other objects stored in the bag by tightening the retaining strap at the buckle. ◀
-  Be sure that your skis are clean before loading them into the bag. Avoid damage from sharp edges during loading. ◀

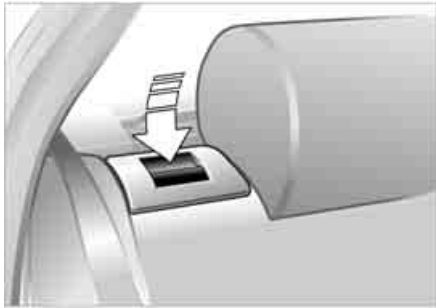

Folding rear backrest

Reach into the recess and pull forward.

▶ When you fold back the backrest, be sure that the catch engages securely. The red warning indicator in the recess disappears when the retainer is locked. ◀

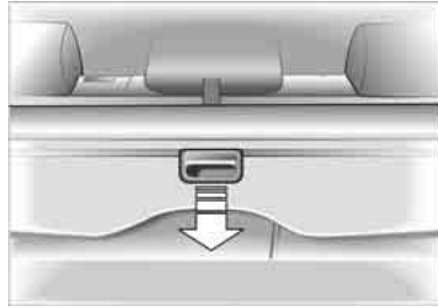

Cargo area cover

⚠ Never use the cover to carry heavy or hard objects, as such objects could pose a hazard to the vehicle's occupants during sudden braking maneuvers.

Guide the cover back into place; do not allow it to snap back, as it could sustain damage. ◀

Pull out the cover and suspend it by attaching it to the holders.

You can carry light objects such as articles of clothing on the cover.

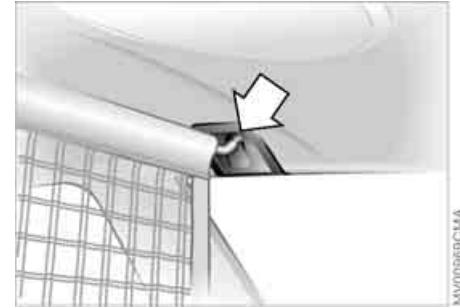

Partition net*

Use the loop to pull out the partition net, then grasp both sides of the rod and insert it into its holder. It is easiest to do this from the back seat.

⚠ Do not allow the partition net to snap back. Doing so could pose a risk of injury and the partition net could be damaged. ◀

If the backrests are folded forward, the partition net's case can be stored on the backrests; you can then extract the partition net and hold it in place by inserting the retainers into the front holders, refer to next page.

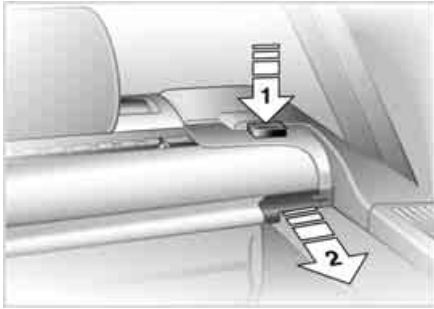

To remove cargo cover and partition net

1. Press the buttons on the sides – see arrow 1
2. Extract the case by pulling to the rear – see arrow 2.

Installation

Simply slide the case forward in the two side holders until it engages.

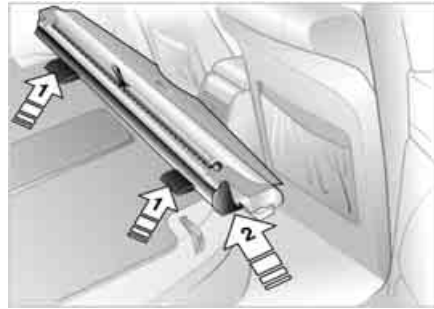

Storing with backrests folded forward

Supports for the case are provided on the rear sides of the backrests – see arrow 1.

Insert the case from the right as shown in the illustration, continuing until the detent engages – see arrow 2. Ensure that the cargo cover points toward the front of the vehicle, with the partition net's loop on the top.

You can pull the partition net out and insert it into the holders above it in the upper roof area.

 To ensure that the case is properly positioned, remember to insert it on both guides from the right side, always continuing until the detents snap into place. Failure to observe the prescribed insertion procedure could also result in damage to the door's upholstery. ◀

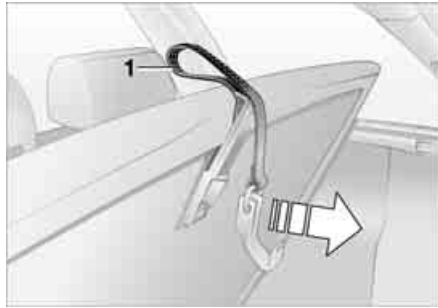

Lifting the floor panel

1. Lift up the floor panel slightly at loop 1
2. Release the loop end from the underside of the floor panel
3. Hook the loop end with the tab onto the rubber weather-stripping.

 Before folding the floor panel back down, attach the loop end to the holder on the underside of the floor panel. ◀

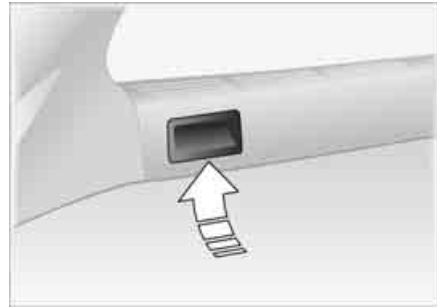

Side covers

Open the side covers by pressing the button.

 Avoid overloading the vehicle so that the permitted load on the tires is not exceeded. Overloading can lead to overheating and internal tire damage. The ultimate result can assume the form of a sudden air loss. ◀



Determining the maximum load

1. Locate the following statement on your vehicle's placard*:

 The combined weight of occupants and cargo should never exceed XXX kg or YYY lbs., as this could otherwise result in damage to the vehicle or unstable driving conditions. ◀

2. Determine the combined weight of the driver and passengers that will be riding in your vehicle
3. Subtract the combined weight of the driver and passengers from XXX kilograms or YYY pounds

4. The resulting figure equals the available amount of cargo and luggage load capacity.

For example, if the XXX amount equals 1,400 lbs. and there will be five 150 lbs. passengers in your vehicle, the amount of available cargo and luggage load capacity is 650 lbs.:

1,400 lbs. minus 750 lbs. = 650 lbs.

5. Determine the combined weight of luggage and cargo being loaded on the vehicle. That weight may not safely exceed the available cargo and luggage load capacity calculated in Step 4
6. If your vehicle will be towing a trailer, load from your trailer will be transferred to your vehicle. Consult the manual for transporting a trailer to determine how this may reduce the available cargo and luggage load capacity of your vehicle.

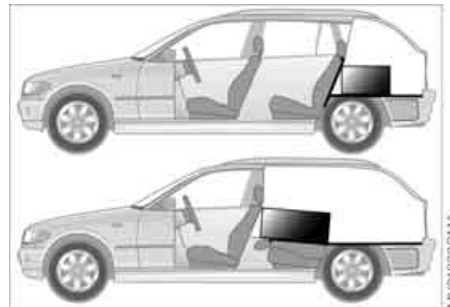

Stowing cargo

- ▷ Load heavy cargo as far forward as possible – directly behind the backrests or the cargo area partition – and as low as possible
- ▷ Cover sharp edges and corners
- ▷ Do not pile objects higher than the top edge of the backrest
- ▷ Pull out the partition net*, refer to previous page, taking care to ensure that there is no danger that any of the objects stored in the cargo area will protrude through the net*

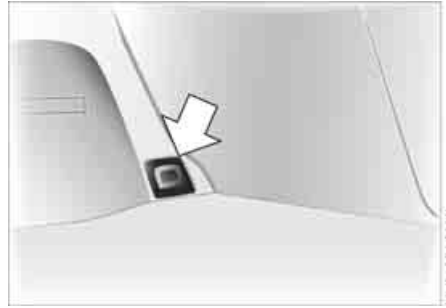
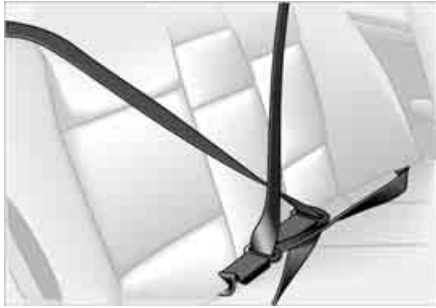

- ▷ For very heavy loads when the rear seat is not occupied, secure each safety belt in the opposite buckle.

Securing cargo

- ▷ Small and light luggage and cargo can be secured with the aid of flexible straps or a luggage compartment net*, refer to page 37
- ▷ For large, heavy pieces, see your BMW center for load-securing devices*. Anchorages located in the cargo area can be used for fastening the load-securing devices.

Read and comply with the instructions enclosed with the load-securing devices.

 Always position and secure loads correctly. If you do not, the load can endanger the passengers during braking or evasive maneuvers. Do not exceed the approved gross vehicle weight or the approved axle loads, refer to page 162, otherwise the vehicle's operating safety is no longer assured and the vehicle will not be in compliance with the certification regulations. Do not stow heavy or hard objects in the passenger compartment without securing them. Otherwise they would be thrown around during braking and evasive maneuvers and could endanger the passengers. ◀

116 Roof-mounted luggage rack*

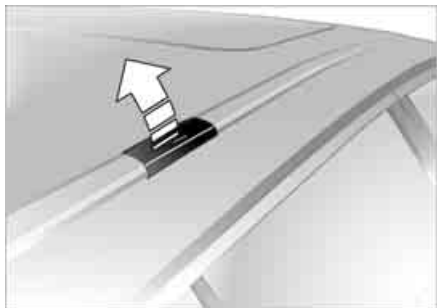

A special roof-rack system is available as an optional extra for your BMW. Please observe the precautions included with the installation instructions.

Anchorage

Access to the anchorages:

To fold up the covers, please use the tool provided with the roof-rack system.

Loading and driving notes

Roof-mounted luggage racks raise the center of gravity of the vehicle when they are loaded. For this reason, they exercise a major effect on the vehicle's handling and steering response.

You should therefore always remember not to exceed the approved roof load capacity, the approved gross vehicle weight or the axle loads when loading the rack. These weights are listed under Technical data on page 162.

Make sure that the load is not too bulky, and attempt to distribute it evenly. Always load the heaviest pieces first so that they are at the bottom. Be sure that adequate clearance is maintained for raising the glass sunroof, and that objects do not project into the opening path of the tailgate.

Secure the roof-mounted luggage correctly and securely to prevent it from shifting or being lost during driving.

Drive smoothly and avoid sudden acceleration and braking. Do not corner at high speeds.

The roof-mounted luggage rack and the roof load increase the aerodynamic resistance: increased fuel consumption and additional stress on the vehicle's body are the result.



Overview

Controls and features

Operation, maintenance

Owner service procedures

Technical data

Index



Overview

Controls

Maintenance

Repairs

Data

Index

To ensure that your vehicle provides maximum economy throughout a long service life, we request that you observe the following suggestions.

Engine and differential

Up to 1,250 miles/2,000 km:

Constantly vary both vehicle and engine speeds, remembering not to exceed 4,500 rpm or vehicle speeds of over 100 mph / 160 km/h:

Obey your local and state maximum speed limits.

Do not use full throttle, and avoid pressing the accelerator beyond the kickdown point during these initial miles.

You can then proceed to increase engine or vehicle speeds once the initial 1,250 miles/2,000 km have elapsed.

You should also observe the same break-in procedures if the engine or differential should have to be replaced later in the course of the vehicle's life.

Tires

Due to technical factors associated with their manufacture, tires do not achieve their full traction potential until an initial break-in period has elapsed. Thus drive with extra care during the initial 200 miles/300 km.

Obey your local and state maximum speed limits.



When the vehicle is operated on wet or slushy roads, a wedge of water may form between the tire and the road surface. This phenomenon is referred to as hydroplaning, and can lead to partial or complete loss of traction, as well as loss of vehicle control and braking effectiveness. Reduce your speed on wet roads. ◀

Brake system

Approx. 300 miles/500 km must elapse before the brake pads and rotors achieve the optimal pad-surface and wear patterns required for trouble-free operation and long service life later on.

To break in the separate parking brake drums, apply the parking brake lightly when coasting to a standstill – at a traffic signal, for instance – provided that traffic conditions allow you to do so.

To avoid corrosion, repeat this procedure from time to time.



The brake lamps do not come on when the parking brake is set.

Vacuum for the brake system servo unit on your BMW is available only when the engine is running. When you move the vehicle with the engine off – when towing, for example – substantially higher levels of pedal force will be required to brake the vehicle. ◀

Clutch

Approx. 300 miles/500 km must elapse before the clutch starts to operate at optimum efficiency. Remember to engage the clutch carefully during this initial period.

General driving notes



Brakes: do not rest your foot on the brake pedal while driving. Even light but consistent pedal pressure can lead to high temperatures, brake wear and possibly even brake failure.

Hydroplaning: when driving on wet or slushy roads, reduce road speed. If you do not, a wedge of water can form between tires and road surface. This phenomenon can lead to partial or complete loss of contact between the tires and road surface, as well as loss of vehicle control and braking ability.

Driving through water: do not drive through water on the road if it is deeper than 1 ft/30 cm, and then only at walking speed. Otherwise, the vehicle's engine, the electrical systems and the transmission may be damaged.

Cargo area cover: never use it to store heavy or hard objects; otherwise, occupants could be injured if the vehicle is braked hard.

Clothes hooks: when hanging clothing from the hooks, be sure that they will not obstruct the driver's vision. Do not hang heavy objects on the hooks. If you do so, they could cause personal injury during braking or evasive maneuvers. ◀

Antilock Brake System (ABS)

The concept

ABS keeps the wheels from locking during braking, thereby enhancing active driving safety.

Braking with ABS

If you are in a situation that requires full braking, you will exploit the full benefits of ABS system if you apply maximum pedal pressure – panic stop. Since the vehicle maintains steering responsiveness, you can avoid possible obstacles with a minimum of steering effort, despite the full brake application.

Pulsation at the brake pedal combined with sounds from the hydraulic circuits indicates to the driver that ABS is in its active mode.

Dynamic Brake Control (DBC)

DBC is included in the DSC, refer to page 86.

The system responds to sudden, high-intensity applications of force to the brake pedal by automatically braking the vehicle with maximum boost to achieve the shortest possible braking distances during panic stops. This system exploits all the benefits of ABS.

Do not reduce the pressure exerted against the brake pedal until the braking maneuver has been completed. DBC is deactivated when you release the brake pedal.

Cornering Brake Control (CBC)

CBC is an advanced engineering design of the ABS. When braking while cornering at high speed or braking during high lateral acceleration, or when braking during a lane change, vehicle stability is improved and steering response is enhanced.

Brake fluid level

Low brake fluid level in the reservoir combined with longer than usual pedal travel may indicate a defect in one of the brake system's hydraulic circuits.

 Proceed to the nearest BMW center. It may be necessary to apply higher levels of pressure to the pedal when stopping and braking distances may also be longer. Please remember to adapt your driving style accordingly. ◀

Disc brakes

When the vehicle is driven only occasionally, during extended periods when the vehicle is not used at all, and in operating conditions where brake applications are less frequent, there is an increased tendency for corrosion of the rotors and accumulation of contamination on the brake pads. This occurs because the minimal pressure that must be exerted by the pads to clean the rotors by brake applications is not reached.

Corrosion on brake rotors is signaled by a running or pulsation during braking; even extended subsequent braking will not cure this phenomenon.

It is a good idea to periodically dry the brakes with a gentle application when driving in rain and on wet roads. Watch traffic conditions to ensure that this maneuver does not endanger other road users. The heat generated in this process helps dry the pads and rotors to ensure that your brake system will respond with undiminished efficiency when you need it.

When descending steep hills and extended grades, downshift to a gear that will allow you to continue safely with only a minimal amount of braking. This helps avoid placing excessive loads on the brake system. Use care to avoid exceeding the approved engine-speed range, refer to page 79.



Do not coast with the clutch depressed or with the transmission or selector lever in Neutral. Do not coast with the engine shut off. The engine provides no braking effect when the clutch is depressed and there is no power-assist for braking or steering when the engine is not running. 325xi: always refer all brake inspection and service work to your BMW center, as failure to observe the special procedures could result in damage to components of the all-wheel drive. Never allow floor mats, carpets or any other objects to protrude into the area around the accelerator, clutch and brake pedals and obstruct their movement. ◀

Brake pads

For your own safety: use only brake pads which BMW has approved for your specific vehicle model. BMW cannot evaluate non-approved brake pads to determine if they are suitable for use, and therefore cannot ensure the operating safety of the vehicle if they are installed. ◀

Portable phone in the vehicle

BMW recommends using mobile communications devices, e.g. portable phones, inside the vehicle with a suitable outside antenna. Otherwise, it cannot be ruled out that the vehicle electronics and portable phone may interfere with each other.

Information for your safety

The factory-approved tires are matched to your vehicle and have been selected to provide optimum safety and driving comfort when used properly.

It is not merely the tire's service life, but also driving comfort and – above all else – driving safety that depend on the condition of the tires and the maintenance of the specified tire inflation pressure.

Incorrect tire inflation pressure is a frequent cause of tire damage. It also significantly influences the roadholding ability of your BMW.



Be sure to check the tire inflation pressure, including the space-saver spare tire or the spare tire, on a regular basis, at least twice a month and before every extended journey, refer to page 25. If this is not done, incorrect tire pressures can cause driving instability and tire damage, ultimately resulting in accidents. ◀

Tire condition

When the tread reaches a depth of 1/16 in / 1.6 mm, these indicators appear and signal that the tires have worn to the minimum legal level.

Tire tread – tire damage

Inspect your tires frequently for tread wear, signs of damage and for foreign objects lodged in the tread. Check the tread depth.

Tread depth should not be allowed to go below 1/8 in / 3 mm, even though the legally specified minimum tread depth is 1/16 in / 1.6 mm.

Below 1/8 in / 3 mm tread depth, there is a great risk of hydroplaning, even at relatively moderate speeds and with only small amounts of water on the road. Tread wear indicators – see arrow – are embedded in the base of the tire's tread. Their locations are indicated by the letters TWI – Tread Wear Indicator – at various points on the tire's shoulder.

Tire condition

 Do not drive on a deflated – flat – tire unless your vehicle is equipped with Run Flat tires. A flat tire greatly impairs steering and braking response, and can lead to complete loss of control over the vehicle. Avoid overloading the vehicle so that the permitted load on the tires is not exceeded. Overloading can lead to overheating and internal tire damage. The ultimate result can assume the form of a sudden air loss. Unusual vibrations encountered during normal vehicle operation can indicate a damaged tire or some other vehicle malfunction. This type of problem can be caused by contact with curbs, etc. This is also true for irregularities in the vehicle's handling characteristics, such as a pronounced tendency to pull to the left or right. Should this occur, respond by immediately reducing your speed. Proceed carefully to the nearest BMW center or professional tire center, or have the vehicle towed in to have it, its wheels or its tires inspected. Tire damage, up to and including sudden and complete air loss, can endanger the lives of both the vehicle occupants and other road users. ◀

Tire replacement

To maintain good handling and vehicle response, use only tires of a single tread configuration from a single manufacturer.

Comply with the specified tire inflation pressures – and be sure to have the wheel and tire assembly balanced every time you change a tire or wheel.

DOT quality grades

Tread wear

Traction AA A B C

Temperature A B C

 All passenger car tires must conform to Federal Safety Requirements in addition to these grades. ◀

Tread wear

The tread wear grade is a comparative rating based on the wear rate of the tire when tested under controlled conditions on a specified government test course.

For example, a tire graded 150 would wear one and one-half – $1\frac{1}{2}$ – times as well on the government course as a tire graded 100. The relative performance of tires depends upon the actual conditions of their use, however, and may

depart significantly from the norm due to variations in driving habits, service practices and differences in road characteristics and climate.

Traction

The traction grades, from highest to lowest, are AA, A, B, and C.

Those grades represent the tire's ability to stop on wet pavement as measured under controlled conditions on specified government test surfaces of asphalt and concrete. A tire marked C may have poor traction performance.

 The traction grade assigned to this tire is based on straight-ahead braking traction tests, and does not include acceleration, cornering, hydroplaning, or peak traction characteristics. ◀

Temperature

The temperature grades are A – the highest – B, and C, representing the tire's resistance to the generation of heat and its ability to dissipate heat when tested under controlled conditions on a specified indoor laboratory test wheel.

Sustained high temperature can cause the material of the tire to degenerate and reduce tire life, and excessive temperature can lead to sudden tire failure. The grade C corresponds to a level of performance which all passenger car tires must meet under the Federal Motor Vehicle Safety Standard No. 109. Grades B and A represent higher levels of performance on the laboratory test wheel than the minimum required by law.

 The temperature grade for this tire is established for a tire that is properly inflated and not overloaded. Excessive speed, underinflation, or excessive loading, either separately or in combination, can cause heat buildup and possible tire failure. ◀

Uniform Tire Quality Grading

Quality grades can be found where applicable on the tire sidewall between tread shoulder and maximum section width. For example:

Tread wear 200
Traction AA
Temperature A



BMW advises against using retreaded tires, since driving safety may be impaired. This is due to the possible variations in casing structures and, in some cases, to their extreme age, which can lead to a decrease in their durability. ◀

Tire age

The date on which the tire was manufactured is indicated by the code on the sidewall:

DOT... 3603 indicates that the tire was manufactured in week 36 of the year 2003.

BMW recommends the replacement of all tires – including the spare tire* – when the tires are no more than 6 years old, even if a tire life of 10 years is possible.

Run Flat tires*

Before purchasing tires, check if your BMW is equipped with Run Flat tires. These are indicated by a circular symbol containing the letters RSC on the tire sidewall, refer to Changing a wheel. In this case, use only Run Flat tires, since no spare wheel is available in the event of a flat. For more information on Run Flat tires, refer to page [150](#).



Run Flat tires are available only in combination with the Flat Tire Monitor. ◀

The right choice

 BMW recommends using only wheels and tires that have been approved by BMW for your particular vehicle model, as otherwise body contact and serious accidents can result despite the use of the same nominal size, e.g. due to manufacturing tolerances. BMW cannot evaluate all tires and wheels on the market, and is thus unable to guarantee that the vehicle will continue to perform safely if unapproved tires and/or wheels are mounted. ◀

For each tire size, BMW has assessed the safe performance of specific tire brands and approved them for use. Consult any BMW center for details. Comply with any local/national regulations, for example by recording the tire type in the vehicle documents.

 The correct wheel-tire combination affects different systems such as ABS, DSC and ADB-X/DBC. The function of these systems is impaired if improper wheel-tire combinations are used. For this reason, use only tires of the same manufacture and tread configuration. In the event of a flat tire, for example, remount the approved wheel and tire combination as soon as possible. ◀

Storage

Always store tires in a cool, dry place. Store them away from light whenever possible. Protect the tires against contact with oil, grease and fuel.

Do not exceed the maximum tire inflation pressures specified on the tire sidewall.

Choosing the right tire

BMW recommends the use of winter tires for operation under winter road conditions. While all-season tires – with M+S designation – provide better winter traction than the corresponding summer tires, they generally do not achieve the performance of winter tires.

In the interest of safe tracking and steering response, install winter tires made by the same manufacturer and having the same tread configuration on all four wheels.

 Never exceed the maximum speed for which the winter tires are rated.

Unprofessional attempts by laymen to service tires can lead to damage and accidents.

Have this work performed by trained professionals only. Any BMW center has the required technical knowledge and the proper equipment and will be happy to assist you. ◀

Run Flat tires*

Before purchasing winter tires, check if your BMW is equipped with Run Flat tires. These are indicated by a circular symbol containing the letters RSC on

the tire sidewall, refer to Changing a wheel. In this case, use only Run Flat winter tires, since no spare tire is provided in the event of a flat tire.

Tire condition, tire pressure

At tread depths below approx. 3/16 in / 4 mm, winter tires display a perceptible decrease in their ability to cope with winter driving conditions, and should be replaced in the interest of safety.

Comply with the specified tire inflation pressures – and be sure to have the wheel and tire assembly balanced every time you change a tire or wheel.

Snow chains*

Only certain snow chains have been tested by BMW and determined and approved as roadworthy. Consult any BMW center for details. BMW recommends using only these approved fine-link snow chains. Use them in pairs on either summer or winter tires, but only on both rear wheels.

325xi: in an extreme emergency – for instance, with the vehicle stuck on one side, or when obstructions make it impossible to reach one tire – a chain may also be mounted on just one tire for the limited period needed to resolve the problem.

Comply with all manufacturer's safety precautions when mounting the chains. Do not exceed a speed of 30 mph / 50 km/h when using snow chains.

You cannot mount snow chains on the following tires:

225/50 R 16

225/45 R 17

245/40 R 17

225/40 R 18

255/35 R 18



Do not initialize the Flat Tire Monitor after mounting snow chains to the tires.

When driving with snow chains, it may be useful to turn off the DSC for a short time, refer to page [87](#) or [88](#). ◀



To release

Pull the lever located under the left-hand side of the instrument panel.

⚠ Do not attempt to service your vehicle if you do not have the required technical background. Failure to work in an informed, professional manner when servicing components and materials constitutes a safety hazard for vehicle occupants and other road users. If you are not familiar with the guidelines, BMW recommends that you have the operations performed by your BMW center. ◀

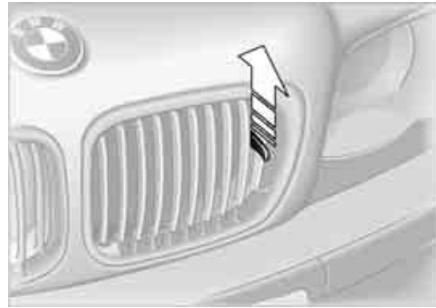

To open

Pull the release handle and open the hood.

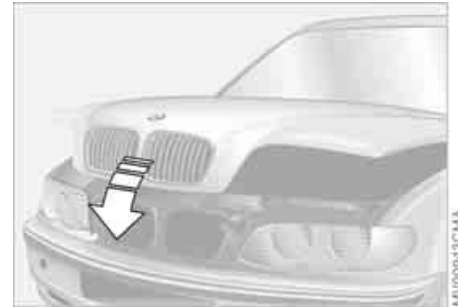

To close

Allow the hood to fall from a height of about 1 ft/30 cm so that it audibly engages.

⚠ To avoid injuries, be sure that the travel path of the hood is clear when it is closed, following the same safety precautions used in all closing procedures. If you determine while driving that the hood is not completely closed, stop immediately and close it securely. ◀

130 Engine compartment essentials

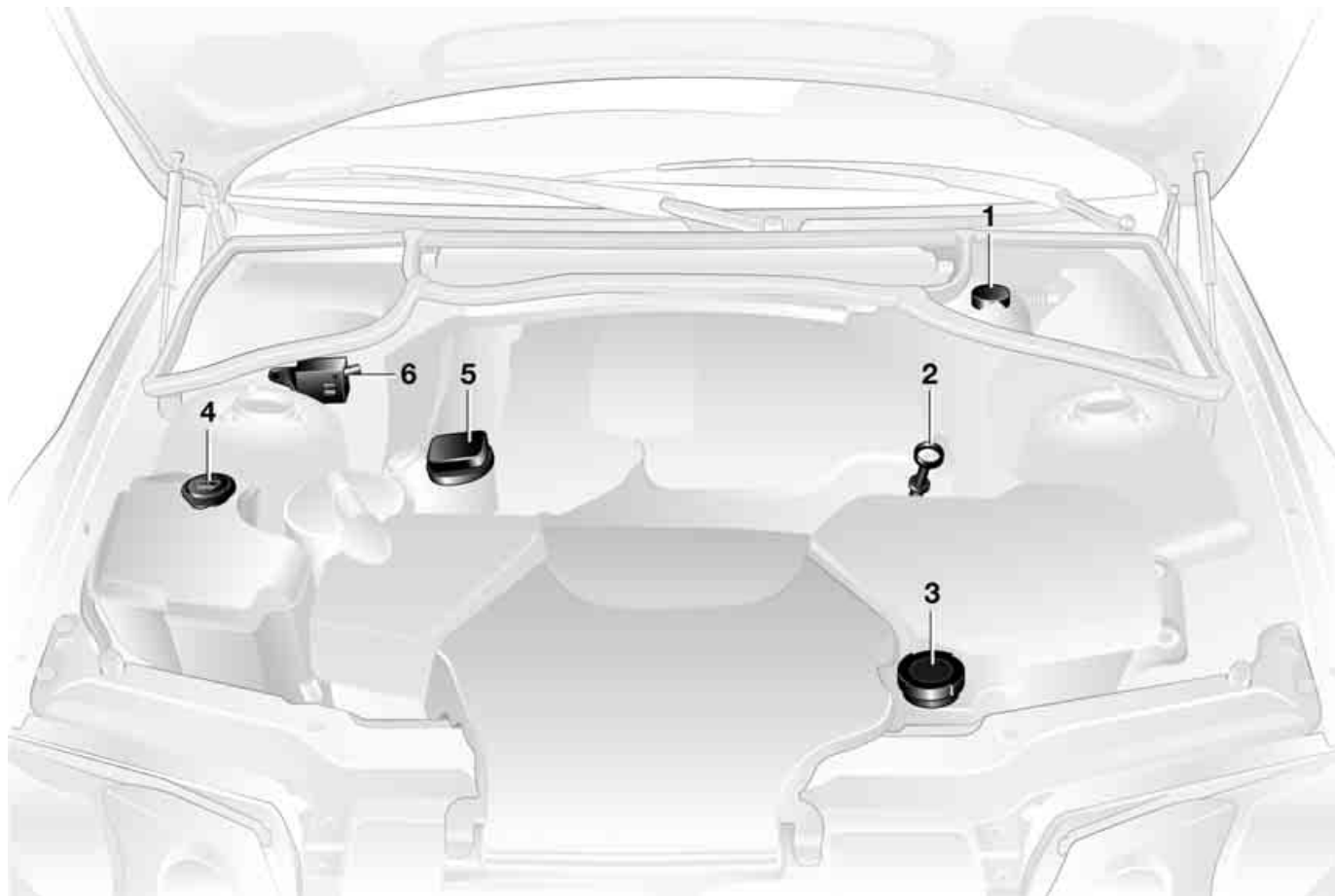

MV0162/CMA

- 1 Brake fluid reservoir [135](#)
- 2 Dipstick, engine oil [132](#)
- 3 Coolant expansion tank [134](#)
- 4 Reservoir for the headlamp and windshield washer system [132](#)
- 5 Engine oil filler neck [132](#)
- 6 Auxiliary terminal for jump-starting [153](#)

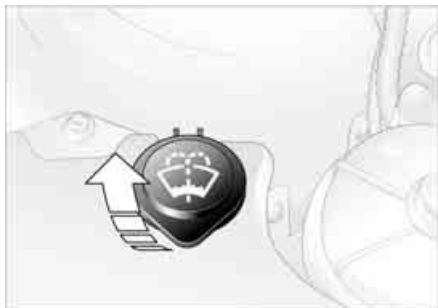

Headlamp* and windshield washer system

Capacity approx.
5.6 US quarts/5.3 liters.

Fill with water and, if required, with a washer antifreeze additive according to manufacturer's recommendations.

 We recommend that you mix the washer fluid before adding it to the reservoir. ◀



Rear window washer reservoir

Capacity approx.
2.4 US quarts/2.3 liters.

Fill with water and, if required, with a washer antifreeze additive according to manufacturer's recommendations.

 We recommend that you mix the washer fluid before adding it to the reservoir. ◀

 Antifreeze agents for the washer fluid are highly flammable. For this reason, keep them away from sources of flame and store them only in their closed original containers. Store it inaccessible to children. Comply with the instructions on the containers. ◀

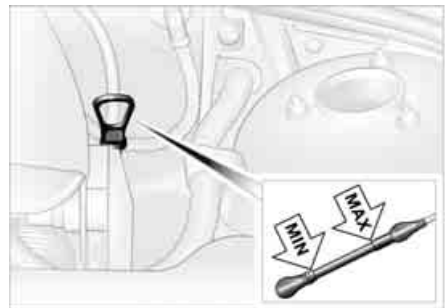

Checking the oil level

1. Park the vehicle on a level surface
2. Switch the engine off after it has reached normal operating temperature
3. After approx. 5 minutes, pull the dipstick out and wipe it off with a clean lint-free cloth, paper towel, or similar material
4. Carefully push the dipstick all the way into the guide tube and pull it out again
5. The oil level should be between the two marks on the dipstick.

As with fuel economy, oil consumption is directly influenced by your driving style and vehicle operating conditions.

Engine oil

The oil volume between the two marks on the dipstick corresponds to approx. 1.1 US quarts/1 liter. Do not fill beyond the upper mark on the dipstick. Excess oil will damage the engine.

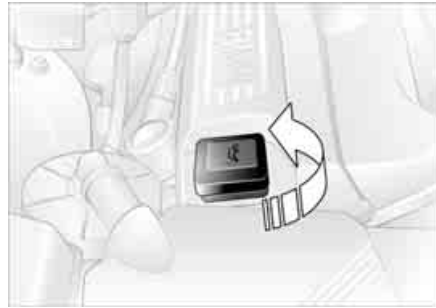

Adding engine oil

Only add engine oil when the oil level has dropped to just above the lower mark on the dipstick.

 BMW engines are designed to operate without oil additives; the use of additives could lead to damage in some cases. This also applies to the manual transmission, the automatic transmission, the differential, and the power steering system. ◀

Recommendation: have the oil changed by your BMW center.

 Continuous exposure to used oil has caused cancer in laboratory testing. For this reason, any skin areas that come into contact with oil should be thoroughly washed with soap and water.

Store oils, grease and similar materials so that they are inaccessible to children. Comply with warning labels and information on containers. ◀

 Comply with the applicable environmental laws regulating the disposal of used oil. ◀

Specified engine oils

The quality of the engine oil is extremely important for the function and service life of an engine. Based on extensive testing, BMW has approved only certain grades of engine oil.

Use only approved BMW High Performance Synthetic Oil.

If an approved BMW High Performance Synthetic Oil should be unavailable, you may use small volumes of other synthetic oils for topping up between oil changes. Use only oils with the specification API SH or higher.

 Ask your BMW center for details concerning the specific BMW High Performance Synthetic Oil or synthetic oils that have been approved. ◀

You can also call BMW of North America toll-free at 1-800-831-1117 or visit this website: www.bmwusa.com to obtain this information.

Viscosity ratings

Viscosity is the oilflow rating as established in SAE classes.

The selection of the correct SAE class depends on the climatic conditions in the area you drive your BMW.

 Approved oils are in SAE classes 5W-40 and 5W-30. ◀

These kinds of oil may be used for driving in all ambient temperatures.

Coolant

 Do not add coolant to the cooling system when the engine is hot. If you attempt to do so, escaping coolant can cause burns.

Antifreeze and anti-corrosion agents are hazardous to health. You should always store them in their closed original containers and in a location which is out of reach of children. Antifreeze and anti-corrosion agents are inflammable. For this reason, do not spill them on hot engine parts. They could ignite and cause burns. Comply with the instructions on the containers. ◀

 Comply with the applicable environmental laws regulating the disposal of antifreeze agents with corrosion inhibitor. ◀



14V00627CMA

Checking the coolant level and adding coolant

Check the coolant level when the engine is cold, approx. 68 °F / +20 °C:

1. Open the cap for the expansion tank by turning it slightly counterclockwise to allow accumulated pressure to escape, then open
2. The coolant level is correct when the upper end of the red float is at least even with the upper edge of the filler neck; see arrow. The end of the float may stick out by a maximum of 3/4 in / 2 cm – that is, up to the second mark on the float
3. If necessary, add coolant. If the coolant is low, slowly add coolant until the correct level is reached – do not overfill.

Brake fluid



Indicator lamp

BRAKE The brake warning lamp comes on when the parking brake is not engaged: the brake fluid level is too low, refer to page 18.

 Brake warning lamp for Canadian models.

Adding brake fluid

For adding brake fluid or for determining and correcting the cause of brake fluid loss, consult your BMW center. Your BMW center is familiar with the specifications for factory-approved brake fluids – DOT 4.

Brake fluid loss results in extended brake pedal travel. Refer to the information on page 122.

 Brake fluid is hygroscopic, that is, it absorbs moisture from the air over time.

In order to ensure the brake system's safety and reliability, have the brake fluid changed every two years by a BMW center. Refer to the Service and Warranty Information Booklet for US models or the Warranty and Service Guide Booklet for Canadian models. Brake fluid is toxic and damages the vehicle's paint. You should always store it in its closed original container and in a location which is out of reach of children.

Do not spill the brake fluid and do not fill the brake fluid reservoir beyond the MAX mark. The brake fluid could ignite upon contact with hot engine parts and cause serious burns. ◀

 Comply with the applicable environmental laws regulating the disposal of brake fluid. ◀

The BMW Maintenance System has been designed as a reliable means of providing maximum driving and operating safety – and as cost-effectively as possible for you.

Please keep in mind that regular maintenance is not only necessary for the safety of your vehicle, but also plays a significant role in maintaining the resale value of the vehicle.



Service interval display

While conventional systems rely on distance traveled alone to determine when service is due, the BMW Maintenance System has for years taken the actual conditions under which the vehicle operates into consideration, because miles can be traveled in many different ways:

From a maintenance point of view, 62,000 miles/100,000 km of short-distance urban driving cannot be compared with 62,000 miles/100,000 km of long-distance highway travel.

The BMW Maintenance System includes the Engine Oil Service and Inspections I and II.

Determining the maintenance intervals according to the actual use of the vehicle covers every kind of operating situation. Minimal use drivers – those who drive significantly fewer than 6,200 miles/10,000 km annually – should have the engine oil changed at least every 2 years since oil deteriorates over time, regardless of use.

Service and Warranty Information Booklet for US models/ Warranty and Service Guide Booklet for Canadian models

For additional information on required maintenance intervals and procedures, please refer to the Service and Warranty Information Booklet for US models, or the Warranty and Service Guide Booklet for Canadian models.

As a precaution against corrosion, it is advisable to have the body checked for damage from rocks or gravel at the same time, depending upon operating conditions.

The BMW Maintenance System



Have your BMW center perform maintenance and repair.

Be sure that all maintenance work is recorded in the Service and Warranty Information Booklet for US models, or in the Warranty and Service Guide Booklet for Canadian models. These entries confirm that your vehicle has benefitted from regular maintenance, and are also required for warranty claims. ◀

Care

You can find everything you need to know on this topic by consulting the separate Caring for your vehicle brochure.

California laws require us to state the following warning:

 Engine exhaust and a wide variety of automobile components and parts, including components found in the interior furnishings in a vehicle, contain or emit chemicals known to the State of California to cause cancer and birth defects and reproductive harm. In addition, certain fluids contained in vehicles and certain products of component wear contain or emit chemicals known to the State of California to cause cancer and birth defects or other reproductive harm.

Battery posts, terminals and related accessories contain lead and lead compounds. Wash your hands after handling.

Used engine oil contains chemicals that have caused cancer in laboratory animals. Always protect your skin by washing thoroughly with soap and water. ◀

OBD interface socket



The interface socket for onboard diagnostics is located on the left-hand side of the driver's side, below the instrument panel and under a cover panel. The cover has the letters OBD on it.

This interface makes it possible to access data on emissions-related components using special equipment.

 An illuminated indicator informs you of the need for service, not that you need to stop the vehicle. Your system should be checked, however, at the earliest opportunity.

If the indicator blinks or flashes, this indicates a high level of engine misfire. Reduce speed and contact the nearest BMW center immediately. Severe

OBD interface socket

engine misfiring for even a short period of time can seriously damage emission control system components, especially the catalytic converter.



SERVICE ENGINE SOON warning lamp for Canadian models.



If the gas cap is not on tight enough, the OBD system can detect leaking vapor and the indicator will light up. If the gas cap is then tightened, the indicator will usually go out after a short period of time. ◀

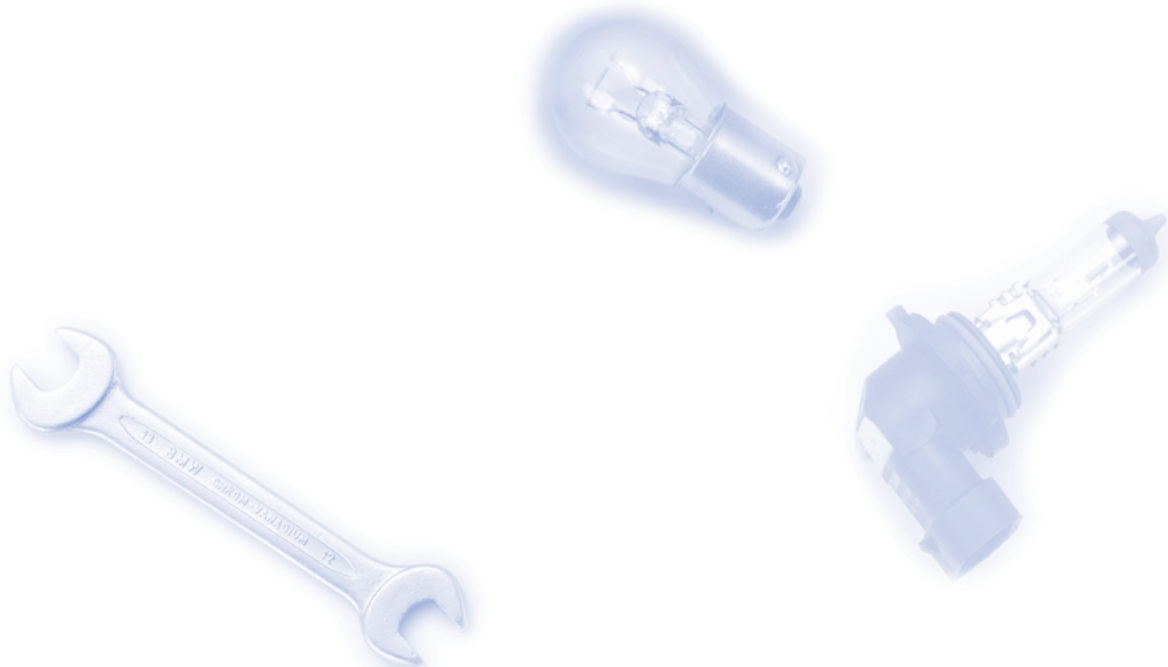



Overview

Controls and features

Operation, maintenance

Owner service procedures

Technical data

Index

Overview

Controls

Maintenance

Repairs

Data

Index



MV01023CMA

The onboard tool kit is located beneath the floor panel in the cargo area.

For information on raising the floor panel, refer to page 113.

Windshield wiper blades



MV000101CMA

Windshield

1. Switch off the engine
2. Fold the wiper arm completely out from the windshield
3. Position the wiper blade at an angle and pull the release spring – see arrow
4. Fold the wiper blade down and unhook it toward the windshield
5. Pull the wiper blade past the wiper arm toward the top
6. Insert a new wiper blade and apply pressure until you hear it engage.

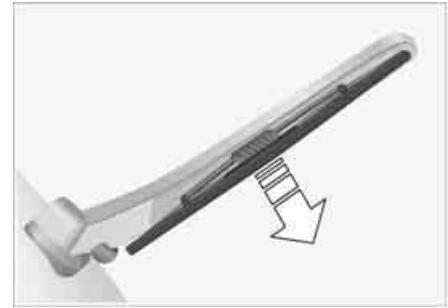

MV01024CMA

Rear window

1. Switch off the engine
2. Fold the wiper arm completely out from the windshield
3. Pull out the wiper blade – see arrow
4. Guide the new wiper blade into place, continue to apply pressure until you hear the detent engage.

Lamps and bulbs

The lamps and bulbs make essential contributions to the safety of your vehicle. Therefore, proceed carefully when handling bulbs. BMW recommends that you have such work performed by your BMW center if you are not familiar with the procedures.

 Do not touch the glass portion of a new bulb with your bare hands since even small amounts of impurities burn in to the surface and reduce the service life of the bulb. Use a clean cloth, paper napkin, or a similar material, or hold the bulb by its metallic base. ◀

A replacement bulb set is available from your BMW center.

 Before working on the electrical system, switch off the electrical accessory you are working on or disconnect the cable from the negative terminal of the battery. Failure to observe this precaution could result in short circuits. To prevent injuries and damage, comply with any instructions provided by the bulb manufacturer. ◀

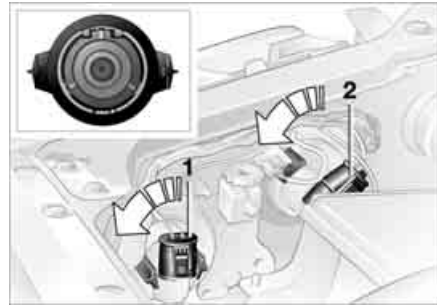

Low beams and high beams

Engine compartment, left side:

- 1 Low beams
 - 2 High beams
- H7 bulb, 55 watts

 The H7 bulb is pressurized. Therefore, wear safety glasses and protective gloves. Failure to comply with this precaution could lead to injury if the bulb is damaged. ◀

1. Turn the two release catches at the front to the left – see arrow – to remove the bulb holder
2. Remove and replace the bulb.

 Insert the new bulb as shown in the inset.

When attaching the bulb holder, ensure that the lock snaps in place properly. ◀

 When cleaning the headlamps, please follow the instructions in the Caring for your vehicle brochure. ◀

Xenon lamps

The service life of these bulbs is very long and the probability of a failure is very low, provided that they are not switched on and off an unusual number of times. If one of these bulbs should nevertheless fail, it is possible to continue driving with great caution using the fog lamps, provided local traffic laws do not prohibit this.

 Because of the extremely high voltages involved, any work on the xenon lighting system, including bulb-changing, should be carried out by technically-qualified personnel only. Otherwise, there is a risk of fatal injury. ◀

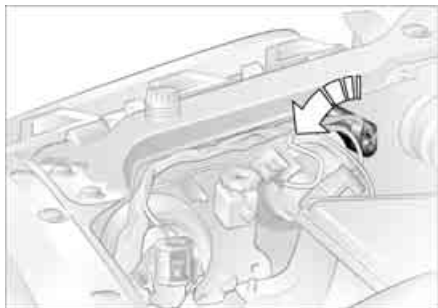

Parking lamps

5 watt bulb

Engine compartment, left side:

1. Turn the bulb holder to the left and remove
2. Remove and replace the bulb.

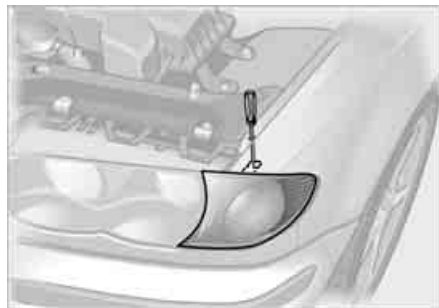

Front turn signal indicators

21 watt bulb

1. Extend a screwdriver through the upper opening and loosen the screw, continuing until you can extract the bulb by removing it from the front
2. Disconnect the plug
3. Apply gentle pressure and turn the bulb toward the letters AUF – refer to the marking on the housing– then remove it for replacement
4. Connect the plug

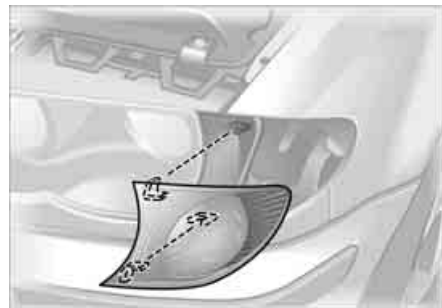

5. Align the lamp assembly's two ridges and the centering pin with the guides on the vehicle when installing
6. Slide in the lamp, applying gentle pressure to seat it firmly
7. Tighten the screw.

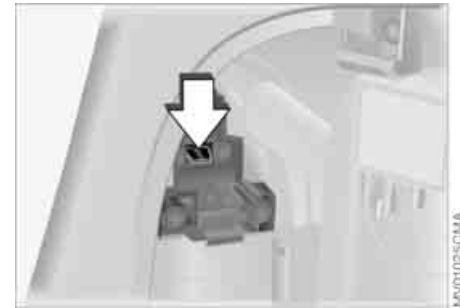
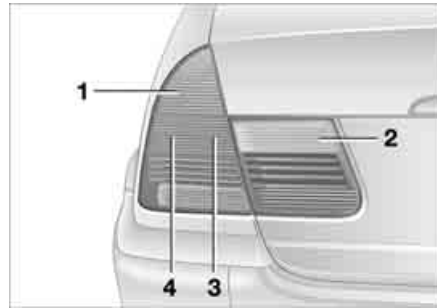
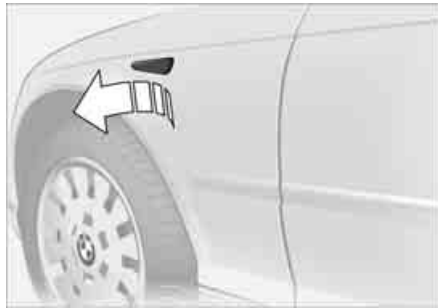

Side turn signal indicators

5 watt bulb

1. Press the back edge of the lamp toward the front with the tip of your finger and remove
2. Apply gentle pressure to the bulb while turning it to the left to remove.

Rear lamps

All bulbs: 21 watts

- 1 Turn signal indicator
- 2 Backup lamp
- 3 Tail lamp
- 4 Tail lamp/brake lamp

Section of the left cargo area:

Bulbs in the fender:

All of the bulbs are integrated in a central bulb holder.

1. Release and remove the cargo area side panel
2. Release and remove the bulb holder – see arrow
3. Remove the power plug and lay the bulb holder to one side, for instance, on the floor of the cargo area
4. Applying light pressure, turn the bulb to the left. Remove and replace the bulb
5. Plug in the power supply fitting
6. Press the bulb holder into position until you hear it engage.

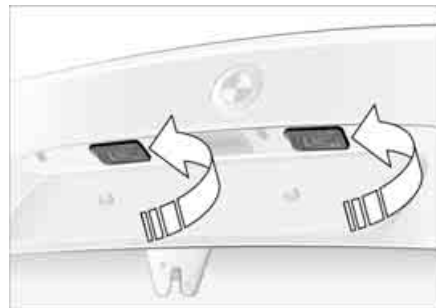

Bulbs in tailgate:

1. Insert a screwdriver in the recess – see arrow – and press down to release the assembly

2. Fold the trim panel down, release the bulb holder and remove
3. Applying light pressure, turn the bulb to the left. Remove and replace the bulb
4. Press the bulb holder into position until you hear it engage
5. Press the trim panel back in, continuing until you hear it snap into place.

License plate lamps

5 watt bulb

1. Place a screwdriver in the slot and press toward the left to release the lens
2. Replace the bulb.

Center high-mount brake lamp

LED strip on the rear window.

Please contact your BMW center in case of a malfunction.

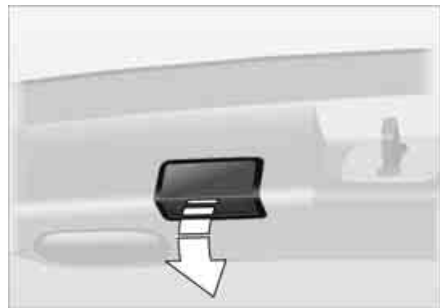

Tailgate lamp

5 watt bulb

1. Pull out the bulb socket
2. Replace the bulb.



Safety precautions in the event of a flat tire or wheel change:

Stop the vehicle as far as possible from passing traffic. Park on a firm, flat, surface. Switch on the hazard warning flashers. Turn the steering wheel to the straight-ahead position and engage the steering lock. Shift into 1st or Reverse, or if you have an automatic transmission position the selector lever in Park, and engage the parking brake.

All passengers should be outside the vehicle and well away from your immediate working area, behind a guardrail, for instance.

If a warning triangle or portable hazard warning lamp is available, set it up on the roadside at an appropriate distance from the rear of the vehicle. Comply with all local safety guidelines and regulations.

Change the wheel only on a level, firm surface which is not slippery. Avoid jacking the vehicle on a soft or slippery support surface – snow, ice, loose gravel, etc. – as either the vehicle or the jack could slip sideways.

Position the jack on a firm support surface.

Do not place wooden blocks or similar objects under the jack. They could prevent the jack from extending to its full

height and reduce its support capacity. Do not lie under the vehicle or start the engine when the vehicle is supported by the jack. There is otherwise a risk of fatal injury. ◀

Your BMW is equipped with a spare tire or a space-saver spare tire designed for temporary use in maintaining the vehicle's mobility in an emergency.



To remove the spare tire, lift the floor panel in the cargo area completely out, refer to page 113. ◀

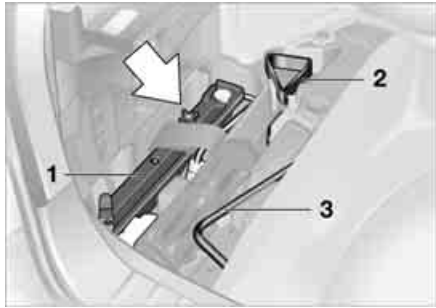

What you will need

In order to avoid rattling noises later, note the position of the tools when you remove them and return them to their original position when you are done using them.

▷ Jack 1

Open the left side cover and remove. Fold up the floor panel, lift away the spare tire cover, and screw off the red wing nut.

When you have completed work, screw the jack all the way back down. Fold the handle back and insert it in its holder

▷ Chock 2

Behind the vehicle jack. Loosen the wing nut to remove it

▷ Lug wrench 3

▷ Spare tire or space-saver spare tire – Located next to the jack.

Loosen the wing nut by hand, remove the storage shelf and take the wheel out.

Procedure

1. Read and comply with the safety precautions provided on the previous page

2. Secure the vehicle to prevent it from rolling:

Place the chock against the rear surface of the front tire on the side opposite the side being raised. If the vehicle is parked on a downward slope, place the chock securely in front of the tire. If the

wheel must be changed on a surface with a more severe slope, take additional precautions to secure the vehicle from rolling

3. Wheels with full wheel covers*: reach into the ventilation openings and pull the cover off
4. Loosen the lug bolts by rotating half a turn

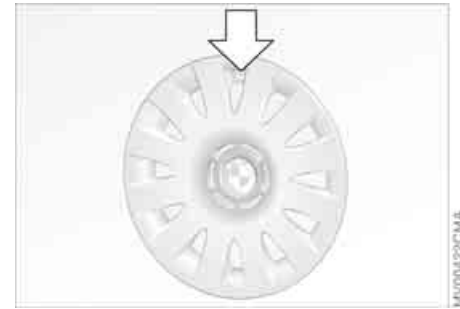
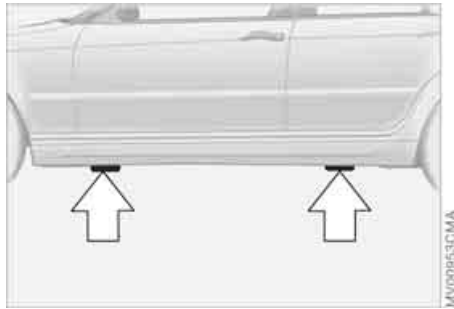

5. Position the jack at the jacking point closest to the flat tire with the jack base vertically below the jacking point. The entire surface of the head of the jack moves into the square recess of the jacking point – refer to the detail in the next illustration – when the jack is cranked
 6. Jack the vehicle up until the wheel you are changing is raised from the ground
 7. Unscrew the lug bolts and remove the wheel
 8. Remove accumulations of mud or dirt from the mounting surfaces of the wheel and hub. Clean the lug bolts
 9. Position the new wheel or the space-saver spare tire on the hub and screw at least two lug bolts finger-tight into opposite bolt holes
 10. Screw in the remaining lug bolts. Screw in all the bolts in a diagonal pattern
 11. Lower the jack and remove it from beneath the vehicle
 12. Tighten the lug bolts securely in a diagonal pattern
 13. Wheels with full wheel covers*: place the wheel cover with the valve opening over the valve. Use both hands to press the cover securely onto the rim
 14. Check and correct the tire inflation pressure at the earliest opportunity. Vehicles with Flat Tire Monitor: after mounting the spare tire or correcting the tire inflation pressure, reinitialize the system, refer to page 91.
- Protect valve stems and valves from dirt using screw-on valve stem caps. Dirty valve stems frequently lead to slow pressure loss.

 Do not attempt to install the full wheel cover on the space-saver spare tire, since this could damage the cover. ◀

 The vehicle jack is designed for changing wheels only. Do not attempt to raise another vehicle model with it or to raise any other type of load. To do so could cause accidents and personal injury.

To ensure continued safety, have the tightness of the torque bolts checked with a calibrated lug wrench – torque specification: 88.5 lb ft/120 Nm – at the earliest opportunity. ◀

When storing a wheel in the spare tire recess, take care to avoid bending the threaded rod.

If the original BMW light-alloy wheels have been replaced with other light-alloy wheels, different lug bolts may be required.

Replace the defective tire as soon as possible and have the new wheel/tire balanced.

Driving with the space-saver spare tire

Drive cautiously. Do not exceed a speed of 50 mph / 80 km/h.

Be aware that vehicle handling may be altered. Anticipate, e.g., reduced tracking during braking, longer braking distances, and changed steering characteristics when approaching limit conditions. These handling characteristics will be even more pronounced if winter tires are mounted.

 Only one space-saver spare tire may be mounted at one time. Mount a wheel and tire of the original size at the earliest possible opportunity. ◀

Driving with a spare tire*

 For certain wheel/tire combinations, the size of the spare tire will differ from that of the remaining tires. The spare tire is fully functional at all loads and speeds. However, the spare tire should be replaced at the earliest possible opportunity in order to achieve the original operating conditions. ◀

Run Flat tires*



Run Flat tires are labeled on the sidewall with a circular symbol containing the letters RSC. Run Flat tires consist of self-supporting tires and special rims. The tire reinforcement ensures that driving remains possible to a restricted degree in the event of pressure drop or even if the tire is deflated.

 When mounting or replacing summer tires with winter tires, or vice versa, use Run Flat tires since no spare wheel is available in the event of a flat. In this event, BMW recommends consulting your BMW center. Your BMW center has the information needed for working with Run Flat tires and is equipped with the necessary special tools. ◀

Run Flat tires*

Driving with a damaged tire

Depending on the cargo load, Run Flat tires allow you to continue driving at a maximum speed of 50 mph / 80 km/h. If there is a total loss of tire inflation pressure, 0 psi/0 kPa, or obvious tire damage, you can determine the distance you may continue driving based on the following values:

- ▷ With a light load:
 - 1 to 2 persons without luggage:
approx. 150 miles/250 km
- ▷ With a medium load:
 - 2 persons, full cargo area; or 5 persons without luggage:
approx. 100 miles/150 km
- ▷ With a full load:
 - 5 persons, full cargo area:
approx. 30 miles/50 km.

 Drive cautiously. Do not exceed a speed of 50 mph / 80 km/h. Be aware that vehicle handling will be altered when there is a loss in inflation pressure. Anticipate, e.g., reduced tracking during braking, longer braking distances and changed steering characteristics.

For safety reasons, BMW recommends not having damaged Run Flat tires repaired. In this case, consult your BMW center. ◀

Battery

Maintenance

The battery is absolutely maintenance-free, that is, the original electrolyte will normally last for the service life of the battery under moderate climatic conditions.

 Please consult your BMW center whenever you have any questions concerning the battery. ◀

Charging the battery

When charging the battery in the vehicle, leave the engine off at all times. Connect the charge cables to the terminals in the engine compartment. For terminal locations, refer to Jump-starting on page 153.

Disposal

 Return used batteries to a recycling point or your BMW center. Maintain the battery in an upright position for transport and storage. Secure the battery against tilting during transport. ◀

Fuses

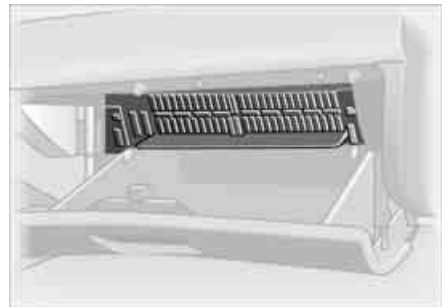

You will find the fuses and information on their respective allocation in the glove compartment behind a panel with two snap clips.

 Do not attempt to repair a blown fuse or replace it with a fuse having a different color or amperage rating. To do this could cause a fire in the vehicle resulting from a circuit overload. ◀

The BMW Group's Mobile Service offers you 24-hour assistance in the event of a breakdown, even on weekends and holidays.

The telephone numbers of the Mobile Service control center in your country are listed in the BMW Dealer Directory.

If your vehicle has the necessary equipment, you can contact the Mobile Service or issue an emergency call using buttons in the interior rearview mirror.

When an emergency call is initiated, a telephone connection is established with the general emergency call center.

In vehicles with activated BMW Assist function, a telephone connection is set up to the BMW Assist emergency call center. If the current location of your vehicle can be determined, this location is transmitted to the BMW Assist emergency call center.

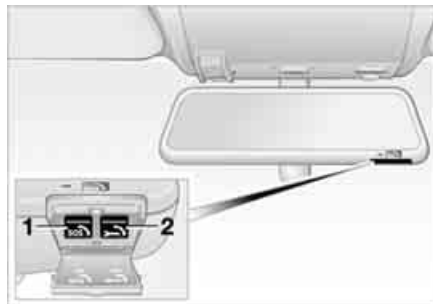

Fold down the cover.

- 1 Emergency call
- 2 Mobile Service

Requirements for initiating an emergency call or contacting Mobile Service:

- ▷ The car phone is registered with a mobile network
- ▷ The emergency call system is operational.

Initiating an emergency call*

Press button 1 for at least 2 seconds.

The indicator lamp above the buttons lights up. As soon as a telephone connection has been set up to the main emergency call center, the indicator lamp flashes.

If the indicator lamp is flashing but you cannot hear the emergency call center, you may still be heard by the emergency call center.

 For technical reasons, the emergency call function cannot be guaranteed in certain unfavorable conditions. ◀

If certain requirements are met, an emergency call is automatically initiated after a serious accident. The automatic emergency call will not be hindered by pressing the button.

Mobile Service*

To establish contact with the BMW Group's Mobile Service:

Press button 2 for at least 2 seconds.

The indicator lamp above the buttons lights up. As soon as a telephone connection has been set up with the Mobile Service, the indicator lamp flashes.

Depending on the country you are in, your vehicle's current location will also be transmitted if your vehicle is equipped with an activated BMW Assist function.

Jump-starting

When your battery is discharged, you can use two jumper cables to start your vehicle with power from the battery in a second vehicle. You can also use the same method to help start another vehicle. Only use jumper cables with fully insulated handles on the terminal clamps.

 Do not touch high-voltage wiring and cables on a running engine. Contact with components carrying high voltage can be harmful or fatal. Carefully observe the following instructions to avoid personal injury and/or damage to one or both vehicles. ◀

Preparations

1. Check whether the battery of the support vehicle has 12 volts and approximately the same capacity – measured in Ah. This information is provided on the battery
2. Stop the engine of the support vehicle
3. Switch off all electrical components in both vehicles.

 Make absolutely certain that there is no contact between the bodywork of the two vehicles, otherwise there is a short circuit hazard. ◀

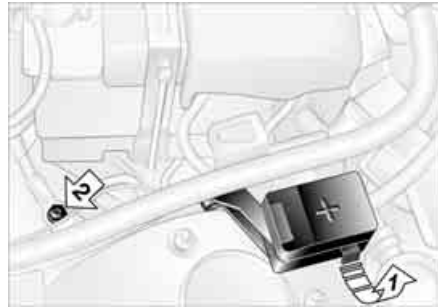

Connecting the jumper cables

 Always adhere to this sequence when connecting jumper cables; failure to observe this procedure can lead to sparks at the battery terminals and pose an injury hazard. ◀

The auxiliary jump-starting terminal located in your BMW's engine compartment acts as the positive battery terminal. Refer to the engine compartment overview on page 130. The cover of this auxiliary terminal is marked with a +.

1. Open the cover of the BMW auxiliary jump-starting terminal. Do so by pulling the tab – see arrow 1

2. Connect one terminal clamp of the plus/+ jumper cable to the positive terminal of the battery or to an auxiliary jump-starting terminal of the support vehicle
3. Connect the second terminal clamp of the plus/+ jumper cable to the positive terminal of the battery or to an auxiliary jump-starting terminal of the vehicle to be started
4. Your BMW is equipped with a special nut – see arrow 2 – to serve as the ground or negative terminal. Attach a terminal clamp of the minus/- jumper cable to the negative terminal of the support vehicle's battery or to a suitable ground on its engine or bodywork
5. Attach the second terminal clamp of the minus/- jumper cable to the negative terminal of the battery or to a suitable ground on the engine or bodywork of the vehicle to be started.

Starting the engine

1. Start the engine of the support vehicle and let it run for several minutes at a slightly elevated engine idle speed

2. Start the engine of the other vehicle as usual.

If the first start attempt is not successful, wait a few minutes before another attempt in order to allow the discharged battery to recharge

3. Allow the engines to run for several minutes
4. Disconnect the jumper cables in reverse sequence.

Depending on the cause of the fault, have the battery checked and recharged by your BMW center.

 Do not use spray starter fluids to start the engine. ◀

Towing the vehicle



Always observe all applicable towing laws and regulations. ◀

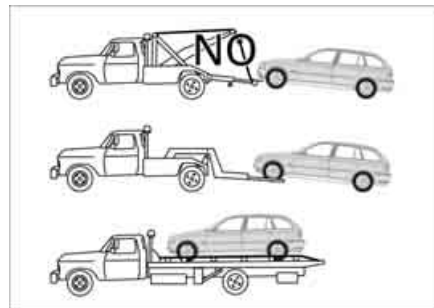

Towing with a commercial tow truck

- ▷ Use wheel lift or flat bed carrier
- ▷ Do not tow with sling-type equipment.



Never allow passengers to ride in a towed vehicle for any reason. Never attach tie-down hooks, chains, straps, or tow hooks to tie rods, control arms, or any other part of the vehicle suspension, as severe damage to these components will occur, possibly leading to accidents. ◀

Towing the vehicle

Towing the vehicle with the front axle raised

Vehicles with automatic transmission:

1. Towing speed: maximum 45 mph / 70 km/h
2. Towing distance: maximum 90 miles/150 km.

Vehicles with sequential manual gear-box SMG:

While the ignition is on, move the selector lever to position N, then turn off the ignition.

325xi: towing the vehicle with the front or rear axle raised

1. Place the transmission in Neutral
2. Switch off the engine
3. Towing speed:
max. 30 mph / 50 km/h
4. Towing distance:
max. 90 miles/150 km.

 Remove the rear driveshaft for longer towing distances with the front axle lifted; remove the front driveshaft for towing over longer distances with the rear axle lifted. Failure to comply with this will result in damage to the transfer box. ◀

Towing eyelet

The screw-in towing eyelet is stored in the onboard tool kit; be sure that it remains in the vehicle at all times. It can be attached at the front or rear of the vehicle. The towing eyelet should not be used to pull a vehicle out of deep snow, mud, sand, etc. Always observe all applicable towing laws and regulations.



Access to tow sockets

Front:

Press out the cover panel with a screwdriver inserted in the recess at the top.



Rear:

Press out the cover panel with a screwdriver inserted in the recess at the top.

 Use only the towing eyelet supplied with the vehicle and screw it in firmly until it stops. Use the towing eyelet for towing on paved roads only. If you do not follow these instructions, the towing eyelet could be torn out and vehicle damage could occur. Never attach tie-down hooks, chains, straps, or tow hooks to tie rods, control arms, or any other part of the vehicle suspension, as severe damage to these components will occur, possibly leading to accidents. ◀

 Avoid staggered towing and be careful that the towing strap is taut before starting to drive the vehicle doing the towing. ◀

Use only a nylon towing strap to tow the vehicle, since the inherent resilience of this material helps protect both vehicles from sudden jerking movements.

 The towed vehicle should always be the lighter of the two vehicles. If this is not the case, it will not be possible to control vehicle handling. ◀

Tow-starting

For instructions on jump-starting, refer to page [153](#).

Never attempt to use your vehicle to push another car, since damage to the energy-absorbing bumpers could result.

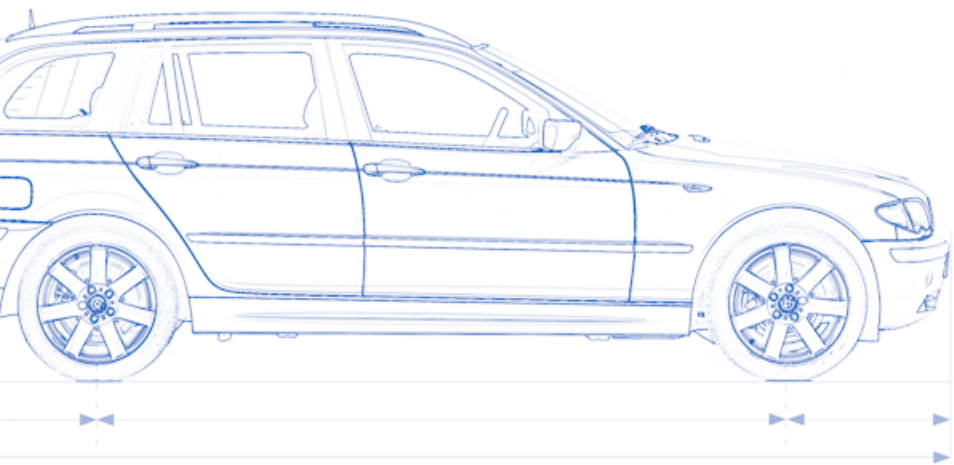

Overview

Controls and features

Operation, maintenance

Owner service procedures

Technical data

Index

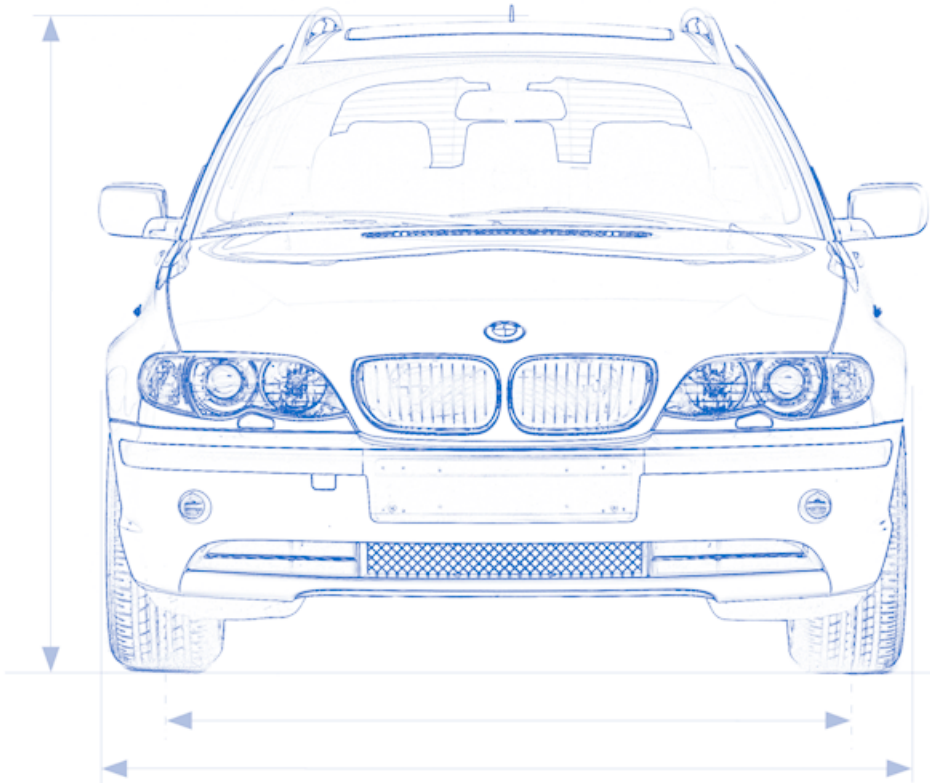

Overview

Controls

Maintenance

Repairs

Data

Index

160 **Engine data**

		325i, 325xi
Displacement	cu in/cm ³	152.2/2,494
Number of cylinders		6
Maximum power output at engine speed	hp rpm	184 6,000
Maximum torque at engine speed	lb ft/Nm rpm	175/237 3,500
Compression ratio	ϵ	10.5
Stroke	in/mm	2.95/75
Bore	in/mm	3.31/84
Fuel mixture preparation		Digital electronic engine-management system (DME)

325xi: power can be tested only on a suitable dynamometer.

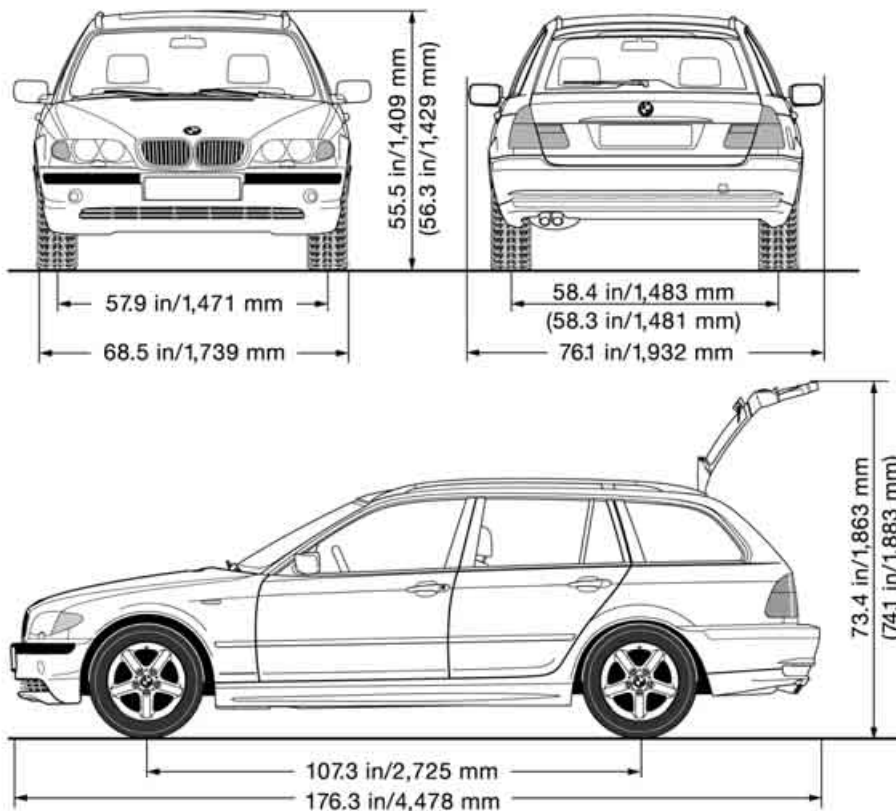

Dimensions in () apply to BMW 325xi. Height with roof rail 56.8 in/1,444 mm (57.6 in/1,464 mm).
 Minimum turning circle dia.: 34.4 feet/10.5 m (35.8 feet/10.9 m).

		325i	325xi
Curb weight			
with manual transmission/SMG	lbs/kg	3,362/1,525	3,594/1,630
with automatic transmission	lbs/kg	3,450/1,565	3,627/1,645
Approved gross vehicle weight			
with manual transmission/SMG	lbs/kg	4,509/2,045	4,696/2,130
with automatic transmission	lbs/kg	4,597/2,085	4,729/2,145
Approved front axle load	lbs/kg	1,984/900	2,139/970
Approved rear axle load	lbs/kg	2,668/1,210	2,657/1,205
Approved roof load capacity	lbs/kg	165/75	165/75
Cargo area capacity	cu ft/l	15.4-57.1/435-1,617	15.4-57.1/435-1,617

Approved axle loads and approved gross vehicle weight must never be exceeded.

			Notes
Fuel tank	gal./liters	approx. 16.6/63	Fuel specification, refer to page 25
Reserve	gal./liters	approx. 2.1/8	
Windshield/ Headlamp washer reservoir front	quarts/liters	approx. 5.6/5.3	Specifications, refer to page 132
Rear window washer reservoir	quarts/liters	approx. 2.4/2.3	
Engine oil and filter change	quarts/liters	325i: approx. 6.9/6.5 325xi: approx. 7.9/7.5	BMW High Performance Synthetic Oil Oil specifications, refer to page 132
Manual and automatic transmission, transfer box and differential		–	Lifetime lubricant, no oil change required

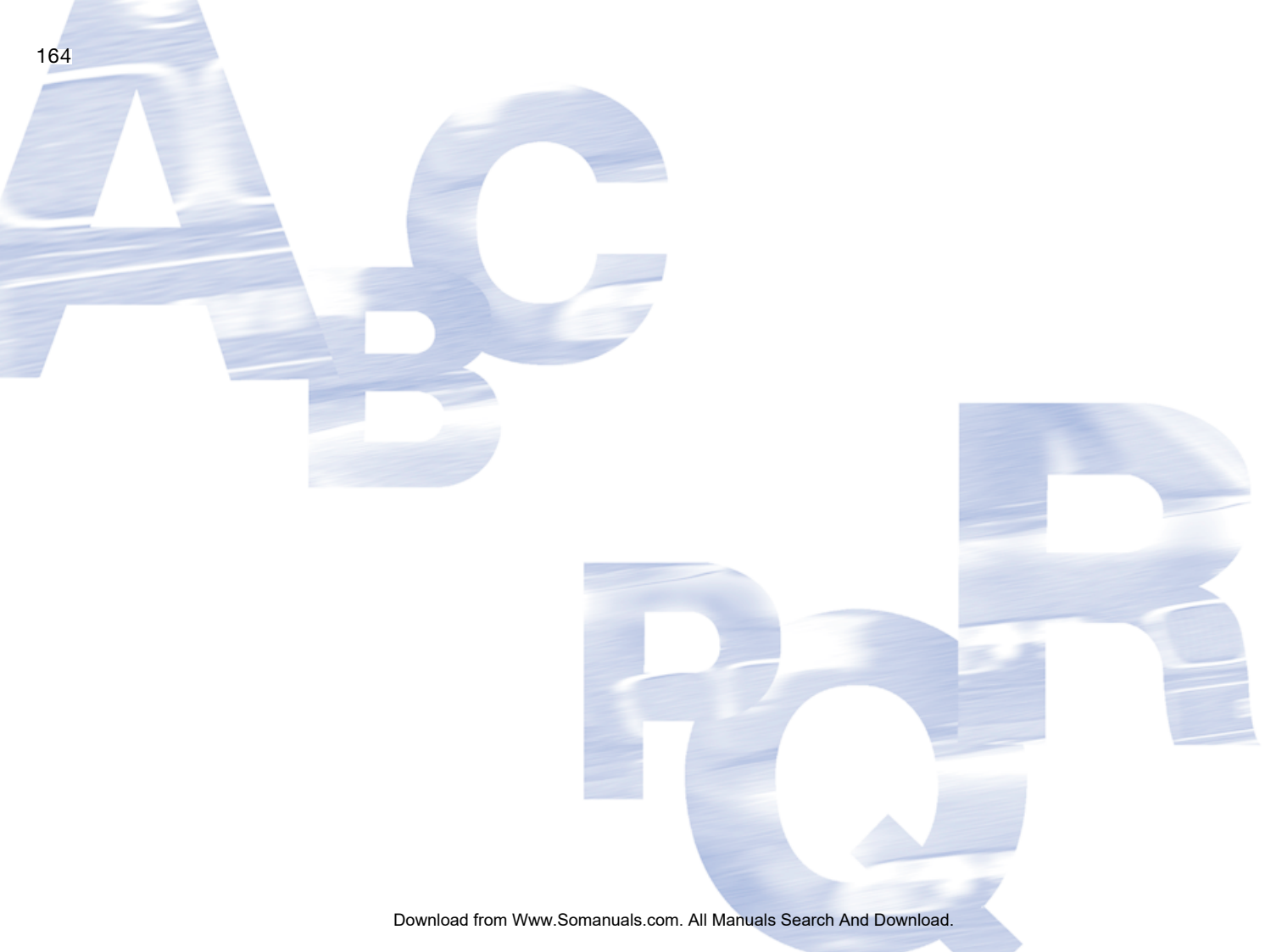



Overview

Controls and features

Operation, maintenance

Owner service procedures

Technical data

Index

Overview

Controls

Maintenance

Repairs

Data

Index

Everything from A to Z

A

ABS Antilock Brake System [121](#)
indicator lamp [18](#)
Acceleration assistant [70](#)
Accessories, refer to For your own safety [5](#)
Accident, refer to Emergency call [152](#)
Activated-charcoal filter [104](#)
ADB-X Automatic Differential Brake, all-wheel [88](#)
Adding brake fluid [135](#)
Additional sources of information [4](#)
Air conditioning [96](#)
Air conditioning mode [98](#)
automatic climate control [102](#)
Air distribution
air conditioning [98](#)
automatic climate control [102](#)
Air distribution, individual [102](#)
Air outlets, refer to Ventilation [96](#), [100](#)
Air pressure, refer to Tire inflation pressure [25](#), [124](#)
Air recirculation, refer to Recirculated-air mode [98](#), [103](#)

Air supply
air conditioning [98](#)
automatic climate control [102](#)
Air, drying, refer to Air conditioning mode [98](#), [102](#)
Airbags [54](#)
indicator lamp [18](#), [56](#)
sitting safely [44](#)
Airing out, refer to Ventilation [96](#), [100](#)
Alarm system [38](#)
avoiding unintentional alarms [39](#)
All-season tires, refer to Winter tires [127](#)
Antifreeze [134](#)
coolant [134](#)
washer fluid [132](#)
Antilock Brake System (ABS) [121](#)
indicator lamp [18](#)
Anti-theft system [30](#)
Anti-theft warning system, refer to Alarm system [38](#)
Approved axle loads, refer to Weights [162](#)
Approved gross weight, refer to Weights [162](#)
Armrest
front [106](#)
rear [107](#)

Artificial leather, refer to the Caring for your vehicle brochure
Ashtray
front [108](#)
rear [108](#)
AUC Automatic recirculated-air control [103](#)
AUTO program, refer to Automatic air distribution [102](#)
Automatic
air distribution [102](#)
air supply [102](#)
cruise control [77](#)
headlamp control [93](#)
Automatic car wash, refer to the Caring for your vehicle brochure
Automatic climate control [100](#)
Automatic curb monitor [51](#)
Automatic Differential Brake, all wheel ADB-X [88](#)
Automatic dimming, interior rearview mirror [53](#)
Automatic recirculated-air control (AUC) [103](#)

Automatic transmission with Steptronic [71](#)
indicator lamp [19](#), [73](#)
interlock [63](#)
selector lever lock [71](#)
shiftlock [71](#)
Automatic windshield washer, refer to Rain sensor [75](#)
Average fuel consumption [84](#)
Average speed [84](#)
Avoiding unintentional alarms [39](#)
Axle loads, refer to Weights [162](#)

B

Backrest, adjusting [46](#)
Backrest, refer to Seat adjustment [45](#), [47](#)
Backup lamps [66](#)
bulb replacement [145](#)
Bandages, refer to First-aid kit [23](#)
Battery [151](#)
charge [151](#)
disposal [151](#)
indicator lamp [18](#)
jump-starting [153](#)
remote control [30](#), [31](#)
Battery charge current [18](#)

- Belts, refer to Safety belts [48](#)
- Beverage holders [106](#), [107](#)
- Blower
 - air conditioning [98](#)
 - automatic climate control [102](#)
- BMW High Performance Synthetic Oils [133](#)
- BMW Maintenance System [136](#)
- BMW sports seat [46](#)
- Bore, refer to Engine data [160](#)
- Bottle holders, see Beverage holders [106](#), [107](#)
- Brake fluid [135](#)
 - indicator lamp [18](#), [135](#)
 - level [135](#)
- Brake force display [92](#)
- Brake hydraulic system [122](#)
- Brake lamps
 - bulb replacement [145](#)
 - indicator lamp, defective lamp [81](#)
- Brake lights
 - brake force display [92](#)
- Brake pads
 - brake fluid level [18](#), [122](#), [135](#)
 - breaking in [120](#)
 - disc brakes [122](#)
- Brake rotors
 - brake system [122](#)
 - breaking in [120](#)
- Brake system
 - brake pads, indicator lamp [19](#)
- Brake wear warning indicator lamp [19](#)
- Brakes
 - ABS [121](#)
 - brake fluid [135](#)
 - breaking in [120](#)
 - indicator/warning lamp [18](#), [19](#)
 - parking brake [65](#)
- Break-in procedures [120](#)
- Bulb replacement, refer to Lamps and bulbs [143](#)
- Bulb, replacing [143](#)
- Buttons in steering wheel [22](#)
- C**
- California Proposition 65 warning [138](#)
- Can holders, see Beverage holders [106](#), [107](#)
- Capacities [163](#)
- Car battery [151](#)
- Car care, refer to the Caring for your vehicle brochure
- Car keys, refer to Keys [30](#)
- Car radio, refer to Owner's Manual for Radio/Onboard Computer
- Car telephone
 - preparation [107](#)
- Car telephone, refer to the separate Owner's Manual
- Car vacuum cleaner, connecting [108](#)
- Car wash, refer to the Caring for your vehicle brochure
- Cargo area [37](#), [111](#)
 - cover [111](#)
 - emergency release, refer to Manual operation [36](#)
 - floor panel [113](#)
 - lamps [35](#)
 - lid, refer to Tailgate [35](#)
 - opening, remote control [32](#)
 - volume [162](#)
- Cargo, securing [115](#)
- Carpet care, refer to the Caring for your vehicle brochure
- Cassette operation, refer to the Owner's Manual for Radio/Onboard Computer
- CBC Cornering Brake Control [121](#)
 - warning lamp [18](#)
- CD changer, refer to the Owner's Manual for Radio/Onboard Computer
- CD operation, refer to the Owner's Manual for Radio/Onboard Computer
- Cellular phone [107](#)
- Center high-mount brake lamp
 - bulb replacement [146](#)
- Central locking system [30](#)
 - button [35](#)
 - passenger compartment [35](#)
- Charge indicator lamp [18](#)
- Check Control [81](#)
- Check Gas Cap indicator lamp [19](#)
- Child safety locks [60](#)
- Child seats [57](#)
- Child-restraint mounting system (LATCH) [59](#)
- Child-restraint systems [57](#)
- Chock [148](#)
- Cigarette lighter [108](#)
- Cigarette lighter socket [108](#)
- Clean rear window [76](#)
- Cleaning chrome parts, refer to the Caring for your vehicle brochure

Everything from A to Z

- Cleaning light alloy wheels, refer to the Caring for your vehicle brochure
- Cleaning the vehicle, refer to the Caring for your vehicle brochure
- Cleaning windshield [76](#)
- Clock [82](#)
 - 12-/24-hour mode [82](#)
- Setting, refer also to the Owner's Manual for Radio/Onboard Computer
- Closing
 - from inside [35](#)
 - from outside [31](#)
- Clothes hooks [121](#)
- Clutch
 - breaking in [120](#)
- Cockpit [14](#)
- Code, refer to the Owner's Manual for Radio/Onboard Computer
- Coin box [106](#)
- Cold start, refer to Starting the engine [63](#)
- Compact disc operation, refer to the Owner's Manual for Radio/Onboard Computer
- Compartments [106](#)
- Compartments in cargo area [113](#)
- Compression ratio, refer to Engine data [160](#)
- Computer [83](#)
- Condensation, refer to Air conditioning mode [98](#), [102](#)
- Configuring settings, refer to Vehicle Memory, Key Memory [61](#)
- Connecting a vacuum cleaner, refer to Cigarette lighter [108](#)
- Consumption
 - display [79](#)
- Consumption, refer to Average fuel consumption [84](#)
- Control elements, refer to Cockpit [14](#)
- Convenience operation
 - from outside [34](#)
 - glass sunroof [32](#)
 - windows [32](#)
- Coolant [134](#)
 - indicator lamp [19](#), [80](#)
 - level [134](#)
 - temperature gauge [80](#)
- Coolant water, refer to Coolant [134](#)
- Cooling, refer to Temperature [98](#), [102](#)
- Copyright [4](#)
- Cornering Brake Control (CBC) [121](#)
 - warning lamp [18](#)
- Correct tires [127](#)
- Cover, refer to Cargo area cover [111](#)
- Cruise control [77](#)
 - indicator lamp [20](#)
- Cup holders, see Beverage holders [106](#), [107](#)
- Curb weight, refer to Weights [162](#)
- Current consumption, refer to Energy control [79](#)
- Cylinders, refer to Engine data [160](#)
- D**
- Dashboard, refer to Cockpit [14](#)
- Data
 - capacities [163](#)
 - dimensions [161](#)
 - engine [160](#)
 - technical [160](#)
 - weights [162](#)
- Daytime driving lamps [93](#)
- DBC Dynamic Brake Control [19](#), [121](#)
- Deep water, refer to Water on roadways [121](#)
- Defrost position, refer to Defrosting windows [99](#), [102](#)
- Defrosting and demisting windows
 - air conditioning [99](#)
 - automatic climate control [102](#)
- Defrosting windows [99](#), [102](#)
- Defrosting windshield, refer to Defrosting windows [99](#), [102](#)
- Demisting windows
 - air conditioning [99](#)
 - automatic climate control [102](#)
- Determining the maximum load [114](#)
- Differential
 - breaking in [120](#)
- Digital clock [82](#)
- Dimensions [161](#)
- Dipstick, engine oil [132](#)
- Disc brakes [122](#)
- Displacement, refer to Engine data [160](#)
- Display lighting, refer to Instrument lighting [94](#)
- Displays, refer to Instrument cluster [16](#)

Disposal
oil 133
vehicle battery 151

Distance warning, refer to
Park Distance Control
(PDC) 85

Door key 30

Door lock 34

Doors
emergency operation 34

Draft-free ventilation 99, 103

Driving light, refer to Parking
lamps/Low beams 93

Driving notes 121

Dry air, refer to Air condi-
tioning mode 98, 102

DSC Dynamic Stability Con-
trol 86
indicator lamp 19, 86

DTC Dynamic Traction Con-
trol 86
indicator lamp 19, 86

Dynamic Brake Control
(DBC) 19, 121
indicator lamp 19

Dynamic Stability Control
(DSC) 19, 86

Dynamic Traction Control
(DTC) 86
indicator lamp 19, 86

E

Electric glass sunroof 41

Electric power windows 40

Electrical accessories, fail-
ure 151

Electrical malfunction
automatic transmission
with Steptronic 73

door lock 34

driver's door 34

fuel filler door 24

glass sunroof 43

tailgate 36

Electronic Stability Program
(ESP), refer to Dynamic
Stability Control (DSC) 86

Emergency call 152

Emergency operation
doors 34
driver's door 34
fuel filler door 24
glass sunroof 43

Emergency release
tailgate 36

Emissions, minimum, refer
to Energy control 79

Energy control 79

Engine
breaking in 120
data 160
electronics 19
indicator lamp 19
speed 79, 160
starting 63
switching off 65

Engine compartment 130

Engine coolant 134
adding 134

Engine oil
adding 133
additives, refer to Adding
engine oil 133
capacity 163
indicator/warning lamp 19
quality 133
viscosity 134

Engine oil consumption 132

Engine oil level 19
check 132
indicator/warning lamp 18

Engine oil pressure
indicator/warning lamp 18

Engine oil types 133

Engine output, refer to
Engine data 160

Engine speed 79, 160

Environmentally-friendly
driving, refer to Energy
control 79

ESP Electronic Stability Pro-
gram, refer to Dynamic
Stability Control DSC 86

Exterior mirrors 52

Eyeglasses
compartment 107

Eyelet, towing 155

F

False alarm, refer to
Avoiding unintentional
alarms 39

Fastening the safety belts 48

Fault displays 81

First aid, refer to First-aid
kit 23

First-aid kit 23

Flashlight 106

Flashlight, refer to
Rechargeable
flashlight 106

Flat tire 147
Flat Tire Monitor 91
space-saver spare tire 147

Flat Tire Monitor 91
indicator lamp 18, 19, 92

Flat tire, refer to Tire condi-
tion 124

Floor panel, lifting 113

Fluid reservoir for washer
systems 132

Everything from A to Z

Fog lamps [95](#)
indicator/warning lamp [20](#)
Folding rear backrest [111](#)
Follow me home lamps [93](#)
Footbrake, refer to General driving notes [121](#)
Front airbags [54](#)
Front center armrest [106](#)
Front fog lamps [95](#)
indicator lamp [20](#)
Fuel
display [80](#)
quality [25](#)
volume [163](#)
Fuel consumption
display [84](#)
Fuel display, refer to Fuel gauge [80](#)
Fuel economy, refer to Energy control [79](#)
Fuel filler door [24](#)
release following an electrical malfunction [24](#)
Fuel gauge [79](#)
Fuel level indicator, refer to Fuel gauge [80](#)
Fuel mixture preparation [160](#)
Fuel reserve indicator, refer to Fuel gauge [80](#)
Fuel tank capacity [163](#)
Fuses [151](#)

G
Gasoline consumption, refer to Average fuel consumption [84](#)
Gasoline, refer to Fuel specifications [25](#)
Gear indicator [69, 73](#)
Gear lever
automatic transmission with Steptronic [71](#)
sequential manual gearbox SMG [67](#)
Gearbox
manual transmission [66](#)
Gearshift lever
manual transmission [66](#)
General driving notes [121](#)
Glass sunroof
convenience operation [32, 34](#)
remote control [31, 32](#)
Glass sunroof, electric [41](#)
closing following an electrical malfunction [43](#)
Glove compartment [105](#)
Grills, refer to Ventilation [96, 100](#)
Gross weight, refer to Weights [162](#)

H
Handbrake, refer to Parking brake [65](#)
Hands-free system [107](#)
Harman Kardon premium sound system [105](#)
Hazard warning flashers [14](#)
Hazard warning triangle [23](#)
HDC Hill Descent Control [90](#)
Head airbags [54](#)
Head restraints [48](#)
Headlamp cleaning system
cleaning headlamps [76](#)
washer fluid [132, 163](#)
Headlamp control, automatic [93](#)
Headlamp flasher [94](#)
indicator lamp [21](#)
Headlamps
bulb replacement [143](#)
care, refer to the Caring for your vehicle brochure
Heated mirrors [52](#)
Heated rear window
air conditioning [98](#)
automatic climate control [103](#)
Heated seats [51](#)
Heating
exterior mirrors [52](#)
rear window [98, 103](#)
seats [51](#)

Heating and ventilation [96, 100](#)
Heavy loads, refer to Cargo loading [114](#)
Height adjustment
seats [45, 47](#)
steering wheel [52](#)
Height, refer to Dimensions [161](#)
High beams [74, 94](#)
bulb replacement [143](#)
headlamp flasher [94](#)
indicator lamp [21](#)
Hill Descent Control (HDC) [90](#)
Holder for
beverages [106, 107](#)
litter bag [107](#)
Hood release [129](#)
Horn [14](#)
Hub cap [148](#)
Hydraulic brake assistant, refer to DBC [121](#)
Hydraulic system
brakes [122](#)
Hydroplaning [121](#)
I
Ice warning [83](#)
Ignition [63](#)
Ignition key [30](#)
positions [63](#)

Ignition lock 63
Imprint 4
Indicator lamps 18
Indicator/warning lamp
 airbags 18
 alarm system 38
 brakes 18, 19
 Check Gas Cap 19
 coolant 19, 80
 DSC 19
 Flat Tire Monitor
 18, 19, 92
 fog lamps 20
 Please fasten safety
 belts 18
 reserve 80
 Service Engine Soon 19
Individual air distribution 102
Individual settings, refer to
 Vehicle Memory, Key
 Memory 61
Inflation pressure 124
Inflation pressure monitor-
 ing, refer to Flat Tire Moni-
 tor 91
Inflation pressure, tires 25
INSPECTION 81
Instrument cluster 16
Instrument lighting 94
Instrument panel 14
Interface socket for onboard
 diagnostics (OBD) 138

Interior lamps 95
 remote control 32
Interior motion sensor 38
 switching off 39
Interior rearview mirror 53
 automatic dimming
 feature 53
Interior temperature
 adjusting 98, 102
Interlock, refer to Steering
 wheel lock 63
Intermittent
 mode, wipers 75
Interval
 display, service 81

J

Jack 147
Jacking points 148
Jump-starting 153

K

Key Memory 61
Keys 30
 with remote control 30
Kickdown 68, 72

L

Lamp defect 143
Lamps and bulbs 143
Lashing down loads, refer to
 Cargo loading 113

Lashing eyelets, refer to
 Securing cargo 115
Lashing fittings, refer to
 Securing cargo 115
LATCH child-restraint
 mounting system 59
Leather care, refer to the
 Caring for your vehicle
 brochure
LEDs light-emitting
 diodes 95
Length, refer to
 Dimensions 161
License plate lamp
 bulb replacement 146
Light switch 93
Light-emitting diodes
 LEDs 95
Lighter 108
LIGHTS ON warning 93
Lights, refer to Parking
 lamps/Low beams 93
Litter bag holder 107
Load, refer to Cargo
 loading 113
Loading
 vehicle 113
Lock buttons on doors, refer
 to Locking 35
Lock, steering wheel 63

Locking
 from inside 35
 from outside 31, 34
Locking and unlocking
 doors
 from inside 35
 from outside 31, 34
Low beams 93
 automatic 93
 bulb replacement 143
 indicator lamp, defective
 lamp 81
Lug bolts 148
 key 148
 torque 148
Luggage area cover, see
 Cargo area cover 111
Luggage compartment, refer
 to Cargo area 37
Luggage net, refer to Parti-
 tion net 111
Luggage rack, refer to Roof-
 mounted luggage rack 116
Luggage straps 37
Lumbar support 47

M

M+S tires, refer to Winter
 tires 127
Maintenance 81, 136
Maintenance system 136

Everything from A to Z

Making telephone calls,
refer to the telephone
Owner's Manual

Malfunction

door lock [34](#)

fuel filler door [24](#)

Malfunction displays [81](#)

Manual operation

door lock [34](#)

driver's door [34](#)

fuel filler door [24](#)

glass sunroof [43](#)

tailgate [36](#)

Manual transmission [66](#)

Master keys

with remote control [30](#)

MC operation, refer to the

Owner's Manual for

Radio/Onboard Computer

MD operation, refer to the

Owner's Manual for

Radio/Onboard Computer

Mechanical seats [45](#)

Memory, refer to Seat and

mirror memory [50](#)

Memory, refer to Vehicle

Memory, Key Memory [61](#)

Microfilter

air conditioning [99](#)

automatic climate

control [104](#)

Microphone, refer to Cellular
phone [107](#)

Mini disc operation, refer to
the Owner's Manual for
Radio/Onboard Computer

Mirror

automatic curb monitor [51](#)

Mirrors [52](#)

heated [52](#)

memory, refer to Seat and
mirror memory [50](#)

Mobile Service [152](#)

Modifications, technical,

refer to For your own

safety [5](#)

Multifunction steering

wheel [22](#)

Multifunction switch

turn signal indicator/head-
lamp flasher [74](#)

washer/wiper system [75](#)

N

Navigation system, refer to
the Owner's Manual for

Radio/Onboard Computer

Neck restraints, refer to

Head restraints [48](#)

Nets [106](#)

Nozzles, refer to Ventilation

[96](#), [100](#)

O

OBD interface socket [138](#)

Odometer [79](#)

Oil

additives, refer to Adding
engine oil [133](#)

capacity [163](#)

dipstick [132](#)

quality [133](#)

viscosity [133](#)

Oil change interval, refer
to Service interval

display [136](#)

Oil change intervals, refer to
the Service and Warranty
Information Booklet for US
models/Warranty and Ser-
vice Guide Booklet for
Canadian models

Oil consumption [132](#)

Oil dipstick [132](#)

Oil filter change [163](#)

Oil level

checking [132](#)

indicator lamp [18](#)

Oil pressure

indicator lamp [18](#)

OIL SERVICE [81](#)

Oil types [133](#)

Old batteries, refer to Dis-
posal [151](#)

Onboard computer [83](#)

Onboard computer, refer to
the Owner's Manual for
Onboard Computer

Onboard tool kit [142](#)

Opening and closing

from inside [35](#)

from outside [31](#)

via door lock [34](#)

via remote control [31](#)

Outlets, ventilation [96](#), [100](#)

Outside temperature dis-
play [83](#)

changing unit of
measure [83](#)

P

Paintwork care, refer to the
Caring for your vehicle
brochure

Panic mode – trigger

alarm [32](#)

Park Distance Control

(PDC) [85](#)

Parking aid, refer to Park
Distance Control (PDC) [85](#)

Parking brake [65](#)

indicator lamp [18](#)

Parking lamps [93](#)

bulb replacement [144](#)

Parking lamps/Low

beams [93](#)

Partition net [111](#)

Parts and accessories, refer to Your individual vehicle 5
Passenger-side exterior mirror tilt function 51
PDC Park Distance Control 85
Pinch protection
 glass sunroof 42
Plastic, refer to the Caring for your vehicle brochure
Please fasten safety belts indicator lamp 18
Pollen, refer to Microfilter 99
Pollen, refer to Microfilter/Activated charcoal filter 104
Power output, refer to Engine data 160
Power seat 47
Power supply, refer to Cigarette lighter socket 108
Power windows
 safety switch 41
Pressure monitoring, tires Flat Tire Monitor 91
Pressure, tires 25, 124
Protective function
 electric power windows 40
Putting the vehicle into storage
 refer to the Caring for your vehicle brochure

R
Radio remote control key, refer to Master key with remote control 30
Radio, refer to the Owner's Manual for Radio
Rain sensor 75
Range 84
Reading lamps
 front 95
 rear 95
Rear armrest, refer to Rear center armrest 107
Rear backrest, folding 111
Rear center armrest 107
Rear lamps
 bulb replacement 145
 indicator lamp, defective lamp 81
Rear window
 remote control 32
Rear window defroster
 air conditioning 98
Rear window heating
 automatic climate control 103
Rear window shelf, refer to Cargo area cover 111
Rear window wiper 76
 changing 142
Rearview mirror 52
Receiving assistance 152

Recirculated-air mode
 air conditioning 98
 automatic climate control 103
Recirculating the air, refer to Recirculated-air mode 98, 103
Reclining seat, refer to Seat adjustment 45, 47
Refueling 24
 fuel filler door 24
Releasing
 hood 129
Remaining distance to service 81
Remaining distance, refer to Range 84
Remote control 31
 malfunction 32
Replacement key 31
Replacing lamps, refer to Lamps and bulbs 143
Replacing tires 125
Reporting safety defects 7
Restraint systems
 for children 57
Restraint systems, refer to Safety belts 48
Reverse
 automatic transmission with Steptronic 71
 SMG gearbox 68

Reverse gear
 manual transmission 66
Roof load capacity 162
Roof-mounted luggage rack 116
Run Flat tires 126, 150
S
Safe seating position 44
Safety belt height adjustment 49
Safety belts 48
 sitting safely 44
 warning lamp 18
Safety feature
 glass sunroof 42
Safety instructions 5
Safety switches for rear windows 41
Safety systems
 refer to Antilock Brake System 121
 refer to Dynamic Stability Control (DSC) 86
Screwdriver, refer to Onboard tool kit 142
Seat adjustment 45
 BMW sports seat 46
 mechanical 45
 power 47
Seat belt tensioner, refer to Safety belts 48

Everything from A to Z

- Seat heating [51](#)
 - Seat memory, refer to Seat and mirror memory [50](#)
 - Seat positions, storing [50](#)
 - Seats [45](#)
 - Securing cargo [115](#)
 - Securing the vehicle
 - from inside [35](#)
 - from outside [31](#), [34](#)
 - Selector lever
 - automatic transmission [71](#)
 - sequential manual gearbox SMG [67](#)
 - Selector lever lock, refer to Shiftlock [67](#), [71](#)
 - Selector lever positions
 - automatic transmission [71](#)
 - sequential manual gearbox SMG [67](#)
 - Sequential manual gearbox SMG [67](#)
 - indicator lamp [19](#)
 - Service and Warranty Information Booklet [136](#)
 - SERVICE ENGINE SOON warning lamp [19](#)
 - Service interval display [81](#), [136](#)
 - Shift paddles [68](#)
 - Shifting gears
 - automatic transmission with Steptronic [71](#)
 - sequential manual gearbox SMG [68](#)
 - Shiftlock [67](#)
 - Shiftlock, refer to Range selection [71](#)
 - Side airbags [54](#)
 - Side turn signal indicators
 - bulb replacement [145](#)
 - Sitting safely
 - with airbags [44](#)
 - with safety belts [44](#)
 - Size [161](#)
 - Ski bag [110](#)
 - Sliding/tilt sunroof, refer to Electric glass sunroof [41](#)
 - SMG sequential manual gearbox [67](#)
 - indicator lamp [19](#)
 - Smokers' package, refer to Ashtray [108](#)
 - Snow chains [128](#)
 - SOS, refer to Emergency call [152](#)
 - Space-saver spare tire
 - changing a wheel [147](#)
 - Spare key [30](#)
 - Spare tire [147](#)
 - Spare wheel [150](#)
 - Speed gauge, refer to Speedometer [16](#)
 - Speedometer [16](#)
 - Split rear backrest, refer to Folding rear backrest [111](#)
 - SPORT button [70](#)
 - Sport program
 - automatic transmission with Steptronic [72](#)
 - Sports seat [46](#)
 - Stability control, refer to Dynamic Stability Control (DSC) [86](#)
 - Standing lamps [94](#)
 - Starting difficulties
 - jump-starting [153](#)
 - temperature [63](#)
 - Starting help DSC [86](#)
 - Starting the engine [63](#)
 - Starting, refer to Starting the engine [63](#)
 - Status of the Owner's Manual [5](#)
 - Steering wheel lock [63](#)
 - Steering wheel, adjusting [52](#)
 - Steptronic, refer to Manual operation [72](#)
 - Storage compartments [106](#)
 - Storage nets [106](#)
 - Storage space, refer to Cargo area [111](#)
 - Storing seat positions, refer to Seat and mirror memory [50](#)
 - Storing tires [127](#)
 - Stroke, refer to Engine data [160](#)
 - Surface ice, refer to Ice warning [83](#)
 - Switches, refer to Cockpit [14](#)
 - Switching off
 - engine [65](#)
 - vehicle [65](#)
 - Symbols [4](#)
 - Synthetic oils [133](#)
- ## T
- Tachometer [79](#)
 - Tail lamps
 - bulb replacement [145](#)
 - Tail lamps, refer to Rear lamps [145](#)
 - Tailgate [35](#)
 - emergency operation [36](#)
 - indicator lamp [81](#)
 - opening from inside the vehicle [36](#)
 - opening from outside [35](#)
 - opening, remote control [32](#)
 - remote control [32](#)
 - unlocking manually [36](#)

- Tailgate lamp
 - bulb replacement [147](#)
- Tank capacity, refer to Fuel tank capacity [163](#)
- Tank indicator, refer to Fuel gauge [80](#)
- Technical data [160](#)
- Technical modifications [5](#)
- Technical modifications, refer to For your own safety [5](#)
- Telephone hookup [107](#)
- Telephone, refer to the separate Owner's Manual
- Television, refer to the Owner's Manual for Onboard Computer
- Temperature
 - air conditioning [98](#)
 - automatic climate control [102](#)
- Temperature adjustment [98](#), [102](#)
- Temperature display
 - engine coolant [80](#)
 - ice warning [83](#)
 - outside temperature [83](#)
 - setting units [83](#)
- Temperature layering [99](#), [103](#)
- Tempomat, refer to Cruise control [77](#)
- Thigh support area, adjusting [46](#)
- Third brake lamp, refer to Center high-mount brake lamp [146](#)
- Three-point safety belt [48](#)
- Through-loading system [111](#)
- Tilt alarm sensor [32](#)
 - remote control [32](#)
 - switching off [39](#)
- Tilting passenger-side exterior mirror [51](#)
- Time [82](#)
- Tire change [147](#)
- Tire pressure monitoring, refer to Flat Tire Monitor [91](#)
- Tire replacement [125](#), [147](#)
- Tires
 - age [126](#)
 - breaking in [120](#)
 - changing [147](#)
 - condition [128](#)
 - damage [124](#)
 - flat [147](#)
 - inflation pressure [25](#), [124](#)
 - replacing [125](#)
 - size, refer to Wheel and tire combinations [127](#)
 - storing [127](#)
 - tread [124](#)
 - treadwear indicator, refer to Tire tread – tire damage [124](#)
 - winter tires [127](#)
- Tools, refer to Onboard tool kit [142](#)
- Torque [160](#)
 - engine [148](#)
 - lug bolts [148](#)
- Tow sockets for towing eyelet [155](#)
- Towing eyelet [155](#)
- Towing the vehicle [154](#)
- Track width, refer to Dimensions [161](#)
- Transmission
 - automatic transmission with Steptronic [71](#)
 - sequential manual gearbox SMG [67](#)
- Transmission lock, refer to Park [71](#)
- Transmission malfunction automatic transmission with Steptronic [73](#)
 - sequential manual gearbox SMG [69](#)
- Transport securing devices, refer to Securing cargo [115](#)
- Transporting children safely [57](#)
- Trap protection
 - electric power windows [40](#)
- Tread depth, refer to Tire tread [124](#)
- Treadwear indicator in the tires, refer to Tire tread – tire damage [124](#)
- Treadwear, tires [124](#)
- Trigger alarm – Panic mode [32](#)
- Trip distance recorder, refer to Trip odometer [79](#)
- Trip meter, refer to Trip odometer [79](#)
- Trip odometer [79](#)

Everything from A to Z

Trunk lid, refer to Tailgate [35](#)
Trunk lighting, refer to cargo area lighting [35](#)
Trunk, refer to Cargo area
Turn signal indicator [74](#)
bulb replacement [144](#)
indicator lamp [20](#)
Turn signal indicator, side bulb replacement [145](#)
Turning circle, refer to Dimensions [161](#)
TV function, refer to the Owner's Manual for Onboard Computer

U

Underbody protection, refer to the Caring for your vehicle brochure
Uniform Tire Quality Grading [126](#)
Units
average fuel consumption [84](#)
temperature [83](#)
Unlocking
from inside [35](#)
from outside [31, 34](#)

V

Valve
screw caps [148](#)

Vehicle
battery [151](#)
break-in procedures [120](#)
care, refer to the Caring for your vehicle brochure
dimensions [161](#)
loading [113](#)
starting [63](#)
switching off [65](#)
washing, refer to the Caring for your vehicle brochure [75](#)
weight [162](#)

Vehicle Memory [61](#)

Vehicle storage
refer to the Caring for your vehicle brochure

Vehicle weight [162](#)

Ventilation [96, 100](#)
draft-free [99, 103](#)

Viscosity [134](#)

Voice Input System [22](#)

Voice recognition, refer to separate Owner's Manual

Volume
cargo area [162](#)

W

Warning and indicator lamps [18](#)

Warning lamp

Please fasten safety belts [18](#)

Warning messages [81](#)

Warranty and Service Guide Booklet [136](#)

Warranty, refer to separate booklet [7](#)

Washer fluid
adding [132, 163](#)

Washer fluid reservoir [132](#)
volume [132](#)

Washer jets, refer to Windshield washer jets [76](#)

Washer/wiper system [75, 76](#)
washer fluid [132](#)

Waste tray, refer to Ashtray [108](#)

Water on roadways, deep water [121](#)

Weights [162](#)

Wheel and tire combinations [127](#)

Wheelbase, refer to Dimensions [161](#)

Wheels and tires [127](#)
Wheel slip control DSC [86](#)
Width, refer to

Dimensions [161](#)

Window condensation removing [99, 102](#)

Windows

convenience operation [32, 34](#)

power [40](#)

remote control [31, 32](#)

Windshield washer nozzles [76](#)

Windshield washer reservoir volume, see Capacities [163](#)

Windshield washer reservoir, filling [132, 163](#)

Windshield wipers, refer to Washer/wiper system [75](#)

Winter tires [127](#)
condition [128](#)

storing [127](#)

Wiper blades replacing [142](#)

Work in the engine compartment [129](#)

Wrench, refer to Onboard tool kit [142](#)

X

Xenon lamps
bulb replacement [143](#)

Refueling



To ensure that you always have convenient access to all essential information when you stop for fuel, we recommend that you fill out the adjoining chart by entering the data that apply to your vehicle. Consult the index for individual specifications.

Fuel

Designation	
-------------	--

Please enter your preferred fuel here.

Engine oil

Quality	
---------	--

The oil volume between the two marks on the dipstick corresponds to approx. 1.1 US quarts/1 liter.

Tire inflation pressure

	Summer tires		Winter tires	
	Front	Rear	Front	Rear
Up to 4 persons				
5 persons or 4 plus luggage				

More about BMW

bmwusa.com



The Ultimate
Driving Machine

01 41 0 157 605 ue

Free Manuals Download Website

<http://myh66.com>

<http://usermanuals.us>

<http://www.somanuals.com>

<http://www.4manuals.cc>

<http://www.manual-lib.com>

<http://www.404manual.com>

<http://www.luxmanual.com>

<http://aubethermostatmanual.com>

Golf course search by state

<http://golfingnear.com>

Email search by domain

<http://emailbydomain.com>

Auto manuals search

<http://auto.somanuals.com>

TV manuals search

<http://tv.somanuals.com>