

1999

**BMW Z3 (E36/7)
Z3 Roadster, Z3 Coupe,
M Roadster, M Coupe**

Electrical

Troubleshooting

Manual

Vehicles produced 9/98 thru 03/99



ELECTRICAL TROUBLESHOOTING MANUAL

SERIES 3 – E36/7 (Z3 Roadster, Z3 Coupe, M Roadster, and M Coupe)

SCHEMATICS

MODEL YEAR 1999

0100.0	INDEX	6160.1	WIPER/WASHER MODULE (WWM)
0110.0	INTRODUCTION	6167.1	HEADLIGHT WASHER (SRA)
0140.0	SYMBOLS	6169.0	WINDSHIELD WASHER JET HEATERS
0670.0	POWER DISTRIBUTION CHART	6211.0	INSTRUMENT CLUSTER
0670.1	FUSE CHART	6213.3	DIGITAL CLOCK
0670.2	POWER DISTRIBUTION	6300.0	LIGHT SWITCH DETAILS
0670.3	FUSE DETAILS	6312.0	HEADLIGHTS/FOG LIGHTS
0670.4	GROUND DISTRIBUTION	6313.0	TURN/HAZARD LIGHTS
0670.5	DATA LINK	6314.0	PARK/TAIL/UNDERHOOD LIGHTS
1210.17	ENGINE CONTROL SYSTEM MS41.1 (6-CYLINDER S52)	6320.0	LICENSE PLATE/LUGGAGE COMPARTMENT LIGHTS
1210.25	ENGINE CONTROL SYSTEM MS42.1 (6-CYLINDER M52)	6322.0	BACK UP LIGHTS
1230.0	CHARGING SYSTEM	6325.0	BRAKE LIGHTS
1240.0	START	6330.3	INTERIOR LIGHTS
1290.0	E-BOX FAN	6332.0	INTERIOR ACCESSORIES
2460.2	ELECTRONIC TRANSMISSION CONTROL (EGS A4S 270R)	6350.0	CRASH CONTROL MODULE
3234.0	SUPPLEMENTAL RESTRAINT SYSTEM (AIR BAG)	6424.0	REAR WINDOW DEFOGGER
3450.1	SLIP CONTROL (ABS/ASC)	6450.6	INTEGRATED HEATING- AND CLIMATE CONTROL
3614.0	TIRE INFLATION SYSTEM	6510.1	RADIO/HIFI
5116.0	POWER MIRRORS	6561.0	CELLULAR TELEPHONE (PROVISIONS)
5126.0	ZKE CENTRAL LOCKING (ZV)	6571.0	CRUISE CONTROL (TEMPOMAT)
5133.0	ZKE POWER WINDOWS (FH)	6575.2	ANTI-THEFT SYSTEM (ALPINE)
5200.0	POWER SEATS	6581.3	BOARD COMPUTER (BC – LOW)
5203.0	HEATED SEATS	7000.0	COMPONENT LOCATION CHART
5410.5	POWER TILT SUNROOF	7100.0	COMPONENT LOCATION VIEWS
5430.2	ELECTRO-HYDRAULIC CONVERTIBLE TOP	8000.0	SPLICE LOCATION VIEWS
6100.0	CENTRAL BODY ELECTRONICS (ZKE IV)	8500.0	CONNECTOR VIEWS
6133.0	HORN		
6135.1	DRIVE-AWAY PROTECTION (EWS III)		



0100.0 INDEX

Z3

ABS HYDRAULIC UNIT, Y1w	3450.1-01	AUXILIARY THROTTLE POSITION SENSOR, R31	3450.1-02
AIR BAG CUT-OFF SWITCH, PASSENGER'S, S559	3234.0-01	AUXILIARY TURN LIGHT, LEFT FRONT, H9	6313.0-02
AIR BAG GAS GENERATOR, DRIVER'S, G5	3234.0-00	AUXILIARY TURN LIGHT, RIGHT FRONT, H8	6313.0-02
AIR BAG GAS GENERATOR, LEFT SIDE, G14	3234.0-03	B+ JUMP START JUNCTION POINT, G6430	0670.2-00
AIR BAG GAS GENERATOR, PASSENGER'S, G6	3234.0-01	B+ JUMP START JUNCTION POINT, G6430	0670.2-05
AIR BAG GAS GENERATOR, RIGHT SIDE, G15	3234.0-03	B+ JUNCTION POINT E-BOX, G6400	0670.2-01
AIR CONDITIONING COMPRESSOR, Y2	6450.6-02	B+ JUNCTION POINT, G7512	0670.2-00
AIR CONDITIONING COMPRESSOR, Y2	6450.6-06	BACK UP LIGHT, LEFT, H27	6322.0-00
AIR CONDITIONING RELAY, MOTRONIC, K33a	6450.6-04	BACK UP LIGHT, RIGHT, H28	6322.0-00
AIR CONDITIONING/RECIRCULATING SWITCH ASSEMBLY, S220	6450.6-01	BACK UP LIGHTS	6322.0-00
AIR CONDITIONING/RECIRCULATING SWITCH ASSEMBLY, S220	6450.6-05	BATTERY, G1	0670.2-00
AIR PUMP, Y6133	1210.17-05	BATTERY, G1	0670.2-05
AIR PUMP, Y6133	1210.25-04	BLOWER MOTOR, M30	6450.6-00
ANALOG CLOCK, N5	6211.0-05	BLOWER MOTOR, M30	6450.6-04
ANTENNA AMPLIFIER AM/FM, N8	6510.1-00	BLOWER RELAY, K4	6450.6-00
ANTI-THEFT CONTROL MODULE (ALPINE), N12w	6575.2	BLOWER RELAY, K4	6450.6-04
ANTI-THEFT HORN (ALPINE), H1w	6575.2-01	BLOWER RESISTORS, R11	6450.6-00
ANTI-THEFT SYSTEM (ALPINE)	6575.2	BLOWER RESISTORS, R11	6450.6-04
ASC SWITCH, S6	3450.1-03	BLOWER SWITCH, S75	6450.6-00
ASC SWITCH, S6	3450.1-06	BLOWER SWITCH, S75	6450.6-04
ASHTRAY LIGHT, FRONT, E25	6300.0-01	BOARD COMPUTER (BC - LOW)	6581.3-00
ASHTRAY LIGHT, FRONT, E25	6332.0-00	BOARD COMPUTER (BC - LOW), A35y	6581.3-00
AUTOMATIC TRANSMISSION RANGE SWITCH, S3	2460.2-04	BODY ELECTRONICS CONTROL MODULE (ZKE IV), A104	6100.0
AUXILIARY FAN MOTOR, M9	6450.6-03	BRAKE FLUID LEVEL SWITCH, B18	6211.0-00
AUXILIARY FAN MOTOR, M9	6450.6-07	BRAKE LIGHT SWITCH, S30	6325.0
AUXILIARY FUSE BOX, P95	0670.2-06	BRAKE LIGHT, LEFT, H24	6325.0
AUXILIARY FUSE BOX, P97	0670.2-06	BRAKE LIGHT, RIGHT, H31	6325.0
AUXILIARY THROTTLE POSITION MOTOR (ADS), M93	3450.1-02	BRAKE LIGHTS	6325.0
		BRAKE PAD SENSOR, LEFT FRONT, B16	6211.0-01
		BRAKE PAD SENSOR, RIGHT REAR, B17	6211.0-01

03/00

0100.0-00

1999



INDEX

Z3

CAMSHAFT POSITION SENSOR
(CYLINDER IDENTIFICATION), B6204 1210.17-06

CAMSHAFT POSITION SENSOR 1 (INLET), B6214 1210.25-05

CAMSHAFT POSITION SENSOR 2 (OUTLET), B6224 1210.25-05

CD CHANGER, N22 6510.1

CELLULAR TELEPHONE (PROVISIONS) 6561.0-00

CENTRAL BODY ELECTRONICS (ZKE IV) 6100.0

CENTRAL LOCKING LUGGAGE COMPARTMENT LID
MOTOR RELAY (ZV), K70 5126.0-05

CHARCOAL FILTER SHUT-OFF VALVE, B6247 1210.17-09

CHARGING SYSTEM 1230.0

CHIME MODULE, H10 6211.0-00

CIGAR LIGHTER CONNECTION, E28a 3614.0-00

CIGAR LIGHTER LIGHT, FRONT, E29 6300.0-01

CIGAR LIGHTER LIGHT, FRONT, E29 6332.0-00

CIGAR LIGHTER, FRONT, E28 6332.0-00

CLUTCH SWITCH, S32 6571.0-01

CLUTCH SWITCH, S32 6571.0-03

COMBINATION SWITCH, S7 6313.0-00

COMPONENT LOCATION CHART 7000.0

COMPONENT LOCATION VIEWS 7100.0

COMPRESSOR CONTROL RELAY, K19 6450.6-02

COMPRESSOR CONTROL RELAY, K19 6450.6-06

COMPRESSOR MAIN SWITCH, S232 3614.0-00

COMPRESSOR RELAY, K6394 3614.0-00

CONNECTOR VIEWS 8500.0

CONTACT RING, C101 3234.0-00

CONVERTIBLE TOP ACTUATING SWITCH, S143 5430.2-01

CONVERTIBLE TOP END-POSITION MICRO SWITCH, S164 5430.2-01

CONVERTIBLE TOP MOTOR, M101 5430.2-00

CONVERTIBLE TOP RELAY I (CLOSE), K18363 5430.2-00

CONVERTIBLE TOP RELAY II (OPEN), K18364 5430.2-00

CRANKSHAFT POSITION/RPM SENSOR, B6203 1210.17-06

CRANKSHAFT POSITION/RPM SENSOR, B6203 1210.25-05

CRASH CONTROL MODULE 6350.0

CRASH CONTROL MODULE, N17 6350.0-01

CRUISE CONTROL (TEMPOMAT) 6571.0

CRUISE CONTROL ACTUATOR (TEMPOMAT), M25 6571.0-01

CRUISE CONTROL INTERFACE, A9008 6571.0-02

CRUISE CONTROL MODULE (TEMPOMAT), A8 6571.0

CRUISE CONTROL SWITCH, S28 6571.0-00

CRUISE CONTROL SWITCH, S28 6571.0-02

DATA LINK 0670.5

DATA LINK CONNECTOR, D100 0670.5

DAY LIGHT RELAY MODULE, K46z 6312.0-01

DEFOGGER I, REAR, E9 6424.0

DIGITAL CLOCK 6213.3-00

DIGITAL CLOCK, A110 6213.3-00

DOME LIGHT/MAP READING ASSEMBLY, FRONT, E34 6330.3-00

DOOR JAMB SWITCH, DRIVER'S, S14 5126.0-01

DOOR JAMB SWITCH, PASSENGER'S, S13 5126.0-01

DOOR LOCK MOTOR, DRIVER'S, M12 5126.0-02

DOOR LOCK MOTOR, DRIVER'S, M12 5126.0-04

DOOR LOCK MOTOR, PASSENGER'S, M13 5126.0-02

DOOR LOCK MOTOR, PASSENGER'S, M13 5126.0-04

DOOR LOCK SWITCH, DRIVER'S, S47 5126.0-00

DOOR LOCK SWITCH, PASSENGER'S, S49 5126.0-00

DRIVE-AWAY PROTECTION (EWS III) 6135.1

DUAL TEMPERATURE SENSOR
(COOLANT TEMPERATURE), B6256 1210.17-02



INDEX

Z3

E-BOX FAN	1290.0-00
E-BOX FAN, M6506	1290.0-00
ELECTRICAL COMPRESSOR, M805	3614.0-00
ELECTRO-HYDRAULIC CONVERTIBLE TOP	5430.2
ELECTRONIC IMMOBILIZER CONTROL MODULE (EWS III), A837	6135.1
ELECTRONIC TRANSMISSION CONTROL (EGS A4S 310R)	2460.2
ENGINE CONTROL MODULE (DME), A6000	1210.17
ENGINE CONTROL MODULE (DME), A6000	1210.25
ENGINE CONTROL MODULE RELAY, K6300	1210.17-00
ENGINE CONTROL MODULE RELAY, K6300	1210.25-00
ENGINE CONTROL RELAY (ABS/ASC), K94	3450.1-00
ENGINE CONTROL SYSTEM MS41.1 (6-CYLINDER M52)	1210.17
ENGINE CONTROL SYSTEM MS42.1 (6-CYLINDER M52)	1210.25
ENGINE COOLANT TEMPERATURE SENSOR, B6232	1210.17-02
ENGINE COOLANT TEMPERATURE SENSOR, B6232	6211.0-03
ENGINE COOLANT TEMPERATURE SENSOR, B6236	1210.17-02
ENGINE COOLANT TEMPERATURE SENSOR, B6236	1210.25-07
ENGINE HOOD SWITCH, S21w	6575.2-00
EVAPORATIVE EMISSION VALVE, Y6120	1210.17-05
EVAPORATIVE EMISSION VALVE, Y6120	1210.25-03
EVAPORATOR CONTROLLER, S221	6450.6-01
EVAPORATOR CONTROLLER, S221	6450.6-05
EVAPORATOR TEMPERATURE SENSOR, B14	6450.6-01
EVAPORATOR TEMPERATURE SENSOR, B14	6450.6-05
EWS TOROIDAL COIL, L1	6135.1
FOG LIGHT RELAY, FRONT, K47	6312.0-00
FOG LIGHT SWITCH, S10	6312.0-00
FOG LIGHT, LEFT, E26	6312.0-00
FOG LIGHT, RIGHT, E27	6312.0-00

FRESH AIR RECIRCULATION MOTOR, M111	6450.6-01
FRESH AIR RECIRCULATION MOTOR, M111	6450.6-05
FRONT POWER DISTRIBUTION BOX, FRONT, P90	0670.2
FUEL INJECTION VALVE, CYL. 1, Y6101	1210.17-01
FUEL INJECTION VALVE, CYL. 1, Y6101	1210.25-02
FUEL INJECTION VALVE, CYL. 2, Y6102	1210.17-01
FUEL INJECTION VALVE, CYL. 2, Y6102	1210.25-02
FUEL INJECTION VALVE, CYL. 3, Y6103	1210.17-01
FUEL INJECTION VALVE, CYL. 3, Y6103	1210.25-02
FUEL INJECTION VALVE, CYL. 4, Y6104	1210.17-01
FUEL INJECTION VALVE, CYL. 4, Y6104	1210.25-02
FUEL INJECTION VALVE, CYL. 5, Y6105	1210.17-01
FUEL INJECTION VALVE, CYL. 5, Y6105	1210.25-02
FUEL INJECTION VALVE, CYL. 6, Y6106	1210.17-01
FUEL INJECTION VALVE, CYL. 6, Y6106	1210.25-02
FUEL PUMP RELAY, K6301w	1210.17-04
FUEL PUMP RELAY, K6301w	1210.25-06
FUEL PUMP, M2	1210.17-04
FUEL PUMP, M2	1210.25-06
FUEL SENSOR, B6y	6211.0-02
FUEL TANK PRESSURE SENSOR, B65	1210.17-09
FUSE CHART	0670.1
FUSE DETAILS	0670.3
FUSE HOLDER IN E-BOX, P98	0670.2-01
FUSE HOLDER, P99	0670.2-00
GENERATOR, G6509	1230.0
GROUND DISTRIBUTION	0670.4
HARD TOP CONNECTOR 1, E99	6424.0-01
HAZARD FLASHER RELAY, K16	6313.0-00
HAZARD SWITCH, S18	6313.0-01



INDEX

Z3

HEADLIGHT WASHER (SRA)	6167.1-00
HEADLIGHT, LEFT, E7	6312.0-01
HEADLIGHT, RIGHT, E8	6312.0-01
HEADLIGHT/FOG LIGHT WASHER PUMP, M7	6160.1-00
HEADLIGHT/FOG LIGHT WASHER PUMP, M7	6167.1-00
HEADLIGHTS/FOG LIGHTS	6312.0
HEAT/A/C CONTROL PANEL ILLUMINATION, E105	6300.0-02
HEAT/A/C CONTROL PANEL ILLUMINATION, E105	6300.0-03
HEAT/A/C CONTROL PANEL ILLUMINATION, E106	6300.0-02
HEAT/A/C CONTROL PANEL ILLUMINATION, E106	6300.0-03
HEATED SEATS	5203.0-00
HIFI AMPLIFIER, A18	6510.1
HIGH BEAM LIGHT RELAY, K46	6312.0-01
HIGH BEAM LIGHT, LEFT, E11	6312.0-01
HIGH LEVEL STOP LIGHT, H34	6325.0
HIGH RANGE SPEAKER, LEFT FRONT, H59	6510.1-02
HIGH RANGE SPEAKER, LEFT FRONT, H59	6510.1-03
HIGH RANGE SPEAKER, LEFT REAR, H56	6510.1-03
HIGH RANGE SPEAKER, RIGHT FRONT, H50	6510.1-01
HIGH RANGE SPEAKER, RIGHT REAR, H53	6510.1-03
HIGH SPEED RELAY, K22	6450.6-03
HIGH SPEED RELAY, K22	6450.6-07
HORN	6133.0-00
HORN RELAY, K2	6133.0-00
HORN SWITCH, S4	6133.0-00
HORN, LEFT, H2	6133.0-00
HOT FILM AIR MASS METER, B6207	1210.17-05
HOT FILM AIR MASS METER, B6207	1210.25-05
IDLE SPEED CONTROL VALVE, Y6130	1210.17-01
IDLE SPEED CONTROL VALVE, Y6130	1210.25-03

IGNITION COIL, CYL. 1, T6151	1210.17-03
IGNITION COIL, CYL. 1, T6151	1210.25-01
IGNITION COIL, CYL. 2, T6152	1210.17-03
IGNITION COIL, CYL. 2, T6152	1210.25-01
IGNITION COIL, CYL. 3, T6153	1210.17-03
IGNITION COIL, CYL. 3, T6153	1210.25-01
IGNITION COIL, CYL. 4, T6154	1210.17-03
IGNITION COIL, CYL. 4, T6154	1210.25-01
IGNITION COIL, CYL. 5, T6155	1210.17-03
IGNITION COIL, CYL. 5, T6155	1210.25-01
IGNITION COIL, CYL. 6, T6156	1210.17-03
IGNITION COIL, CYL. 6, T6156	1210.25-01
IGNITION SWITCH, S2	0670.2-04
IGNITION SWITCH, S2	0670.2-08
INDEX	0100.0
INSTRUMENT CLUSTER	6211.0
INSTRUMENT CLUSTER, A2w	6211.0
INTAKE AIR TEMPERATURE SENSOR, B6205	1210.17-02
INTAKE AIR TEMPERATURE SENSOR, B6205	1210.25-07
INTEGRATED HEATING- AND CLIMATE CONTROL	6450.6
INTERIOR ACCESSORIES	6332.0-00
INTERIOR LIGHT SWITCH, S408	6330.3-00
INTERIOR LIGHT, FRONT LEFT, E800	6330.3-00
INTERIOR LIGHTS	6330.3-00
INTERMEDIATE PRESSURE SWITCH, B9	6450.6-03
INTERMEDIATE PRESSURE SWITCH, B9	6450.6-07
INTRODUCTION	0110.0
JET HEATER THERMOSWITCH, S198	6169.0-00
KICK-DOWN SWITCH, S8507	2460.2-02
KNOCK SENSOR, B6240	1210.17-06



INDEX

Z3

KNOCK SENSOR, B6240	1210.25-09
LEAKAGE DIAGNOSIS PUMP, Y6139	1210.25-04
LICENSE PLATE LIGHT, LEFT, E43	6320.0-00
LICENSE PLATE/LUGGAGE COMPARTMENT LIGHTS	6320.0-00
LIGHT ASSEMBLY, LEFT REAR, E16	0670.4-16
LIGHT ASSEMBLY, RIGHT REAR, E17	0670.4-16
LIGHT SWITCH DETAILS	6300.0
LIGHT SWITCH, S8	6300.0-00
LOW BEAM LIGHT RELAY, K48	6312.0-01
LOW BEAM LIGHT, LEFT, E13	6312.0-01
LOW RANGE SPEAKER, LEFT FRONT, H58	6510.1-01
LOW RANGE SPEAKER, LEFT REAR, H57	6510.1-02
LOW RANGE SPEAKER, RIGHT FRONT, H51	6510.1-01
LOW RANGE SPEAKER, RIGHT REAR, H52	6510.1-02
LUGGAGE COMPARTMENT LID LOCKING SWITCH, S117	5126.0-05
LUGGAGE COMPARTMENT LIGHT SWITCH, S826	6320.0-00
LUGGAGE COMPARTMENT LIGHT, E32	6320.0-01
LUGGAGE COMPARTMENT LOCK MOTOR, M17	5126.0-03
LUGGAGE COMPARTMENT LOCK MOTOR, M17	5126.0-05
MARKER LIGHT, LEFT FRONT, E21	6314.0-01
MARKER LIGHT, RIGHT FRONT, E22	6314.0-01
MID-HIGH RANGE SPEAKER, REAR LEFT, H55z	6510.1-02
MID-HIGH RANGE SPEAKER, REAR RIGHT, H54z	6510.1-02
MIDRANGE SPEAKER, LEFT FRONT, H55	6510.1-02
MIDRANGE SPEAKER, LEFT FRONT, H55	6510.1-03
MIDRANGE SPEAKER, RIGHT FRONT, H54	6510.1-01
MIRROR CONTROL SWITCH, S17	5116.0-00
MIRROR, DRIVER'S SIDE, Y5	5116.0-01
MIRROR, PASSENGER'S SIDE, Y6	5116.0-01
NORMAL SPEED RELAY, K21	6450.6-03

NORMAL SPEED RELAY, K21	6450.6-07
OBD II CONNECTOR, D110	0670.5-03
OBD II CONNECTOR, D110	0670.5-06
OIL PRESSURE SWITCH, B6231	1210.25-08
OIL PRESSURE SWITCH, B6231	6211.0-03
OIL PRESSURE SWITCH, B6231	6211.0-07
OIL TEMPERATURE GAUGE, B59	6211.0-05
OIL TEMPERATURE SENSOR, B6238	1210.25-07
OIL TEMPERATURE SENSOR, B6238	6211.0-05
ON-BOARD COMPUTER TEMPERATURE SENSOR, B21	6581.3-00
OXYGEN SENSOR I (BEHIND CATALYTIC CONVERTER), B62102	1210.17-04
OXYGEN SENSOR I (BEHIND CATALYTIC CONVERTER), B62102	1210.25-06
OXYGEN SENSOR I (IN FRONT OF CATALYTIC CONVERTER), B62101	1210.17-04
OXYGEN SENSOR I (IN FRONT OF CATALYTIC CONVERTER), B62101	1210.25-06
OXYGEN SENSOR II (BEHIND CATALYTIC CONVERTER), B62202	1210.17-04
OXYGEN SENSOR II (BEHIND CATALYTIC CONVERTER), B62202	1210.25-06
OXYGEN SENSOR II (IN FRONT OF CATALYTIC CONVERTER), B62201	1210.17-04
OXYGEN SENSOR II (IN FRONT OF CATALYTIC CONVERTER), B62201	1210.25-06
PARK BRAKE SWITCH, S31	6211.0-04
PARK BRAKE SWITCH, S31	6211.0-08
PARK LIGHT, LEFT, E15	6314.0-01
PARK/TAIL/UNDERHOOD LIGHTS	6314.0
POWER DISTRIBUTION	0670.2



INDEX

Z3

POWER DISTRIBUTION CHART	0670.0	SEAT HEATER SWITCH, DRIVER'S SEAT, S53	5203.0-00
POWER MIRRORS	5116.0	SEAT HEATER SWITCH, PASSENGER'S SEAT, S54	5203.0-00
POWER SEATS	5200.0	SEAT HEATER, DRIVER'S, E57	5203.0-00
POWER TILT SUNROOF	5410.5-00	SEAT HEATER, PASSENGER'S, E58	5203.0-00
POWER WINDOW SWITCH, DRIVER'S, S126y	5133.0-01	SEAT HEIGHT MOTOR, DRIVER'S, M52	5200.0-00
POWER WINDOW SWITCH, PASSENGER'S, S127y	5133.0-01	SEAT HEIGHT MOTOR, DRIVER'S, M52	5200.0-02
PRESSURE SWITCH, B8y	6450.6-03	SEAT HEIGHT MOTOR, PASSENGER'S, M59	5200.0-01
PRESSURE SWITCH, B8y	6450.6-07	SEAT HEIGHT MOTOR, PASSENGER'S, M59	5200.0-03
PRESSURE SWITCH, B9508	6450.6-03	SEAT LENGTH ADJUST CUT-OFF RELAY, DRIVER'S, K921 ..	5200.0-02
PRESSURE SWITCH, B9508	6450.6-07	SEAT LENGTH ADJUST CUT-OFF RELAY, PASSENGER'S,	
PROGRAM SWITCH, S8503	2460.2-03	K911	5200.0-03
PYROTECHNICAL BELT TENSIONER, DRIVER'S SIDE, G12 ..	3234.0-00	SEAT LIMIT SWITCH, DRIVER'S, S910	5200.0-02
PYROTECHNICAL BELT TENSIONER, PASSENGER'S SIDE,		SEAT LIMIT SWITCH, PASSENGER'S, S911	5200.0-03
G13	3234.0-00	SEAT MAT, I1008	3234.0-01
RADIO ANTI-THEFT SWITCH, S20w	6575.2-00	SEAT MOVEMENT MOTOR, DRIVER'S, M51	5200.0-00
RADIO, N9	6510.1	SEAT MOVEMENT MOTOR, DRIVER'S, M51	5200.0-02
RADIO/HIFI	6510.1	SEAT MOVEMENT MOTOR, PASSENGER'S, M60	5200.0-01
RESISTOR, R8554	0670.4-08	SEAT MOVEMENT MOTOR, PASSENGER'S, M60	5200.0-03
REVERSING LIGHT SWITCH, S8511	6322.0-00	SEAT OCCUPANCY DETECTOR, A113	3234.0-01
RIGHT HIGH BEAM LIGHT, RIGHT, E12	6312.0-01	SEAT TILT ADJUST CUT-OFF RELAY, DRIVER'S, K920	5200.0-02
RIGHT HORN, RIGHT, H3	6133.0-00	SEAT TILT ADJUST CUT-OFF RELAY, PASSENGER'S,	
RIGHT LICENSE PLATE LIGHT, RIGHT, E44	6320.0-00	K910	5200.0-03
RIGHT LOW BEAM LIGHT, RIGHT, E14	6312.0-01	SEATBACK HEATER, DRIVER'S, E56	5203.0-00
RIGHT PARK LIGHT, RIGHT, E19	6314.0-01	SEATBACK HEATER, PASSENGER'S, E59	5203.0-00
SEAT BELT SWITCH, DRIVER'S, S58	3234.0-02	SECONDARY AIR PUMP RELAY, K6304	1210.17-05
SEAT BELT SWITCH, PASSENGER'S, S59	3234.0-02	SECONDARY AIR PUMP RELAY, Y6304	1210.25-04
SEAT CONTROL SWITCH, DRIVER'S SEAT, S51	5200.0-00	SECONDARY AIR PUMP VALVE, Y6163	1210.17-05
SEAT CONTROL SWITCH, DRIVER'S SEAT, S51	5200.0-02	SECONDARY AIR PUMP VALVE, Y6163	1210.25-03
SEAT CONTROL SWITCH, PASSENGER'S SEAT, S56	5200.0-01	SHIFT-LOCK, Y19	2460.2-02
SEAT CONTROL SWITCH, PASSENGER'S SEAT, S56	5200.0-03	SIDE IMPACT SENSOR, DRIVER'S, B78	3234.0-03



INDEX

Z3

SIDE IMPACT SENSOR, PASSENGER'S, B79	3234.0-03
SLIP CONTROL (ABS/ASC)	3450.1
SLIP CONTROL MODULE (ABS/ASC), A52	3450.1
SOLENOID VALVE ("RUNNING LOSSES"), Y6550	1210.17-05
SOLENOID VALVE ("RUNNING LOSSES"), Y6550	1210.25-04
SPEAKER, LEFT REAR, H46	6510.1-03
SPEAKER, RIGHT REAR, H45	6510.1-03
SPEED SENSOR – ABS, LEFT FRONT, B2	3450.1-04
SPEED SENSOR – ABS, LEFT FRONT, B2	3450.1-07
SPEED SENSOR – ABS, LEFT REAR, B4	3450.1-04
SPEED SENSOR – ABS, LEFT REAR, B4	3450.1-07
SPEED SENSOR – ABS, RIGHT FRONT, B1	3450.1-04
SPEED SENSOR – ABS, RIGHT FRONT, B1	3450.1-07
SPEED SENSOR – ABS, RIGHT REAR, B3	3450.1-04
SPEED SENSOR – ABS, RIGHT REAR, B3	3450.1-07
SPLICE LOCATION VIEWS	8000.0
START	1240.0
STARTER IMMOBILIZATION SWITCH, S235	1240.0
STARTER, M6510	1240.0
SUPPLEMENTAL RESTRAINT SYSTEM (AIR BAG)	3234.0
SUPPLEMENTAL RESTRAINT SYSTEM CONTROL MODULE, A12	3234.0
SYMBOLS	0140.0
TAIL LIGHT, LEFT, H25	6314.0-01
TAIL LIGHT, LEFT, H37	6314.0-01
TAIL LIGHT, RIGHT, H30	6314.0-01
TAIL LIGHT, RIGHT, H39	6314.0-01
TEMPERATURE SWITCH, S36	6450.6-03
TEMPERATURE SWITCH, S36	6450.6-07
TEMPERATURE WHEEL SWITCH, S531	6450.6-01

TEMPERATURE WHEEL SWITCH, S531	6450.6-05
THERMAL OIL LEVEL SENSOR (TOENS) CONTROL MODULE, A19007	6211.0-06
THERMAL OIL LEVEL SWITCH, B6254	6211.0-07
THERMOSTAT, CHARACTERISTIC MAP COOLING, B6279 .	1210.25-05
THROTTLE POSITION SENSOR, R6252	1210.17-05
THROTTLE POSITION SENSOR/ CRUISE CONTROL ACTUATOR, R6385	1210.25-07
THROTTLE POSITION SENSOR/CRUISE CONTROL ACTUATOR, R6385	6571.0-03
TILT SUNROOF MOTOR, M24y	5410.5-00
TILT SUNROOF SWITCH, S38y	5410.5-00
TIRE INFLATION SYSTEM	3614.0-00
TRANSMISSION CONTROL MODULE (EGS), A8500	2460.2
TRANSMISSION POSITION INDICATOR LIGHT, E82	6300.0-02
TRANSMISSION VALVE UNIT, Y8521	2460.2-01
TURN LIGHT, LEFT FRONT, H7	6313.0-02
TURN LIGHT, LEFT REAR, H6	6313.0-03
TURN LIGHT, RIGHT FRONT, H4	6313.0-02
TURN LIGHT, RIGHT REAR, H5	6313.0-03
TURN/HAZARD LIGHTS	6313.0
UNLOADER RELAY, TERMINAL 15, K6326	1210.17-02
UNLOADER RELAY, TERMINAL 15, K6326	1210.25-01
UNLOADER RELAY, TERMINAL 15, K9	6424.0
VALVE RELAY (ABS/ASC), K95	3450.1-00
VALVE, INDIVIDUAL CONTROL INTAKE SYSTEM, Y6167 ...	1210.25-03
VARIABLE CAMSHAFT CONTROL VALVE 1 (INLET), Y6275z	1210.25-03
VARIABLE CAMSHAFT CONTROL VALVE 1, Y6275	1210.17-01
VARIABLE CAMSHAFT CONTROL VALVE 2 (OUTLET), Y6276	1210.25-03
VEHICLE SPEED SENSOR, B10	6211.0-02

03/00

0100.0-06

1999



INDEX

Z3

VOLTMETER, B211	6211.0-05
WASHER JET HEATER, LEFT, E51	6169.0-00
WASHER JET HEATER, RIGHT, E52	6169.0-00
WASHER PUMP, M4	6160.1-01
WASHER PUMP, M4	6160.1-02
WATER VALVE, Y4z	6450.6-01
WATER VALVE, Y4z	6450.6-05
WINDOW DEFOGGER SWITCH, REAR, S76	6424.0
WINDOW DEFOGGER, REAR	6424.0
WINDOW MOTOR, DRIVER'S, M21	5133.0-02
WINDOW MOTOR, PASSENGER'S, M23	5133.0-02
WINDSHIELD WASHER JET HEATERS	6169.0-00
WIPER MOTOR, M3	6160.1-00
WIPER/WASHER INTERVAL CONTROL MODULE, REAR, A36	6160.1-02
WIPER/WASHER MODULE (WWM)	6160.1
WIPER/WASHER MODULE, A51	6160.1
WIPER/WASHER MODULE, A51	6167.1-00
WIPER/WASHER SWITCH, S5	6160.1-01
WIPER/WASHER SWITCH, S5	6160.1-02
WOOFER, REAR, H500	6510.1-02
ZKE CENTRAL LOCKING (ZV)	5126.0
ZKE POWER WINDOWS (FH)	5133.0

03/00

0100.0-07

1999

Schematics

The schematics divide the entire vehicle electrical system into individual circuits. Interacting electrical components are shown on one common schematic.

Switches and other components are represented in such a way that their general layout and function are self-explicit. They are arranged on the sheet such that the current path can be followed from positive (top) to negative (bottom).

Important: The components and wires are not drawn to scale. For instance, a lead with a length of over 1m can be shown as a lead that is only a few cm long. To ensure clear arrangement, all connectors, lines branches and connected components from the fuses to the component and from the component to ground connection are not shown within the individual cells. If required, reference can be made to cells **0670.3 Fuse Details** and **0670.4 Ground Distribution** where all lines are illustrated with all plug connections, line branches and connected components.

All circuit symbols used are listed and explained in cell **0140.0 Symbols**.

In cell **7000.0 Component Location Chart** all important connectors, ground points and components are listed in tabular form. It provides a precise description of the component locations in the vehicle.

In cell **7100.0 Component Location Views** the location of connectors and components which are difficult to locate are shown in line arts or illustrations. In cell **8000.0 Splice Location Views** all splices are listed in numerical order and illustrations are provided to assist in locating splices on larger harnesses. In cell **8500.0 Connector Views** diagrams of connectors with more than 2 pins are illustrated.

Example

General conventions can be explained based on the following schematic example.

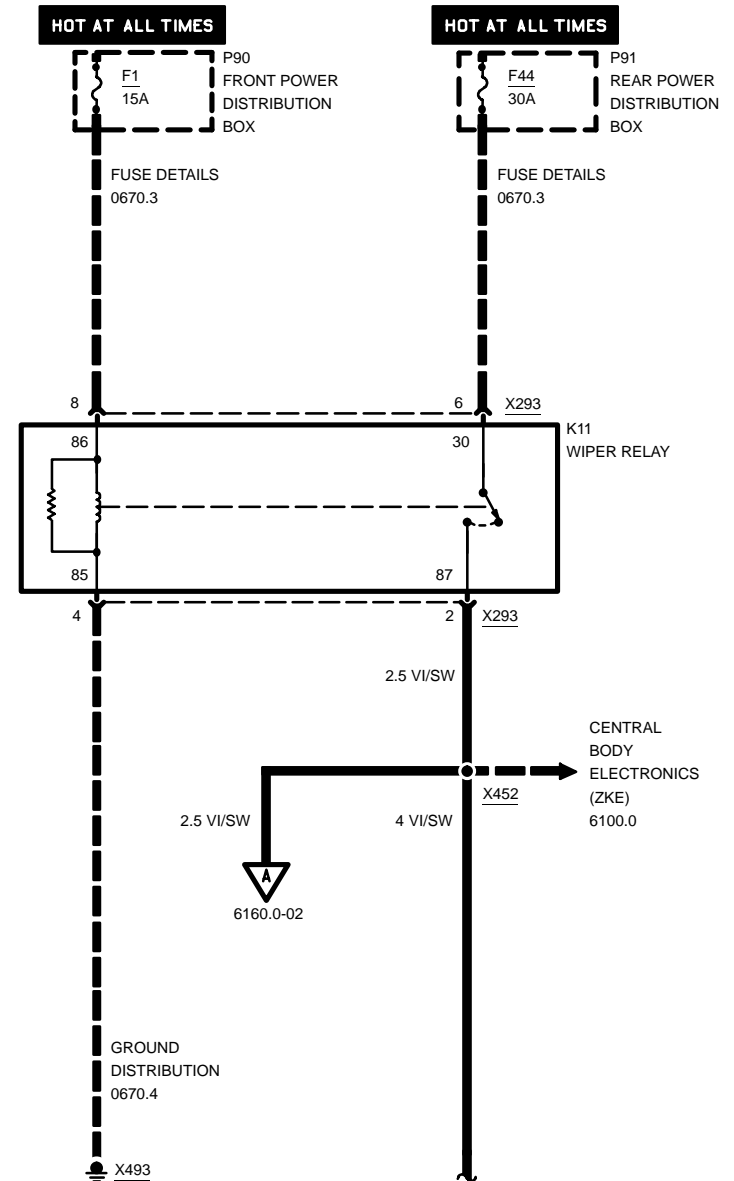



Z3

INTRODUCTION

General Conventions

1. Switches and relays are always shown in rest position (e.g. K11).
2. A component shown in a dashed frame signifies that the component is illustrated only in part (e.g. P90 and P91).
3. A component shown in a completely drawn frame signifies that the component is illustrated in full (e.g. K11).
4. The dashed line between pin 8 and pin 6 of connector X293 indicates that both pins belong to connector X293.
5. The dashed line from fuse F1 to pin 8 of connector X293 shows the positive supply of relay K11. If required, refer to cell **0670.3 Fuse Details** at fuse F1 for the complete line progressing with plug connections, line branches, wire colors and cross sections.
6. The dashed line with an arrow at splice X452 indicates that several wires lead to splice X452. All lines leading to the connection are illustrated in cell **6100.0 Central Body Electronics (ZKE)**. An interrupted line with an arrow indicates that only this one wire leads to another circuit.
7. The dashed line from pin 4 of connector X293 to ground X493 shows the ground supply for relay K11. If required, refer to cell **0670.4 Ground Distribution** at ground X493 for the complete line progression with all plug connections, line branches, wire colors, and cross sections.
8. The interrupted line from splice X452 with an **A** in the open arrow is continued on page 6160.0-02. Termination of wire 4 VI/SW from splice X452 with a wavy line indicates that the wire is continued on the opposite page.

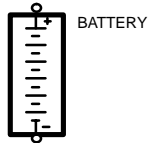

BATTERY

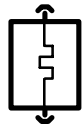

HEATING ELEMENT



VARIABLE RESISTANCE
SENSOR VARIABLE
CONTACT IS MOVED BY
AN EXTERNAL FORCE



ANTENNA



FUSE DETAILS



LOUDSPEAKER OR
HORN



VARIABLE RESISTOR RE-
SISTANCE IS CHANGED
BY TEMPERATURE OR
PRESSURE



CONTROL/POWER
ELECTRONICS



FUSIBLE LINK



LIGHT



DIODE CURRENT
CAN FLOW ONLY IN
DIRECTION OF AR-
ROW



HALL EFFECT
SENSOR



RADIO



CIRCUIT BREAKER



PERMANENT MAGNET
MOTOR ONE SPEED



ZENER DIODE TO
REGULATE VOLTAGE



TRANSISTORIZED
SWITCH



THERMO SWITCH



PERMANENT MAGNET
MOTOR TWO SPEEDS



LIGHT EMITTING
DIODE



INDUCTIVE
SENSOR



SOLENOID



KNOCK SENSOR



OXYGEN SENSOR



VEHICLE SPEED
SENSOR

SOLENOID CON-
TROLLED VALVE
OR CLUTCH
SOLENOID

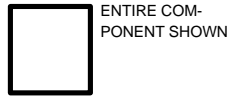

ENTIRE COM-
PONENT SHOWN

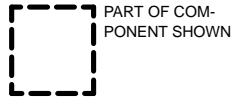

PART OF COM-
PONENT SHOWN

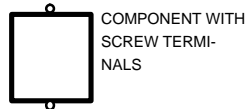

COMPONENT WITH
SCREW TERMI-
NALS

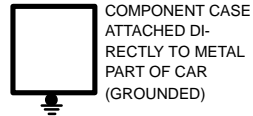

COMPONENT CASE
ATTACHED DI-
RECTLY TO METAL
PART OF CAR
(GROUNDED)

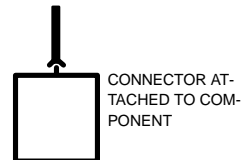

CONNECTOR AT-
TACHED TO COM-
PONENT

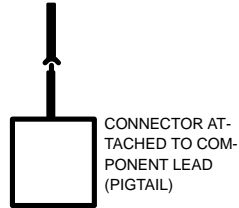

CONNECTOR AT-
TACHED TO COM-
PONENT LEAD
(PIGTAIL)

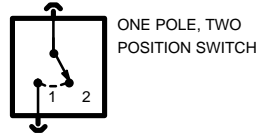

ONE POLE, TWO
POSITION SWITCH

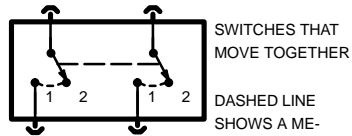

SWITCHES THAT
MOVE TOGETHER

DASHED LINE
SHOWS A ME-
CHANICAL CON-
NECTION
BETWEEN
SWITCHES

WIRE COLOR	
BL	BLUE
BR	BROWN
GE	YELLOW
GN	GREEN
GR	GRAY
OR	ORANGE
RS	PINK
RT	RED
SW	BLACK
VI	VIOLET
WS	WHITE
TR	TRANSPARENT

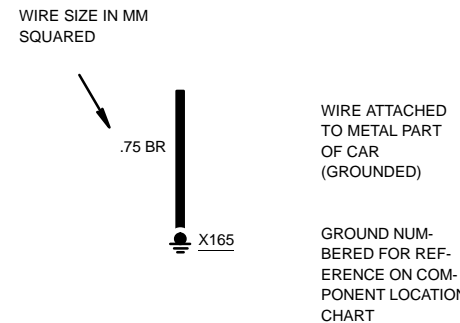
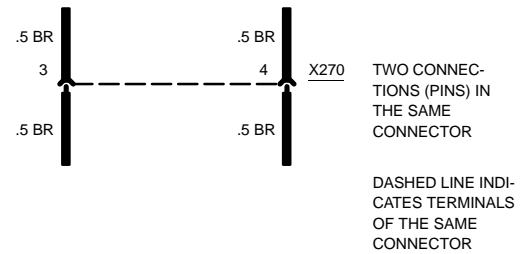
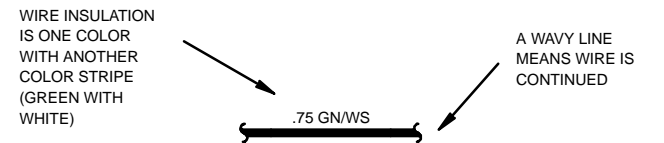
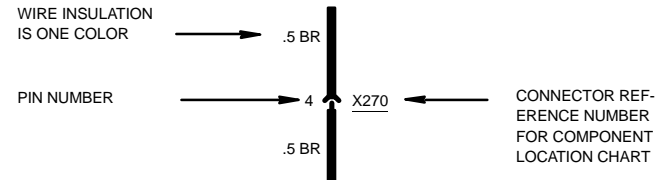

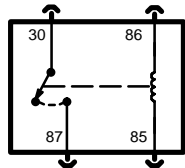

CONTACT RELAY

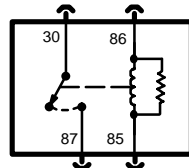

RELAY WITH RESISTOR ACROSS WINDING

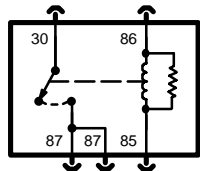

CONTACT RELAY WITH TWO OUTPUTS

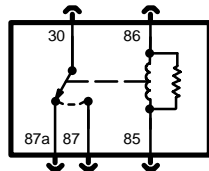

CHANGEOVER RELAY WITH TWO OUTPUTS

TERMINAL NUMBER	DESCRIPTION
30	RELAY INPUT
85	RELAY OUTPUT (WINDING)
86	RELAY INPUT (WINDING)
87	RELAY OUTPUT (ENERGIZED)
87a	RELAY OUTPUT (AT REST)

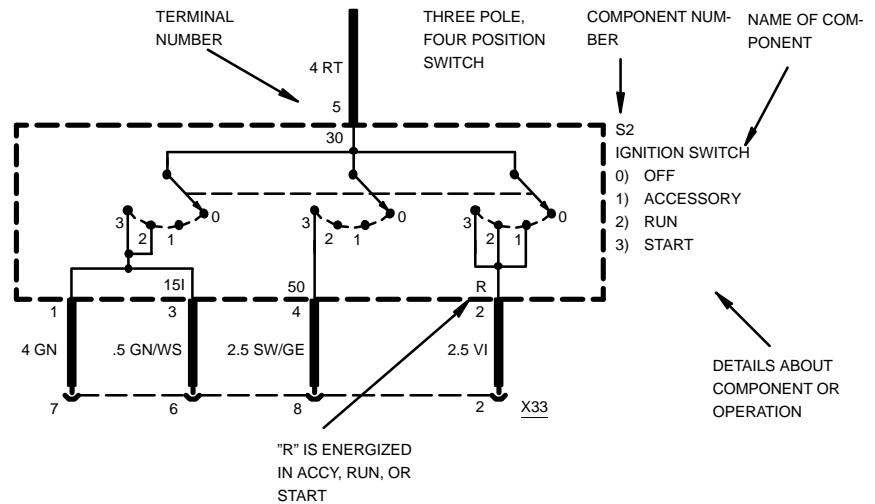

TERMINAL NUMBER	DESCRIPTION	TERMINAL NUMBER	DESCRIPTION
50	VOLTAGE: IGNITION SWITCH IN START	15I	VOLTAGE: IGNITION SWITCH IN RUN
30	VOLTAGE: SUPPLIED AT ALL TIMES	R	VOLTAGE: IGNITION SWITCH IN ACCESSORY, RUN OR START
15	VOLTAGE: IGNITION SWITCH IN RUN OR START	31	GROUND

HOT AT ALL TIMES

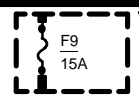

INDICATES THAT FUSE 9 IS SUPPLIED WITH POWER AT ALL TIMES

POWER STATUS

HOT AT ALL TIMES

HOT IN RUN AND START

HOT IN ACCY, RUN AND START

DESCRIPTION
 VOLTAGE: SUPPLIED AT ALL TIMES
 VOLTAGE: IGNITION SWITCH IN RUN OR START
 VOLTAGE: IGNITION SWITCH IN ACCESSORY, RUN OR START



SYMBOLS

Z3

HOT IN ACCY, RUN AND START

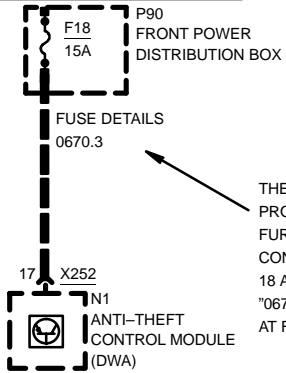

THE COMPLETE WIRE PROGRESSION AND FURTHER CIRCUITS CONNECTED TO FUSE 18 ARE SHOWN IN CELL "0670.3 FUSE DETAILS" AT FUSE 18

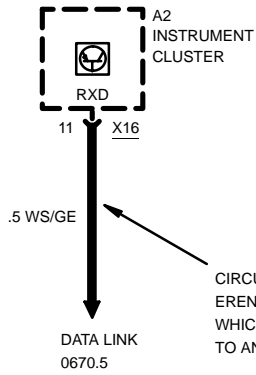

CIRCUIT REFERENCE-A WIRE WHICH CONNECTS TO ANOTHER CIRCUIT

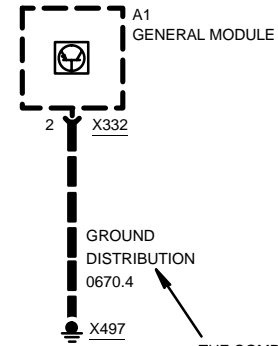

THE COMPLETE WIRE PROGRESSION AND FURTHER CIRCUITS CONNECTED TO GROUND X497 ARE SHOWN IN CELL "0670.4 GROUND DISTRIBUTION" AT GROUND X497

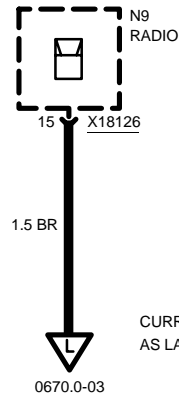

CURRENT PATH IS CONTINUED AS LABELED



ARROW SHOWS DIRECTION OF CURRENT FLOW AND IS REPEATED WHERE CURRENT PATH CONTINUES



0670.0 POWER DISTRIBUTION CHART

FRONT POWER DISTRIBUTION BOX

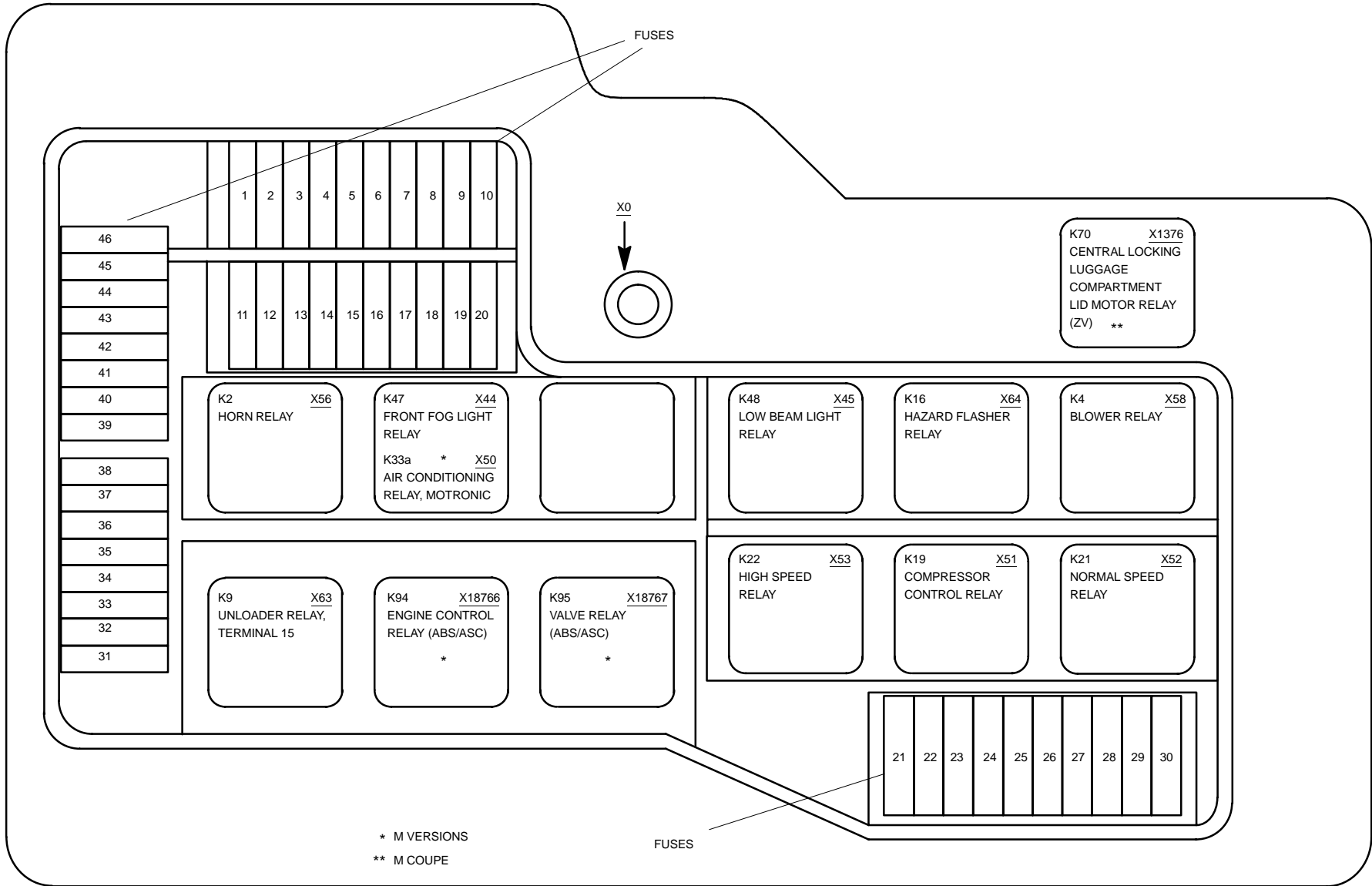



POWER DISTRIBUTION CHART

IN E-BOX

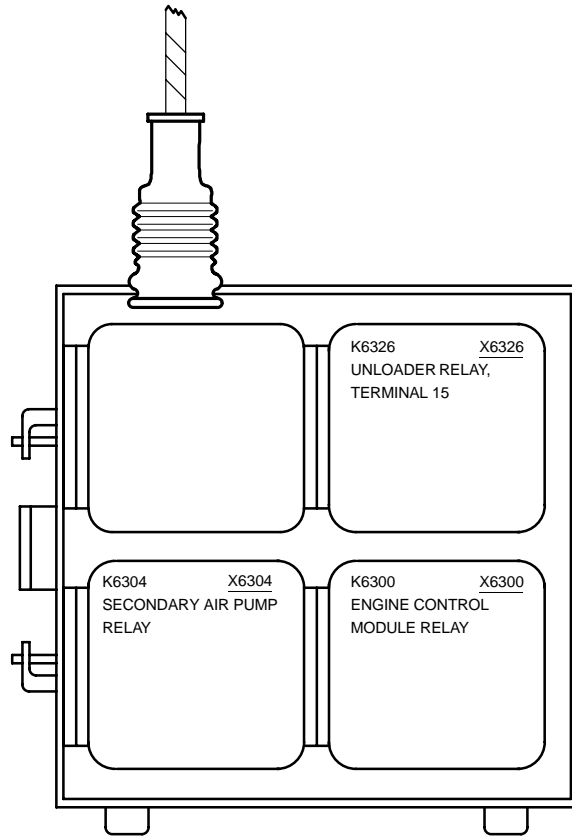

M VERSIONS

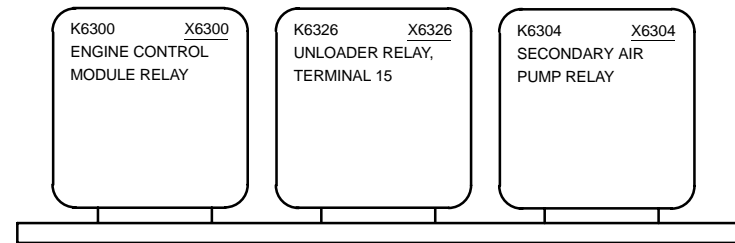

Z3 VERSIONS



Z3

POWER DISTRIBUTION CHART

RELAY PANEL UNDER LH SIDE OF DASHBOARD

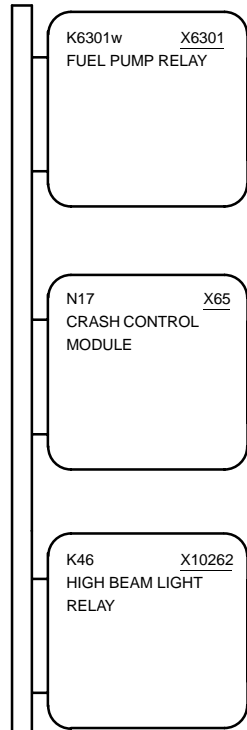

03/00

0670.0-02

1999



POWER DISTRIBUTION CHART

Z3 VERSIONS

B+ JUNCTION POINT UNDER LH SIDE OF DASHBOARD

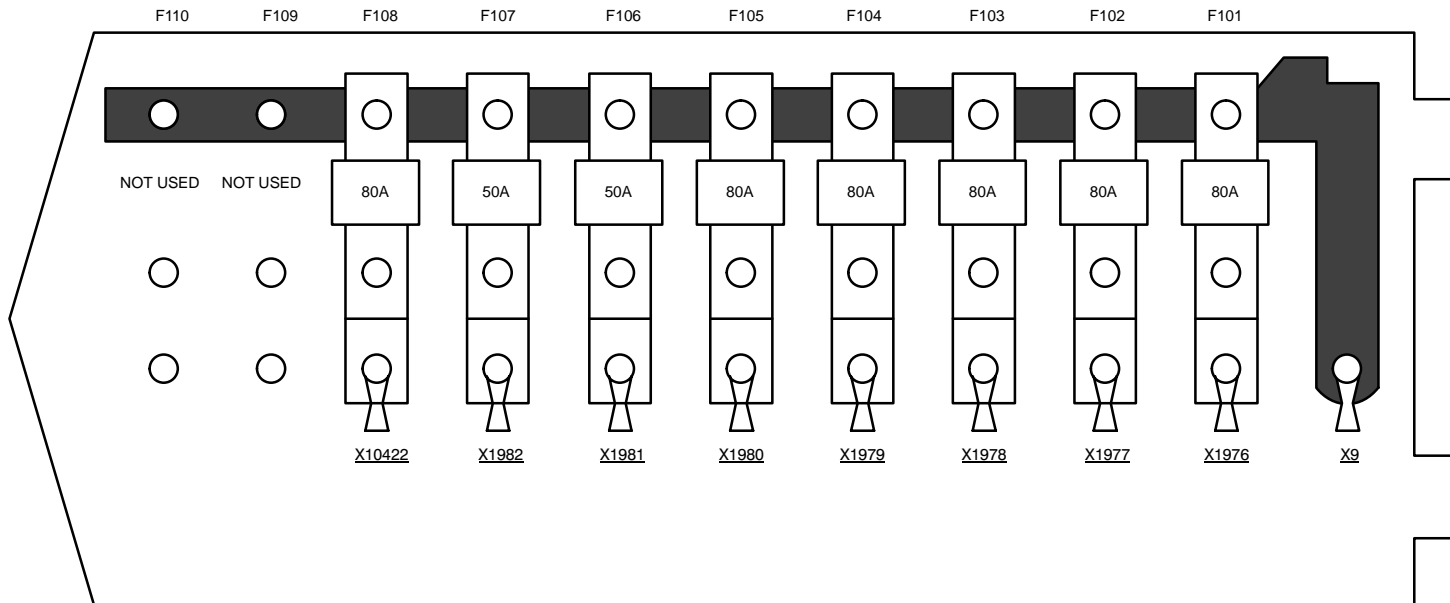

03/00

0670.0-03

1999



0670.1 FUSE CHART

FUSES 1 TO 29

Z3

* M VERSIONS

	FUSE NUMBER																													
	1	2	3	4	5	6	7	8	9	10	11	12	13	14	15	16	17	18	19	20	21	22	23	24	25	26	27	28	29	
	30A	*15A 10A	30A	15A	30A	20A	5A	15A	20A	30A	7.5A	7.5A	*5A 7.5A	30A	10A	5A	15A	30A	30A	5A	5A	5A	10A	5A	10A	5A	5A	7.5A		
1210.17 ENGINE CONTROL SYSTEM MS41.1 (6-CYLINDER S52)													●			●		●												
1210.25 ENGINE CONTROL SYSTEM MS42.1 (6-CYLINDER M52)													●			●		●									●	●		
1230.0 CHARGING SYSTEM																											●	●		
1240.0 START																													●	
1290.0 E-BOX FAN																											●			
2460.2 ELECTRONIC TRANSMISSION CONTROL (EGS A4S 270R)																										●		●		
3234.0 SUPPLEMENTAL RESTRAINT SYSTEM (AIR BAG)																								●			●			
3450.1 SLIP CONTROL (ABS/ASC)										●			●							●							●			
3614.0 TIRE INFLATION SYSTEM																														
5116.0 POWER MIRRORS																									●					
5126.0 ZKE CENTRAL LOCKING (ZV)							●																							
5133.0 ZKE POWER WINDOWS (FH)														●																
5200.0 POWER SEATS					●															●										
5203.0 HEATED SEATS				●																										
5410.5 POWER TILT SUNROOF																									●					
5430.2 ELECTRO-HYDRAULIC CONVERTIBLE TOP	●																													
6100.0 CENTRAL BODY ELECTRONICS (ZKE IV)		●												●																
6133.0 HORN								●																						
6135.1 DRIVE-AWAY PROTECTION (EWS III)																													●	
6160.1 WIPER/WASHER MODULE (WWM)	●		●																											
6167.1 HEADLIGHT WASHER (SRA)			●																											

03/00

0670.1-00

1999



FUSE CHART

FUSES 1 TO 29

Z3

* M VERSIONS

	FUSE NUMBER																												
	1	2	3	4	5	6	7	8	9	10	11	12	13	14	15	16	17	18	19	20	21	22	23	24	25	26	27	28	29
	30A	*15A 10A	30A	15A	30A	20A	5A	15A	20A	30A	7.5A	7.5A	*5A 7.5A	30A	10A	5A		15A	30A	30A	5A	5A	5A	10A	5A	10A	5A	5A	7.5A
6169.0 WINDSHIELD WASHER JET HEATERS																								●					
6211.0 INSTRUMENT CLUSTER				●			●																●			●	●		
6213.3 DIGITAL CLOCK																													
6300.0 LIGHT SWITCH DETAILS																						●	●		●				
6312.0 HEADLIGHTS/FOG LIGHTS											●	●		●								●	●		●				●
6313.0 TURN/HAZARD LIGHTS																							●						
6314.0 PARK/TAIL/UNDERHOOD LIGHTS																													
6320.0 LICENSE PLATE/LUGGAGE COMPARTMENT LIGHTS																													
6322.0 BACK UP LIGHTS																										●			
6325.0 BRAKE LIGHTS													●																
6330.3 INTERIOR LIGHTS	●																												
6332.0 INTERIOR ACCESSORIES																													
6350.0 CRASH CONTROL MODULE											●	●													●				
6424.0 REAR WINDOW DEFOGGER						●																	●						
6450.6 INTEGRATED HEATING- AND CLIMATE CONTROL																●					●			●					
6510.1 RADIO/HIFI									●																				
6561.0 CELLULAR TELEPHONE (PROVISIONS)																													
6571.0 CRUISE CONTROL (TEMPOMAT)													●														●		
6575.2 ANTI-THEFT SYSTEM (ALPINE)																													
6581.3 BOARD COMPUTER (BC – LOW)																													



FUSE CHART

FUSES 30 TO 205

Z3

	FUSE NUMBER																											
	30	31	32	33	34	35	36	37	38	39	40	41	42	43	44	45	46	47	48	49					202	203	204	205
	7.5A	5A	30A	10A	15A	25A	30A	10A	30A	7.5A	30A	15A	5A	5A	15A	7.5A	15A				40A	50A			30A	20A	30A	30A
1210.17 ENGINE CONTROL SYSTEM MS41.1 (6-CYLINDER S52)										●																		
1210.25 ENGINE CONTROL SYSTEM MS42.1 (6-CYLINDER M52)										●							●								●	●	●	●
1230.0 CHARGING SYSTEM																												
1240.0 START		●														●												
1290.0 E-BOX FAN																												
2460.2 ELECTRONIC TRANSMISSION CONTROL (EGS A4S 270R)																	●										●	
3234.0 SUPPLEMENTAL RESTRAINT SYSTEM (AIR BAG)												●	●															
3450.1 SLIP CONTROL (ABS/ASC)									●								●			●								
3614.0 TIRE INFLATION SYSTEM																												
5116.0 POWER MIRRORS																												
5126.0 ZKE CENTRAL LOCKING (ZV)						●								●														
5133.0 ZKE POWER WINDOWS (FH)																												
5200.0 POWER SEATS																												
5203.0 HEATED SEATS																												
5410.5 POWER TILT SUNROOF																												
5430.2 ELECTRO-HYDRAULIC CONVERTIBLE TOP																		●										
6100.0 CENTRAL BODY ELECTRONICS (ZKE IV)				●		●										●												
6133.0 HORN															●													
6135.1 DRIVE-AWAY PROTECTION (EWS III)		●															●											
6160.1 WIPER/WASHER MODULE (WWM)							●	●								●												
6167.1 HEADLIGHT WASHER (SRA)							●									●												

03/00

0670.1-02

1999



FUSE CHART

FUSES 30 TO 205

Z3

		FUSE NUMBER																												
		30	31	32	33	34	35	36	37	38	39	40	41	42	43	44	45	46	47	48	49	202	203	204	205					
		7.5A	5A	30A	10A	15A	25A	30A	10A	30A	7.5A	30A	15A	5A	5A	15A	7.5A	15A					30A	20A	30A	30A				
6169.0	WINDSHIELD WASHER JET HEATERS																													
6211.0	INSTRUMENT CLUSTER		●															●												
6213.3	DIGITAL CLOCK		●														●													
6300.0	LIGHT SWITCH DETAILS				●				●																					
6312.0	HEADLIGHTS/FOG LIGHTS	●																												
6313.0	TURN/HAZARD LIGHTS				●																									
6314.0	PARK/TAIL/UNDERHOOD LIGHTS				●				●																					
6320.0	LICENSE PLATE/LUGGAGE COMPARTMENT LIGHTS				●				●																					
6322.0	BACK UP LIGHTS																													
6325.0	BRAKE LIGHTS																	●												
6330.3	INTERIOR LIGHTS				●										●															
6332.0	INTERIOR ACCESSORIES			●					●																					
6350.0	CRASH CONTROL MODULE				●																									
6424.0	REAR WINDOW DEFOGGER																													
6450.6	INTEGRATED HEATING- AND CLIMATE CONTROL										●	●									●									
6510.1	RADIO/HIFI																●													
6561.0	CELLULAR TELEPHONE (PROVISIONS)				●											●														
6571.0	CRUISE CONTROL (TEMPOMAT)																	●												
6575.2	ANTI-THEFT SYSTEM (ALPINE)		●												●															
6581.3	BOARD COMPUTER (BC - LOW)		●														●													



0670.2 POWER DISTRIBUTION

Z3 VERSIONS

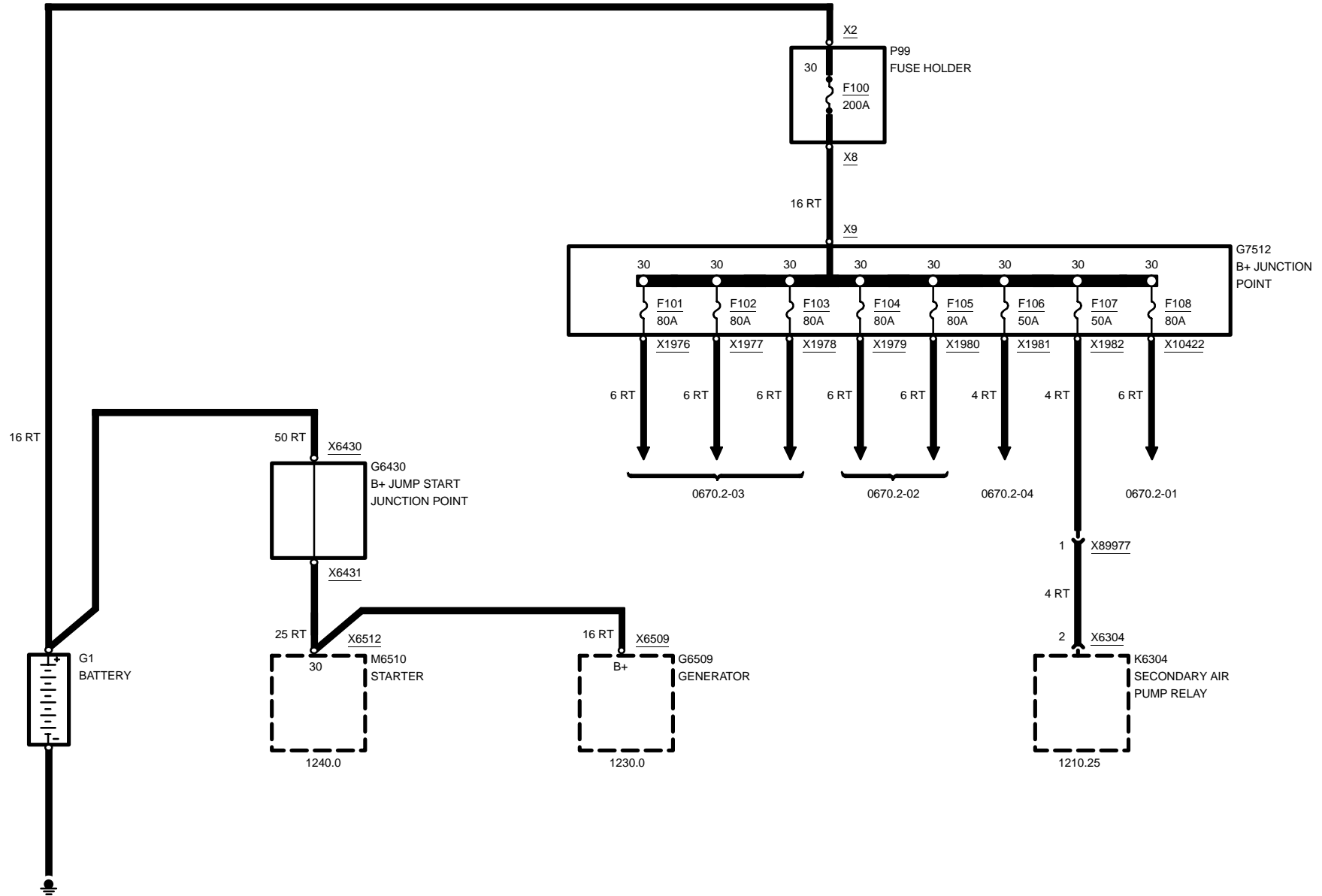

03/00

0670.2-00

1999



POWER DISTRIBUTION

Z3 VERSIONS

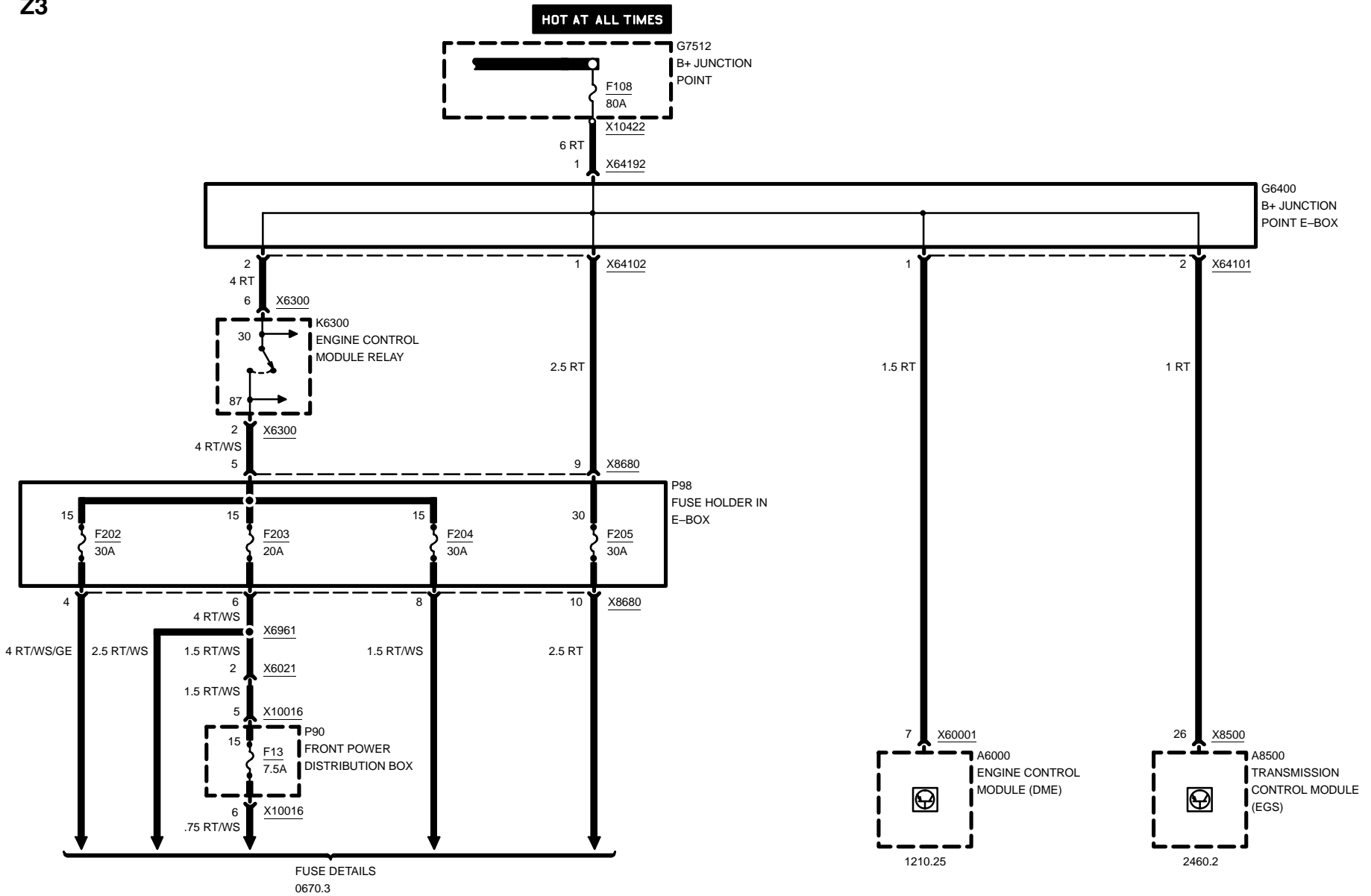

03/00

0670.2-01

1999

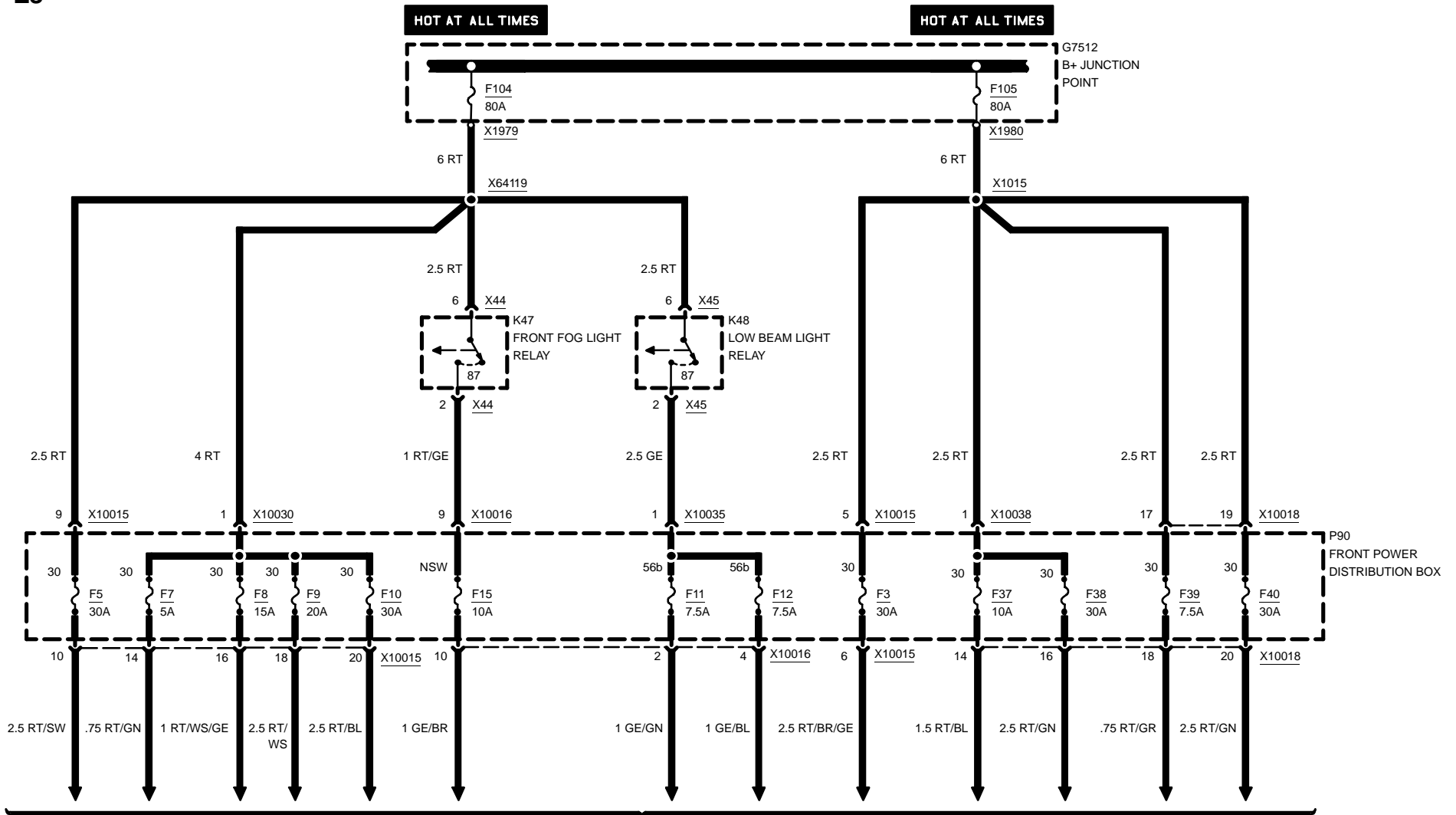

FUSE DETAILS
0670.3

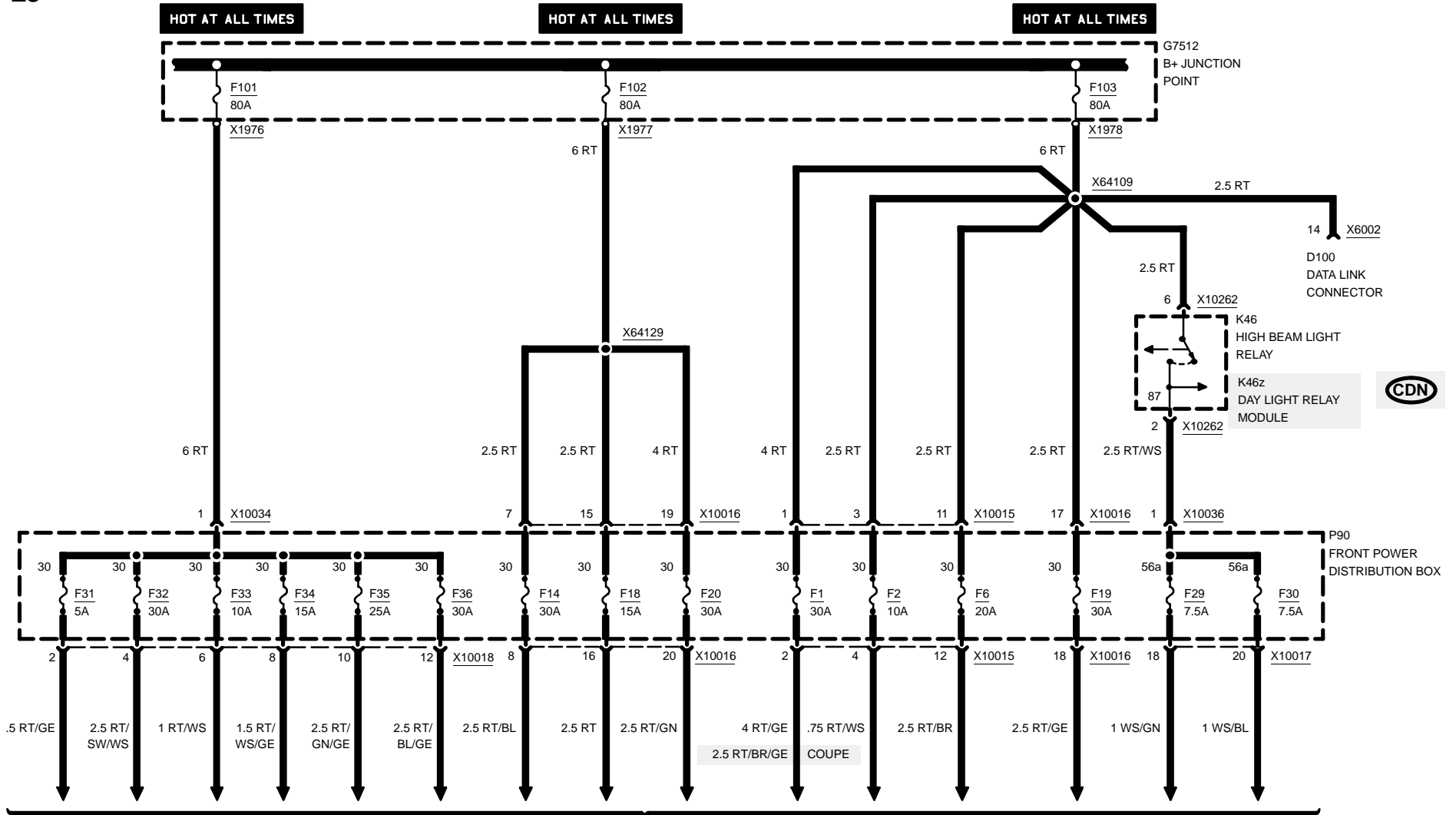

FUSE DETAILS
0670.3



Z3

POWER DISTRIBUTION

M VERSIONS

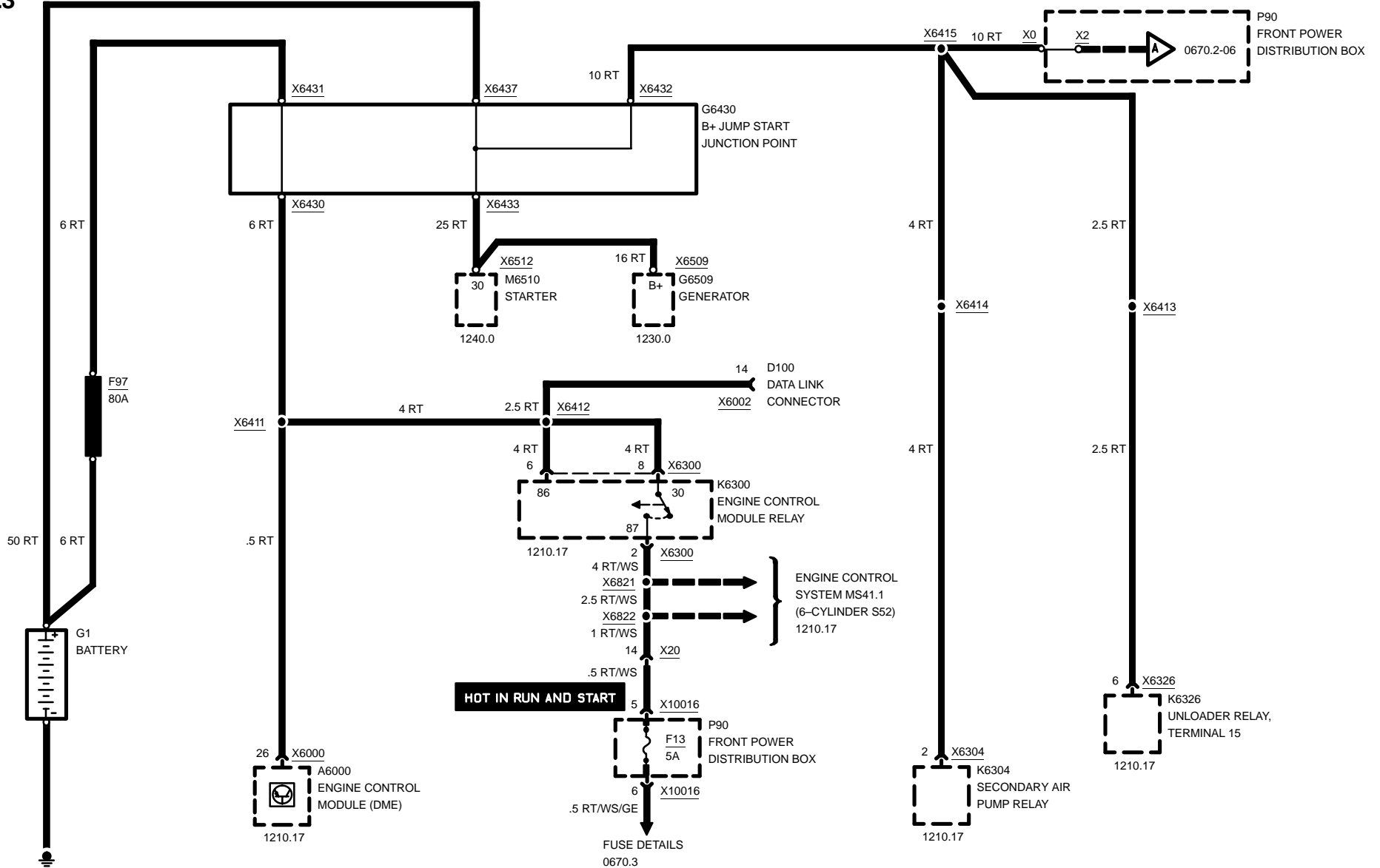

03/00

0670.2-05

1999



POWER DISTRIBUTION

M VERSIONS

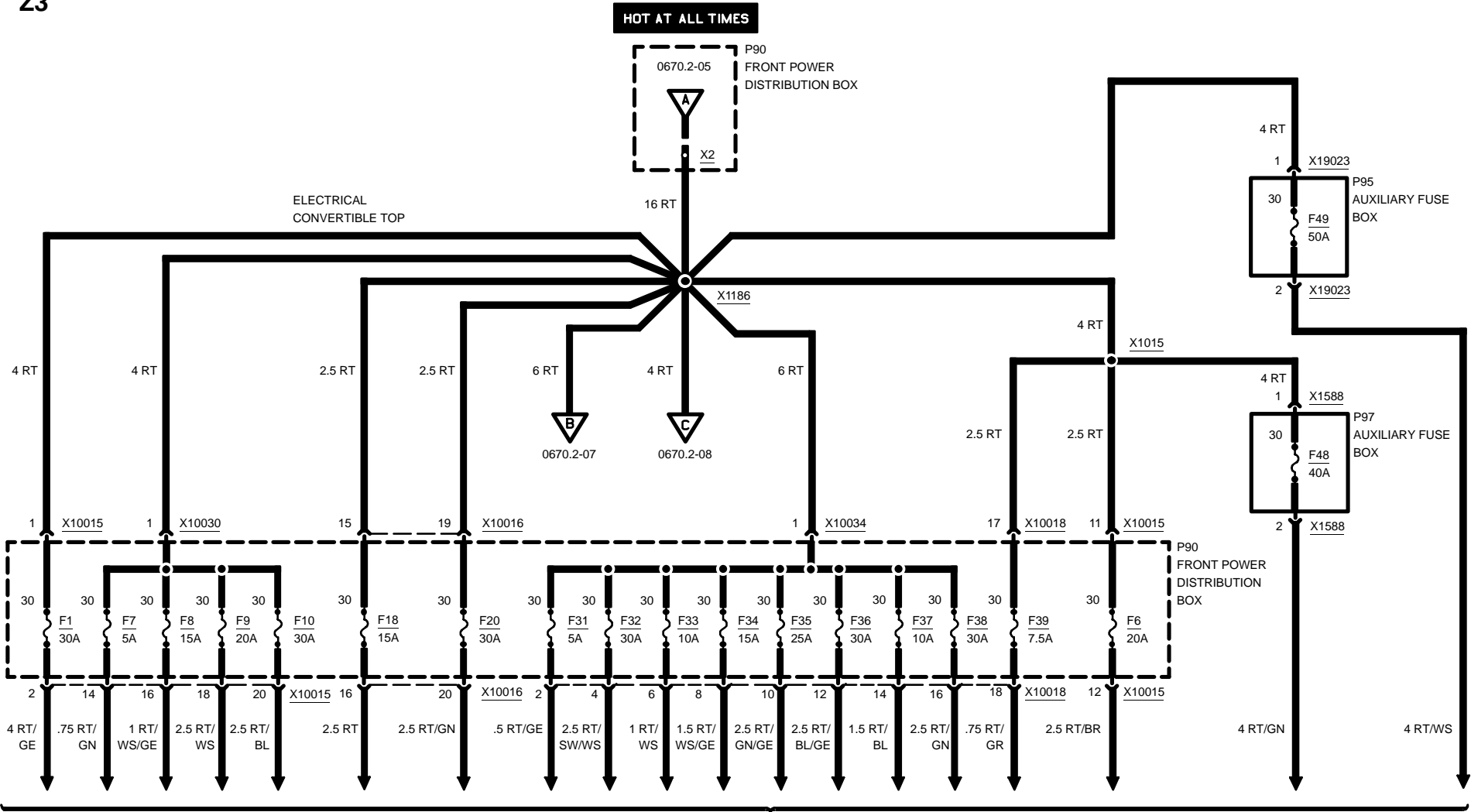

FUSE DETAILS
0670.3

03/00

0670.2-06

1999



POWER DISTRIBUTION

M VERSIONS

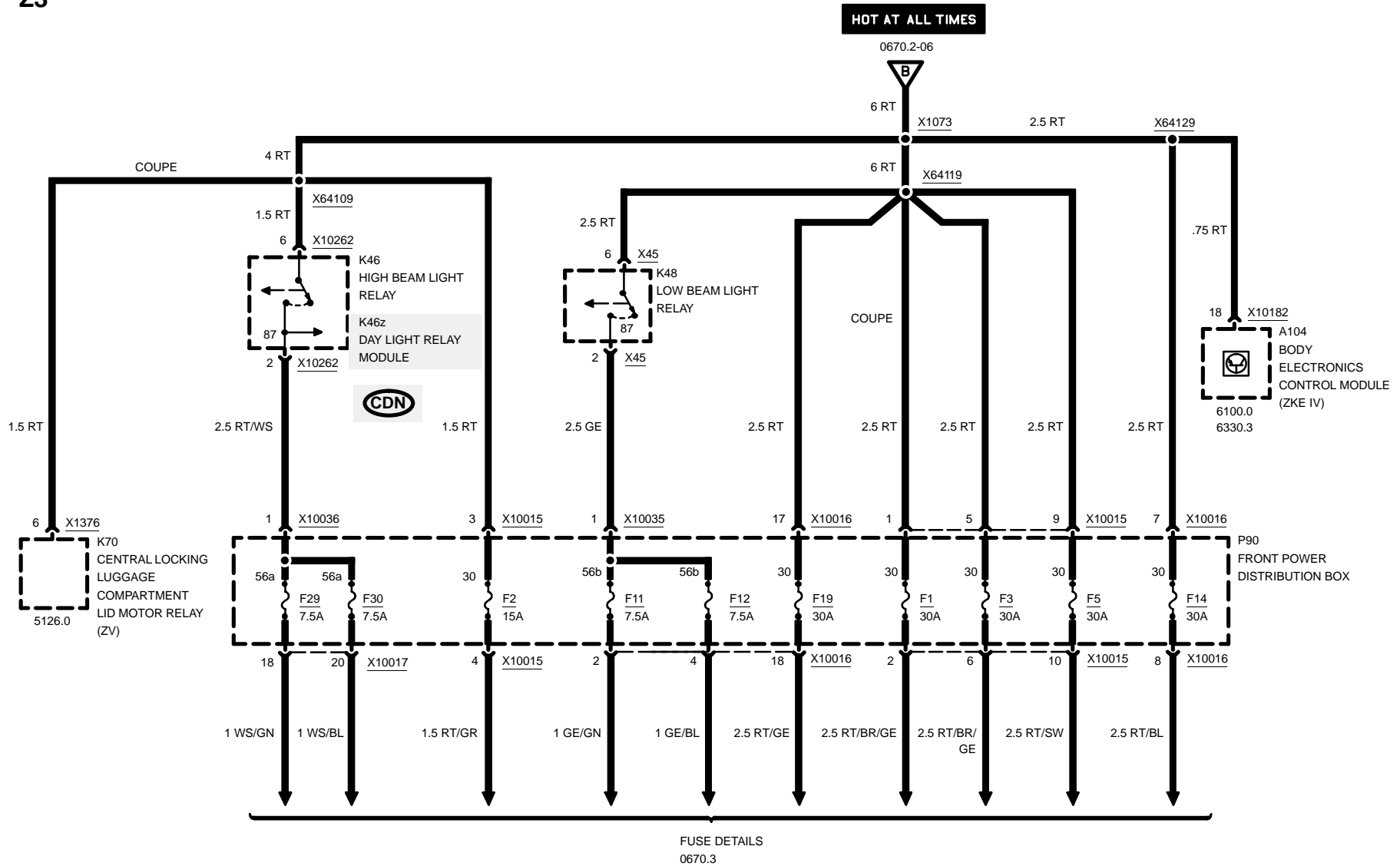

03/00

0670.2-07

1999



POWER DISTRIBUTION

M VERSIONS

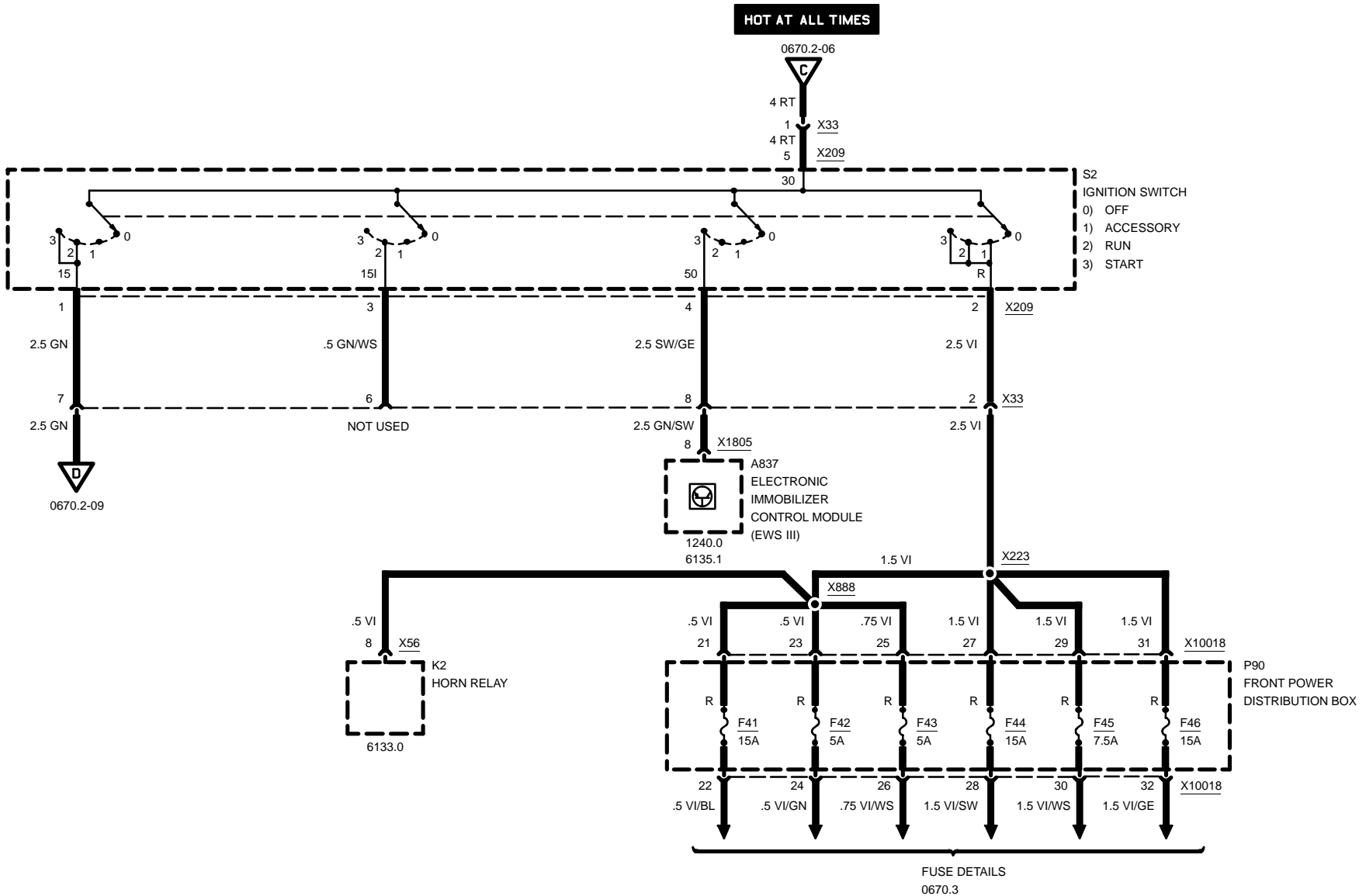

03/00

0670.2-08

1999



POWER DISTRIBUTION

M VERSIONS

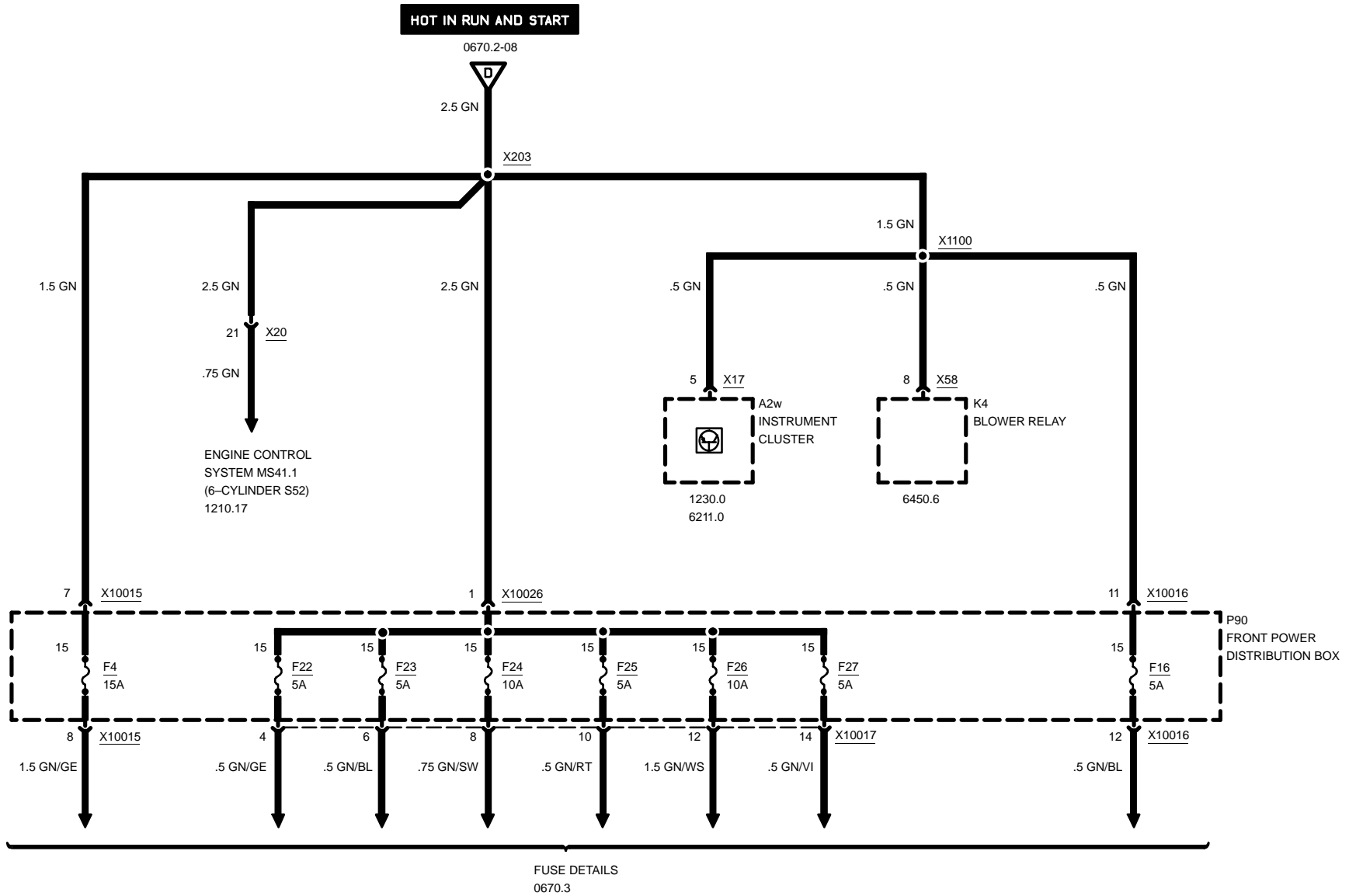

03/00

0670.2-09

1999



0670.3 FUSE DETAILS

FUSES 1, 2, 3, AND 4

Z3

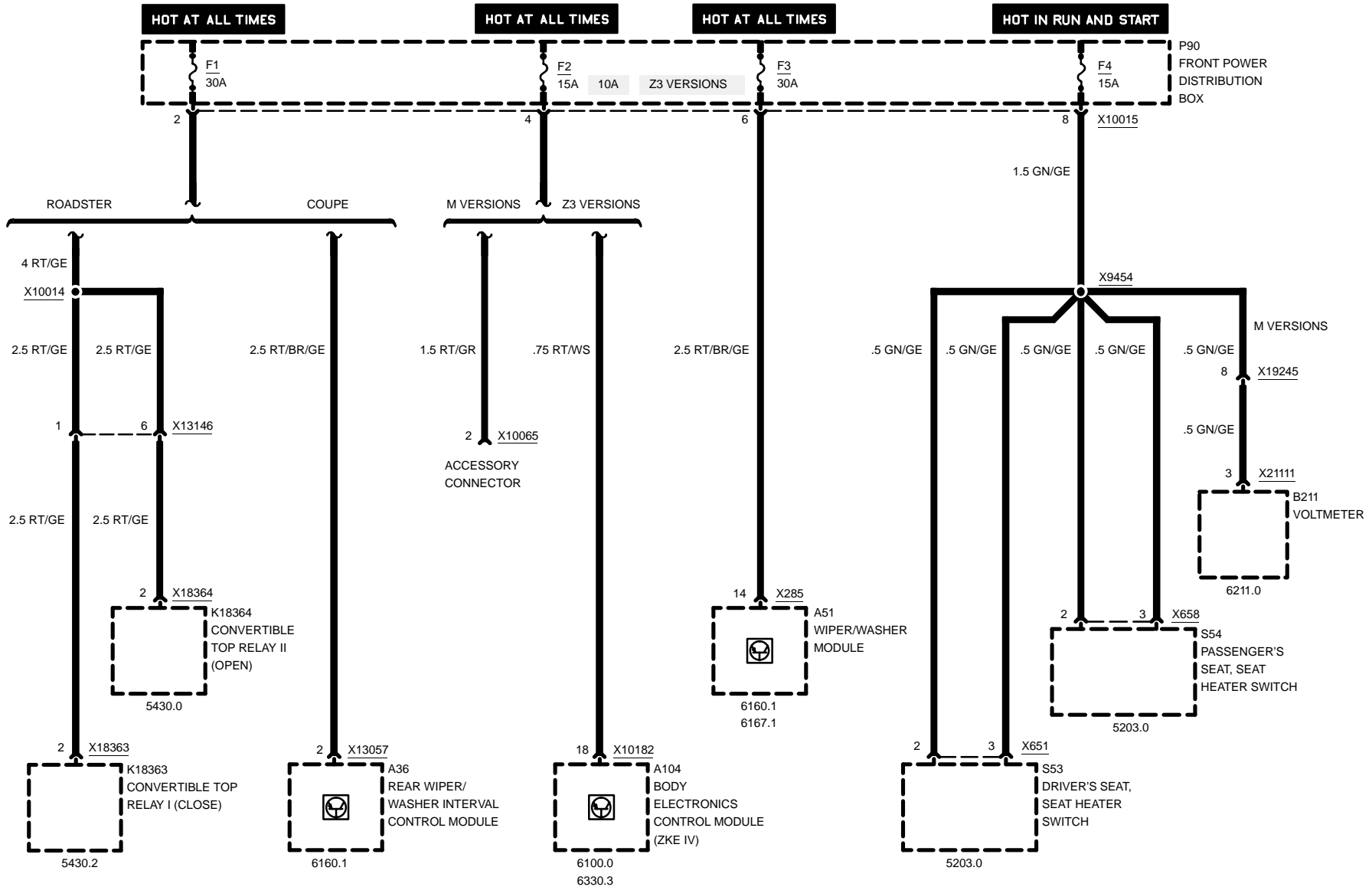

03/00

0670.3-00

1999



FUSE DETAILS

FUSES 5, 6, 7, AND 8

Z3

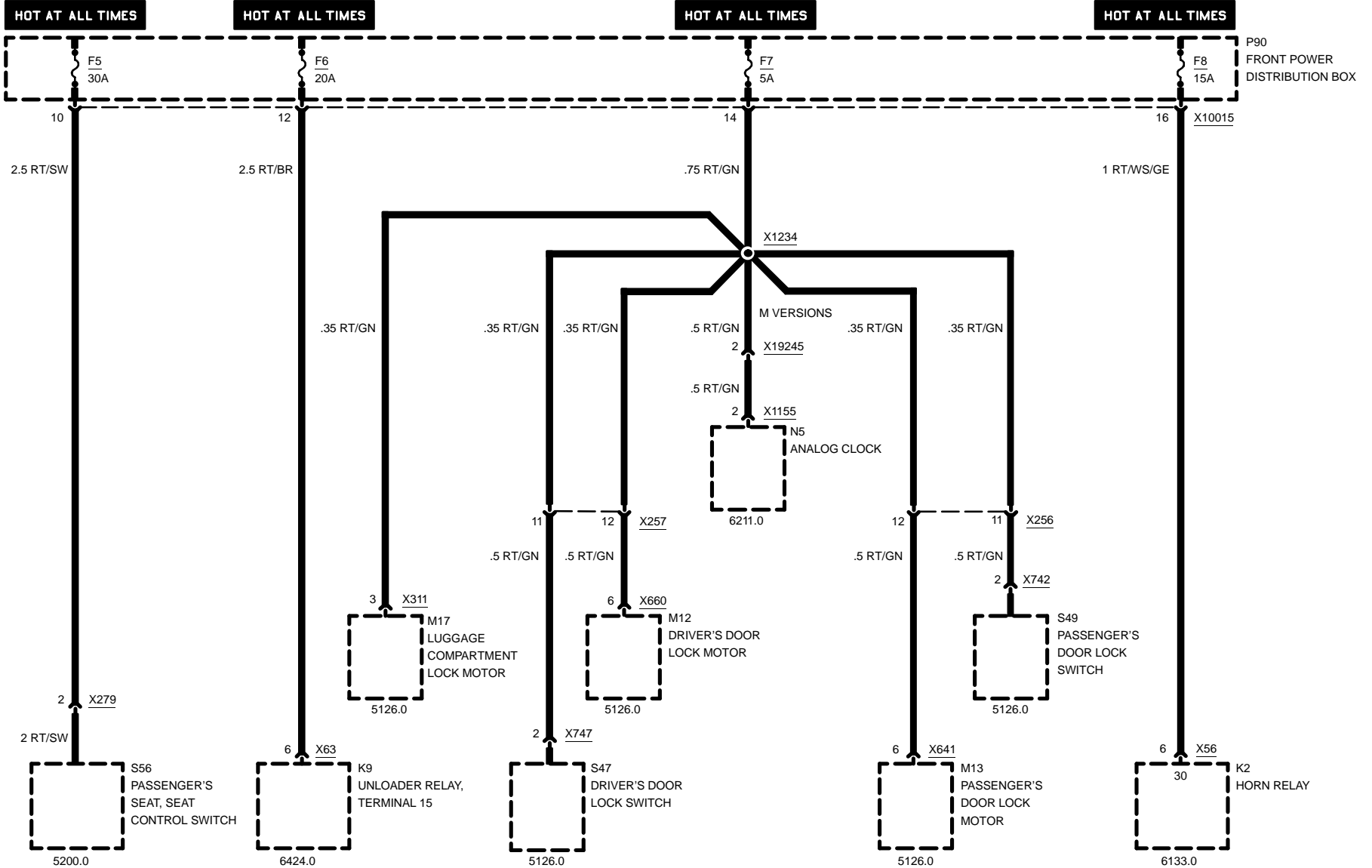

03/00

0670.3-01

1999



FUSE DETAILS

FUSES 9 AND 10

Z3

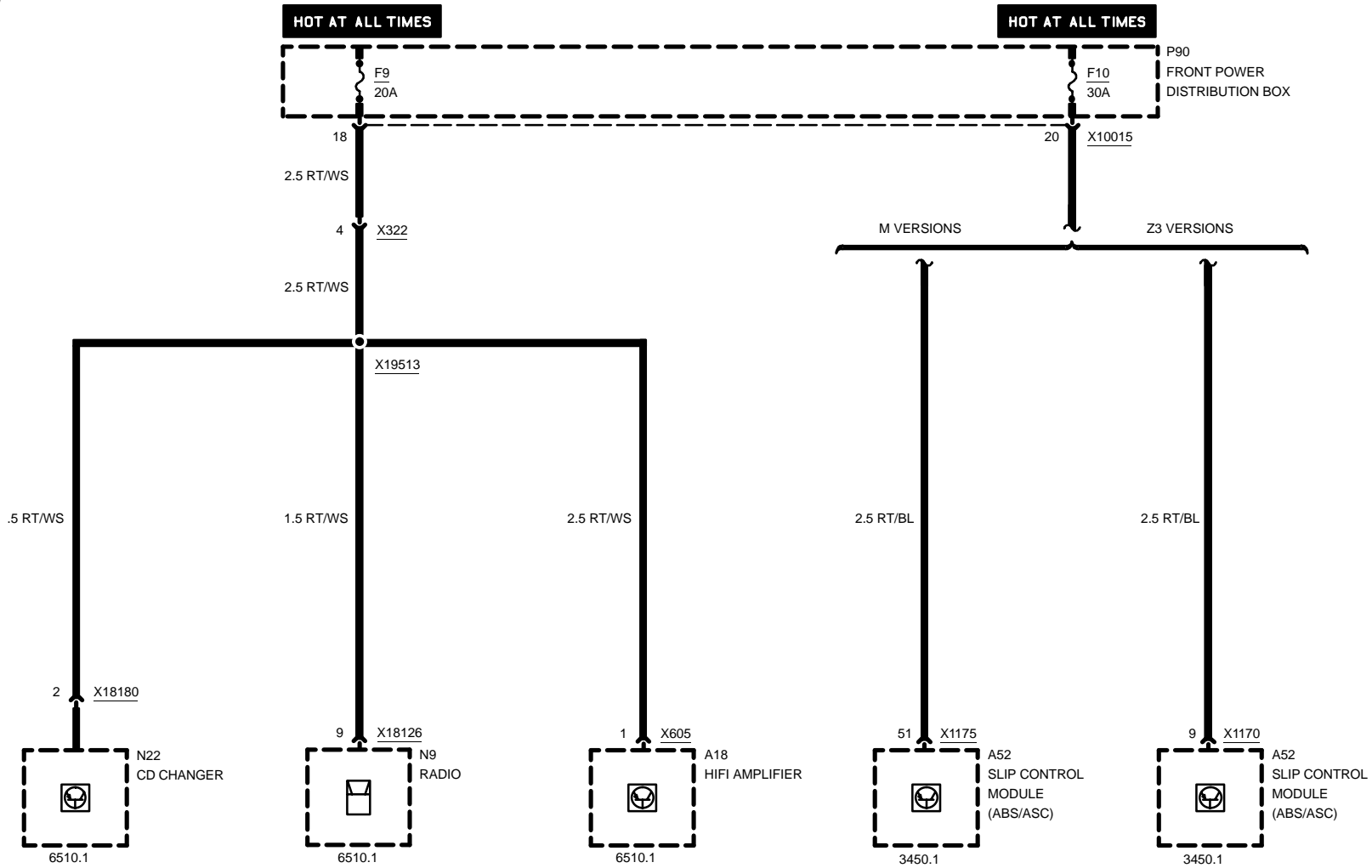

03/00

0670.3-02

1999



FUSE DETAILS

FUSES 11, 12, AND 13

Z3

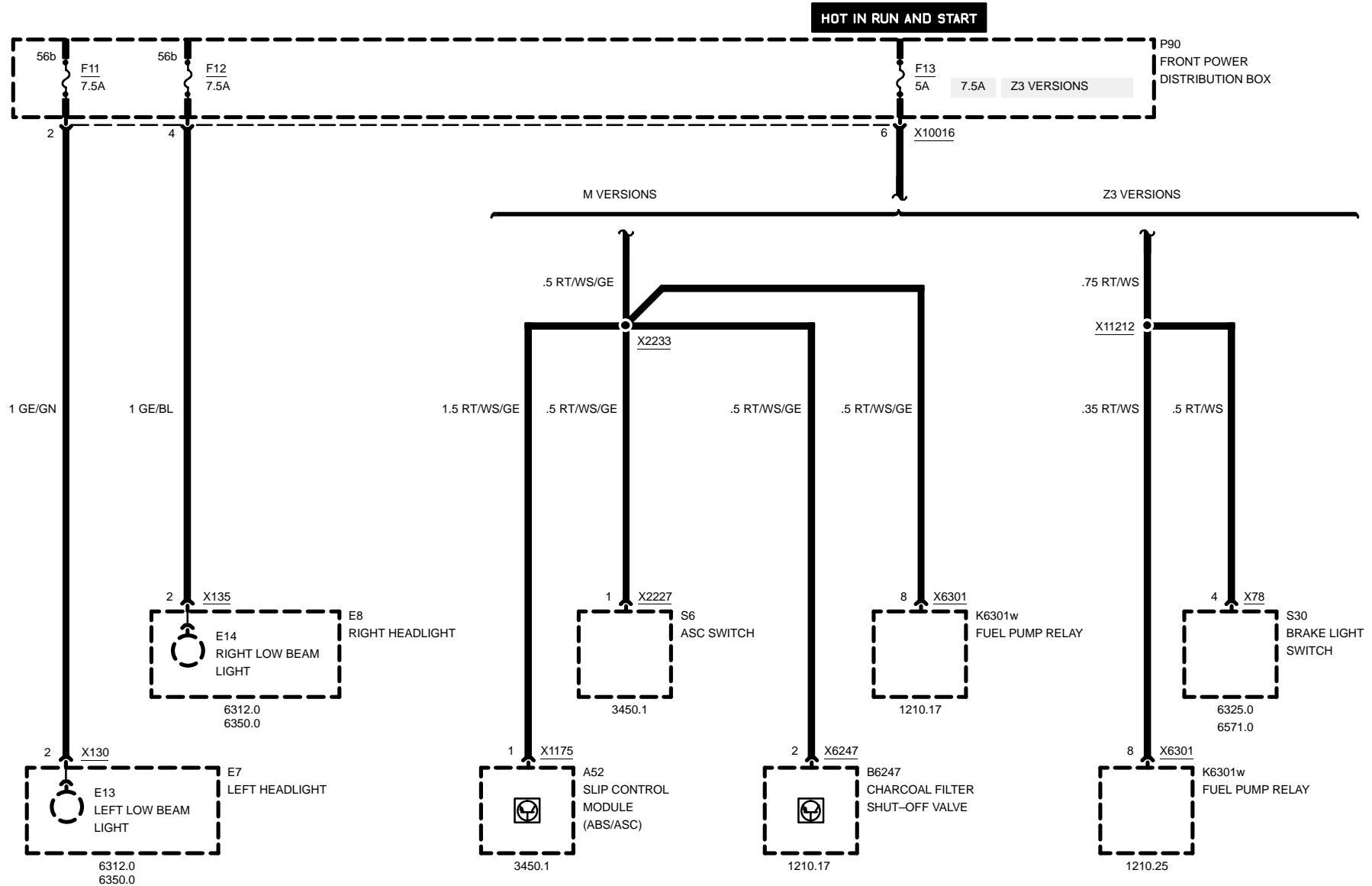

03/00

0670.3-03

1999



FUSE DETAILS

FUSES 14, 15, 16, AND 18

Z3

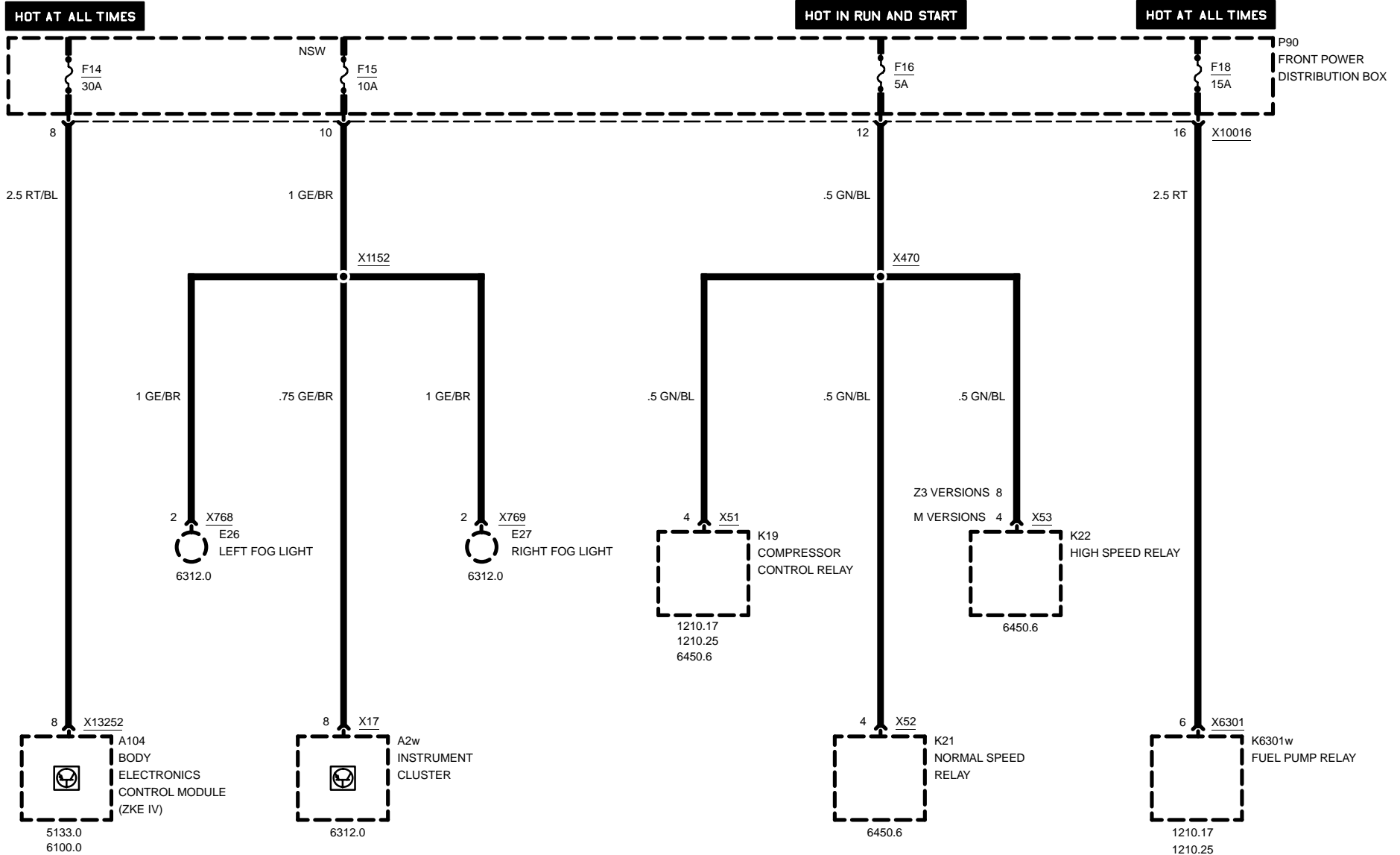

03/00

0670.3-04

1999



FUSE DETAILS

FUSES 19, 20, 21, AND 22

Z3

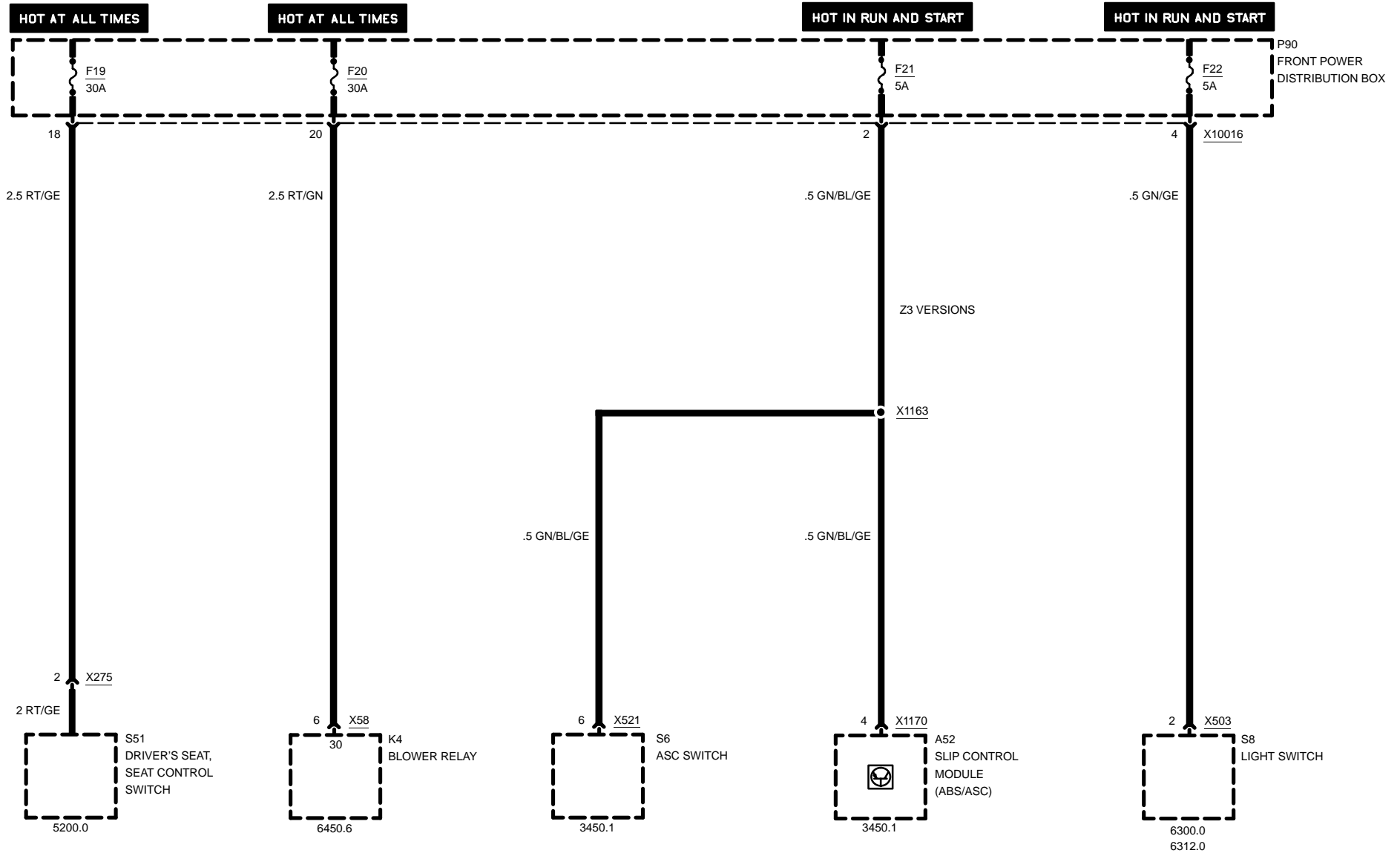

03/00

0670.3-05

1999



FUSE DETAILS

FUSE 23

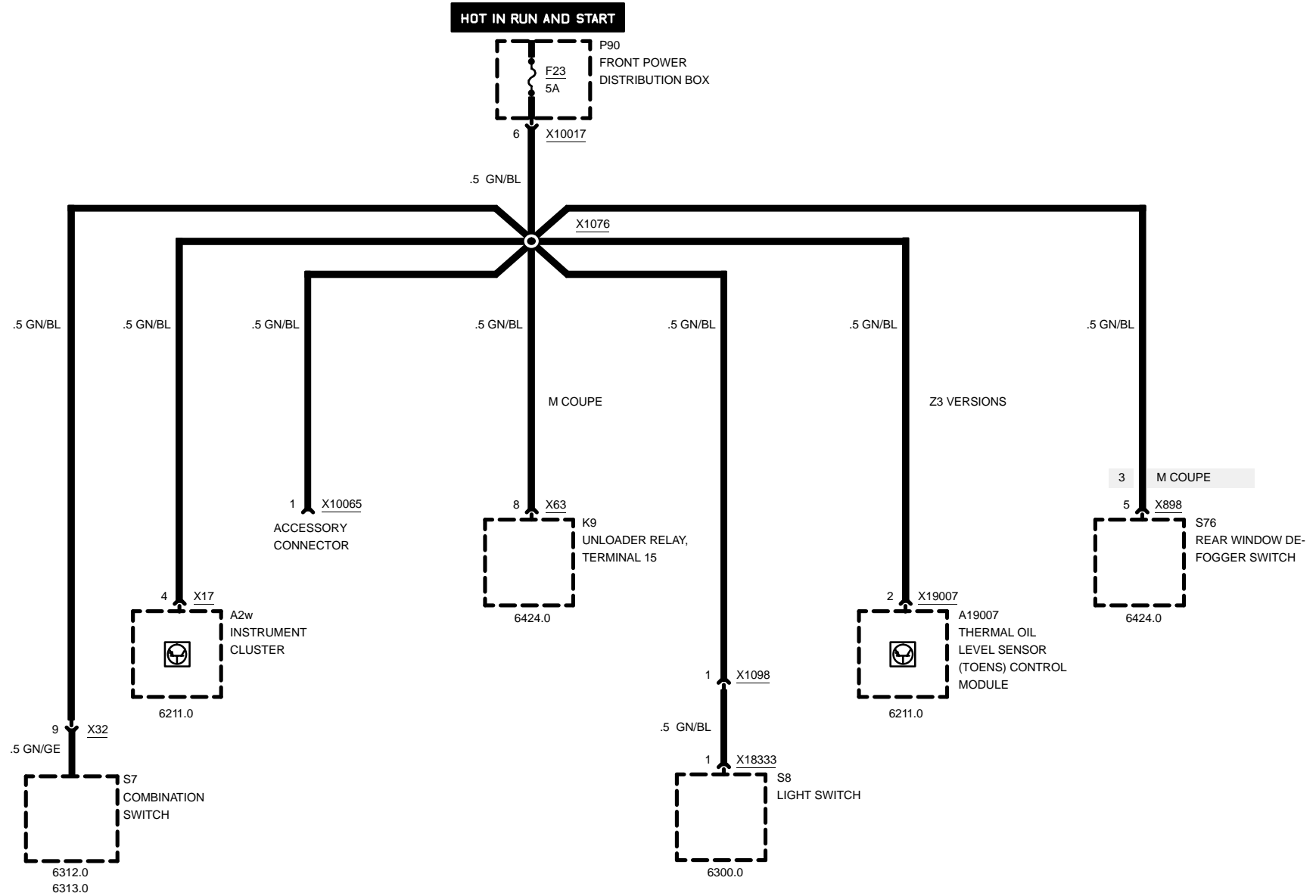



FUSE DETAILS

FUSES 24 AND 25

Z3

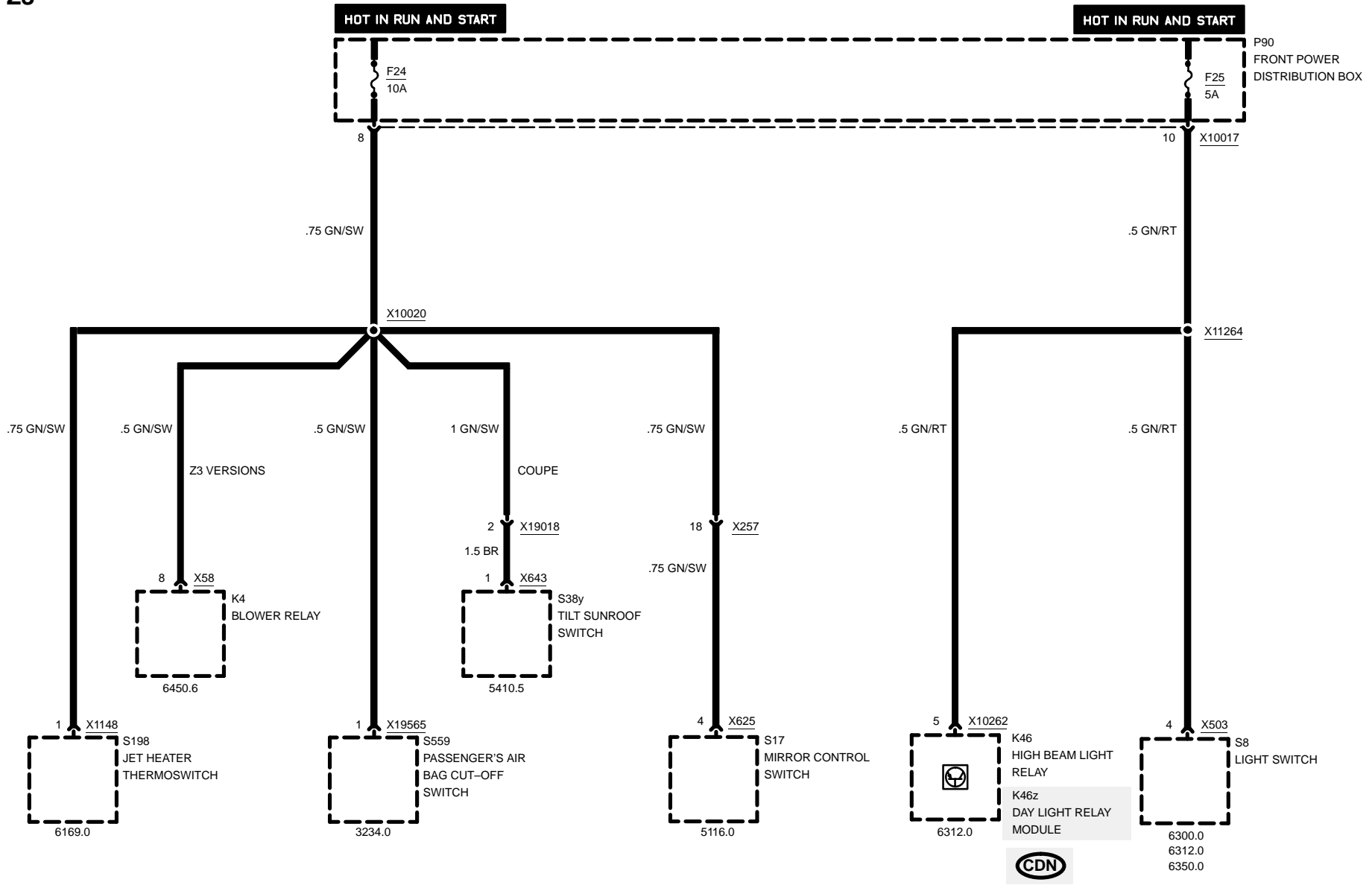

03/00

0670.3-07

1999



FUSE DETAILS

FUSE 26

Z3

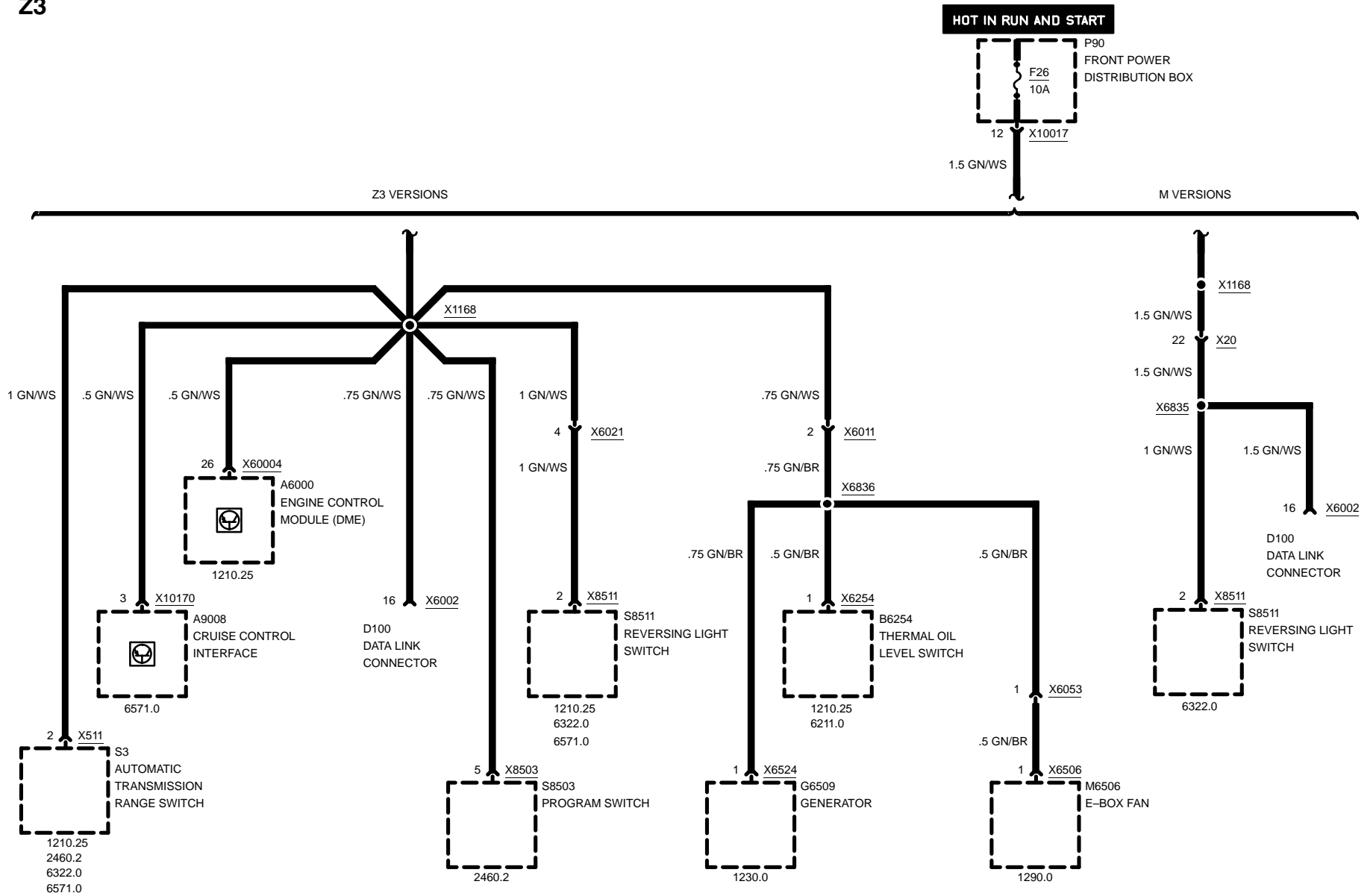

03/00

0670.3-08

1999



FUSE DETAILS

FUSES 27, 28, 29, AND 30

Z3

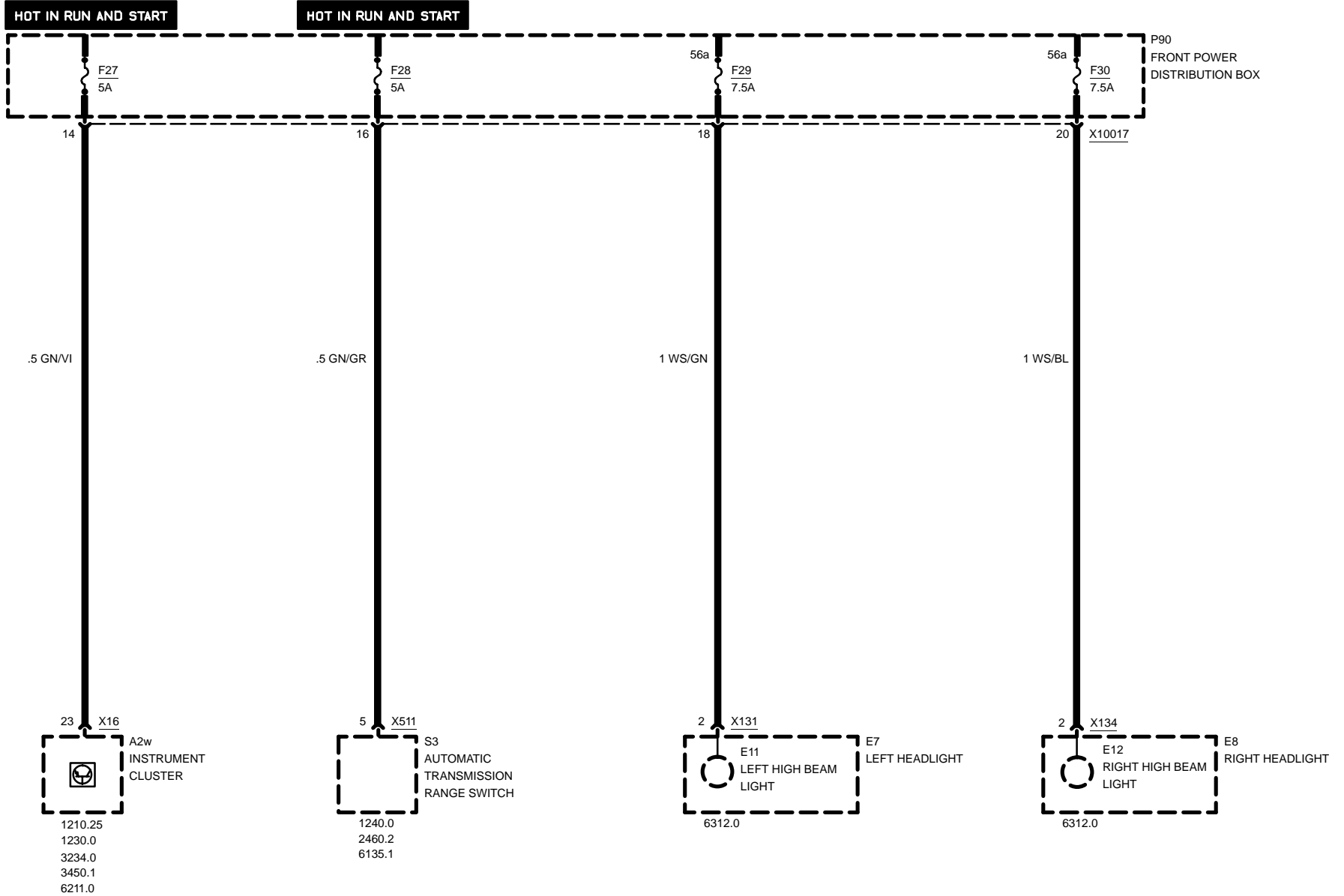

03/00

0670.3-09

1999



FUSE DETAILS

FUSE 31

HOT AT ALL TIMES

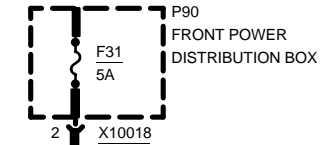

.5 RT/GE

X1067

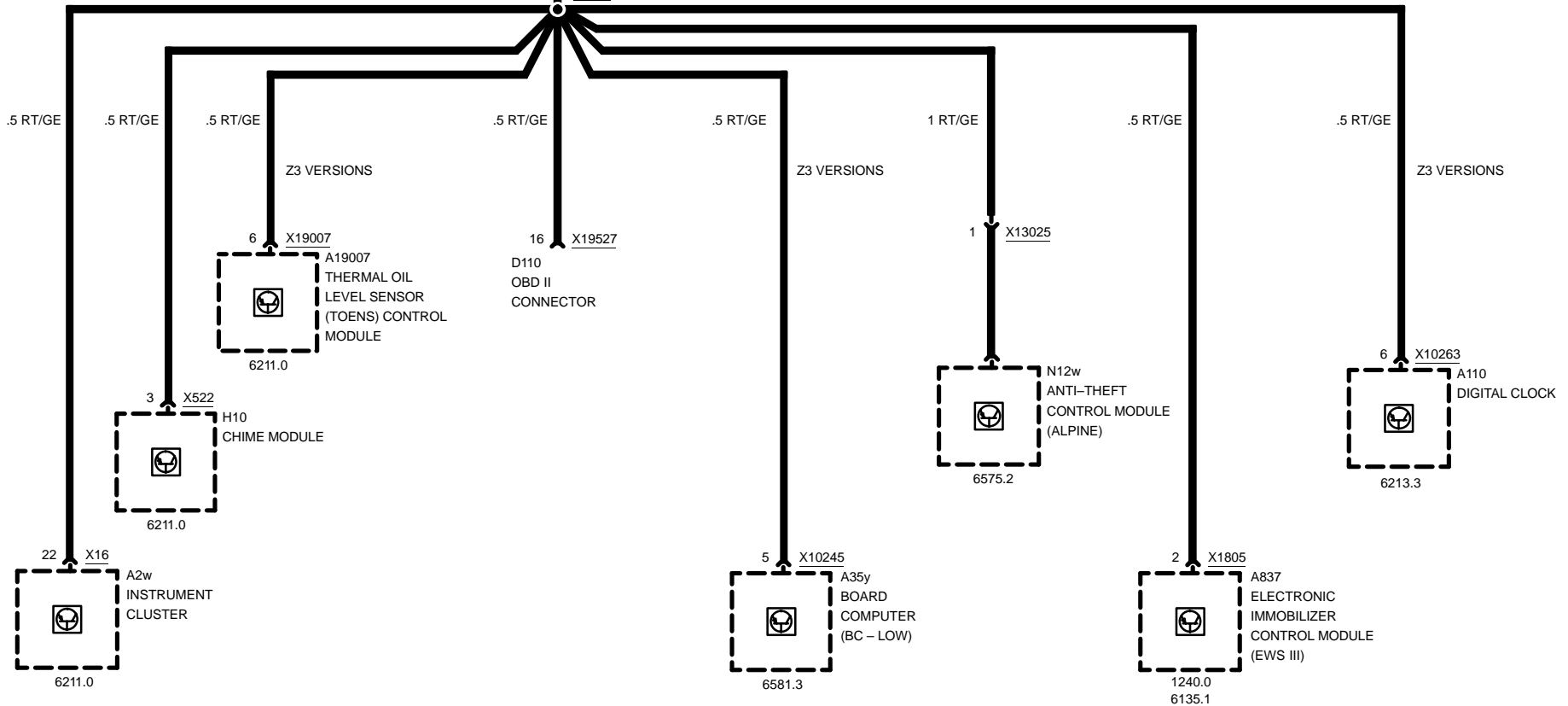



FUSE DETAILS

FUSES 32, 33, 34, AND 35

Z3

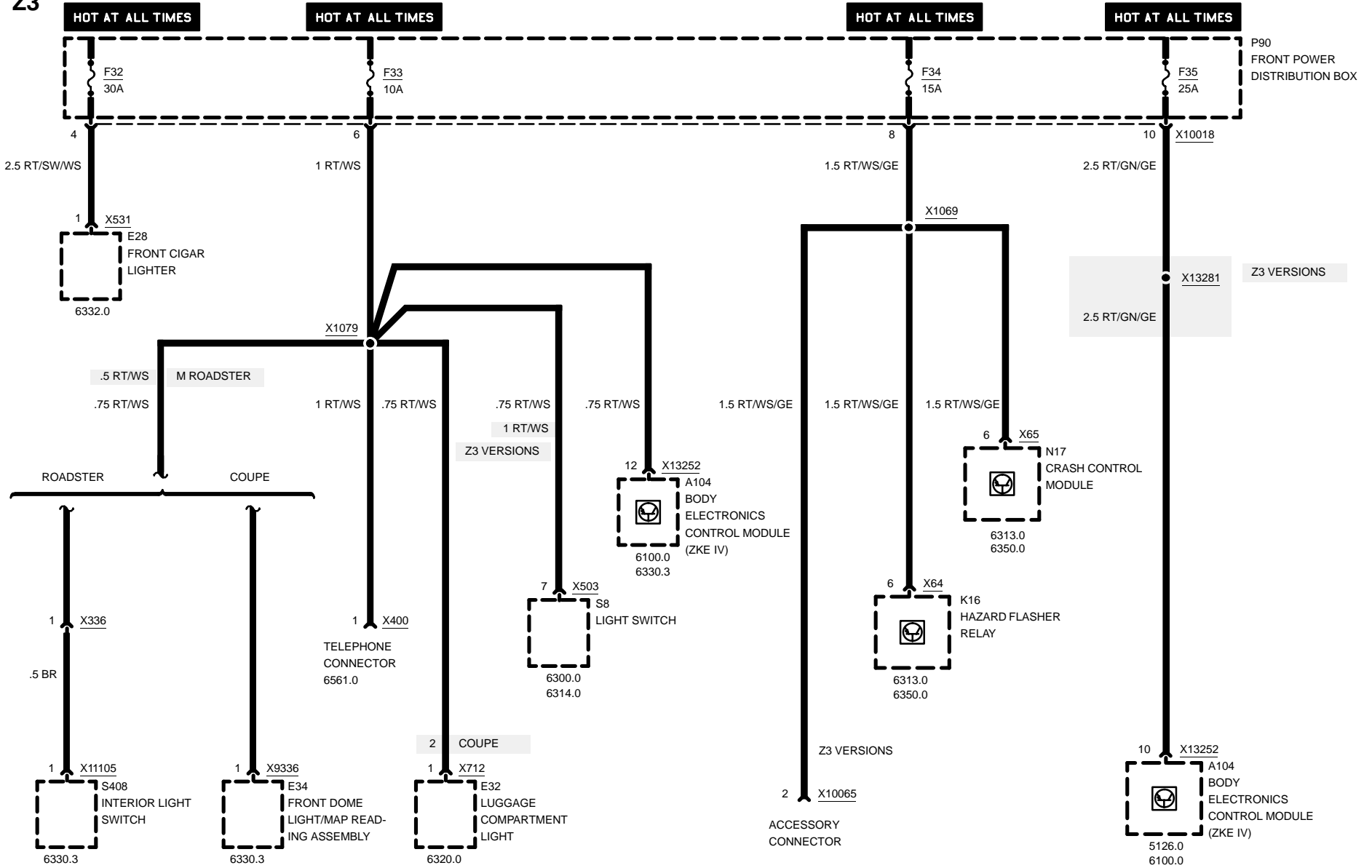

03/00

0670.3-11

1999



FUSE DETAILS

FUSES 36, 37, 38, AND 39

Z3

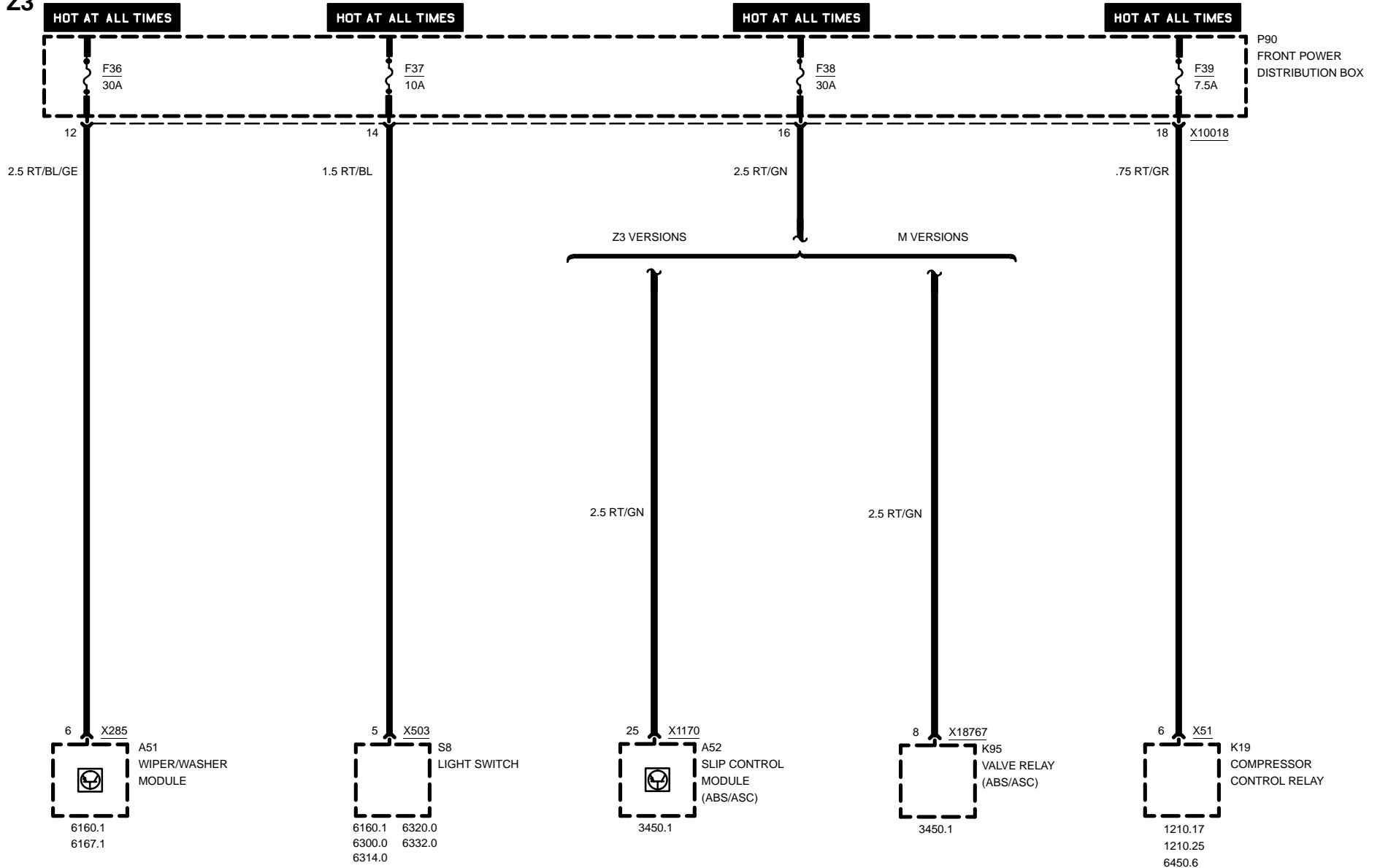

03/00

0670.3-12

1999



FUSE DETAILS

FUSES 40, 41, AND 42

Z3

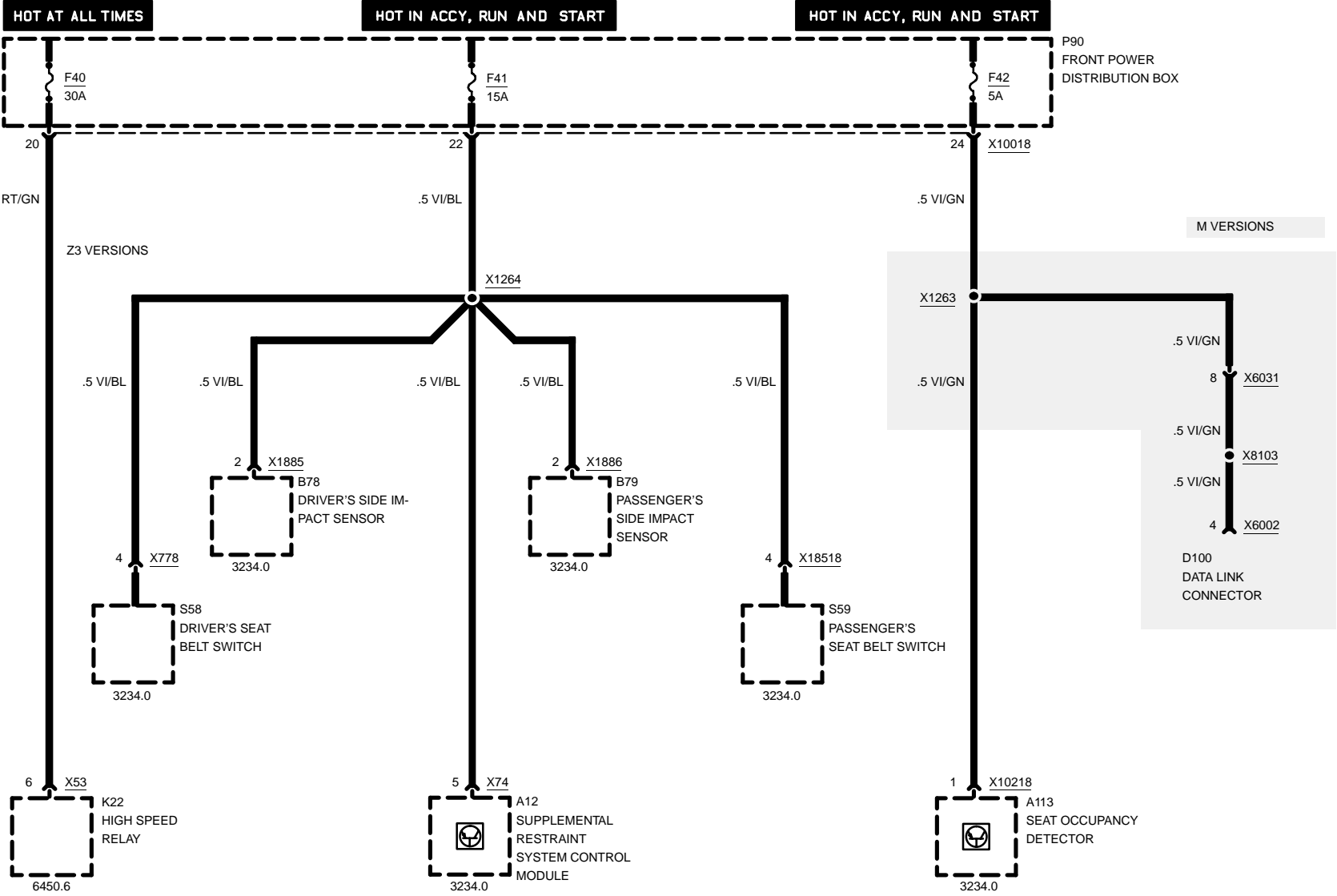

03/00

0670.3-13

1999



FUSE DETAILS

FUSE 46

HOT IN ACCY, RUN AND START

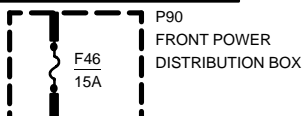

32 X10018

1.5 VI/GE

X1182

.5 VI/GE

1.5 VI/GE

.5 VI/GE

.5 VI/GE

.5 VI/GE

Z3 VERSIONS

M VERSIONS

M VERSIONS

M VERSIONS

5 X19245

.5 VI/GE

16 X17

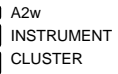

6211.0

1 X78

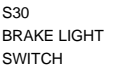

1210.25 5430.2
2460.2 6325.0
3450.1 6571.0

10 X10245



6581.3

3 X10059

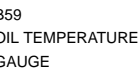

6211.0

26 X22

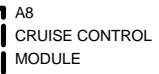

6571.0

1 X72

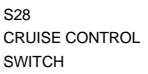

6571.0

03/00

0670.3-15

1999



Z3

FUSE DETAILS

FUSES 48 AND 49

M VERSIONS

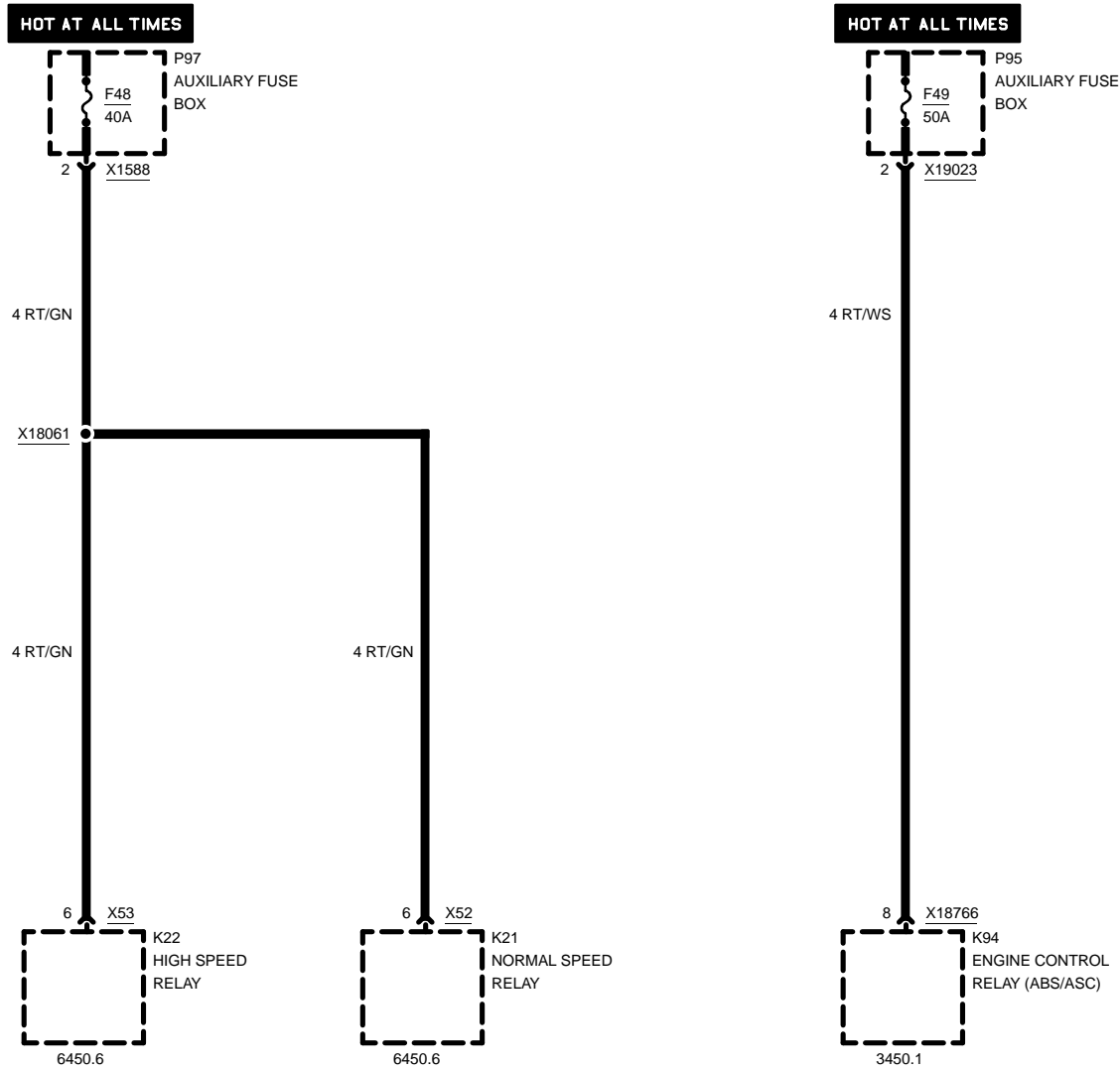

03/00

0670.3-16

1999



FUSE DETAILS

FUSE 202

Z3

HOT IN RUN AND START

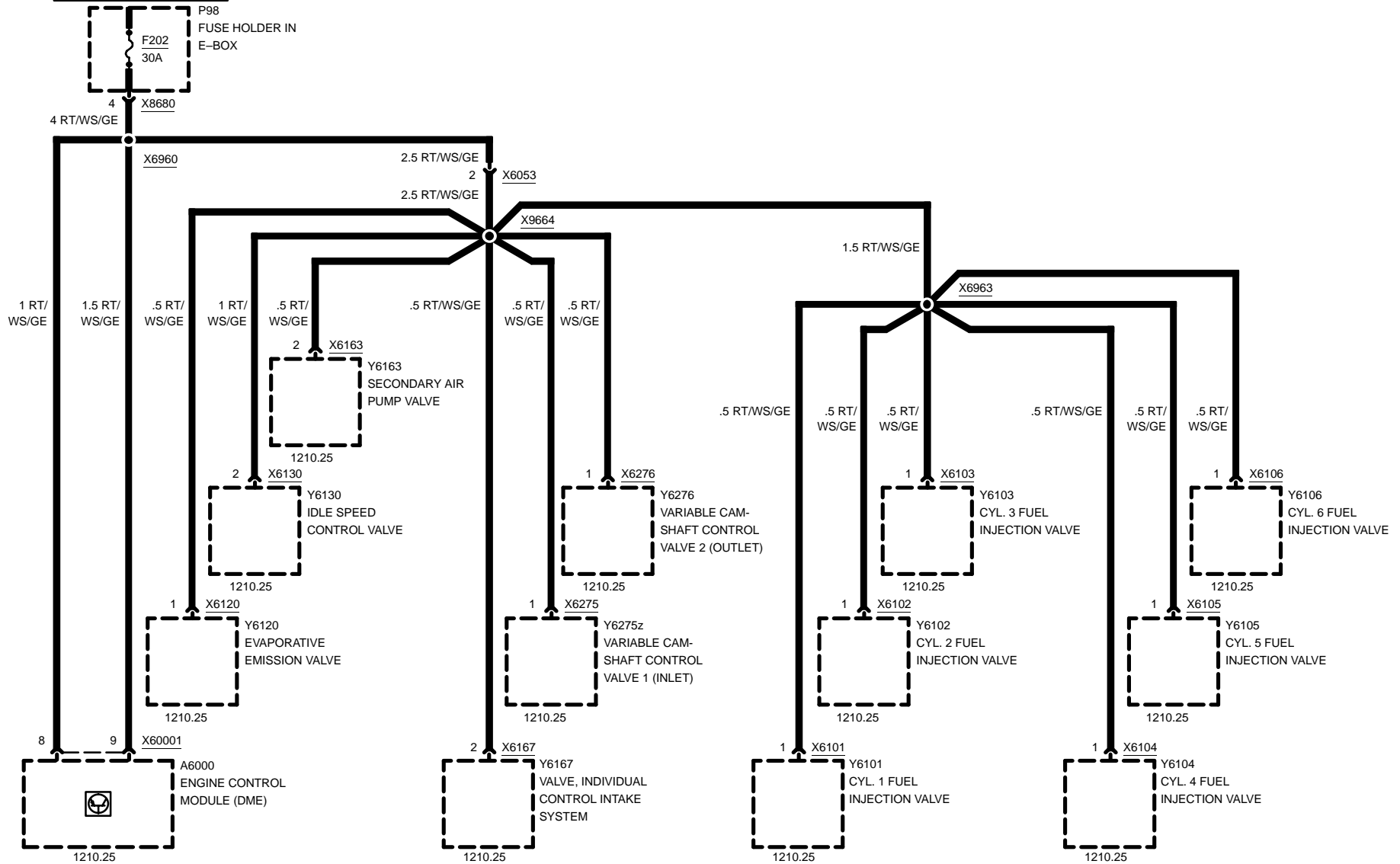

03/00

0670.3-17

1999



FUSE DETAILS

FUSES 203, 204, AND 205

Z3

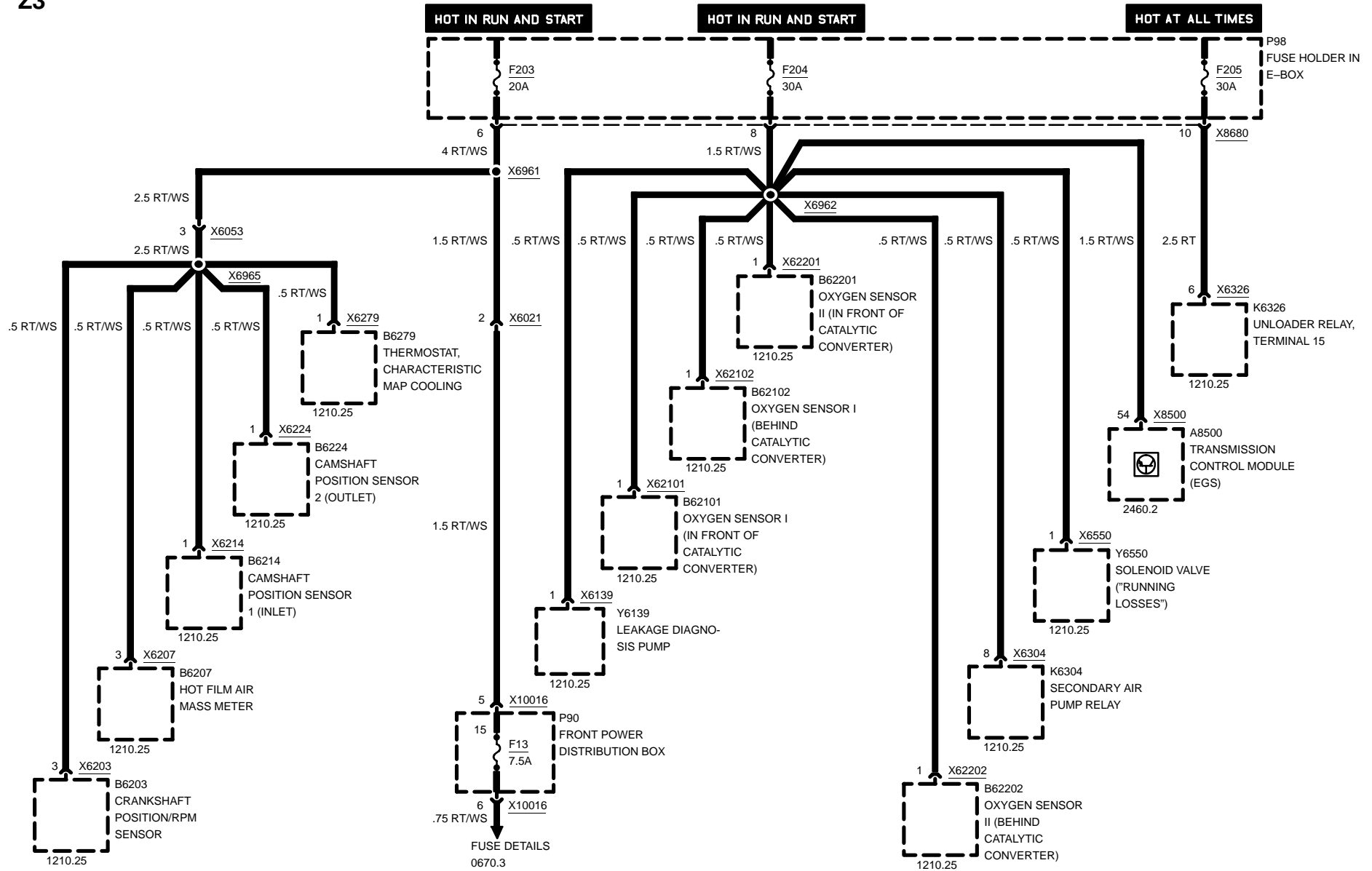



0670.4 GROUND DISTRIBUTION

GROUNDS X4 AND X165

M VERSIONS

Z3

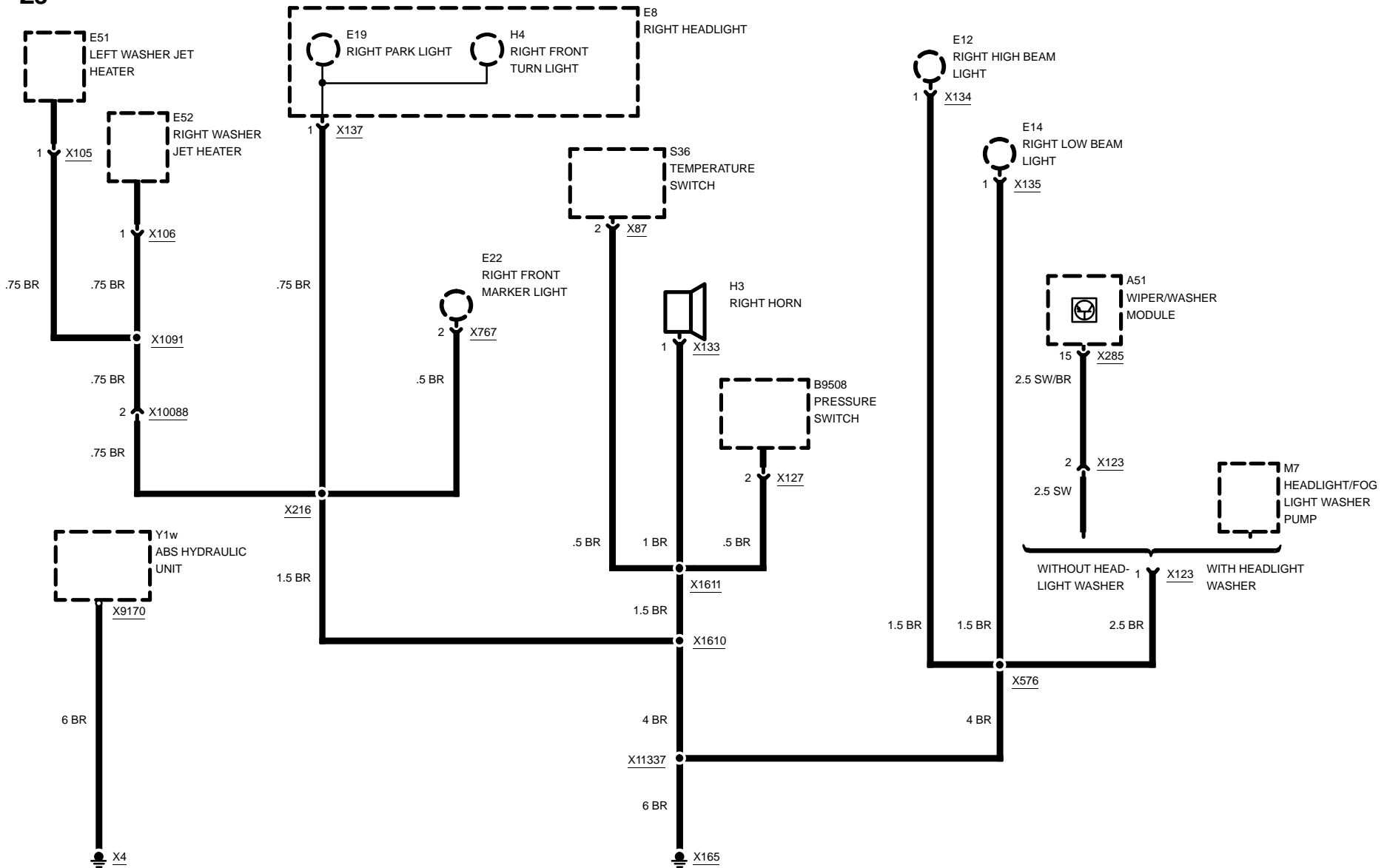

03/00

0670.4-00

1999



GROUND DISTRIBUTION

Z3 VERSIONS

GROUND X165

Z3

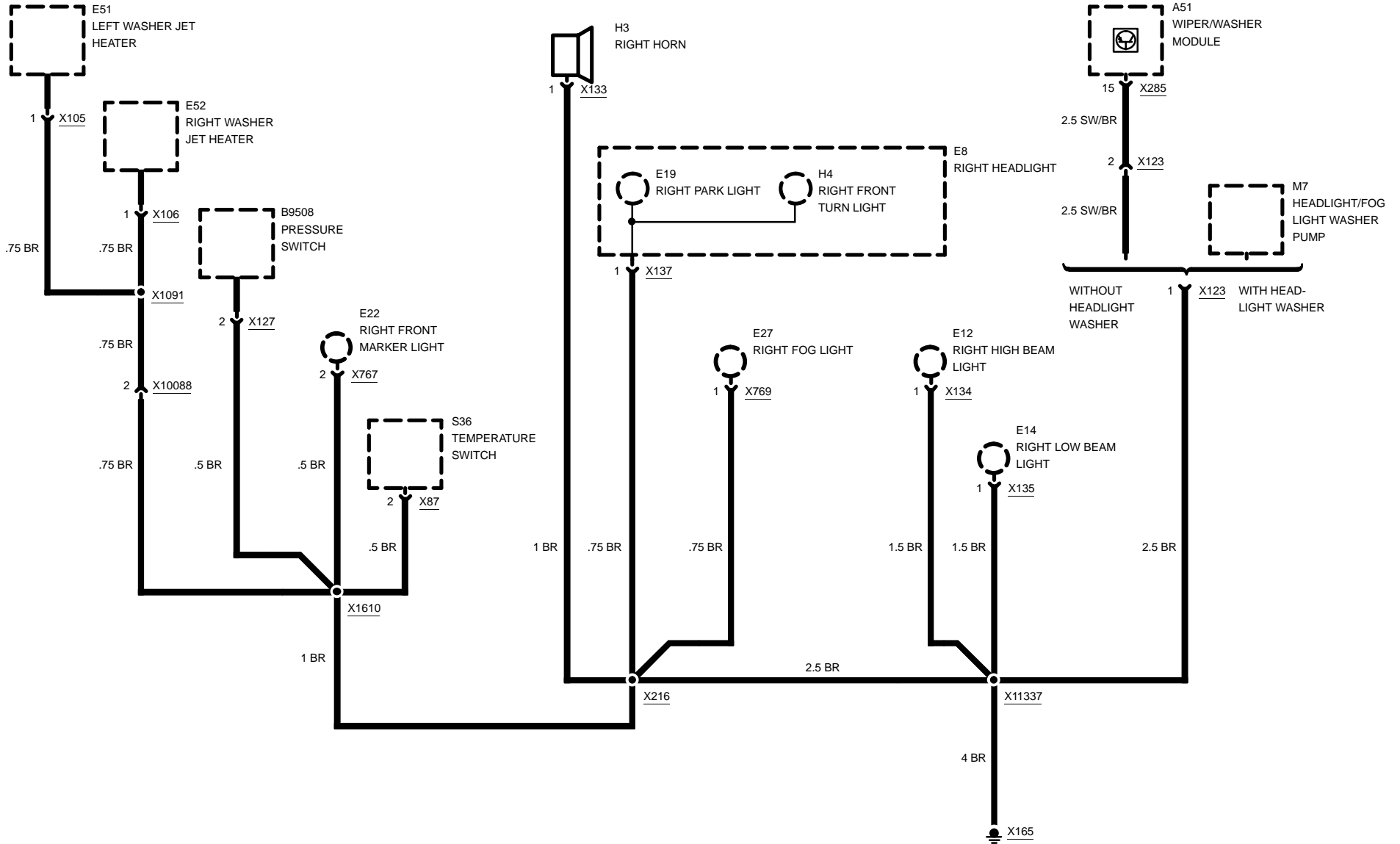

03/00

0670.4-01

1999



GROUND DISTRIBUTION

M VERSIONS

GROUND X166

Z3

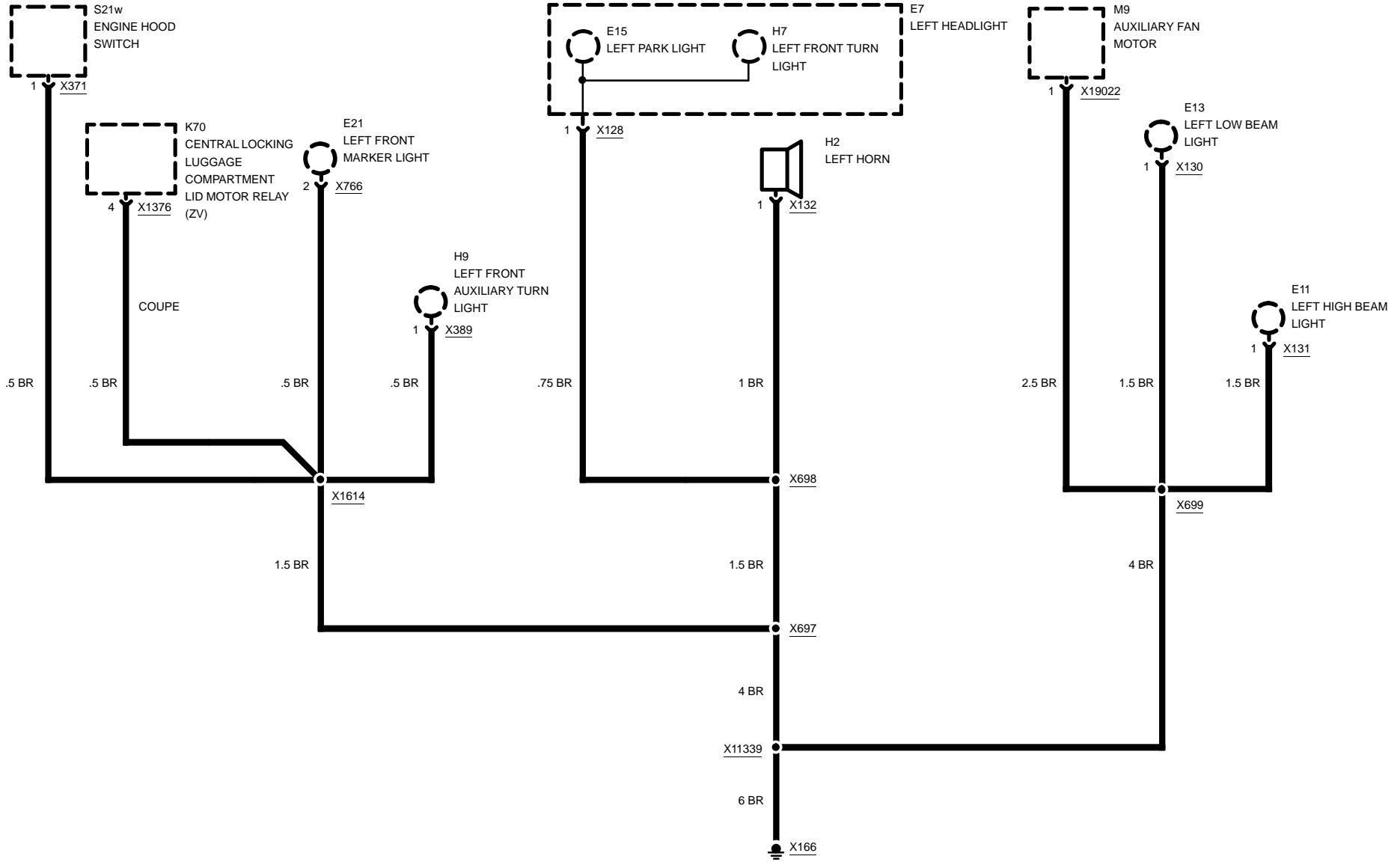

03/00

0670.4-02

1999



GROUND DISTRIBUTION

Z3 VERSIONS

GROUND X166

Z3

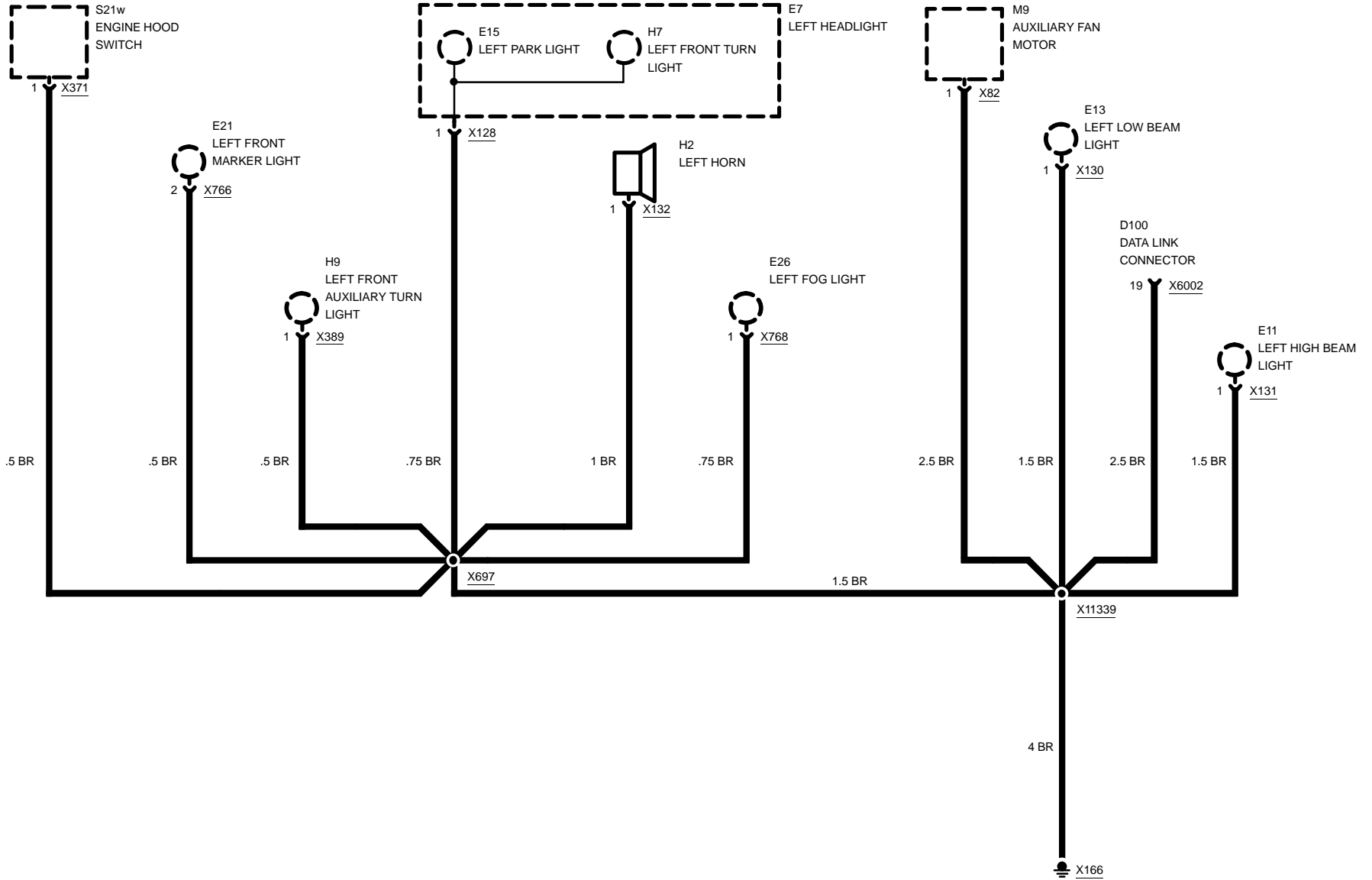

03/00

0670.4-03

1999



GROUND DISTRIBUTION

GROUNDS X170 AND X494

Z3

Z3 VERSIONS

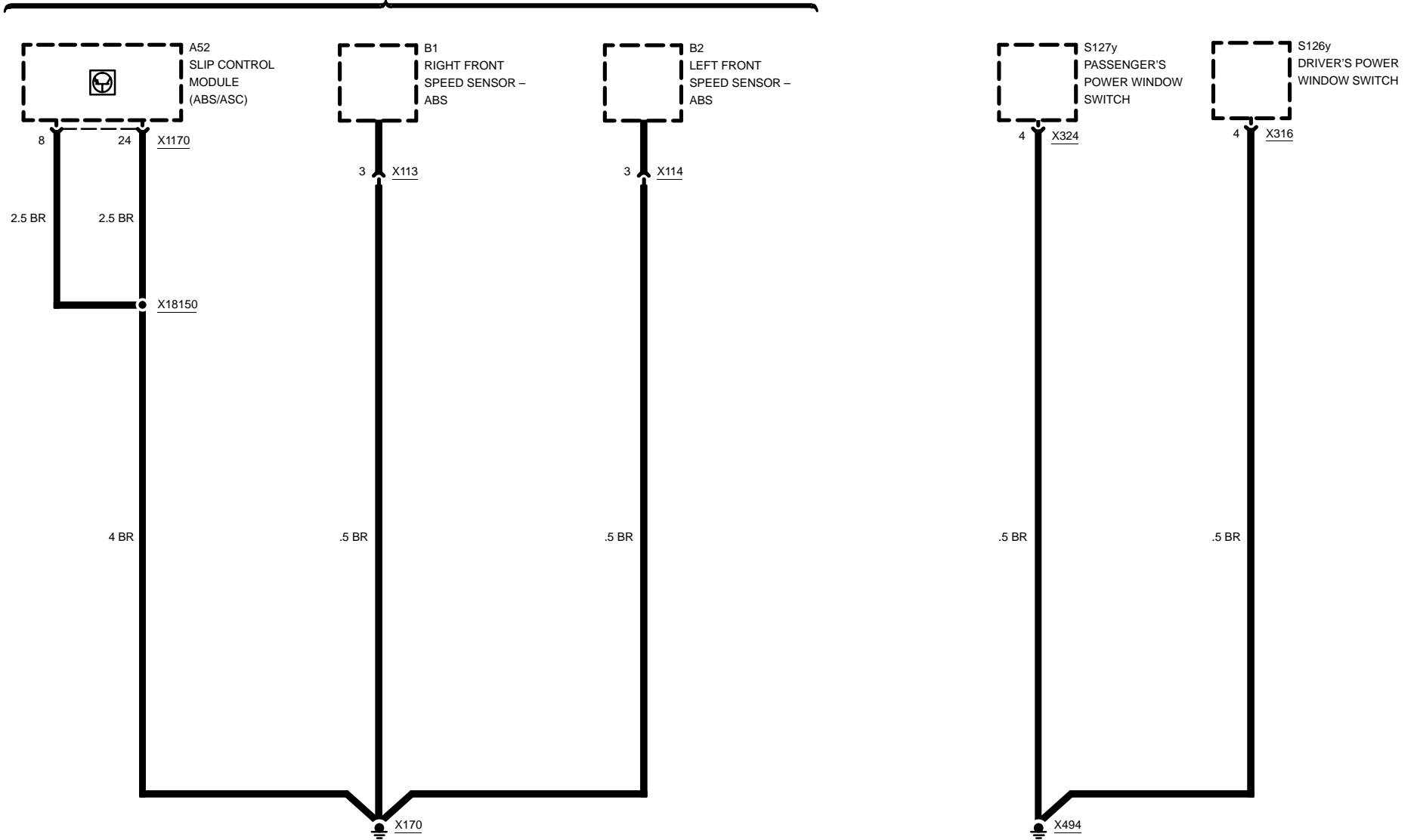

03/00

0670.4-04

1999



GROUND DISTRIBUTION

GROUNDS X1116, X1166, AND X1441

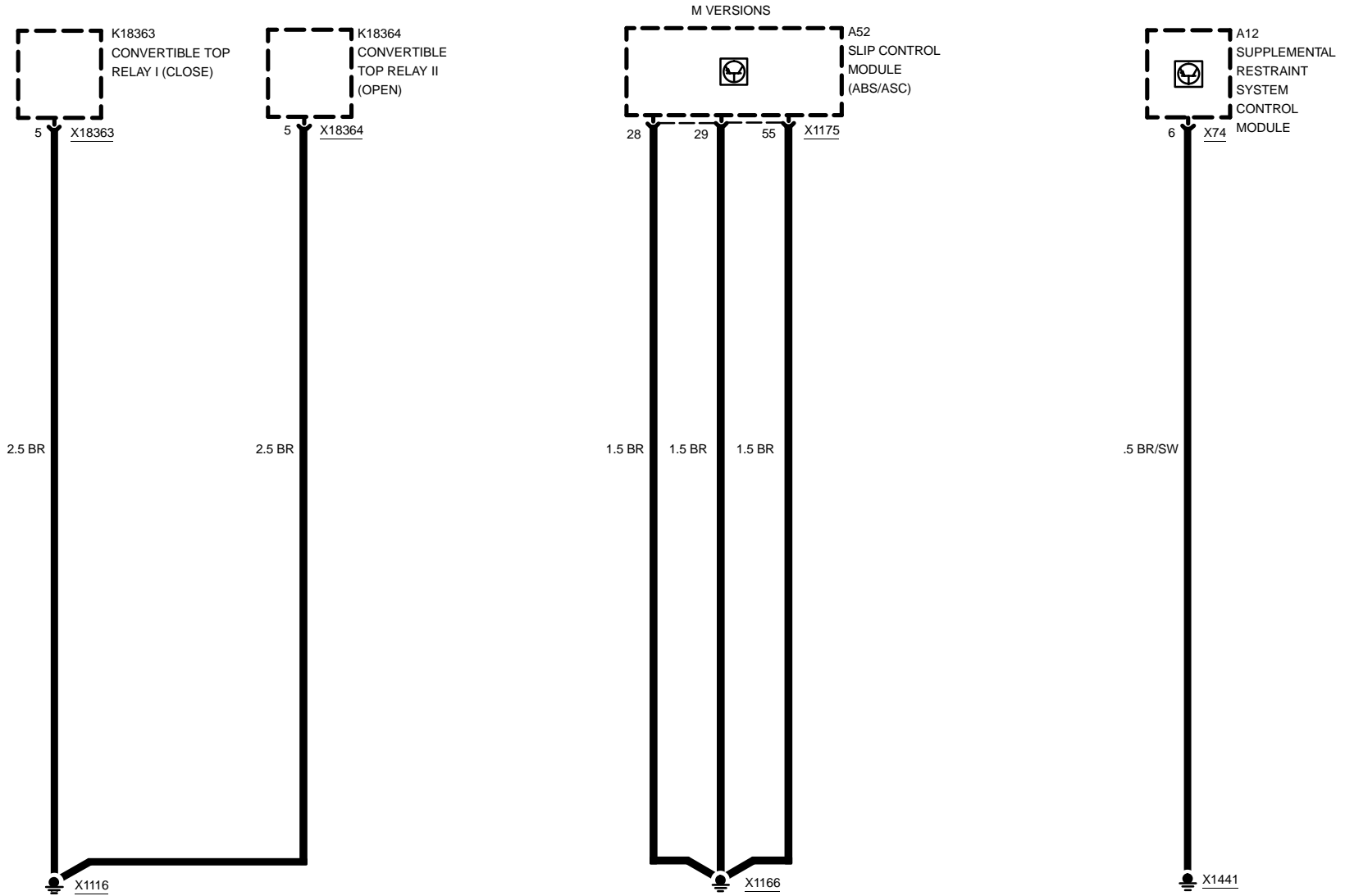

03/00

0670.4-05

1999



GROUND DISTRIBUTION

M VERSIONS

GROUND X6454

Z3

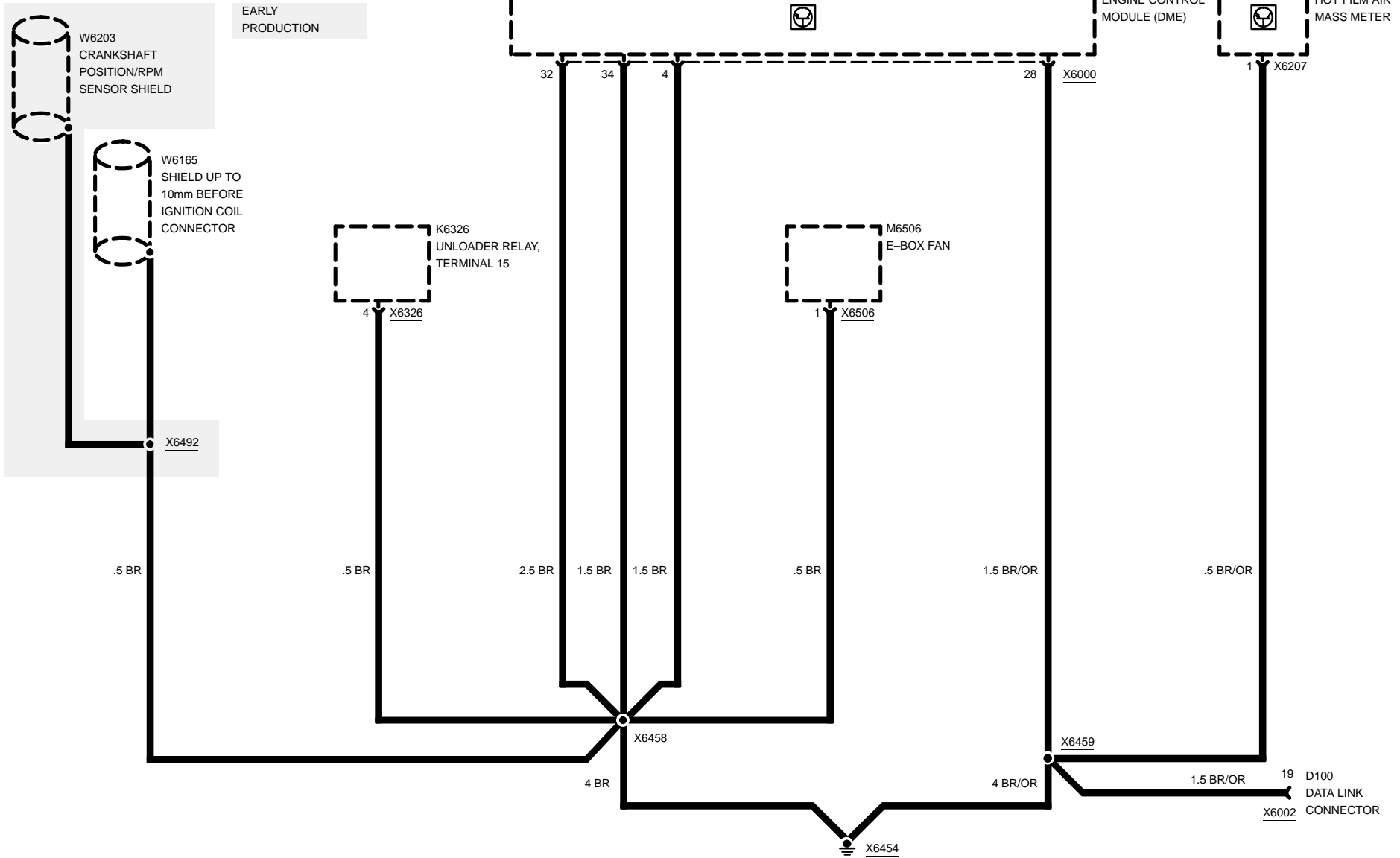

03/00

0670.4-06

1999



GROUND DISTRIBUTION

Z3 VERSIONS

GROUND X6454

Z3

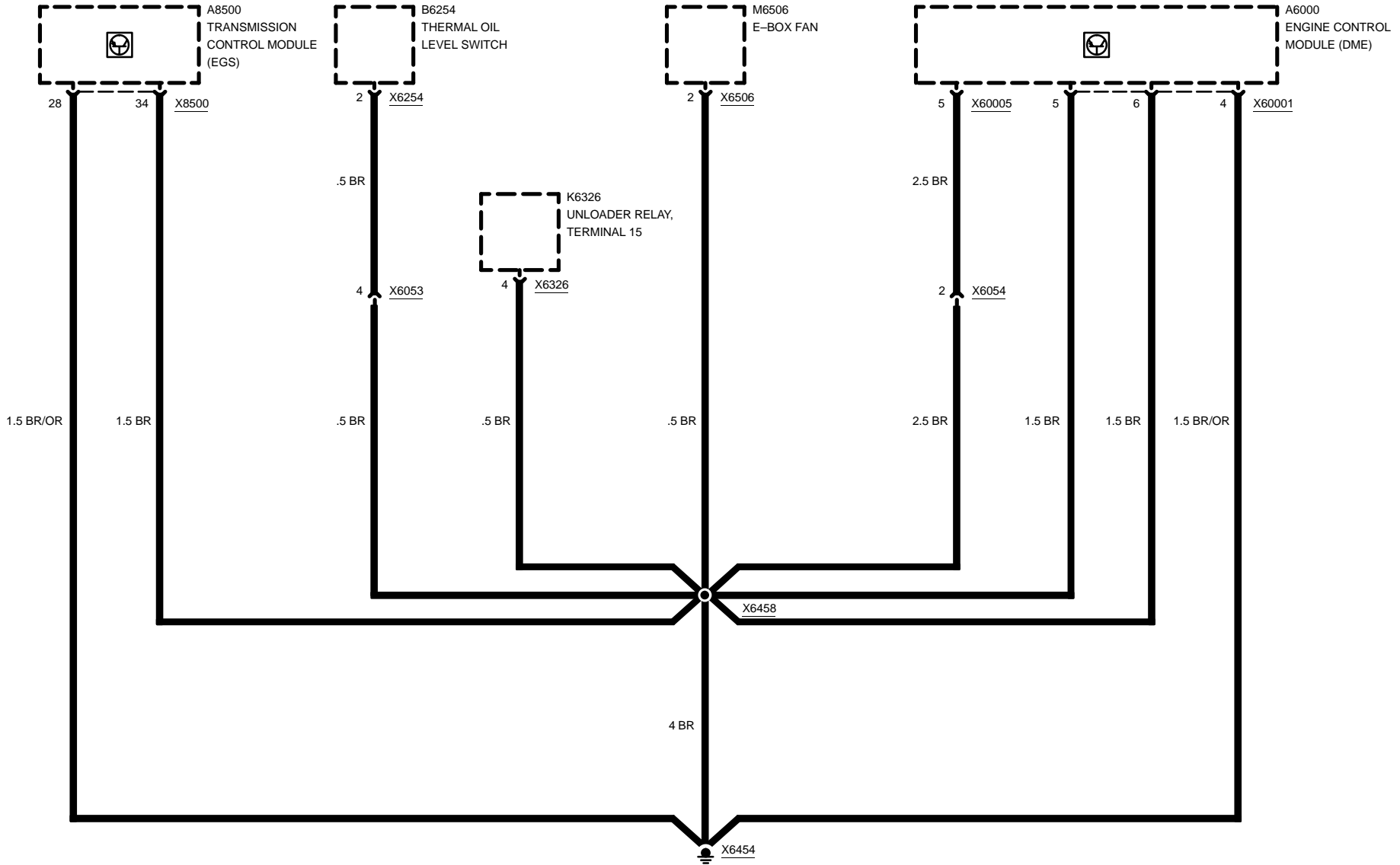

03/00

0670.4-07

1999



GROUND DISTRIBUTION

GROUNDS X6455 AND X6456

Z3

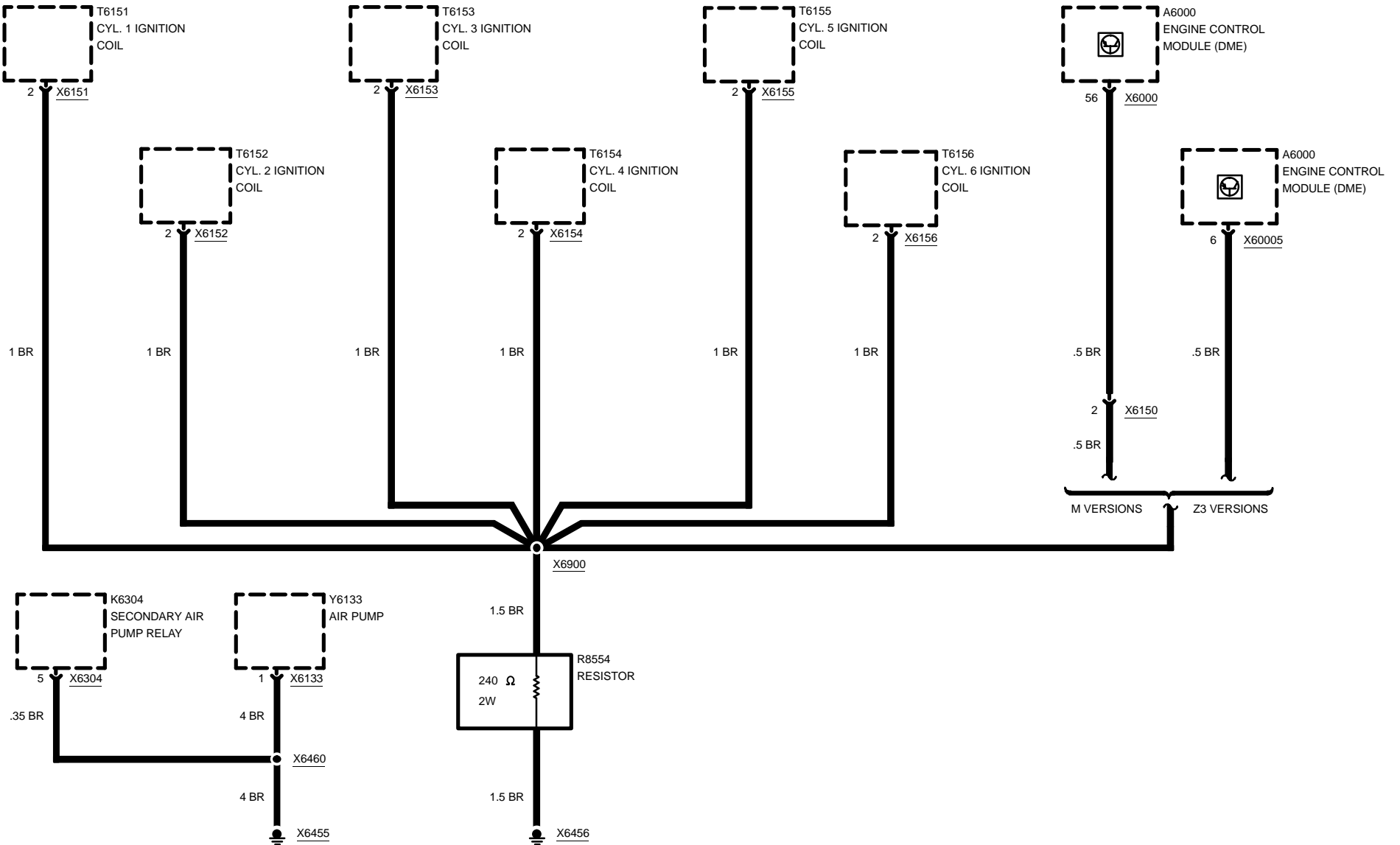

03/00

0670.4-08

1999



GROUND DISTRIBUTION

Z3 VERSIONS

GROUND X9633

Z3

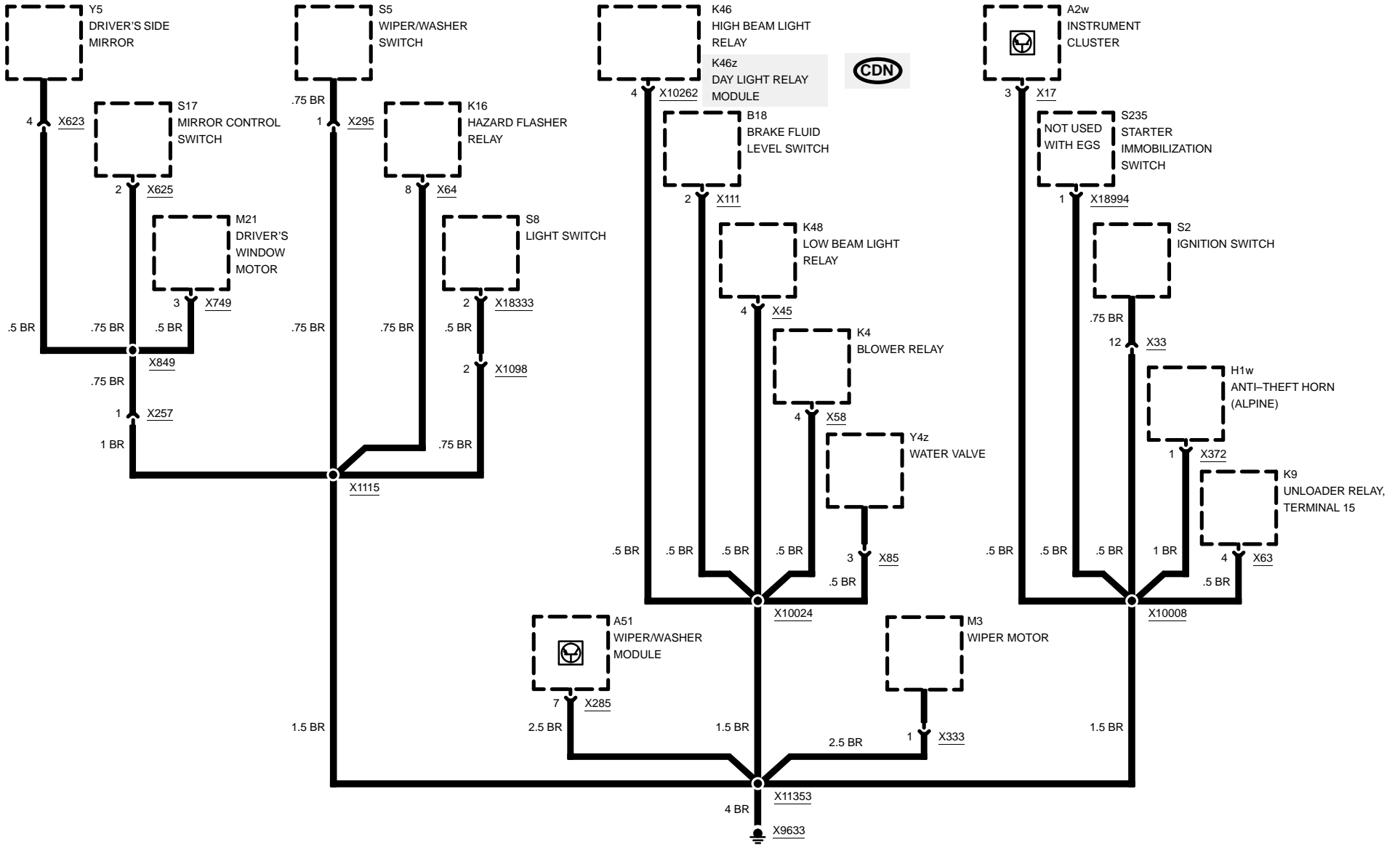

03/00

0670.4-09

1999



GROUND DISTRIBUTION

GROUND X9633

M VERSIONS

Z3

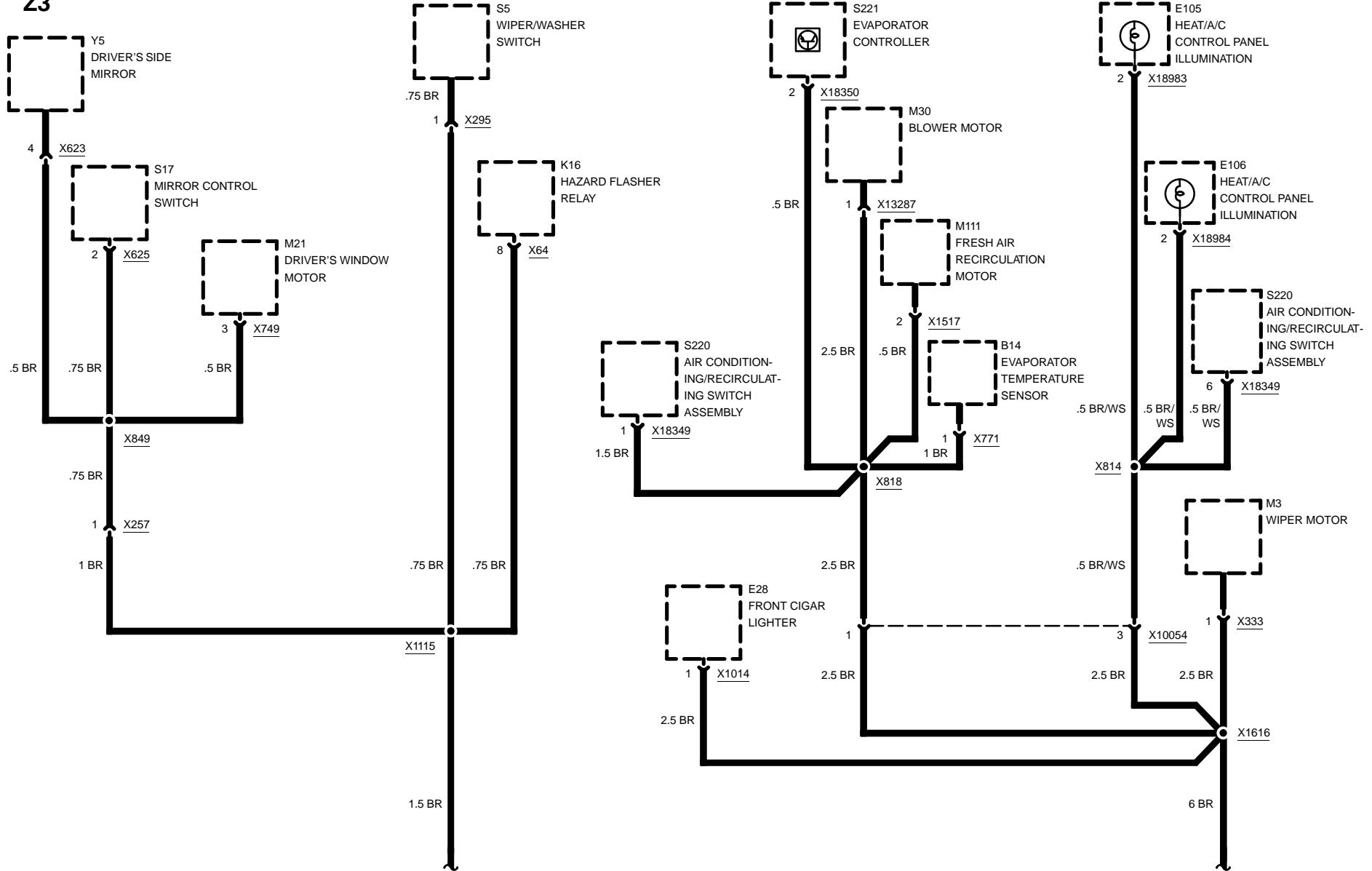

03/00

0670.4-10

1999

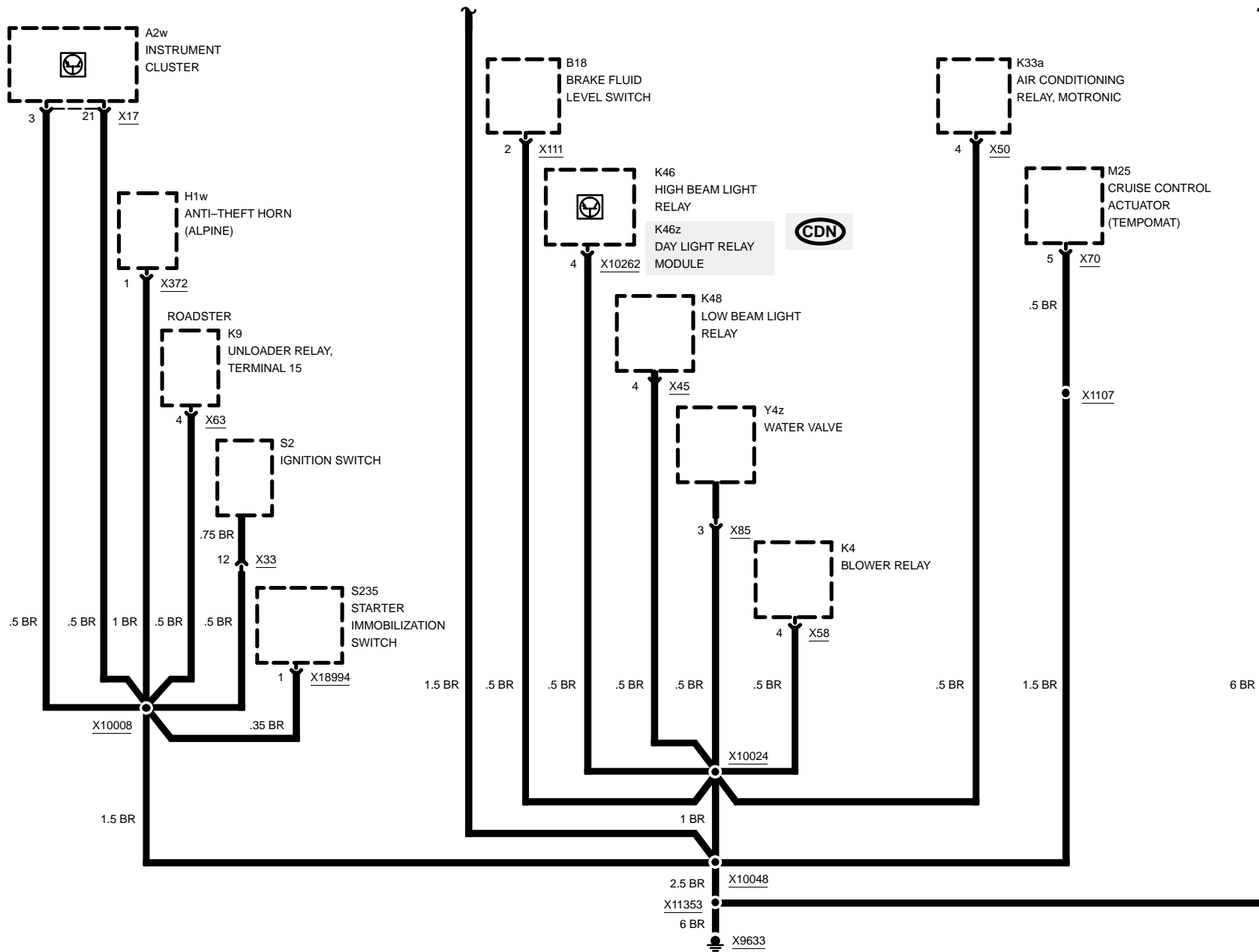



GROUND DISTRIBUTION

Z3 VERSIONS

GROUND X10010

Z3

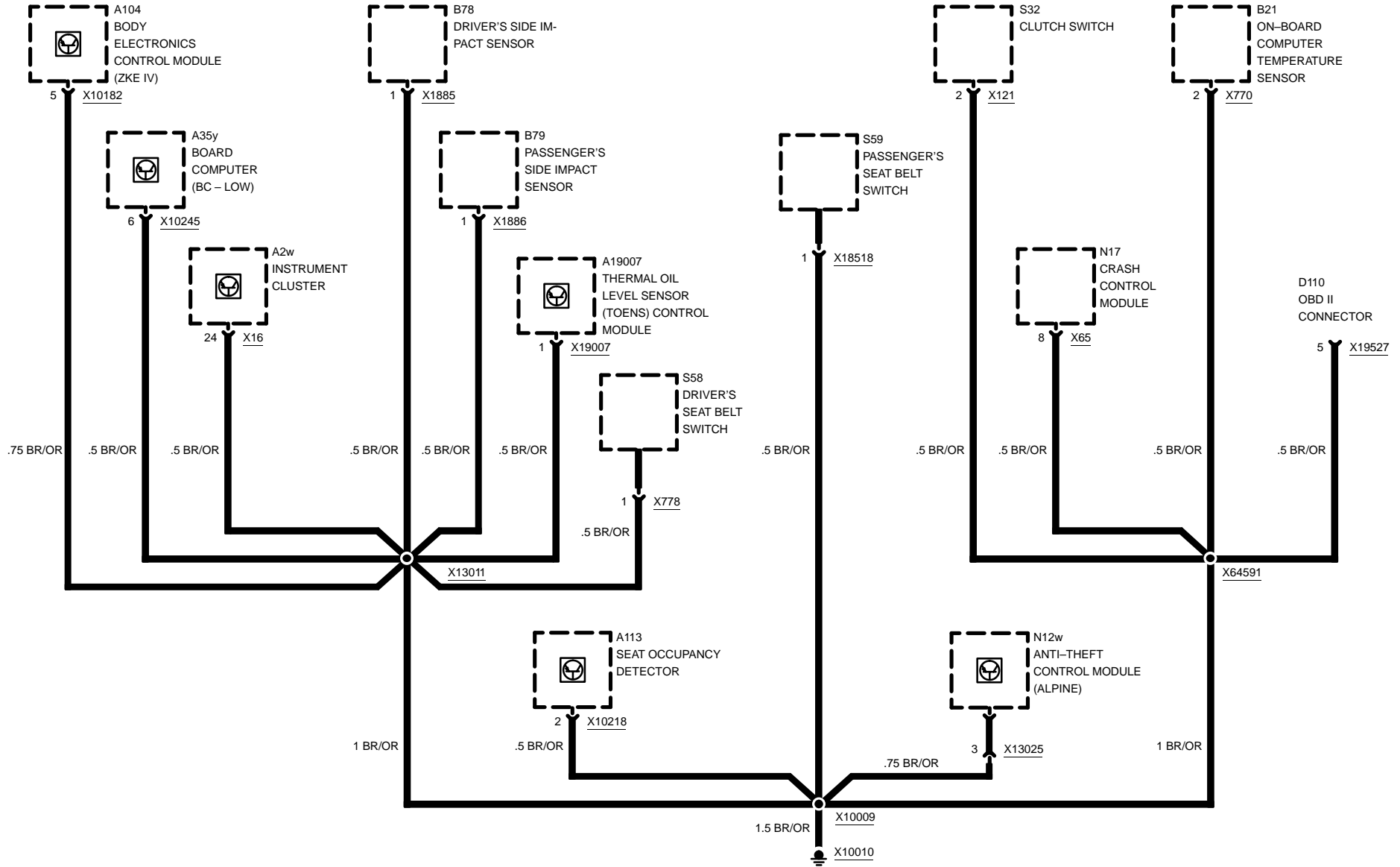

03/00

0670.4-12

1999



GROUND DISTRIBUTION

M VERSIONS

GROUND X10010

Z3

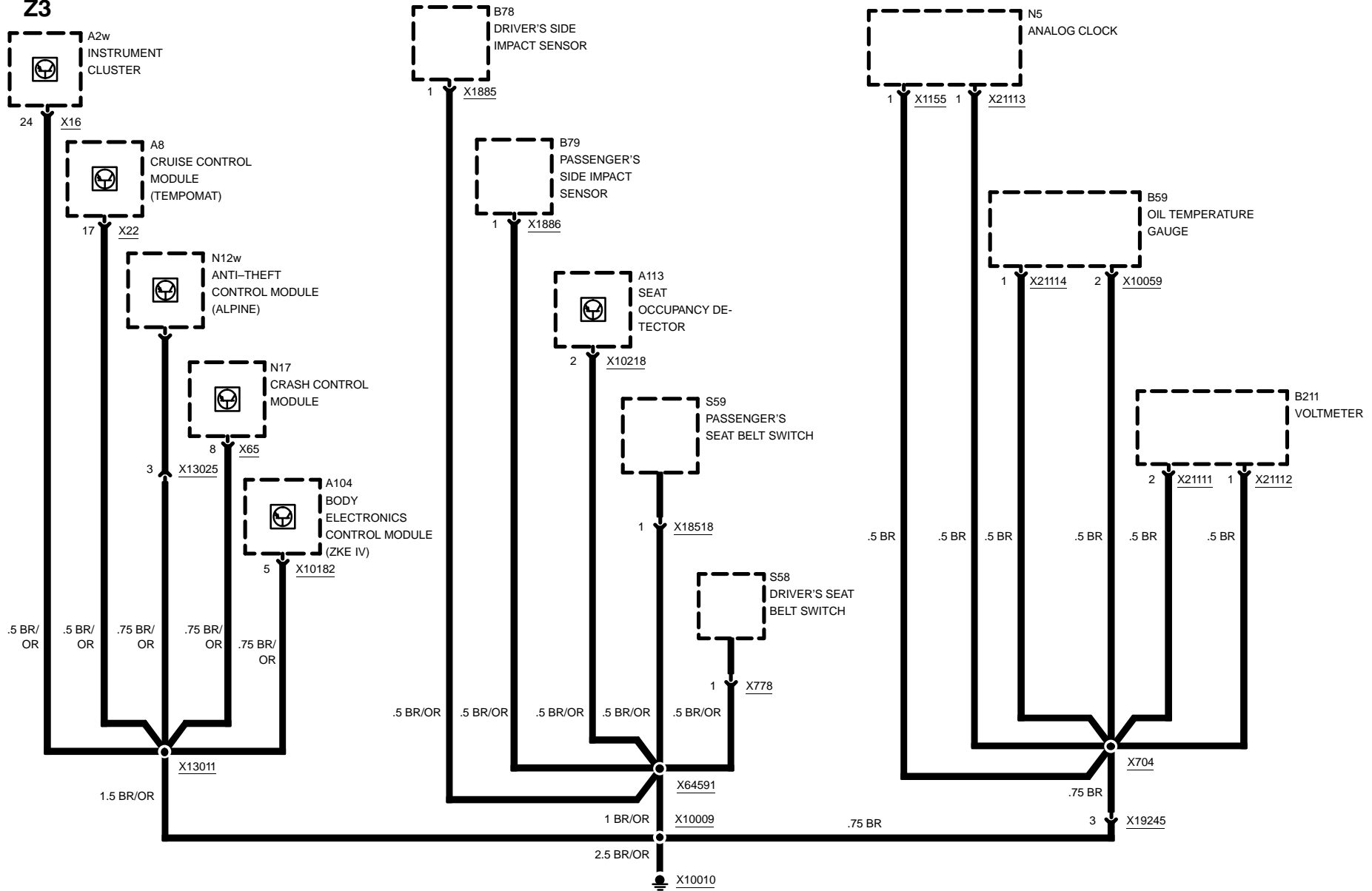

03/00

0670.4-13

1999



GROUND DISTRIBUTION

M VERSIONS

GROUND X13004

Z3

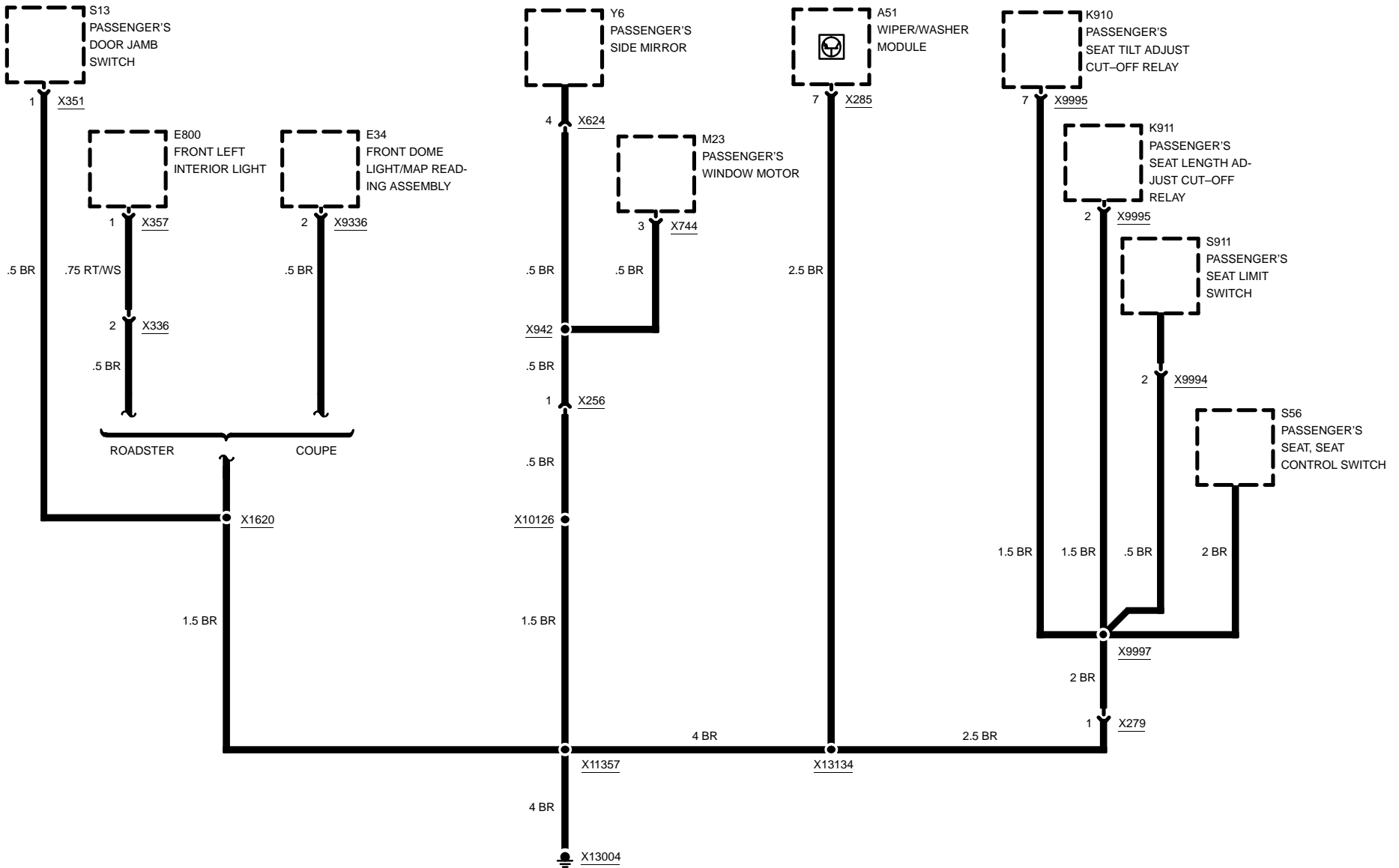

03/00

0670.4-14

1999



GROUND DISTRIBUTION

Z3 VERSIONS

GROUND X13004

Z3

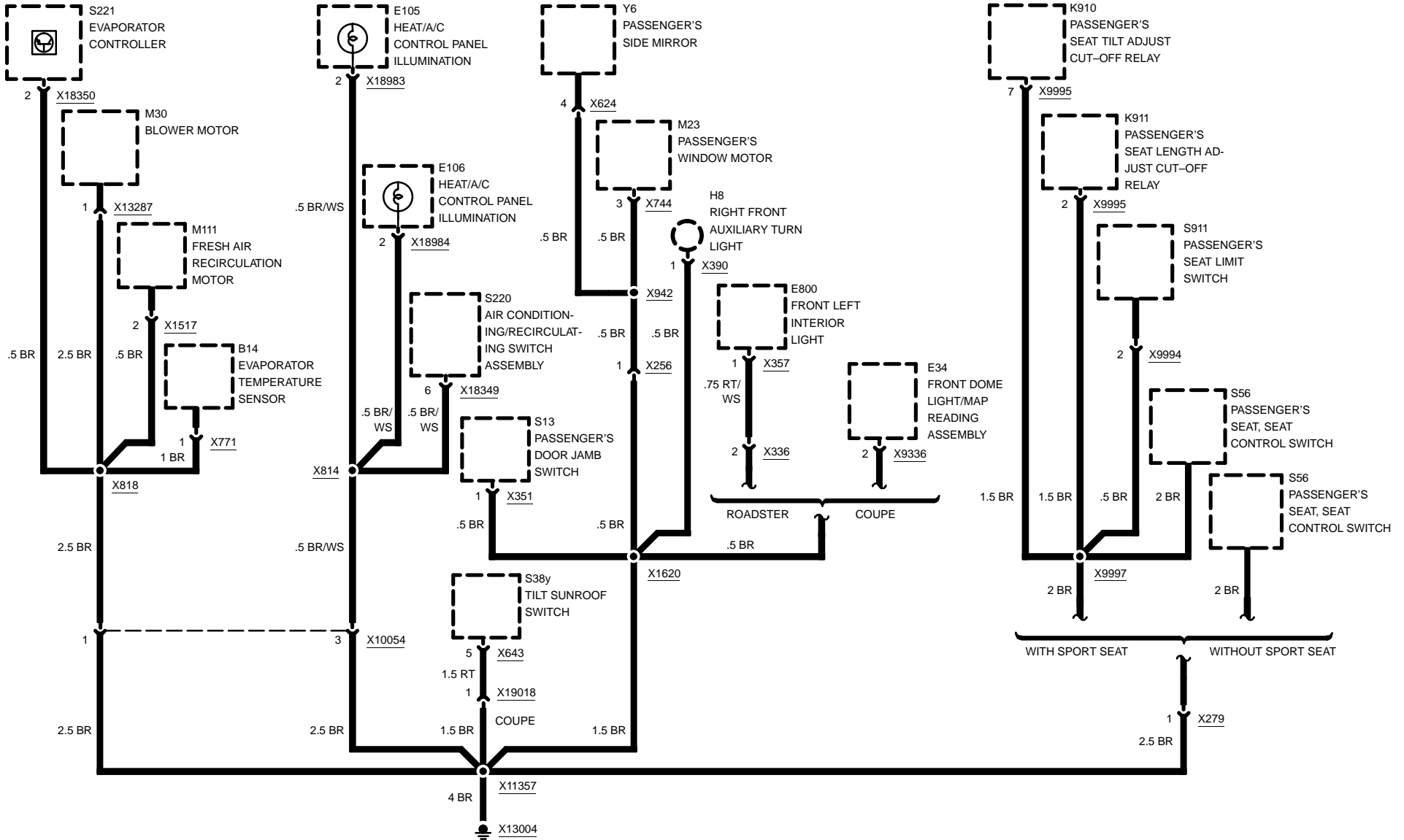

03/00

0670.4-15

1999



Z3

GROUND DISTRIBUTION

GROUND X13006

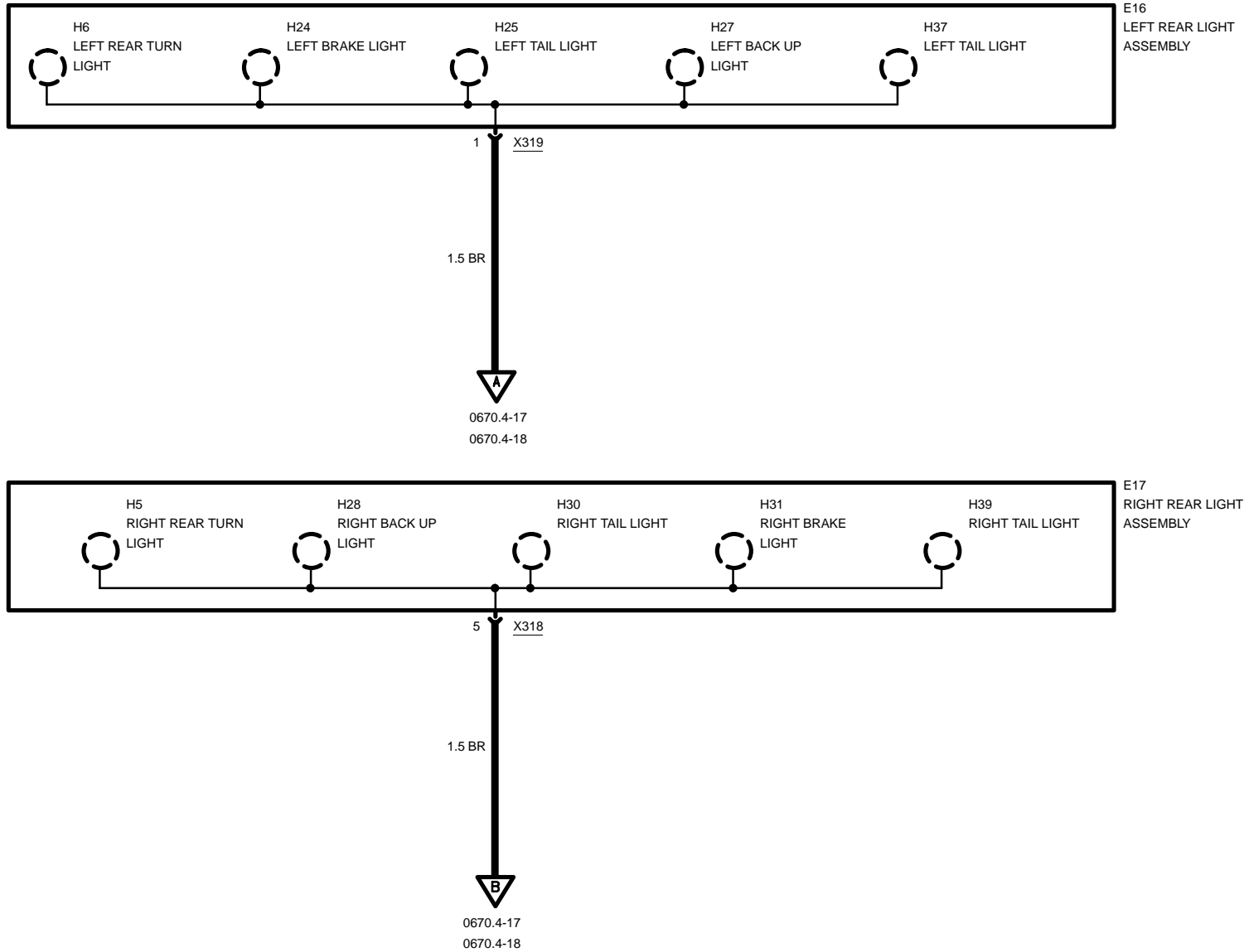

03/00

0670.4-16

1999



GROUND DISTRIBUTION

GROUND X13006

M VERSIONS

Z3

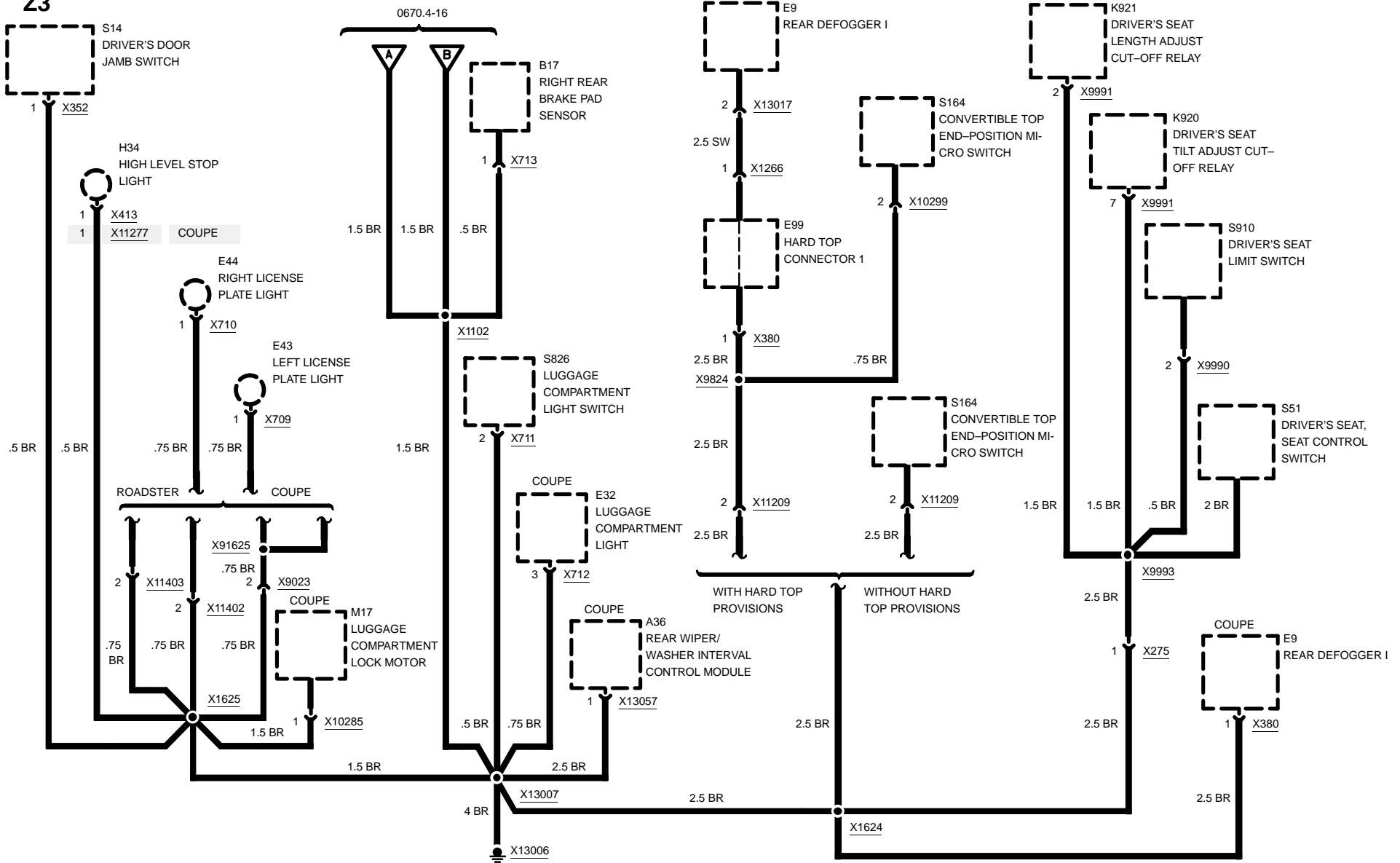

03/00

0670.4-17

1999



GROUND DISTRIBUTION

Z3 VERSIONS

GROUND X13006

Z3

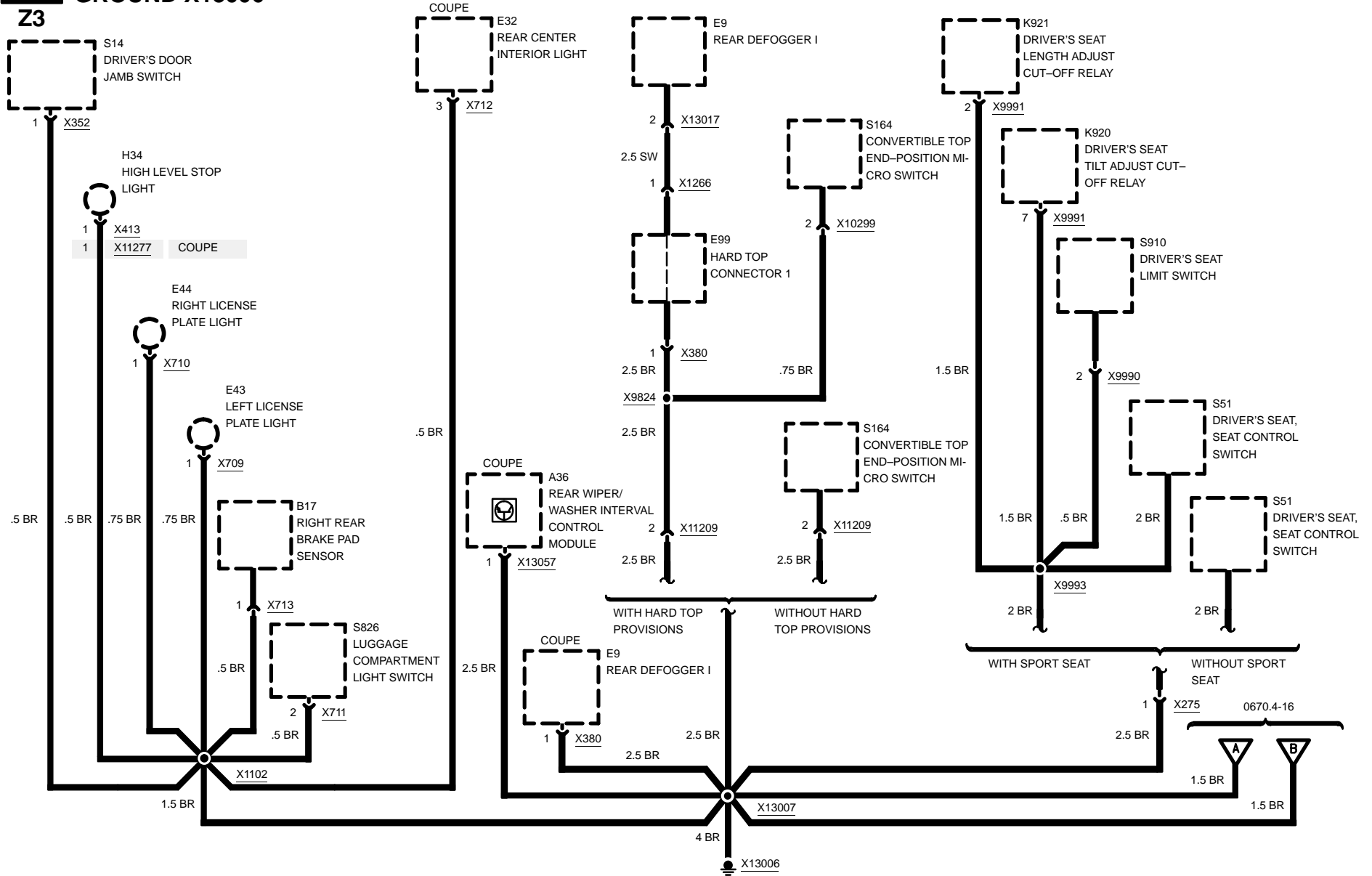

03/00

0670.4-18

1999



GROUND DISTRIBUTION

GROUNDS X13016 AND X13032

Z3

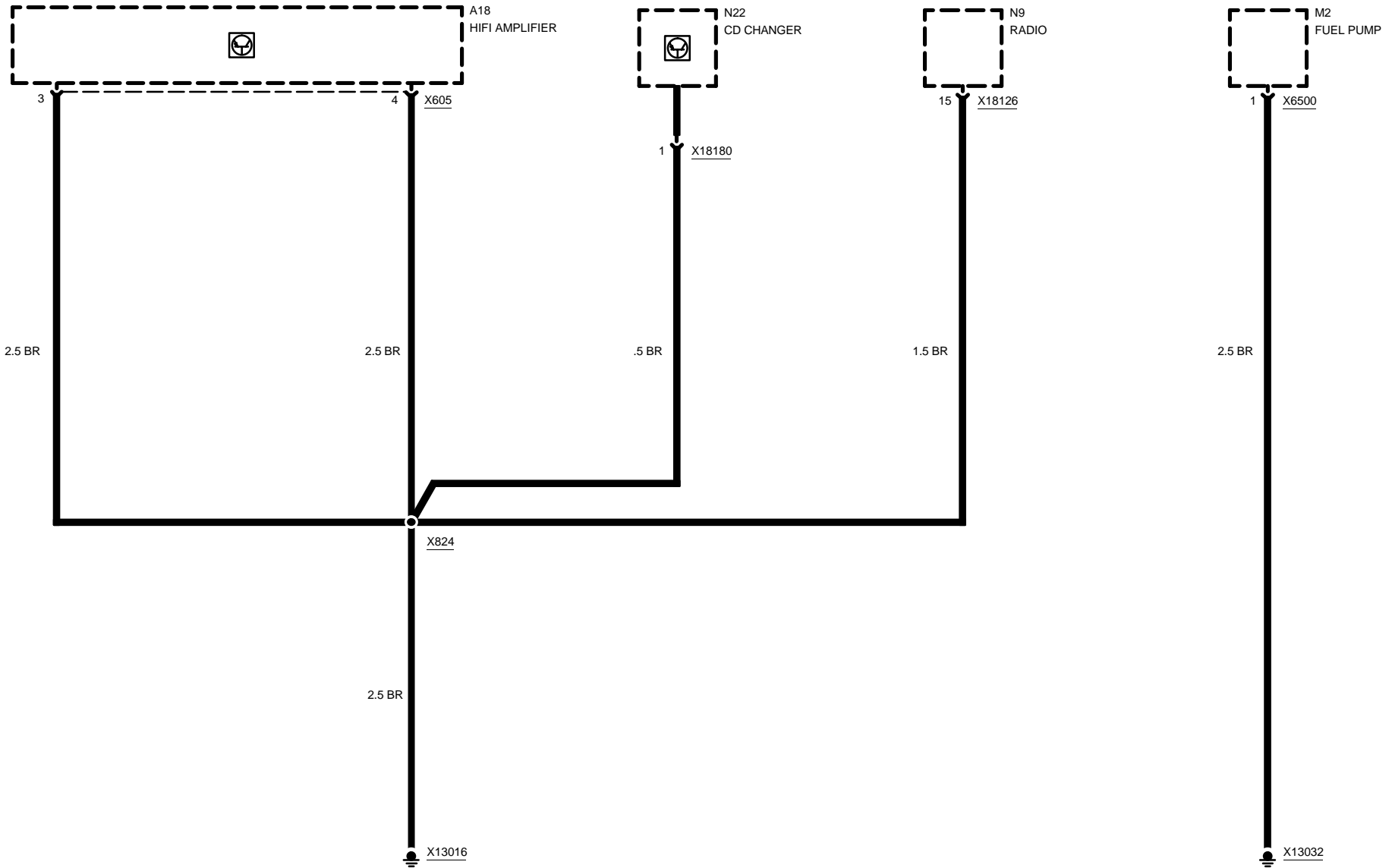

03/00

0670.4-19

1999



GROUND DISTRIBUTION

GROUND X18170

Z3 VERSIONS

Z3

TELEPHONE CONNECTOR

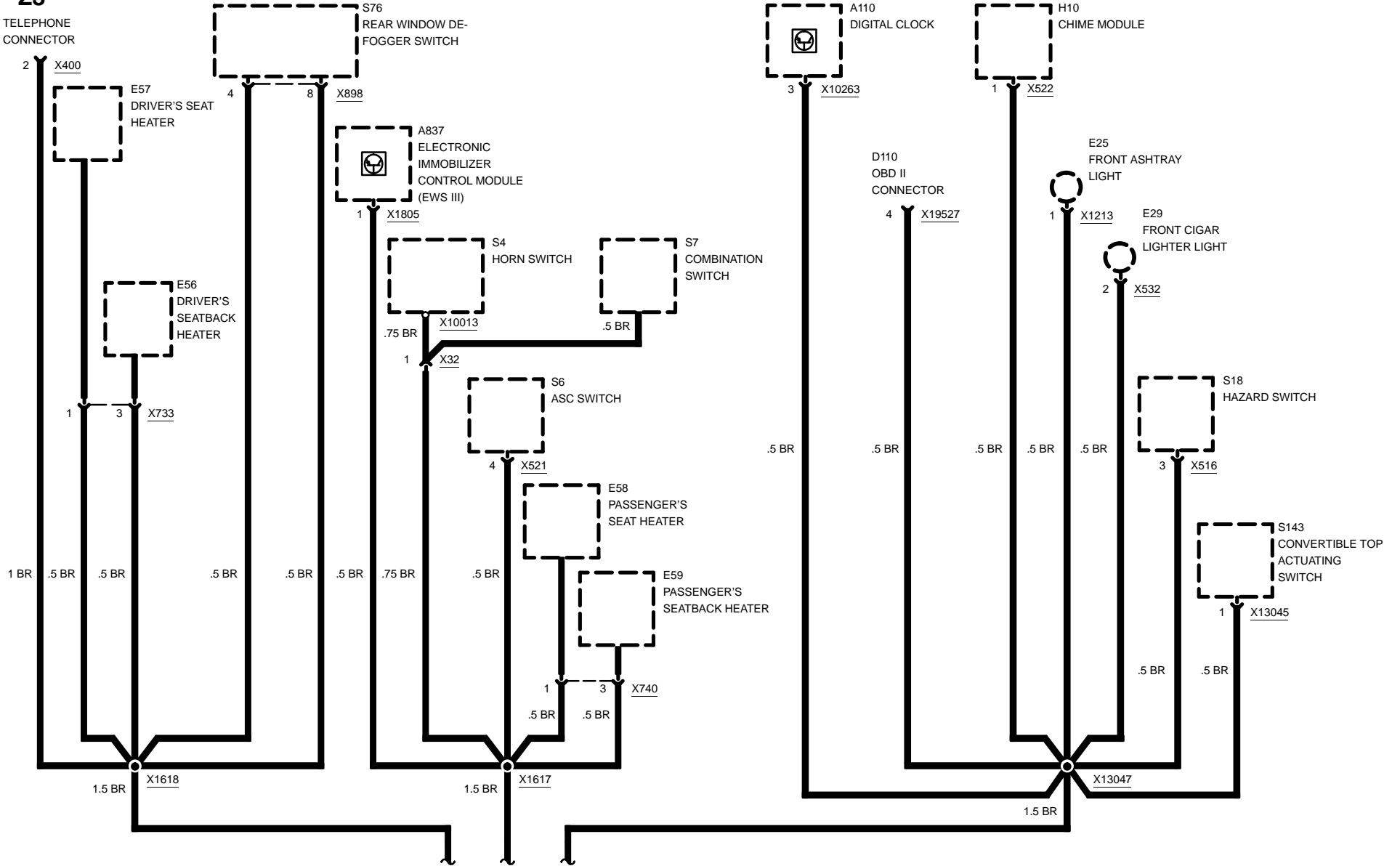

03/00

0670.4-20

1999

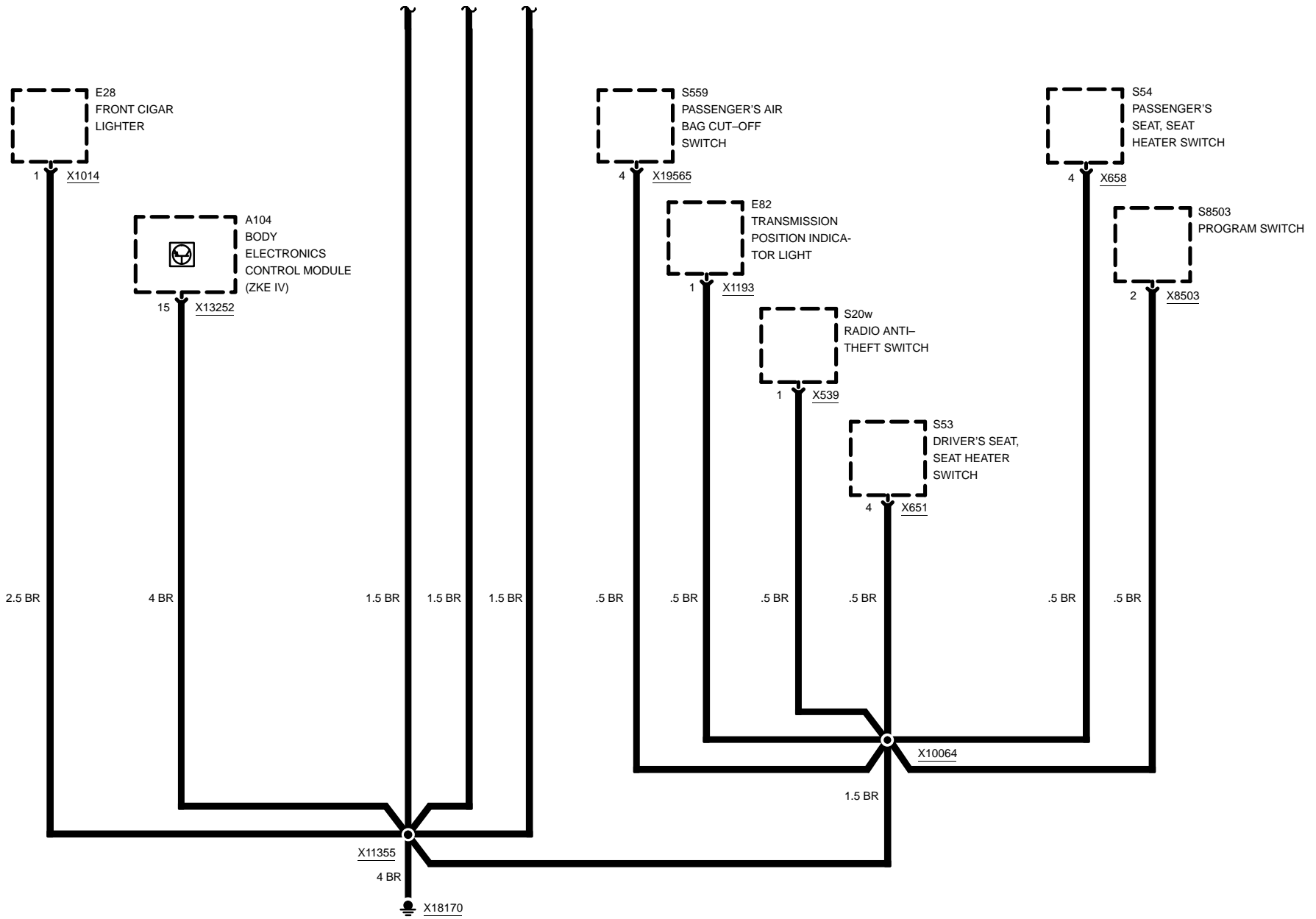



GROUND DISTRIBUTION

GROUND X18170

M VERSIONS

Z3

TELEPHONE CONNECTOR

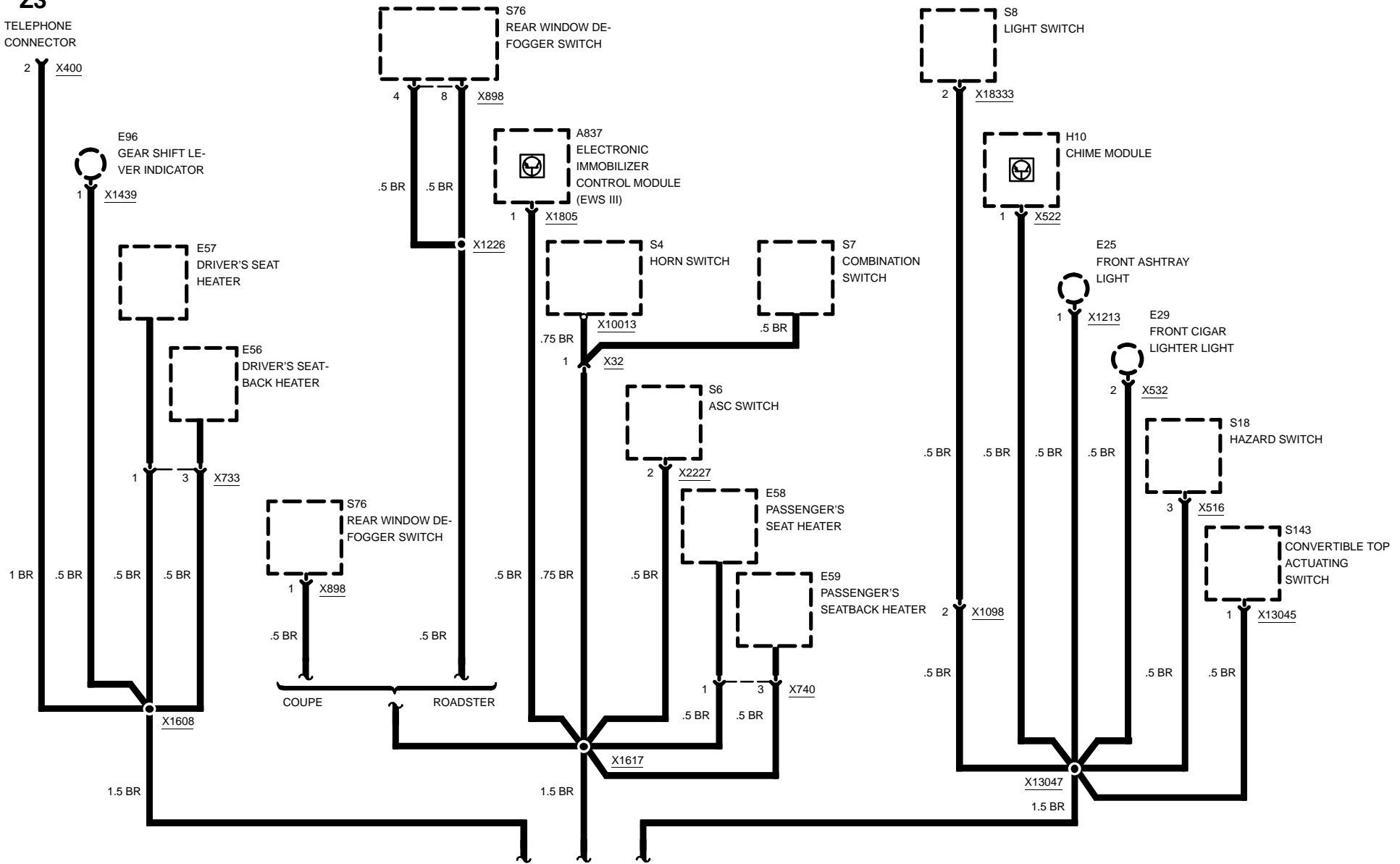

03/00

0670.4-22

1999

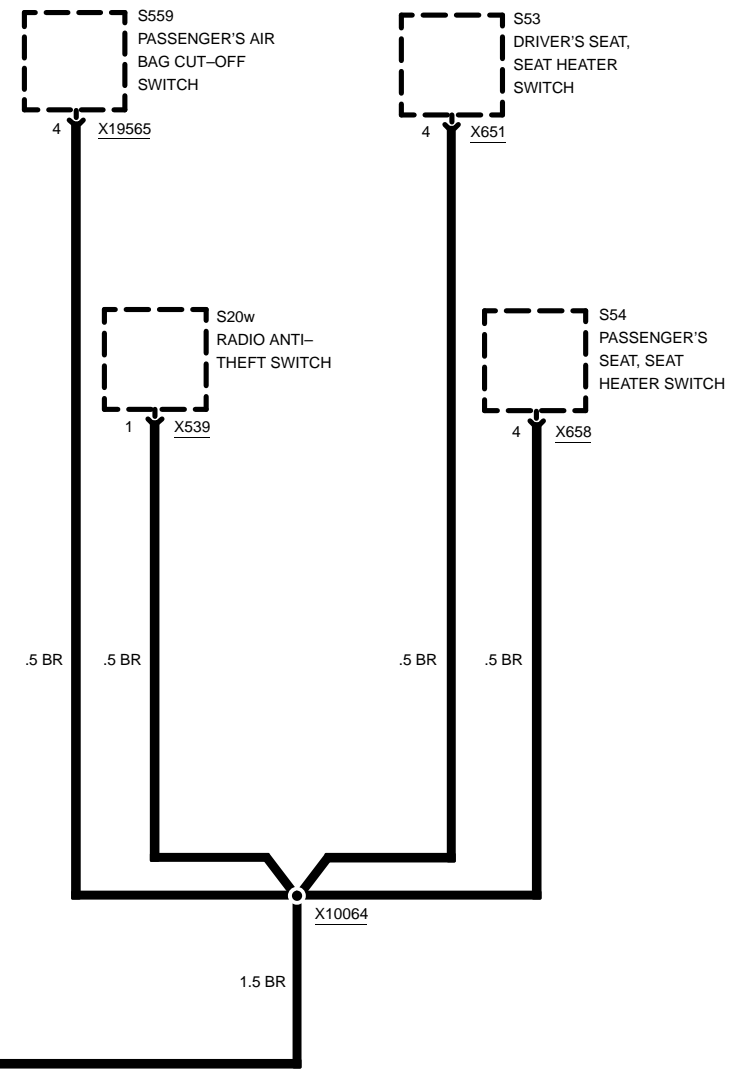
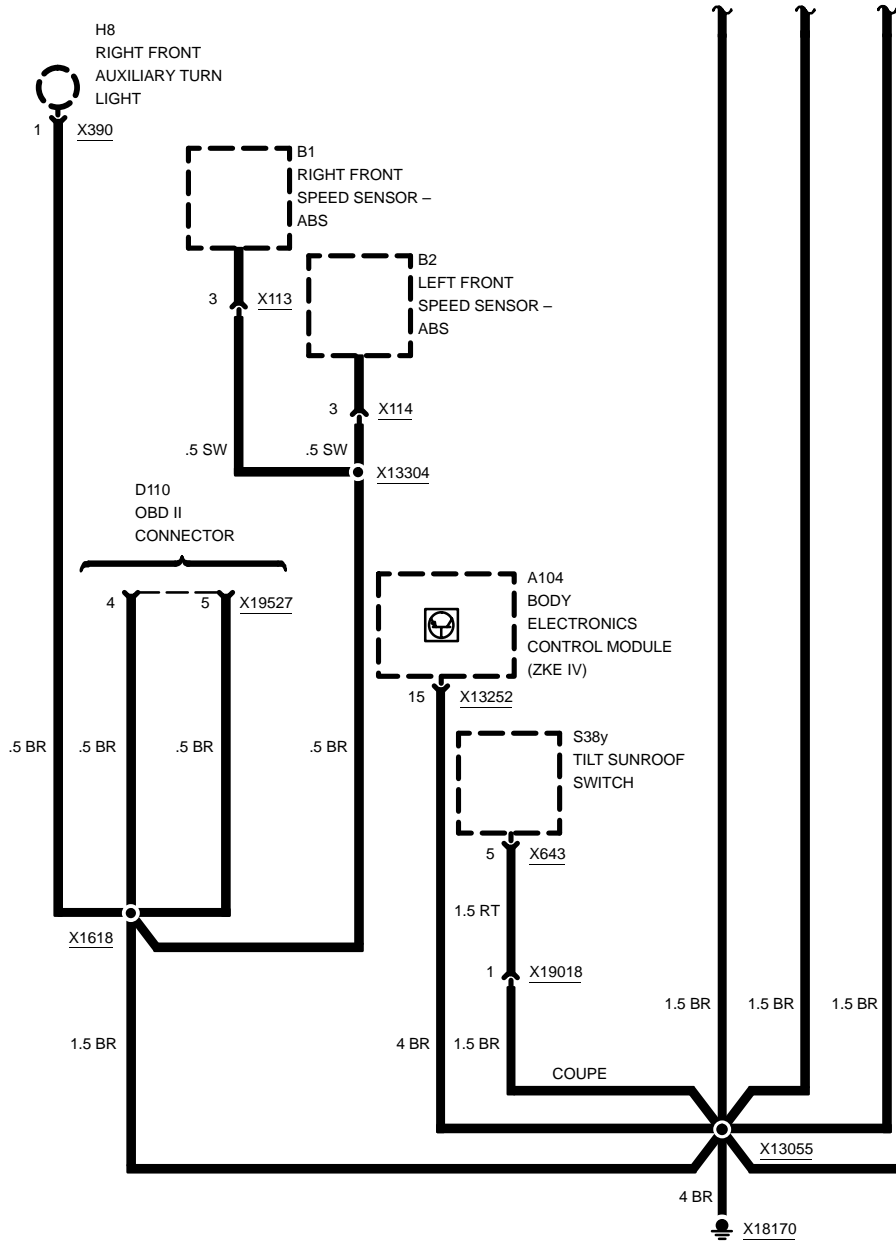



0670.5 DATA LINK BLOCK DIAGRAM

Z3

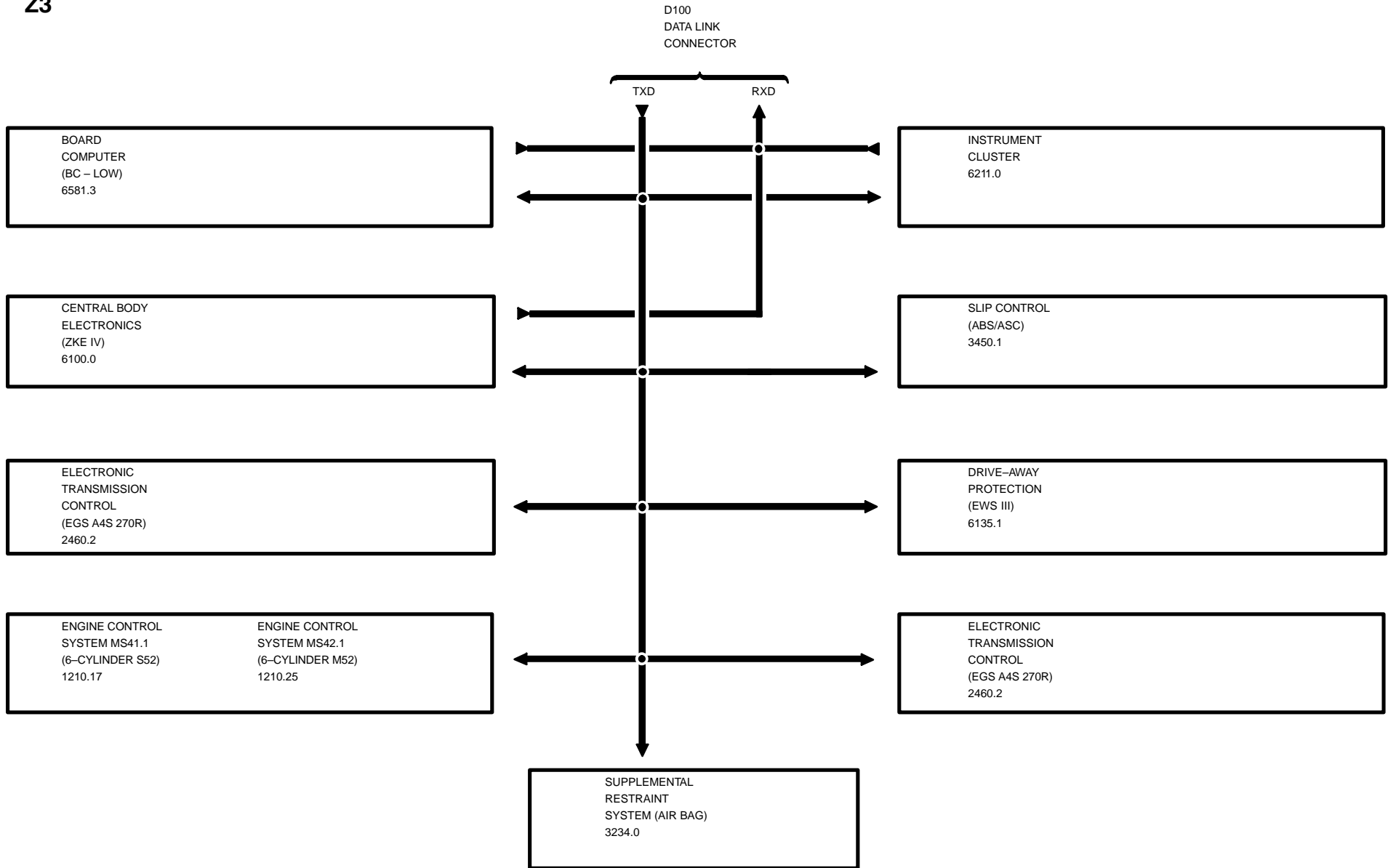

03/00

0670.5-00

1999



DATA LINK RXD AND TXD

Z3 VERSIONS

Z3

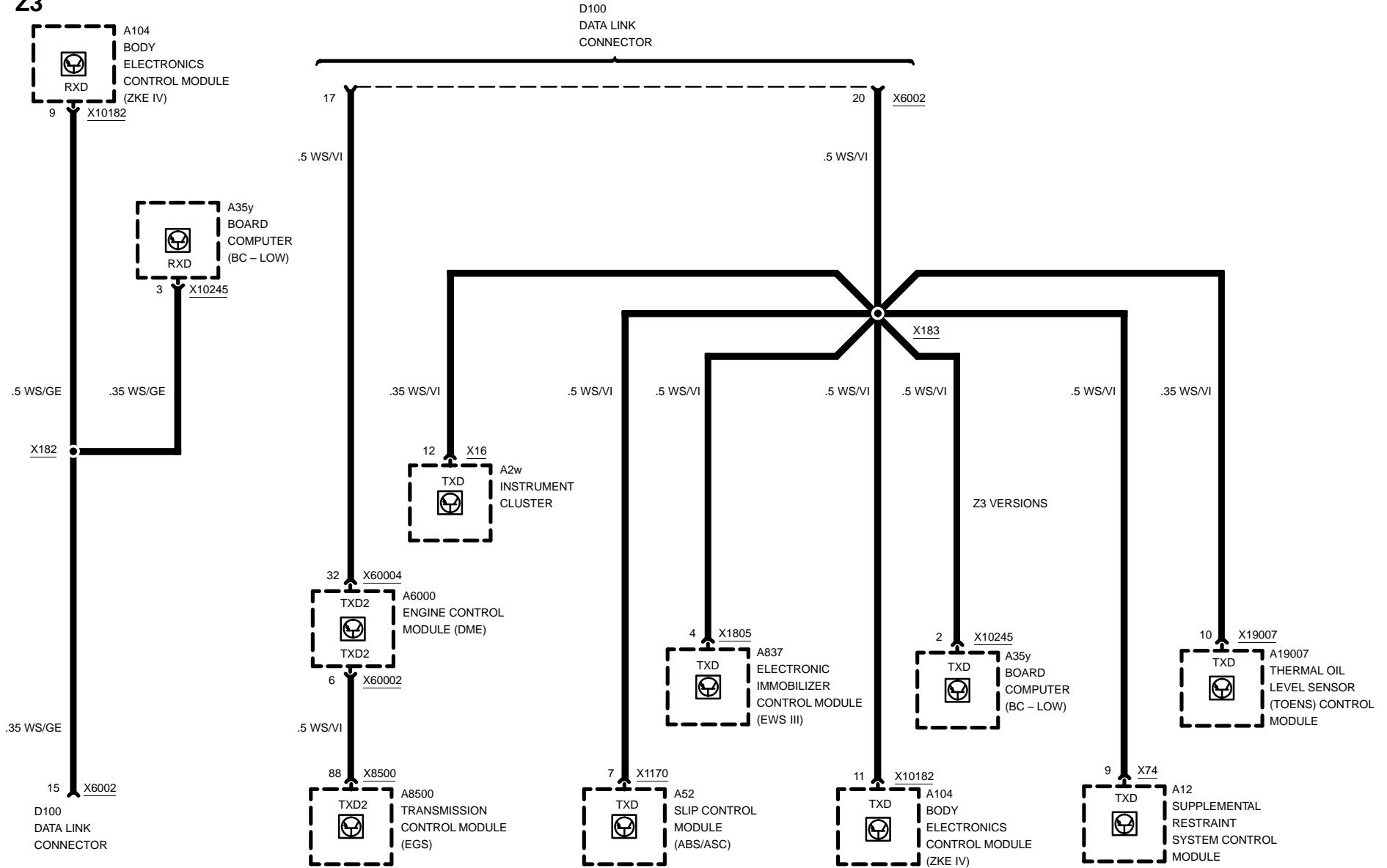

03/00

0670.5-01

1999



DATA LINK

Z3 VERSIONS

DATA LINK CONNECTOR, PINS 1, 7, 14, AND 16

Z3

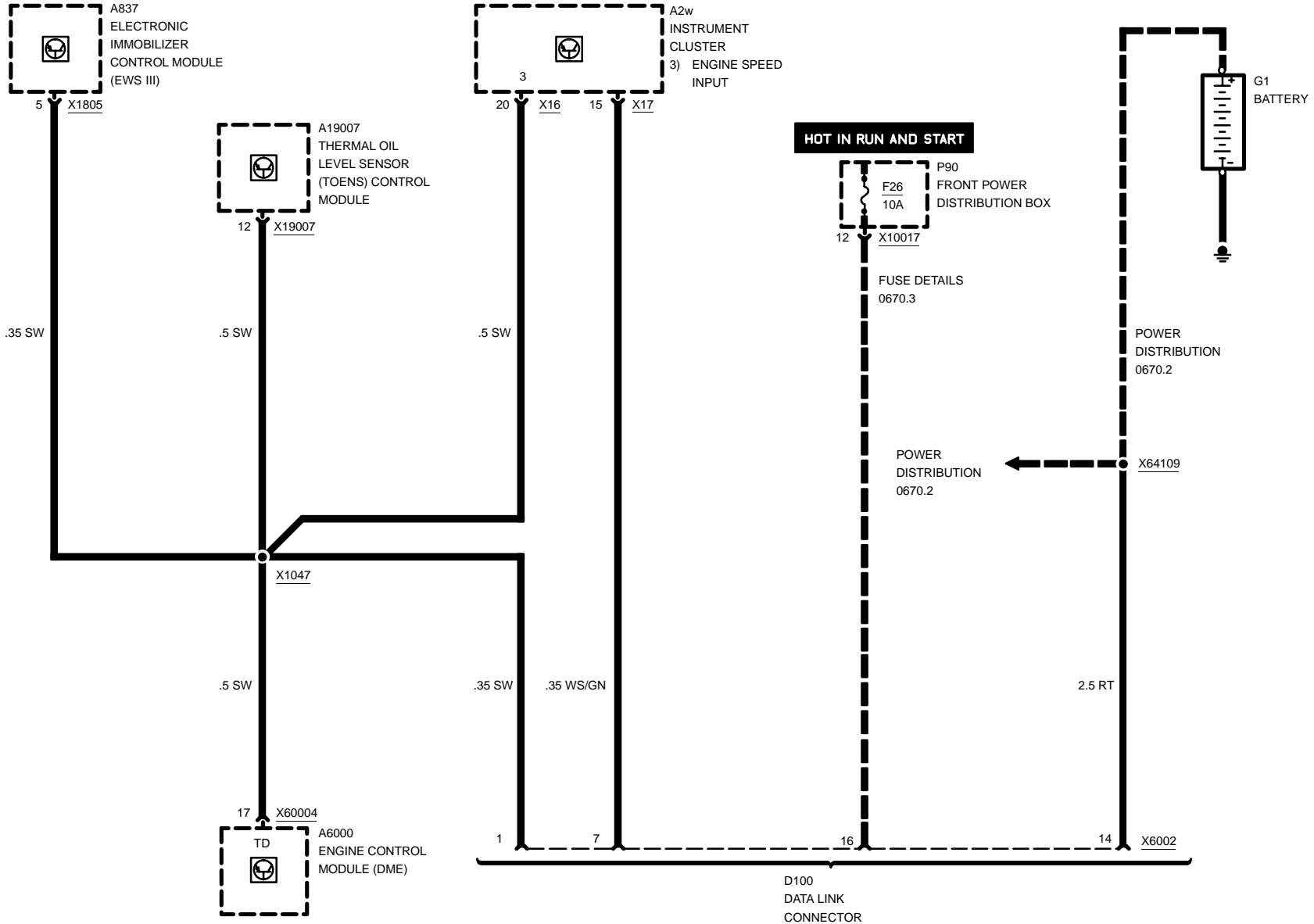

03/00

0670.5-02

1999



DATA LINK

Z3 VERSIONS

DATA LINK CONNECTOR, PINS 2 AND 19, AND OBD II CONNECTOR

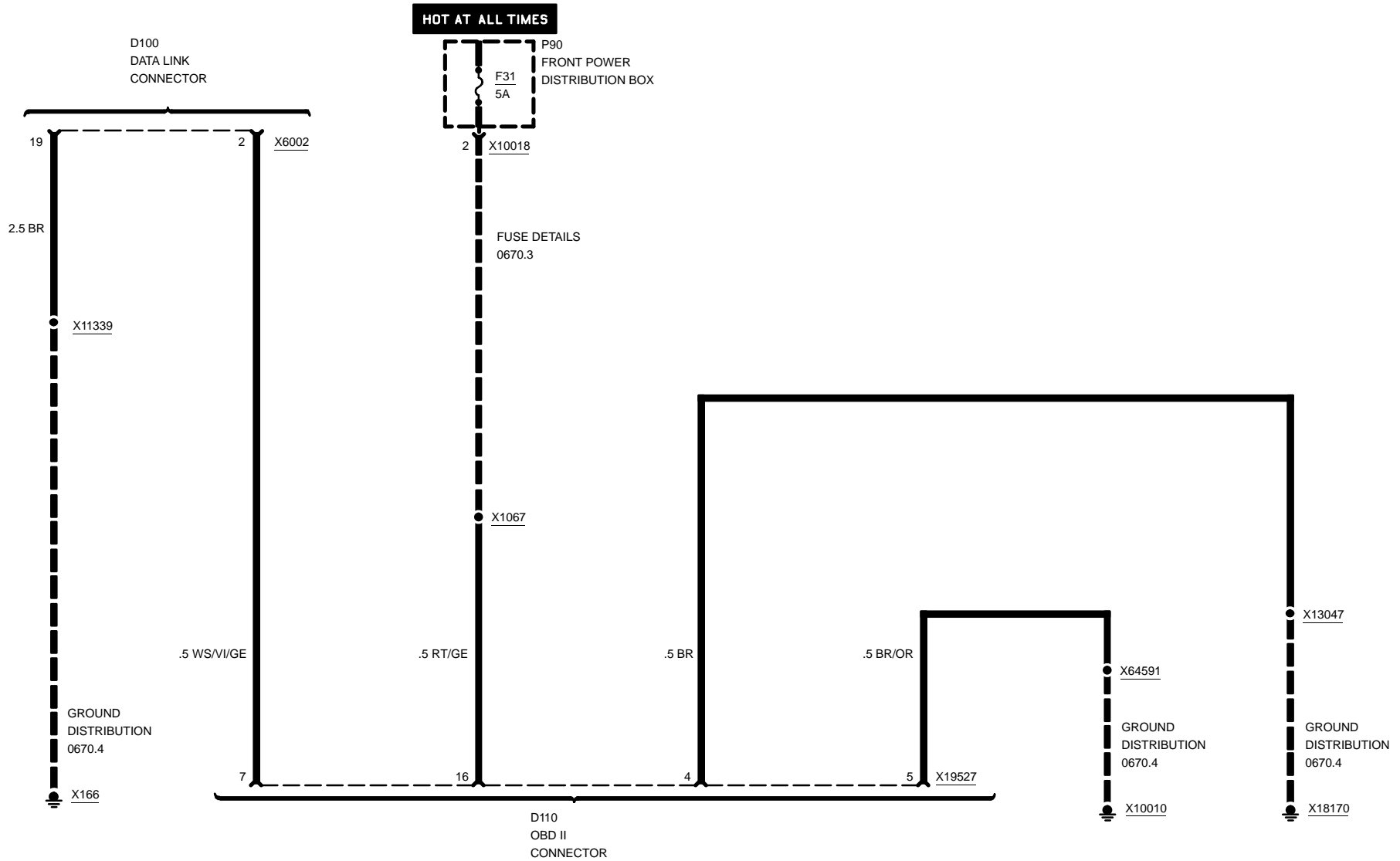

03/00

0670.5-03

1999



DATA LINK TXD AND RXD

M VERSIONS

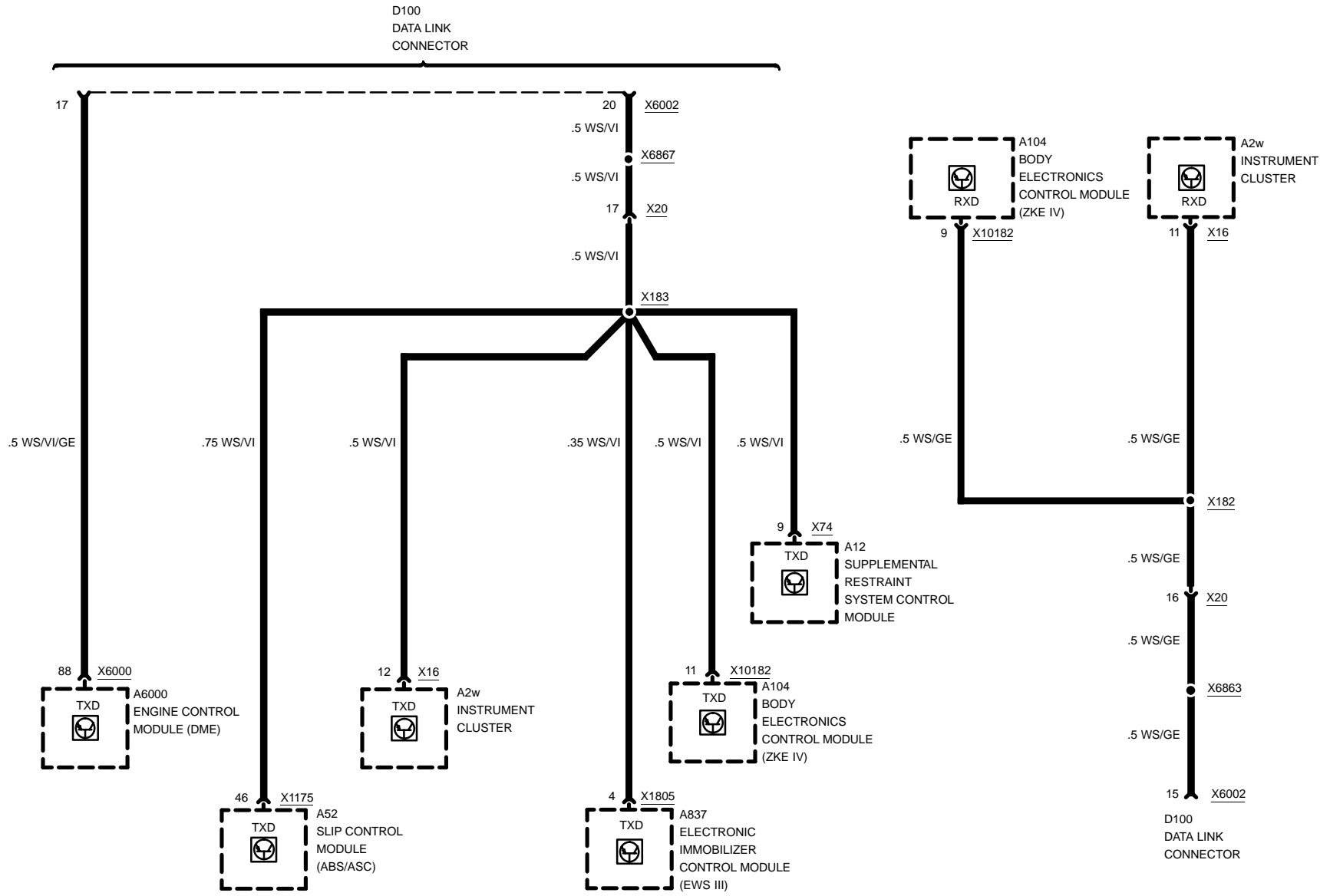

03/00 0670.5-04 1999



DATA LINK

M VERSIONS

DATA LINK CONNECTOR, PINS 1, 7, 16, 4, 12, AND 14

Z3

HOT IN RUN AND START

HOT IN ACCY, RUN AND START

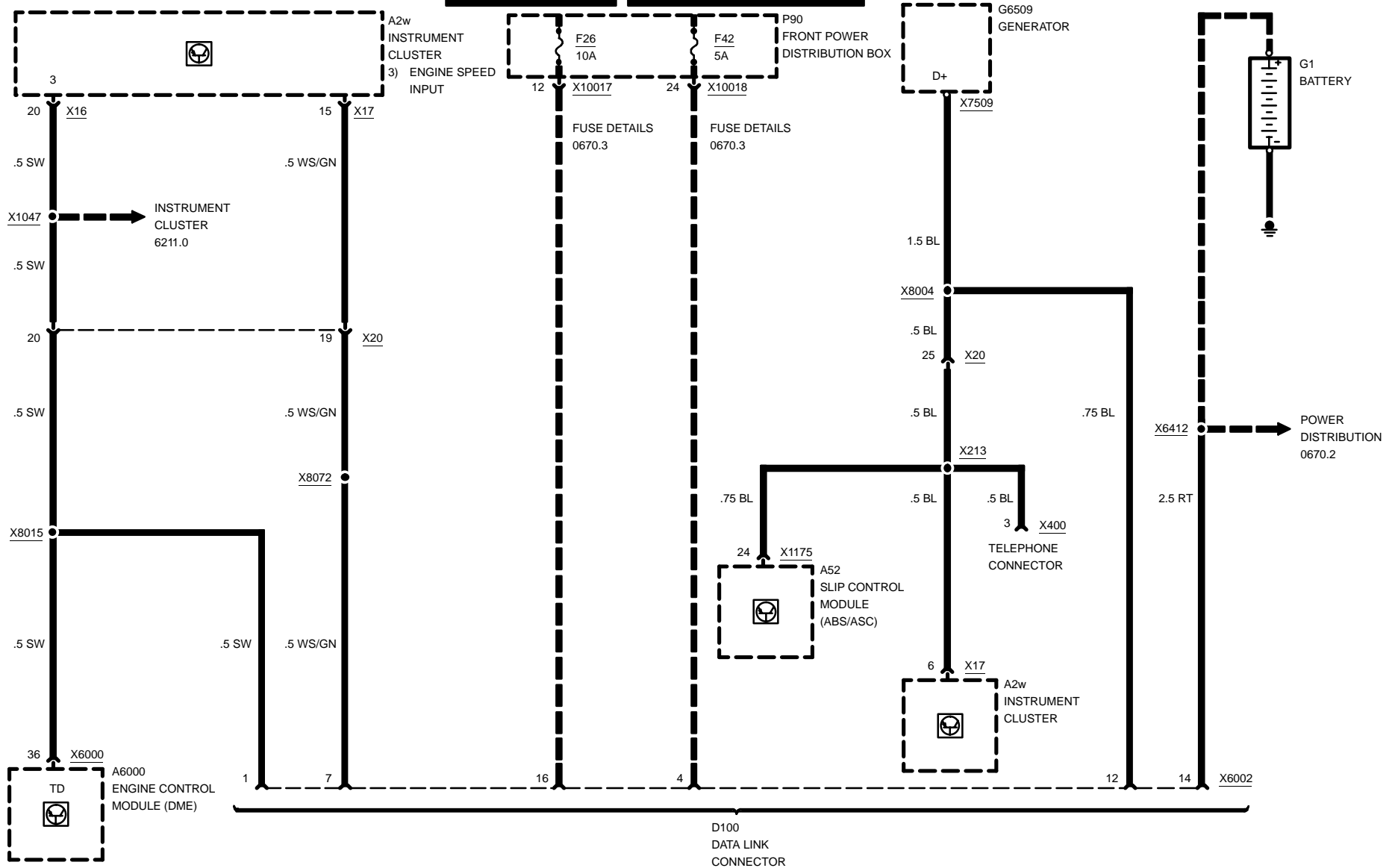

03/00

0670.5-05

1999



DATA LINK

M VERSIONS

DATA LINK CONNECTOR, PINS 19, 18, 2, AND OBD II CONNECTOR

Z3

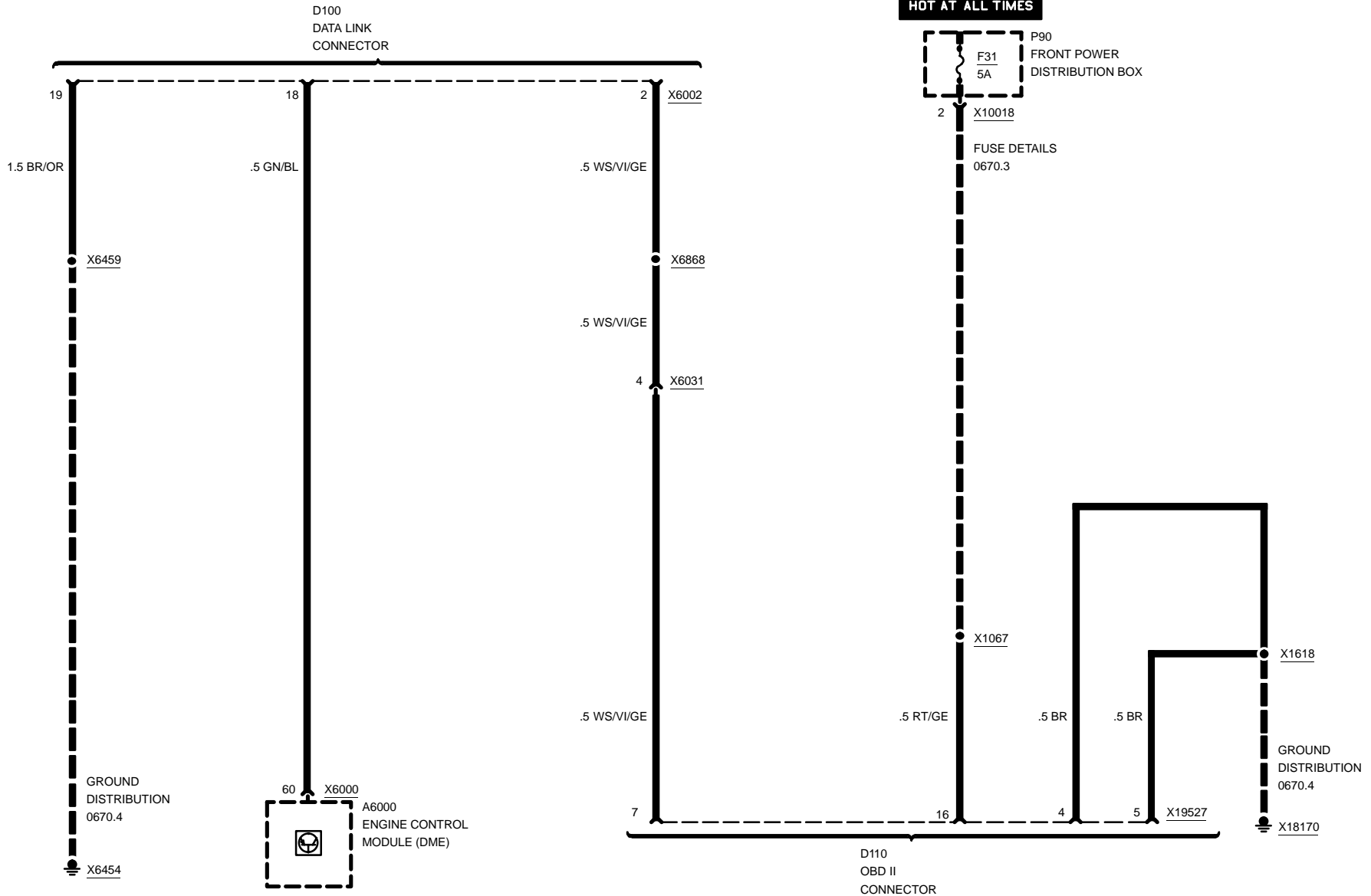

03/00

0670.5-06

1999



DATA LINK

DATA LINK CONNECTOR (X6002)

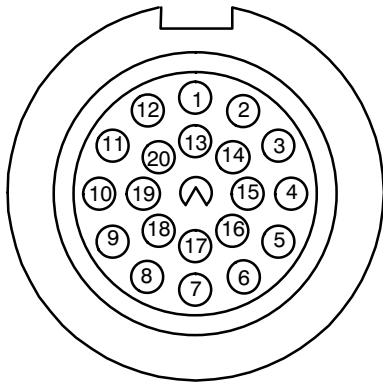

BRIDGES IN CAP OF D100 DATA LINK CONNECTOR

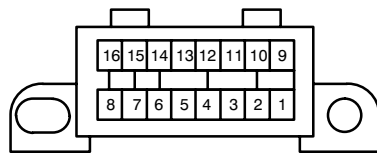
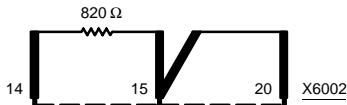
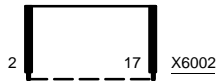

BRIDGE IN CAP OF D110 OBD II CONNECTOR



PIN NUMBER	TERMINAL NUMBER	TERMINAL DESCRIPTION	WIRE COLOR
1	TD	ENGINE	SW
2	TXD2	DIAGNOSTIC DATA LINK	WS/VI/GE
3	—	NOT OCCUPIED	
*4	R	VOLTAGE: HOT IN ACCY, RUN AND START	VI/GN
5	—	NOT OCCUPIED	
6	—	NOT OCCUPIED	
7	SI	SERVICE INTERVAL RESET	WS/GN
8	—	NOT OCCUPIED	
9	—	NOT OCCUPIED	
10	—	NOT OCCUPIED	
11	—	NOT OCCUPIED	
*12	61(D+)	GENERATOR CHARGE INDICATOR	BL
13	—	NOT OCCUPIED	
14	30	VOLTAGE: HOT AT ALL TIMES	RT
15	RXD	DIAGNOSTIC DATA LINK	WS/GE
16	15S	VOLTAGE: IGNITION SWITCH IN RUN AND START	GN/WS
17	TXD2	DIAGNOSTIC DATA LINK	WS/VI (*WS/VI/GE)
*18	PGSP	PROGRAM SELECT FOR ENGINE CONTROL MODULE (DME)	GN/BL
19	31	GROUND	BR (*BR/OR)
20	TXD	DIAGNOSTIC DATA LINK	WS/VI

* M VERSIONS

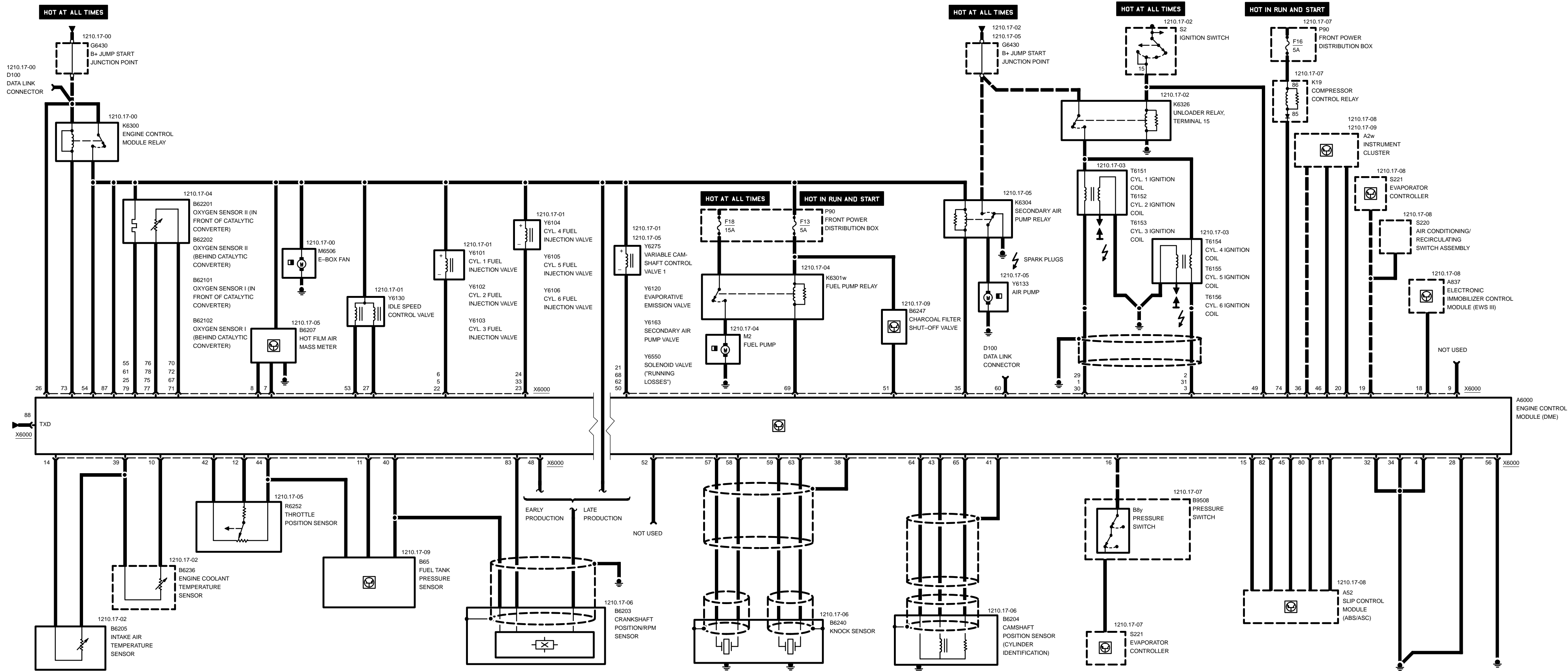



Z3

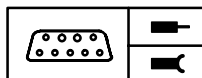

Pin Assignments

X6000

Pin	Type	Description/Function	Connection
1	A	Cyl. 2 ignition coil control	Cyl. 2 ignition coil
2	A	Cyl. 4 ignition coil control	Cyl. 4 ignition coil
3	A	Cyl. 6 ignition coil control	Cyl. 6 ignition coil
4	M	Ground	Ground point
5	A	Cyl. 2 fuel injection valve control	Cyl. 2 fuel injection valve
6	A	Cyl. 1 fuel injection valve control	Cyl. 1 fuel injection valve
7	M	Ground	Hot wire air mass meter
8	E	Hot wire air mass meter	Hot wire air mass meter
9	E	TI-measurement signal (fuel consumption)	Not used
10	E	Engine coolant temperature	Engine coolant temperature sensor
11	E	Fuel tank pressure	Fuel tank pressure sensor
12	E	Throttle position signal	Throttle position sensor
13		Not used	
14	E	Intake air temperature	Intake air temperature sensor
15	E	Speed signal right rear	ABS/ASC control module
16	E	Activate A/C	Pressure switch
17		Not used	
18	E	Drive away protection signal (code)	Electronic immobilizer control module (EWS III)
19	E	A/C-ON-signal	Air conditioning operating unit
20	A	"Check engine" indicator control	Instrument cluster
21	A	Camshaft control	Variable camshaft control valve
22	A	Cyl. 3 fuel injection valve control	Cyl. 3 fuel injection valve
23	A	Cyl. 6 fuel injection valve control	Cyl. 6 fuel injection valve
24	A	Cyl. 4 fuel injection valve control	Cyl. 4 fuel injection valve
25	M	Oxygen sensor heating ground	Oxygen sensor I (in front of catalytic converter)
26	E	Battery voltage	B+ jump start junction point
27	A	Activate valve	Idle speed control valve
28	M	Ground	Ground point
29	A	Cyl. 1 ignition coil control	Cyl. 1 ignition coil

E = Input, A = Output, M = Ground



Z3

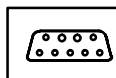

Pin Assignments

Pin	Type	Description/Function	Connection
30	A	Cyl. 3 ignition coil control	Cyl. 3 ignition coil
31	A	Cyl. 5 ignition coil control	Cyl. 5 ignition coil
32	M	Ground	Ground point
33	A	Cyl. 5 fuel injection valve control	Cyl. 5 fuel injection valve
34	M	Ground	Ground point
35	A	Activate relay	Secondary air pump relay
36	A	Crankshaft RPM speed signal TD	Instrument cluster
37		Not used	
38	M	Ground	Shield knock sensor
39	M	Ground	Temperature sensors
40	M	Ground	Crankshaft position/RPM sensor Fuel tank pressure sensor
41	M	Ground	Shield camshaft position sensor
42	M	Ground	Throttle position sensor
43	M	Ground	Camshaft position sensor
44	A	Voltage supply	Throttle position sensor Fuel tank pressure sensor
45	A	Throttle position signal	ABS/ASC control module
46	E	TI-measurement signal (fuel consumption)	Instrument cluster
47		Not used	
48	A	Voltage supply	Crankshaft position/RPM sensor (Early Production)
49	E	Terminal 15	Ignition switch
50	A	Running losses	Solenoid valve
51	A	Activate valve	Charcoal filter shut off valve
52		Not used	
53	A	Activate valve	Idle speed control valve
54	E	Battery voltage, terminal 87	Engine control module relay
55	M	Oxygen sensor heating ground	Oxygen sensor II (in front of catalytic converter)
56	M	Ground	Ground point
57	E	Cyl. 1-3 knock sensor	Knock sensor
58	E	Cyl. 1-3 knock sensor	Knock sensor

E = Input, A = Output, M = Ground



Z3

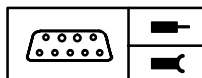

Pin Assignments

Pin	Type	Description/Function	Connection
59	E	Cyl. 4-6 knock sensor	Knock sensor
60	E	Programming voltage	Data link connector
61	M	Oxygen sensor heating ground	Oxygen sensor II (behind catalytic converter)
62	E	Activate valve	Secondary air pump valve
63	E	Cyl. 4-6 knock sensor	Knock sensor
64	E	Camshaft position	Camshaft position sensor
65	E	Camshaft position	Camshaft position sensor
66		Not used	
67	M	Oxygen sensor signal ground	Oxygen sensor I (in front of catalytic converter)
68	E	Activate valve	Evaporative emission valve
69	E	Activate relay	Fuel pump relay
70	M	Oxygen sensor signal ground	Oxygen sensor II (in front of catalytic converter)
71	M	Oxygen sensor signal ground	Oxygen sensor I (behind catalytic converter)
72	M	Oxygen sensor signal ground	Oxygen sensor II (behind catalytic converter)
73	E	Activate relay	Engine control module relay
74	A	Activate A/C compressor	Compressor control relay
75	E	Sensor signal	Oxygen sensor I (in front of catalytic converter)
76	E	Sensor signal	Oxygen sensor II (in front of catalytic converter)
77	E	Sensor signal	Oxygen sensor I (behind catalytic converter)
78	E	Sensor signal	Oxygen sensor II (behind catalytic converter)
79	M	Oxygen sensor heating ground	Oxygen sensor I (behind catalytic converter)
80	A	ASC signal ZA	Slip control module ABS/ASC
81	A	ASC signal ZWV	Slip control module ABS/ASC
82	A	ASC signal MSR	Slip control module ABS/ASC
83	E	Sensor signal	Crankshaft position/RPM sensor

E = Input, A = Output, M = Ground



Z3

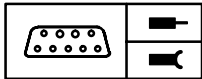

Pin Assignments

Pin	Type	Description/Function	Connection
84		Not used	
85		Not used	
86		Not used	
87	E	Battery voltage, terminal 87	Engine control module relay
88	E/A	TxD diagnosis data link	Data link connector

E = Input, A = Output, M = Ground



ENGINE CONTROL SYSTEM MS41.1 (6-CYLINDER S52)

M VERSIONS

POWER

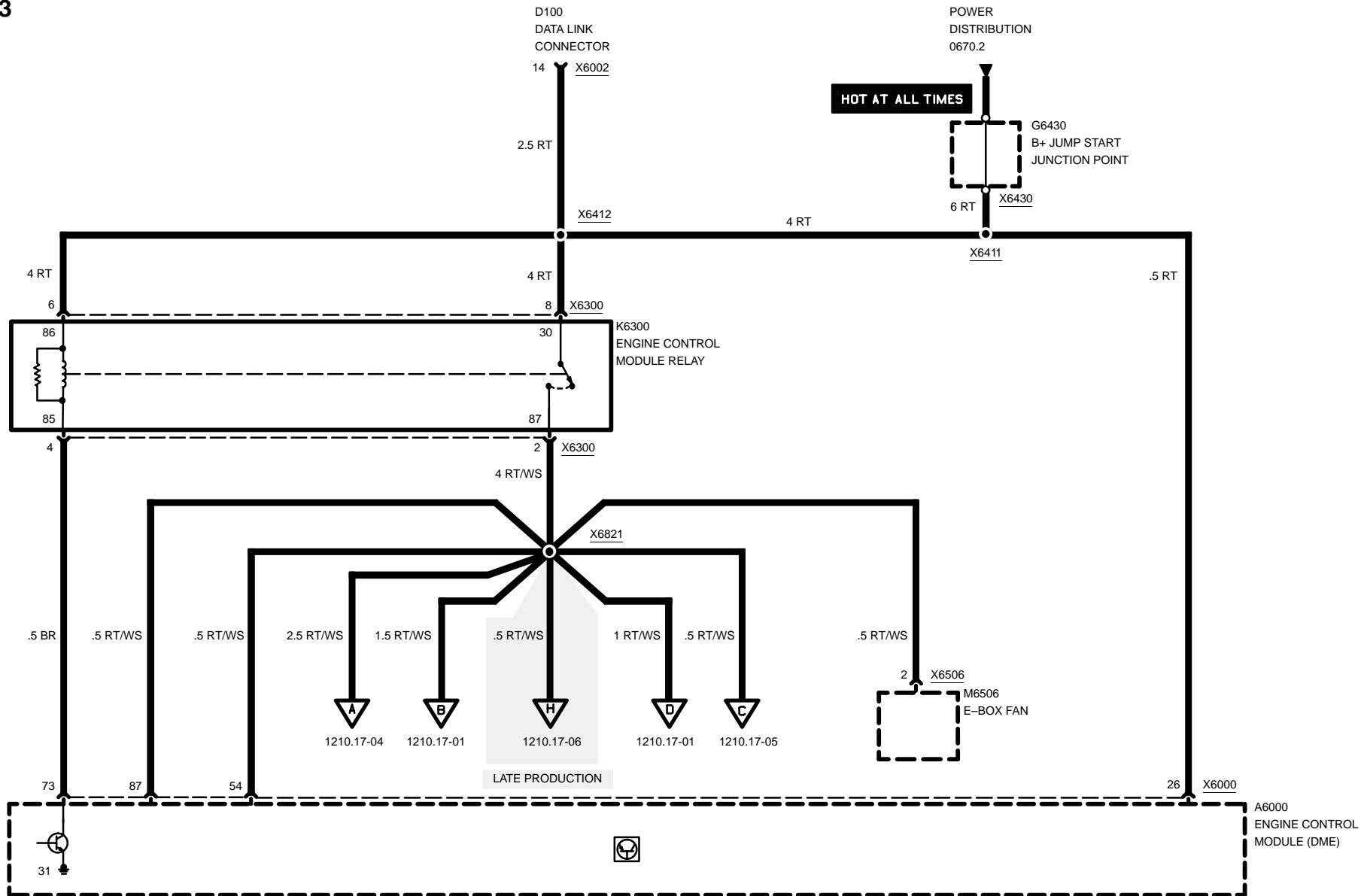

03/00

1210.17-00

1999



ENGINE CONTROL SYSTEM MS41.1 (6-CYLINDER S52)

M VERSIONS

Z3

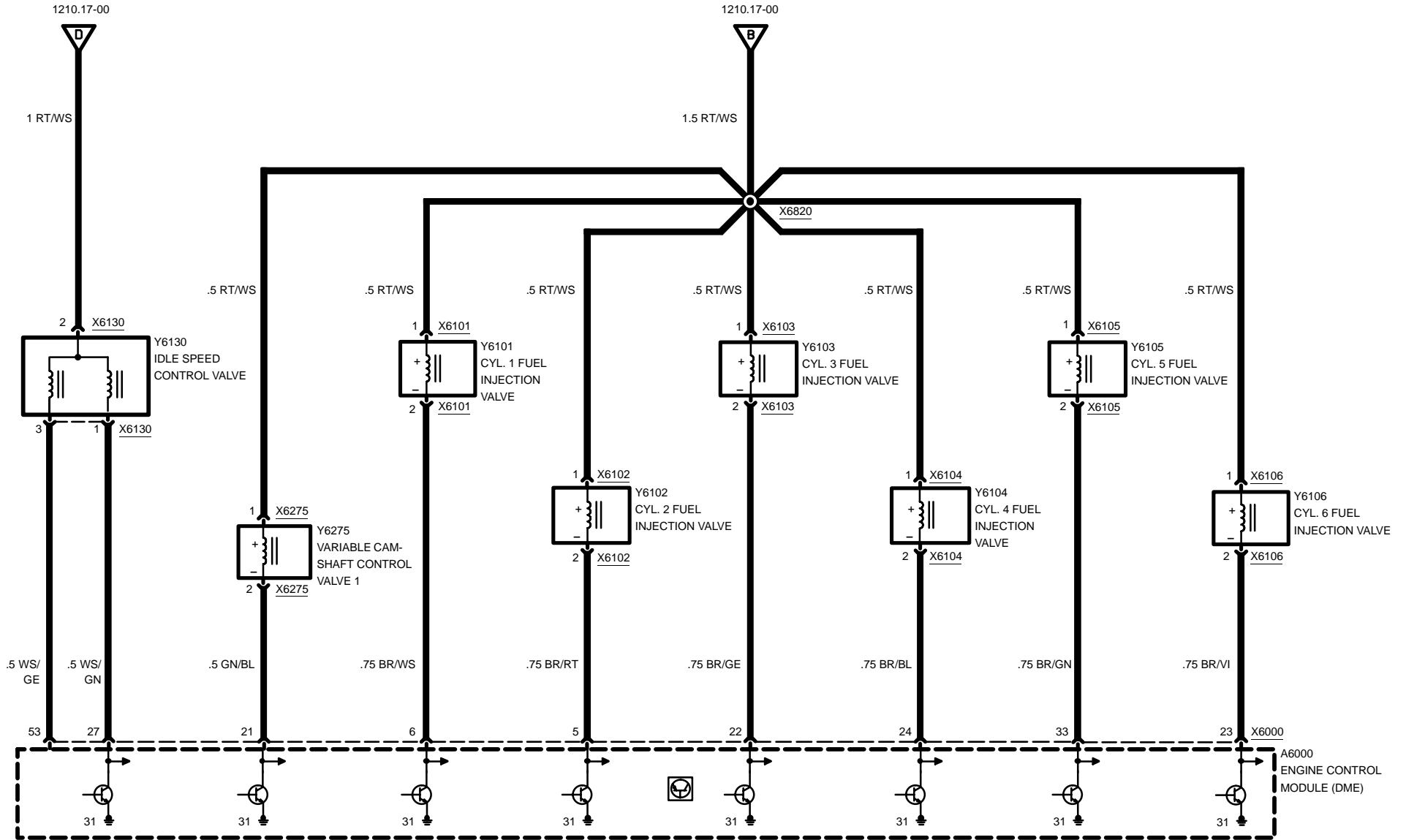

03/00

1210.17-01

1999



ENGINE CONTROL SYSTEM MS41.1 (6-CYLINDER S52)

M VERSIONS

Z3

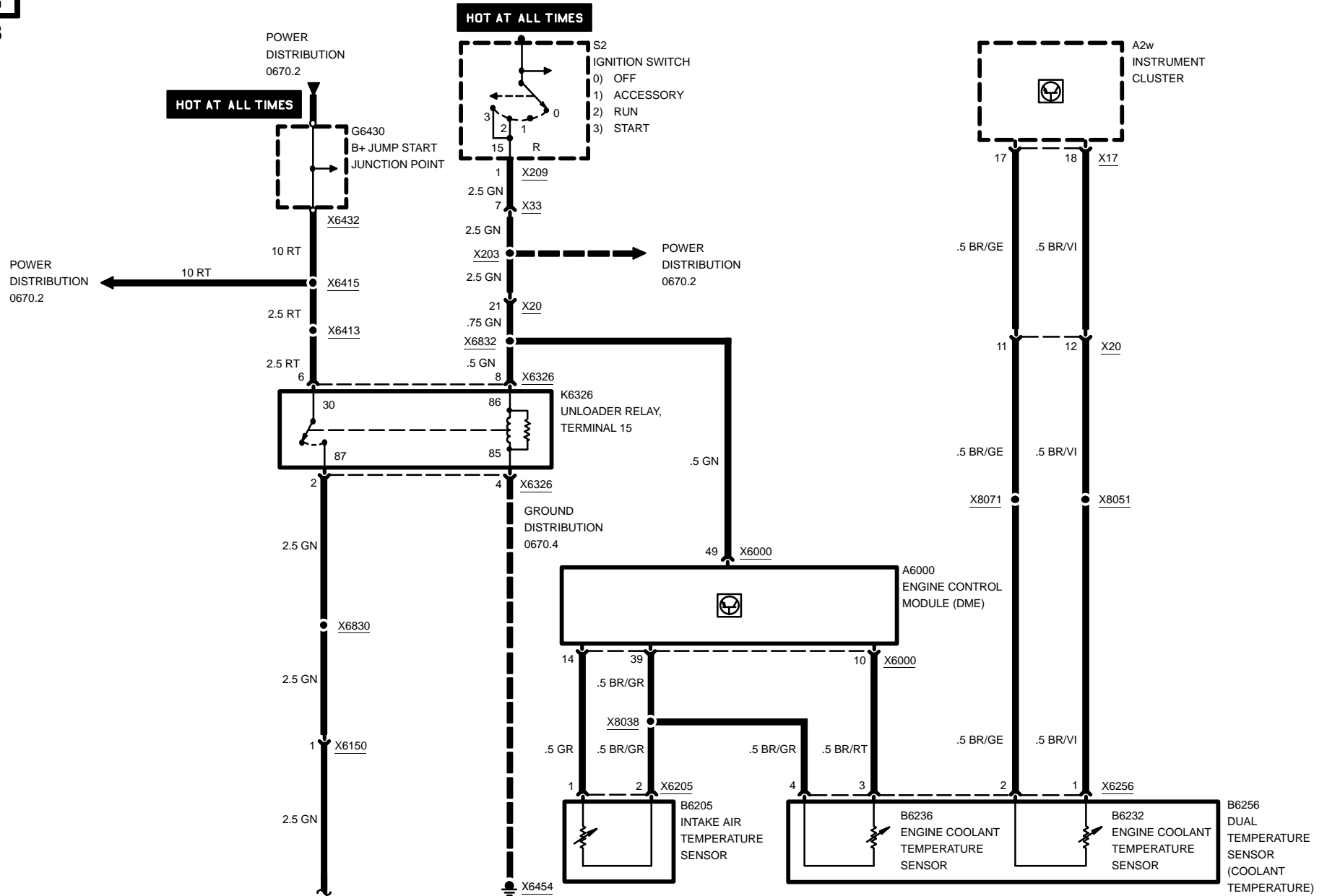

03/00

1210.17-02

1999

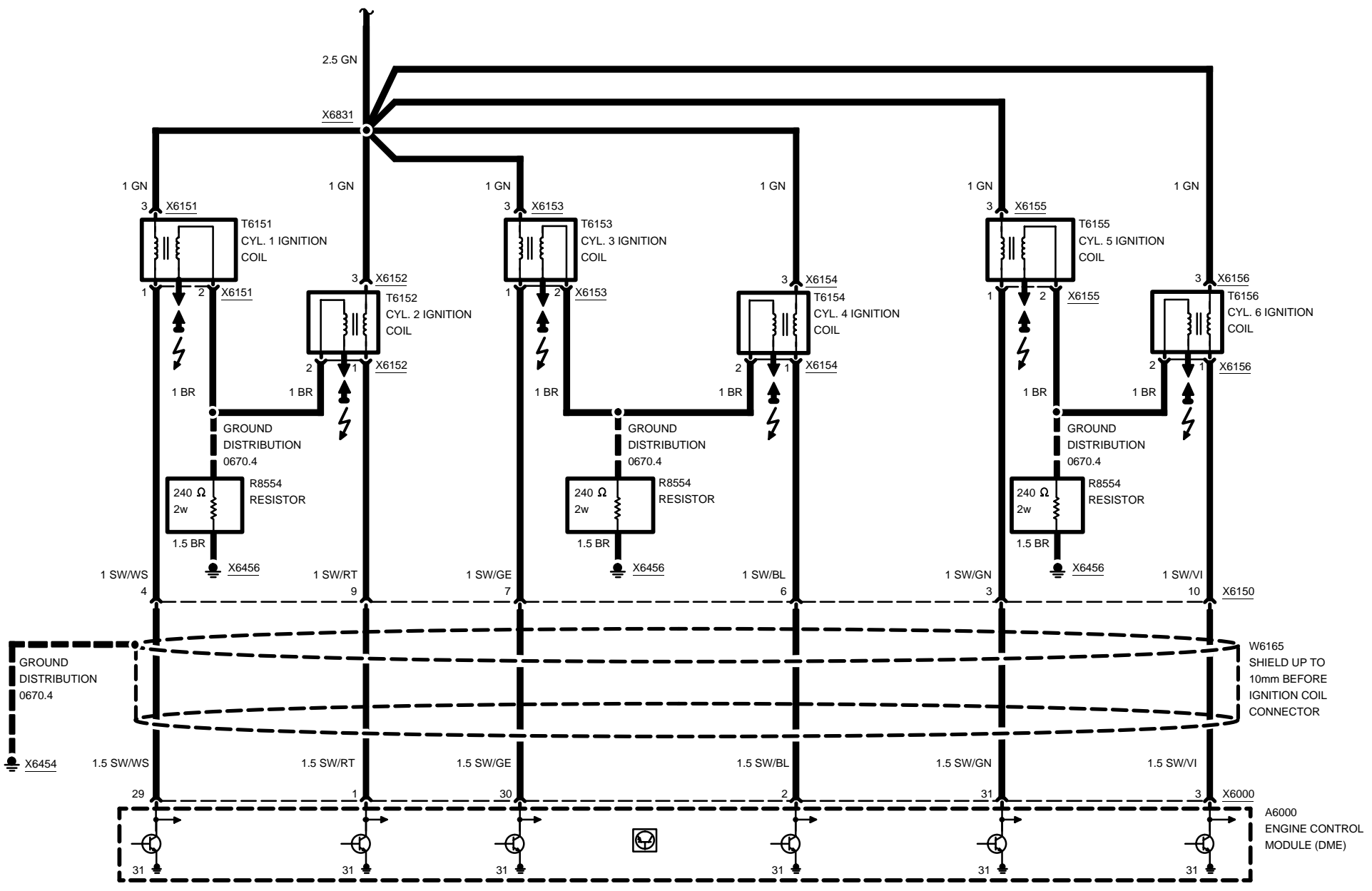

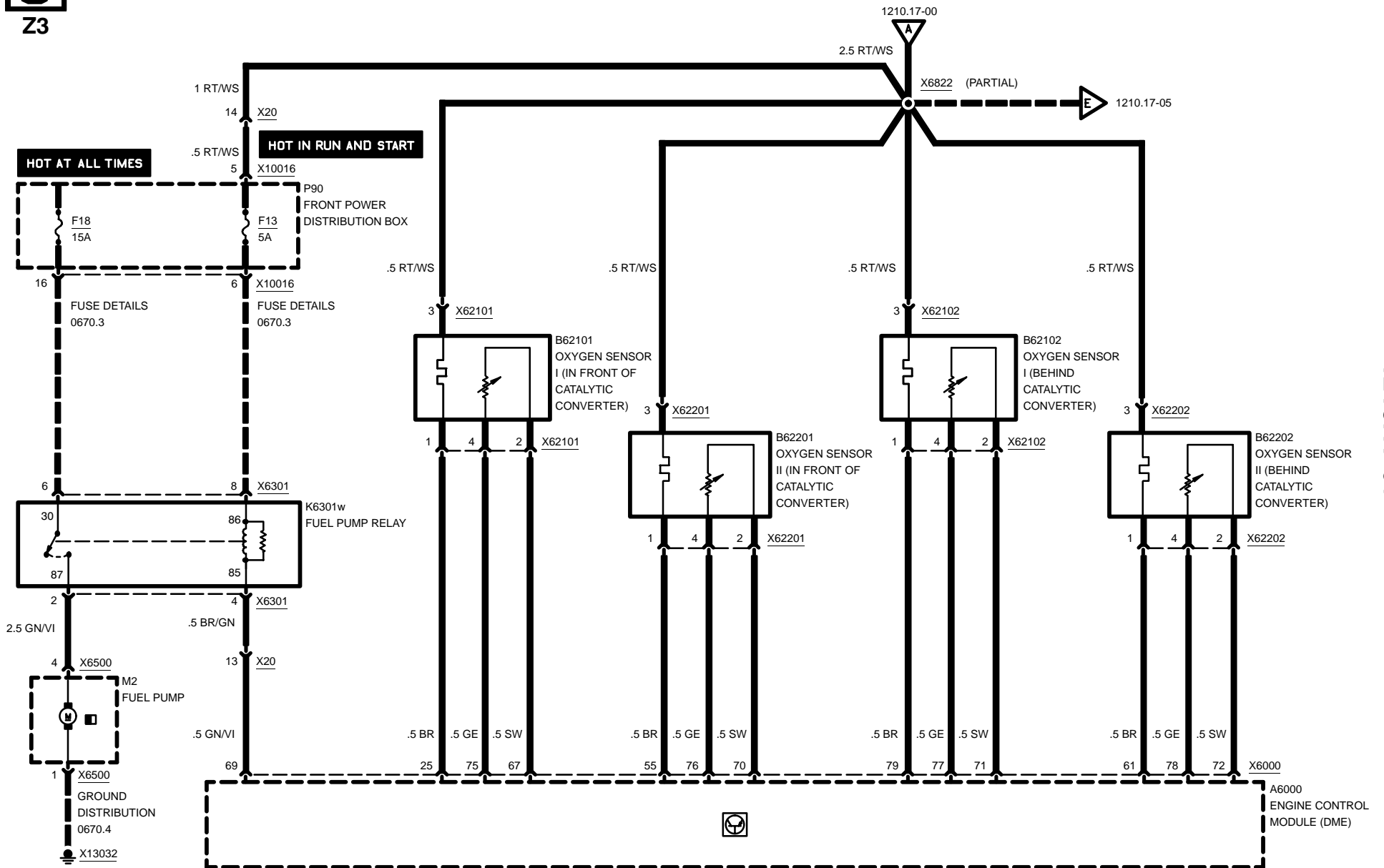

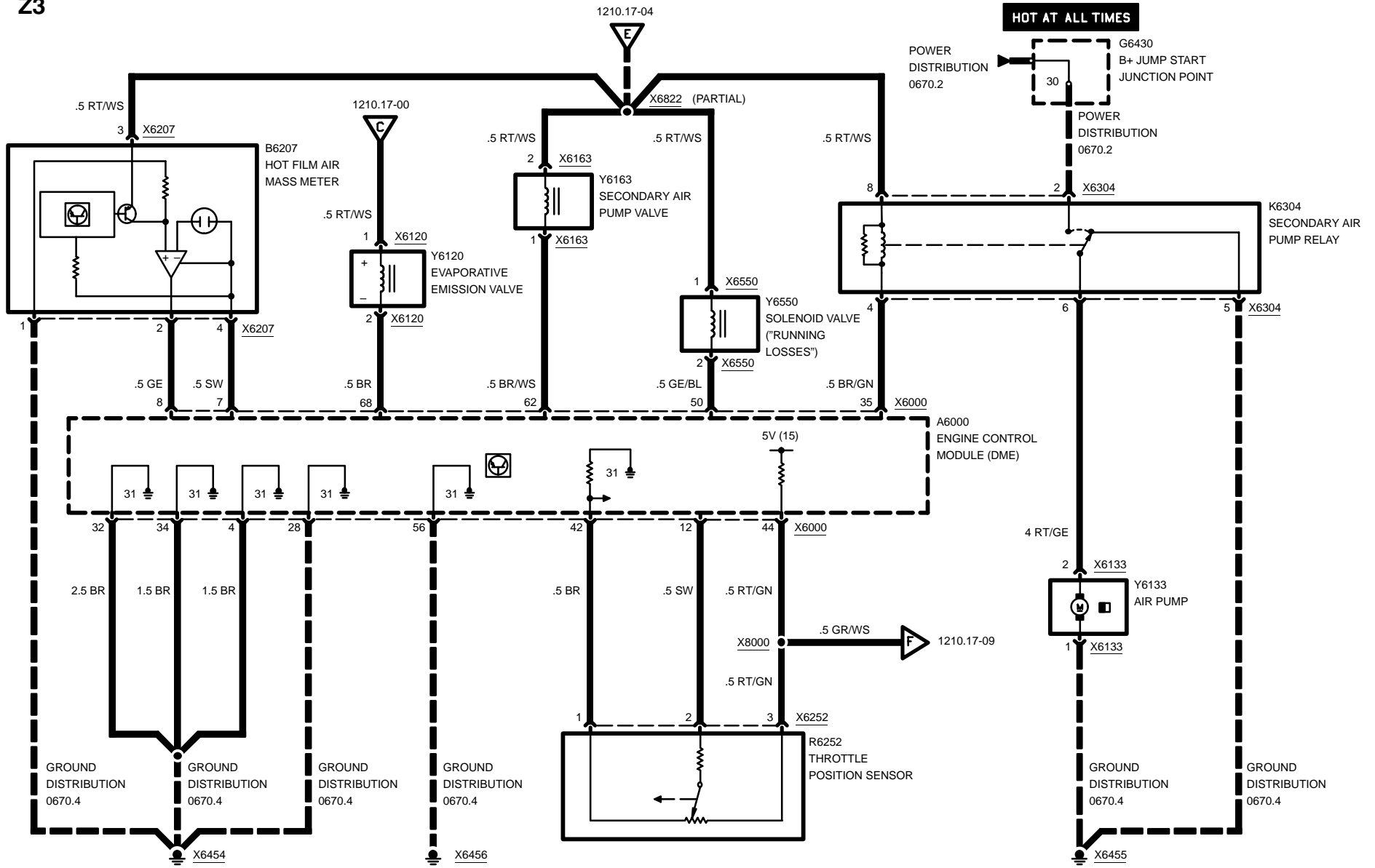

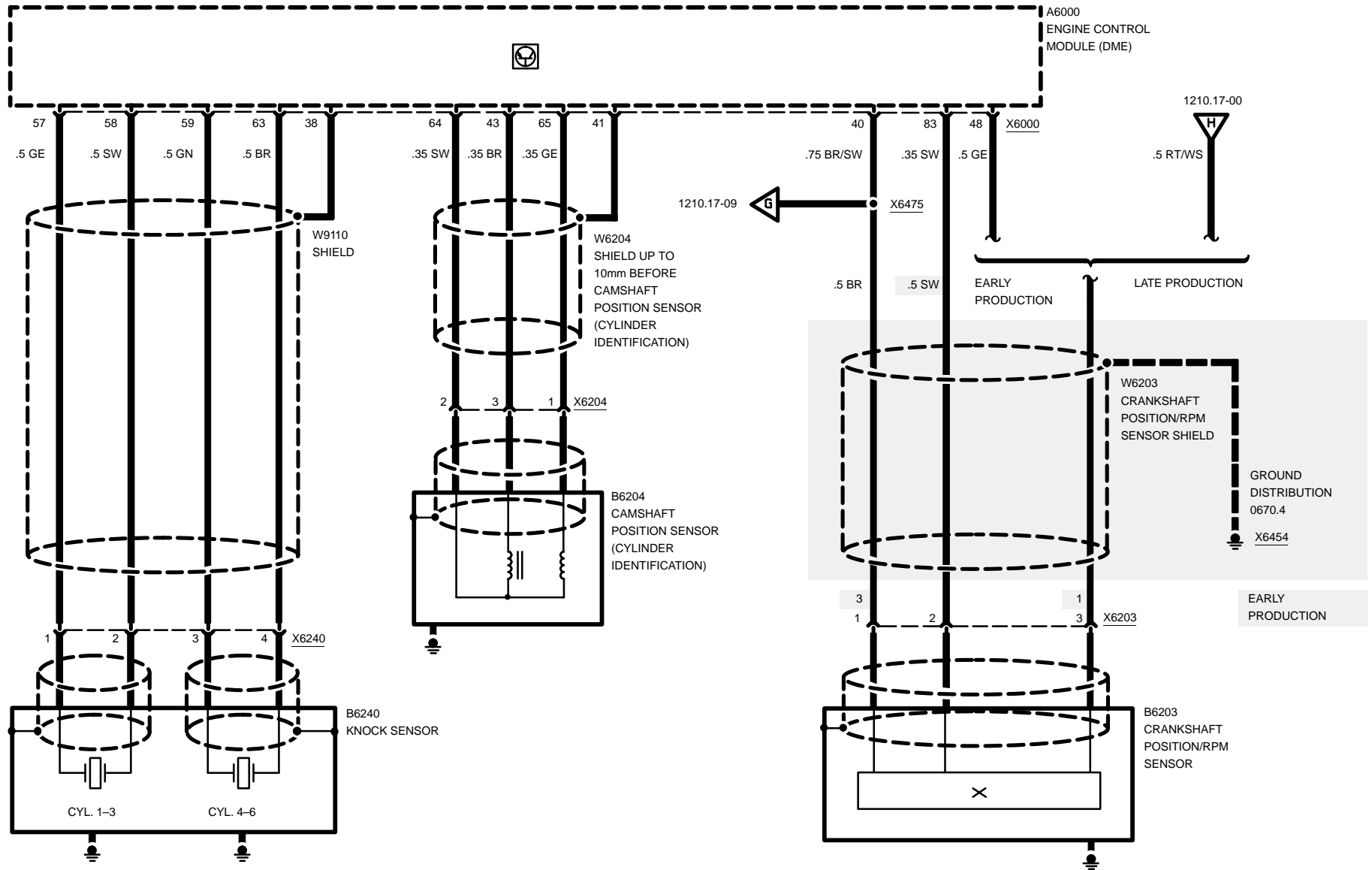

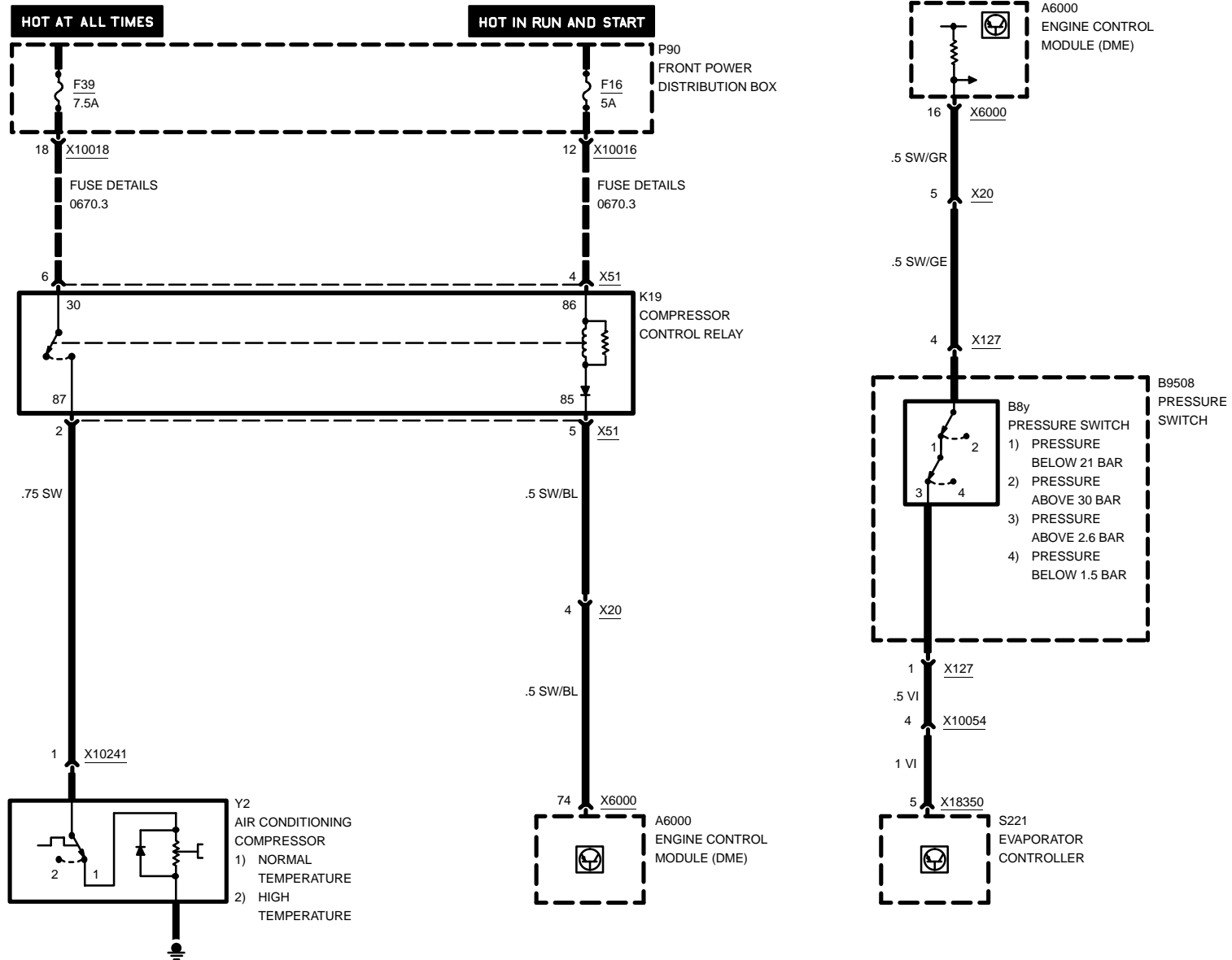



ENGINE CONTROL SYSTEM MS41.1 (6-CYLINDER S52)

M VERSIONS

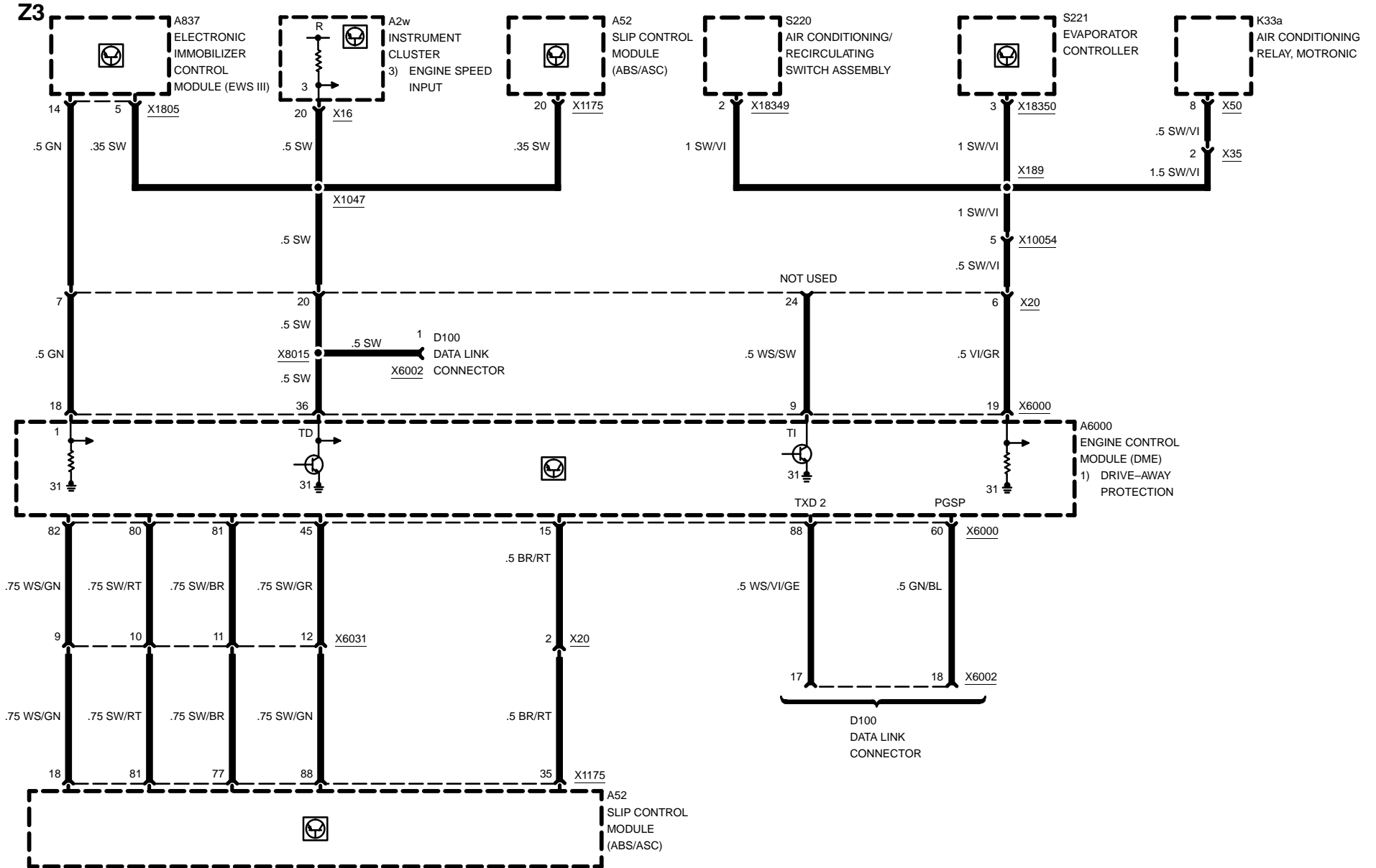

03/00

1210.17-08

1999



ENGINE CONTROL SYSTEM MS41.1 (6-CYLINDER S52)

M VERSIONS

OB D II DIAGNOSIS

Z3

HOT IN ACCY RUN AND START

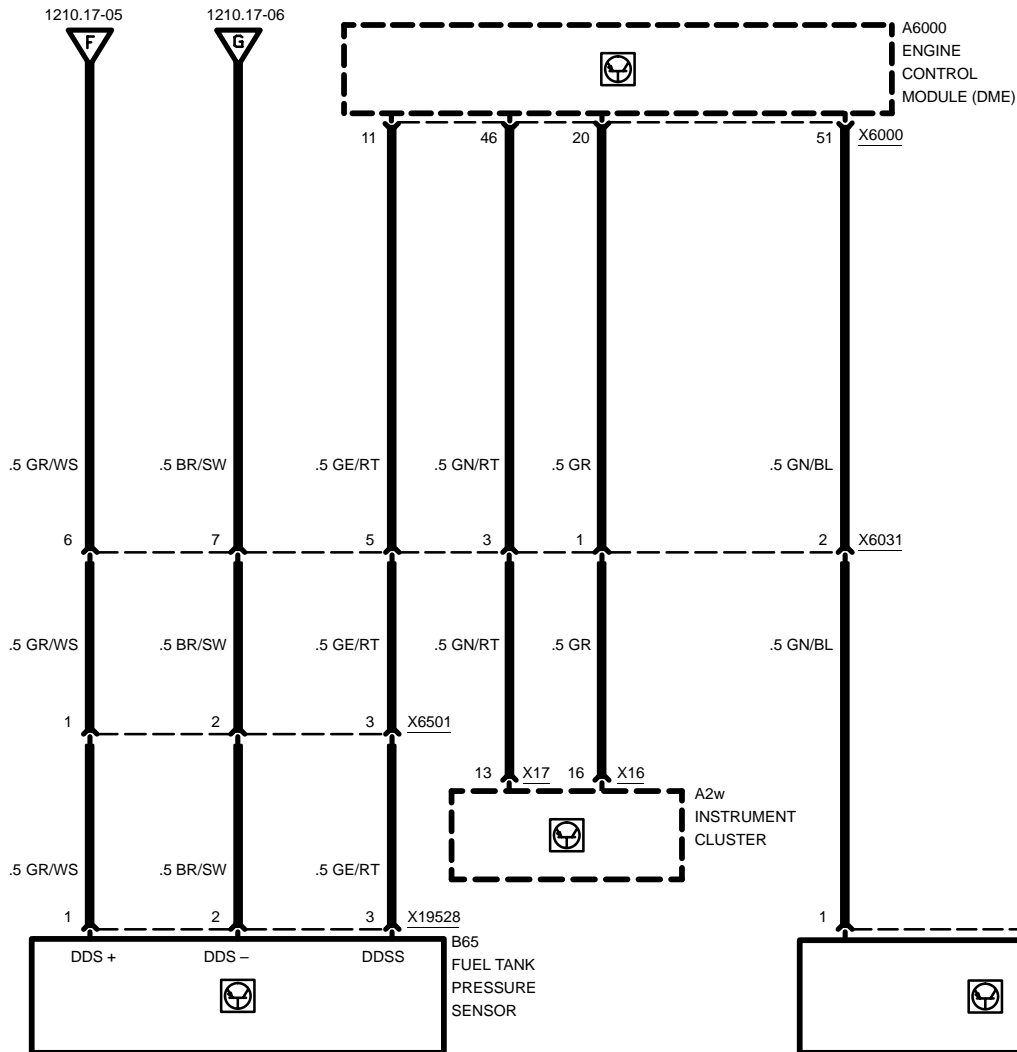
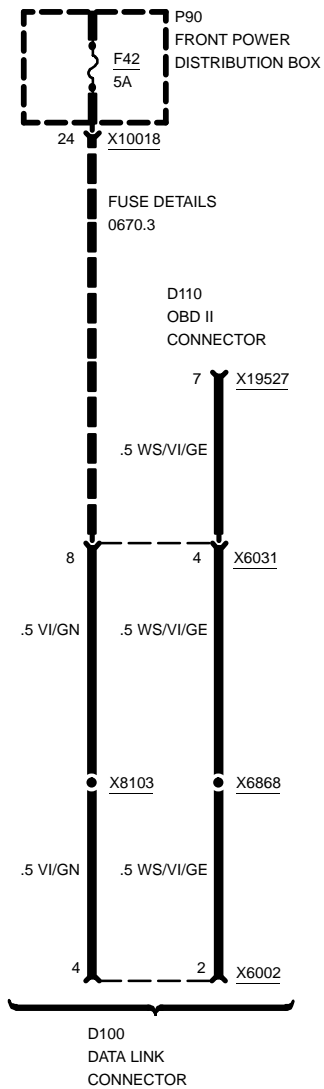

HOT IN RUN AND START

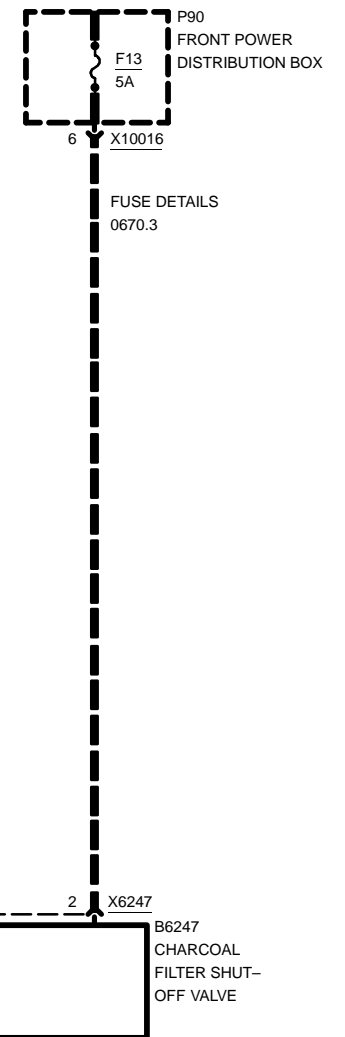

03/00

1210.17-09

1999

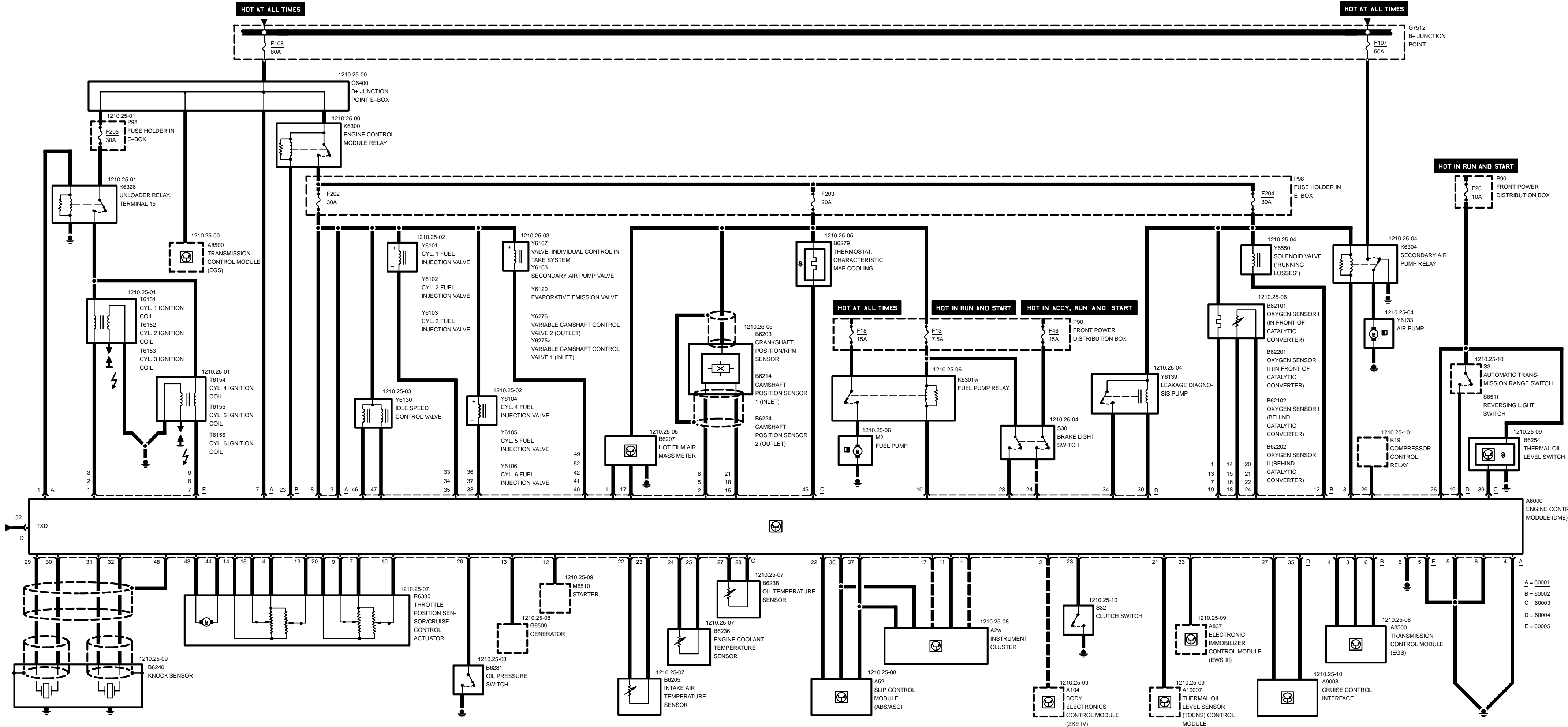

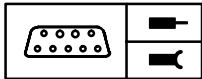

Z3

**Pin Assignments**

A = X60001 9 Pins, black

B = X60002 24 Pins, black

C = X60003 52 Pins, black

D = X60004 40 Pins, black

E = X60005 9 Pins, black

X60001

Pin	Type	Signal	Description/Function	Connection
1	A	15	Activate relay	Unloader relay terminal 15
2			Not used	
3			Not used	
4	M	31E	Ground	Ground point
5	M	31L	Ground	Ground point
6	M	31L	Ground	Ground point
7	E	30	Voltage supply	B+ junction point E-box
8	E	U_HR<2	Voltage supply	Fuse holder in E-box
9	E	U_HR<2	Voltage supply	Fuse holder in E-box

X60002

Pin	Type	Signal	Description/Function	Connection
1	M	T_LHV1	Oxygen sensor heating ground	Oxygen sensor 1 (in front of catalytic converter)
2			Not used	
3	E/A	D_CAN-L	CAN bus low	Transmission control module (EGS)
4	E/A	D_CAN-H	CAN bus high	Transmission control module (EGS)
5			Not used	
6	E/A	D_TXD2	Diagnosis	Transmission control module (EGS)
7	M	T_LHH1	Oxygen sensor heating ground	Oxygen sensor 1 (behind catalytic converter)
8			Not used	

E = Input, A = Output, M = Ground

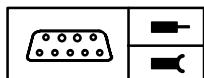

Z3

**Pin Assignments**

Pin	Type	Signal	Description/Function	Connection
9			Not used	
10			Not used	
11			Not used	
12	A	S_KKU	Activate valve	Solenoid valve (Running Losses)
13	M	T_LHV2	Oxygen sensor heating ground	Oxygen sensor 2 (in front of catalytic converter)
14	E	A_LSV1	Sensor signal	Oxygen sensor 1 (in front of catalytic converter)
15	E	A_LSV2	Sensor signal	Oxygen sensor 2 (in front of catalytic converter)
16	E	A_LSH1	Sensor signal	Oxygen sensor 1 (behind catalytic converter)
17			Not used	
18	E	A_LSH2	Sensor signal	Oxygen sensor 2 (behind catalytic converter)
19	M	T_LHH2	Oxygen sensor heating ground	Oxygen sensor 2 (behind catalytic converter)
20	M	M_LSV1	Signal ground	Oxygen sensor 1 (in front of catalytic converter)
21	M	M_LSV2	Signal ground	Oxygen sensor 2 (in front of catalytic converter)
22	M	M_LSH1	Signal ground	Oxygen sensor 1 (behind catalytic converter)
23	A	S_HR	Activate relay	Engine control module relay
24	M	M_LSH2	Signal ground	Oxygen sensor 2 (behind catalytic converter)

X60003

Pin	Type	Signal	Description/Function	Connection
1	E	A_HFM	Signal air mass meter	Hot film air mass meter
2	E	P_NWGA1	Signal camshaft position	Camshaft position sensor 2 (outlet)
3			Not used	
4	A	U_DKFW1	Voltage supply	Throttle position sensor 1

E = Input, A = Output, M = Ground

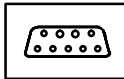

Pin Assignments

Pin	Type	Signal	Description/Function	Connection
5	E	P_NWGE1	Signal camshaft position	Camshaft position sensor 1 (inlet)
6			Not used	
7	A	U_DKFW2	Voltage supply	Throttle position sensor 2
8	E	P_KWG	Signal crankshaft position	Crankshaft position sensor
9	E	A_FWG2	Throttle position signal	Throttle position sensor 2
10	E	A_DKG2	Throttle position signal	Throttle position sensor 2
11			Not used	
12	E	S_30H	Start signal	Starter
13	E	S_61-1	Charging signal	Generator
14	M	M_DKFW1	Ground	Throttle position sensor 1
15	M	M_NWGA1	Ground	Camshaft position sensor 2 (outlet)
16	E	A_FWG1	Throttle position signal	Throttle position sensor 1
17	M	M_HFM	Ground	Hot film air massmeter
18	M	M_NWGE1	Ground	Crankshaft position sensor 1 (inlet)
19	E	A_DKG1	Throttle position signal	Throttle position sensor 1
20	M	M_DKFW2	Ground	Throttle position sensor 2
21	M	M_KWG	Ground	Crankshaft position sensor
22	E	A_TANS	Temperature signal	Intake air temperature sensor
23	M	M_TANS	Ground	Intake air temperature sensor
24	E	A_TMOT	Temperature signal	Engine coolant temperature sensor
25	M	M_TMOT	Ground	Engine coolant temperature sensor
26	E	A_OLD	Pressure signal	Oil pressure switch
27	E	A_TOEL	Temperature signal	Oil temperature sensor
28	M	M_TOEL	Ground	Oil temperature sensor
29	E	A_KS1A	Cyl. 1-3 knock sensor	Knock sensor
30	E	A_KS1B	Cyl. 1-3 knock sensor	Knock sensor
31	E	A_KS2A	Cyl. 4-6 knock sensor	Knock sensor
32	E	A_KS2B	Cyl. 4-6 knock sensor	Knock sensor
33	A	P_EVZ1	Activate valve	Cyl. 1 fuel injection valve
34	A	P_EVZ2	Activate valve	Cyl. 2 fuel injection valve
35	A	P_EVZ3	Activate valve	Cyl. 3 fuel injection valve
36	A	P_EVZ4	Activate valve	Cyl. 4 fuel injection valve

E = Input, A = Output, M = Ground

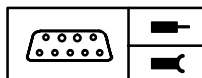

Z3

**Pin Assignments**

Pin	Type	Signal	Description/Function	Connection
37	A	P_EVZ5	Activate valve	Cyl. 5 fuel injection valve
38	A	P_EVZ6	Activate valve	Cyl. 6 fuel injection valve
39	E	F_OLN	Level signal	Oil level sensor
40	A	T_NWE1	Activate valve	Variable camshaft control valve 1 (inlet)
41	A	T_NWA1	Activate valve	Variable camshaft control valve 2 (outlet)
42	A	T_TEV	Activate valve	Evaporative emission valve
43	A	T_MDK1	Activate motor	Cruise control actuator
44	A	T_MDK2	Activate motor	Cruise control actuator
45	A	S_KFK	Cooling signal	Thermostat, characteristic map cooling
46	A	T_LLFSS	CLOSE signal	Idle speed control valve
47	A	T_LLFSO	OPEN signal	Idle speed control valve
48	M	W_KS	Ground	Shield knock sensor
49	A	S_DISA	Activate valve	Valve, individual control intake system
50			Not used	
51			Not used	
52	A	S_SLPV	Activate valve	Secondary air pump valve

X60004

Pin	Type	Signal	Description/Function	Connection
1	A	61	Charging signal	Instrument cluster
2	A	30H	Start signal	Body electronics control module (ZKE IV)
3	A	S_SLP	Activate relay	Secondary air pump relay
4			Not used	
5			Not used	
6			Not used	
7			Not used	
8			Not used	

E = Input, A = Output, M = Ground



03/00

1210.25-e

1999

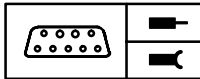

Pin Assignments

Pin	Type	Signal	Description/Function	Connection
9			Not used	
10	A	EKP	Activate relay	Fuel pump relay
11	A	OELD	Oil pressure signal	Instrument cluster
12			Not used	
13			Not used	
14			Not used	
15			Not used	
16			Not used	
17	A	TD	Crankshaft RPM speed signal TD	Instrument cluster
18			Not used	
19	E	RFL	Reverse signal	Reversing light switch/ Automatic transmission range switch
20			Not used	
21	A	A-OELN	Oil level signal	Thermal oil level sensor (TOENS) control module
22	E	DFAHR	Speed signal right rear	ABS/ASC control module
23	E	KUPP	Clutch signal	Clutch switch
24	E	KL 54 ON	Brake signal	Brake light switch
25			Not used	
26	E	15A26	Terminal 15	Fuse 26
27	E	MFL	Cruise control signal	Cruise control interface
28	E	S_BLTS	Brake signal	Brake light switch
29	A	S_KOREL	Activate relay	Compressor control relay
30	A	LDPV	Activate valve	Leakage diagnosis pump
31			Not used	
32	E/A	TXDII	TXD diagnosis data link	Data link connector
33	E	S_DWA	Drive-away protection signal (code)	Electronic immobilizer control module (EWS III)
34	E	LDPS	Leakage signal	Leakage diagnosis pump
35	M	31	Ground	Cruise control interface
36	E/A	CAN+	CAN bus high	Instrument cluster, ABS/ASC control module

E = Input, A = Output, M = Ground

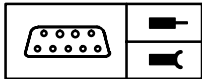

Z3

**Pin Assignments**

Pin	Type	Signal	Description/Function	Connection
37	E/A	CAN-	CAN bus low	Instrument cluster, ABS/ASC control module
38			Not used	
39			Not used	
40			Not used	

X60005

Pin	Type	Signal	Description/Function	Connection
1	A	P_ZSZ3	Ignition coil signal	Cyl. 3 ignition coil
2	A	P_ZSZ2	Ignition coil signal	Cyl. 2 ignition coil
3	A	P_ZSZ1	Ignition coil signal	Cyl. 1 ignition coil
4			Not used	
5	M	31L	Ground	Ground point
6	M	A_ZSR	Ground	Ground point
7	A	P_ZSZ6	Ignition coil signal	Cyl. 6 ignition coil
8	A	P_ZSZ5	Ignition coil signal	Cyl. 5 ignition coil
9	A	P_ZSZ4	Ignition coil signal	Cyl. 4 ignition coil

E = Input, A = Output, M = Ground



ENGINE CONTROL SYSTEM MS42.1 (6-CYLINDER M52)

Z3 VERSIONS

POWER

HOT AT ALL TIMES

POWER DISTRIBUTION
0670.2

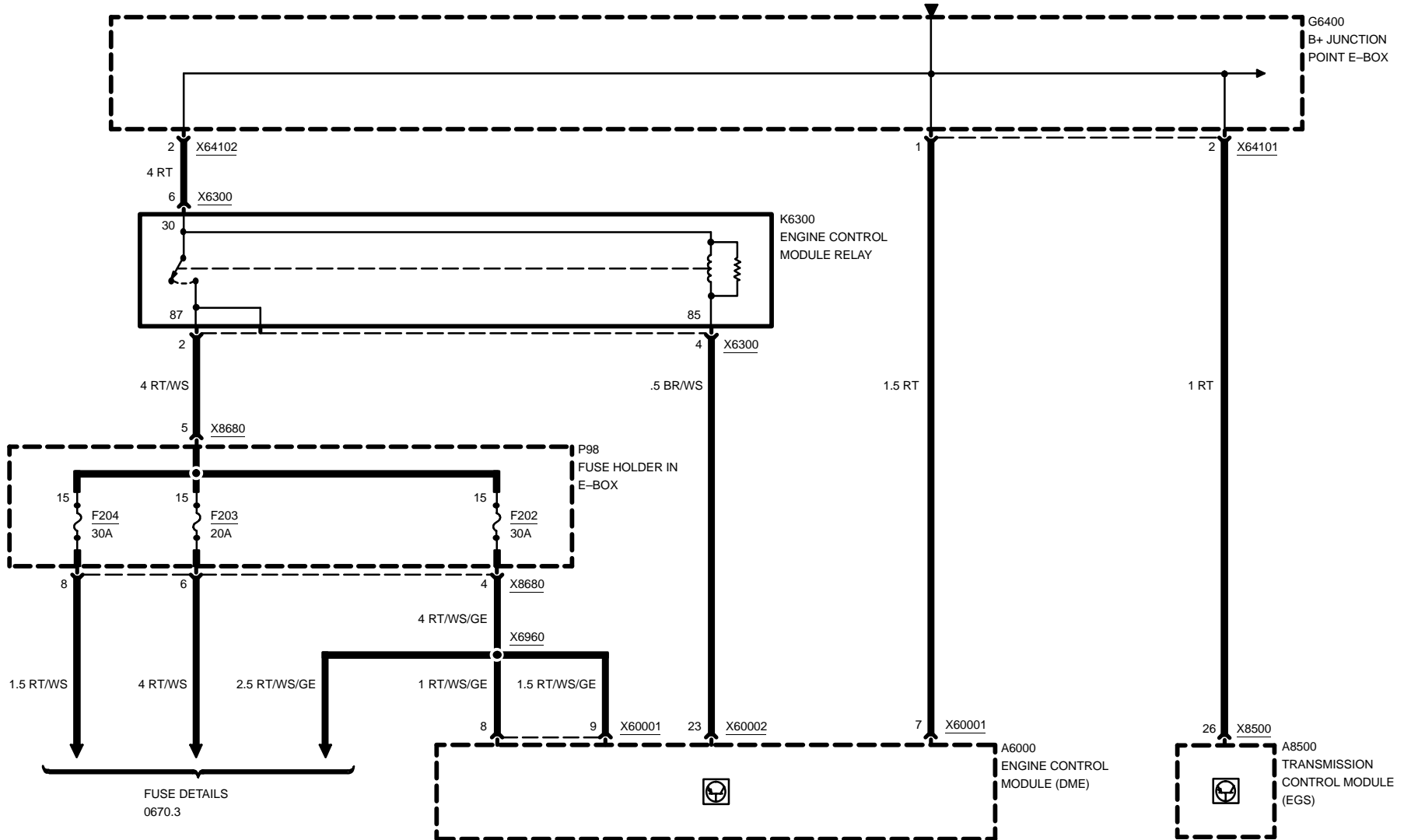

03/00

1210.25-00

1999



ENGINE CONTROL SYSTEM MS42.1 (6-CYLINDER M52)

Z3 VERSIONS

Z3

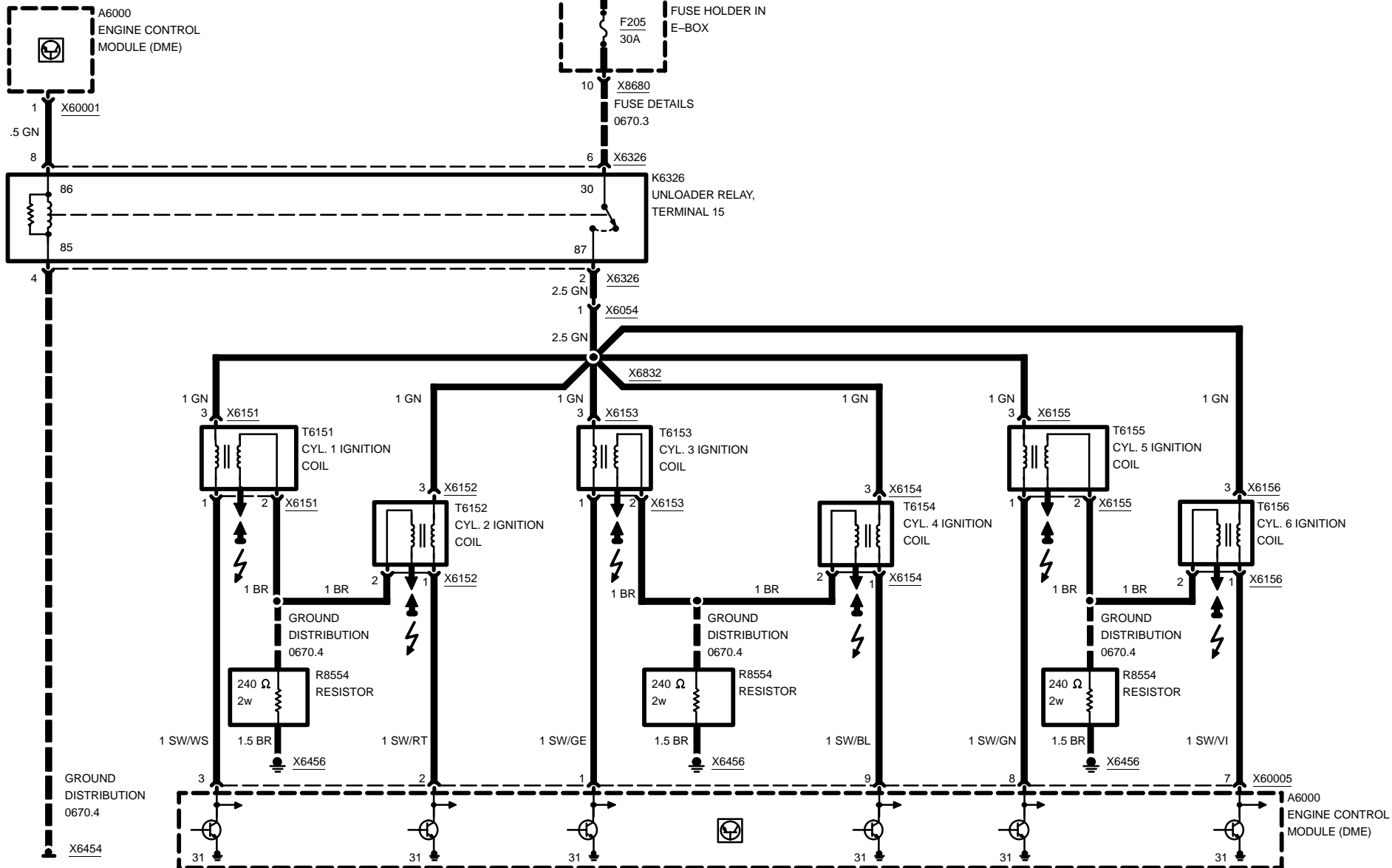

03/00

1210.25-01

1999

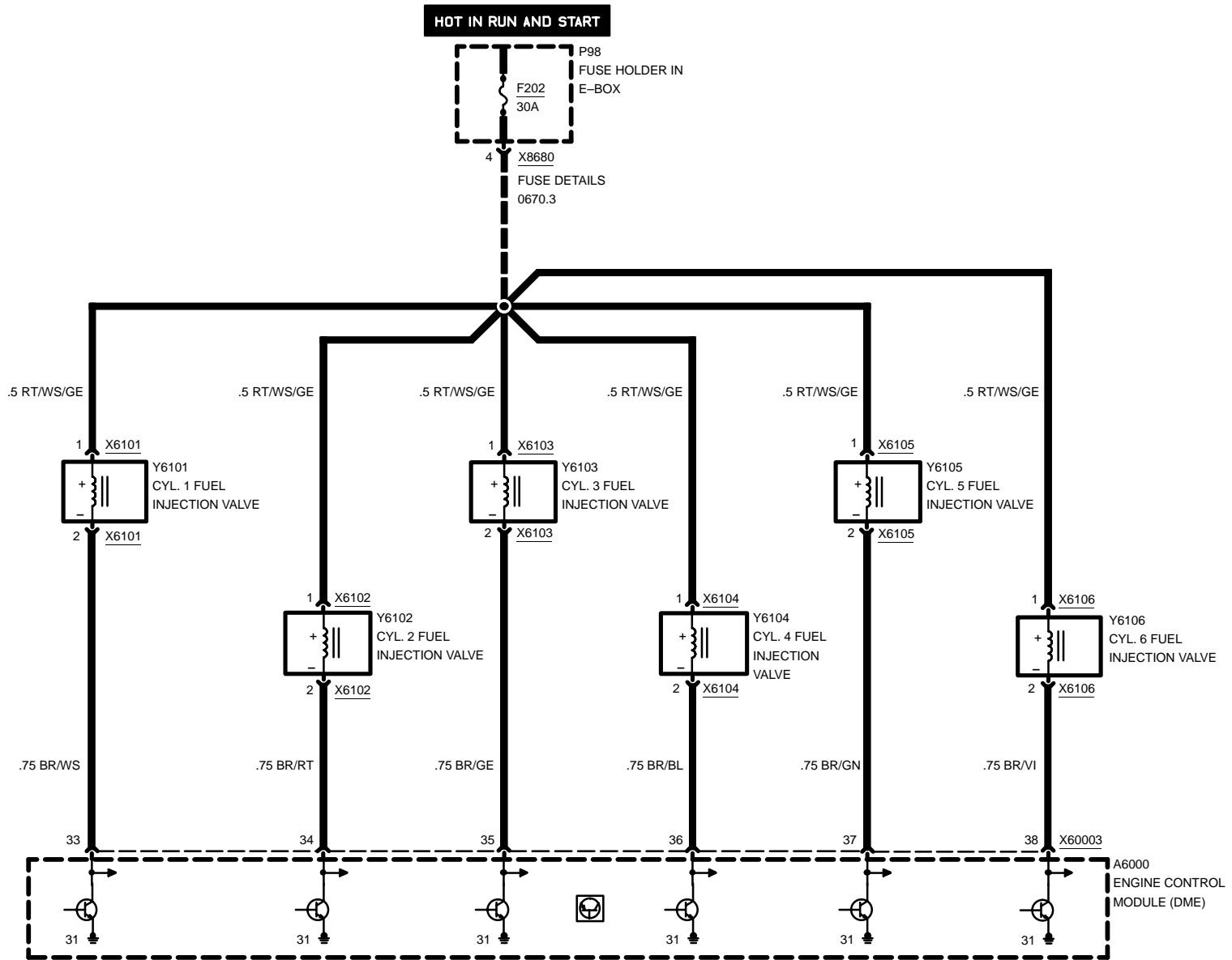

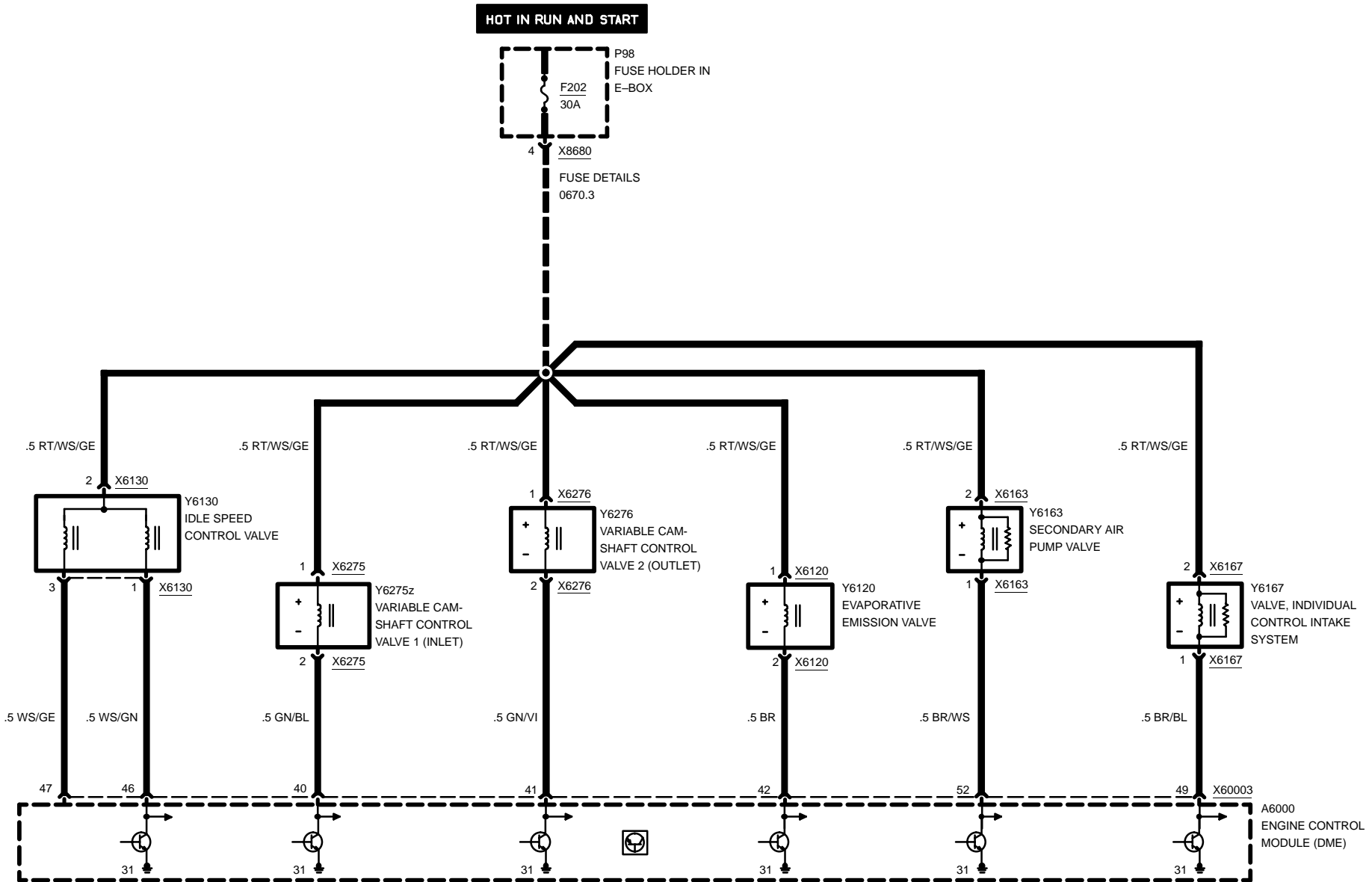



ENGINE CONTROL SYSTEM MS42.1 (6-CYLINDER M52)

Z3 VERSIONS

Z3

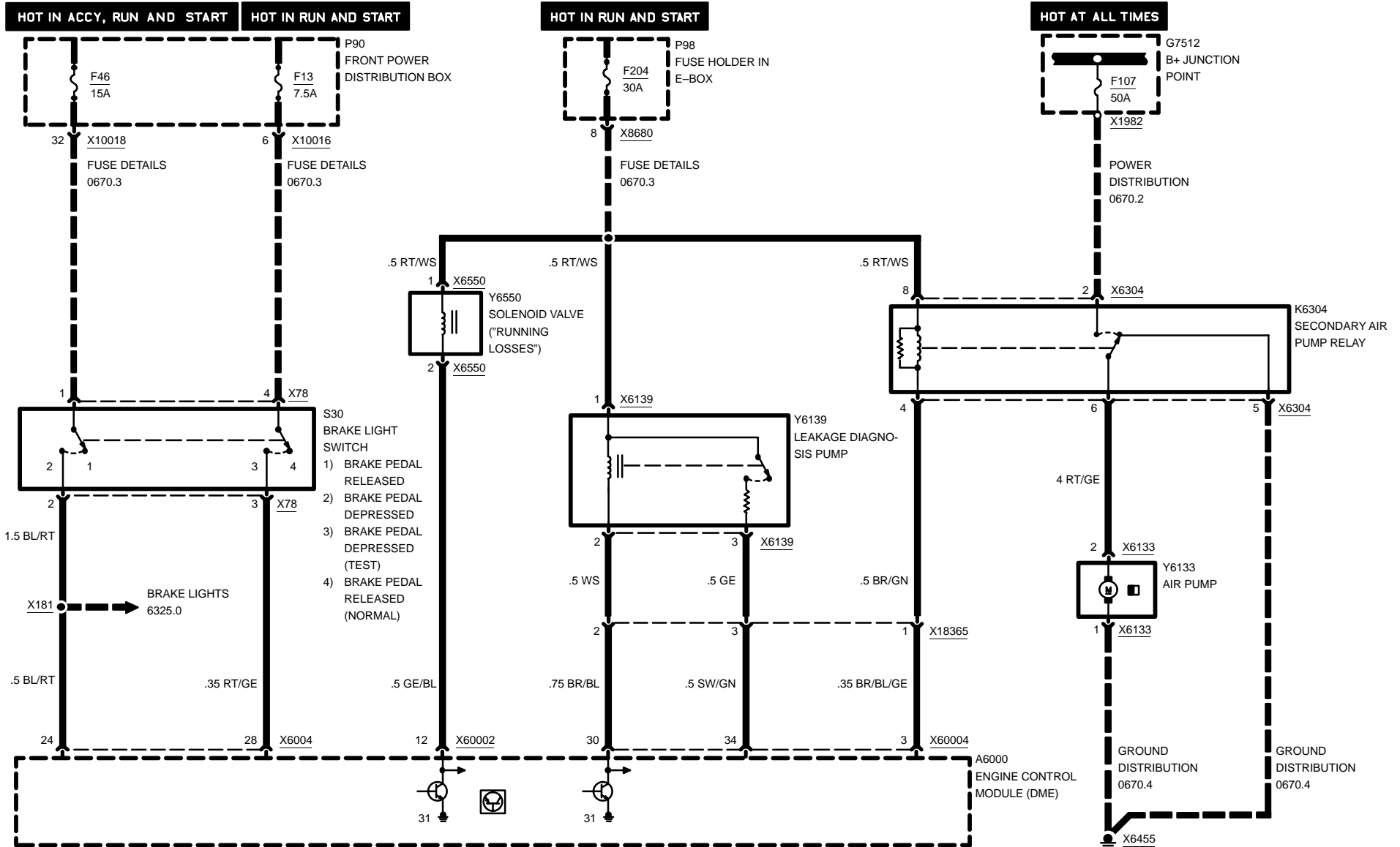

03/00

1210.25-04

1999

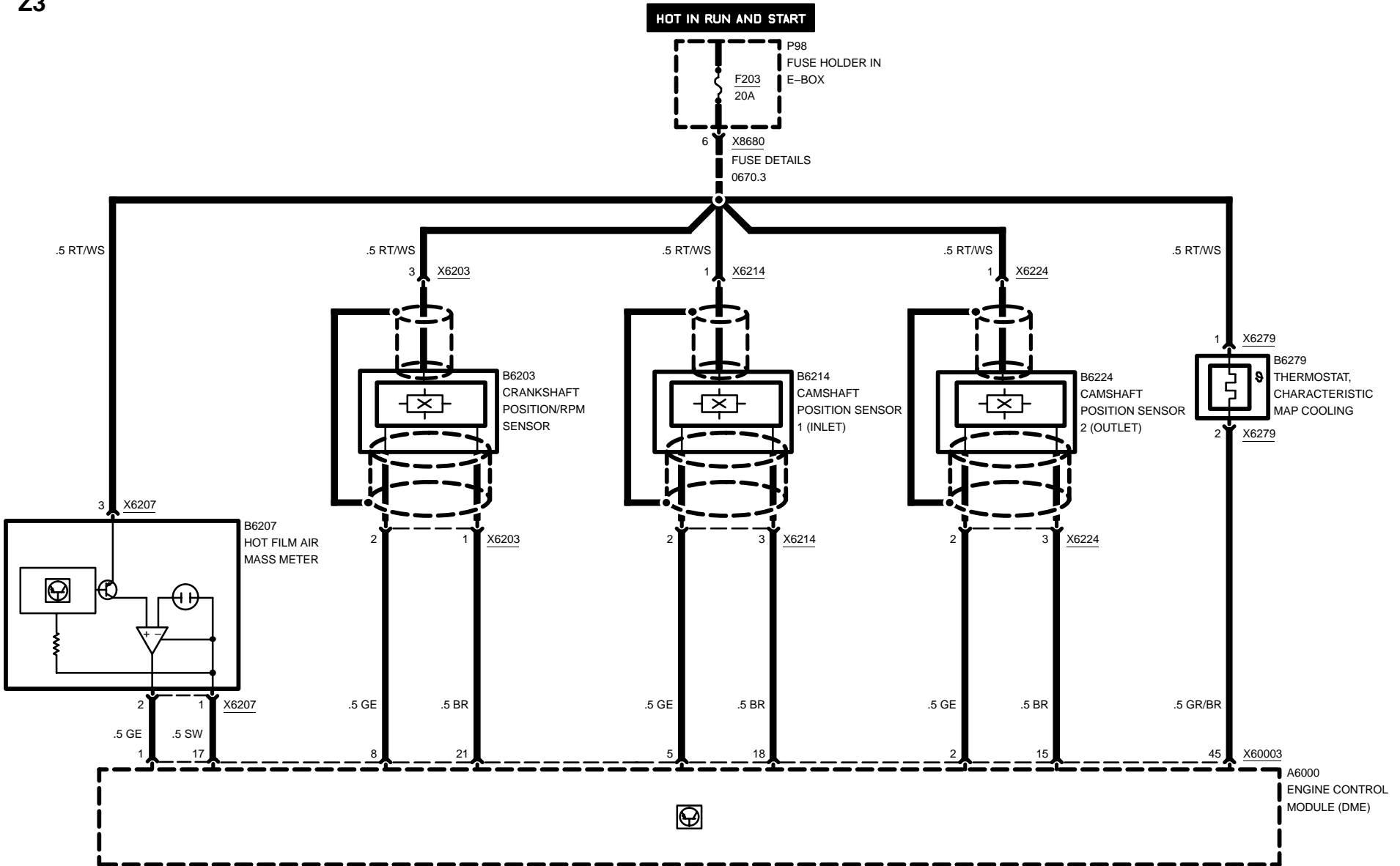



ENGINE CONTROL SYSTEM MS42.1 (6-CYLINDER M52)

Z3 VERSIONS

Z3

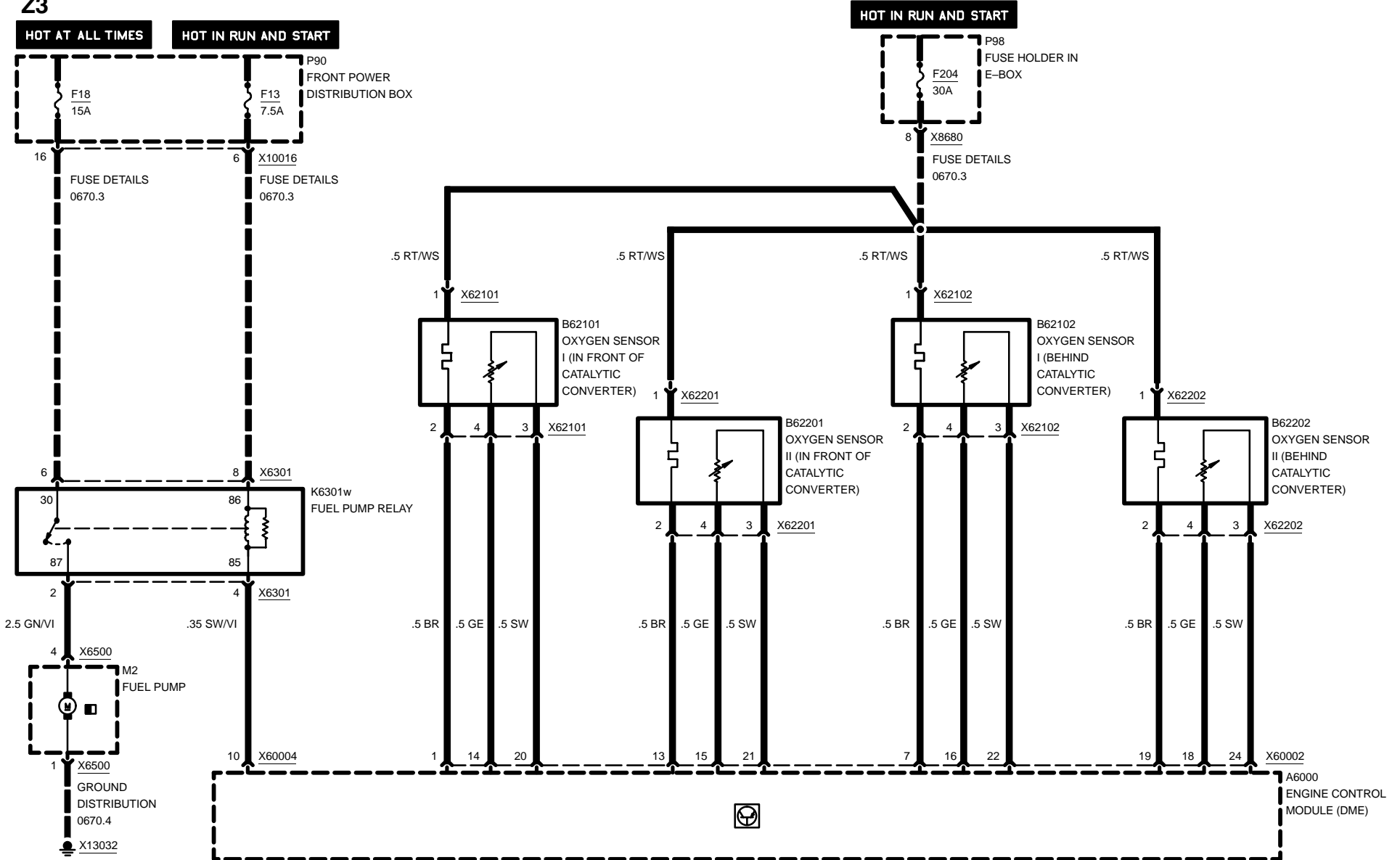

03/00

1210.25-06

1999



ENGINE CONTROL SYSTEM MS42.1 (6-CYLINDER M52)

Z3 VERSIONS

Z3

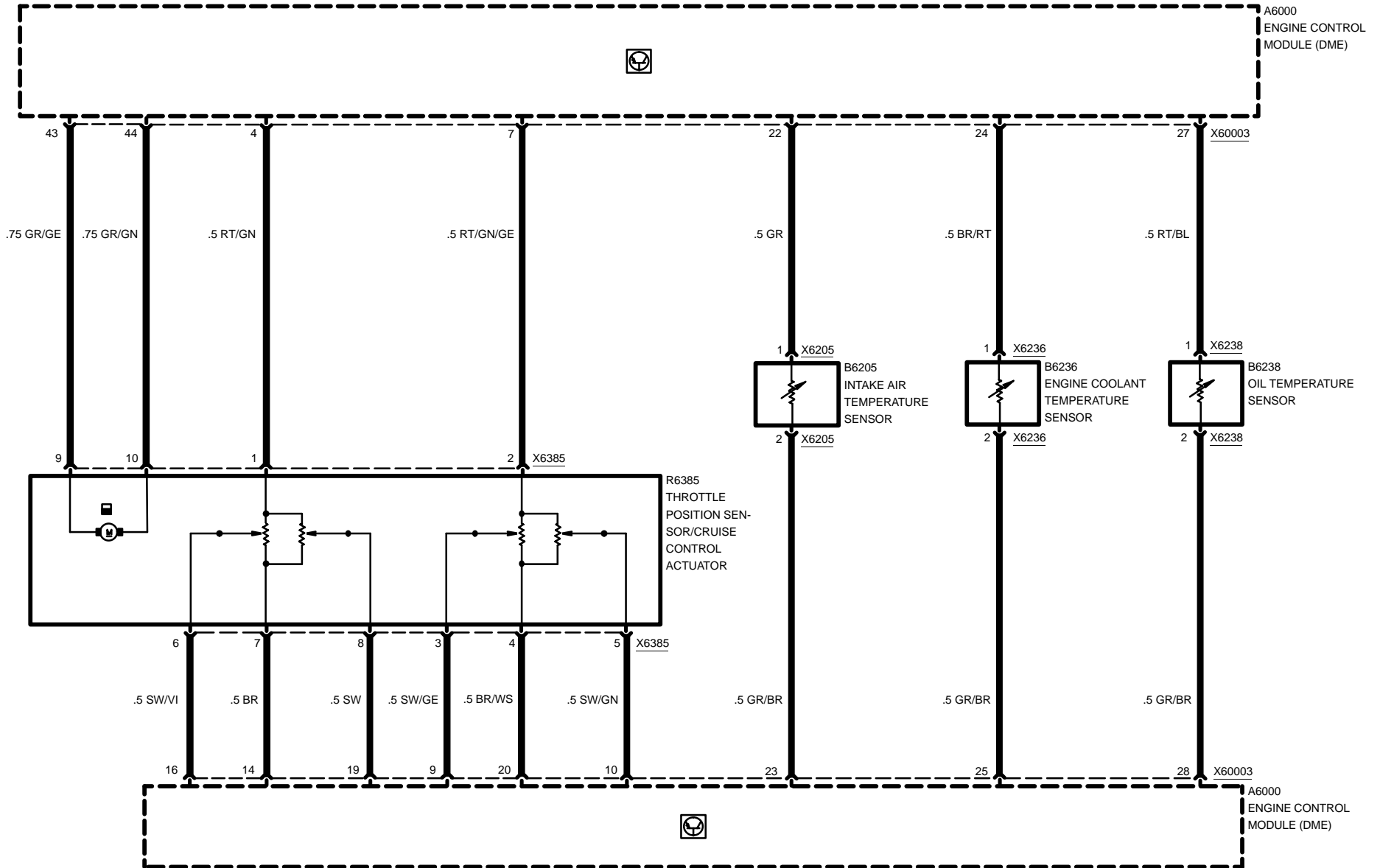

03/00

1210.25-07

1999

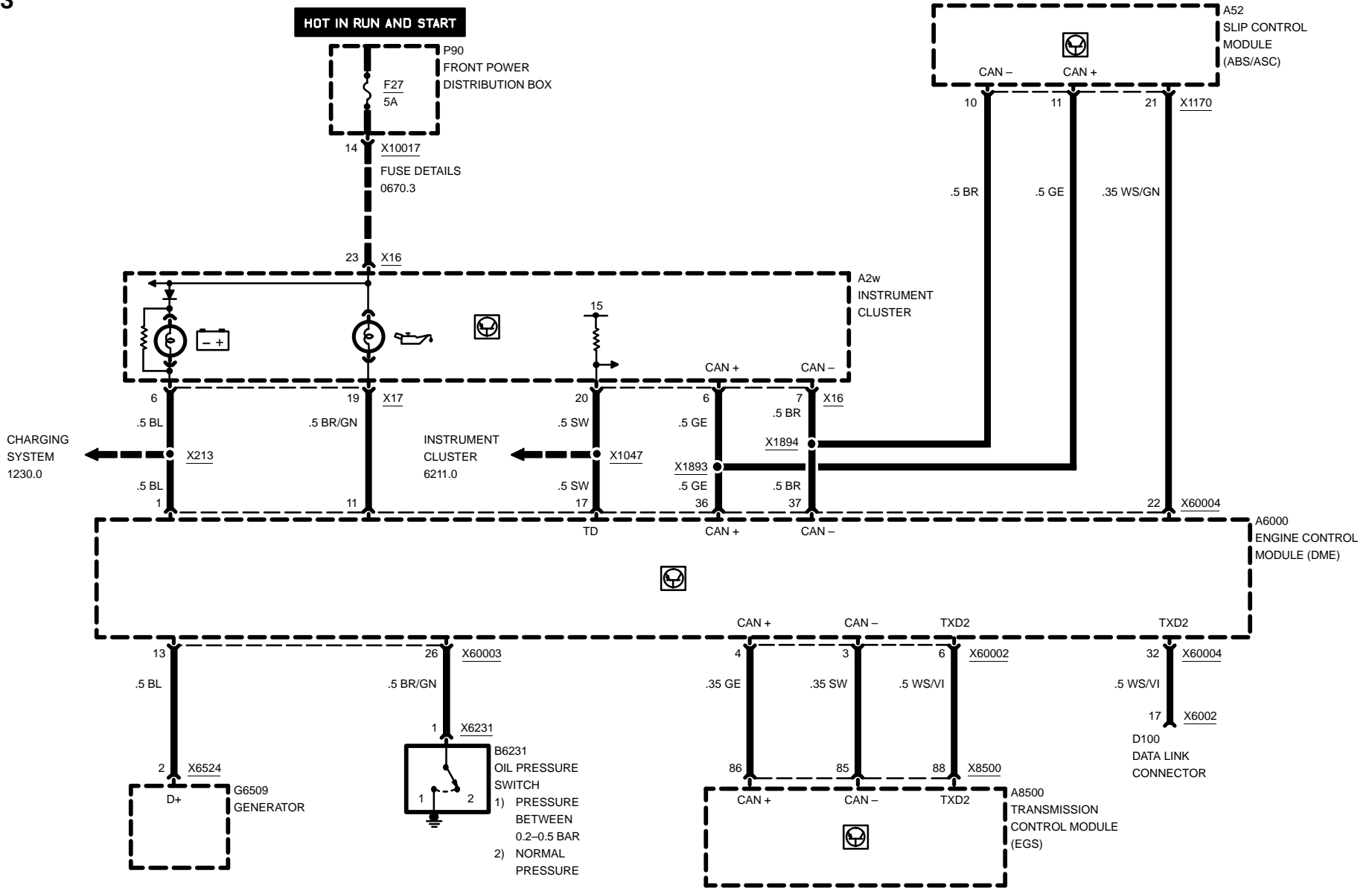

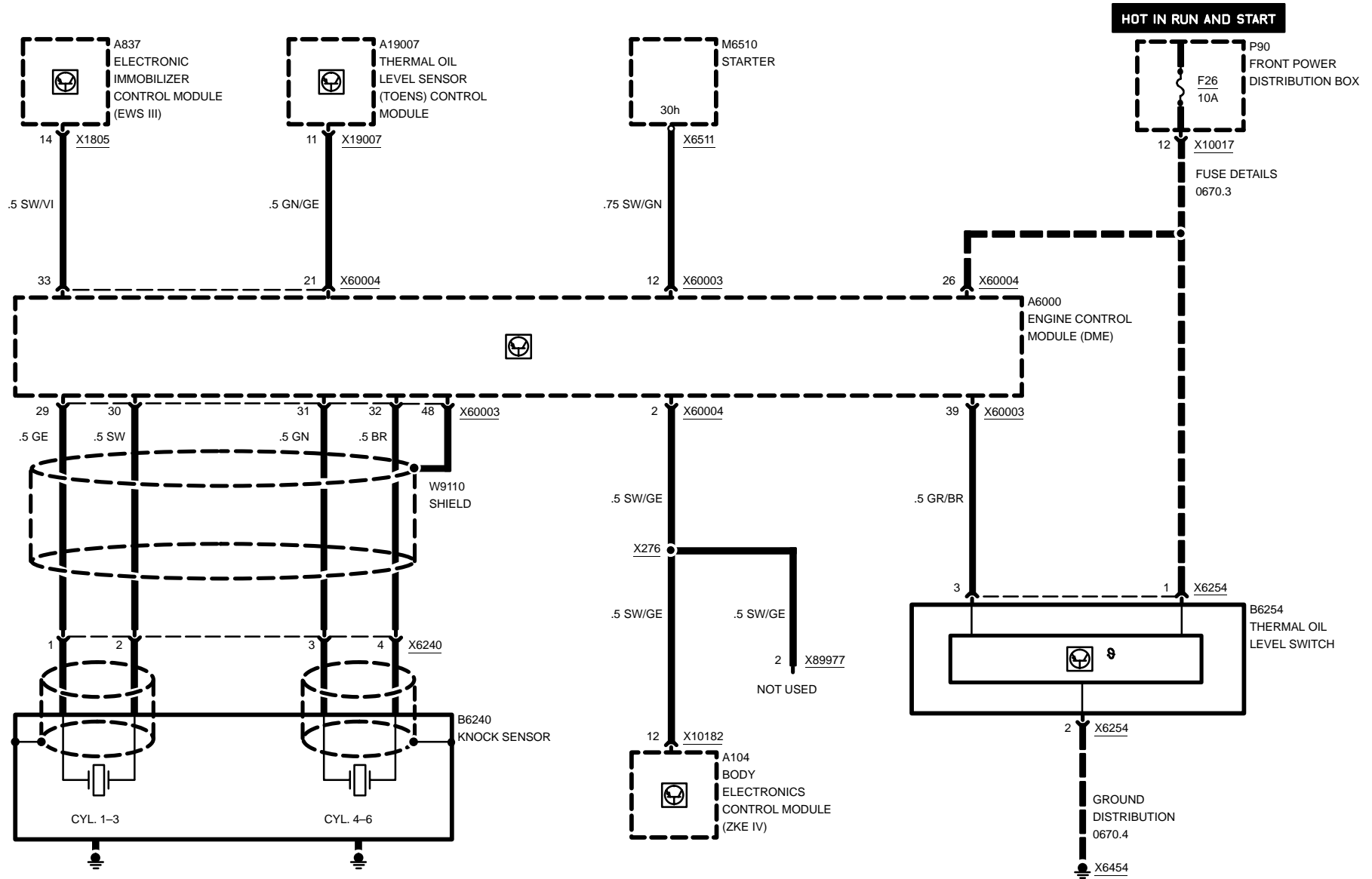



Z3

1230.0 CHARGING SYSTEM

M VERSIONS

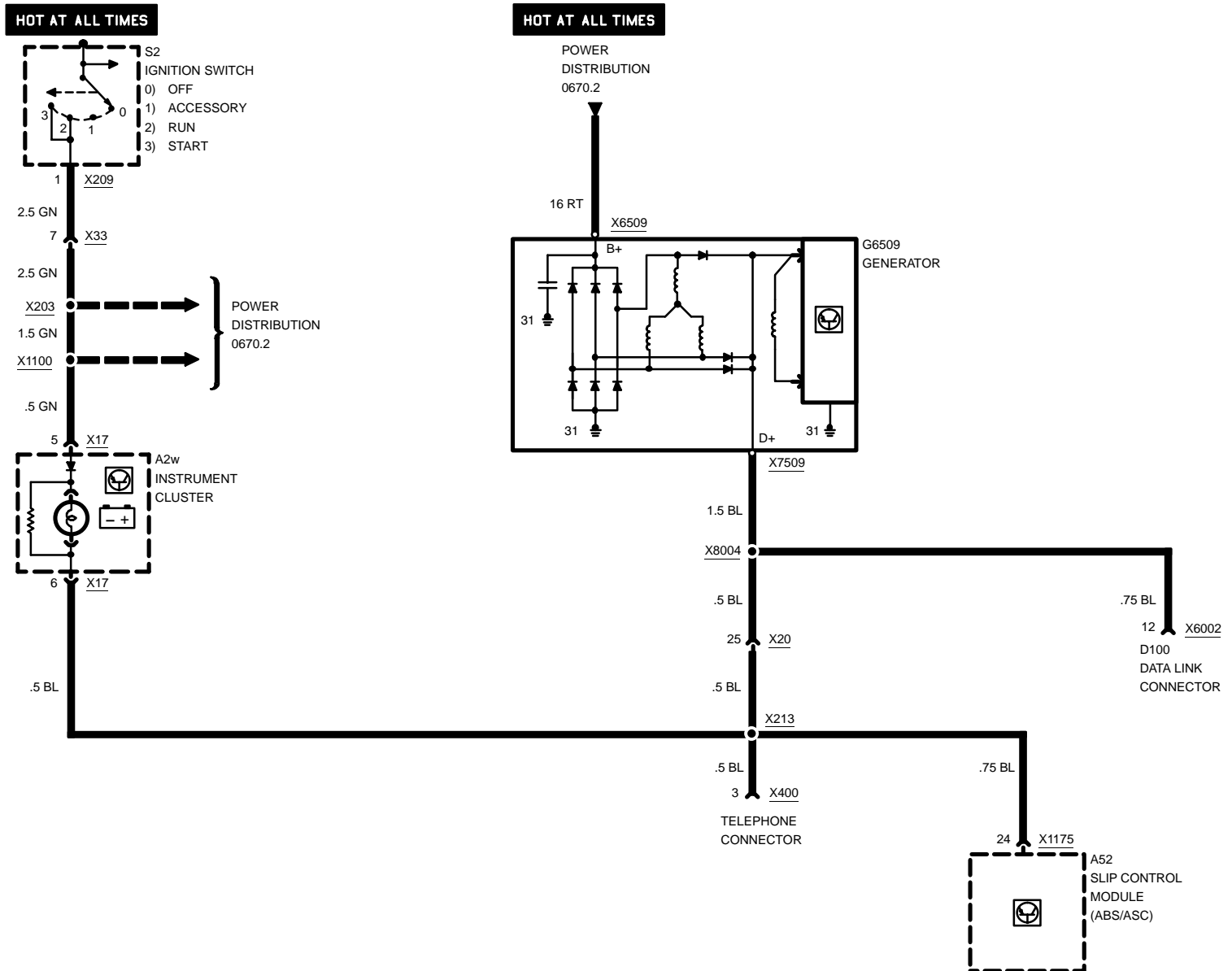

03/00

1230.0-00

1999



CHARGING SYSTEM

Z3 VERSIONS

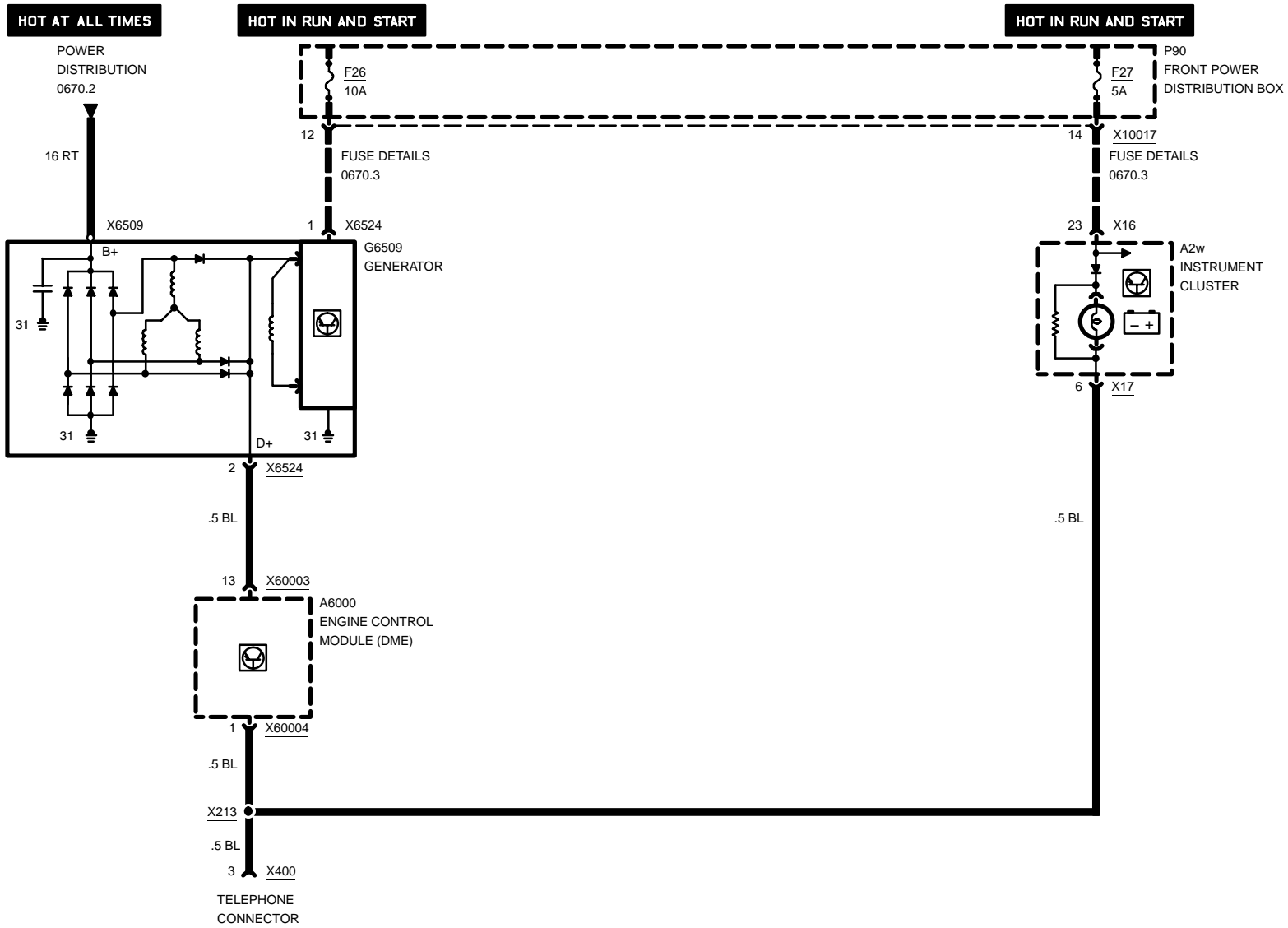

03/00

1230.0-01

1999

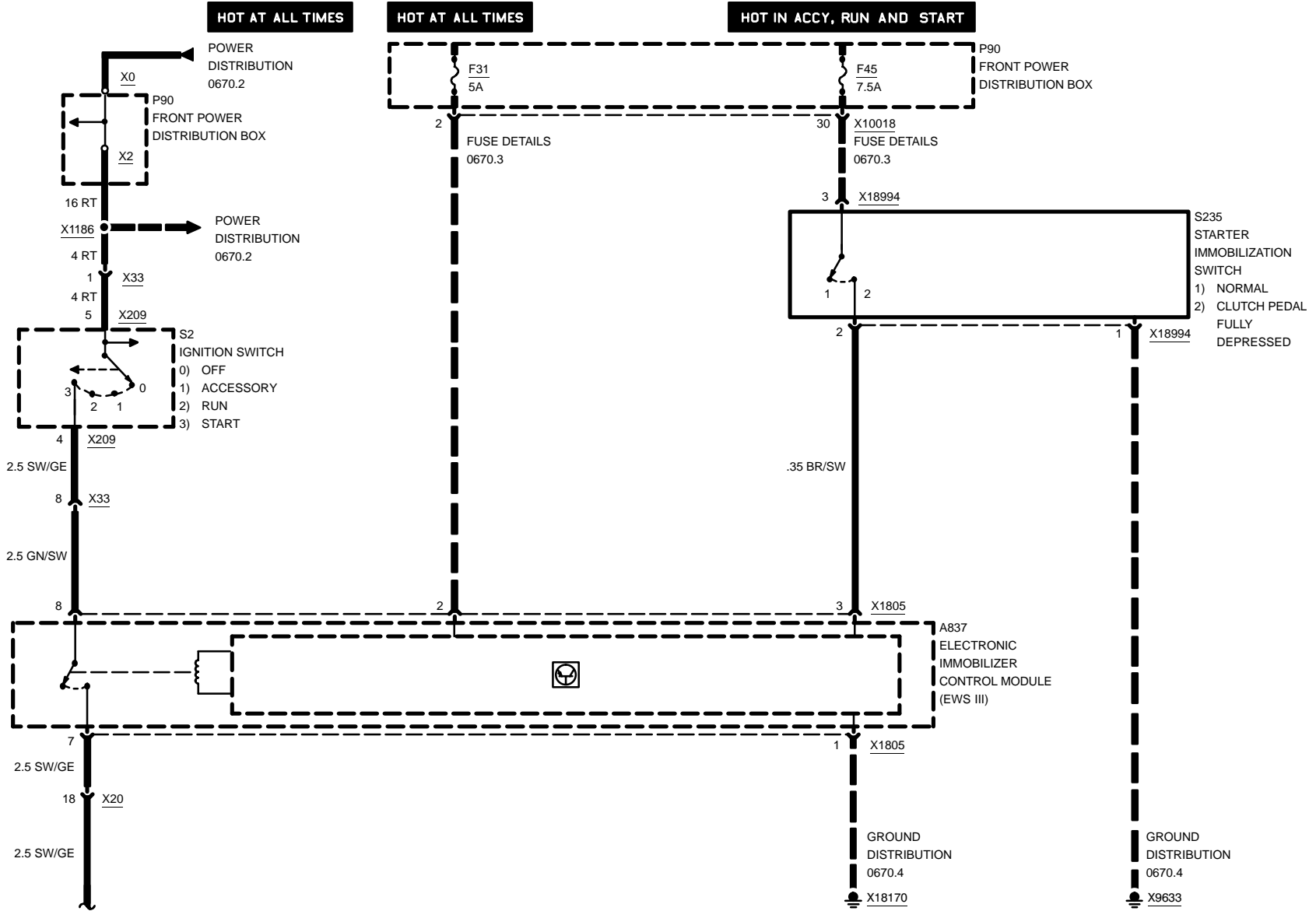

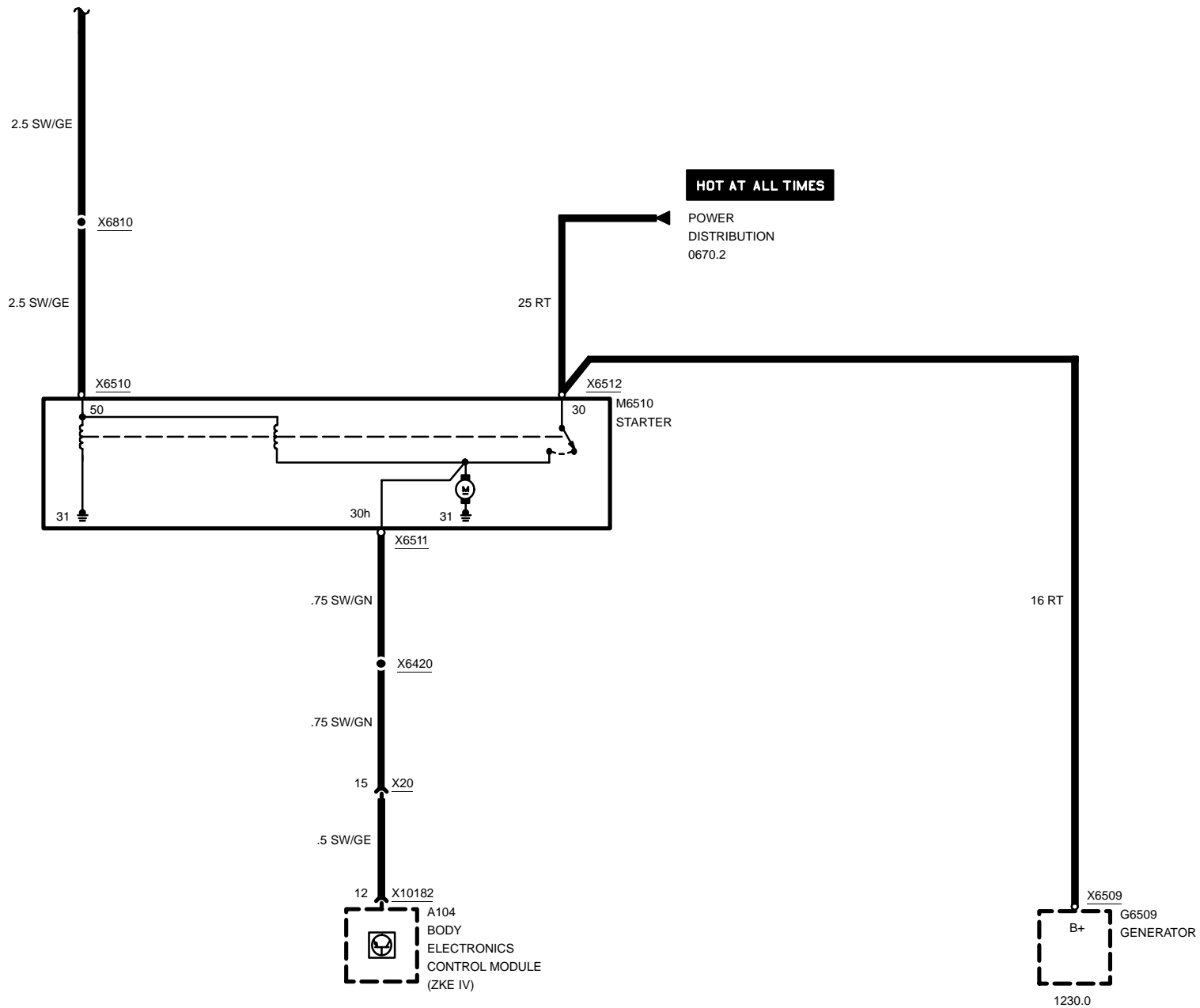

03/00 ————— 1240.0-01 ————— 1999

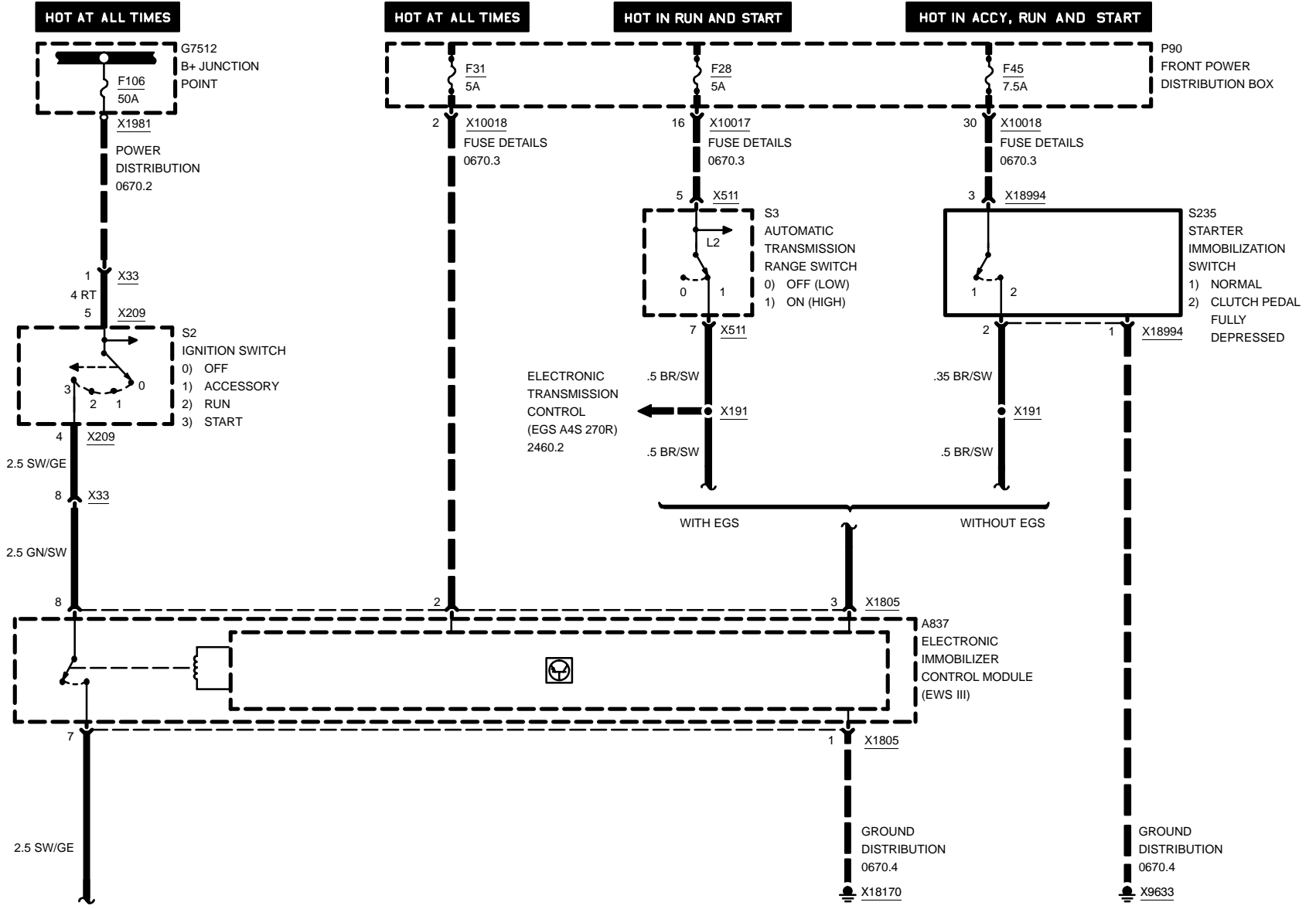

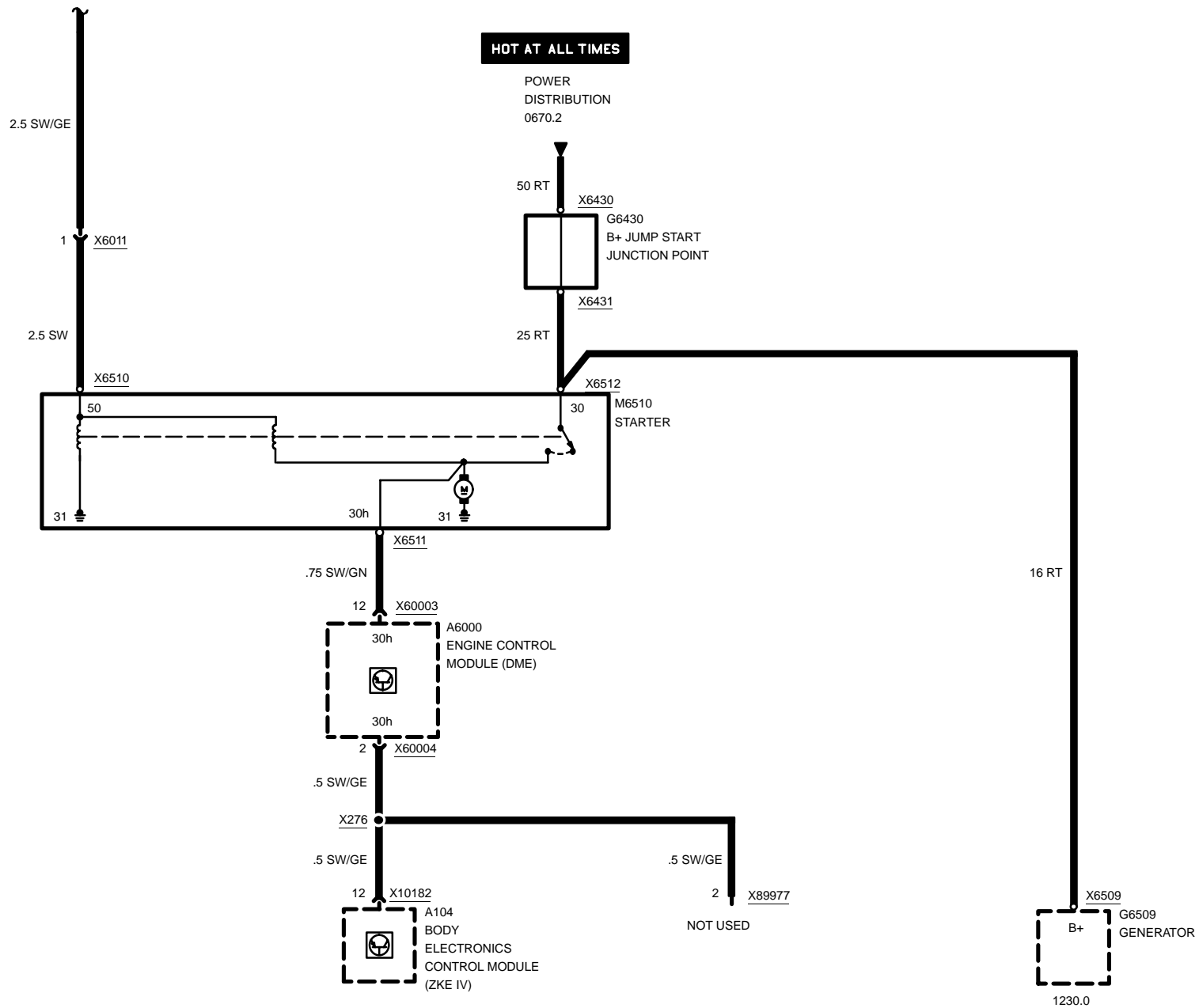

03/00 ————— 1240.0-03 ————— 1999

1290.0 E-BOX FAN

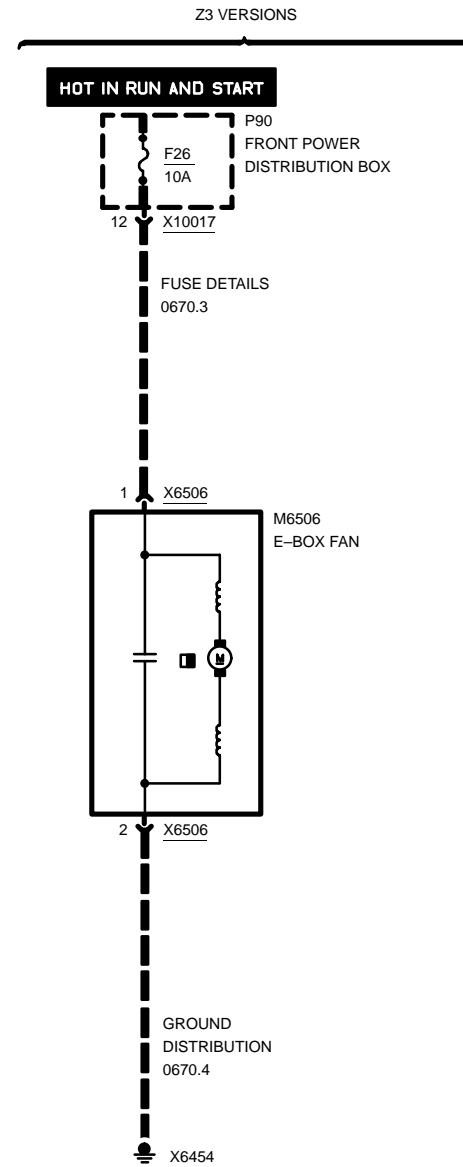
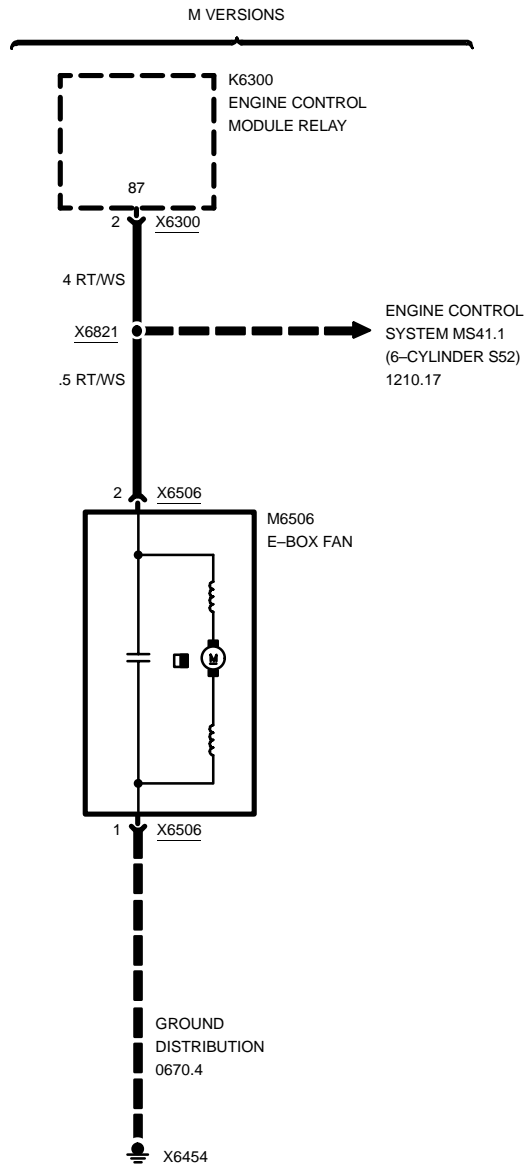

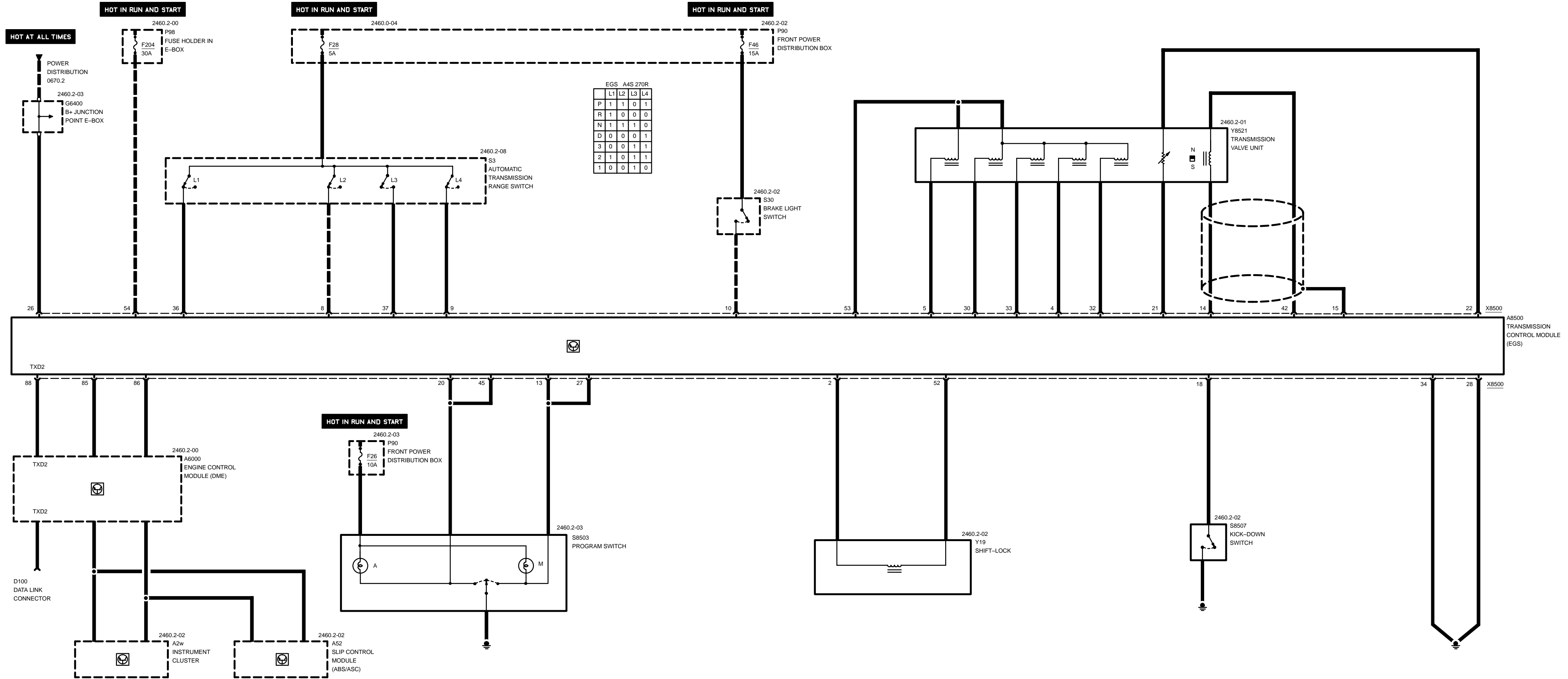

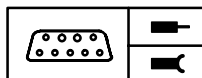

Z3

**Pin Assignments****X8500**

Pin	Type	Description/Function	Connection
10		Not used	
11	M	Ground	Shift-lock
12		Not used	
13	A	Solenoid valve 3 control (-)	Transmission valve unit
14	A	Hydraulic pressure regulator control (-)	Transmission valve unit
15		Not used	
16		Not used	
17	E	Gear range signal L2	Automatic transmission range switch
18	E	Gear range signal L4	Automatic transmission range switch
19	E	Brake pedal position	Brake light switch
20		Not used	
21		Not used	
22	E	Manual mode signal	Program switch
23	E	Output speed (-)	Transmission valve unit
24	M	Ground for shield	Shield for speed sensor
25		Not used	
26		Not used	
27	E	Kick-down signal	Kick-down switch
28		Not used	
29	E	Automatic mode signal	Program switch
30	E	Oil temperature signal (-)	Transmission valve unit
31	E	Oil temperature signal (+)	Transmission valve unit
32		Not used	
33		Not used	
34		Not used	
35	E	Battery voltage	B+ junction point E-box
36	A	M-program indication	Program switch
37	M	Ground	Ground point
38		Not used	
39	A	Solenoid valve 1 control (-)	Transmission valve unit

E = Input, A = Output, M = Ground

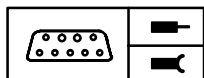

Z3

**Pin Assignments**

Pin	Type	Description/Function	Connection
40		Not used	
41	A	Torque converter clutch solenoid valve control (-)	Transmission valve unit
42	A	Solenoid valve 2 control (-)	Transmission valve unit
43	M	Ground	Ground point
44		Not used	
45	E	Gear range signal L1	Automatic transmission range switch
46	E	Gear range signal L3	Automatic transmission range switch
47		Not used	
48		Not used	
49		Not used	
50		Not used	
51	E	Output speed (+)	Transmission valve unit
52		Not used	
53		Not used	
54	A	A-program indication	Program switch
55		Not used	
56		Not used	
57		Not used	
58		Not used	
59		Not used	
60		Not used	
61	A	Shift-lock solenoid control	Shift-lock
62	A	Voltage solenoid valves	Transmission valve unit
63	E	Voltage supply	Fuse 204
64		Not used	
65		Not used	
66		Not used	
67		Not used	
68		Not used	
69		Not used	
70		Not used	

E = Input, A = Output, M = Ground



Z3

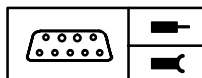

Pin Assignments

Pin	Type	Description/Function	Connection
71		Not used	
72		Not used	
73		Not used	
74		Not used	
75		Not used	
76		Not used	
77		Not used	
78		Not used	
79		Not used	
80		Not used	
81		Not used	
82		Not used	
83		Not used	
84		Not used	
85		Not used	
86		Not used	
87		Not used	
88		Not used	
89		Not used	
90		Not used	
91		Not used	
92		Not used	
93		Not used	
94	E/A	Can-Low	Engine control module
95	E/A	Can-High	Engine control module
96		Not used	
97	E/A	TxD diagnostic data link	Engine control module

E = Input, A = Output, M = Ground



Z3

ELECTRONIC TRANSMISSION CONTROL (EGS A4S 270R)

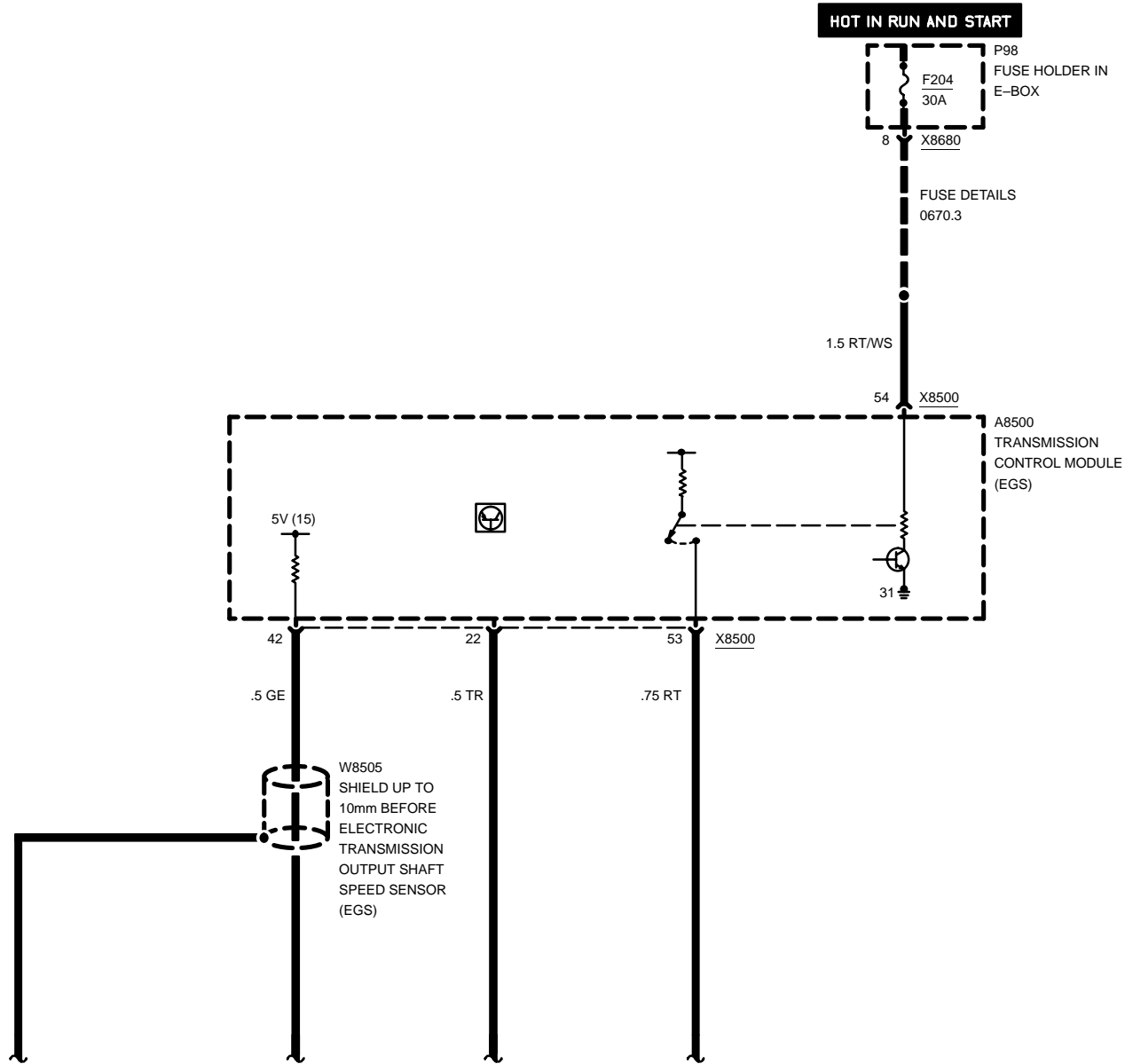

03/00

2460.2-00

1999

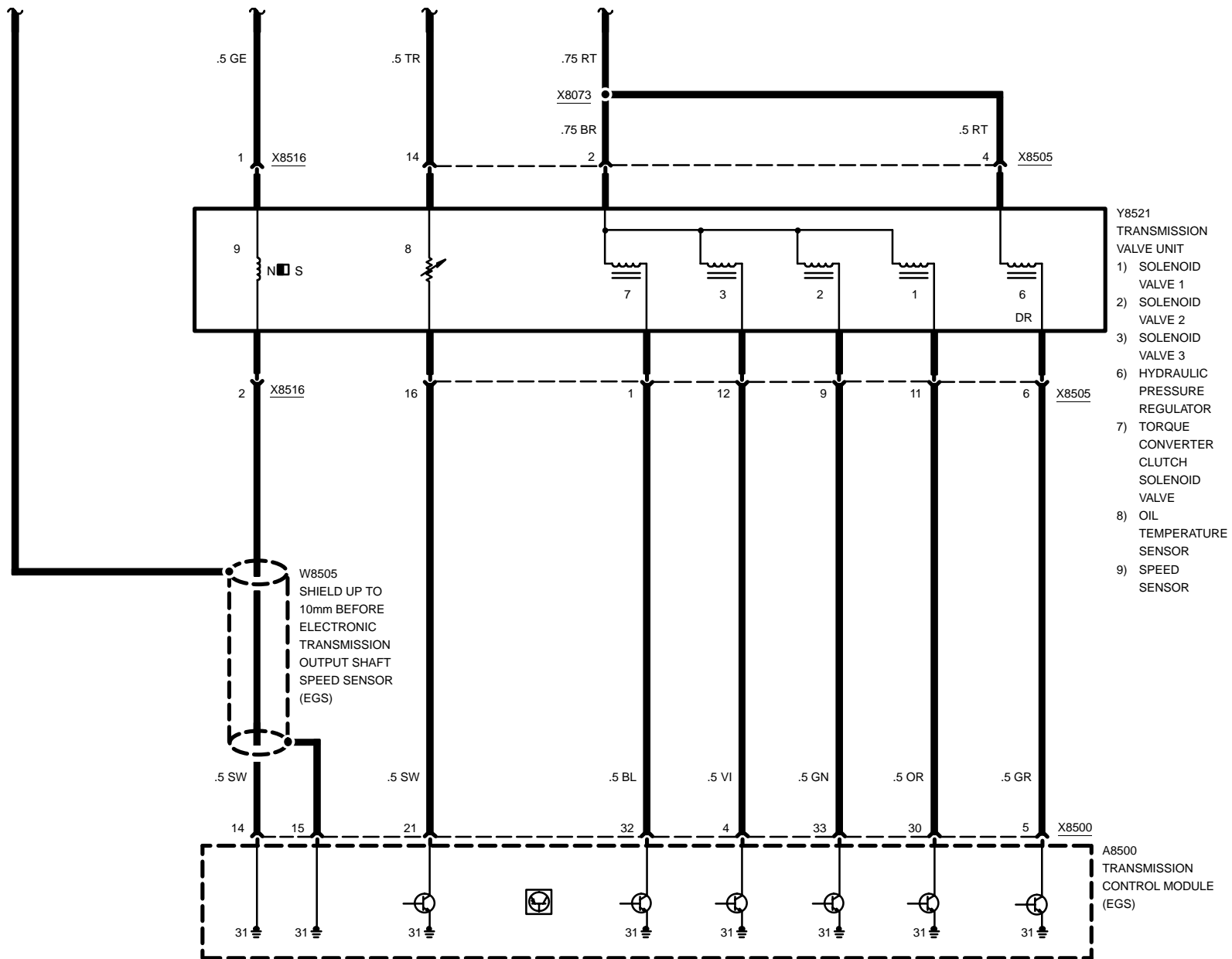



ELECTRONIC TRANSMISSION CONTROL (EGS A4S 270R)

SHIFT LOCK, DATA LINK, KICK-DOWN SWITCH

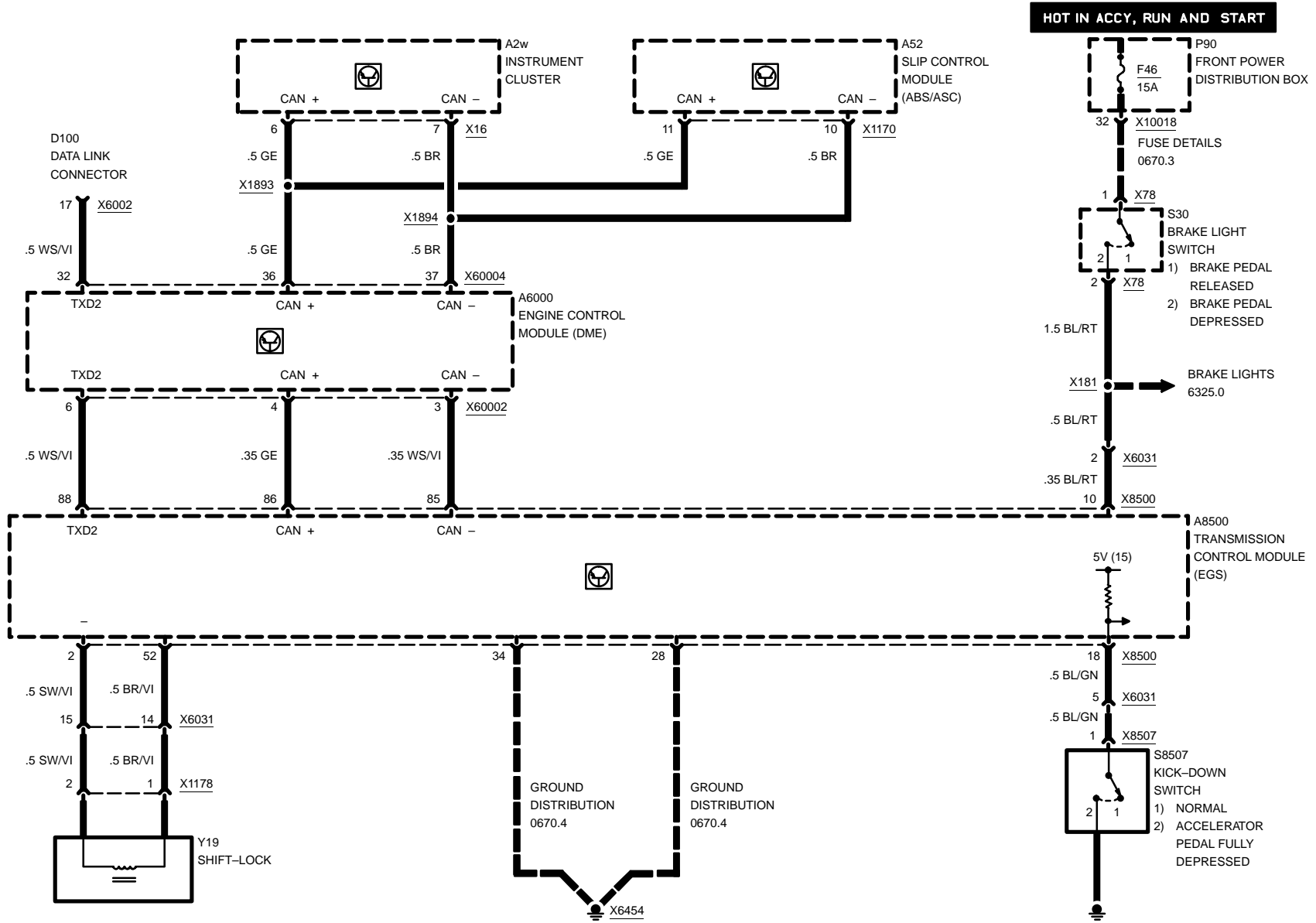

03/00

2460.2-02

1999

ELECTRONIC TRANSMISSION CONTROL (EGS A4S 270R)

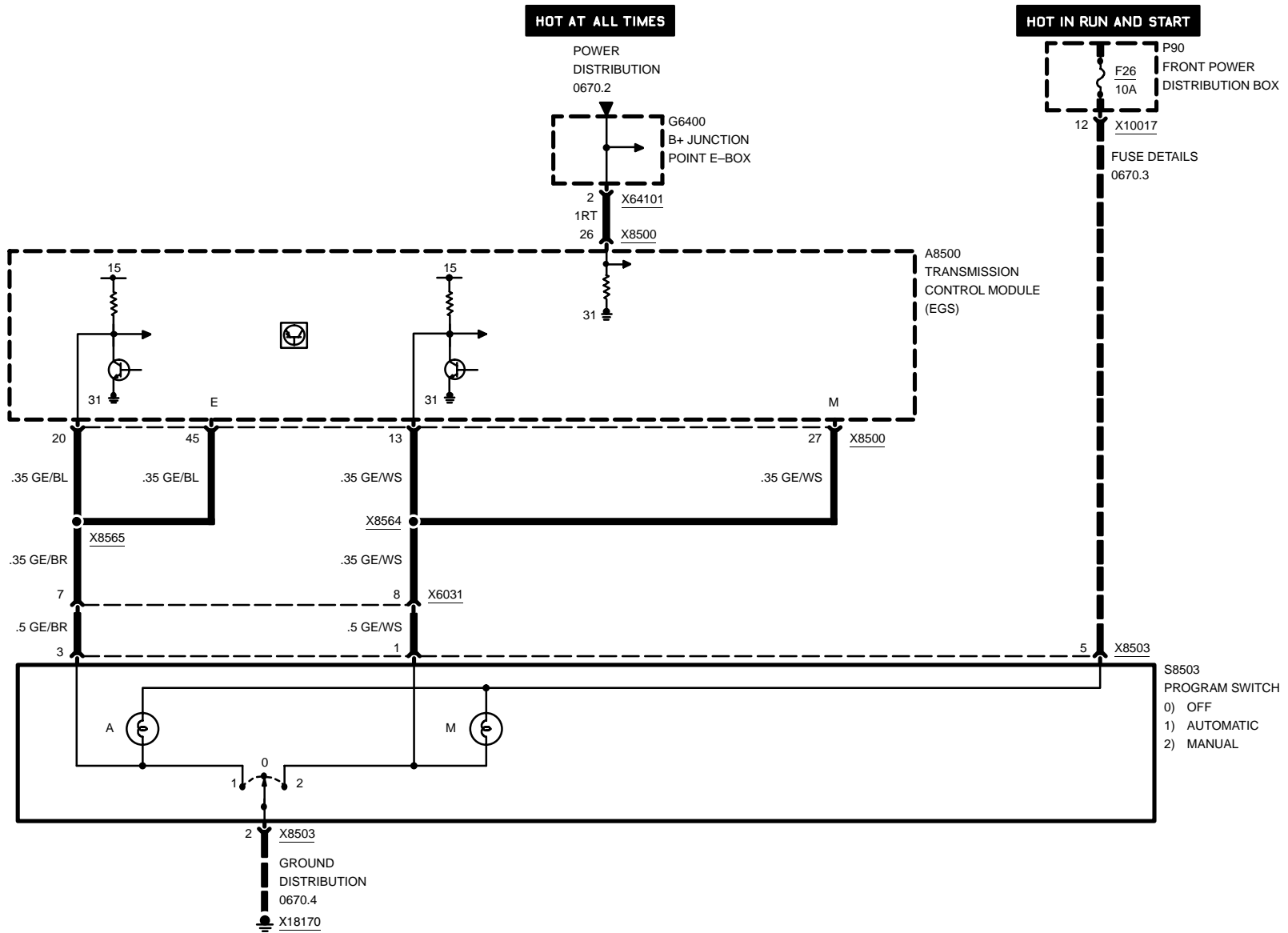

ELECTRONIC TRANSMISSION CONTROL (EGS A4S 270R)

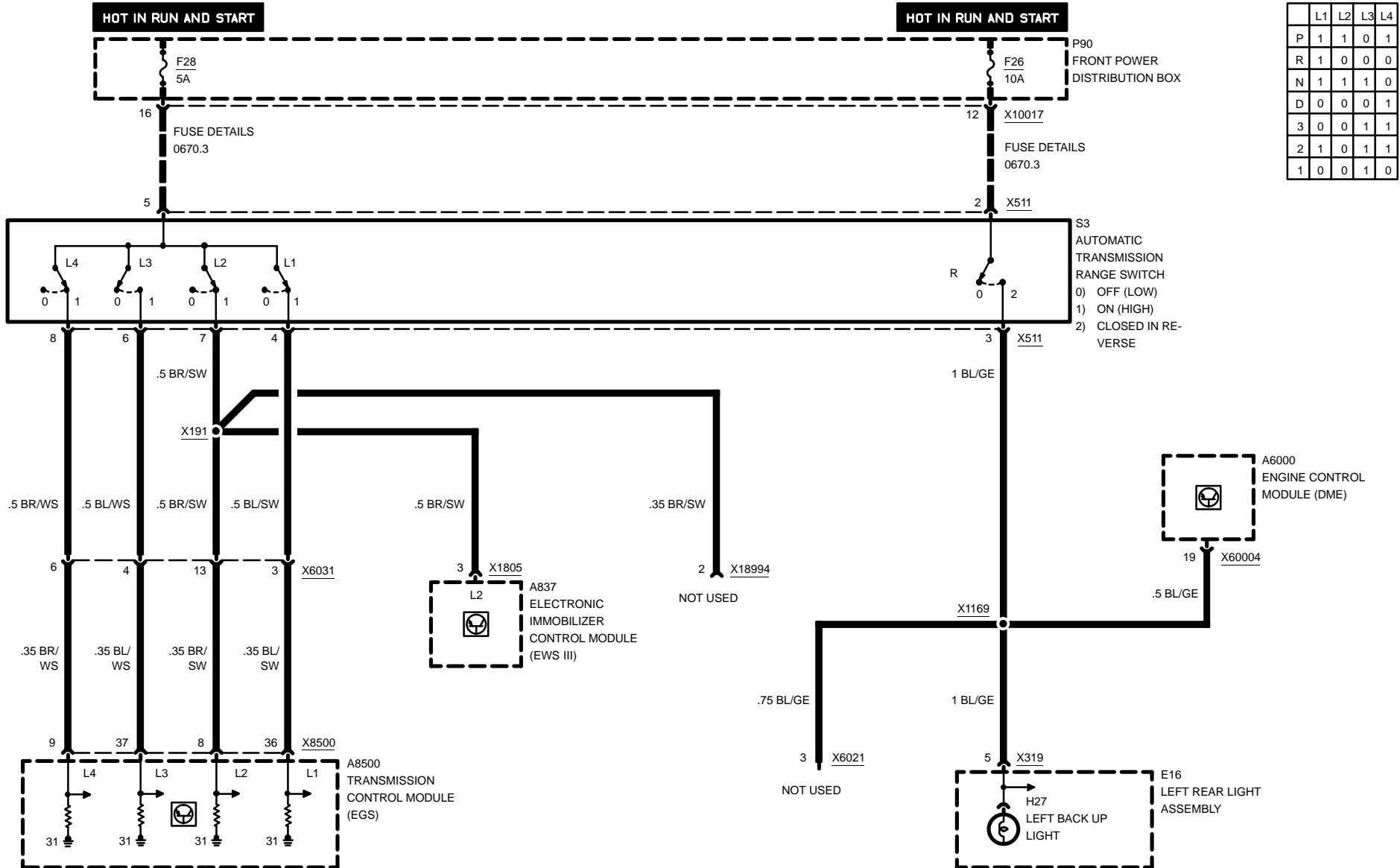

	L1	L2	L3	L4
P	1	1	0	1
R	1	0	0	0
N	1	1	1	0
D	0	0	0	1
3	0	0	1	1
2	1	0	1	1
1	0	0	1	0

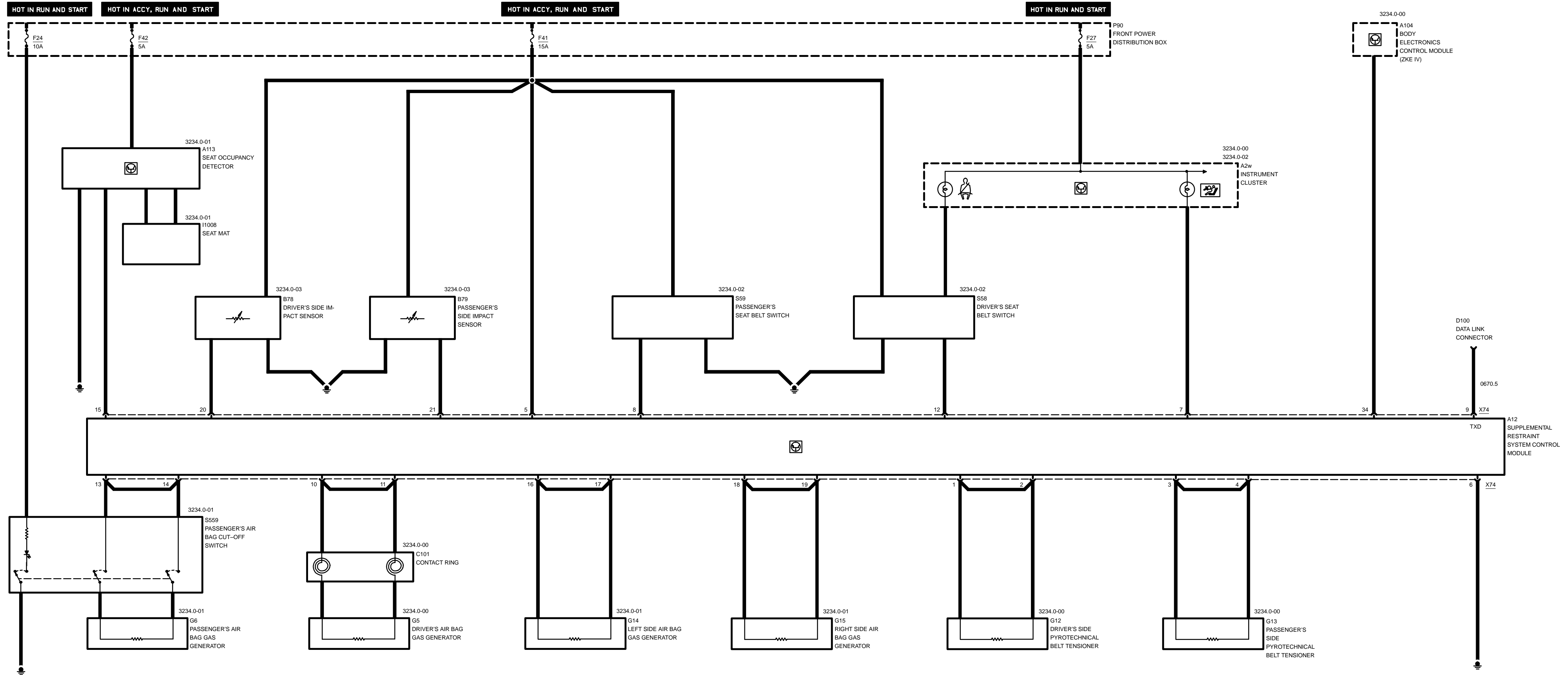

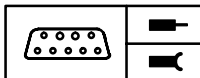

Z3

**Pin Assignments****X74**

Pin	Type	Description/Function	Connection
1	A	Pyrotechnical belt tensioner (+)	Driver's side pyrotechnical belt tensioner
2	A	Pyrotechnical belt tensioner (-)	Driver's side pyrotechnical belt tensioner
3	A	Pyrotechnical belt tensioner (+)	Passenger's side pyrotechnical belt tensioner
4	A	Pyrotechnical belt tensioner (-)	Passenger's side pyrotechnical belt tensioner
5	E	Power supply	Front power distribution box, fuse 41
6	M	Ground	Ground point
7	A	Air bag warning indicator	Instrument cluster
8	E	Belt switch	Passenger's seat belt switch
9	E/A	TxD diagnostic data line	Data link connector
10	A	Air bag (+)	Driver's air bag gas generator
11	A	Air bag (-)	Driver's air bag gas generator
12	E	Belt switch	Driver's seat belt switch
13	A	Air bag (+)	Passenger's air bag gas generator
14	A	Air bag (-)	Passenger's air bag gas generator
15	E	Seat occupancy detector	Seat occupancy detector
16	A	Gas generator	Gas generator, left side air bag
17	A	Gas generator	Gas generator, left side air bag
18	A	Gas generator	Gas generator, right side air bag
19	A	Gas generator	Gas generator, right side air bag
20	E	Impact sensor	Driver's side impact sensor
21	E	Impact sensor	Passenger's side impact sensor
22		Not used	
23		Not used	
24		Not used	
25		Not used	
26		Not used	
27		Not used	
28		Not used	
29		Not used	

E = Input, A = Output, M = Ground



Z3

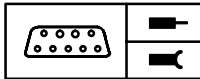

Pin Assignments

Pin	Type	Description/Function	Connection
30		Not used	
31		Not used	
32		Not used	
33		Not used	
34	A	Crash signal	Body electronics control module (ZKE IV)
35		Not used	
36		Not used	
37		Not used	
38		Not used	
39		Not used	
40		Not used	
41		Not used	
42		Not used	
43		Not used	
44		Not used	
45		Not used	
46		Not used	
47		Not used	
48		Not used	
49		Not used	
50		Not used	

E = Input, A = Output, M = Ground



SUPPLEMENTAL RESTRAINT SYSTEM (AIR BAG)

Z3

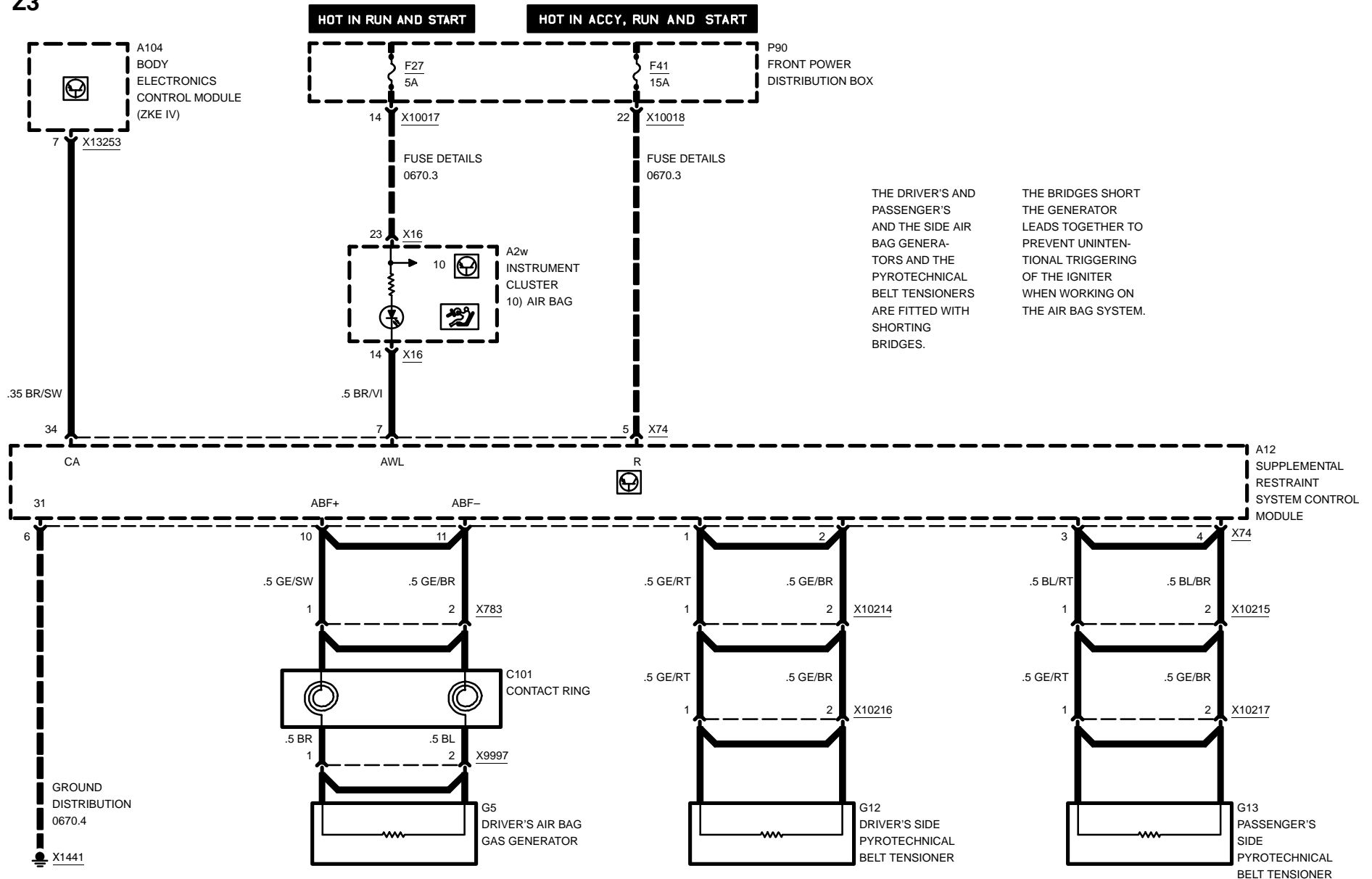

03/00

3234.0-00

1999

SUPPLEMENTAL RESTRAINT SYSTEM (AIR BAG)

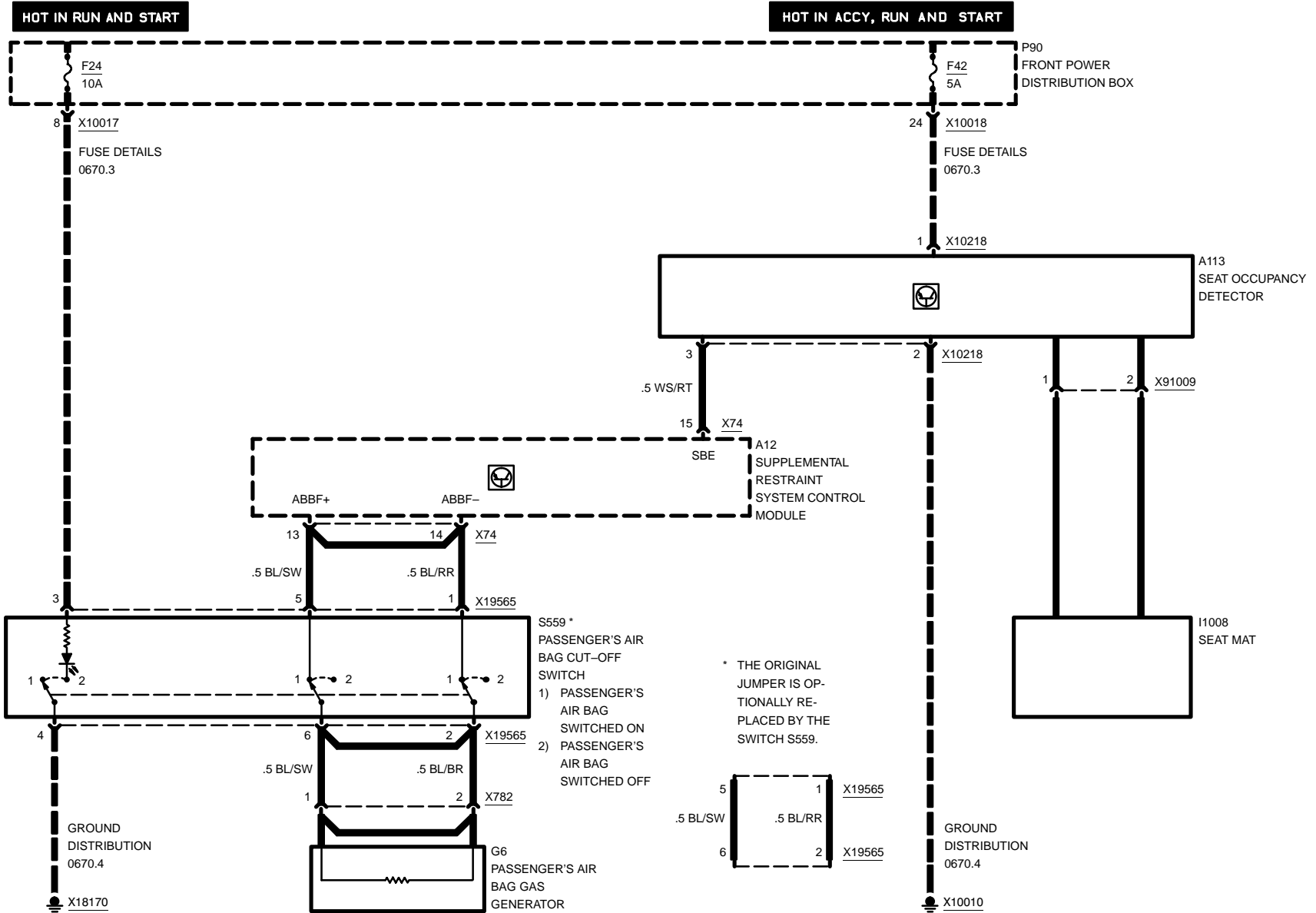

SUPPLEMENTAL RESTRAINT SYSTEM (AIR BAG)

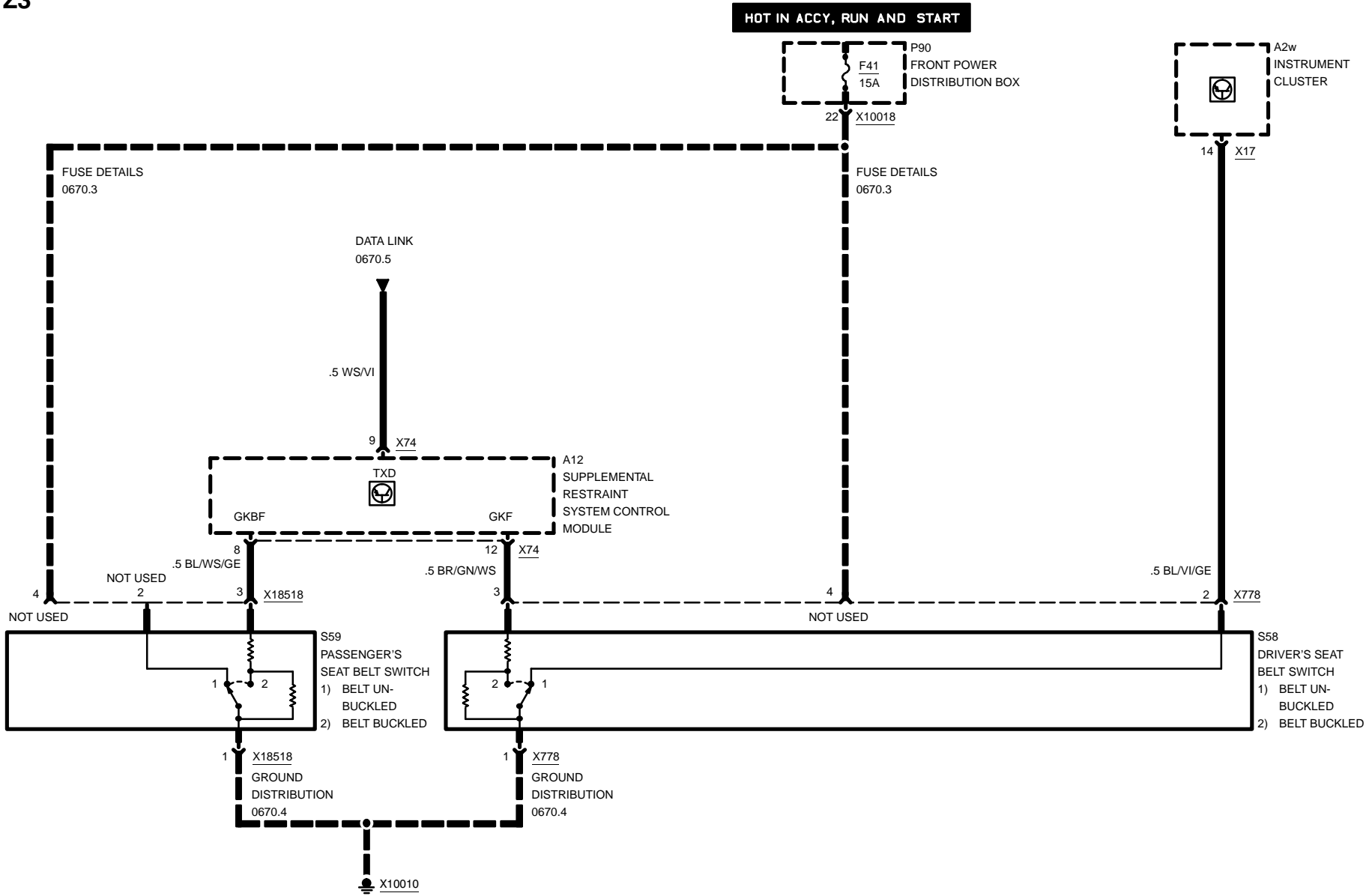

SUPPLEMENTAL RESTRAINT SYSTEM (AIR BAG)

SIDE AIR BAG

HOT IN ACCY, RUN AND START

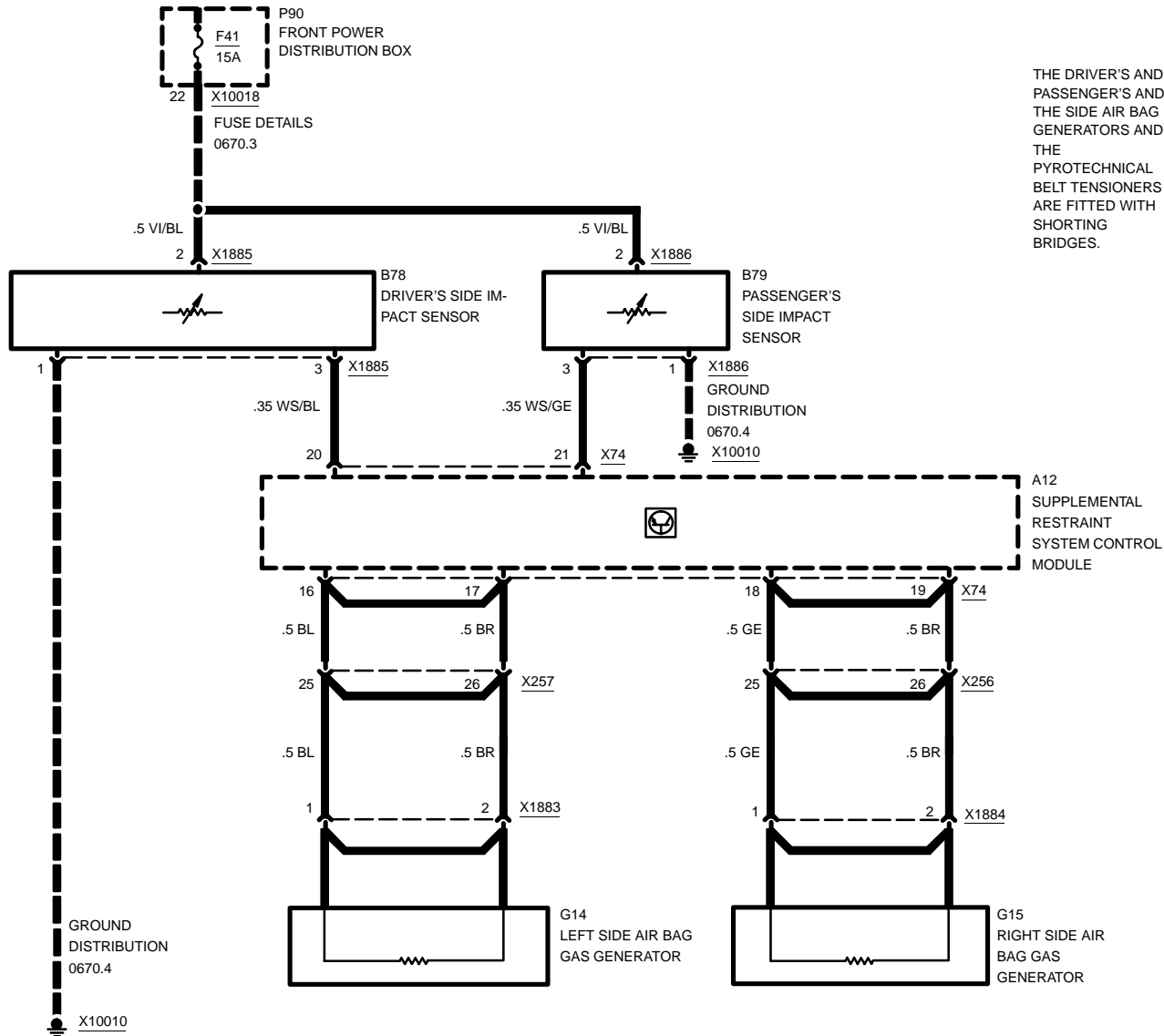

THE DRIVER'S AND PASSENGER'S AND THE SIDE AIR BAG GENERATORS AND THE PYROTECHNICAL BELT TENSIONERS ARE FITTED WITH SHORTING BRIDGES.

THE BRIDGES SHORT THE GENERATOR LEADS TOGETHER TO PREVENT UNINTENTIONAL TRIGGERING OF THE IGNITER WHEN WORKING ON THE AIR BAG SYSTEM.

M VERSIONS

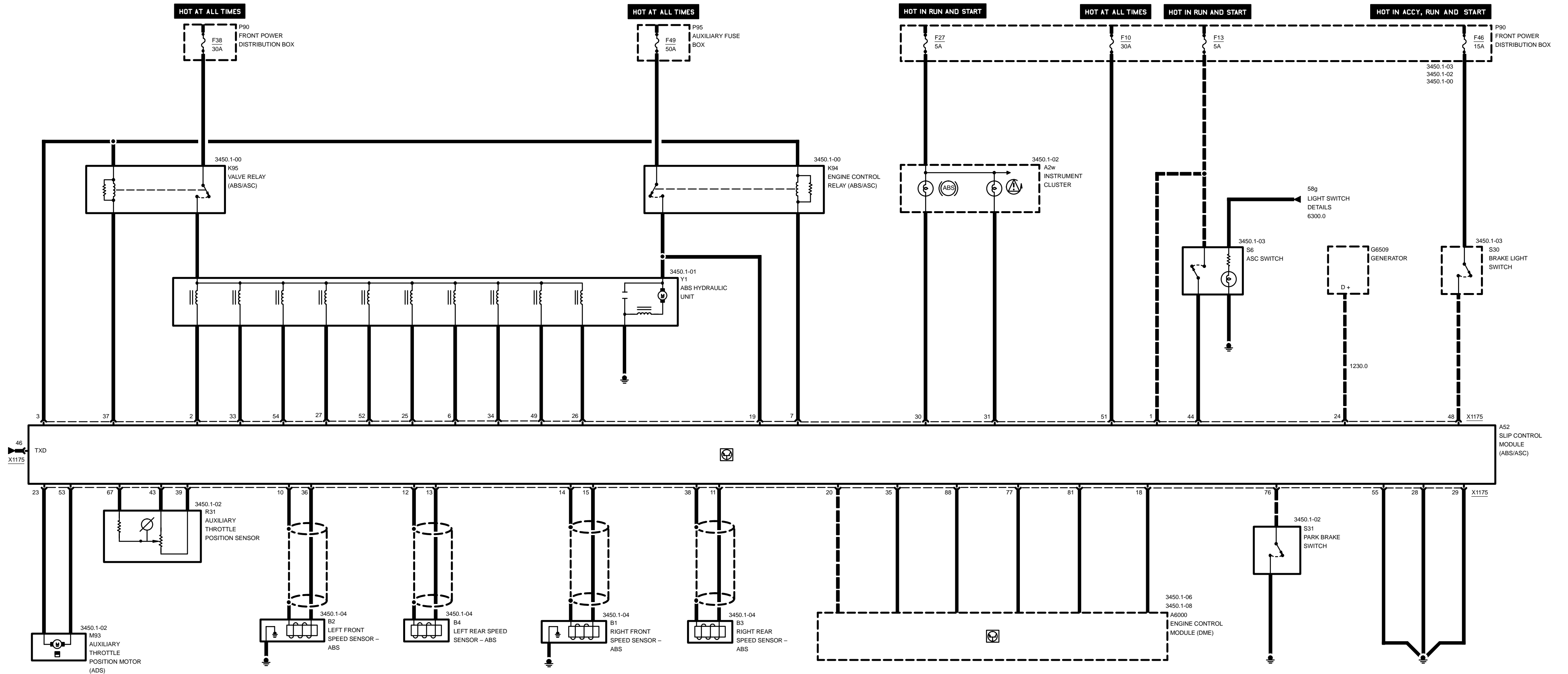

Z3 VERSIONS

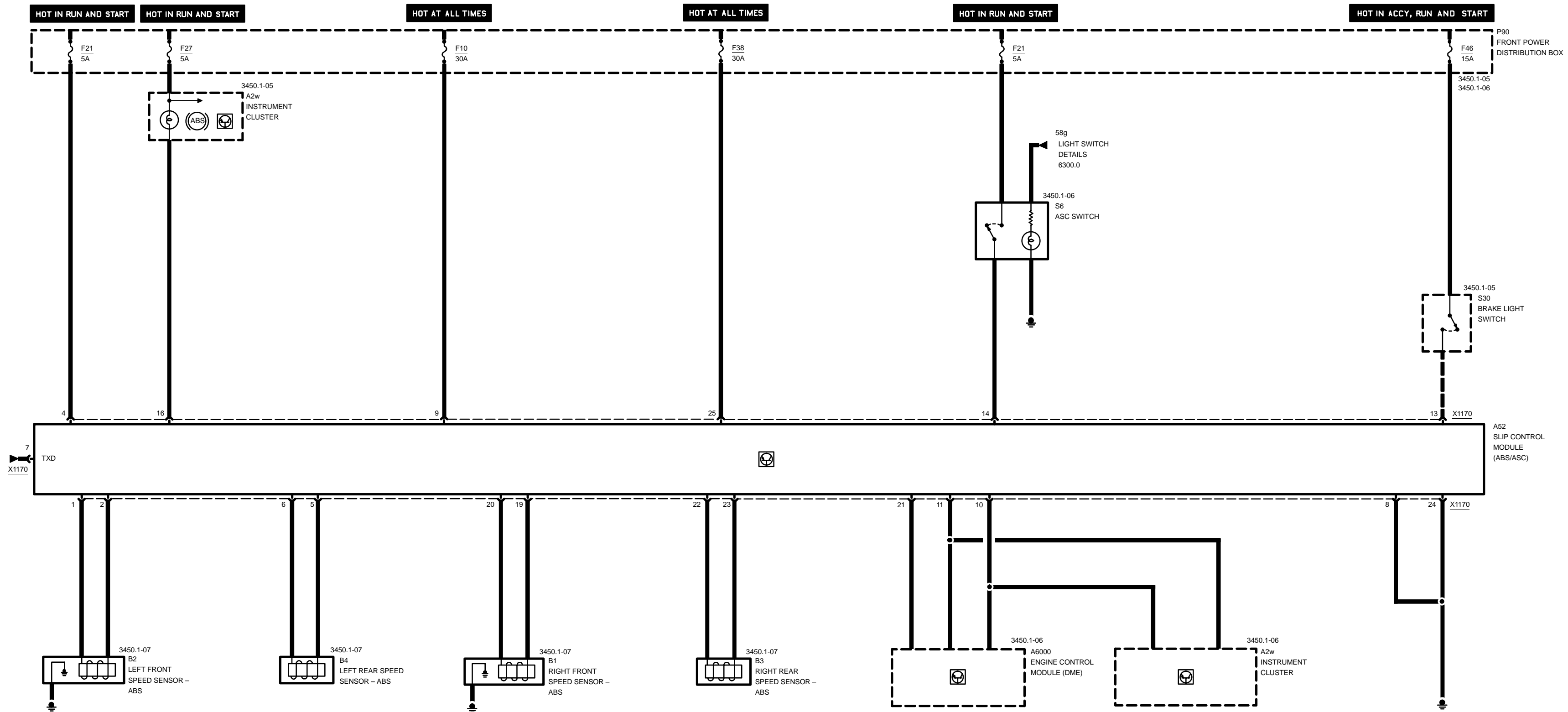

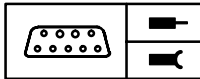

Z3

**Pin Assignments****X1175**

Pin	Type	Description/Function	Connection
51	E	Voltage supply	Fuse 13
52	A	Left front inlet valve	ABS hydraulic unit
53	A	Voltage supply	Valve – Engine control relay
54		Not used	
55		Not used	
56	A	Right rear inlet valve	ABS hydraulic unit
57	A	Activate relay	Engine control relay
58		Not used	
59		Not used	
60	M	Sensor ground	ABS speed sensor front left
61	E	Speed signal	ABS speed sensor rear right
62	M	Sensor ground	ABS speed sensor rear left
63	E	Speed signal	ABS speed sensor rear left
64	M	Sensor ground	ABS speed sensor front right
65	E	Speed signal	ABS speed sensor front right
66		Not used	
67		Not used	
68	E	Engine signal 1	Engine control module (DME)
69	E	Relay activation feedback	Engine control relay
70	E	Speed signal	Engine control module (DME)
71		Not used	
72		Not used	
73	A	ADS step motor (+)	ADS step motor
74	E	Charge indicator	Generator
75	A	Left rear outlet valve	ABS hydraulic unit
76	A	Shut-off valve (ASC)	ABS hydraulic unit
77	A	Right front outlet valve	ABS hydraulic unit
78	M	Ground	Ground point
79	M	Ground	Ground point
80	A	ABS lamp control	Instrument cluster

E = Input, A = Output, M = Ground

Z3

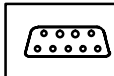

Pin Assignments

Pin	Type	Description/Function	Connection
81	A	ASC lamp control	Instrument cluster
82		Not used	
83	A	Left front outlet valve	ABS hydraulic unit
84	A	Right rear outlet valve	ABS hydraulic unit
85	A	Right rear speed signal	Engine control module (DME)
86	E	Speed signal	ABS speed sensor front left
87	A	Activate relay	Valve relay
88	M	Sensor ground	ABS speed sensor rear right
89	A	Throttle position sensor (-)	Auxiliary throttle position sensor
90		Not used	
91		Not used	
92		Not used	
93	A	Throttle position sensor (+)	Auxiliary throttle position sensor
94	E	ASC-ON-signal	ASC switch
95		Not used	
96	E/A	TXD signal	Diagnostic link
97		Not used	
98	E	Brake signal	Brake light switch
99	A	Changeover valve (ASC)	ABS hydraulic unit
100		Not used	
101	E	Voltage supply	Fuse 10
102	A	Left rear inlet valve	ABS hydraulic unit
103	A	ADS step motor (-)	ADS step motor
104	A	Right front inlet valve	ABS hydraulic unit
105	M	Ground	Ground point
106		Not used	
107		Not used	
108		Not used	
109		Not used	
110		Not used	
111		Not used	
112		Not used	

E = Input, A = Output, M = Ground



Z3

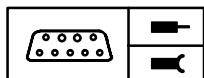

Pin Assignments

Pin	Type	Description/Function	Connection
113		Not used	
114		Not used	
115		Not used	
116		Not used	
117	E	ASC throttle flap signal	Auxiliary throttle position sensor
118		Not used	
119		Not used	
120		Not used	
121		Not used	
122		Not used	
123		Not used	
124		Not used	
125		Not used	
126	E	Signal park brake set	Park brake switch
127	E	Engine signal 3	Engine control module (DME)
128		Not used	
129		Not used	
130		Not used	
131	E	Engine signal 2	Engine control module (DME)
132		Not used	
133		Not used	
134		Not used	
135		Not used	
136		Not used	
137		Not used	
138	E	Throttle flap position	Engine control module (DME)

E = Input, A = Output, M = Ground

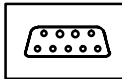

Z3

**Pin Assignments****X1170**

Pin	Type	Signal	Description/Function	Connection
1	M	VL-	Sensor ground	Left front speed sensor (ABS)
2	E	VL+	Speed signal	Left front speed sensor (ABS)
3			Not used	
4	E	15A21	Voltage supply	Fuse 21
5	M	HL-	Sensor ground	Left rear speed sensor (ABS)
6	E	HL+	Speed signal	Left rear speed sensor (ABS)
7	E/A	TXD	TXD signal	Diagnostic link
8	M	31L	Ground	Ground point
9	E	30<10	Voltage supply	Fuse 10
10	E/A	CAN-	CAN bus low	Instrument cluster/engine control module
11	E/A	CAN+	CAN bus high	Instrument cluster/engine control module
12			Not used	
13	E	54	Brake signal	Brake light switch
14	E	ASCS	ASC-ON-signal	ASC switch
15			Not used	
16	A	WLAS	Warning lamp	Instrument cluster
17			Not used	
18			Not used	
19	M	VR-	Sensor ground	Right front speed sensor (ABS)
20	E	VR+	Speed signal	Right front speed sensor (ABS)
21	A	DFAHR	Right rear speed signal	Engine control module (DME)
22	E	HR+	Speed signal	Right rear speed sensor (ABS)
23	M	HR-	Sensor ground	Right rear speed sensor (ABS)
24	M	31L	Ground	Ground point
25	E	30<38	Voltage supply	Fuse 38

E = Input, A = Output, M = Ground



SLIP CONTROL (ABS/ASC)

M VERSIONS

Z3

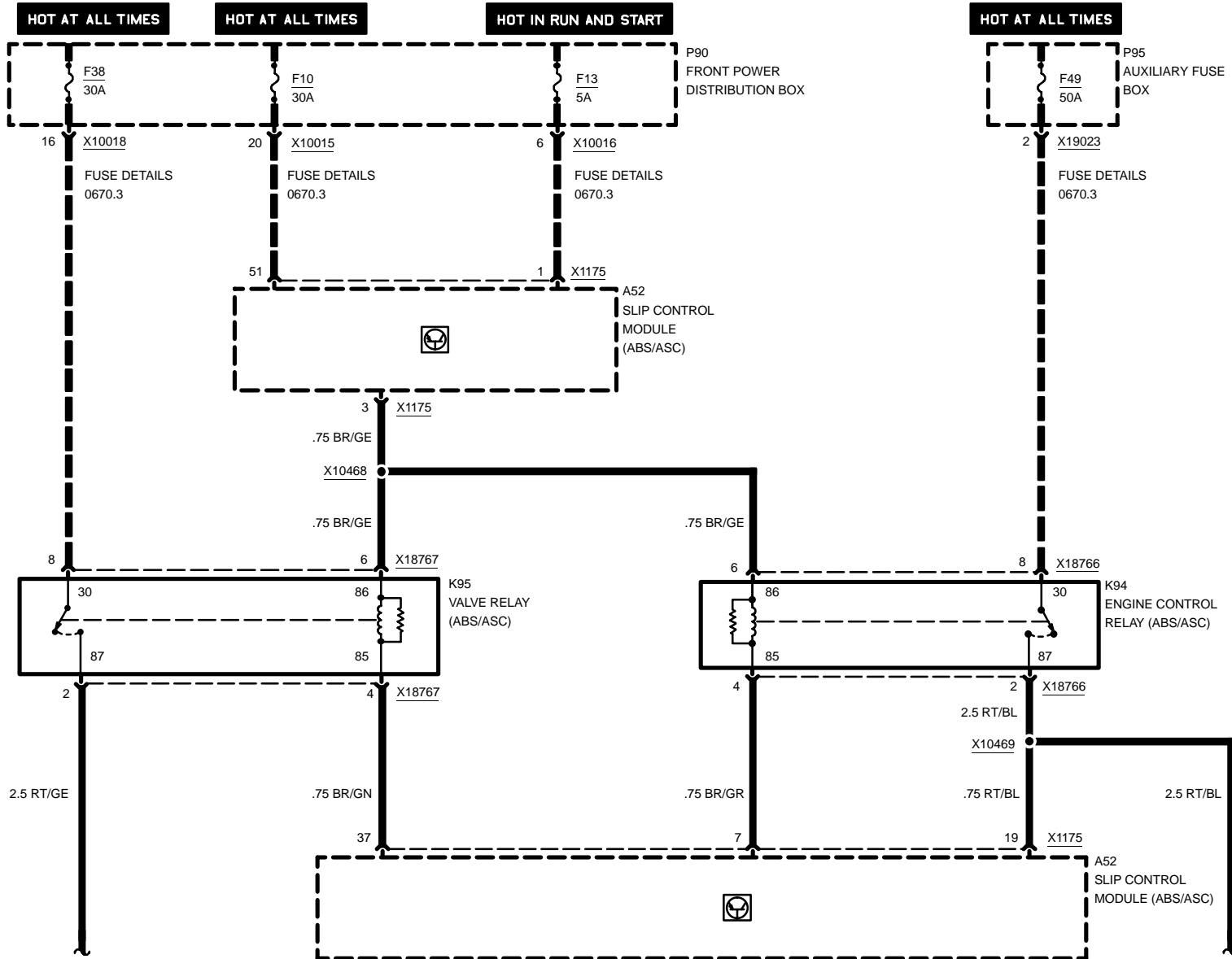

03/00

3450.1-00

1999

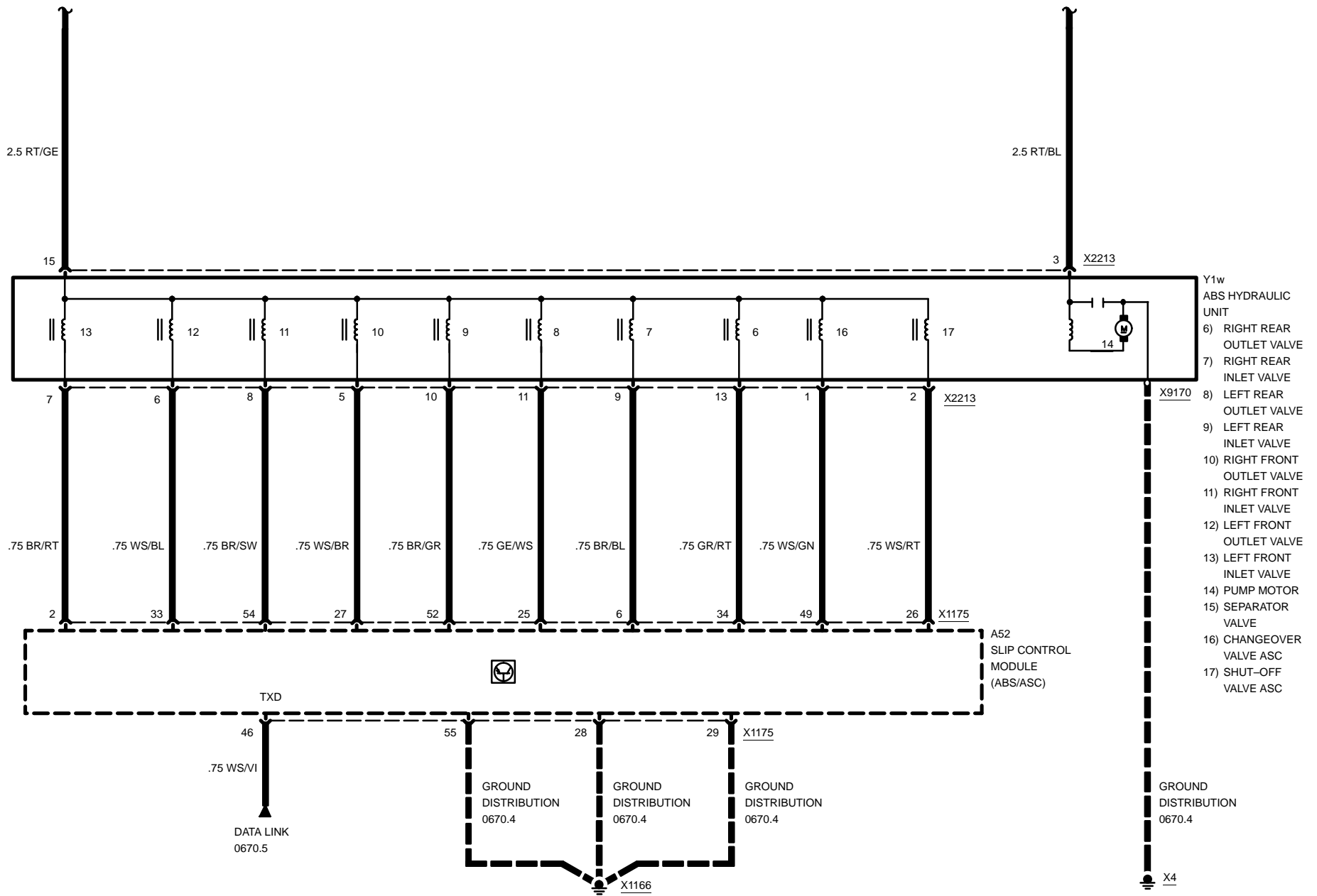



Z3

SLIP CONTROL (ABS/ASC)

M VERSIONS

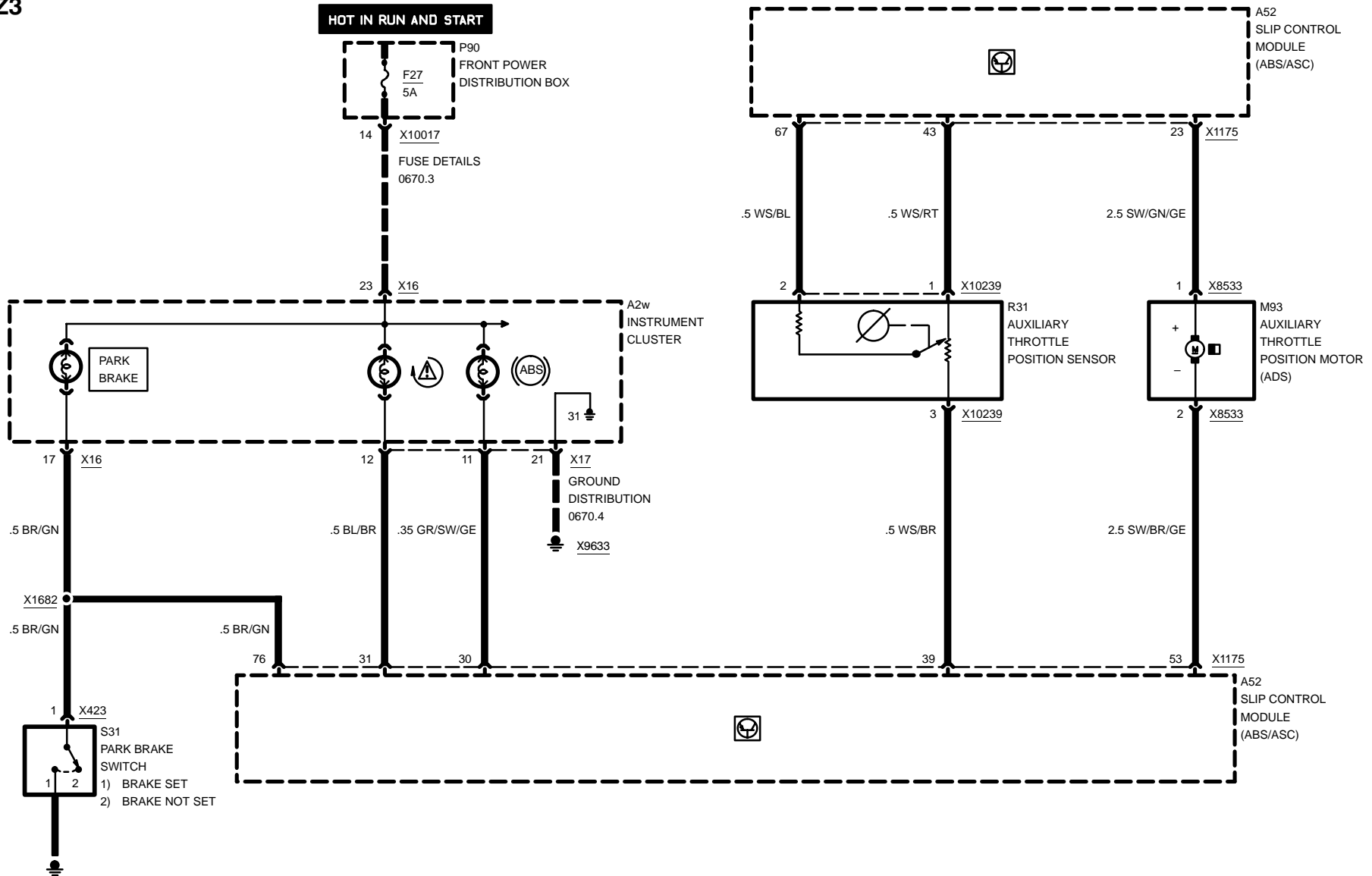

03/00

3450.1-02

1999



SLIP CONTROL (ABS/ASC)

M VERSIONS

Z3

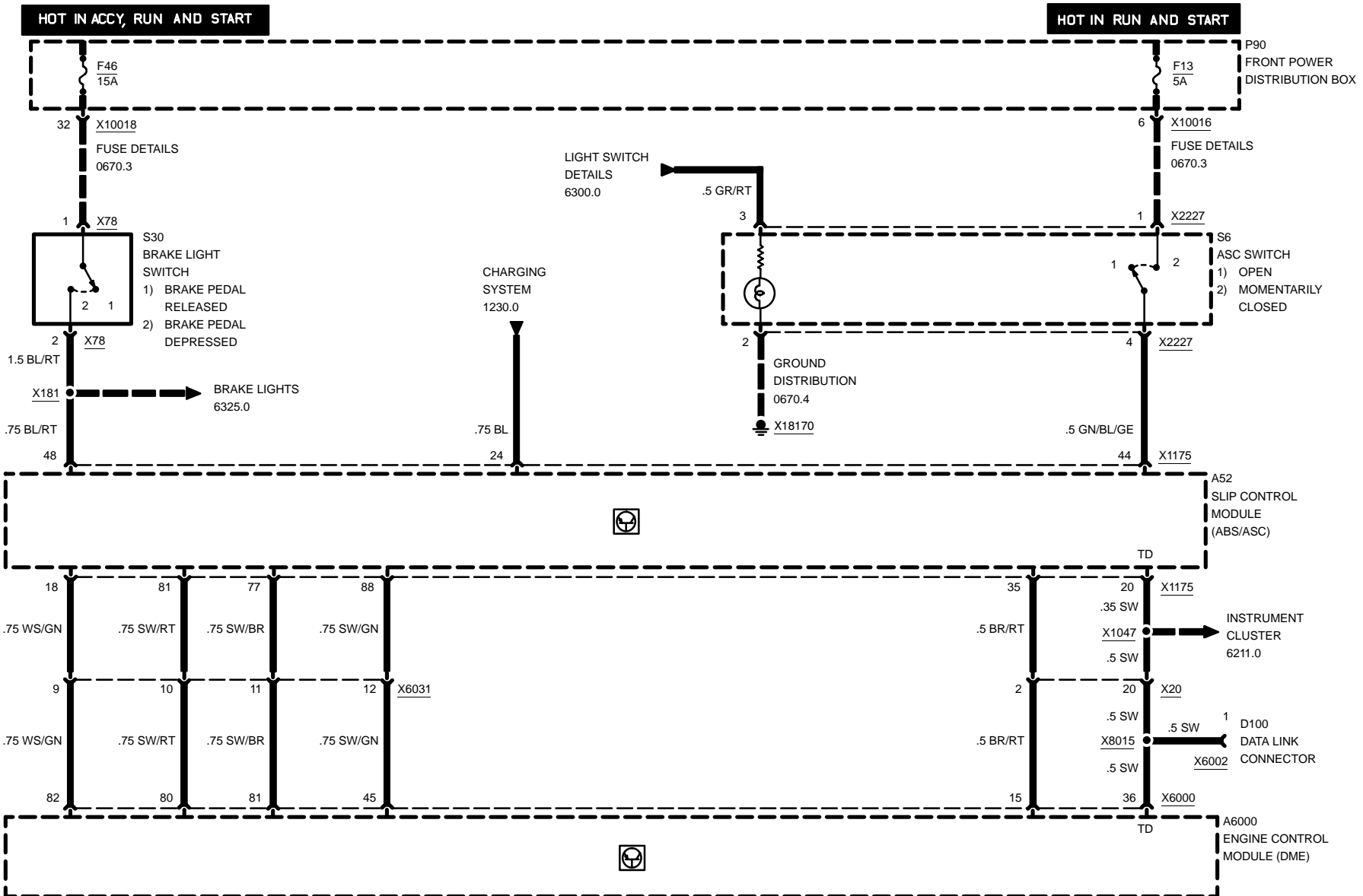

03/00

3450.1-03

1999

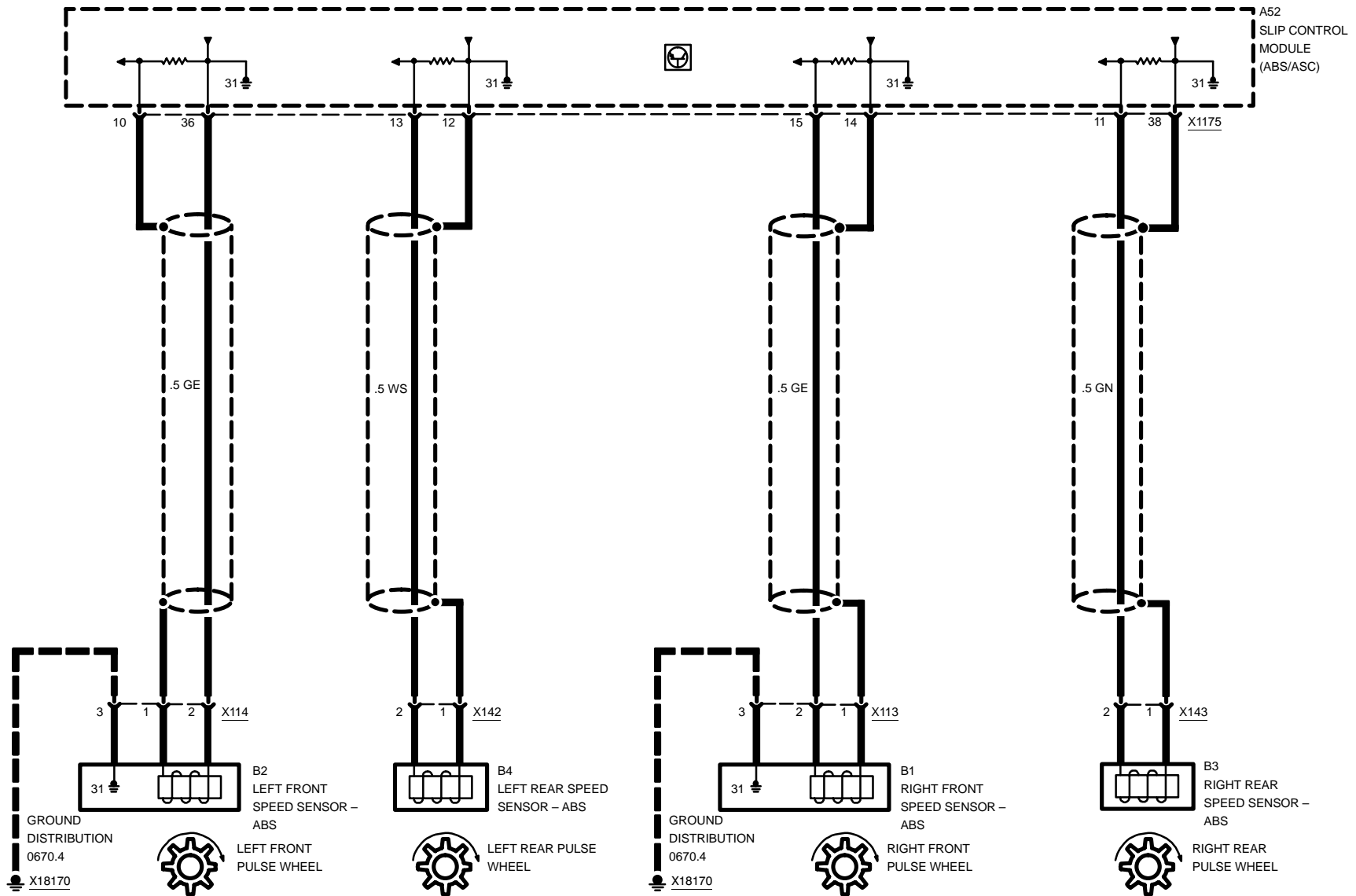



Z3

SLIP CONTROL (ABS/ASC)

Z3 VERSIONS

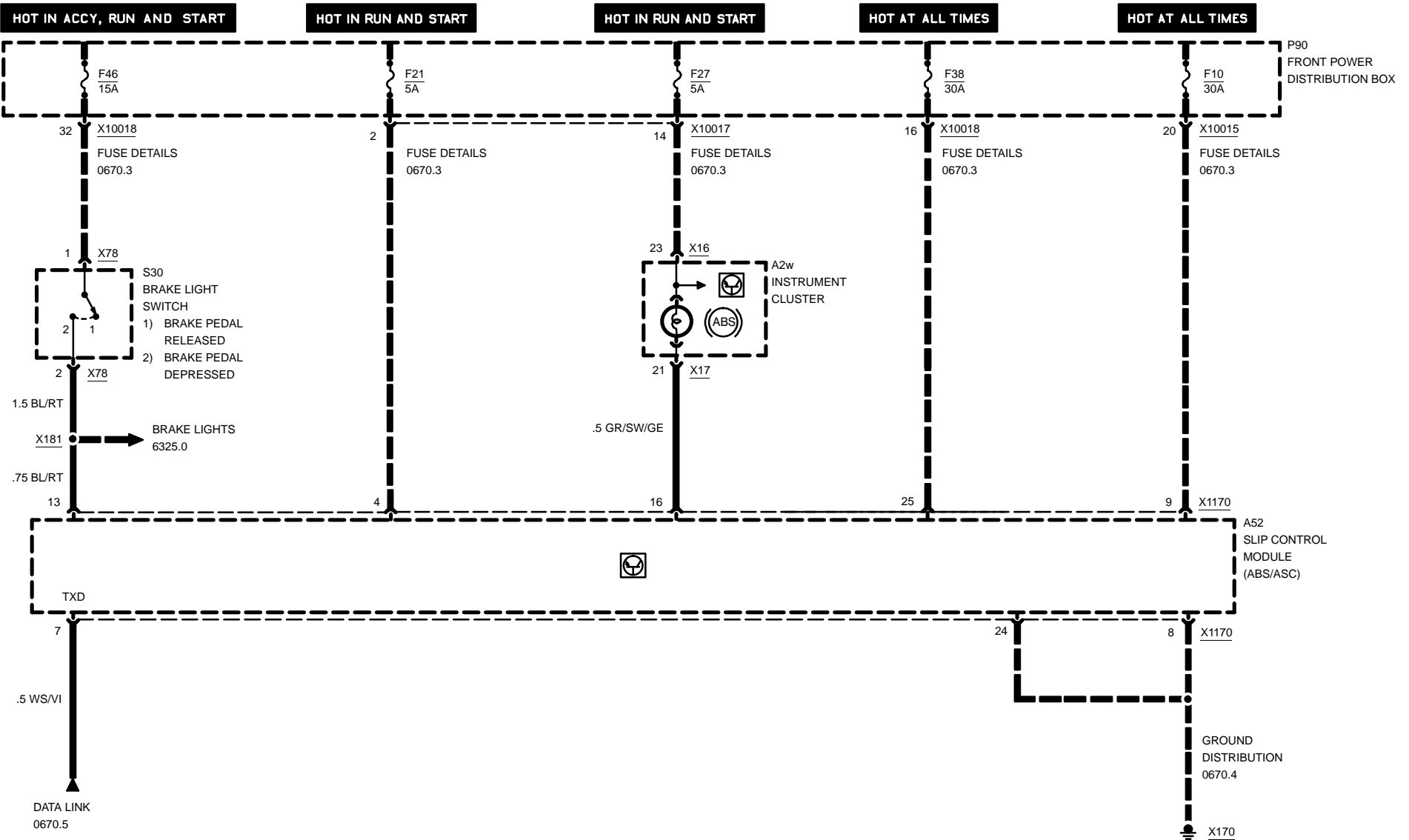

03/00

3450.1-05

1999



SLIP CONTROL (ABS/ASC)

Z3 VERSIONS

Z3

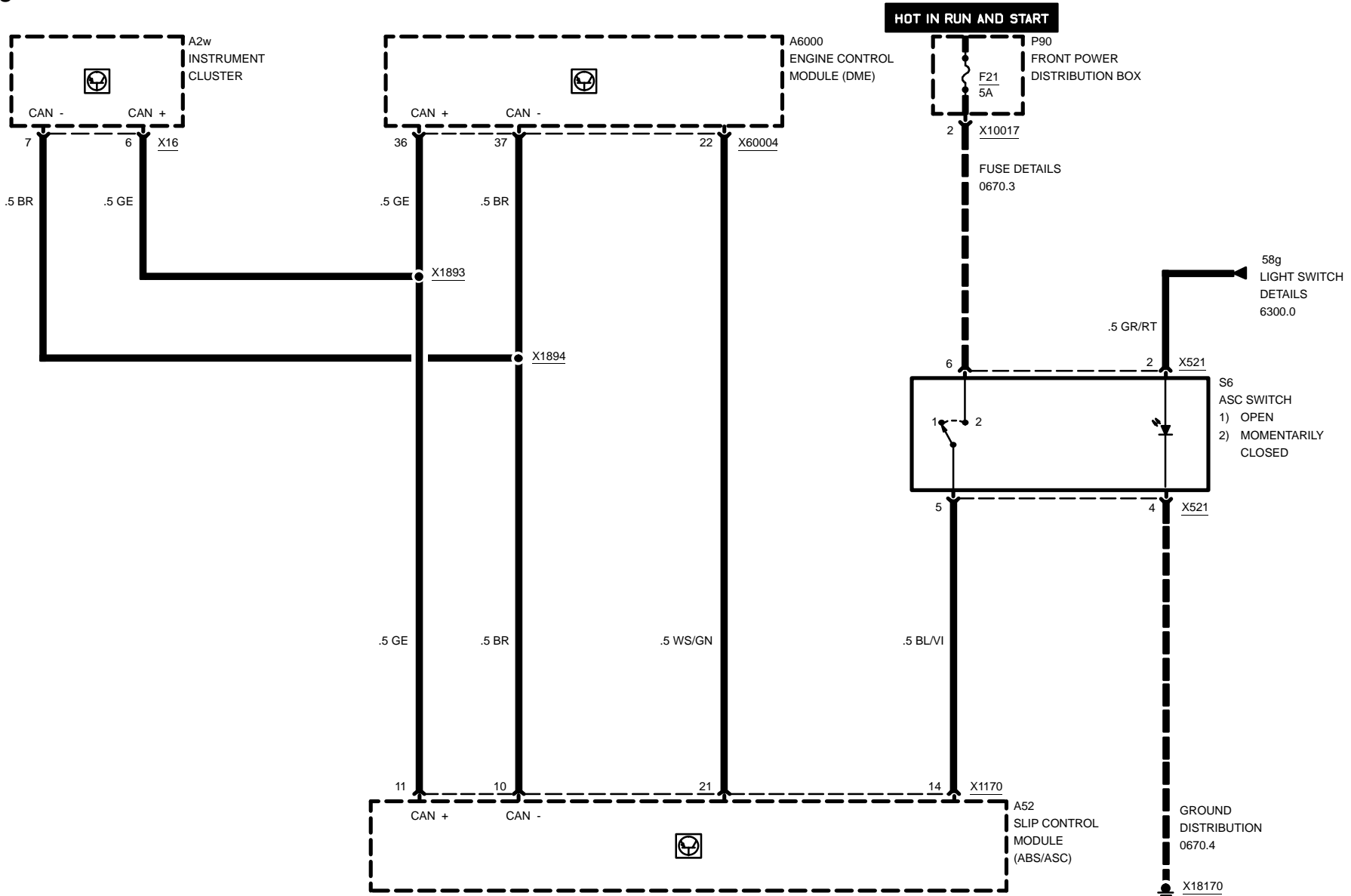

03/00

3450.1-06

1999



SLIP CONTROL (ABS/ASC)

Z3 VERSIONS

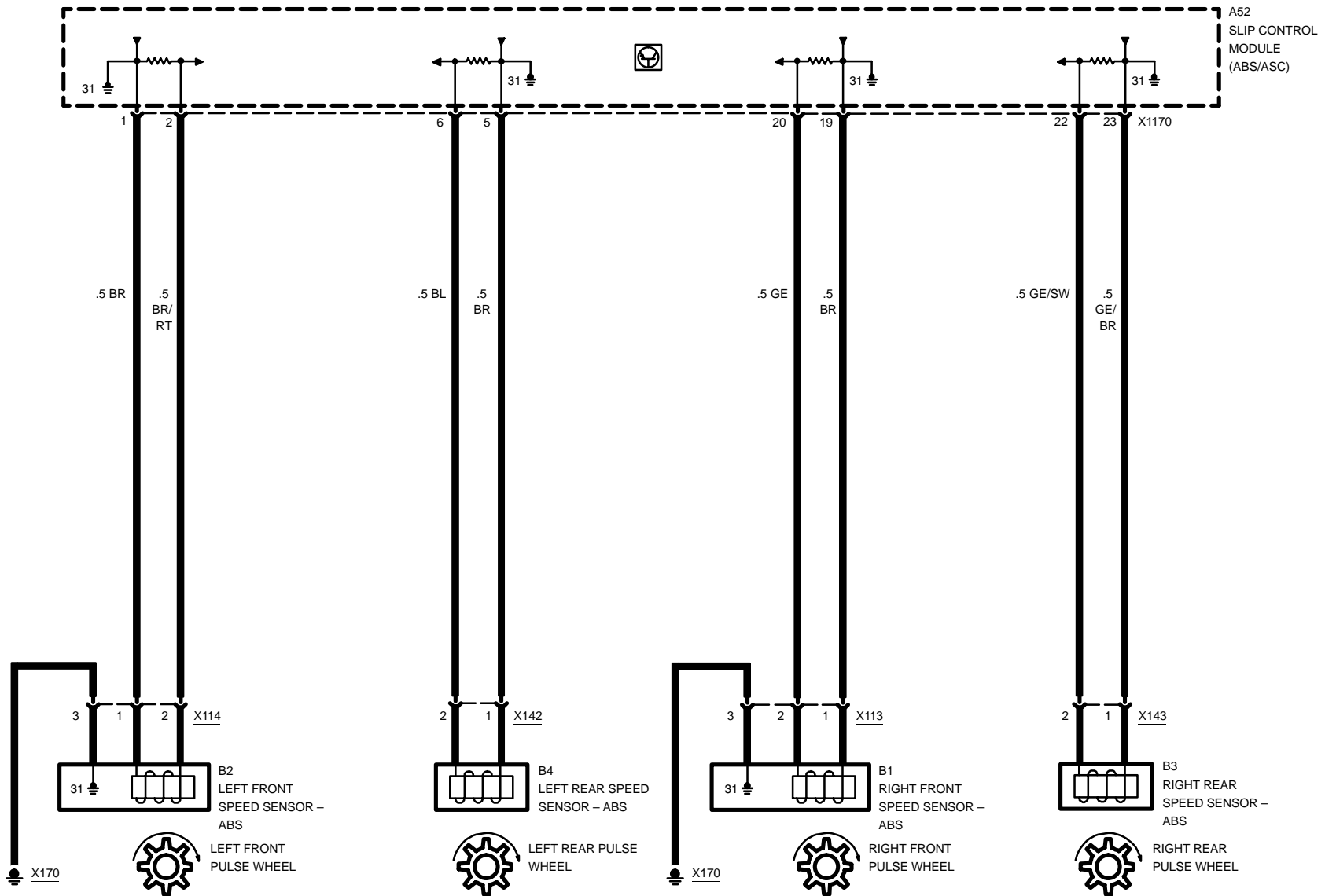

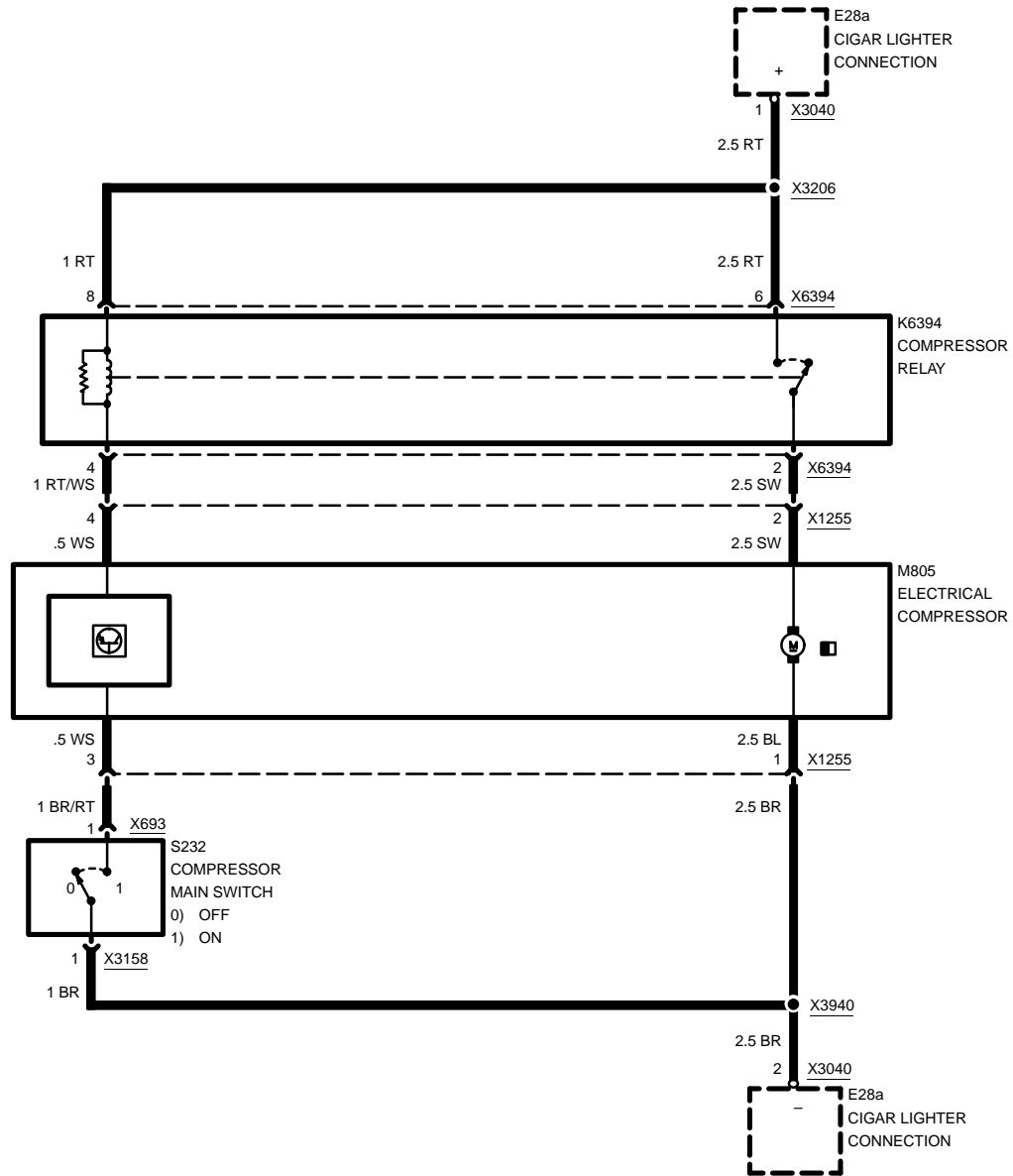



5116.0 POWER MIRRORS

OUTSIDE MIRROR

HOT IN RUN AND START

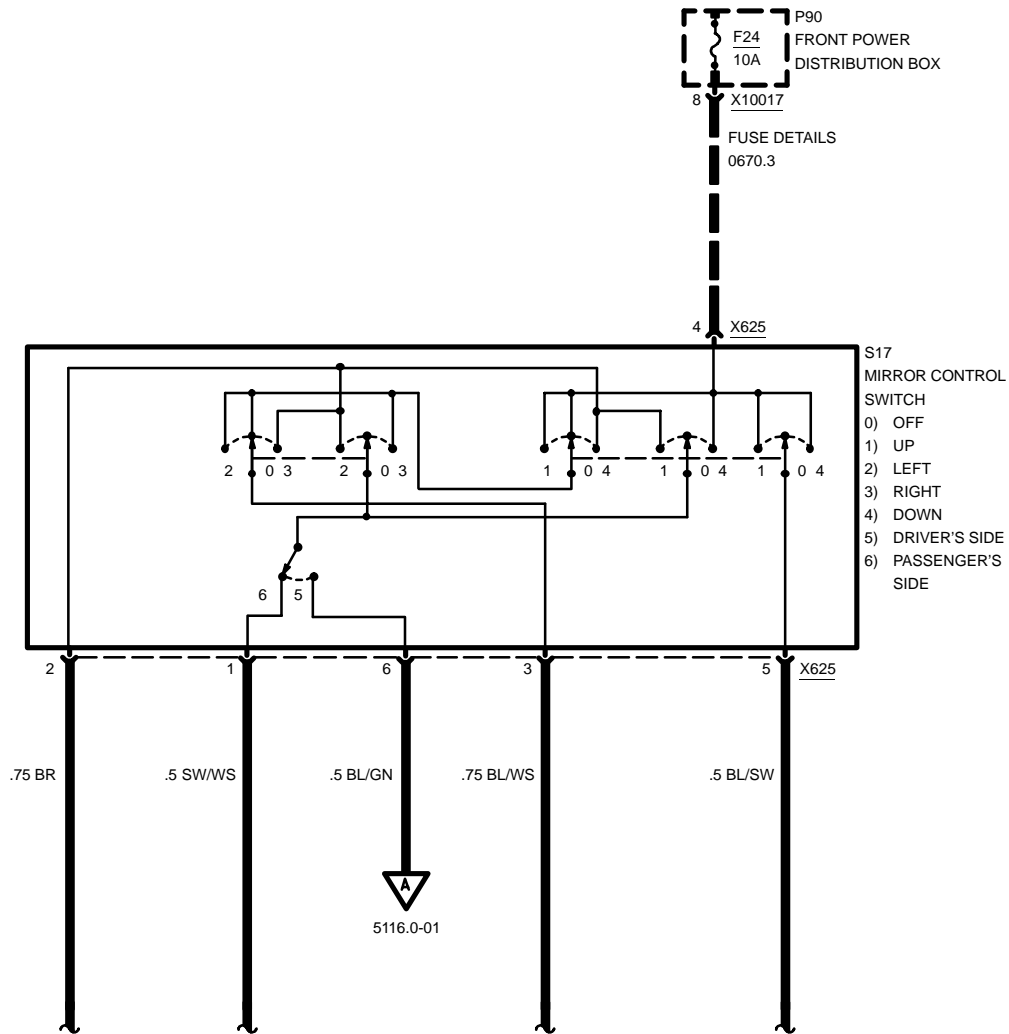

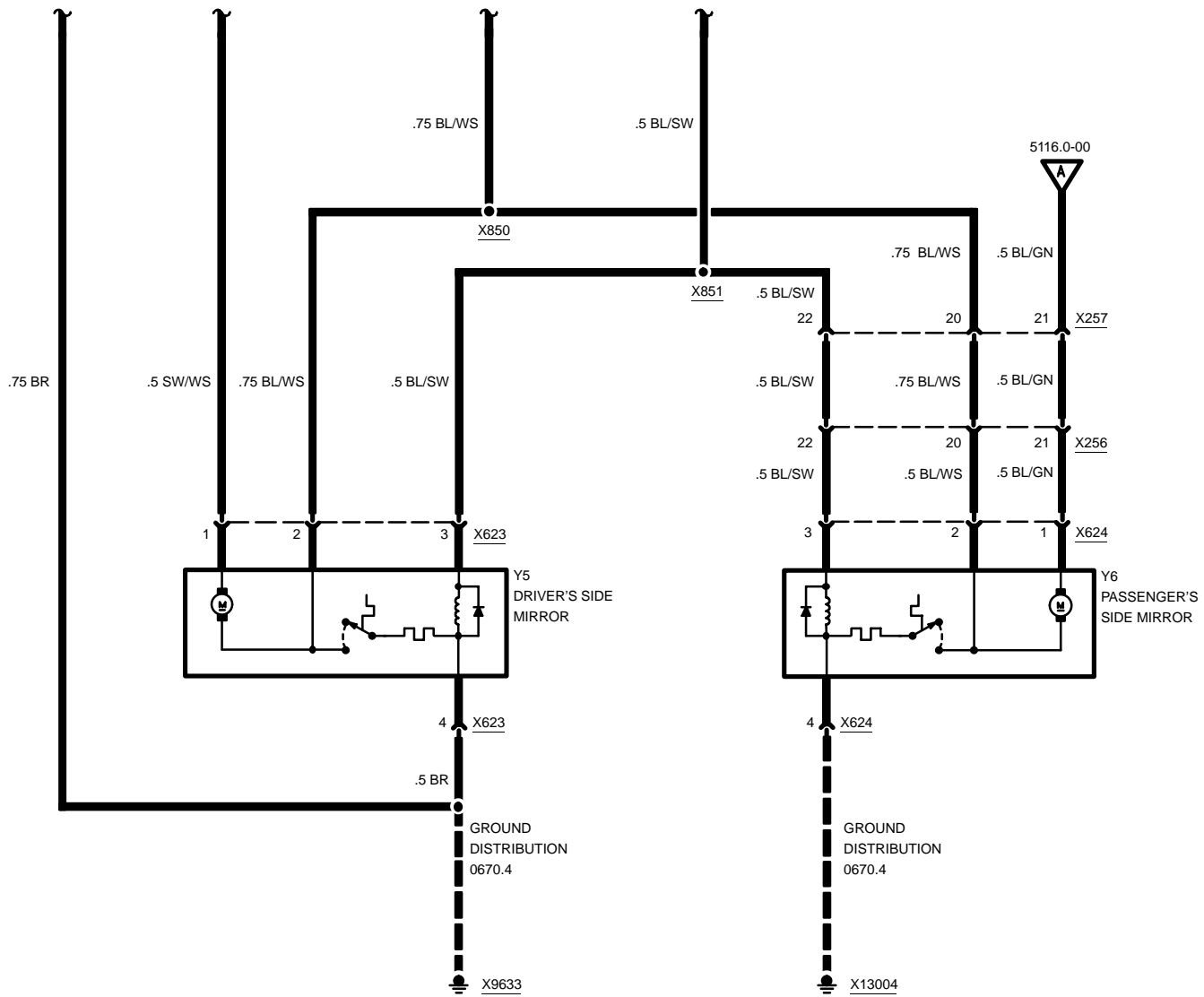



5126.0 ZKE CENTRAL LOCKING (ZV)

INPUTS, DRIVE-AWAY PROTECTION

Z3

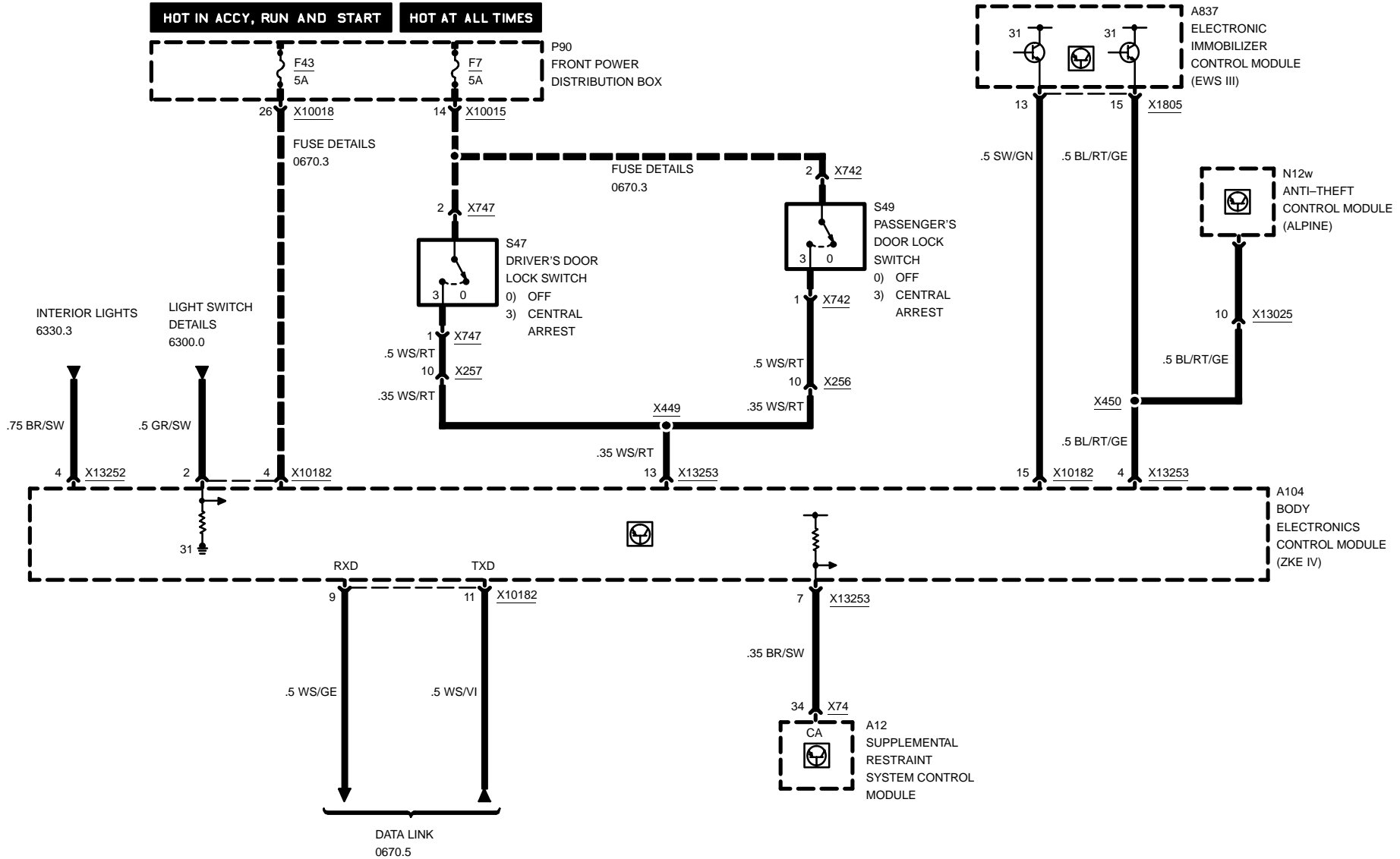

03/00

5126.0-00

1999



ZKE CENTRAL LOCKING (ZV)

INPUT DETAILS

Z3

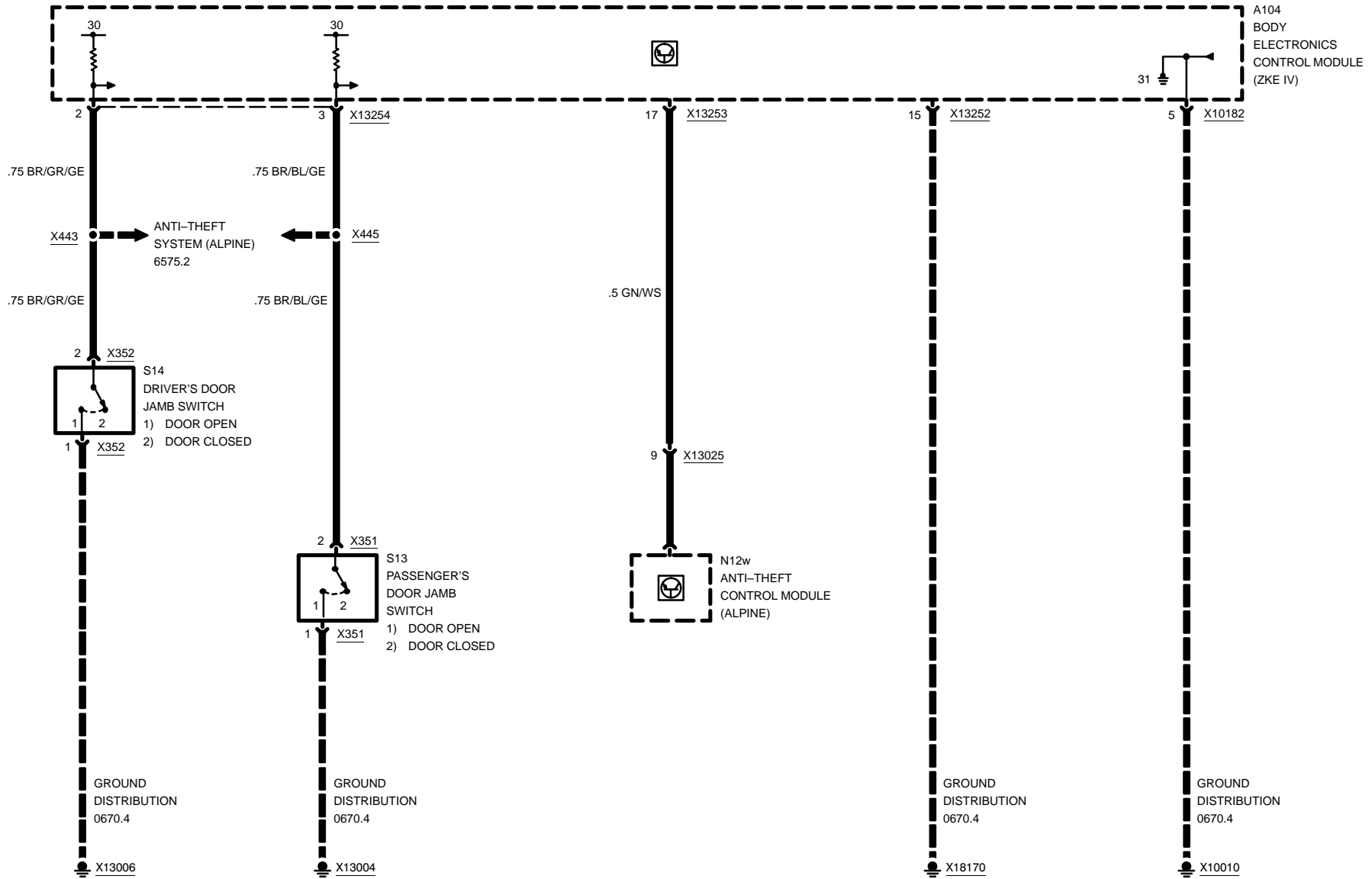

03/00

5126.0-01

1999

ZKE CENTRAL LOCKING (ZV) OUTPUT DETAILS

Z3 VERSIONS AND M ROADSTER

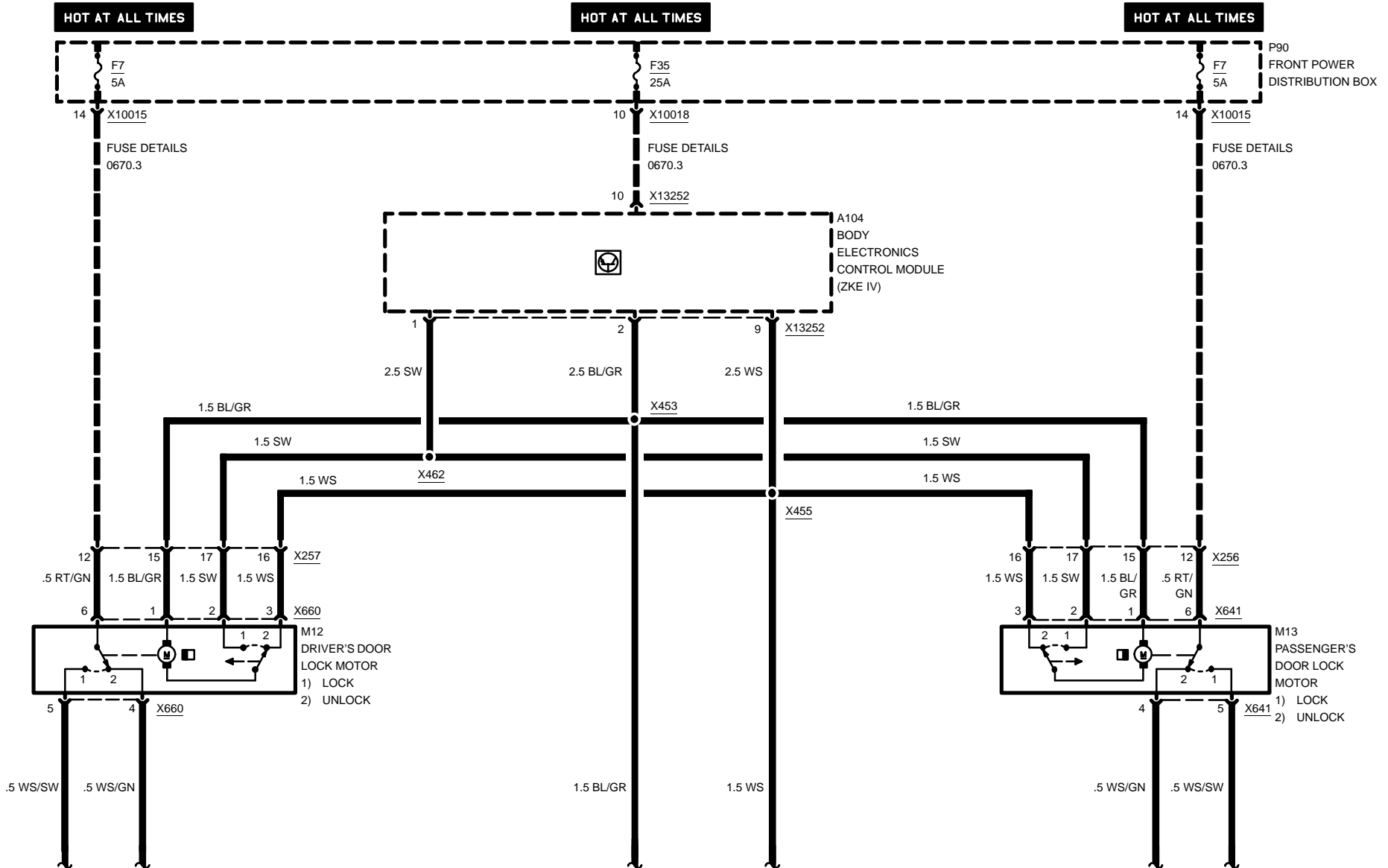

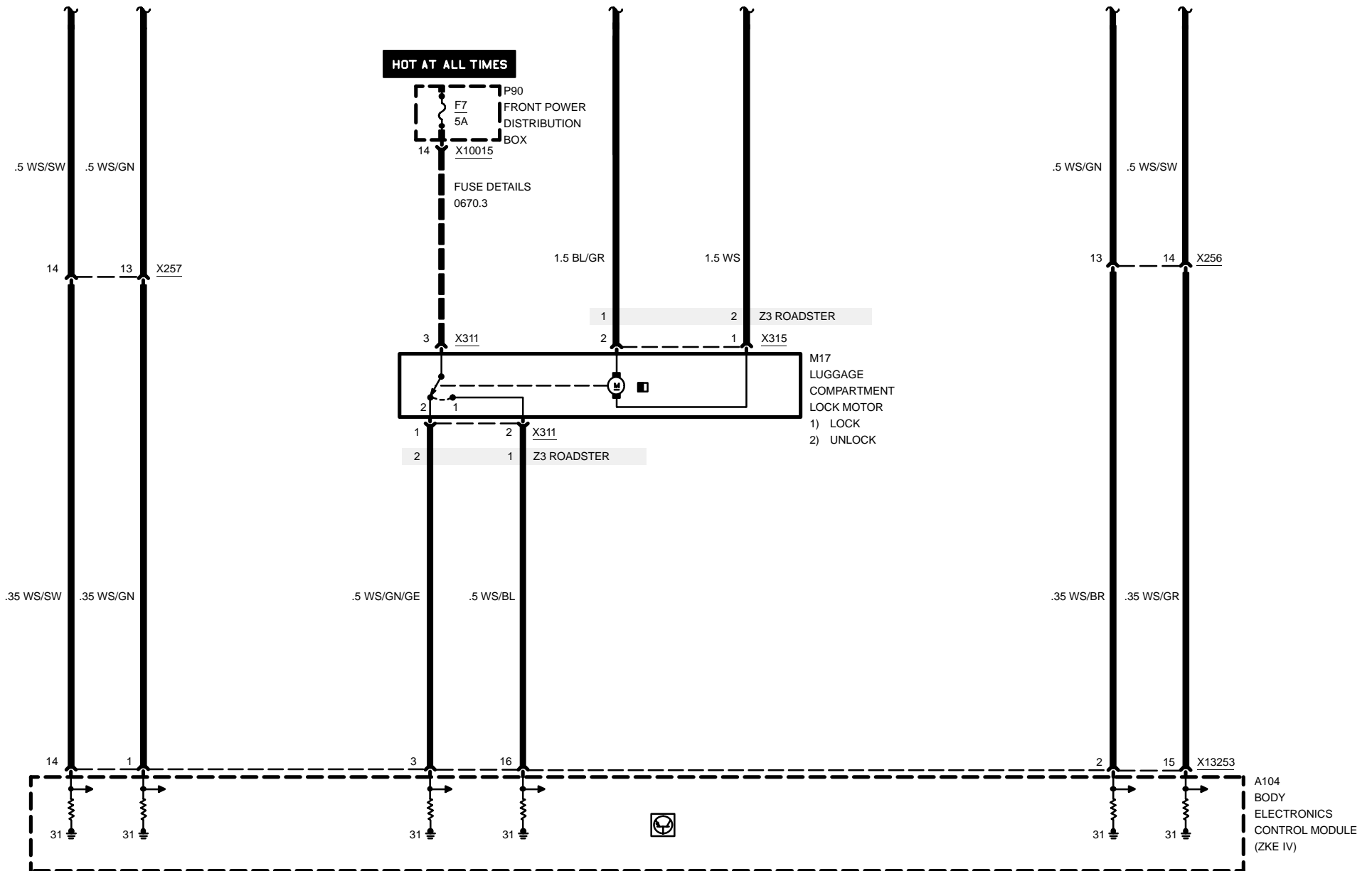

ZKE CENTRAL LOCKING (ZV)
OUTPUT DETAILS

M COUPE

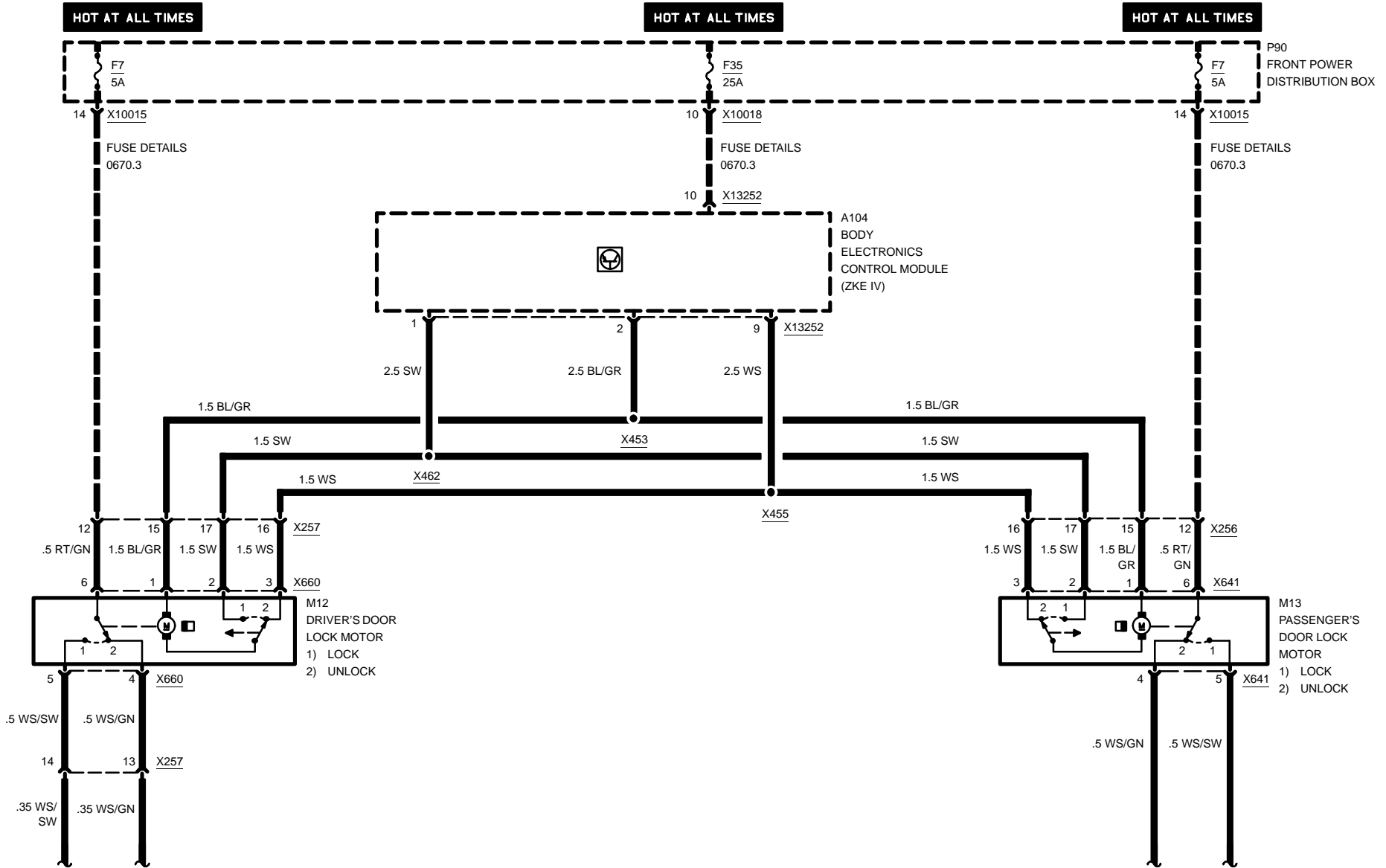

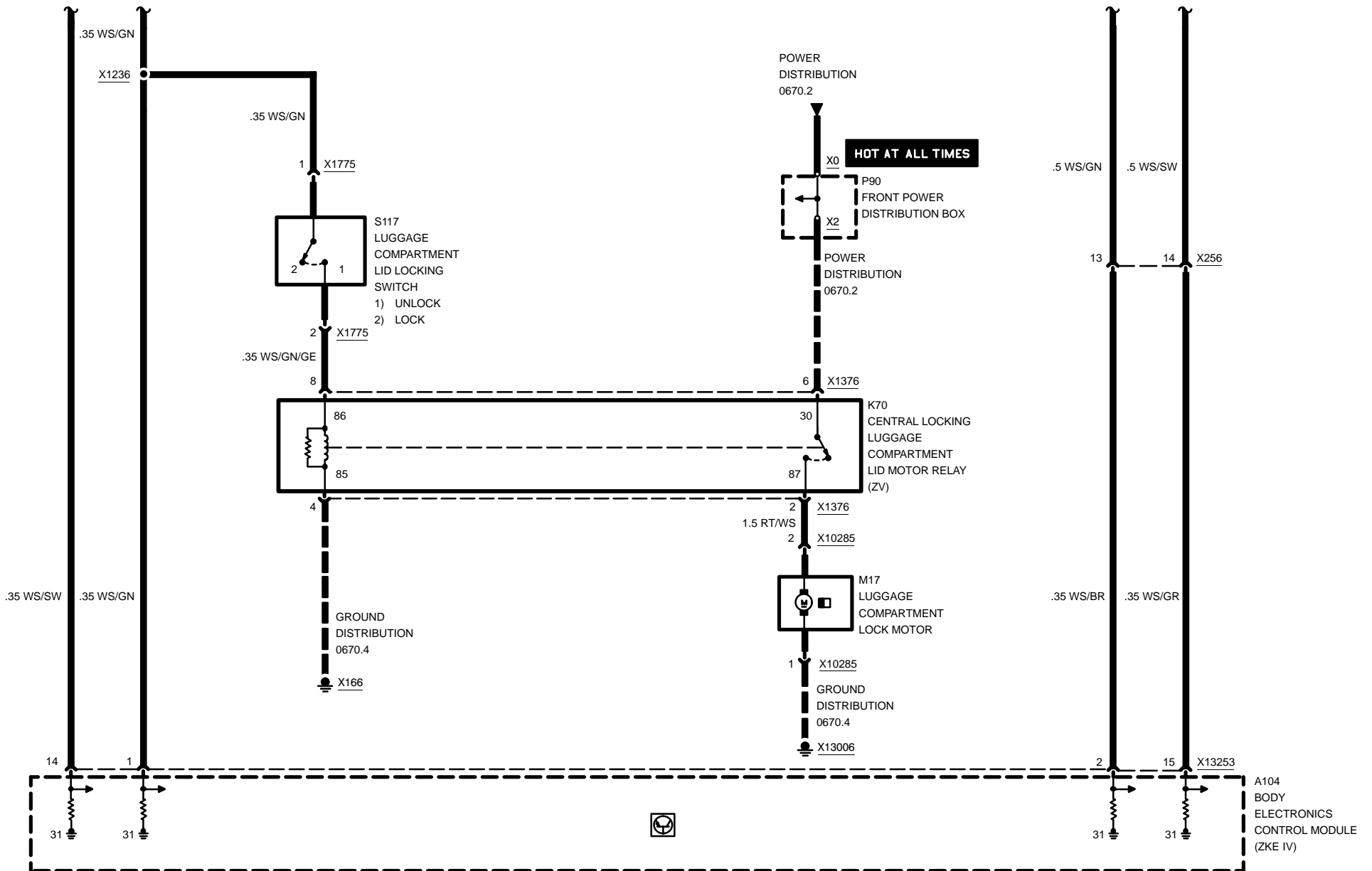



5133.0 ZKE POWER WINDOWS (FH) INPUT DETAILS

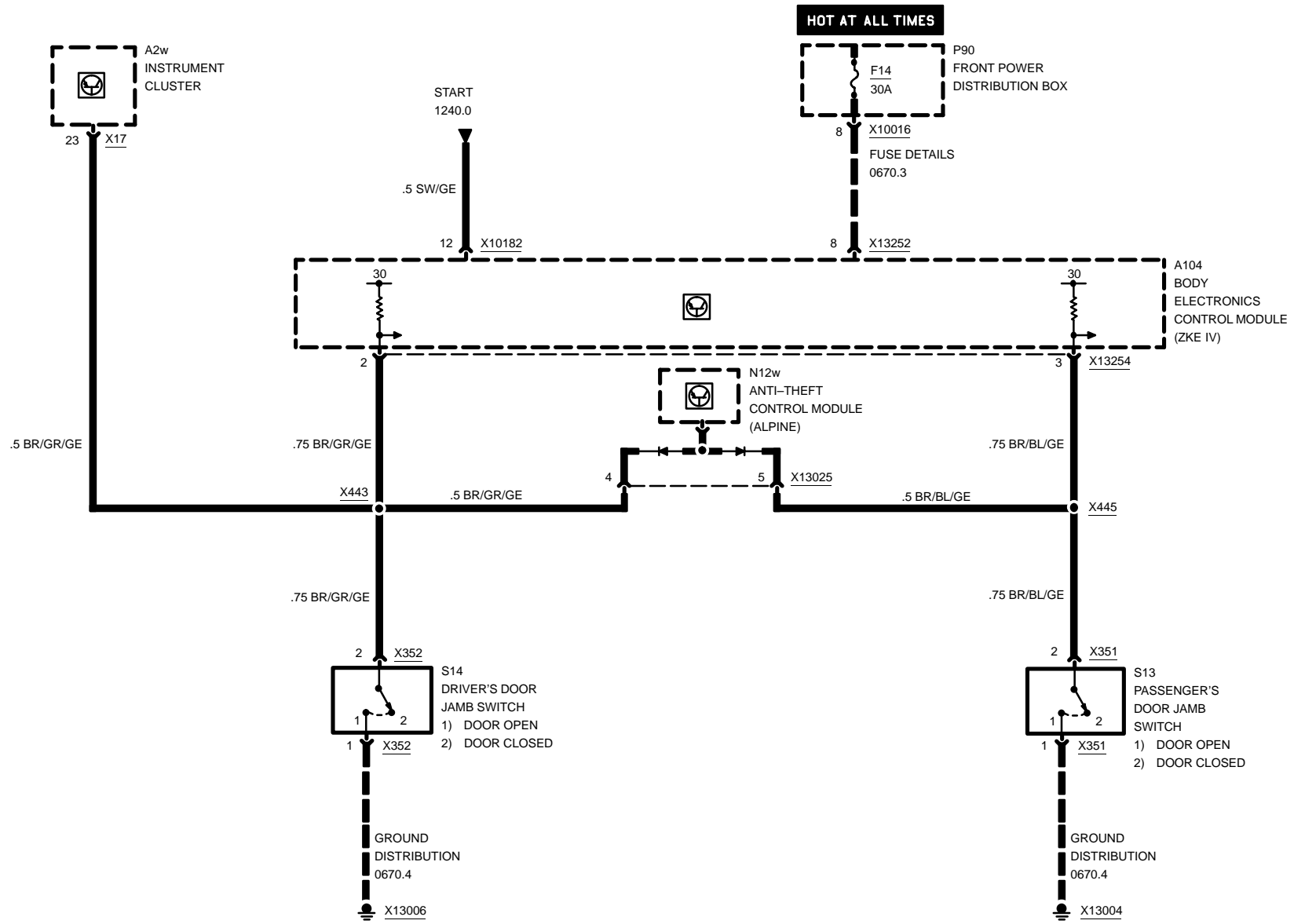

03/00

5133.0-00

1999



ZKE POWER WINDOWS (FH)

INPUT DETAILS

Z3

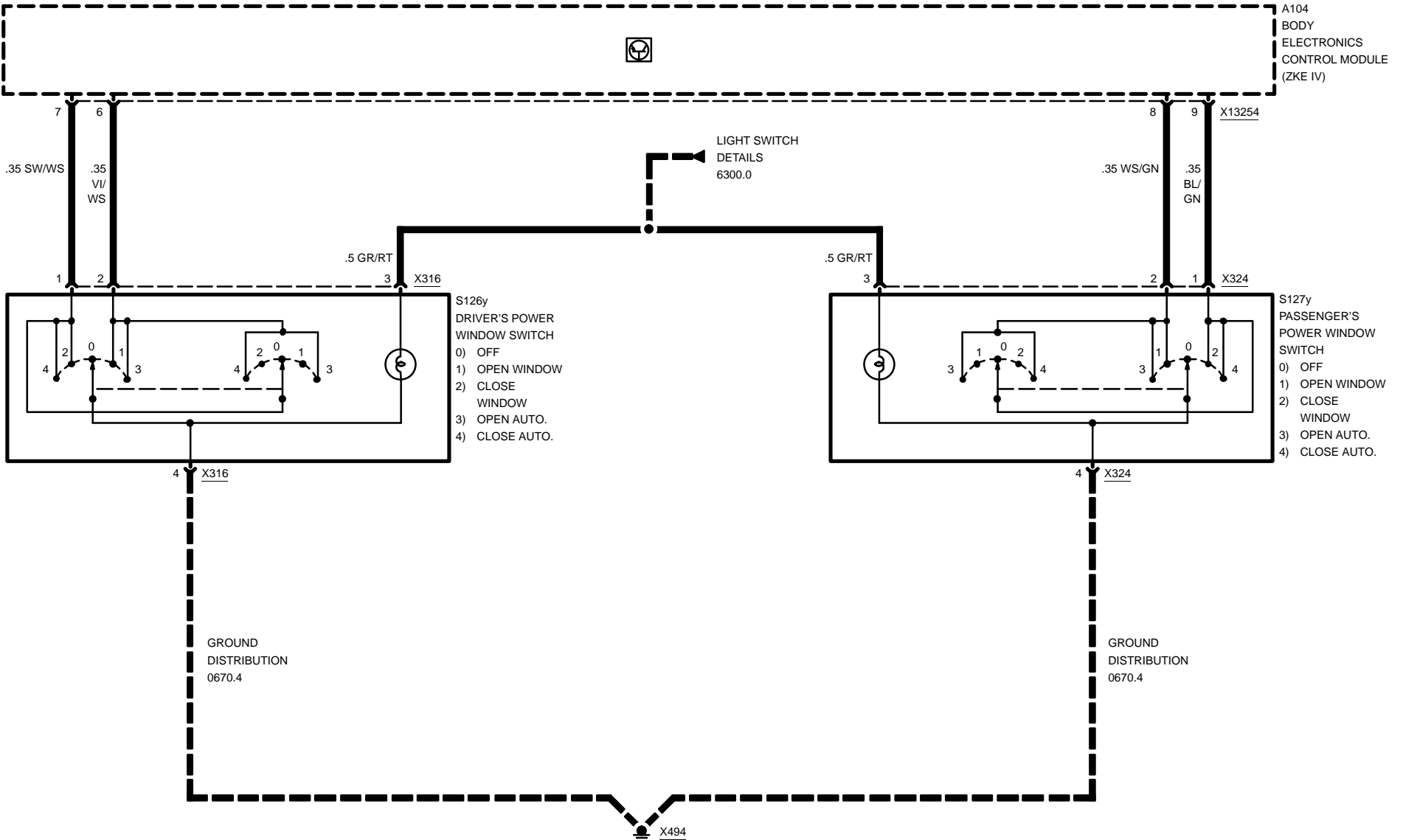

03/00

5133.0-01

1999



ZKE POWER WINDOWS (FH)

OUTPUT DETAILS

Z3

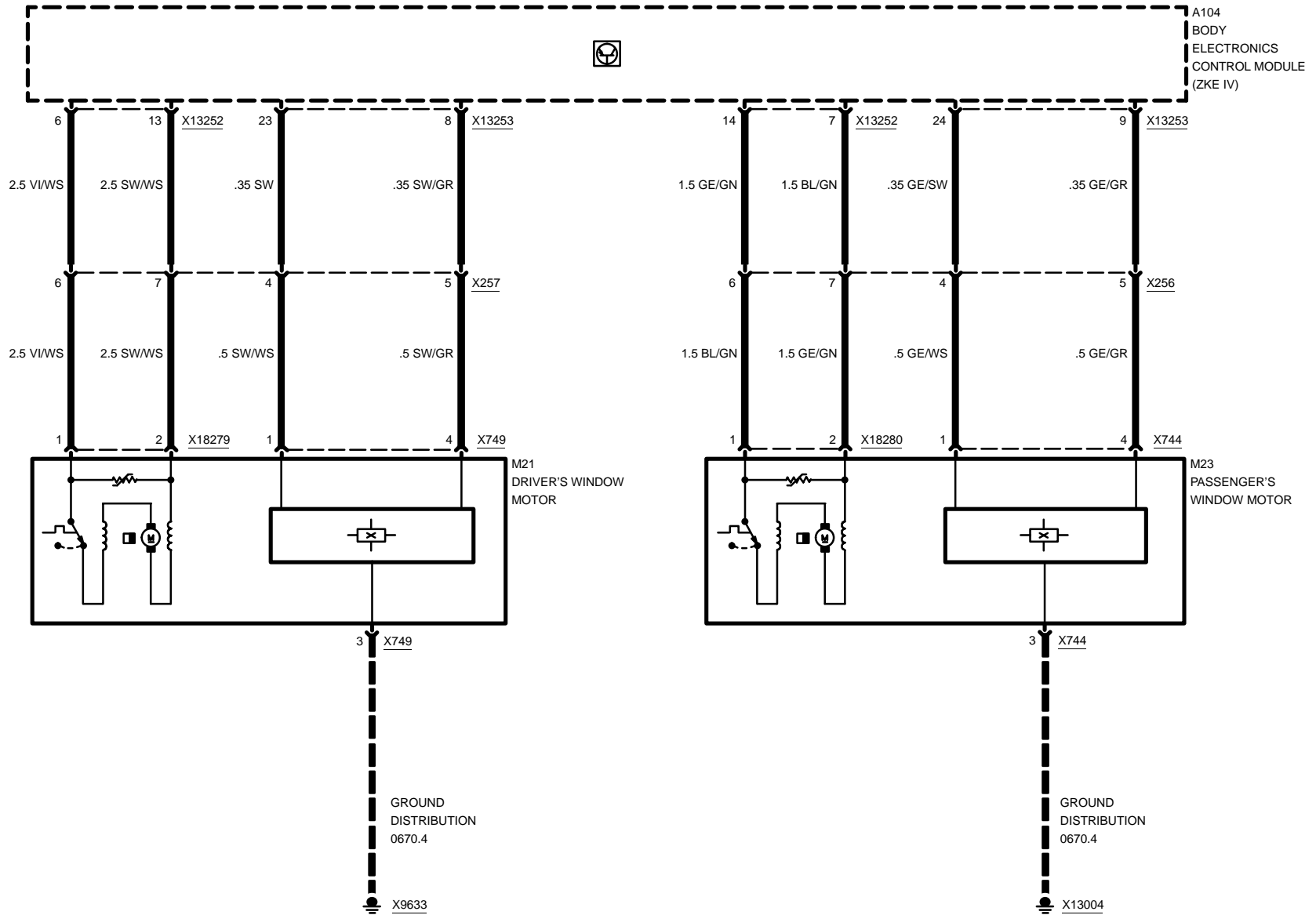

03/00

5133.0-02

1999



5200.0 POWER SEATS

DRIVER'S SEAT

03/00

5200.0-00

1999

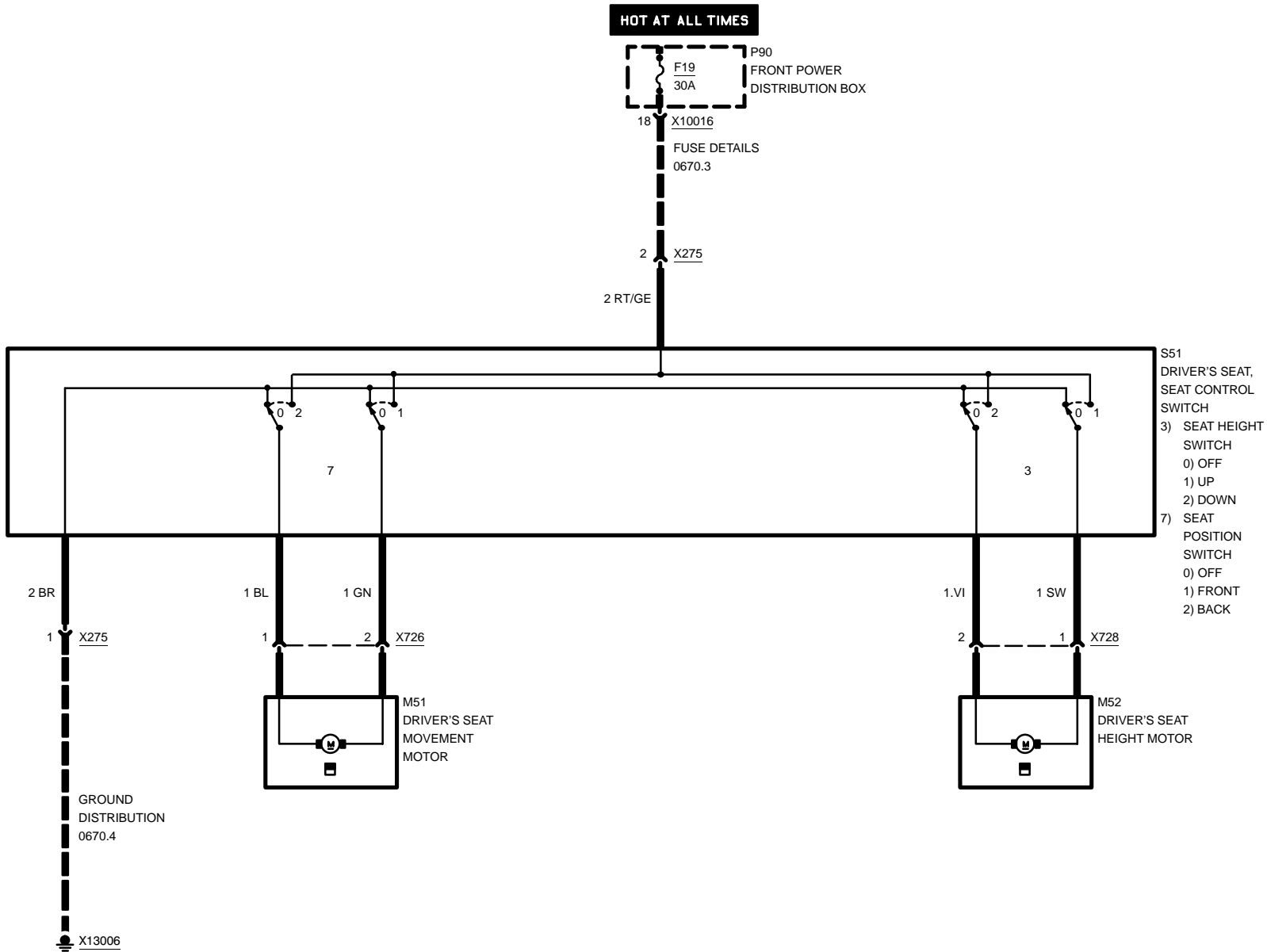



POWER SEATS PASSENGER'S SEAT

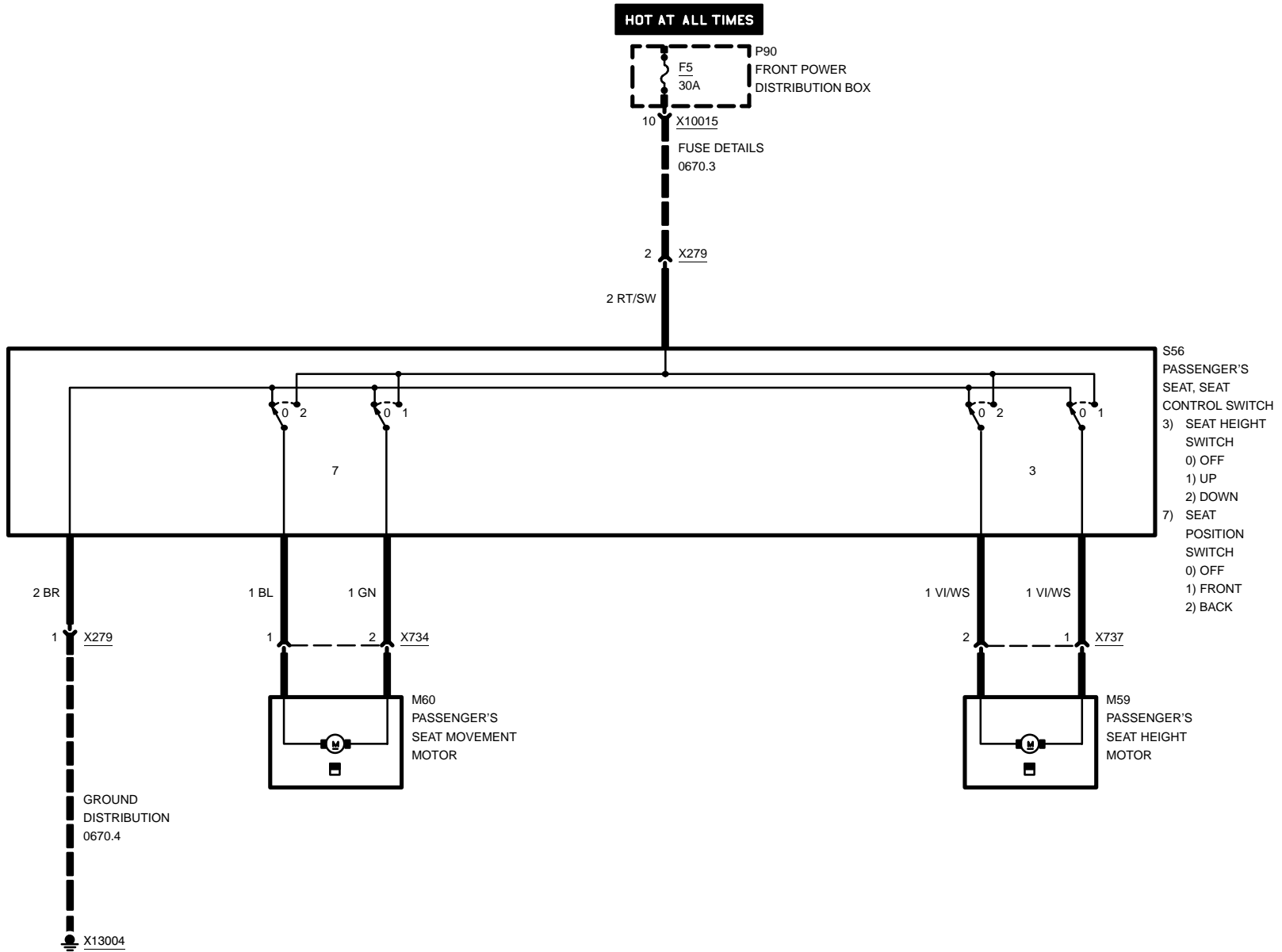

03/00

5200.0-01

1999

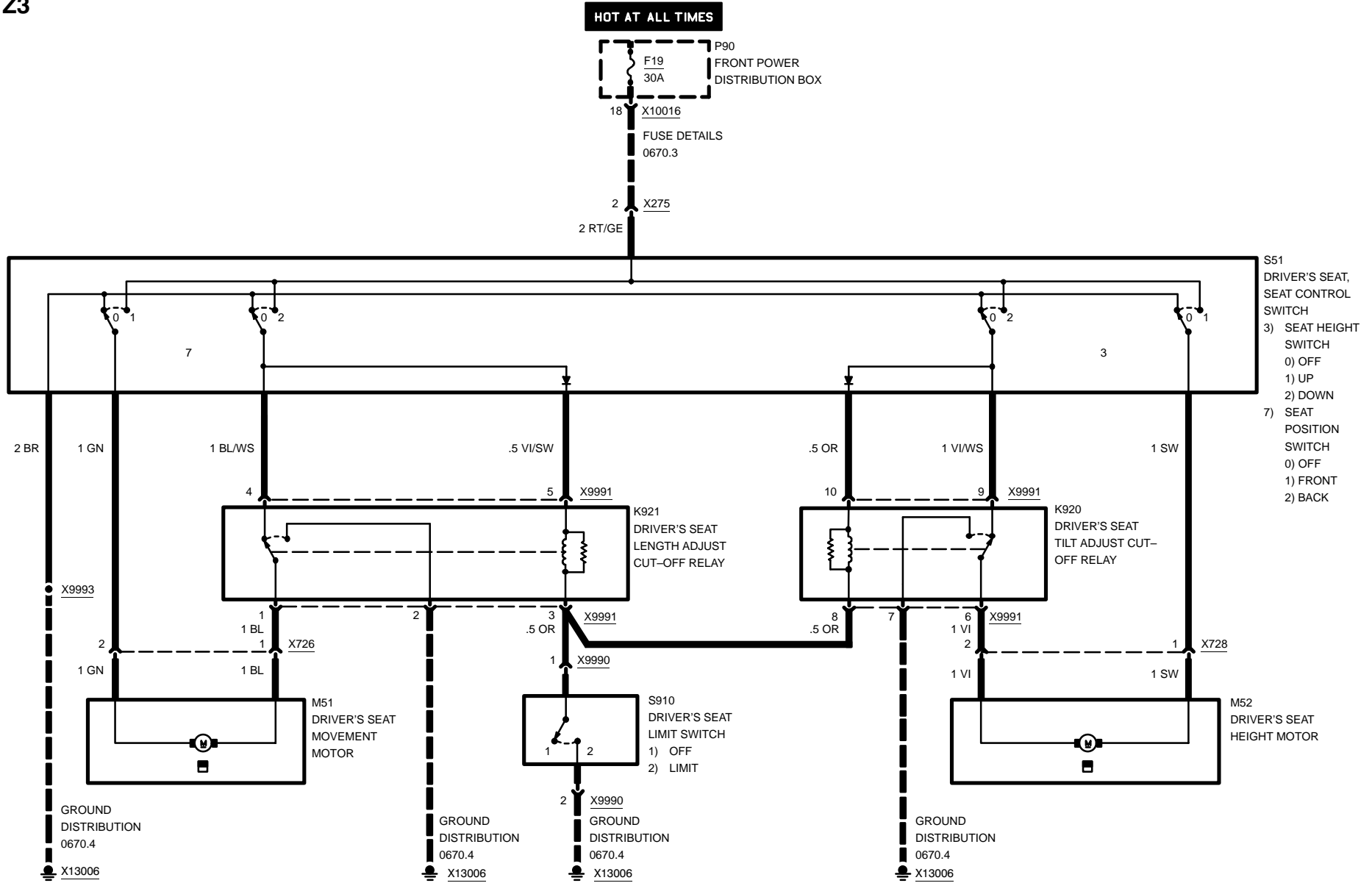

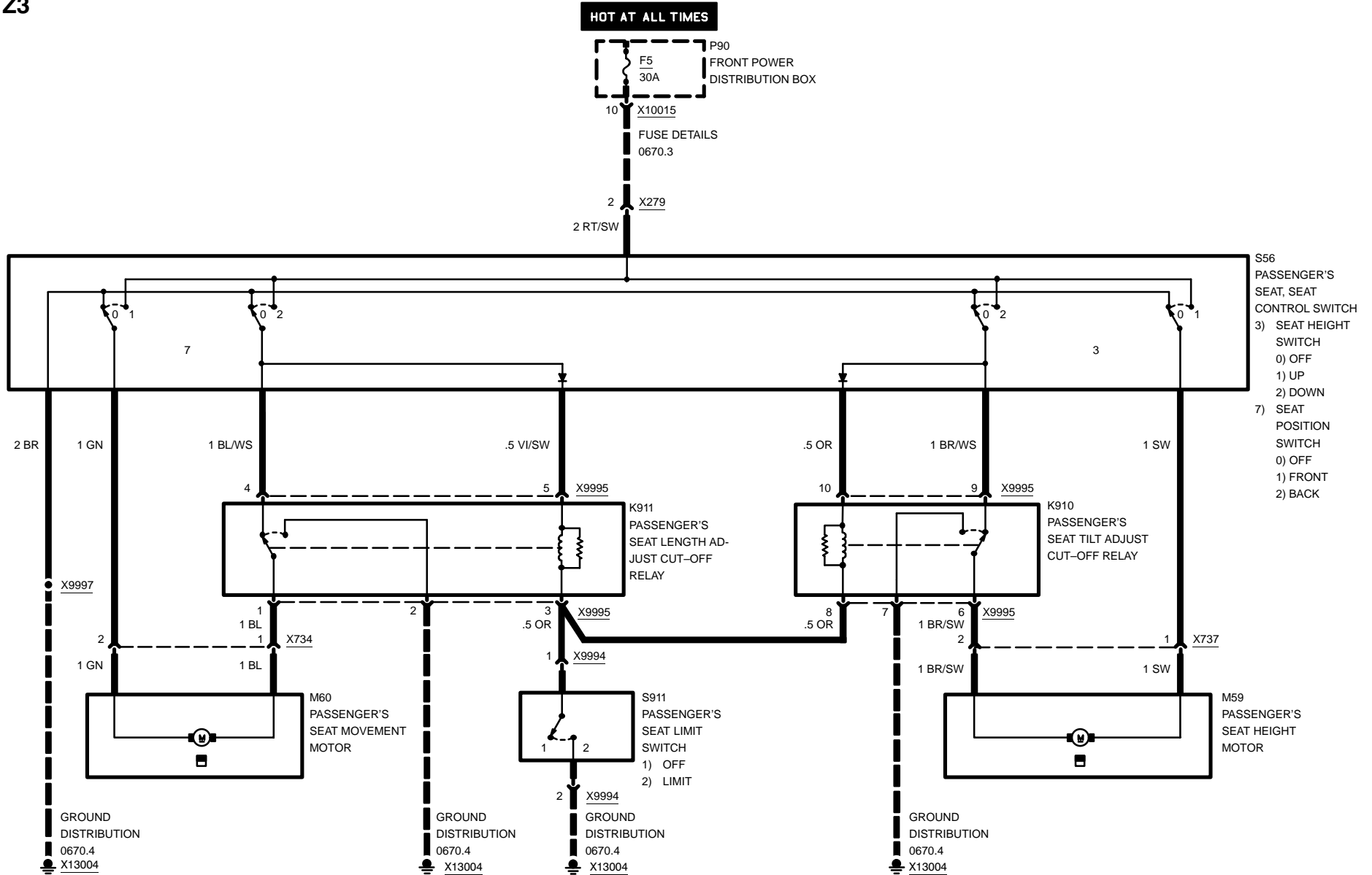



Z3

5203.0 HEATED SEATS

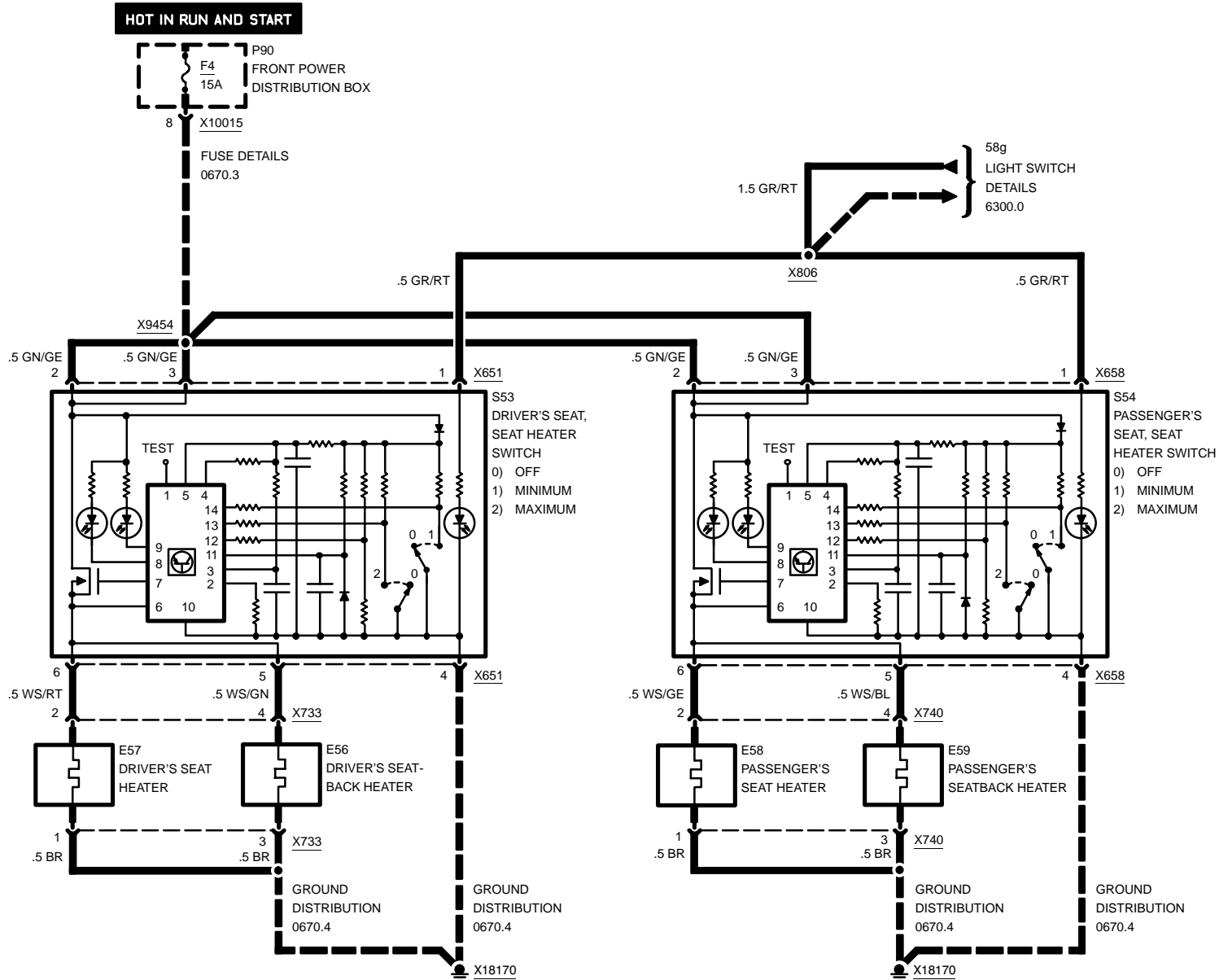

03/00

5203.0-00

1999



5410.5 POWER TILT SUNROOF

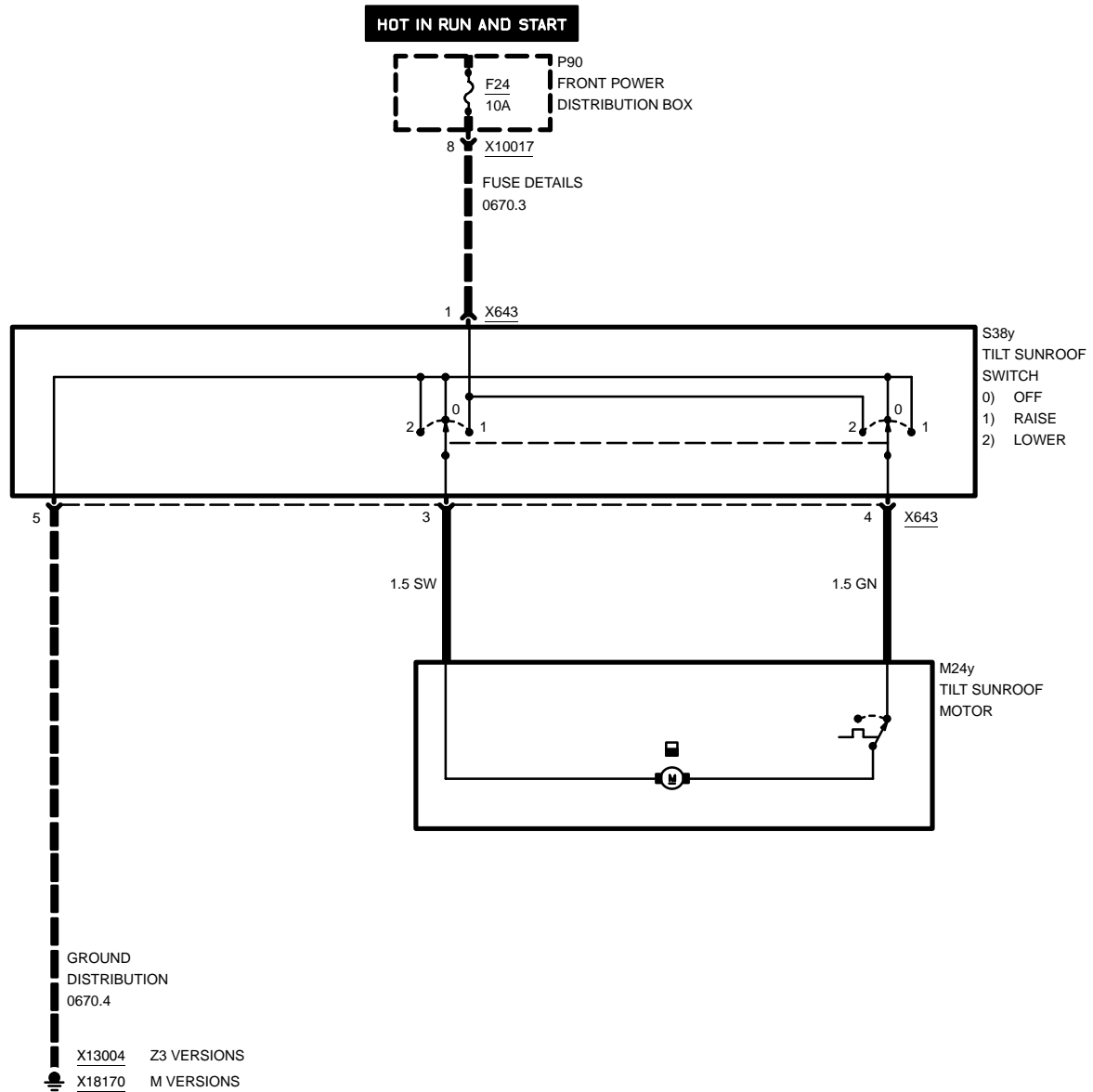

5430.2 ELECTRO-HYDRAULIC CONVERTIBLE TOP

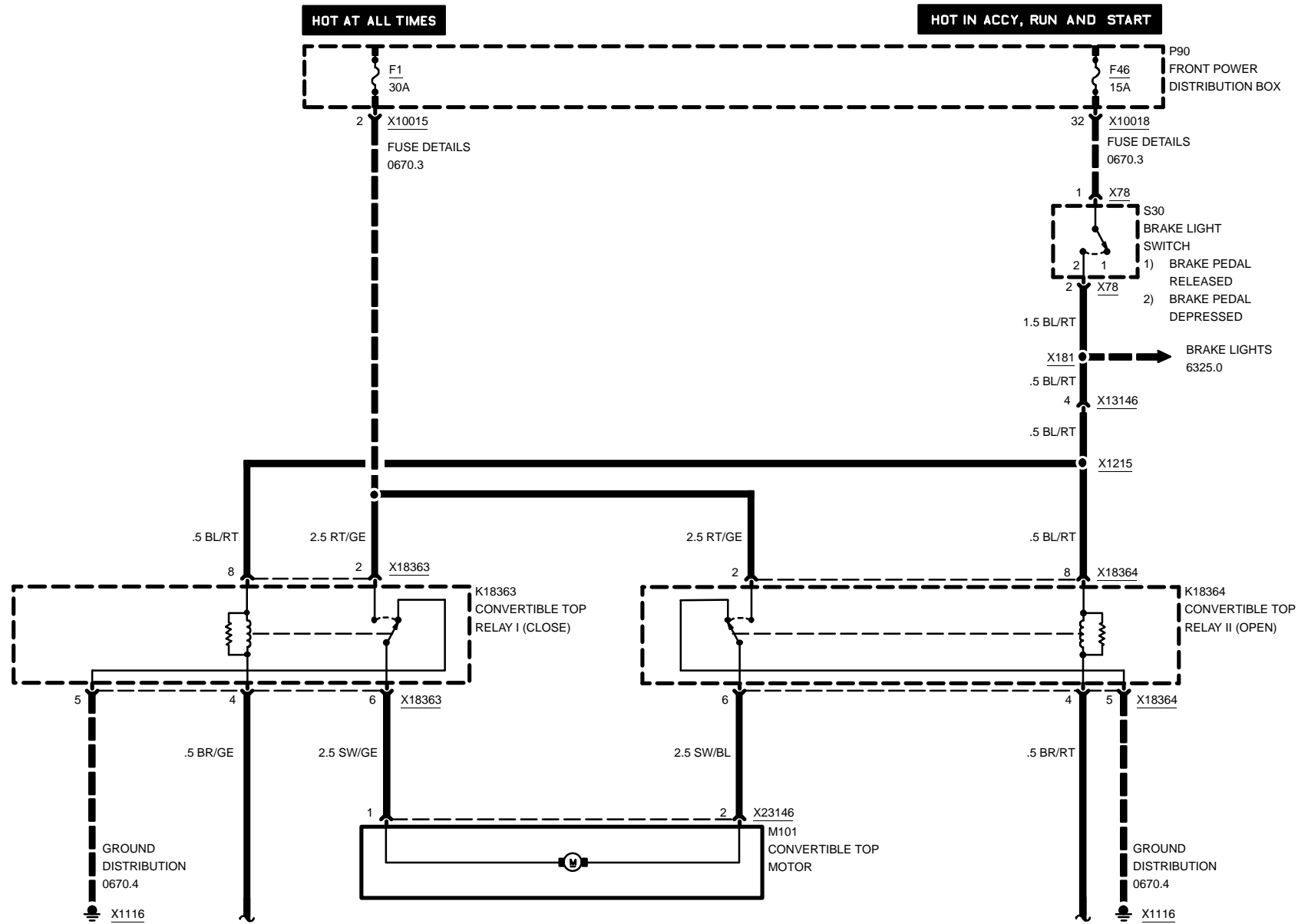

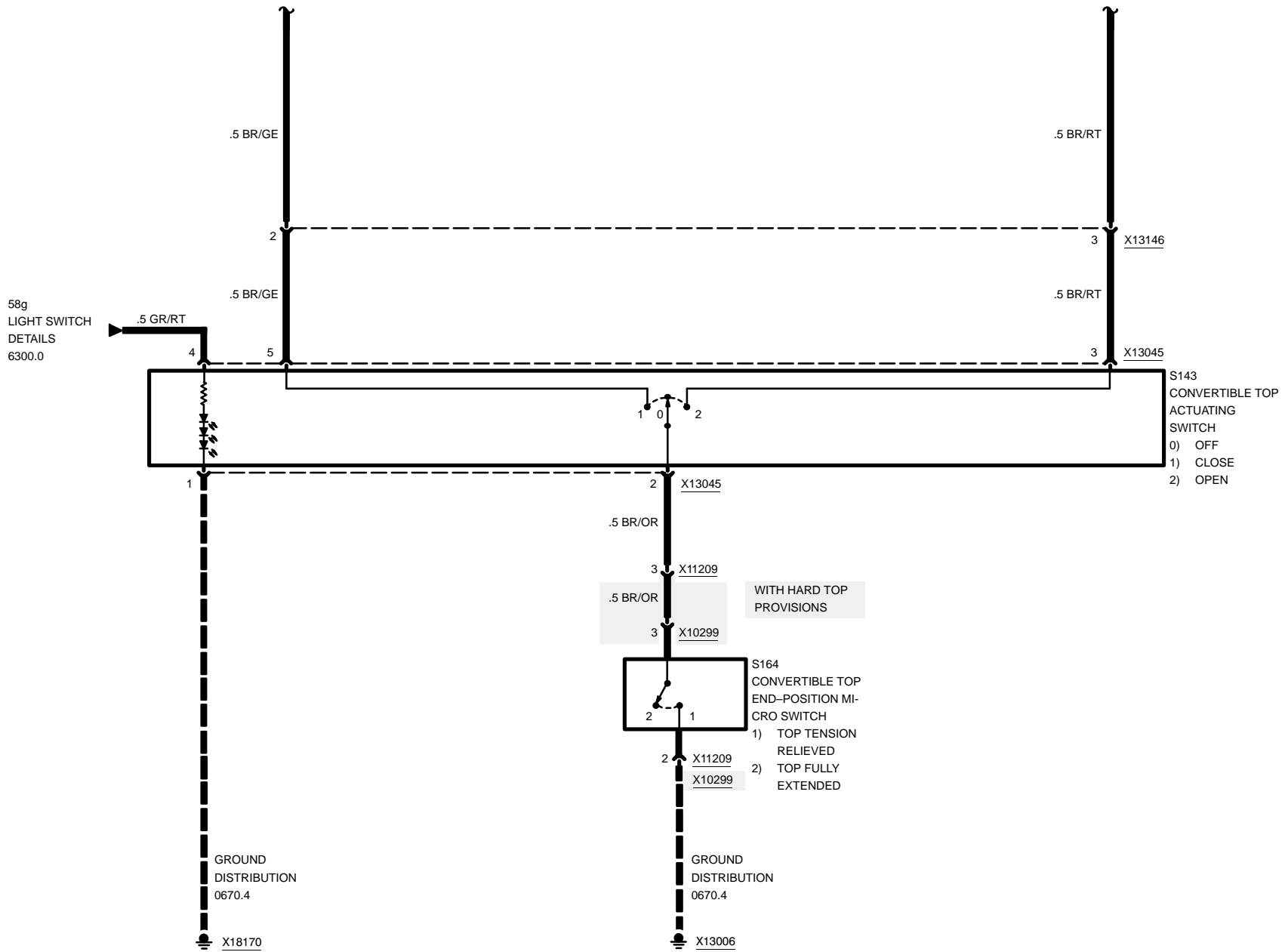

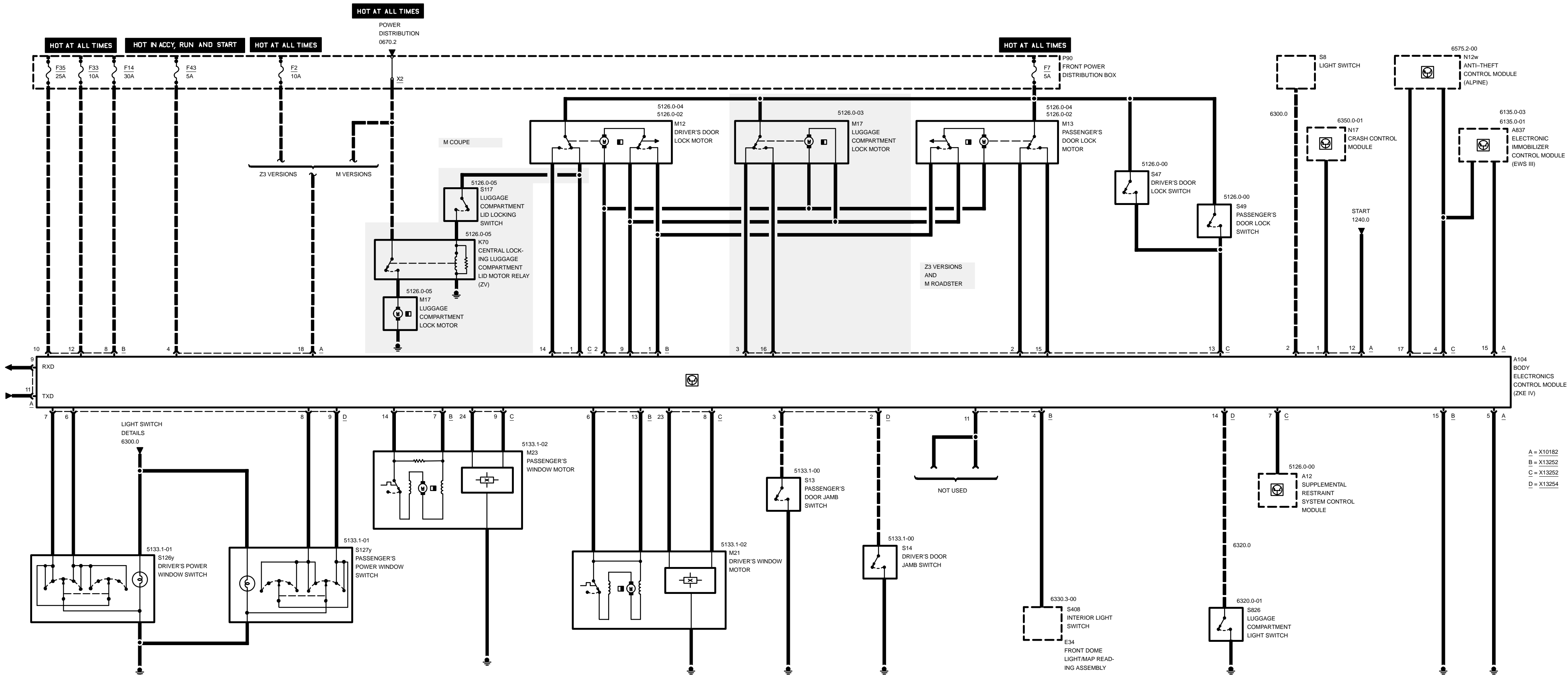



Z3

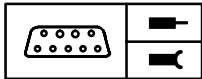

Pin Assignments

F = X10182	18 Pins, black
G = X13252	15 Pins, black
H = X13253	26 Pins, yellow
I = X13254	26 Pins, green

X10182

Pin	Type	Description/Function	Connection
1	E	Crash signal	Crash control module
2	E	Light signal	Light switch
3		Not used	
4	E	Power supply	Front power distribution box, fuse 43
5	M	Ground	Ground point
6		Not used	
7		Not used	
8		Not used	
9	A	Diagnosis RxD signal	Data link connector
10		Not used	
11	E/A	Diagnosis TxD signal	Data link connector
12	E	Start signal	Starter
13		Not used	
14		Not used	
15	A	Drive away protection	Electronic immobilizer control module (EWS III)
16		Not used	
17		Not used	
18	E	Power supply	Front power distribution box

E = Input, A = Output, M = Ground

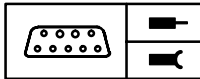

Z3

**Pin Assignments****X13252**

Pin	Type	Description/Function	Connection
1	A	Central arrest signal	Lock motors
2	A	Unlock signal	Lock motors
3		Not used	
4	A	Automatic interior light signal	Interior light
5		Not used	
6	A	Voltage supply	Power window motor driver's door
7	A	Voltage supply	Power window motor passenger's door
8	E	Power supply	Front power distribution box, fuse 14
9	A	Lock signal	Lock motors
10	E	Power supply	Front power distribution box, fuse 35
11	A	Consumer cut-off signal	Not used
12	E	Power supply	Front power distribution box, fuse 33
13	E	Motor signal	Power window motor driver's door
14	E	Motor signal	Power window motor passenger's door
15	M	Ground	Ground point

X13253

Pin	Type	Description/Function	Connection
1	E	Unlock signal	Door lock motor driver's door
2	E	Unlock signal	Door lock motor passenger's door
3	E	Unlock signal	Luggage compartment lock motor (Z3 Versions and M Roadster)
4	E	Data signal	Anti-theft system control module (Alpine)
5		Not used	
6		Not used	
7	E	Crash signal	Supplemental restraint system control module
8	E	Revolution signal	Power window motor driver's door
9	E	Revolution signal	Power window motor passenger's door

E = Input, A = Output, M = Ground

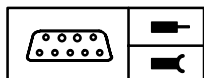

Z3

**Pin Assignments**

Pin	Type	Description/Function	Connection
10		Not used	
11		Not used	
12		Not used	
13	E	Central arrest signal	Door lock switches
14	E	Lock signal driver's door	Door lock motor driver's door
15	E	Lock signal passenger's door	Door lock motor passenger's door
16	E	Lock signal luggage compartment lid	Luggage compartment lock motor (Z3 Versions and M Roadster)
17	E	Data signal	Anti-theft system control module (Alpine)
18		Not used	
19		Not used	
20		Not used	
21		Not used	
22		Not used	
23	A	Plus supply (revolution)	Power window's motor driver's side
24	A	Voltage supply (revolution)	Power window's motor passenger's side
25		Not used	
26		Not used	

X13254

Pin	Type	Description/Function	Connection
1		Not used	
2	E	Door signal	Door jamb switch driver's door
3	E	Door signal	Door jamb switch passenger's door
4		Not used	
5		Not used	
6	E	OPEN signal	Power window switch driver's door
7	E	CLOSE signal	Power window switch driver's door
8	E	OPEN signal	Power window switch passenger's door
9	E	CLOSE signal	Power window switch passenger's door
10		Not used	

E = Input, A = Output, M = Ground



Z3

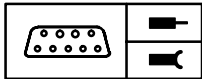

Pin Assignments

Pin	Type	Description/Function	Connection
11		Not used	
12		Not used	
13		Not used	
14	E	Luggage compartment signal	Luggage compartment light switch
15		Not used	
16		Not used	
17		Not used	
18		Not used	
19		Not used	
20		Not used	
21		Not used	
22		Not used	
23		Not used	
24		Not used	
25		Not used	
26		Not used	

E = Input, A = Output, M = Ground

CENTRAL BODY ELECTRONICS (ZKE IV)

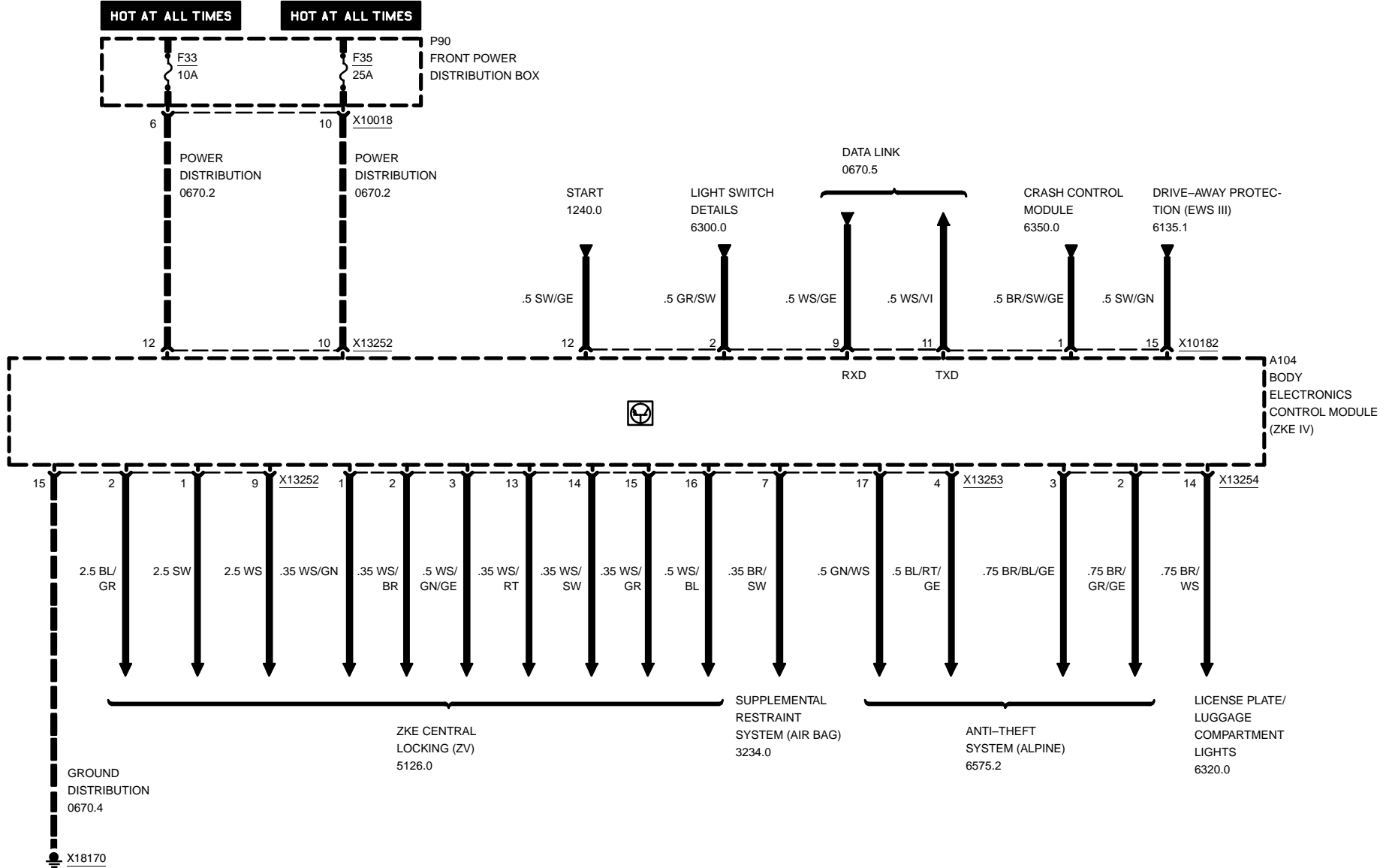



Z3

CENTRAL BODY ELECTRONICS (ZKE IV)

HOT AT ALL TIMES

POWER
DISTRIBUTION
0670.2

HOT AT ALL TIMES

HOT IN ACCY, RUN AND START

HOT AT ALL TIMES

P90
FRONT POWER
DISTRIBUTION BOX

NOT USED

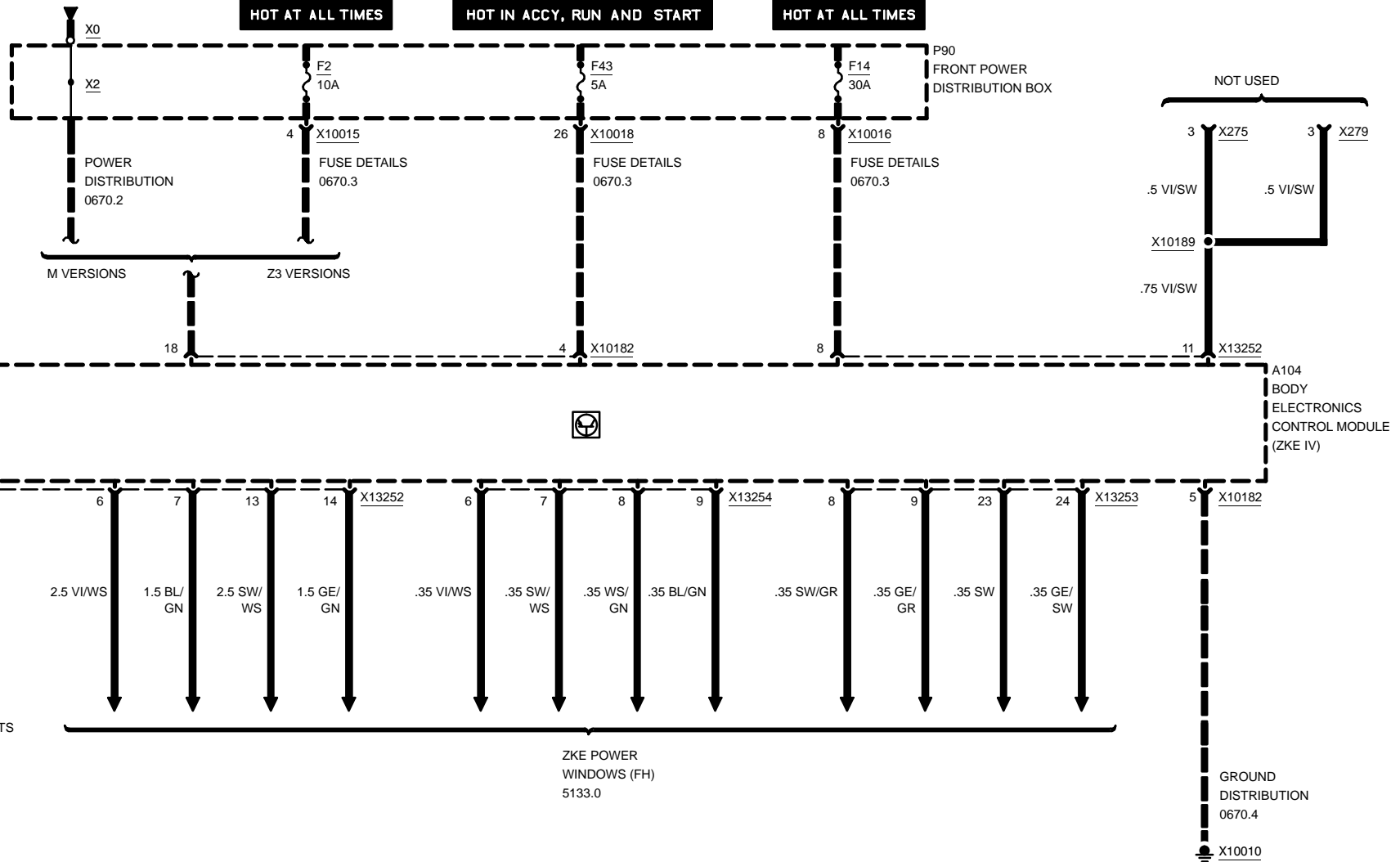

03/00

6100.0-01

1999

6133.0 HORN

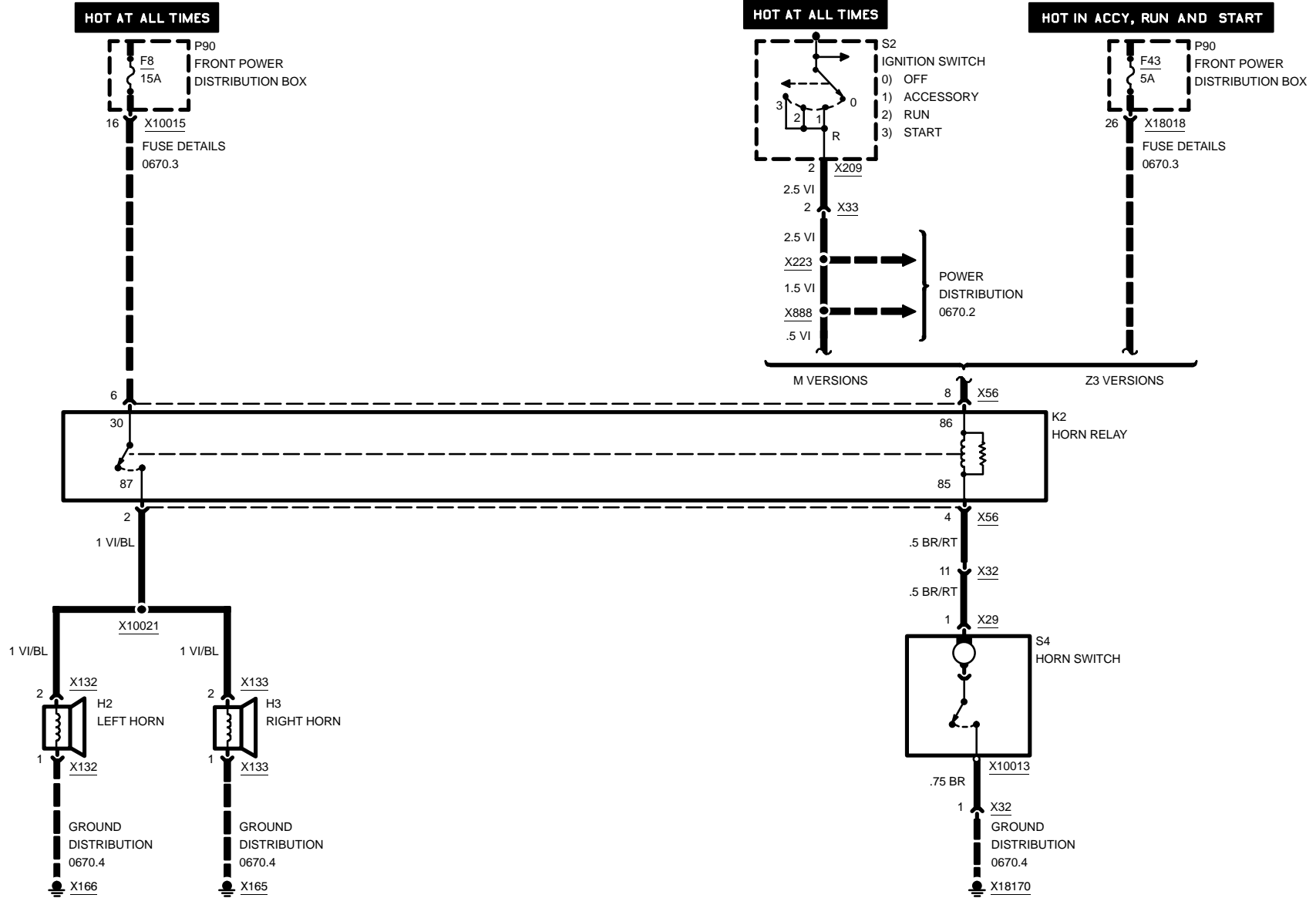



6135.1 DRIVE-AWAY PROTECTION (EWS III)

M VERSIONS

Z3

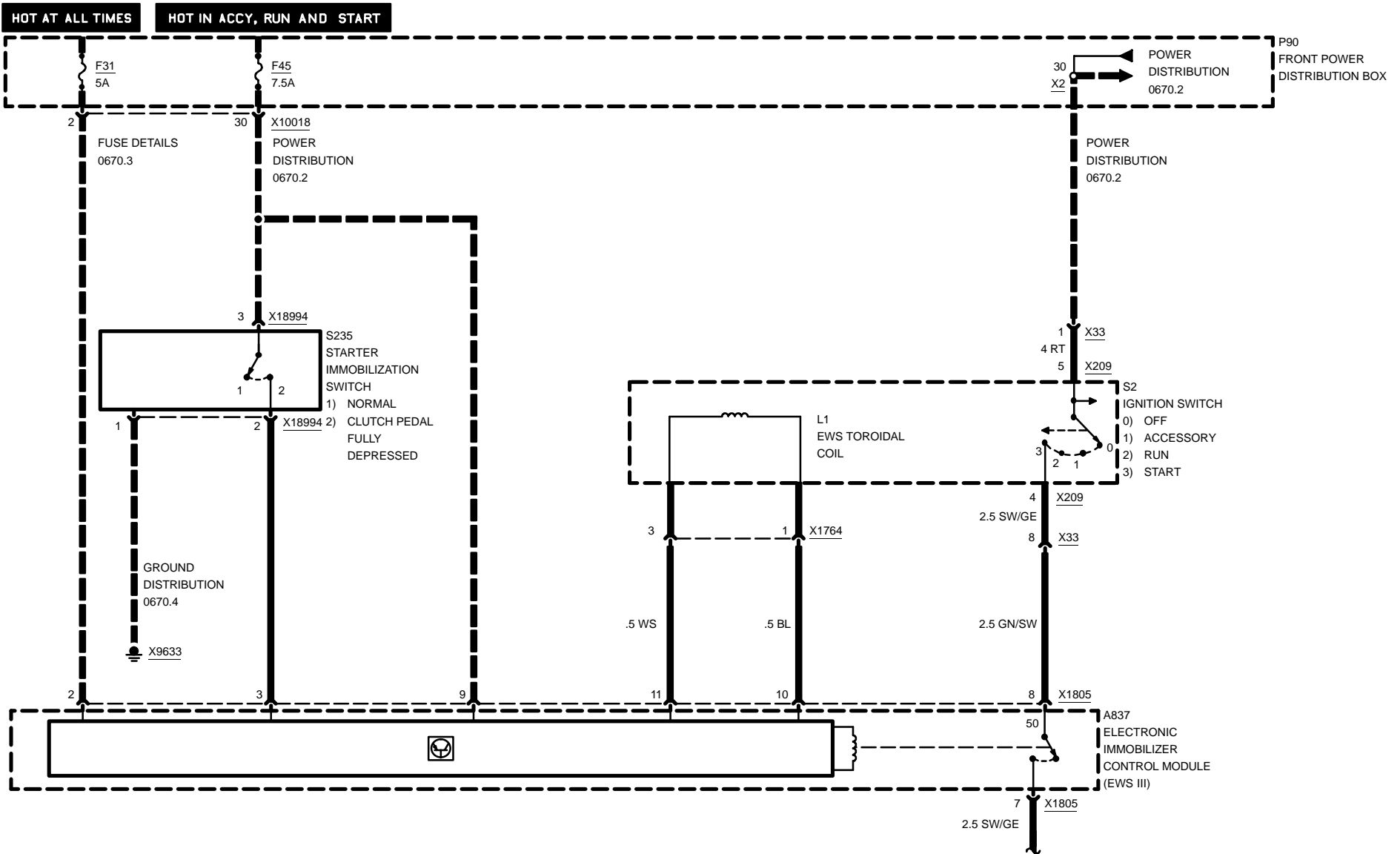

03/00

6135.1-00

1999

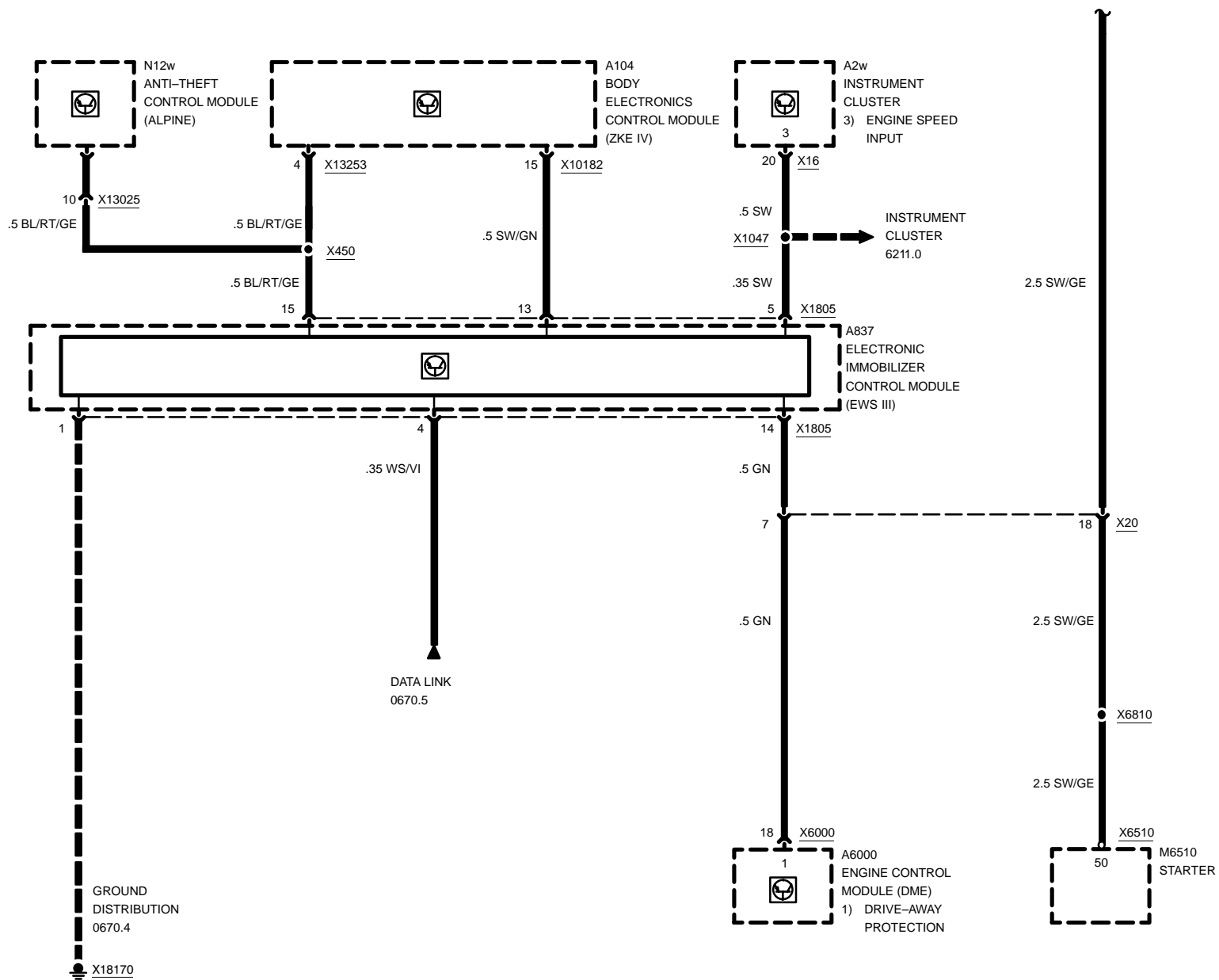



DRIVE-AWAY PROTECTION (EWS III)

Z3 VERSIONS

Z3

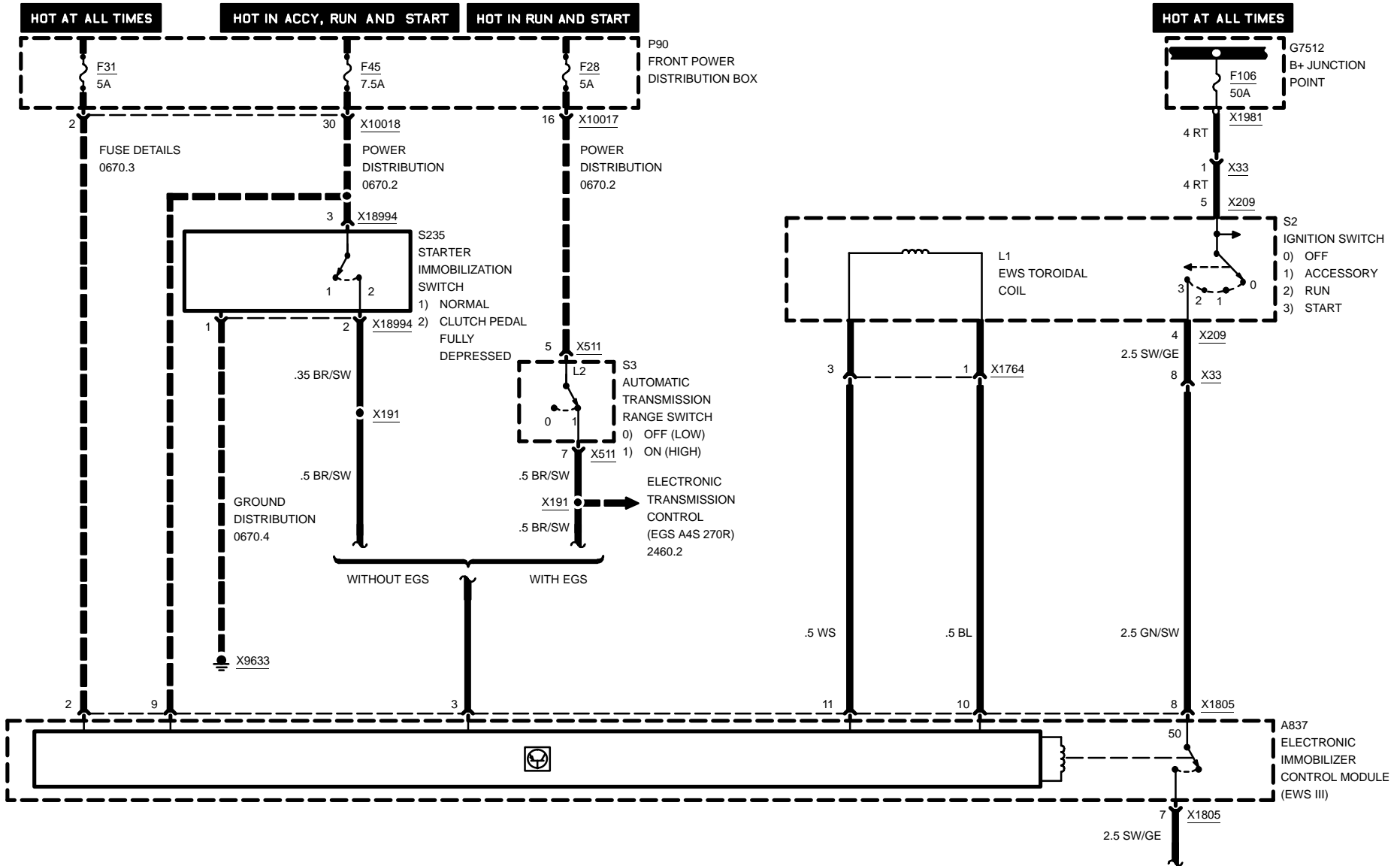

03/00

6135.1-02

1999

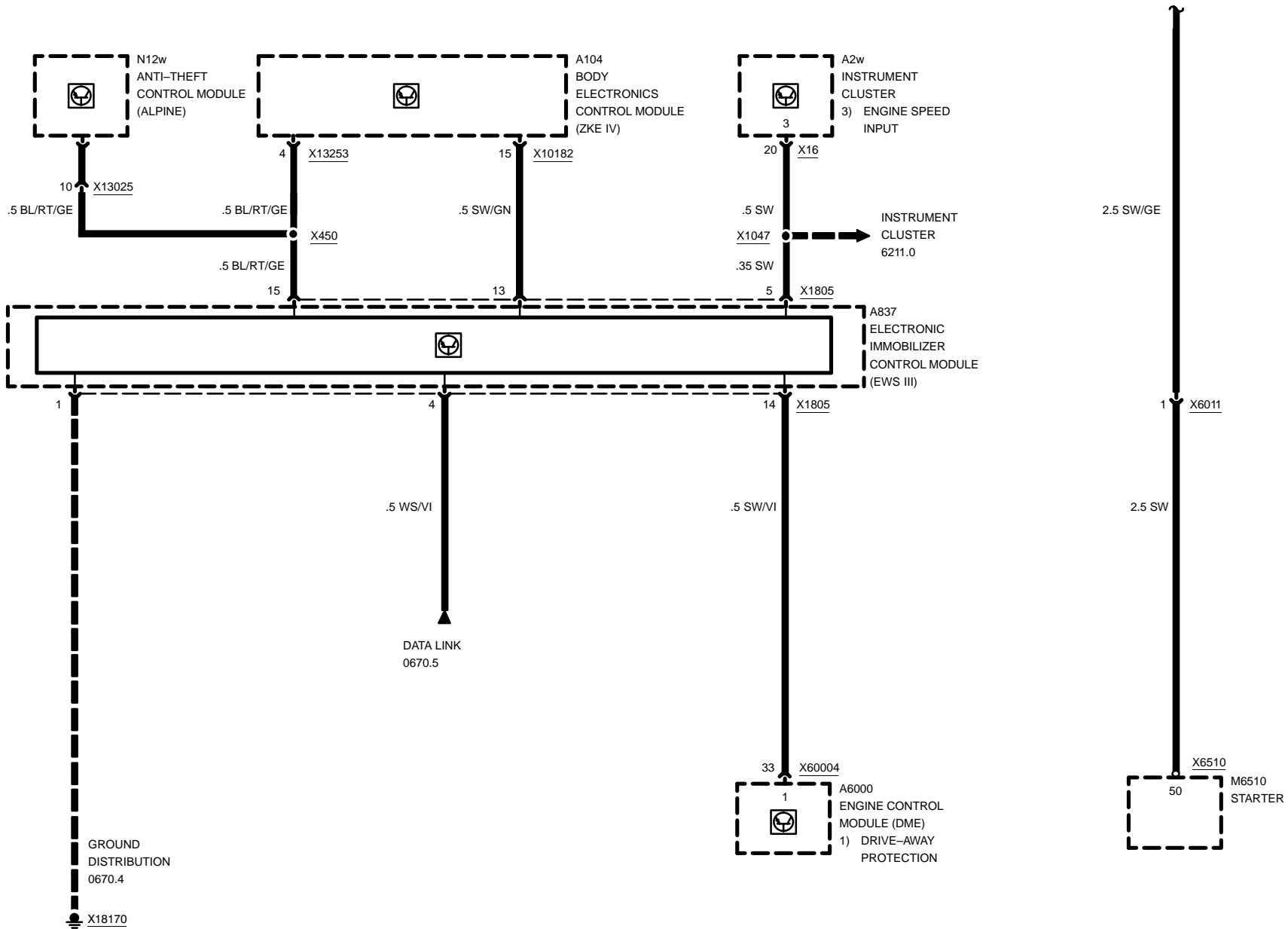

6160.1 WIPER/WASHER MODULE (WWM)

HIGH

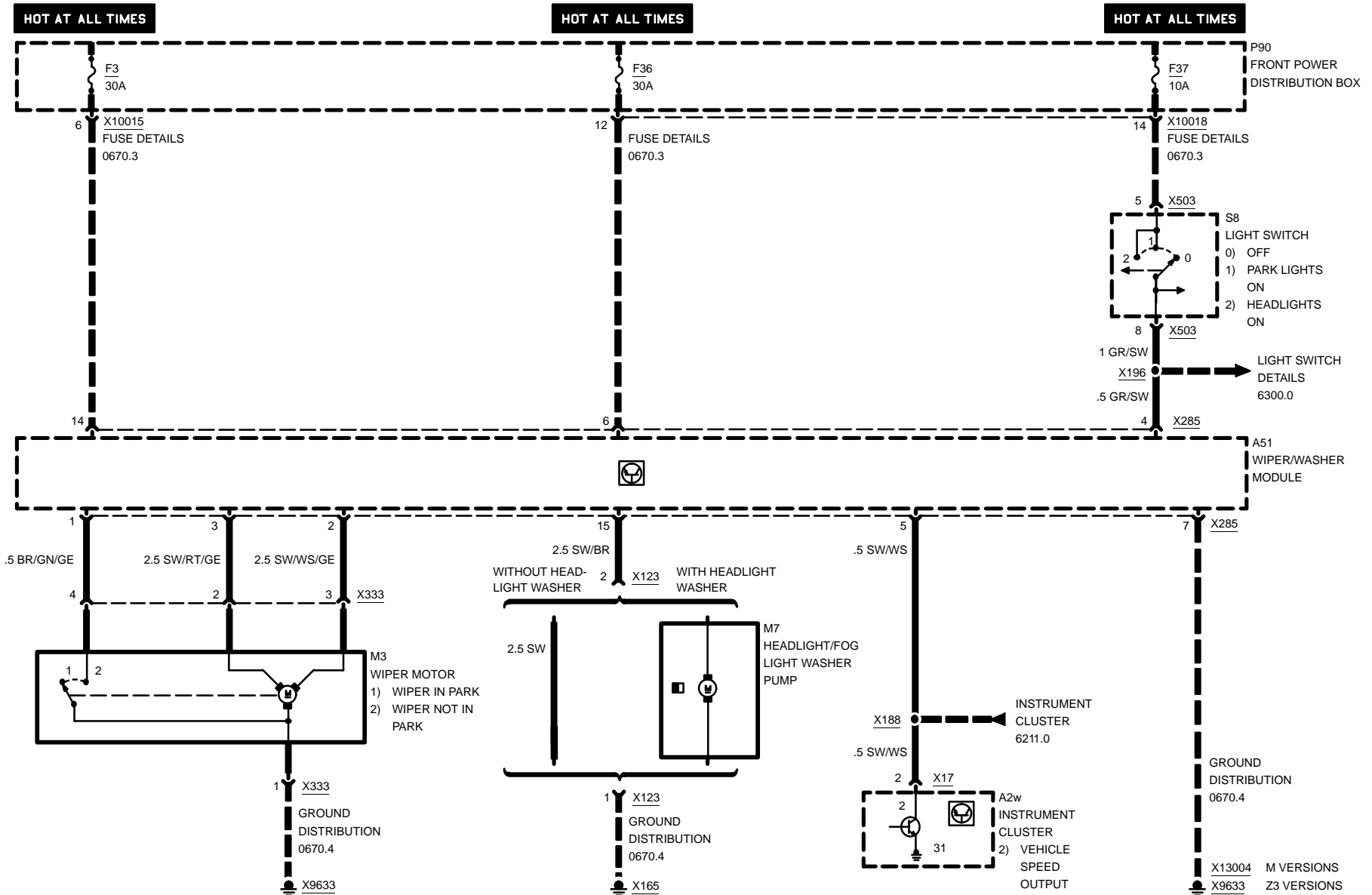

WIPER/WASHER MODULE (WWM) HIGH

ROADSTER

HOT IN ACCY, RUN AND START

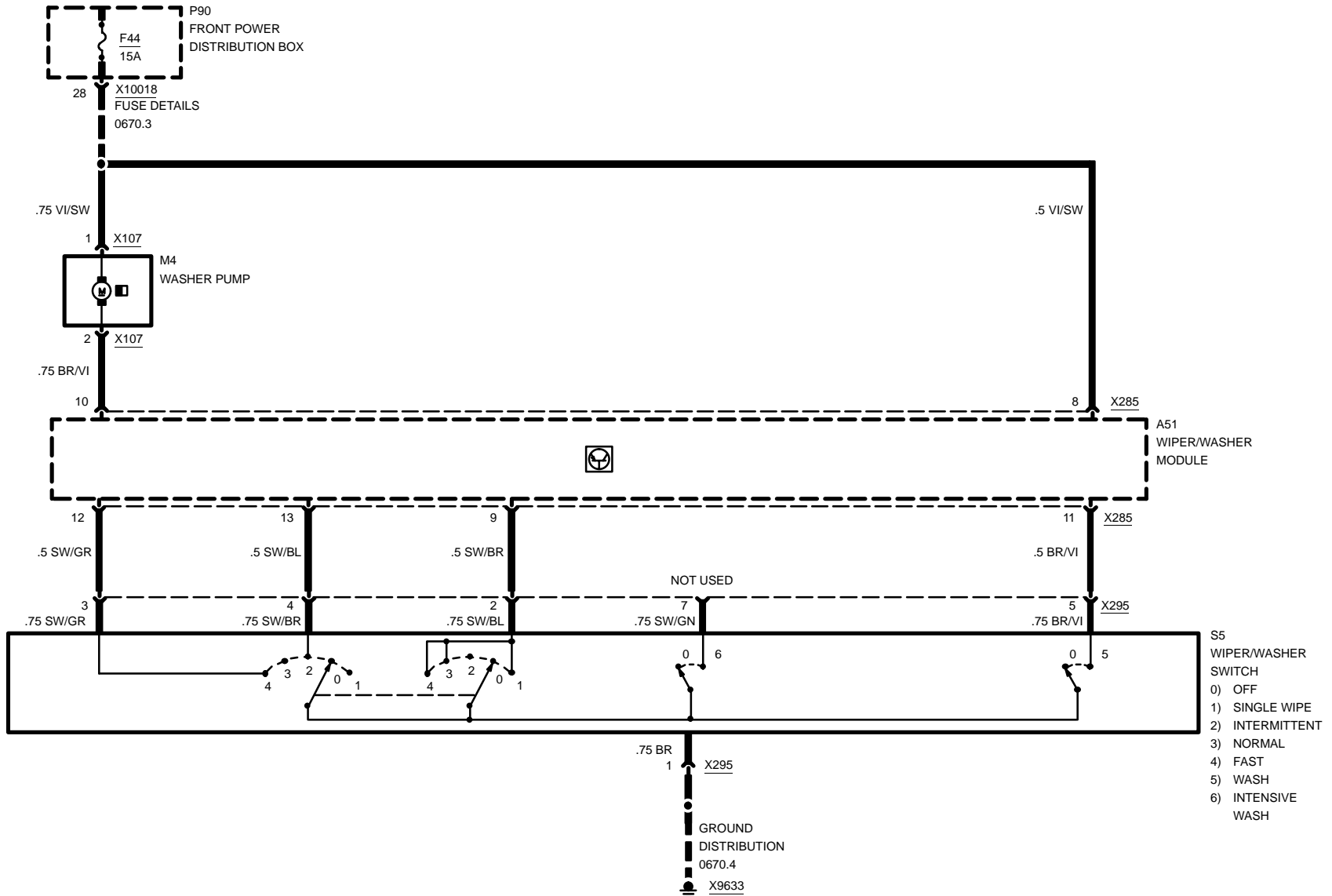



WIPER/WASHER MODULE (WWM)

WIPER/WASHER (HIGH)

COUPE

HOT IN ACCY, RUN AND START

HOT AT ALL TIMES

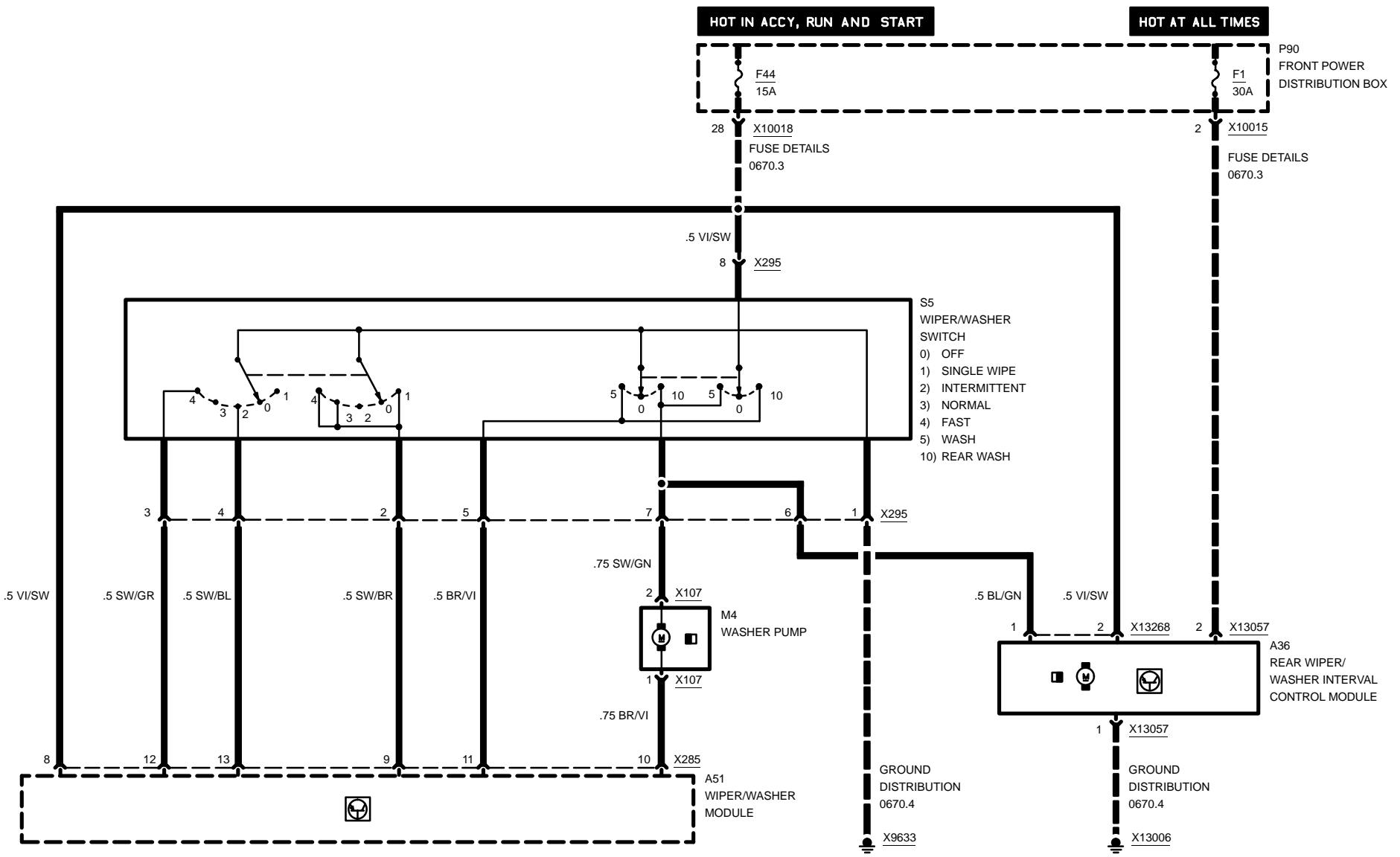

03/00

6160.1-02

1999

6167.1 HEADLIGHT WASHER (SRA)

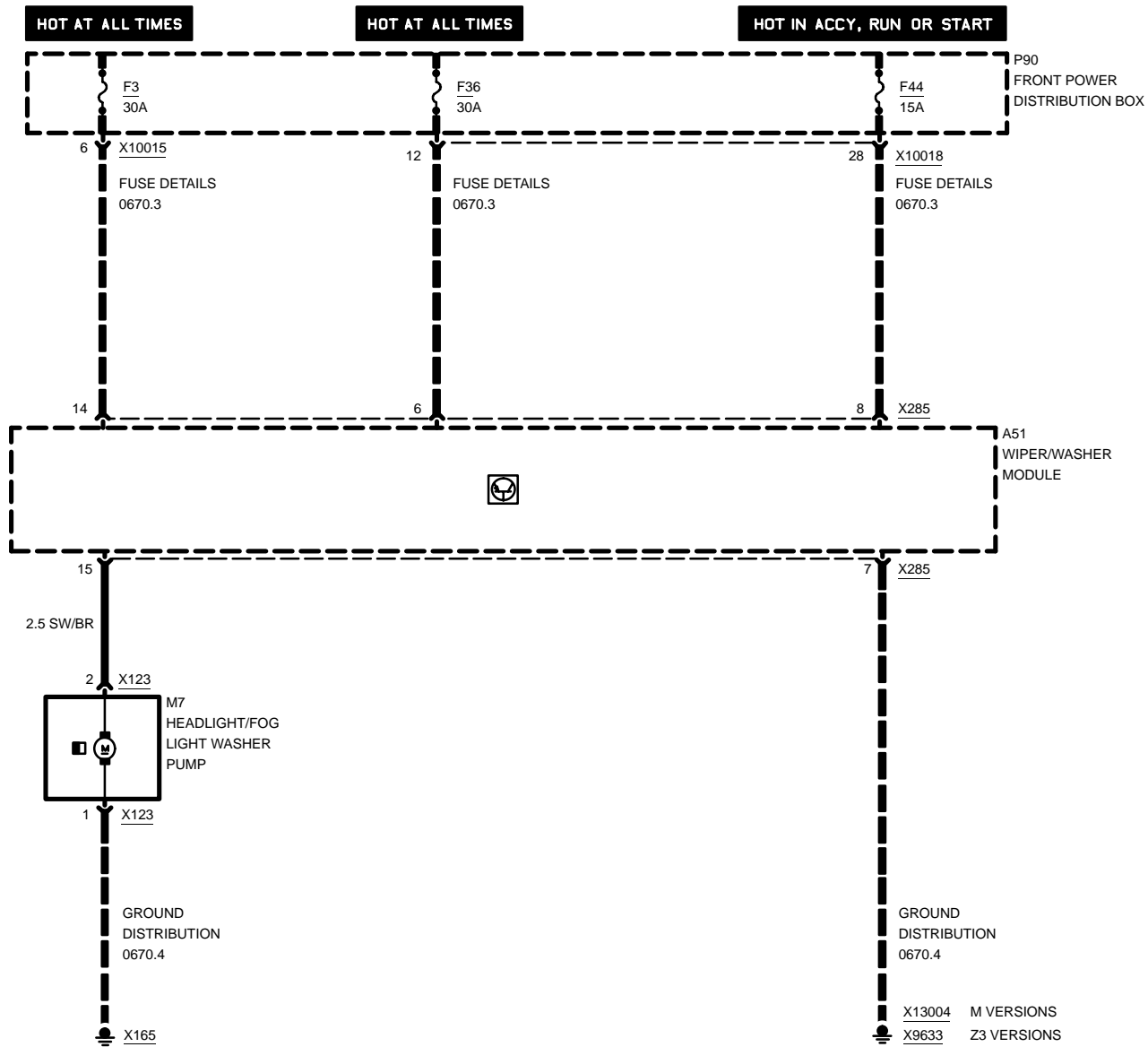

6169.0 WINDSHIELD WASHER JET HEATERS

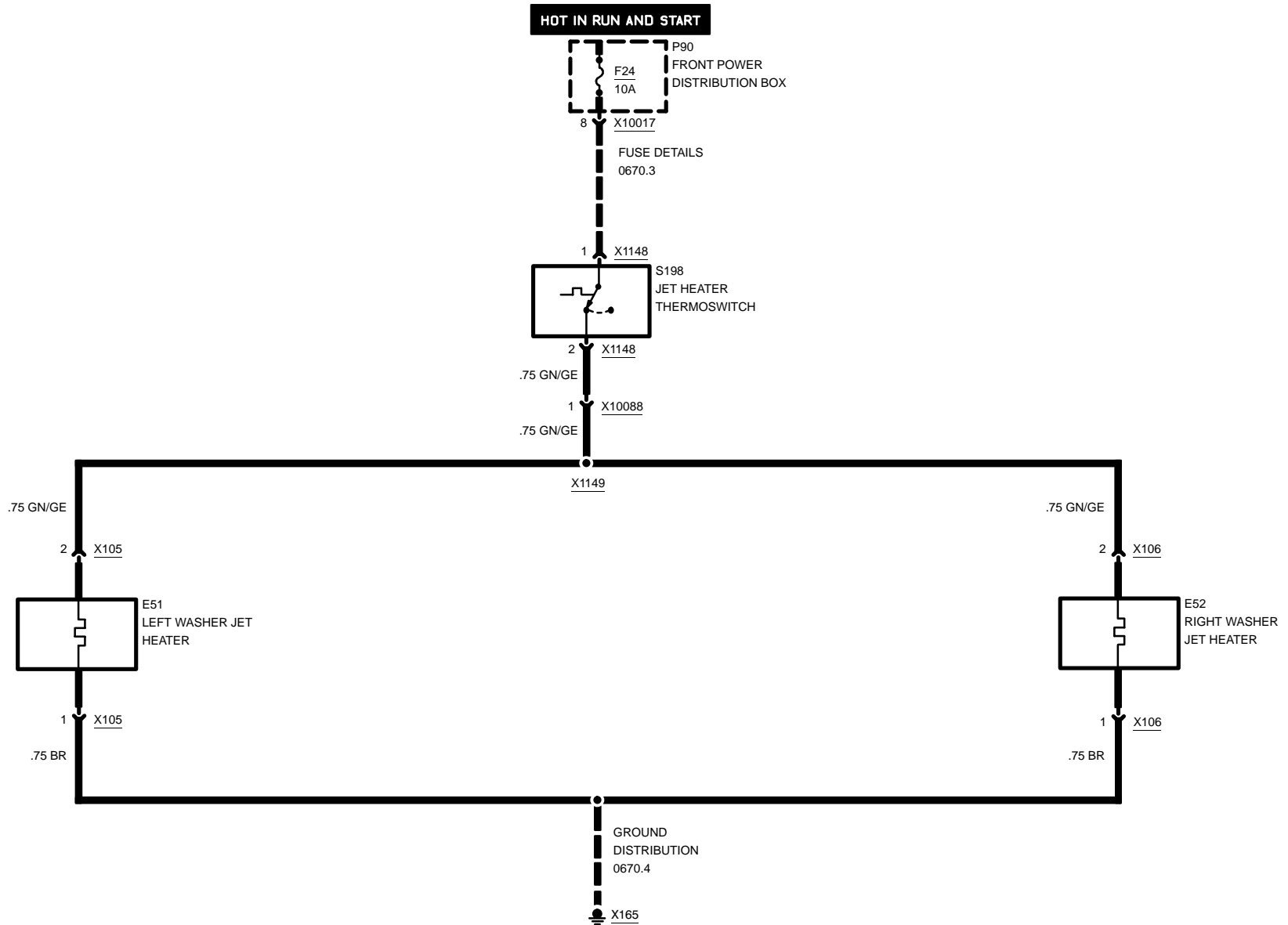

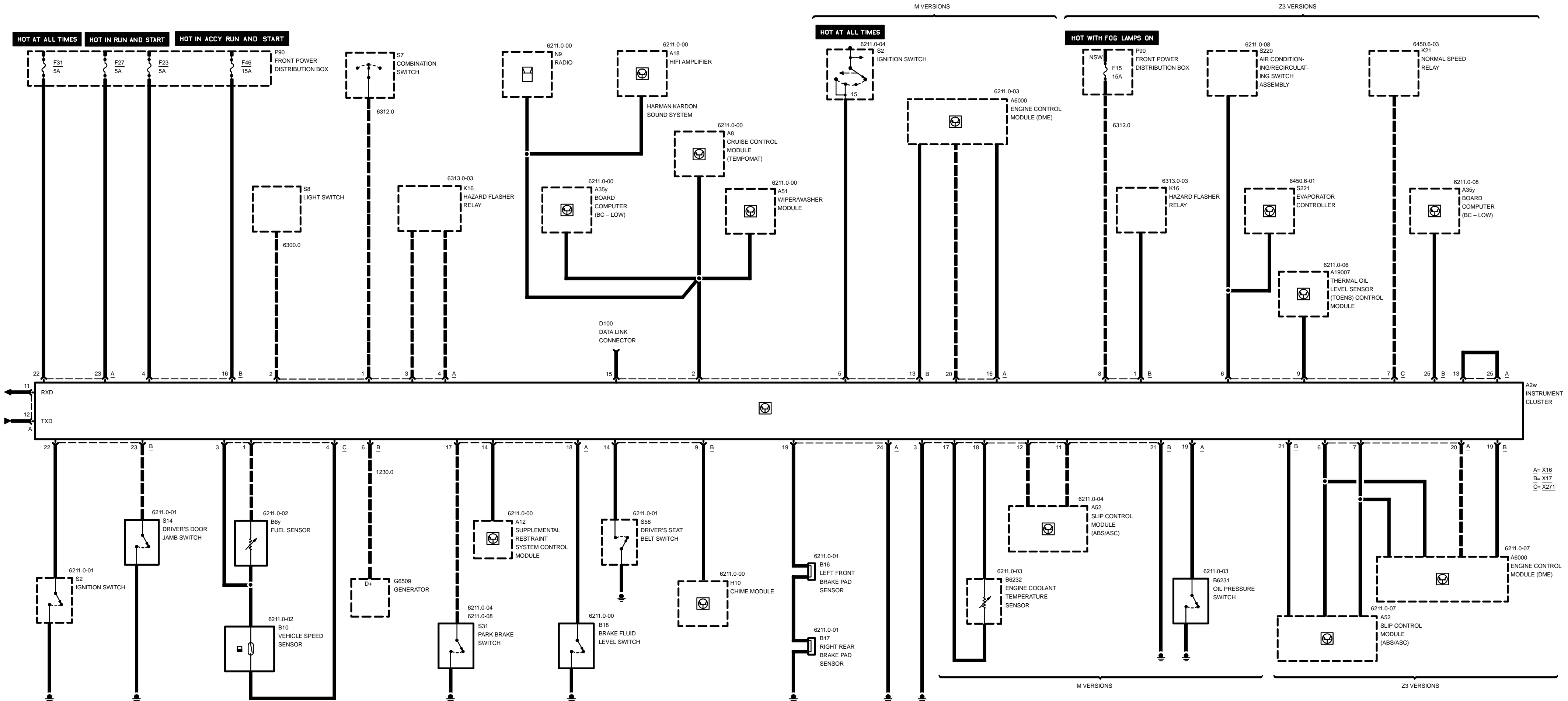



Z3

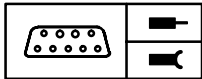

Pin Assignments

X16

Pin	Type	Description/Function	Connection
1	E	High beam indicator control	Combination switch
2	E	Terminal 58g, instrument illumination power	Light switch (dimmer)
3	E	Right turn signal indicator control	Hazard flasher relay
4	E	Left turn signal indicator control	Hazard flasher relay
5		Not used	
6	E/A	CAN bus high	Engine/slip control module (Z3 Versions)
7	E/A	CAN bus low	Engine/slip control module (Z3 Versions)
8		Not used	
9		Not used	
10		Not used	
11	A	Diagnosis RXD signal	Data link connector (M Versions)
12	E/A	Diagnosis TXD signal	Data link connector
13	E/A	CAN jumper	Instrument cluster (Z3 Versions)
14	E	Airbag warning lamp (SRS) control	Supplemental restraint system control module
15		Not used	
16	E	"Check engine" indicator control	Engine control module (DME) (M Versions)
17	E	Park brake warning lamp control	Park brake switch
18	E	Brake fluid warning lamp control	Brake fluid level switch
19	E	Brake pad wear warning lamp control	Brake pad sensors
20	E	Crankshaft RPM speed signal TD	Engine control module (DME)
21		Not used	
22	E	Voltage supply, terminal 30	Front power distribution box, fuse 31
23	E	Voltage supply, terminal 15 for indicator and warning lamps	Front power distribution box, fuse 27
24	M	Ground supply, terminal 31 for instrument cluster electronics	Ground point
25	E/A	CAN jumper	Instrument cluster (Z3 Versions)
26		Not used	

E = Input, A = Output, M = Ground



Z3

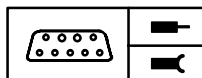

Pin Assignments

X17

Pin	Type	Description/Function	Connection
1	E	Trailer turn signal indicator control	Hazard flasher relay (Z3 Versions)
2	A	Vehicle speed signal	Various control modules
3	M	Ground supply, terminal 31 for indicator and warning lamps	Ground point
4	E	Voltage supply, terminal 15 for instrument cluster electronics	Front power distribution box, fuse 23
5	E	Voltage supply, terminal 15 for battery charge indicator	Ignition switch, terminal 15 (M Versions)
6	E	Ground supply, terminal 61 for battery charge indicator	Generator
7		Not used	
8	E	Fog light indicator control	Front power distribution box, fuse 15 (Z3 Versions)
9	A	Sound tone signal	Chime module
10		not used	
11	E	Slip control system warning lamp (ABS) control	Slip control module (ABS/ASC) (M Versions)
12	E	ASC signal	ASC control module (M Versions)
13	A	TI-measurement signal (fuel consumption)	Engine control module (DME) (M Versions)
14	E	Seat belt warning lamp control	Driver's seat belt switch
15	E	SIA reset/service interval indicator reset	Data link connector
16	E	Voltage supply, terminal R	Front power distribution box, fuse 46
17	A	Coolant temperature sensor (-)	Coolant temperature sensor (M Versions)
18	E	Coolant temperature sensor (+)	Coolant temperature sensor (M Versions)
19	E	Oil pressure warning lamp control	Oil pressure switch (M Versions) Engine control module (Z3 Versions)
20		Not used	
21	M	Ground (ASC)	Ground point (M Versions)
21	E	ABS warning lamp (ABS)	Slip control module (ABS/ASC) (Z3 Versions)
22	E	Ignition key warning/audible ignition key warning	Ignition switch

E = Input, A = Output, M = Ground

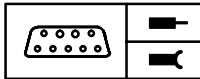

Z3

**Pin Assignments**

Pin	Type	Description/Function	Connection
23	E	Driver's door open	Driver's door jamb switch
24		Not used	
25	E	Fuel consumption signal	Board computer (Z3 Versions)
26		Not used	

X271

Pin	Type	Description/Function	Connection
1	A	Fuel level sensor	Fuel tank sensors
2		Not used	
3	A	Ground supply for fuel tank sensor and vehicle speed sensor	Fuel tank sensor and vehicle speed sensor
4	E	Position signal TW	Vehicle speed sensor
5		Not used	
6	E	A/C-ON-signal	Air condition switch (Z3 Versions)
7	E	Activate A/C	Pressure switch, normal speed relay (Z3 Versions)
8		Not used	
9	E	Oil level signal	Thermal oil level sensor (TOENS) control module (Z3 Versions)
10		Not used	
11		Not used	
12		Not used	

E = Input, A = Output, M = Ground



INSTRUMENT CLUSTER

INDICATORS

Z3

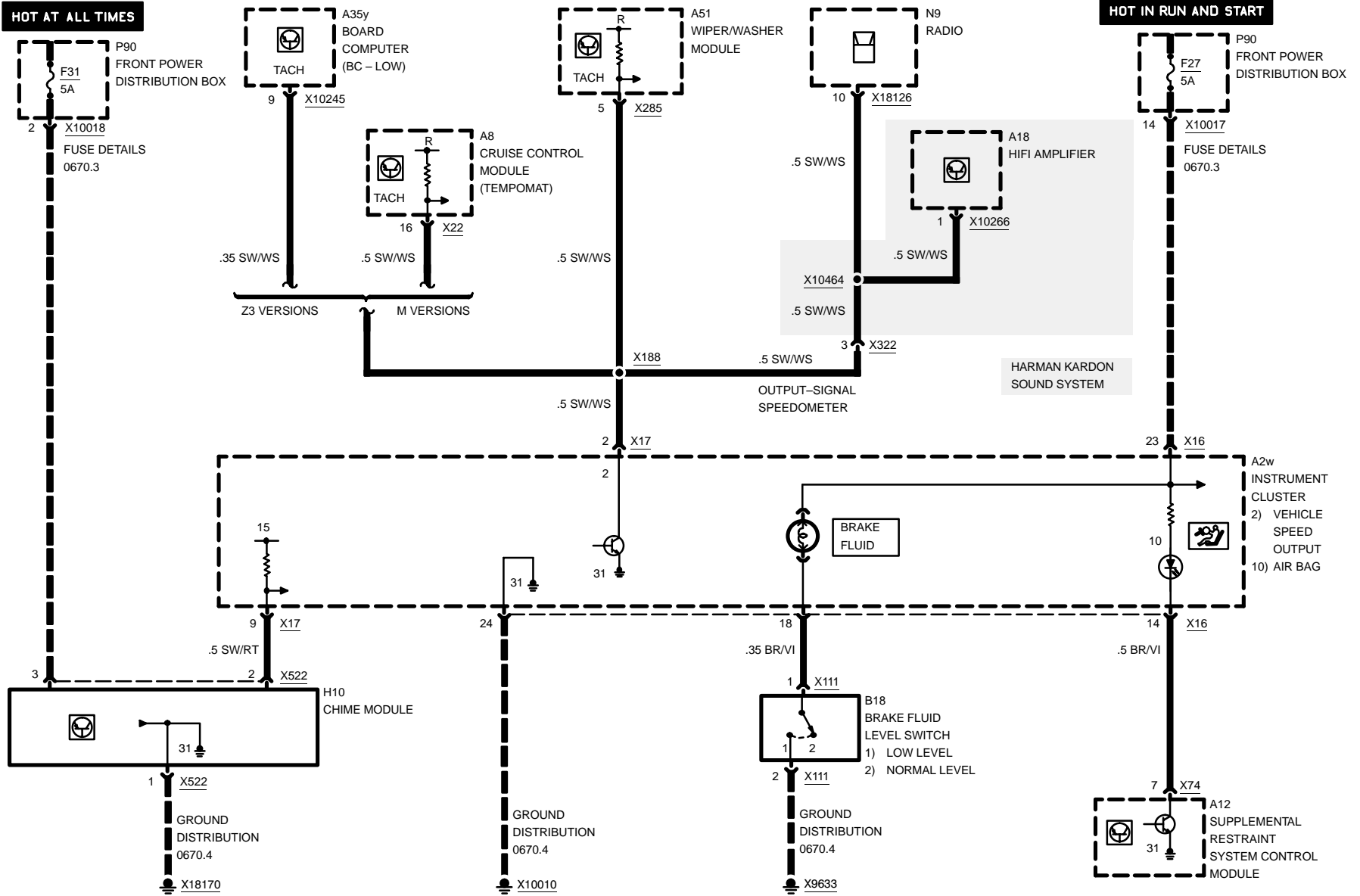

03/00

6211.0-00

1999



INSTRUMENT CLUSTER INDICATORS

Z3

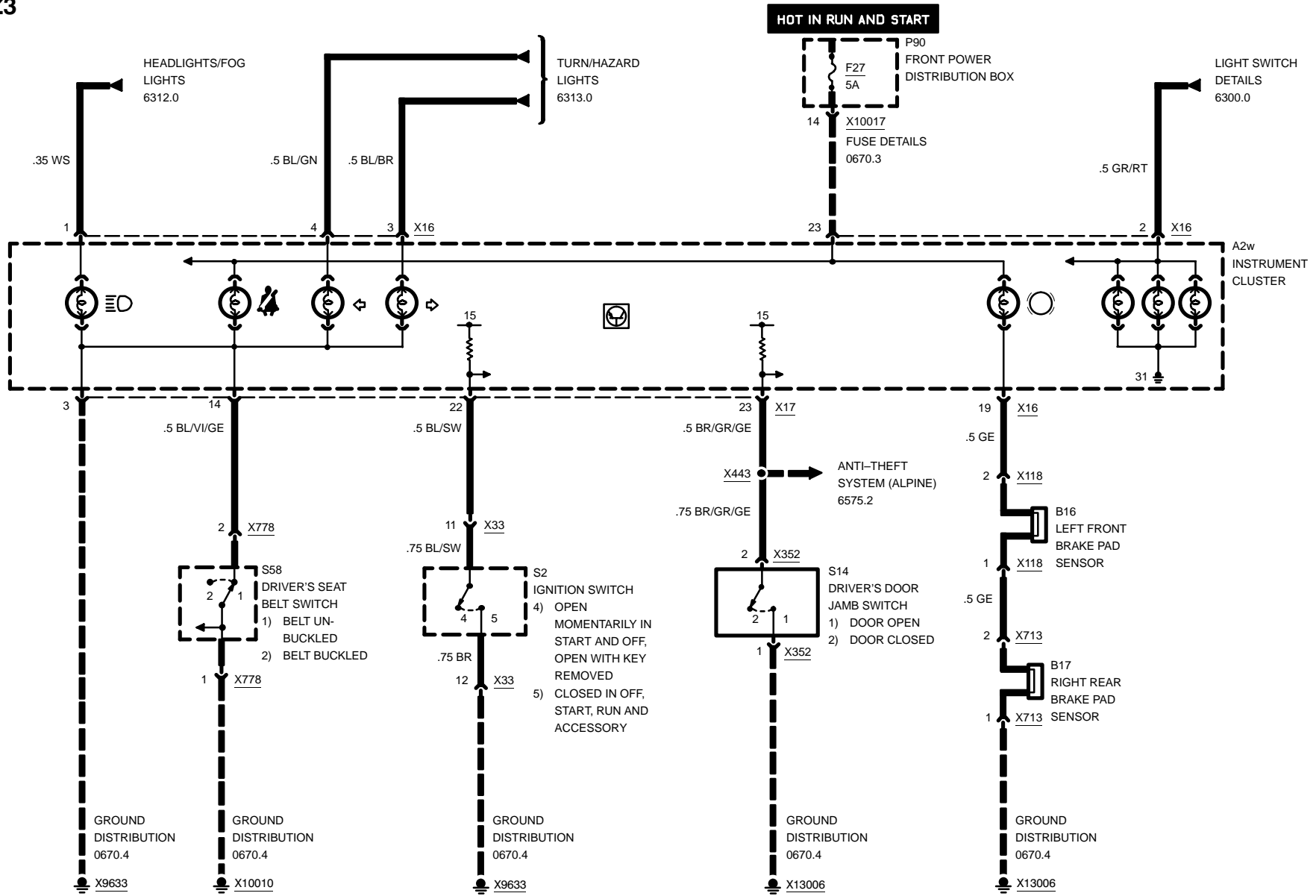

03/00

6211.0-01

1999



INSTRUMENT CLUSTER

INDICATORS

Z3

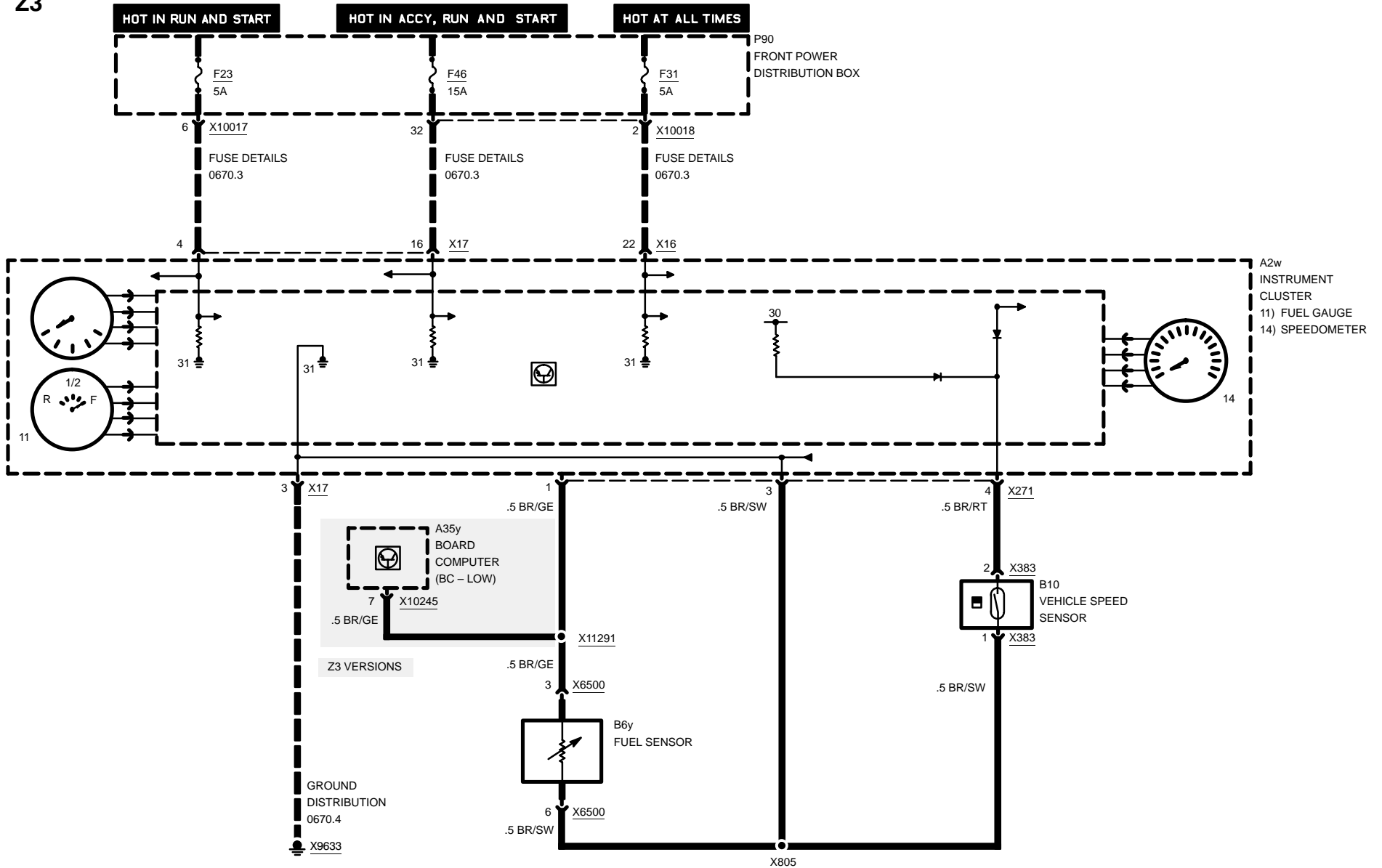

03/00

6211.0-02

1999



INSTRUMENT CLUSTER

INDICATORS

M VERSIONS

Z3

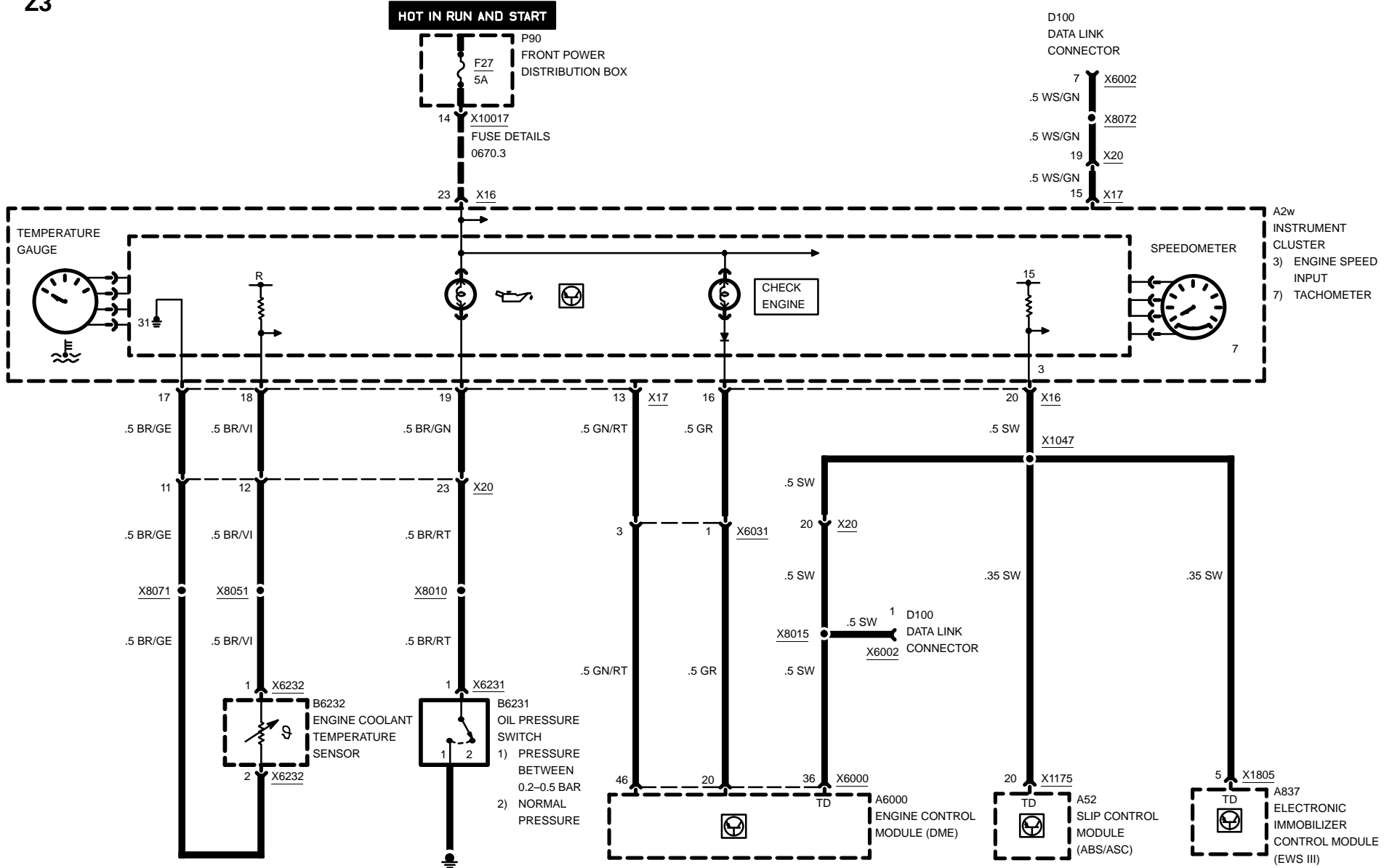

03/00

6211.0-03

1999

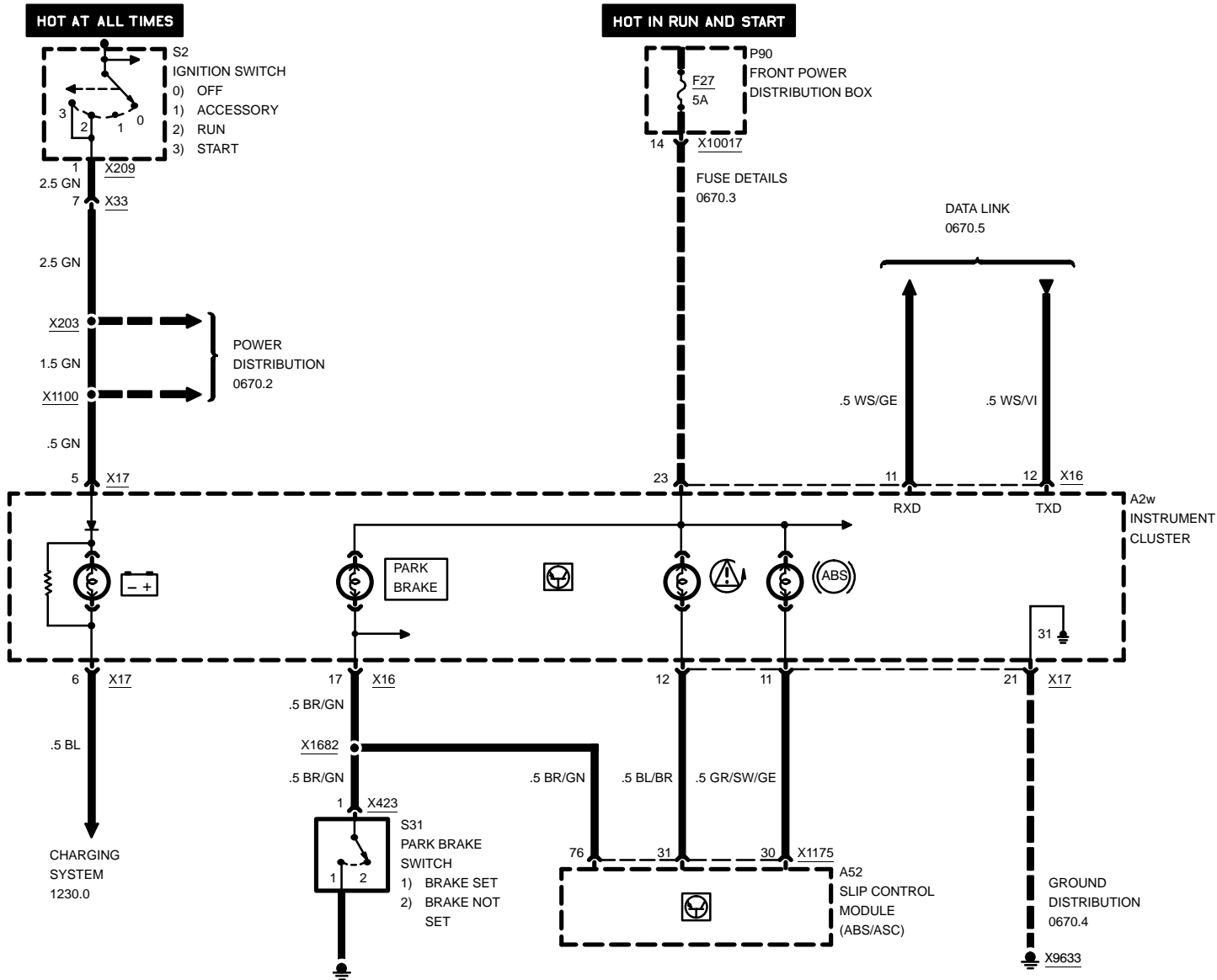



INSTRUMENT CLUSTER INDICATORS

Z3 VERSIONS

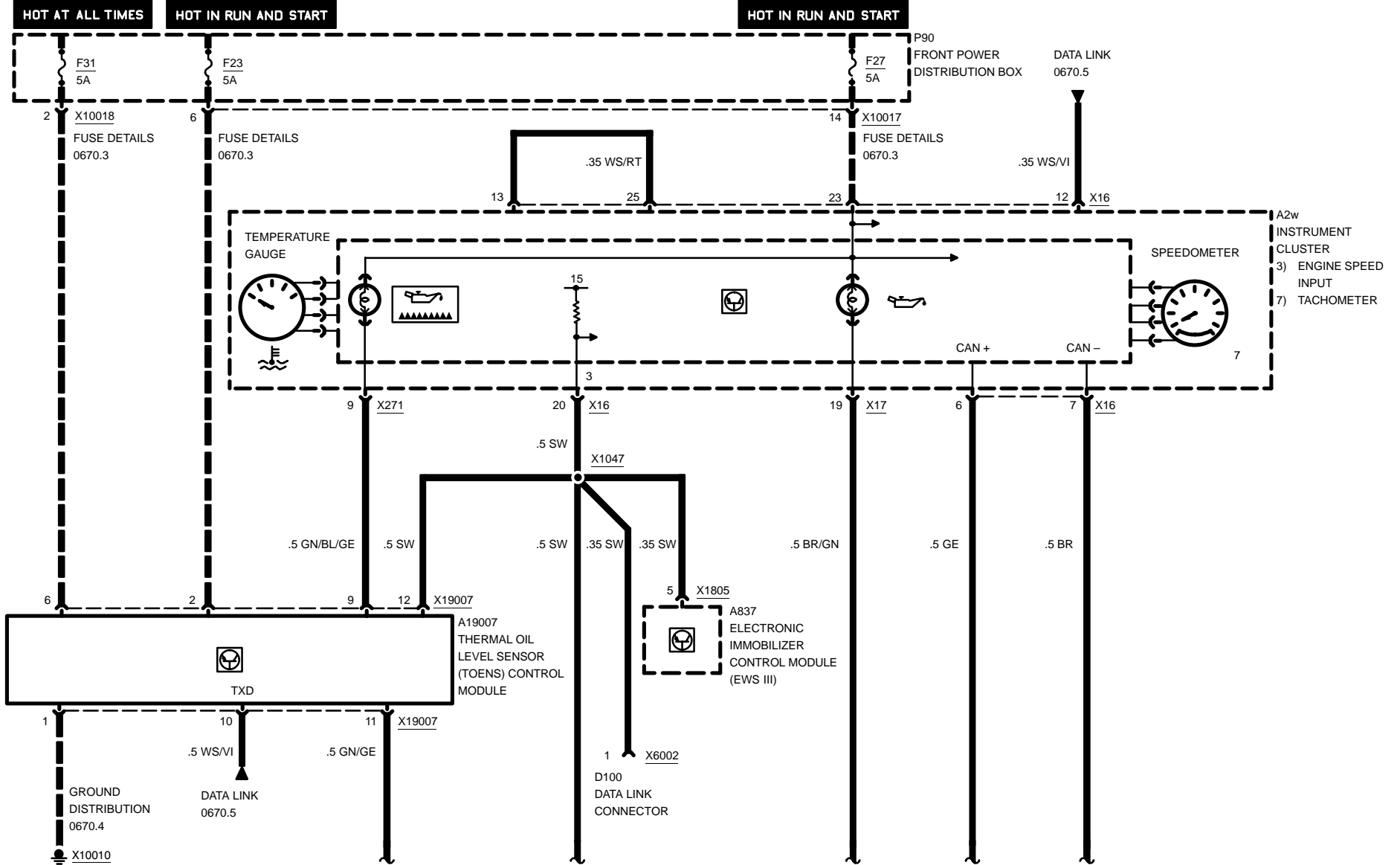

03/00

6211.0-06

1999

HOT IN RUN AND START

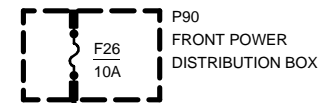

X10017
FUSE DETAILS
0670.3

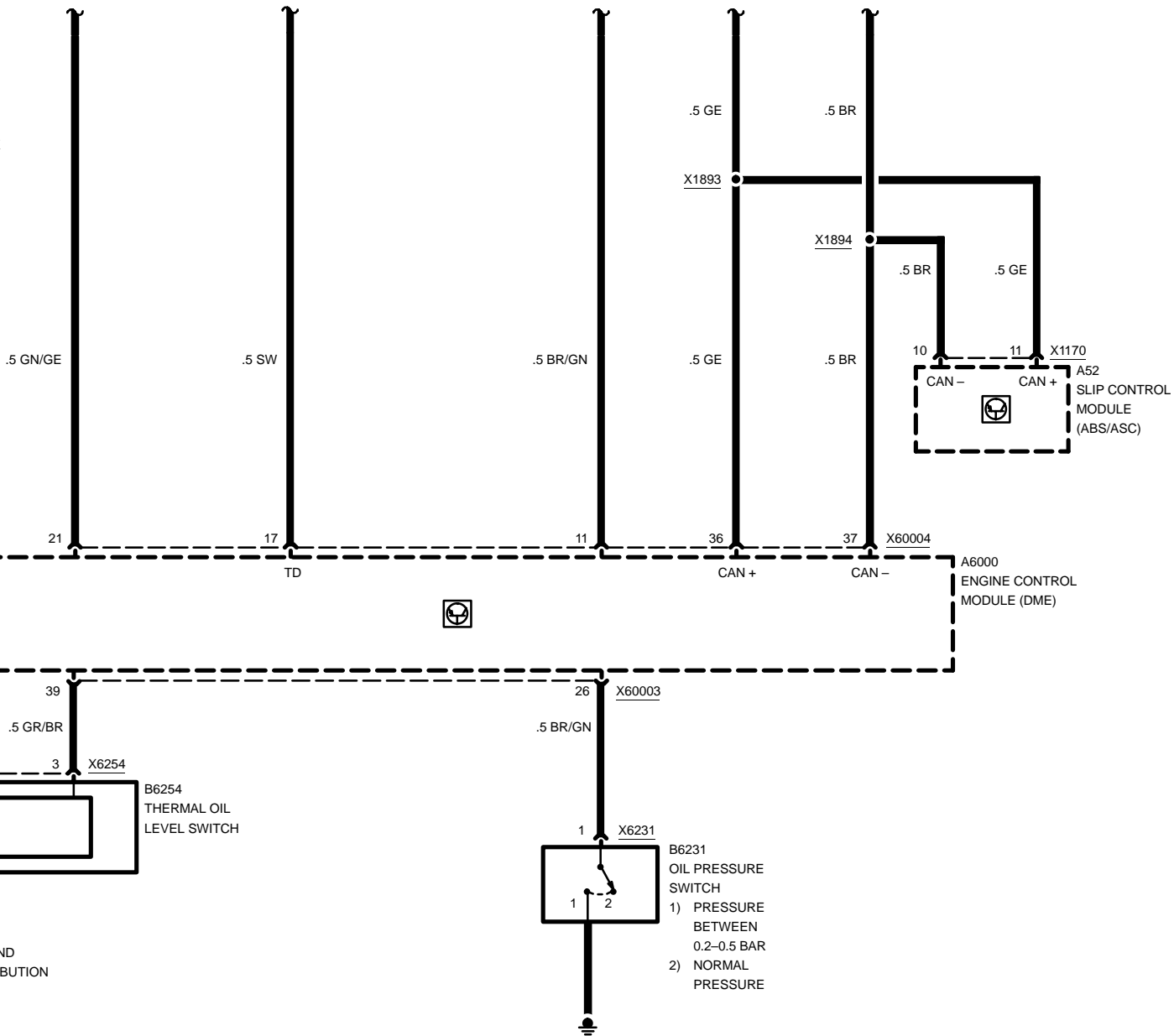



INSTRUMENT CLUSTER INDICATORS

Z3 VERSIONS

03/00

6211.0-08

1999

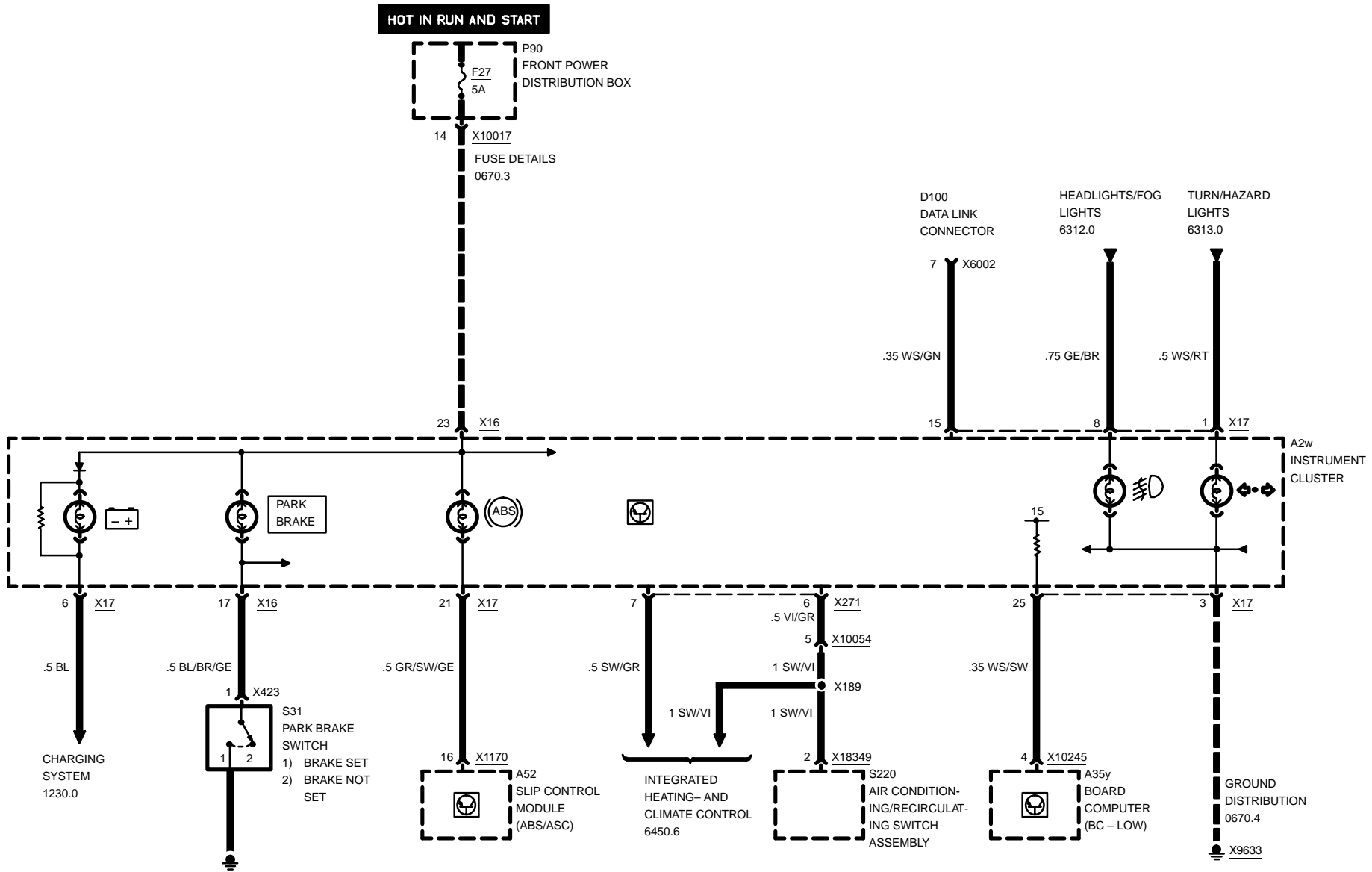



6213.3 DIGITAL CLOCK

Z3 VERSIONS

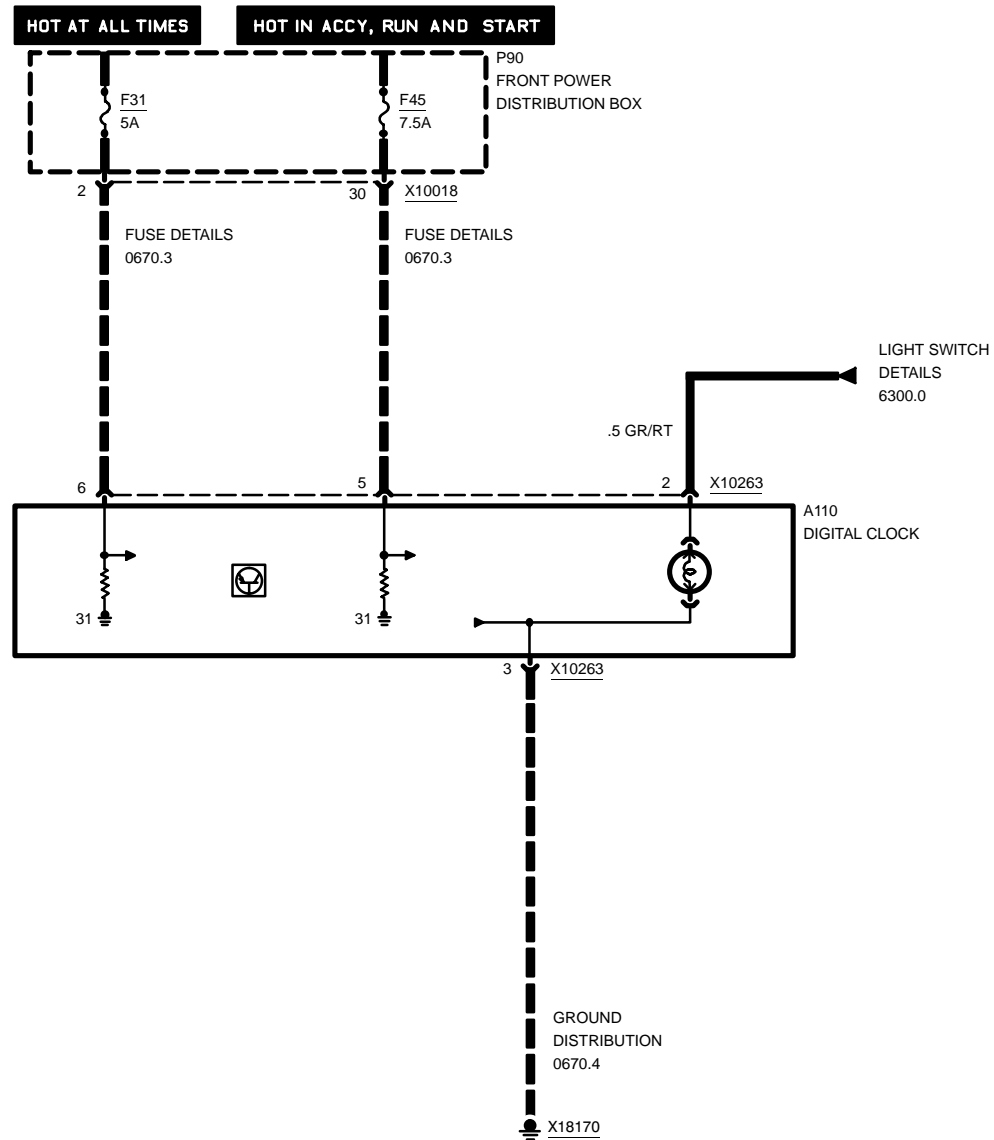

03/00

6213.3 00

1999



6300.0 LIGHT SWITCH DETAILS

Z3

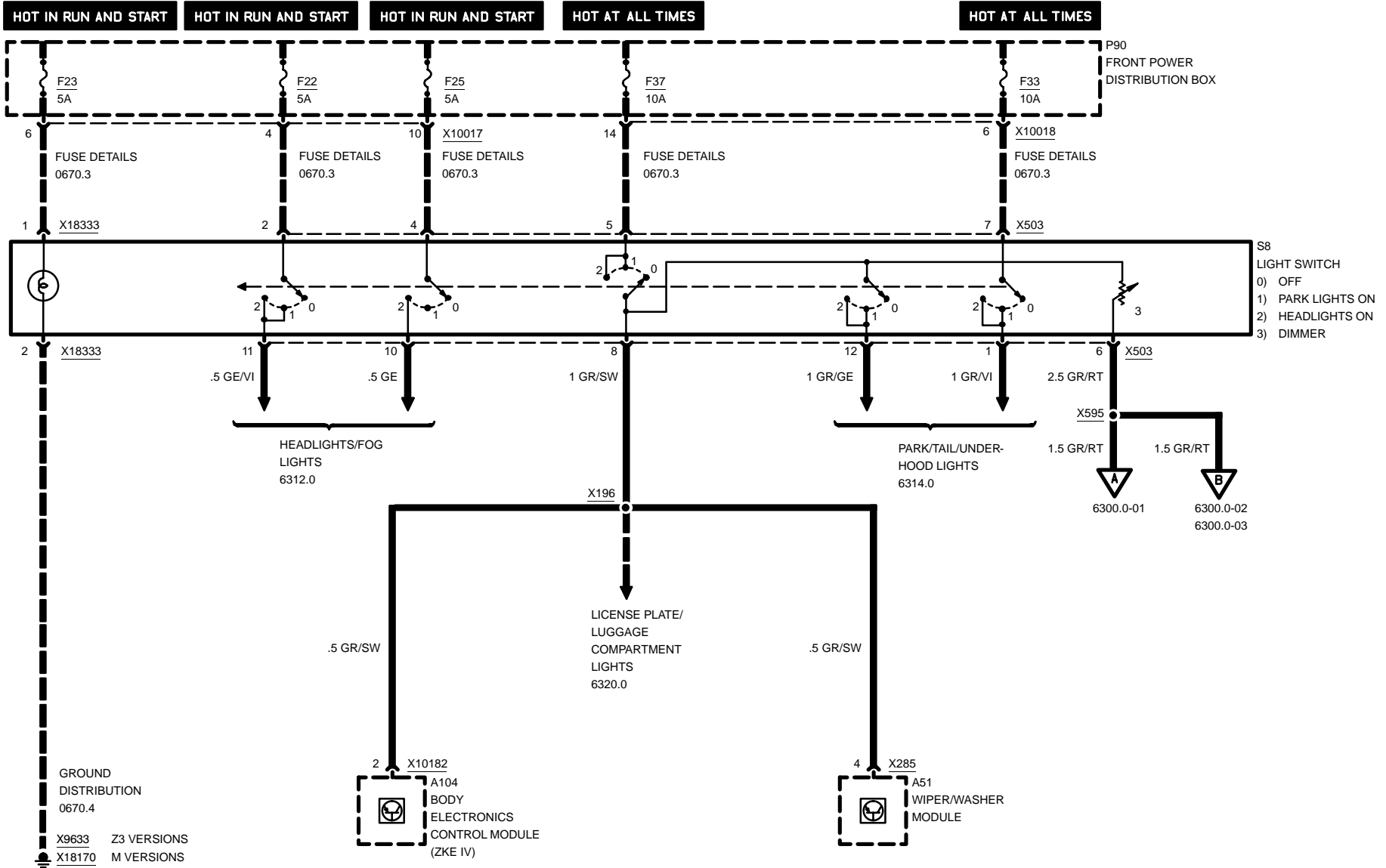

03/00

6300.0-00

1999



LIGHT SWITCH DETAILS

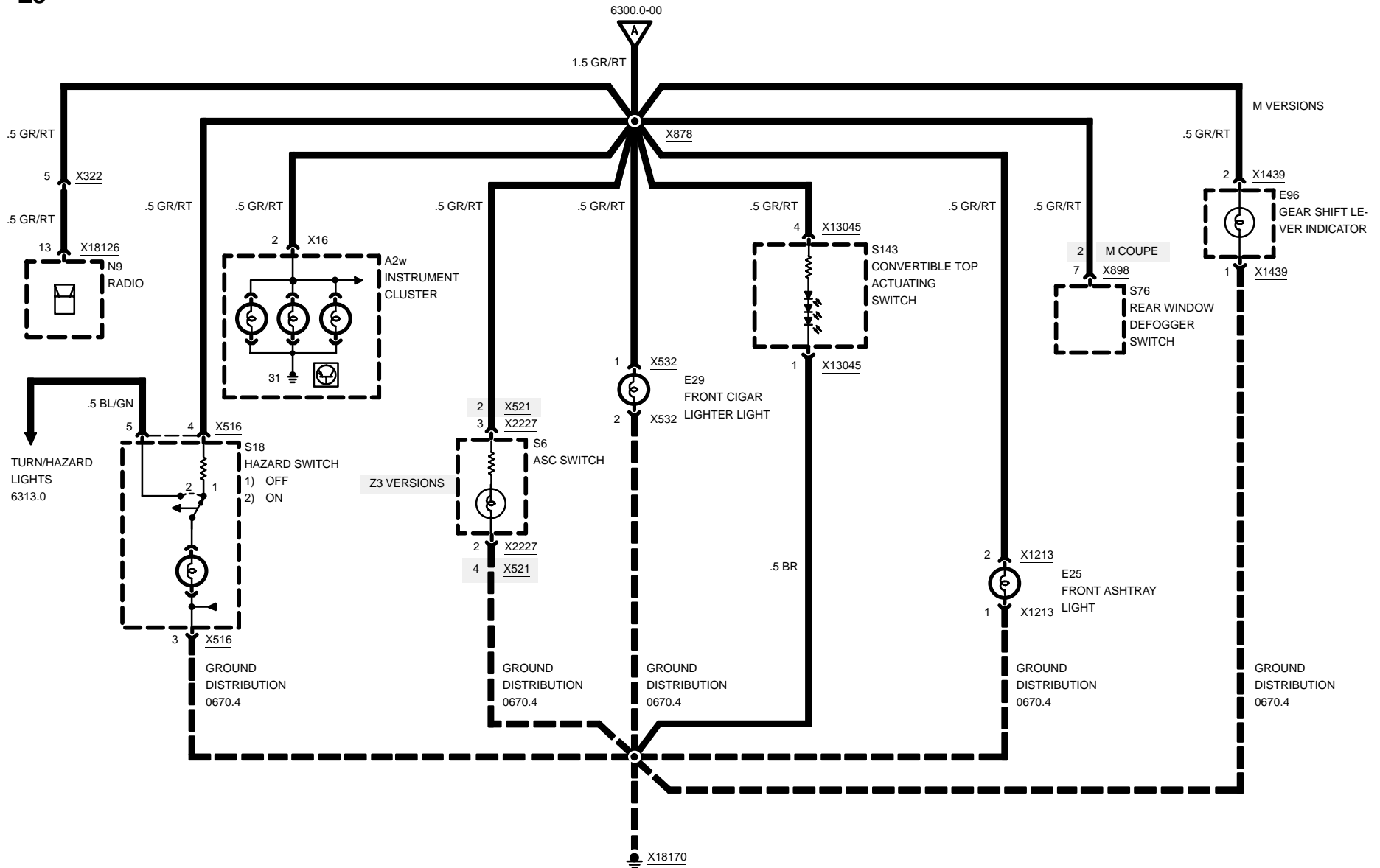



LIGHT SWITCH DETAILS

Z3 VERSIONS

Z3

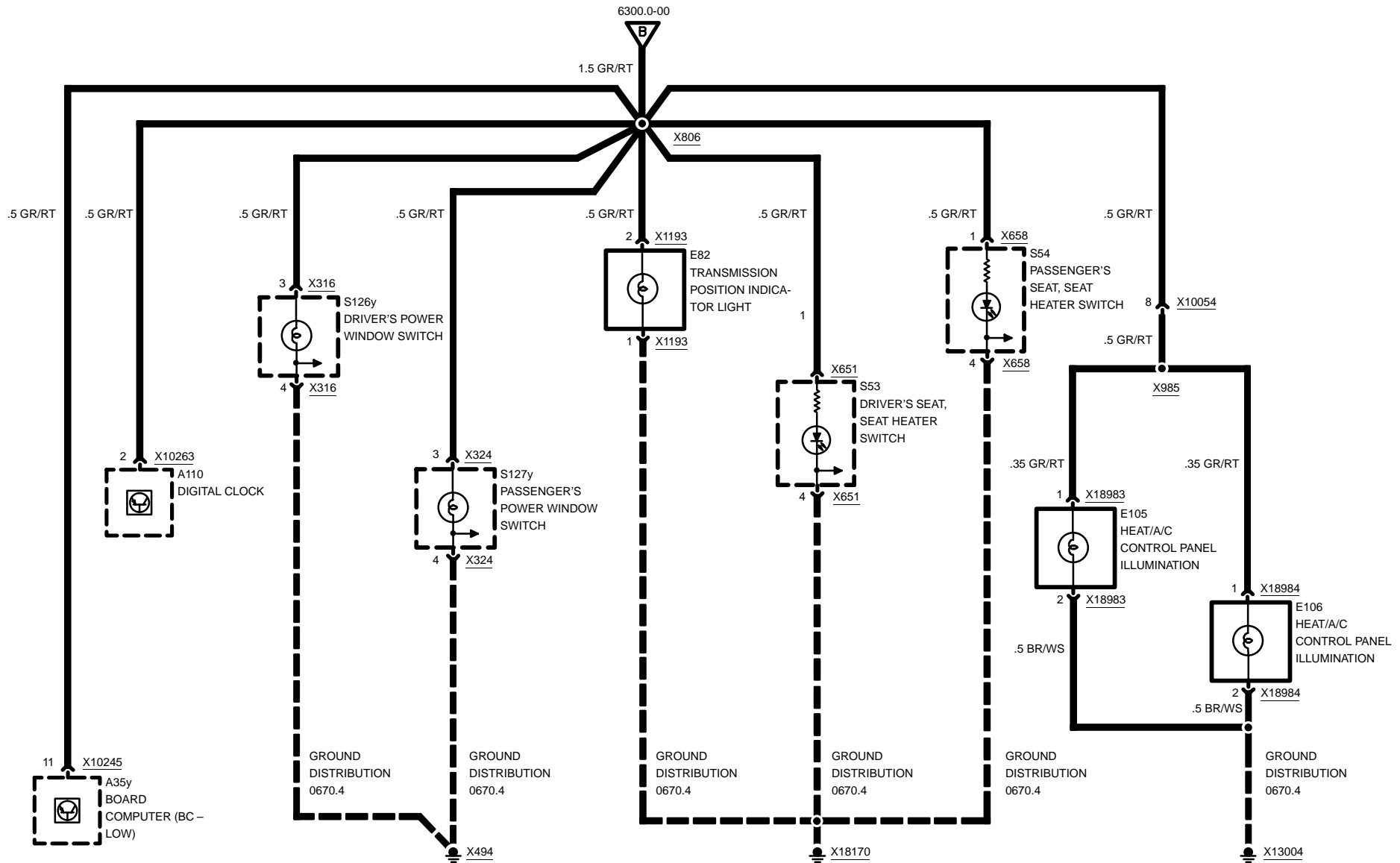

03/00

6300.0-02

1999



LIGHT SWITCH DETAILS

M VERSIONS

Z3

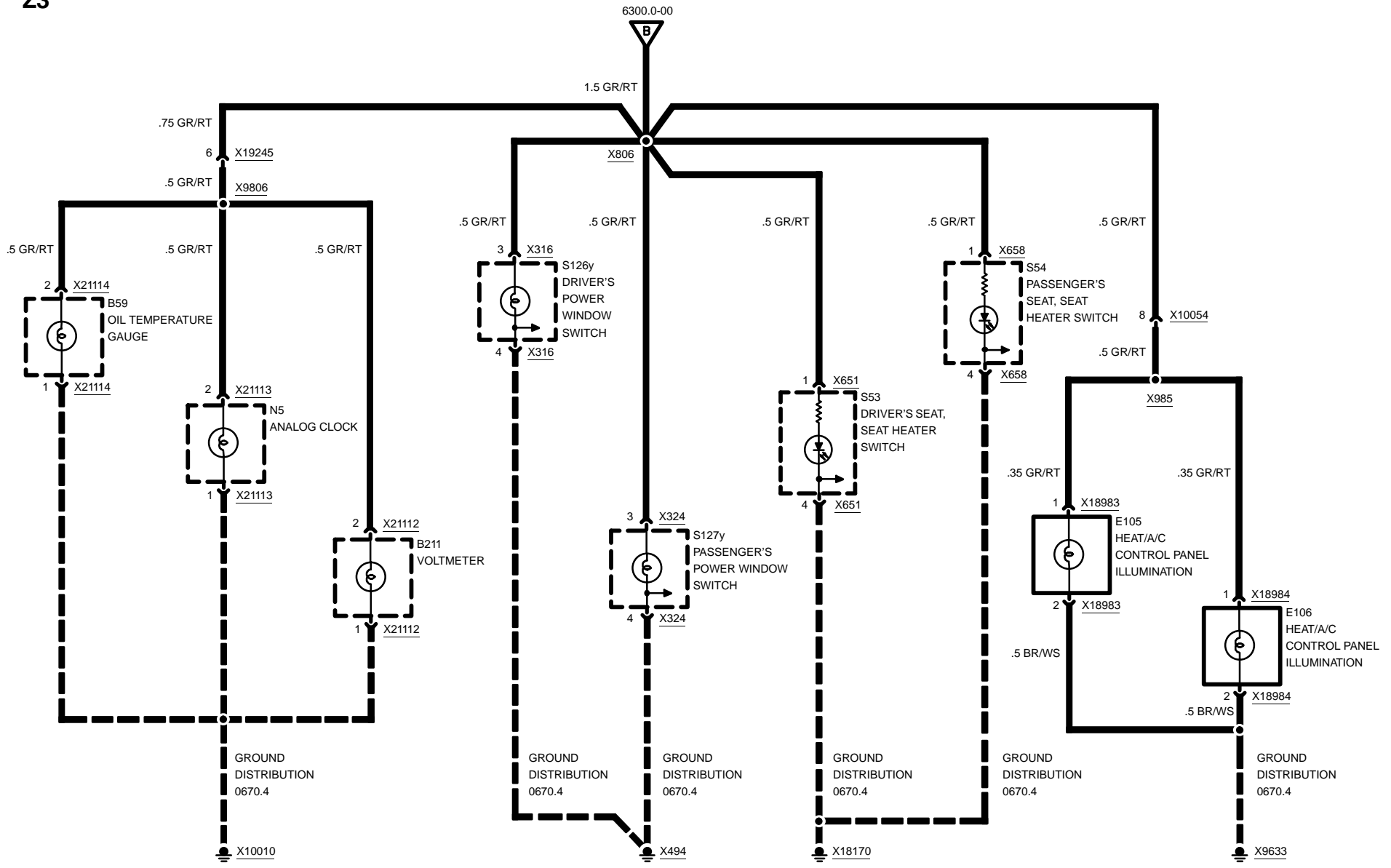

03/00

6300.0-03

1999

6312.0 HEADLIGHTS/FOG LIGHTS

Z3

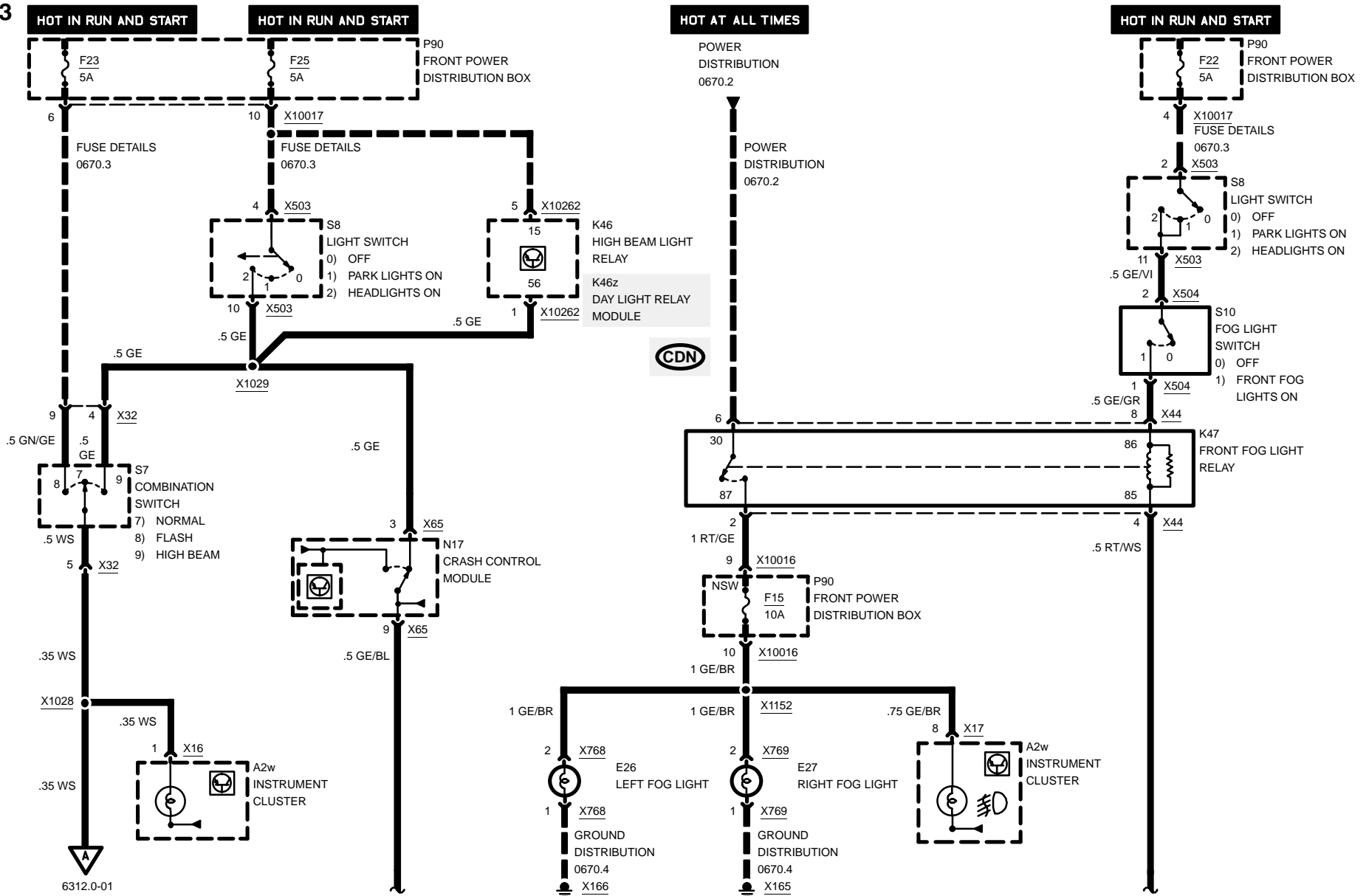

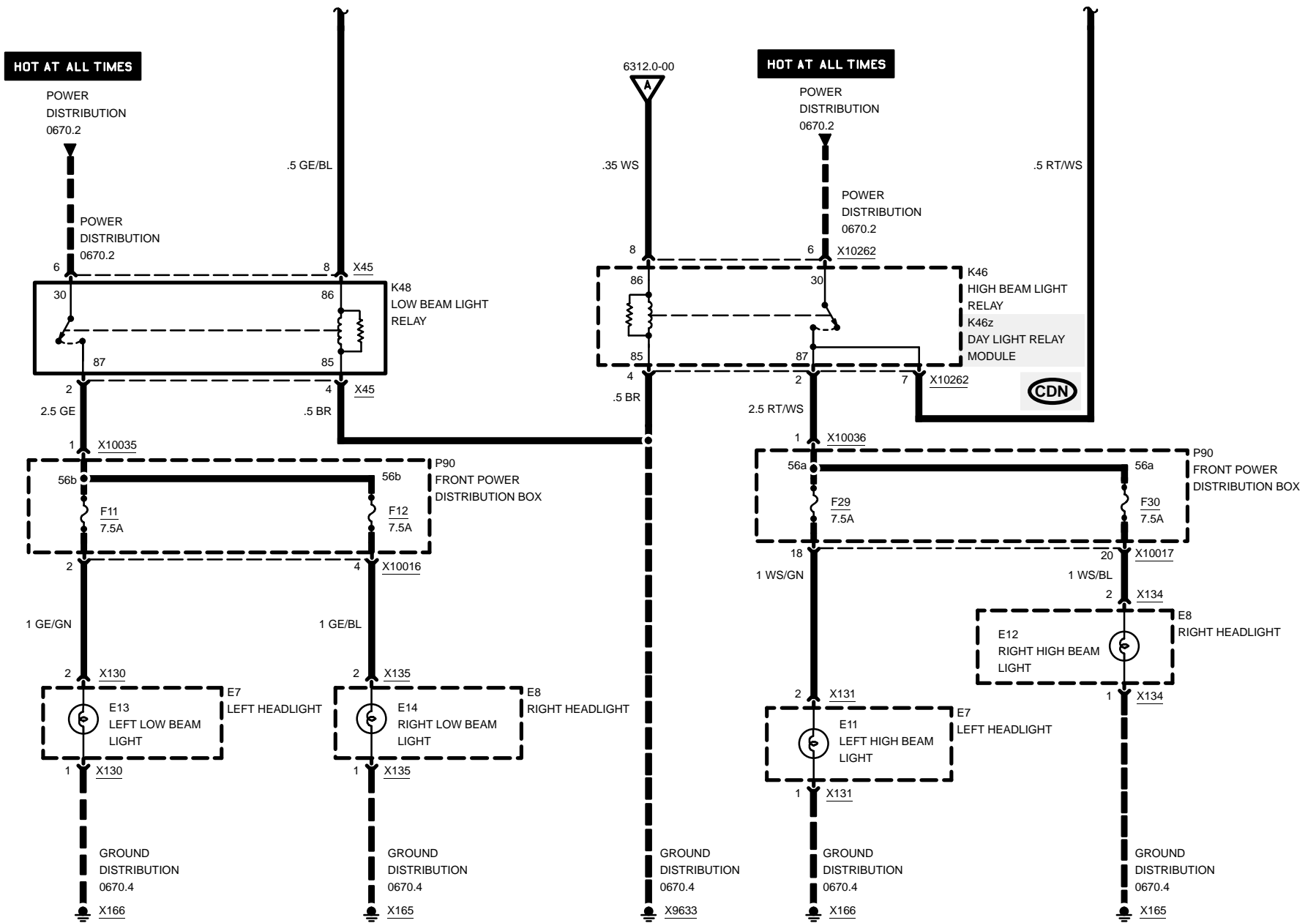

6313.0 TURN/HAZARD LIGHTS

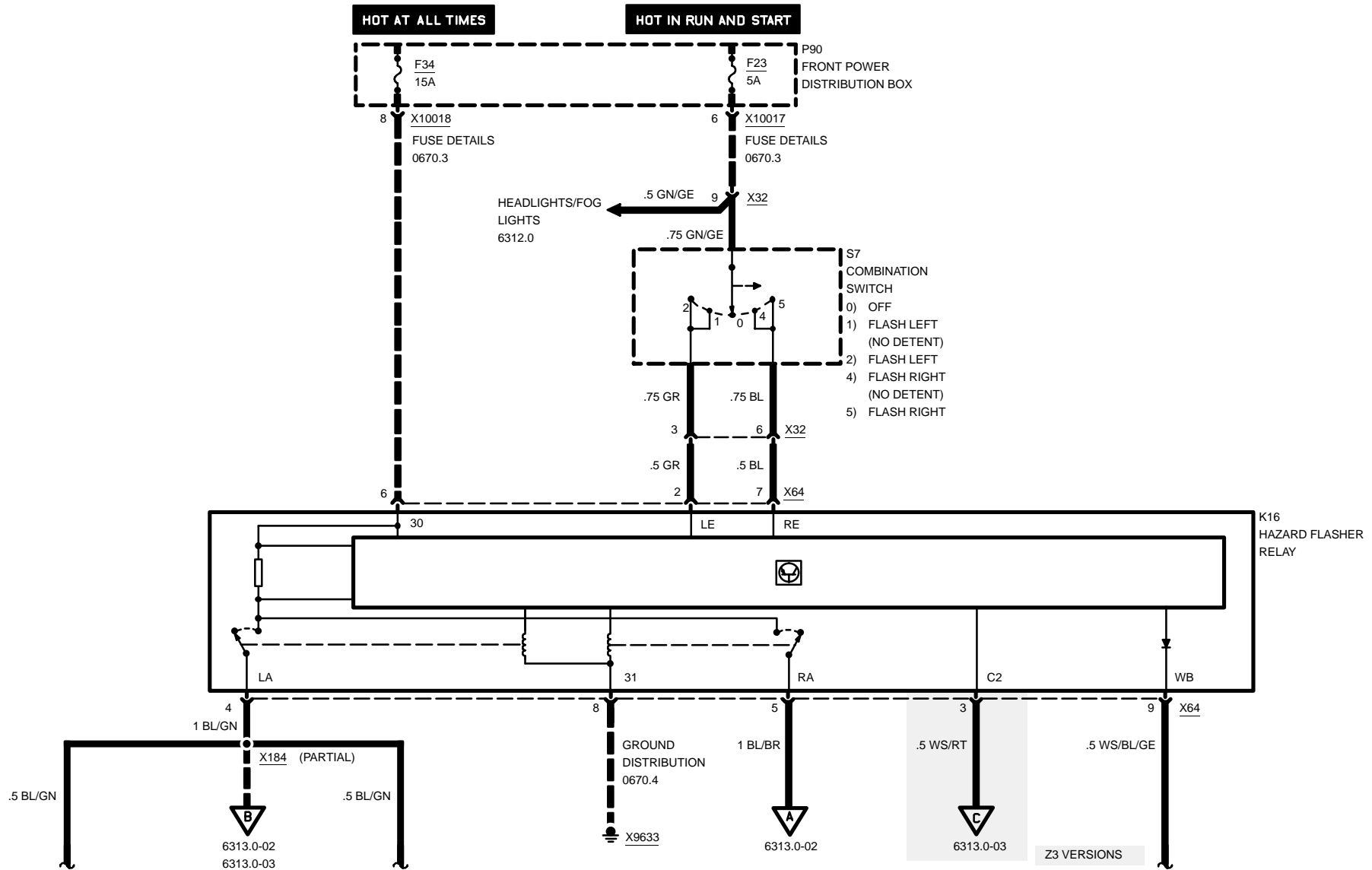

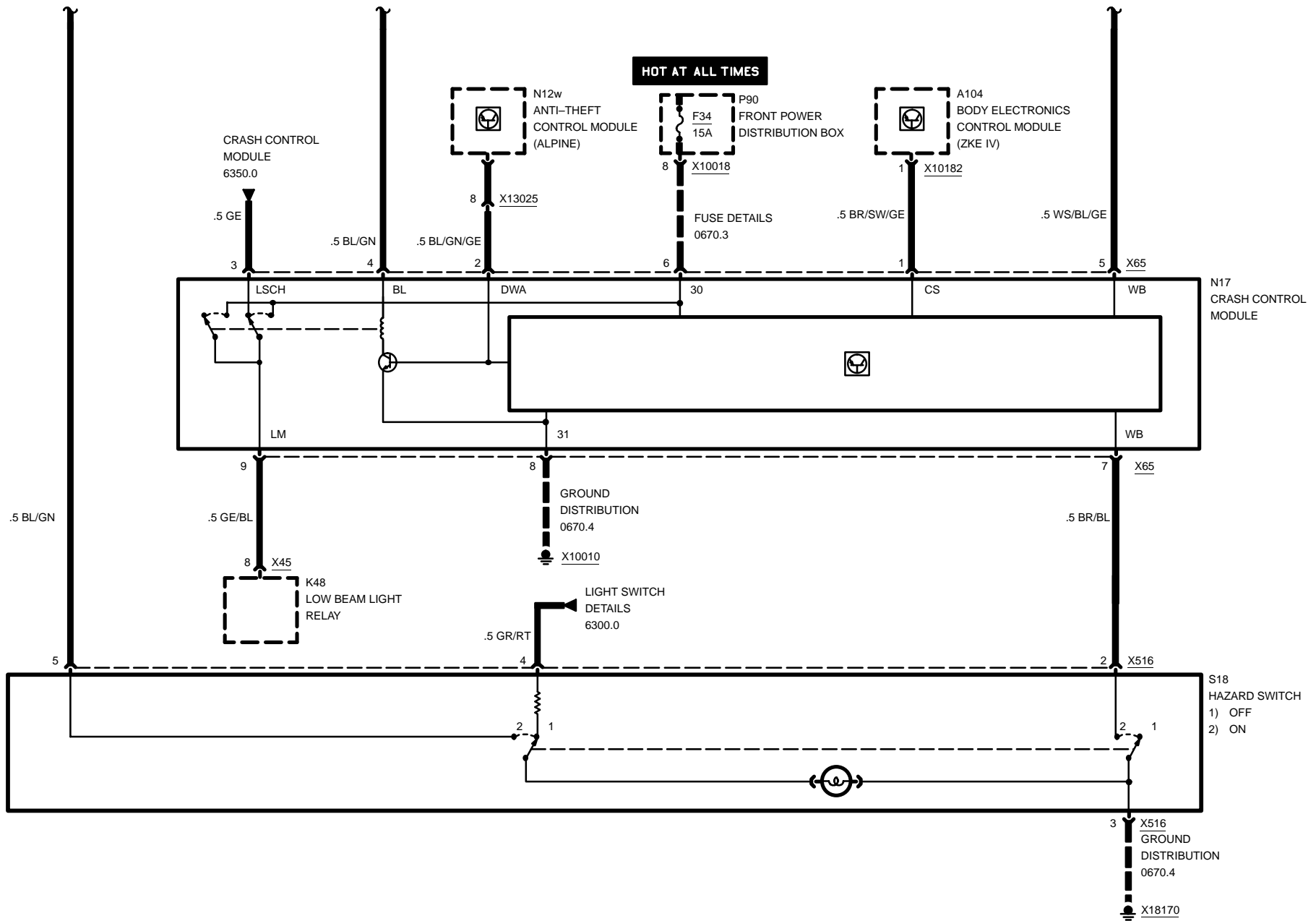



TURN/HAZARD LIGHTS

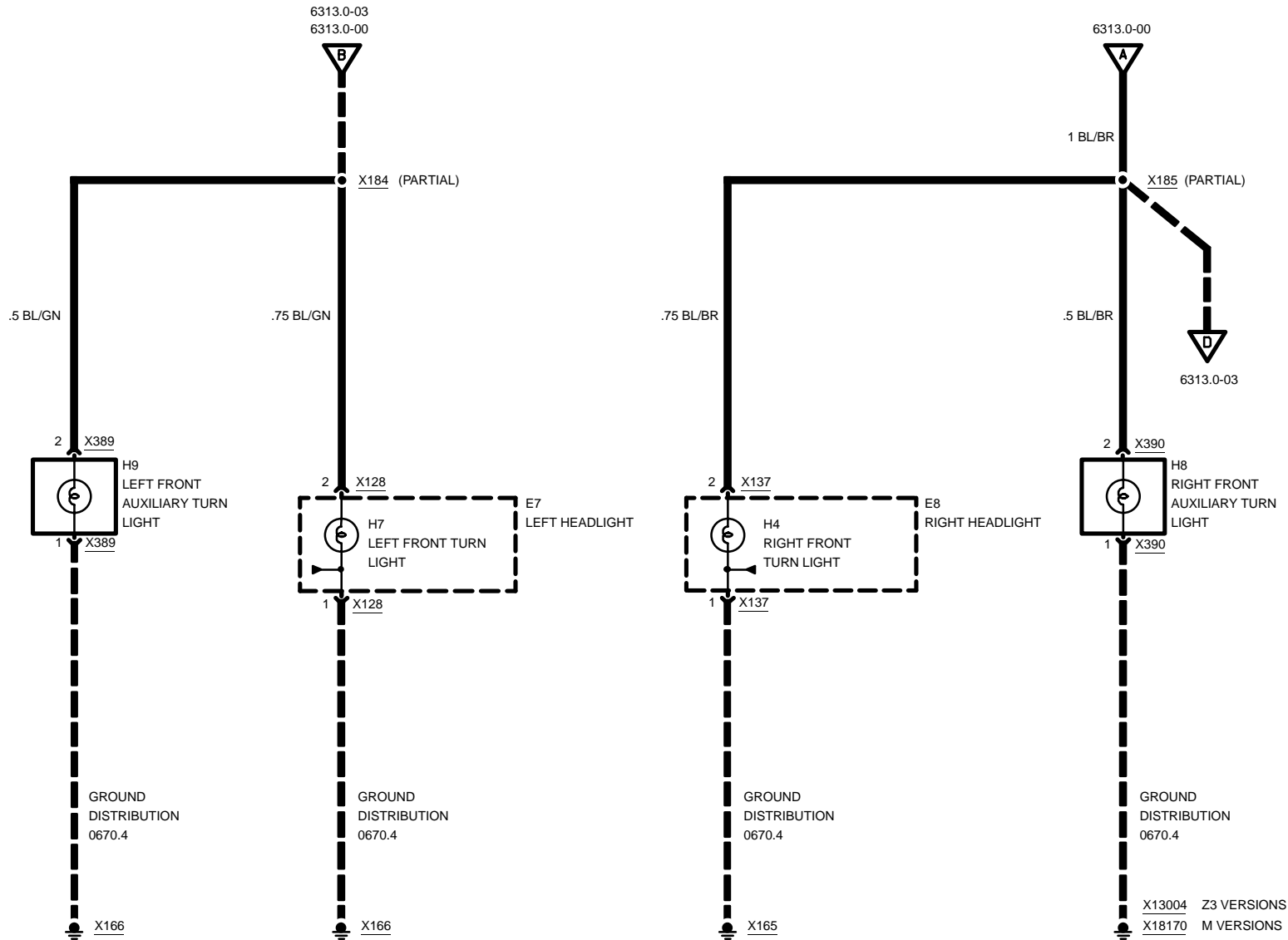



TURN/HAZARD LIGHTS

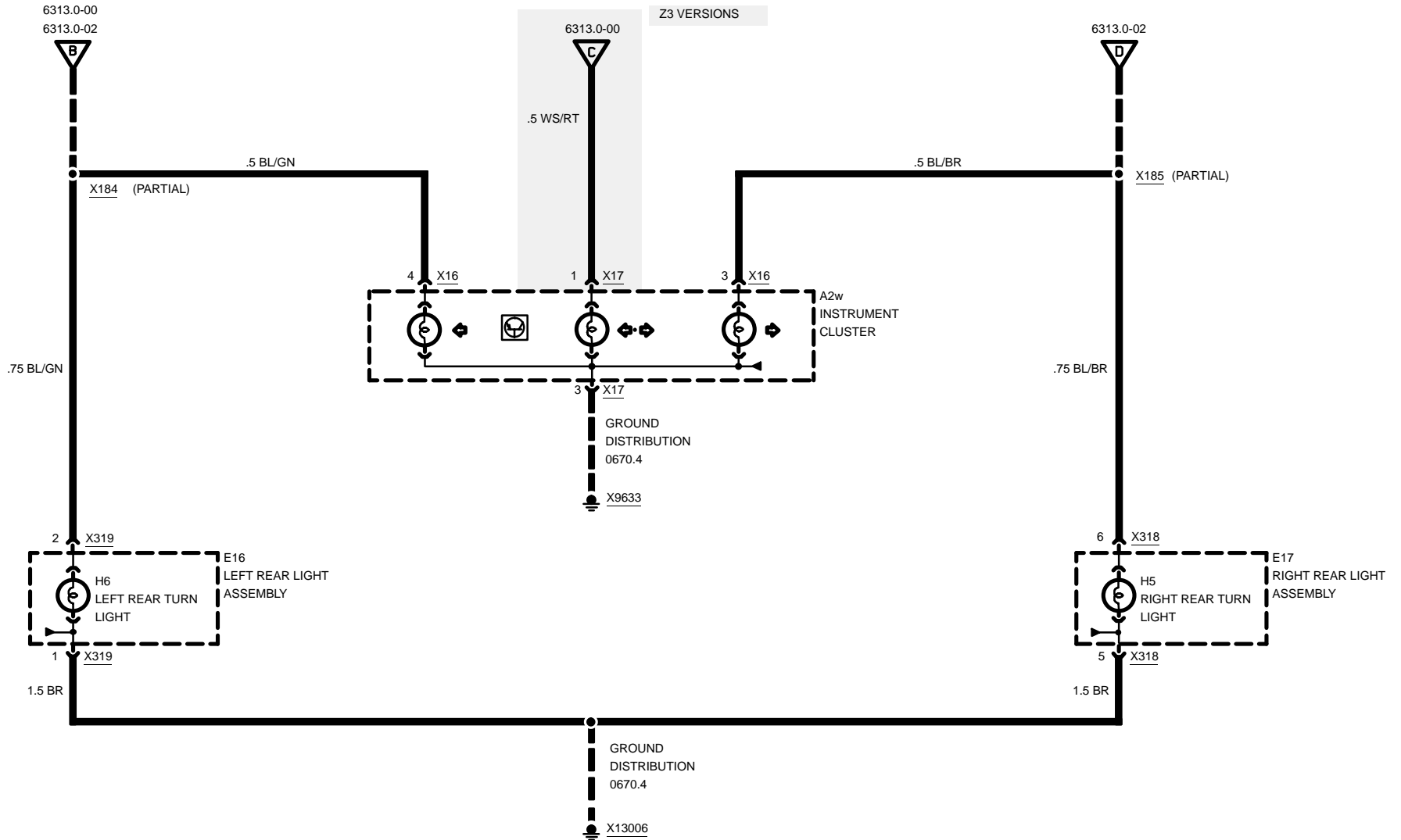

03/00

6313.0-03

1999



6314.0 PARK/TAIL/UNDERHOOD LIGHTS

Z3

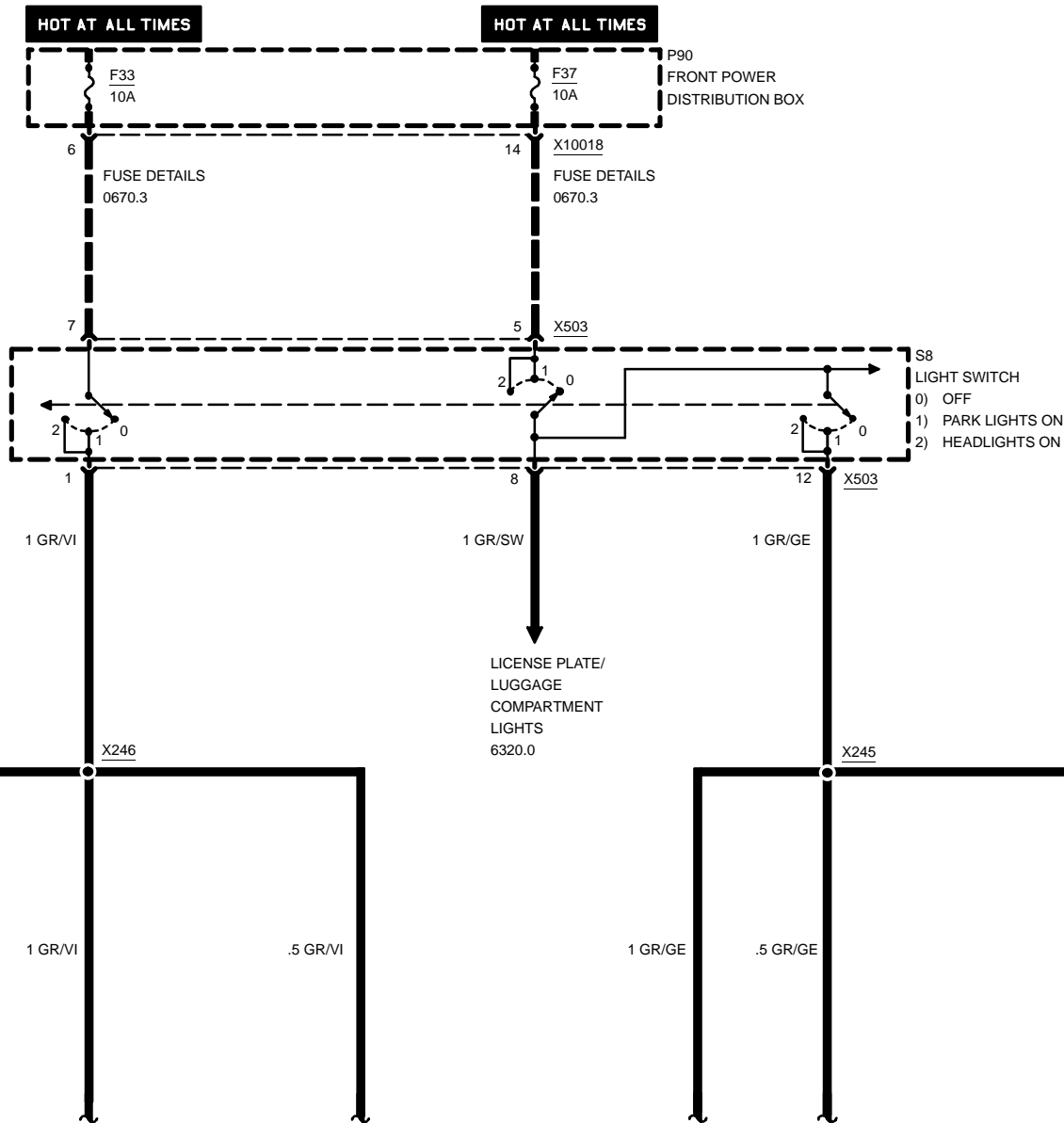

03/00

6314.0-00

1999

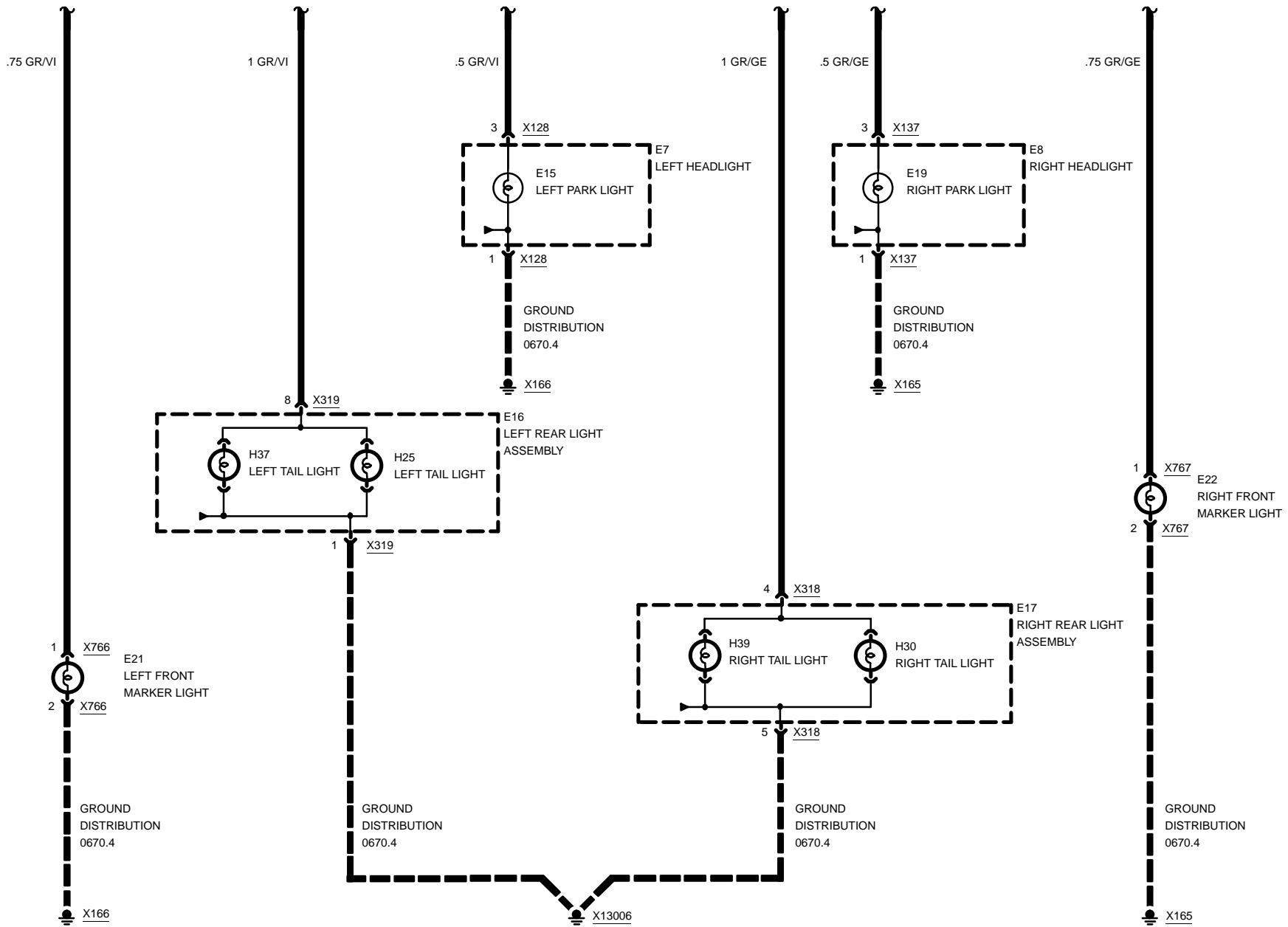

6320.0 LICENSE PLATE/LUGGAGE COMPARTMENT LIGHTS

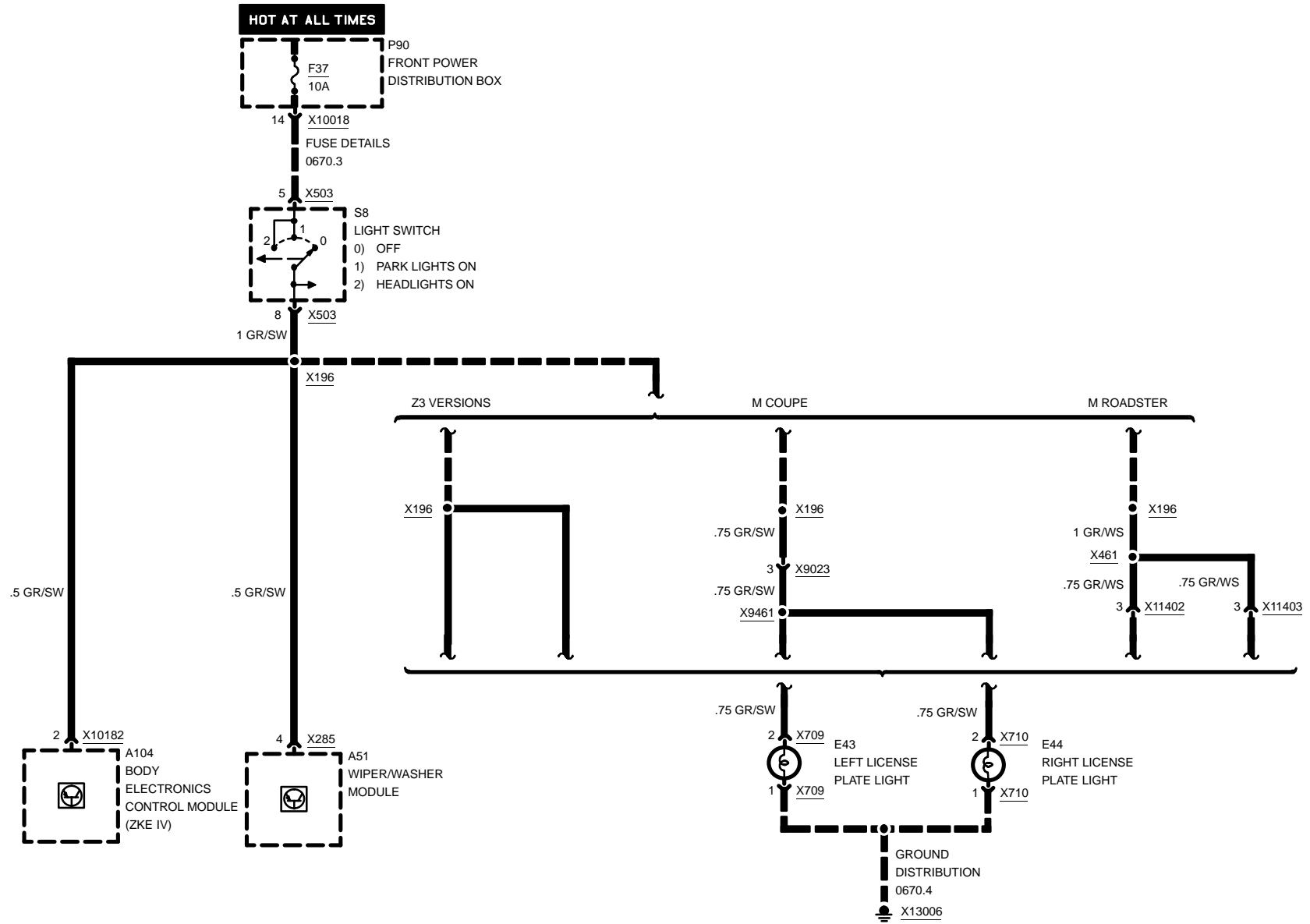

LICENSE PLATE/LUGGAGE COMPARTMENT LIGHTS

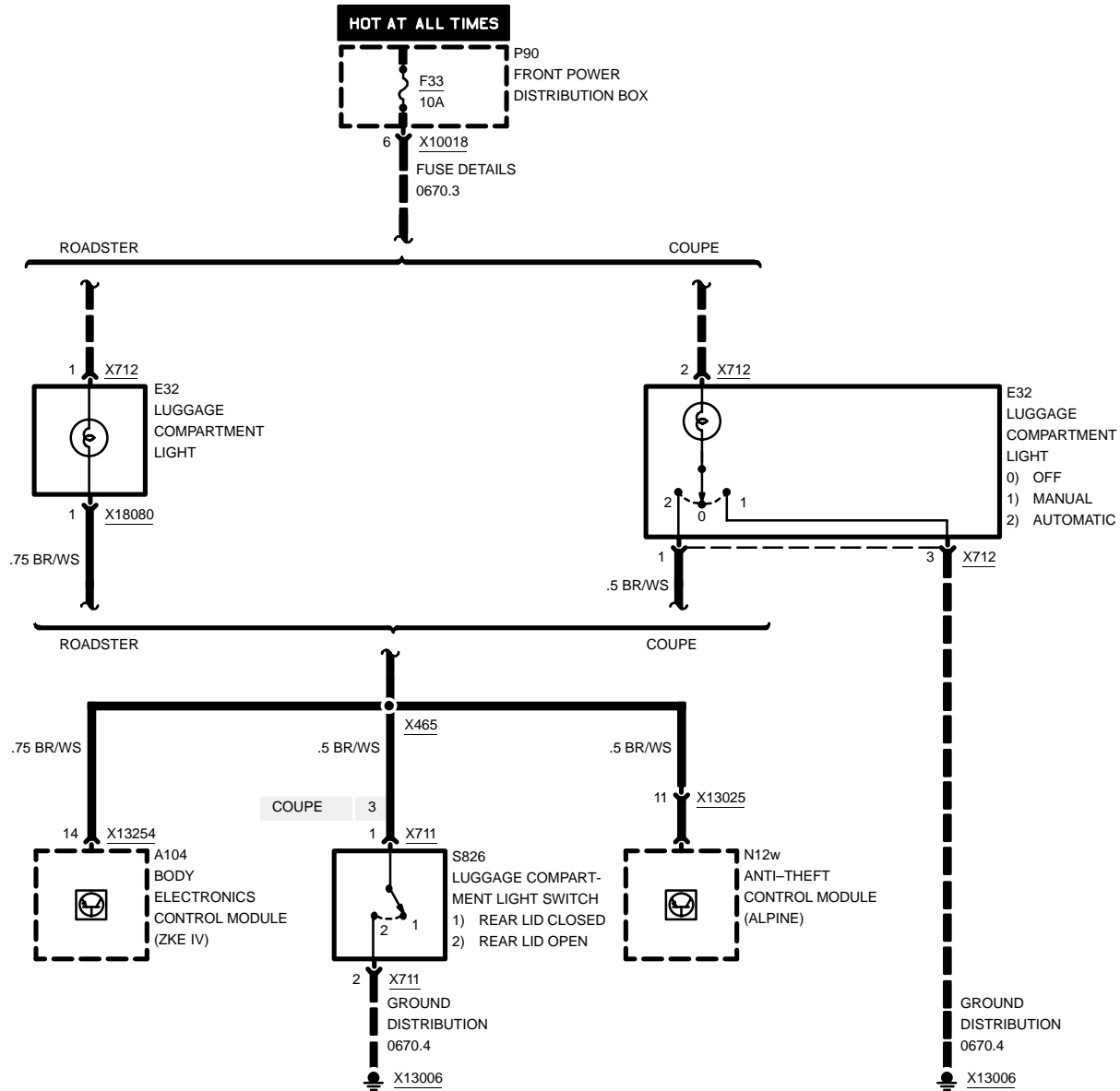



6322.0 BACK UP LIGHTS

Z3

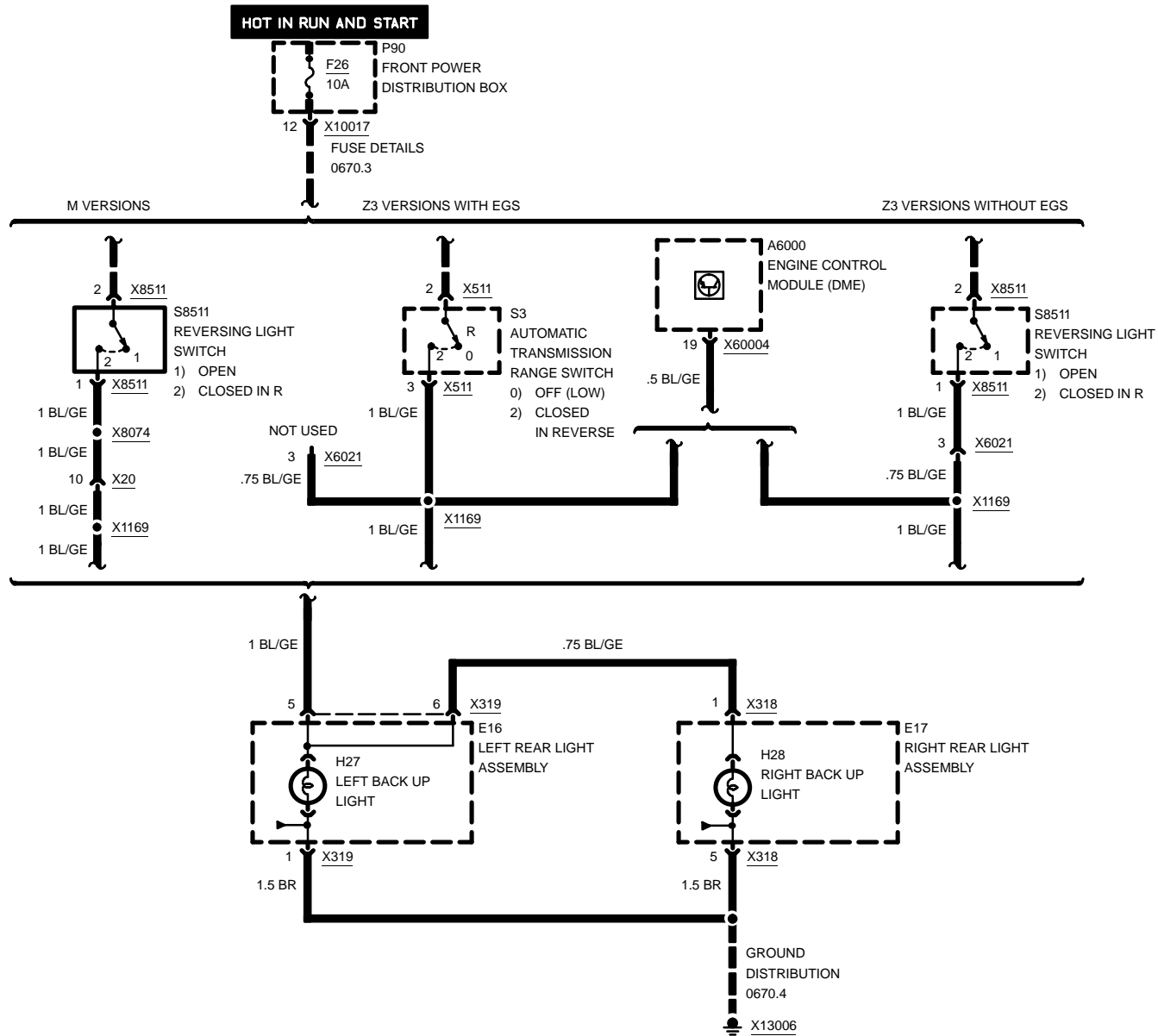

03/00

6322.0-00

1999



6325.0 BRAKE LIGHTS

Z3 VERSIONS

Z3

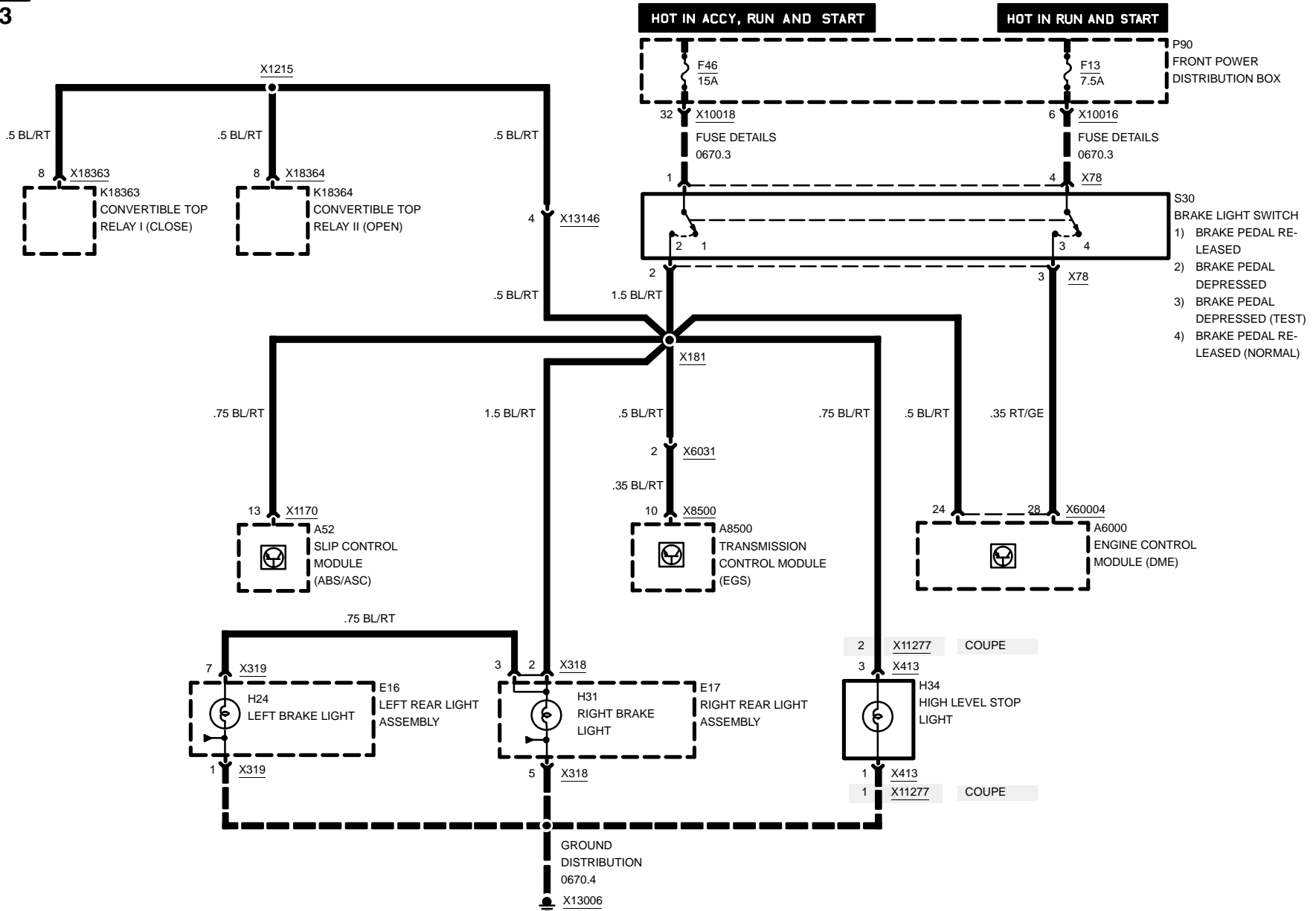

03/00

6325.0-00

1999

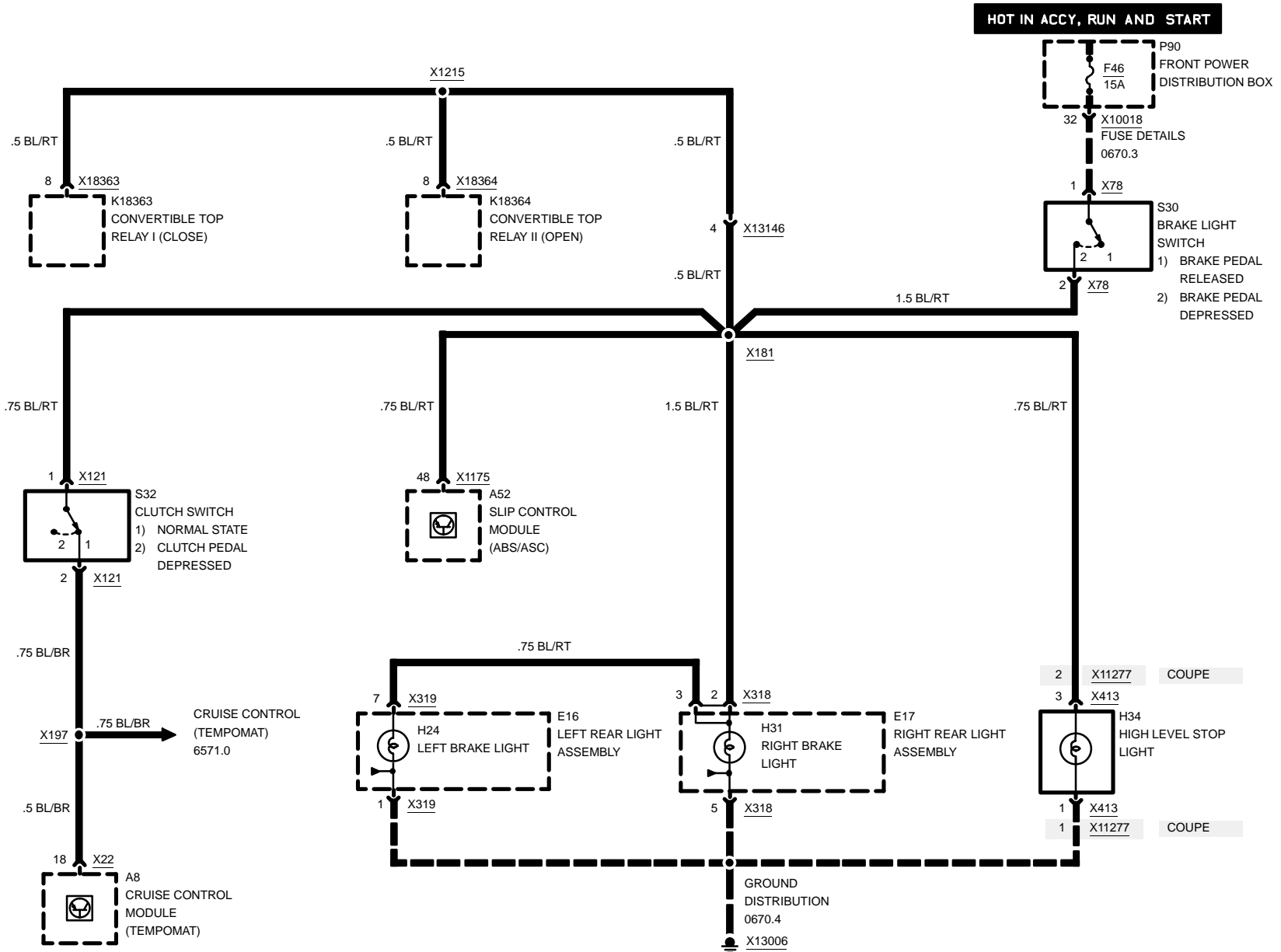

6330.0 INTERIOR LIGHTS

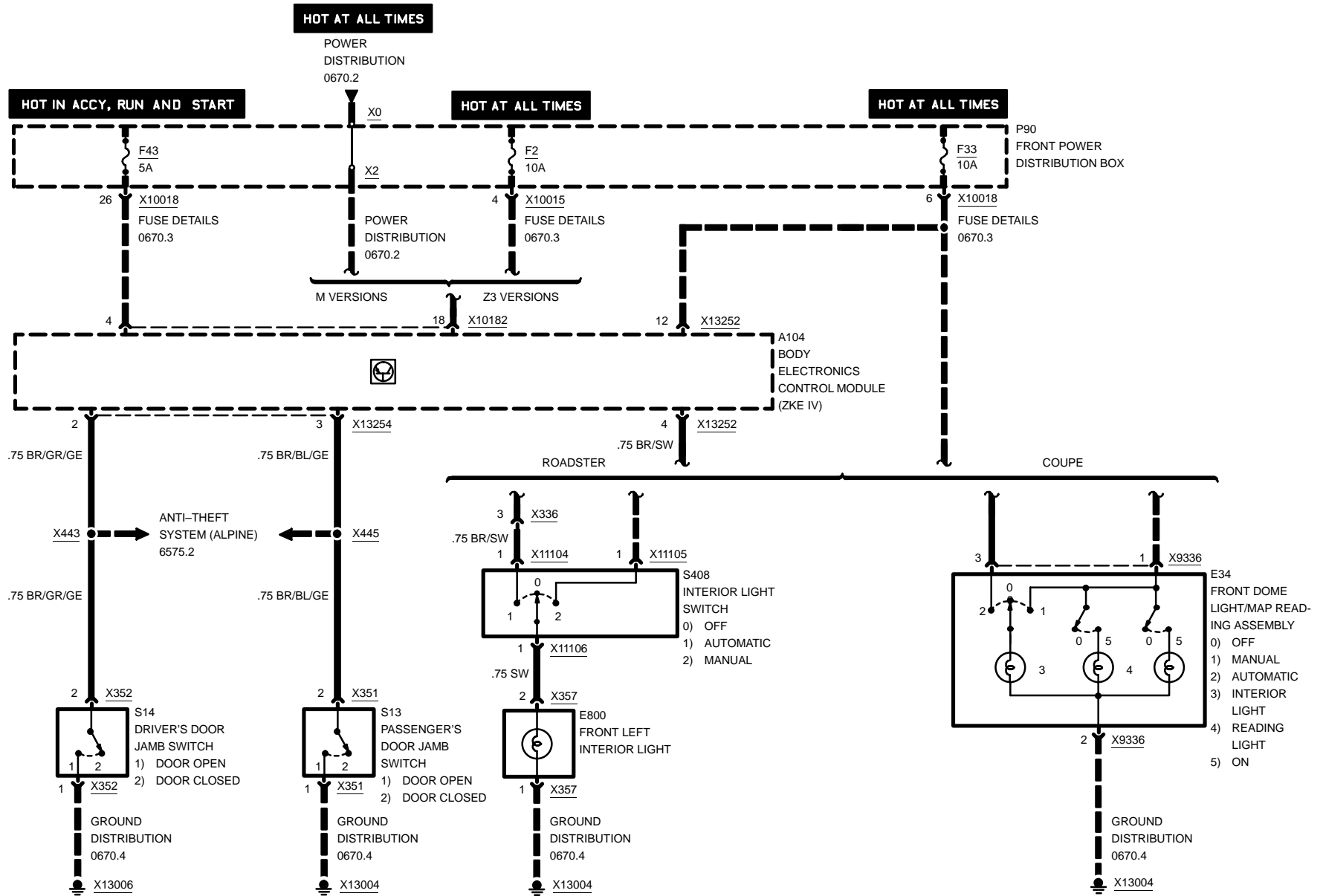

6332.0 INTERIOR ACCESSORIES

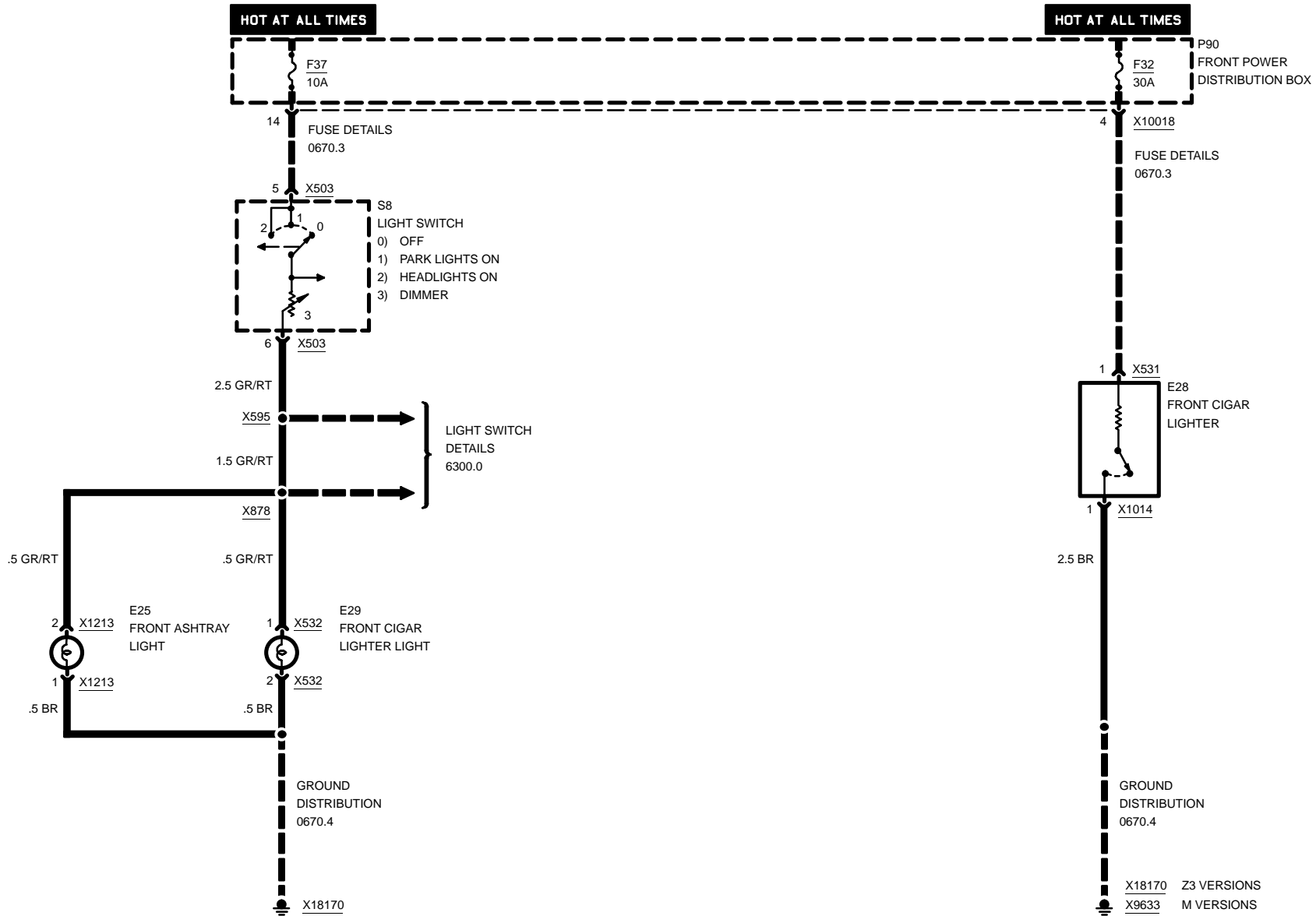



Z3

6350.0 CRASH CONTROL MODULE

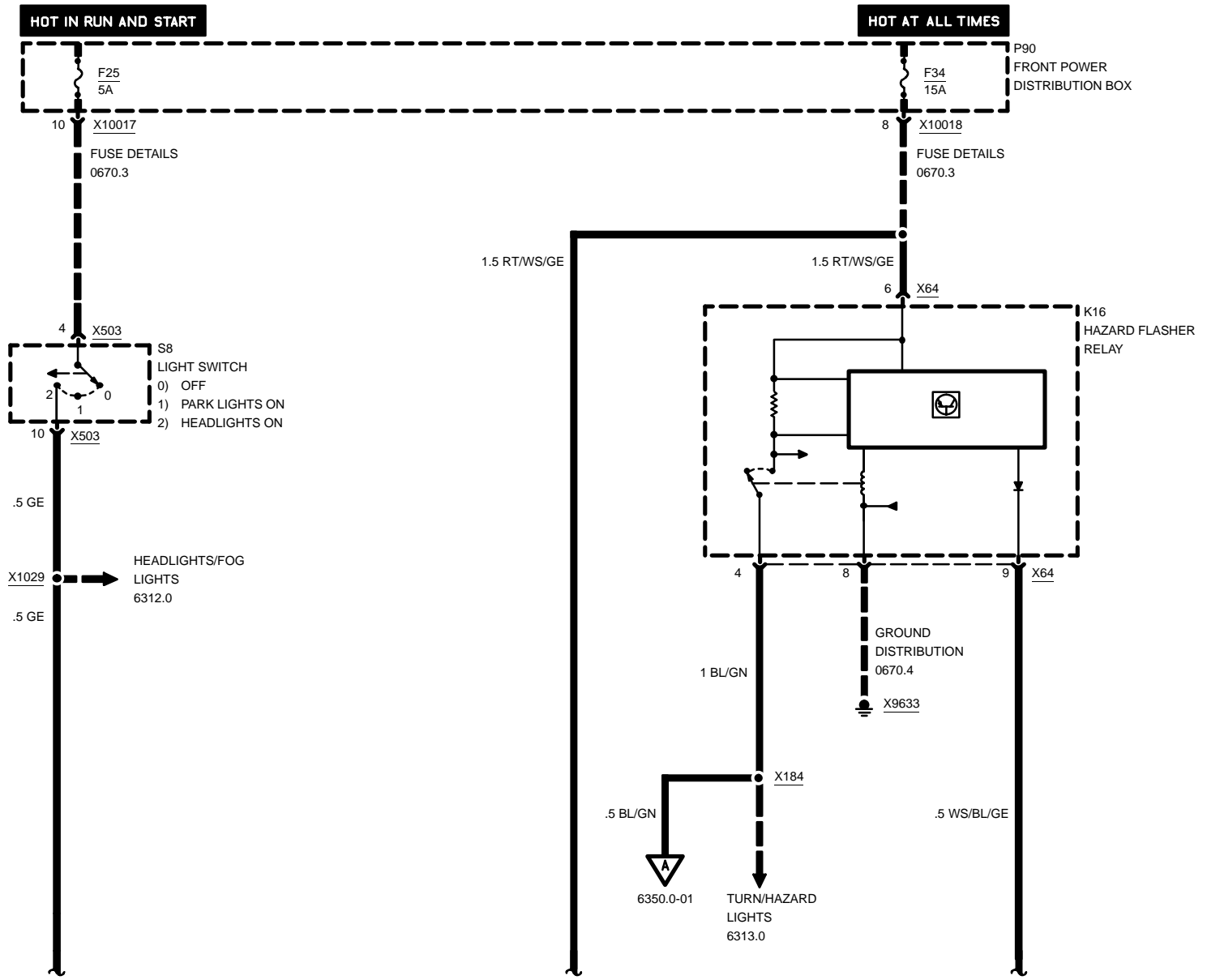

03/00

6350.0-00

1999

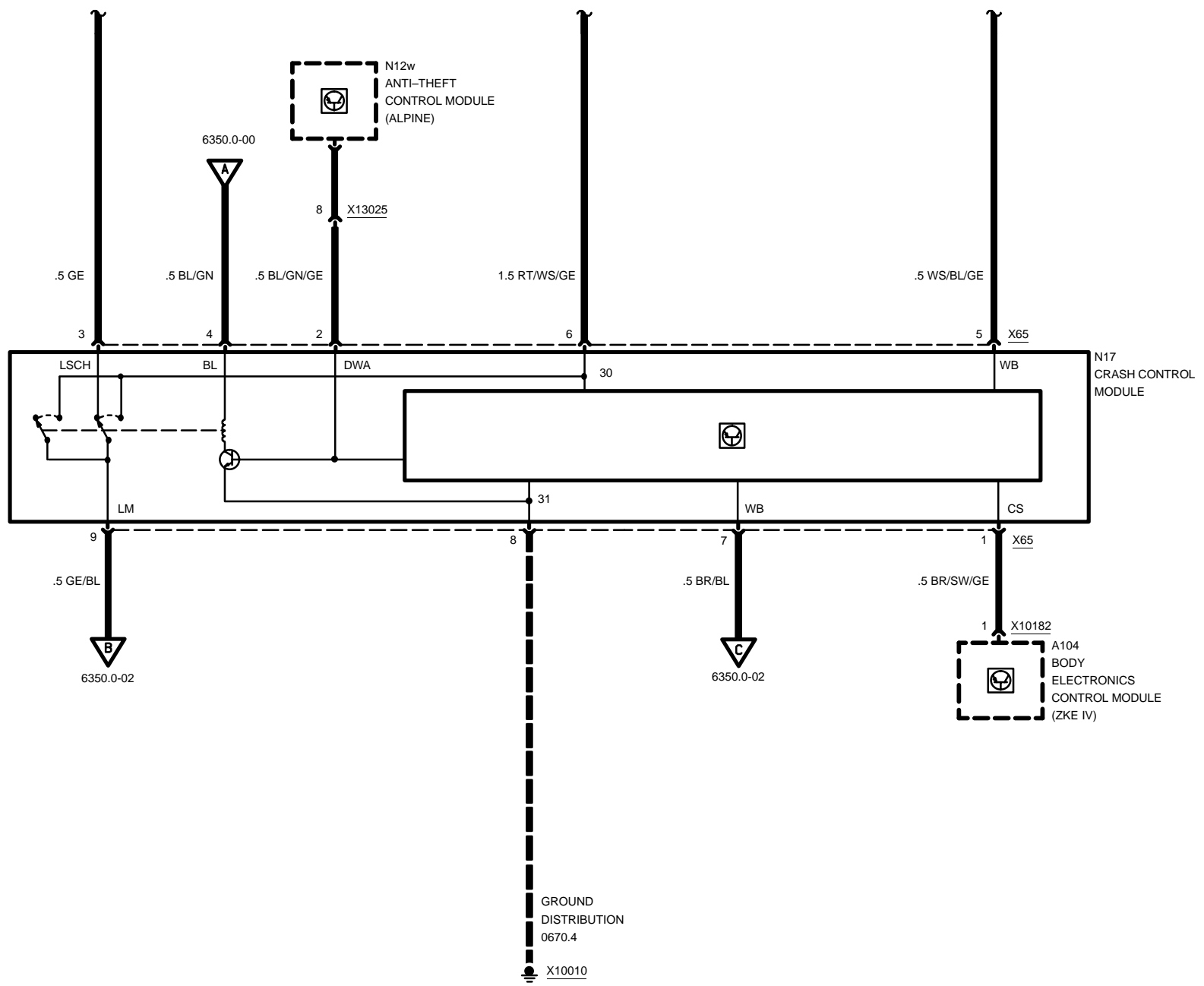



Z3

CRASH CONTROL MODULE

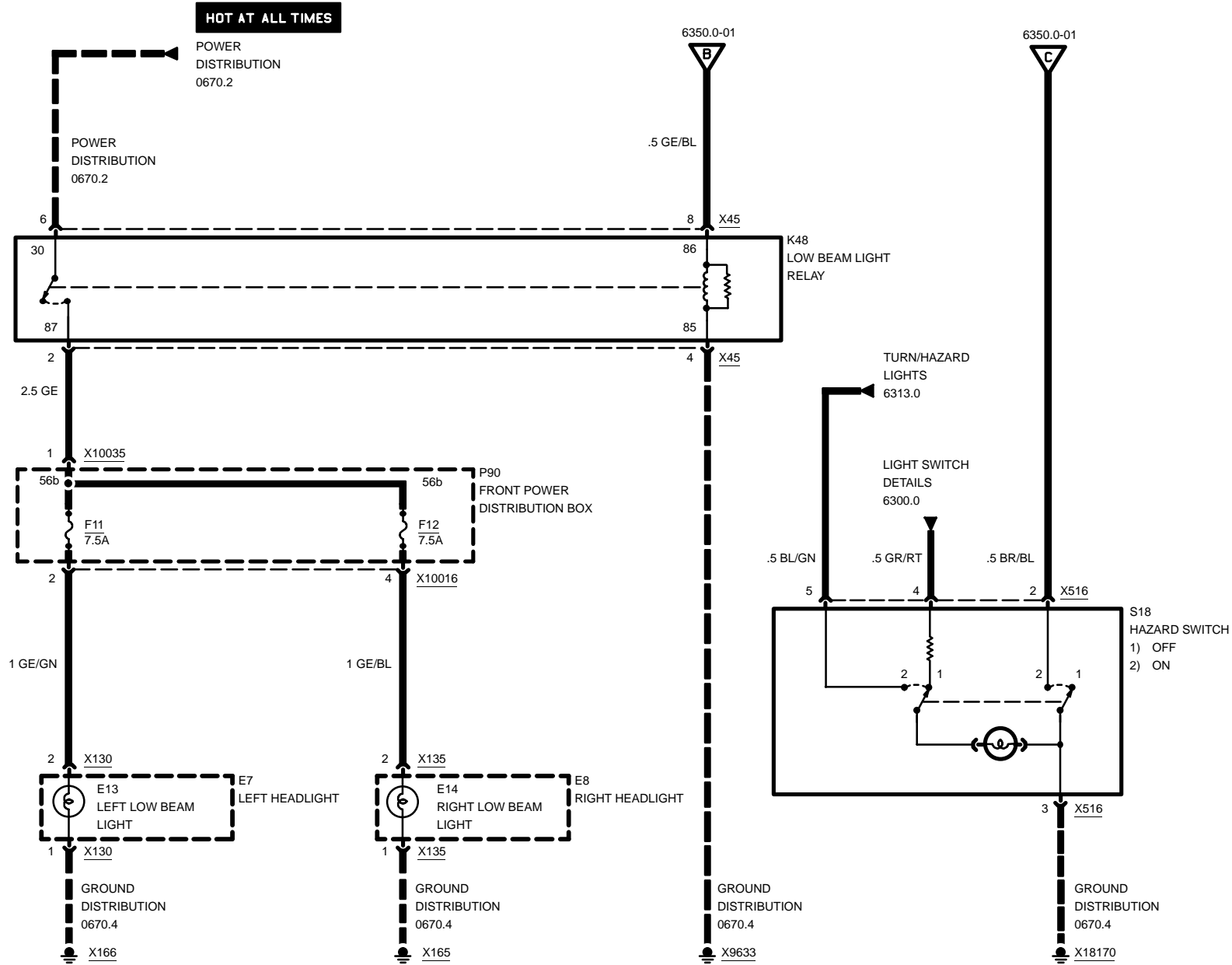

03/00

6350.0-02

1999



Z3

6424.0 REAR WINDOW DEFOGGER

M COUPE

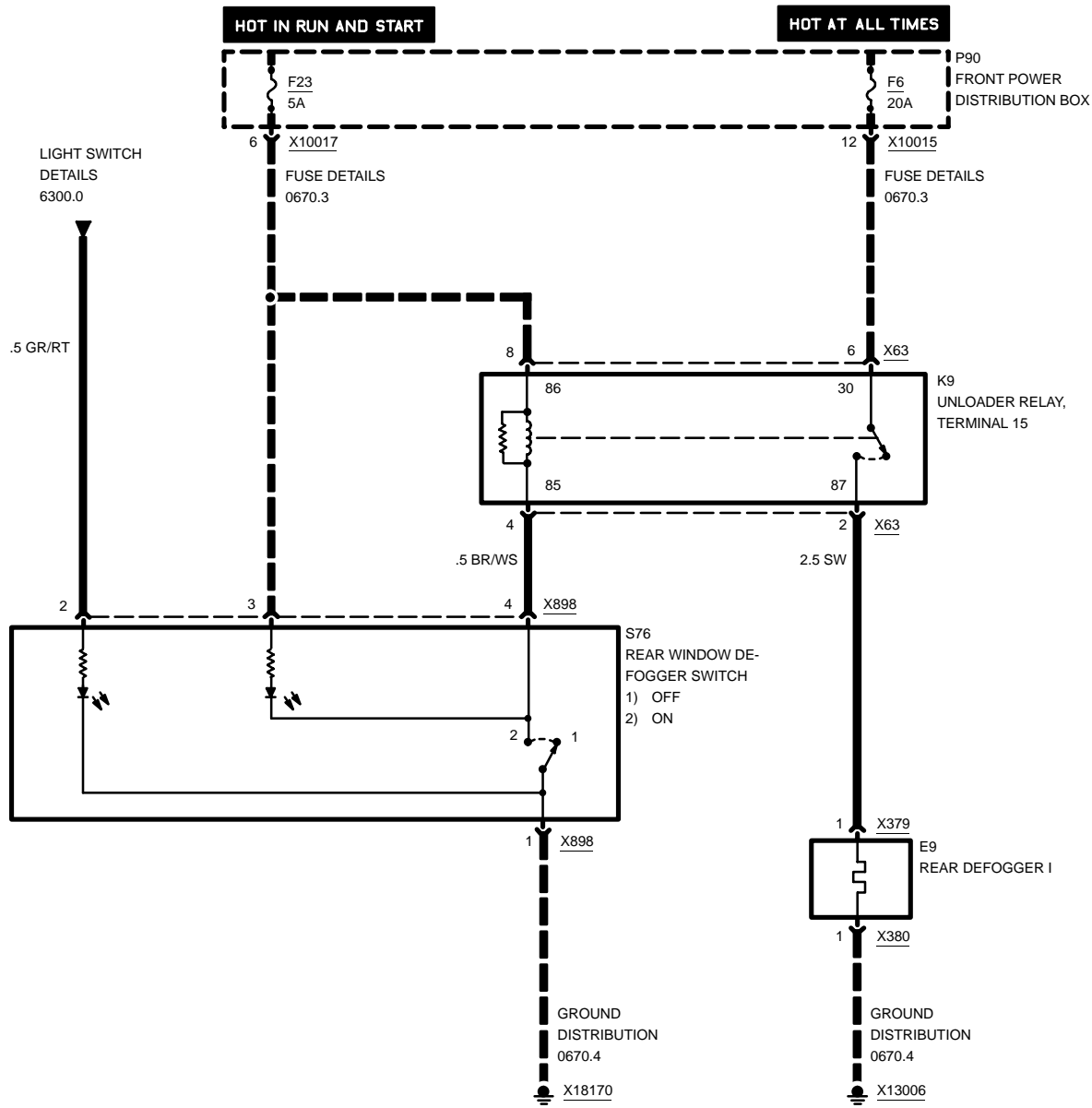

03/00

6424.0-00

1999



Z3

REAR WINDOW DEFOGGER

ROADSTER AND Z3 COUPE

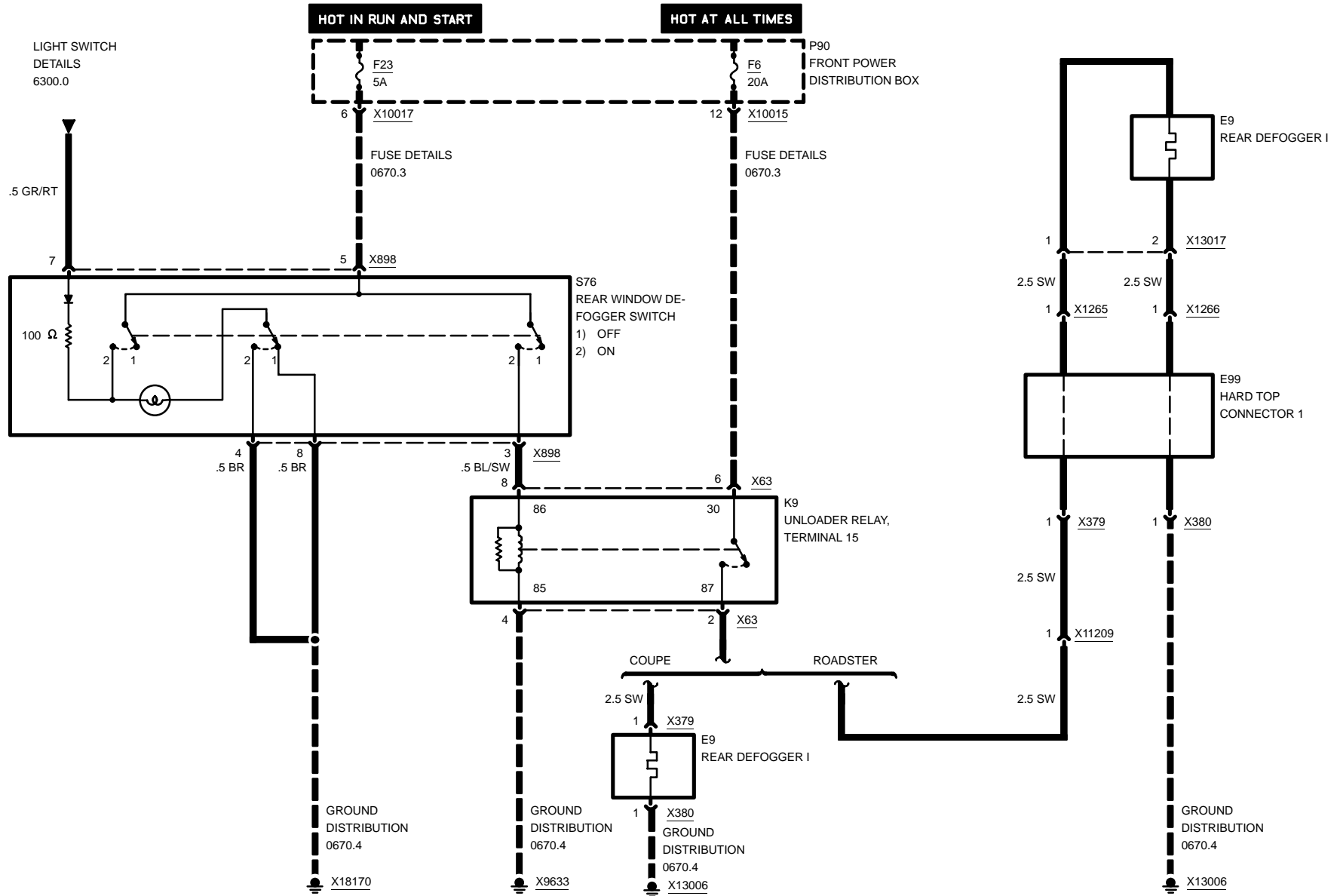

03/00

6424.0-01

1999

Z3 VERSIONS

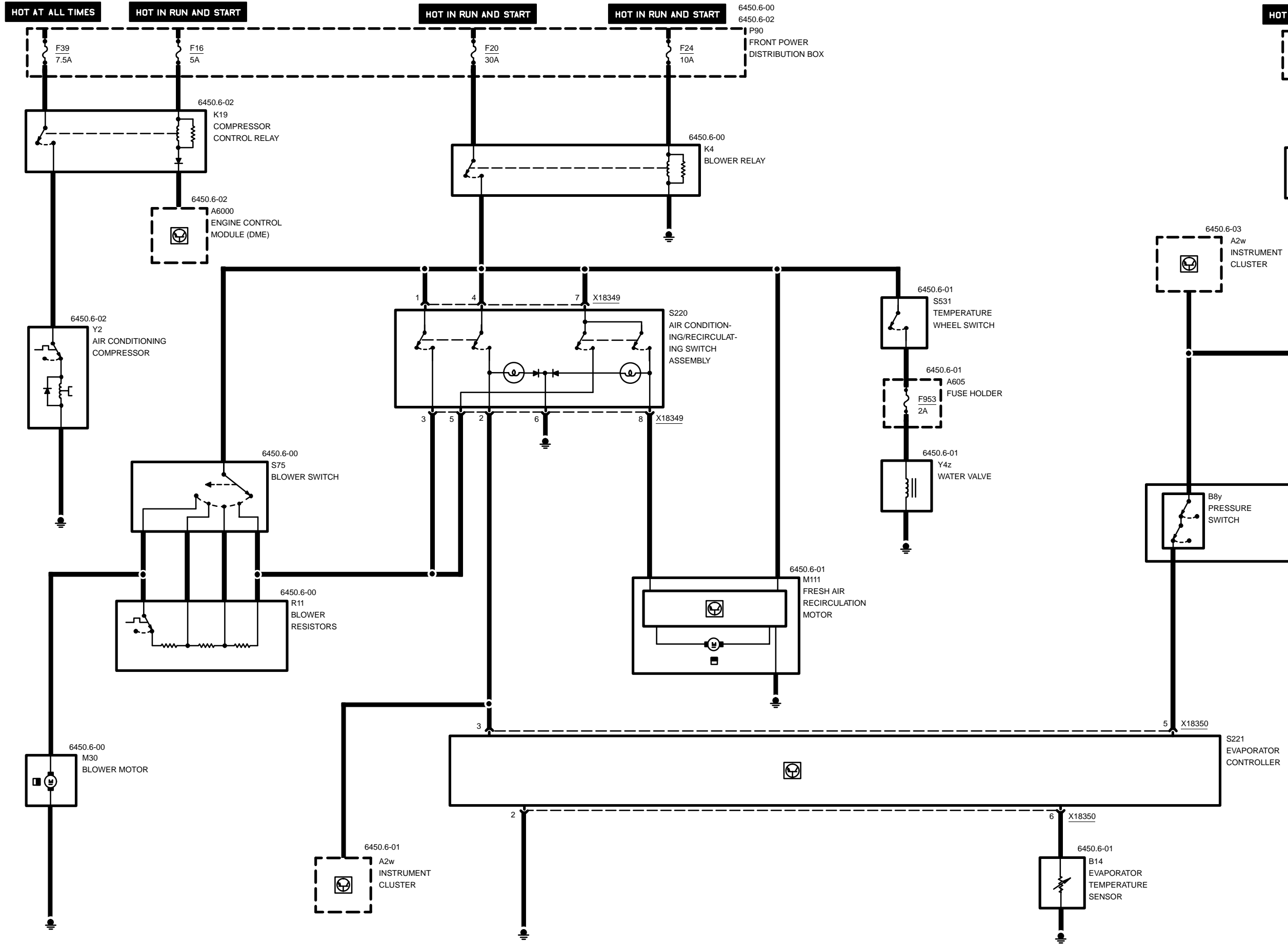

AUXILIARY FAN

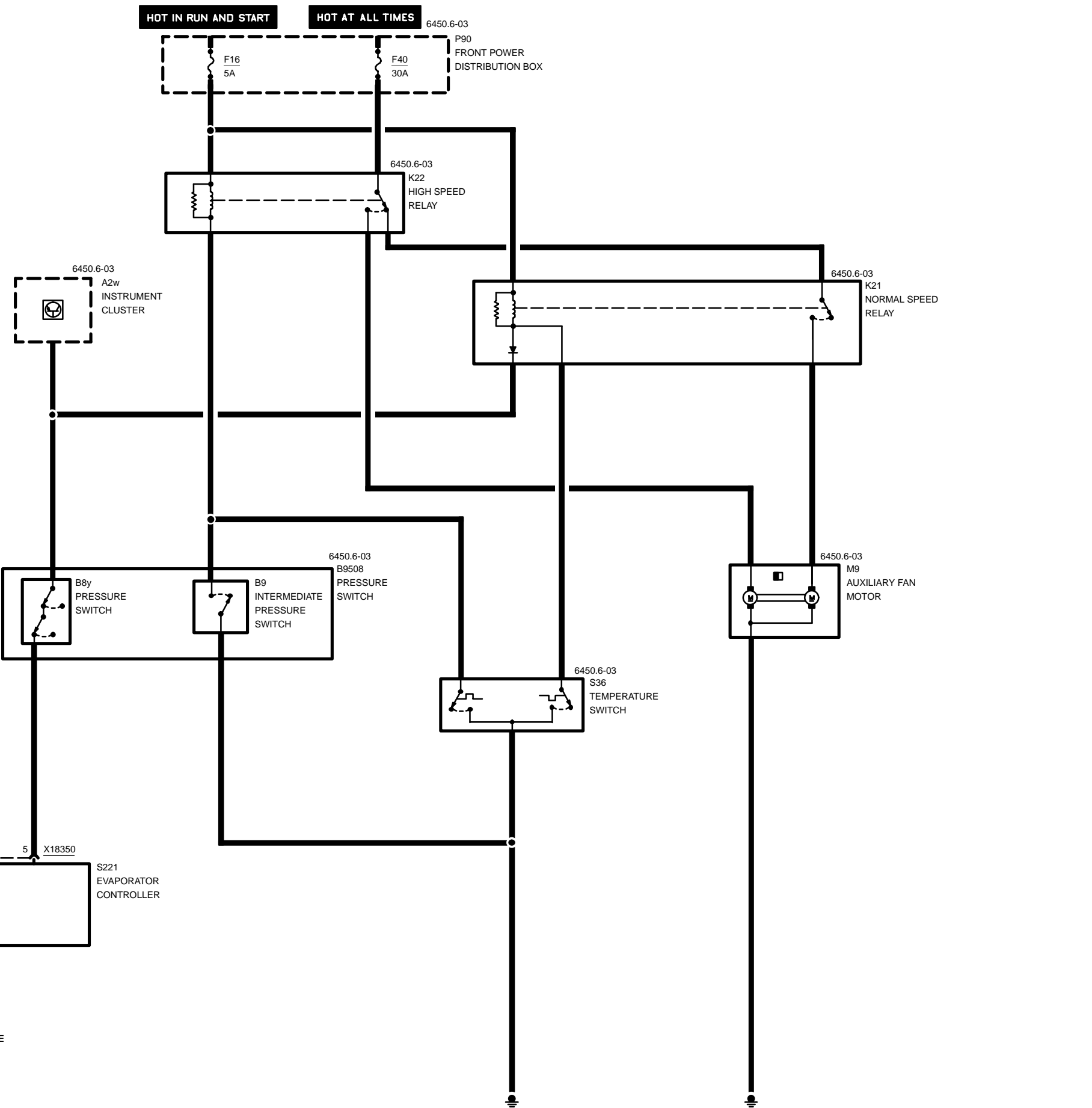

M VERSIONS

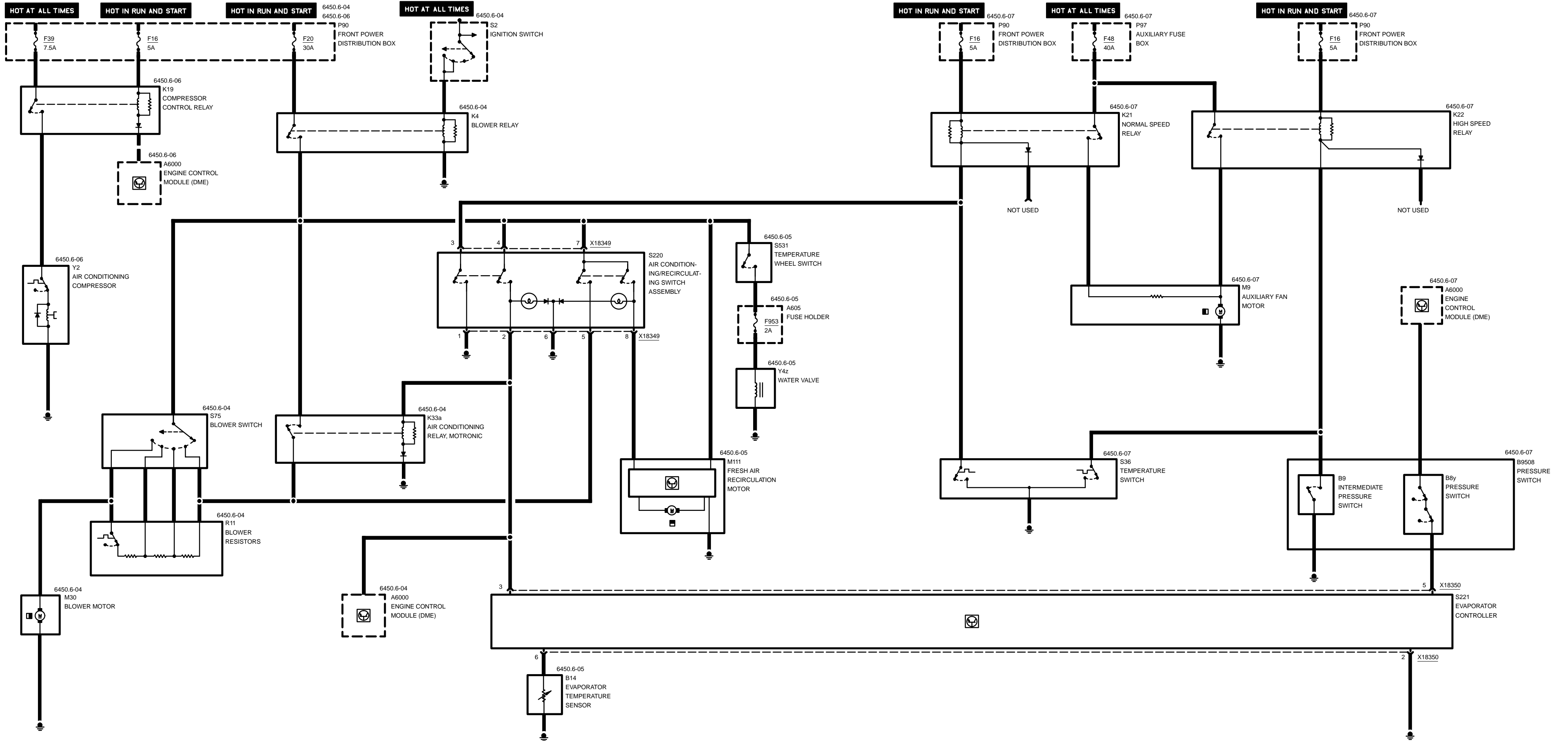



Z3

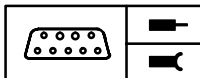

Pin Assignments (Z3 Versions)

X18349	8 Pins, black
X18350	6 Pins, black

X18349

Pin	Type	Description/Function	Connection
1	E	Terminal 15	Heating blower relay
2	A	Activate compressor clutch	Instrument cluster
3	A	Blower level 1 (air conditioning)	Blower resistor
4	E	Terminal 15	Heating blower relay
5	A	Blower level 1 (air-recirculation)	Blower resistor
6	M	Ground for function lights	Ground point
7	E	Terminal 15	Heating blower relay
8	A	Activate fresh air-recirculation	Fresh air-recirculation motor

X18350

Pin	Type	Description/Function	Connection
1		Not used	
2	M	Ground	Ground point
3	E	Climate-ON-signal	Air conditioning/recirculated air operating unit
4		Not used	
5	A	Activate A/C compressor	Pressure switch
6	E	Evaporator temperature	Evaporator temperature sensor

E = Input, A = Output, M = Ground

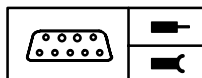

Z3

**Pin Assignments (M Versions)**

X18349	8 Pins, black
X18350	6 Pins, black

X18349

Pin	Type	Description/Function	Connection
1	M	Ground	Ground point
2	A	A/C-ON-signal	Evaporator controller
3	A	A/C-ON-signal	Normal speed relay
4	E	Terminal 15	Heating blower relay
5	A	Blower level 1 (air-recirculation)	Blower resistor
6	M	Ground for function lights	Ground point
7	E	Terminal 15	Heating blower relay
8	A	Activate fresh air-recirculation	Fresh air-recirculation motor

X18350

Pin	Type	Description/Function	Connection
1		Not used	
2	M	Ground	Ground point
3	E	Climate-ON-signal	Air conditioning/recirculated air operating unit
4		Not used	
5	A	Activate A/C compressor	Pressure switch
6	E	Evaporator temperature	Evaporator temperature sensor

E = Input, A = Output, M = Ground



INTEGRATED HEATING- AND CLIMATE CONTROL

Z3 VERSIONS

POWER, AIR FLOW CONTROL

Z3

HOT IN RUN AND START

HOT AT ALL TIMES

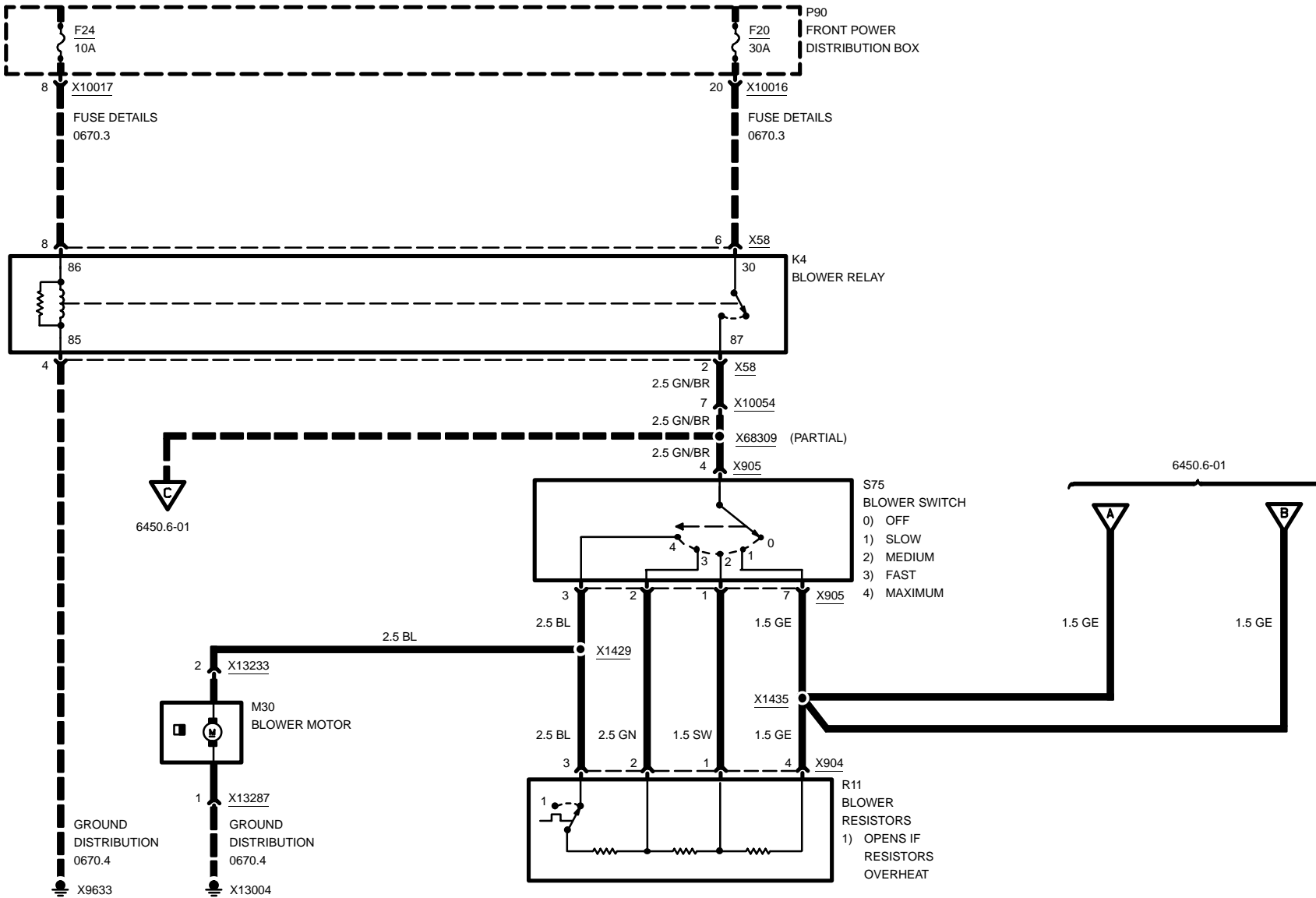

03/00

6450.6-00

1999

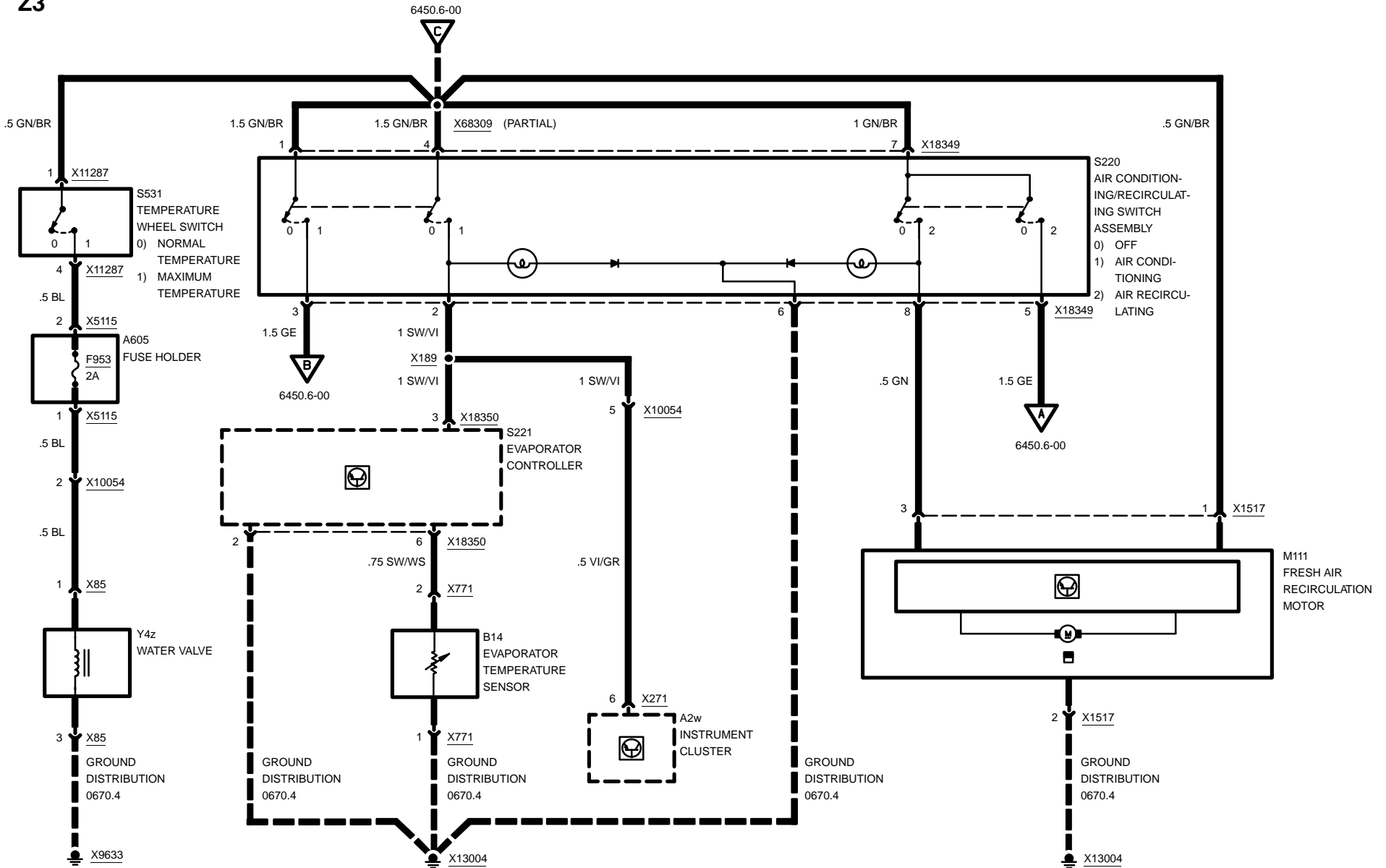



INTEGRATED HEATING- AND CLIMATE CONTROL COMPRESSOR CONTROLS

Z3 VERSIONS

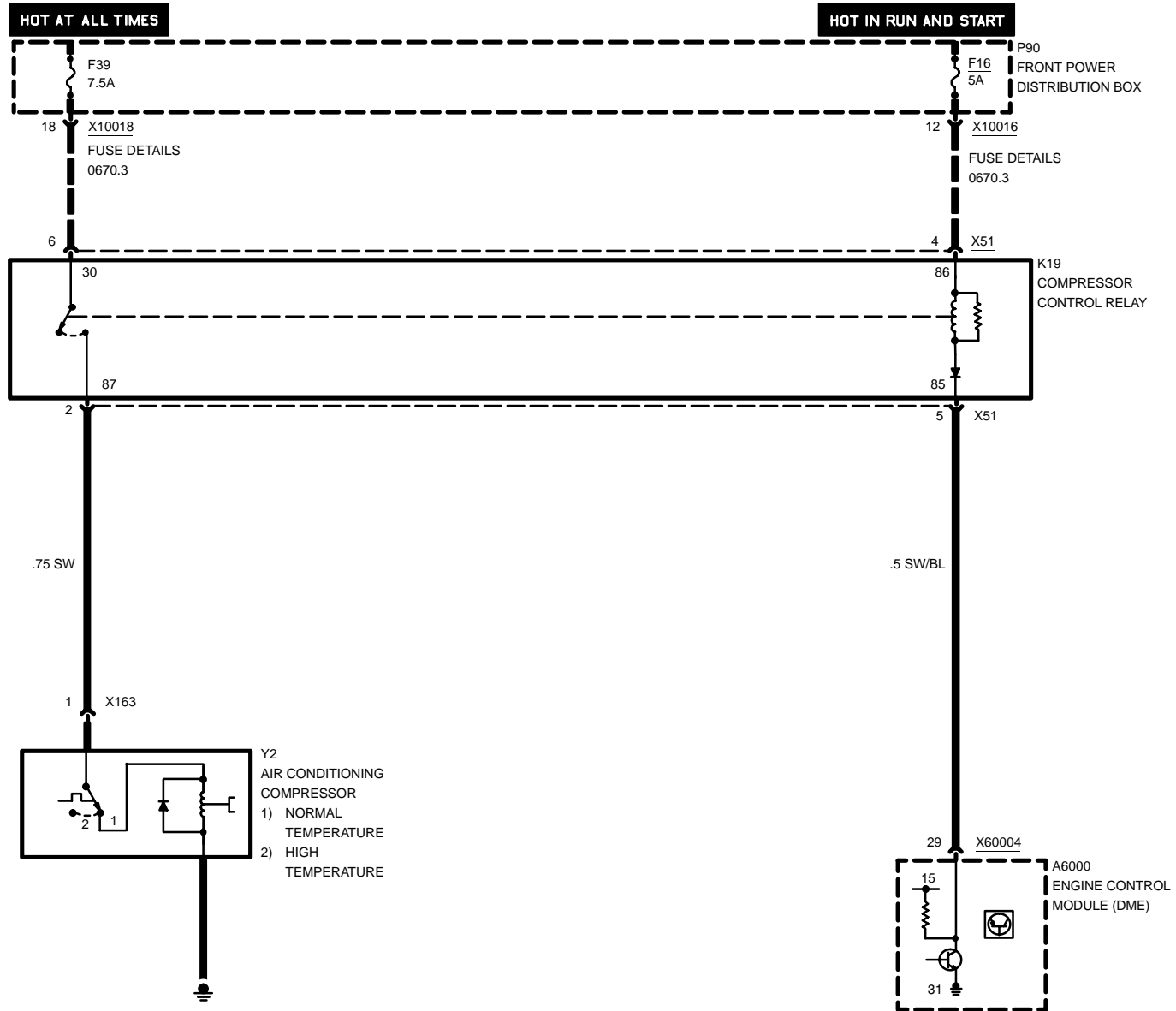

03/00

6450.6-02

1999



INTEGRATED HEATING- AND CLIMATE CONTROL

Z3 VERSIONS

AUXILIARY FAN

Z3

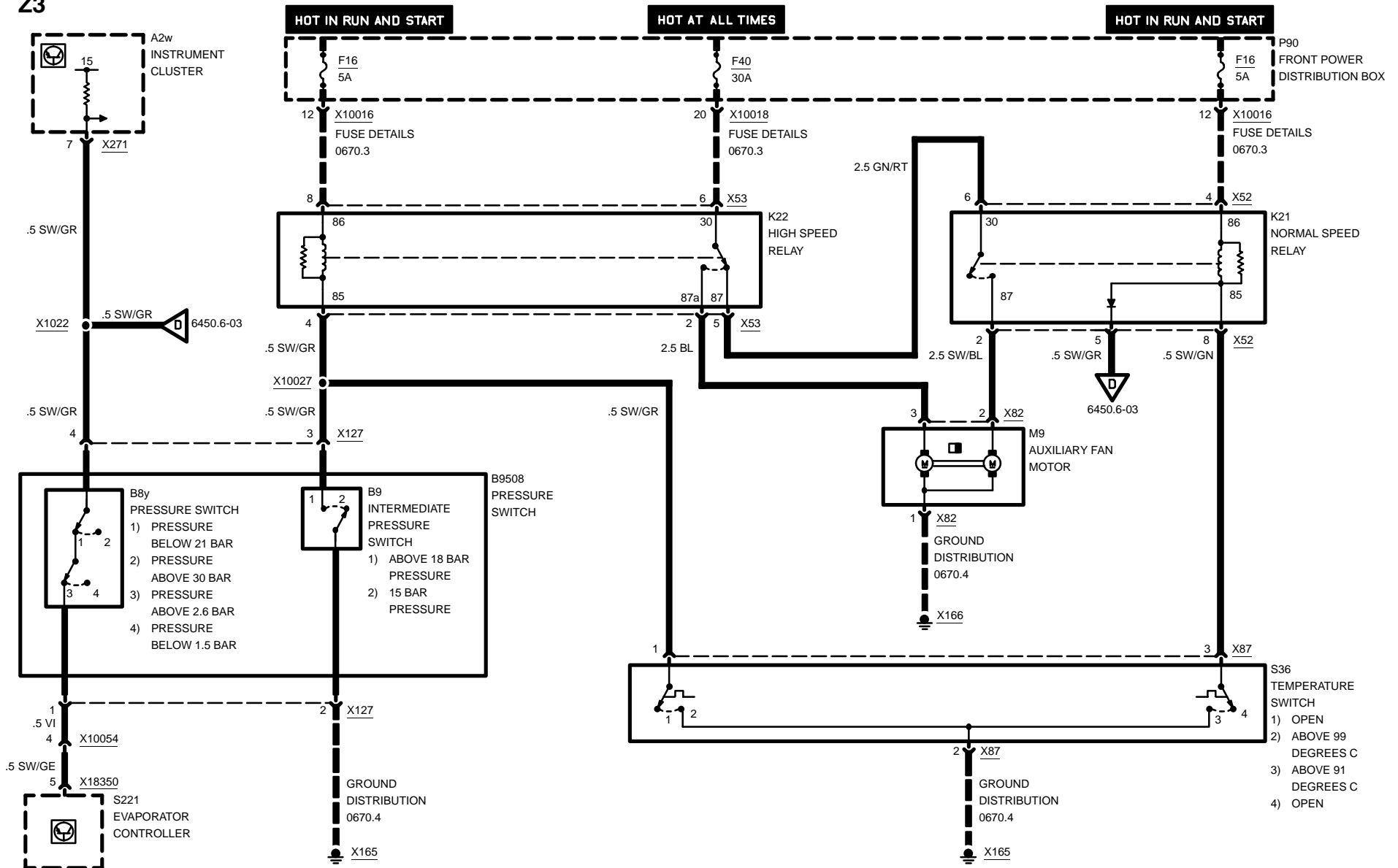

03/00

6450.6-03

1999



INTEGRATED HEATING- AND CLIMATE CONTROL

M VERSIONS

POWER, AIR FLOW CONTROL

Z3

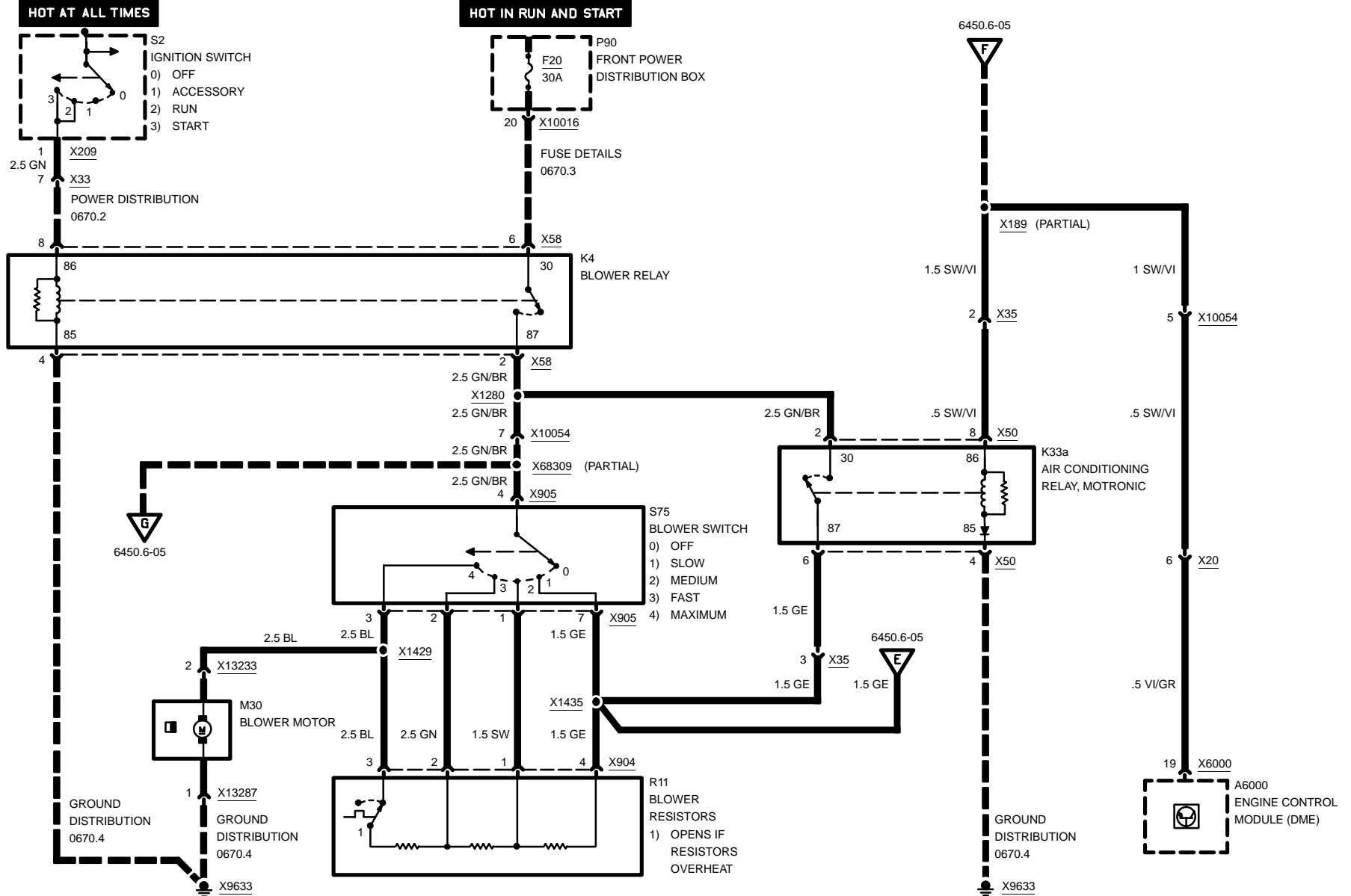

03/00

6450.6-04

1999



INTEGRATED HEATING- AND CLIMATE CONTROL COMPRESSOR CONTROL AND WATER SUPPLY

M VERSIONS

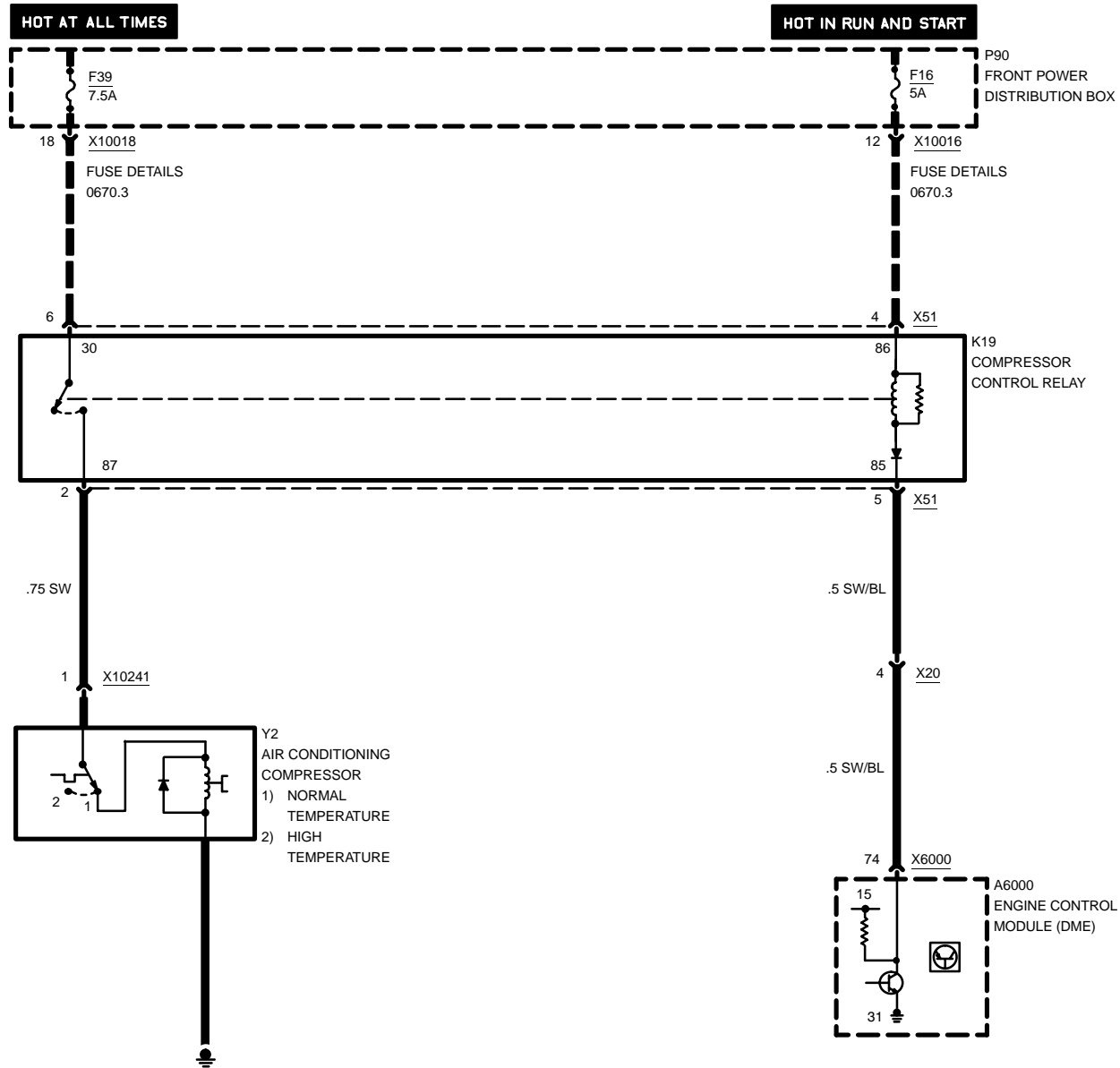

03/00

6450.6-06

1999



INTEGRATED HEATING- AND CLIMATE CONTROL

M VERSIONS

AUXILIARY FAN

Z3

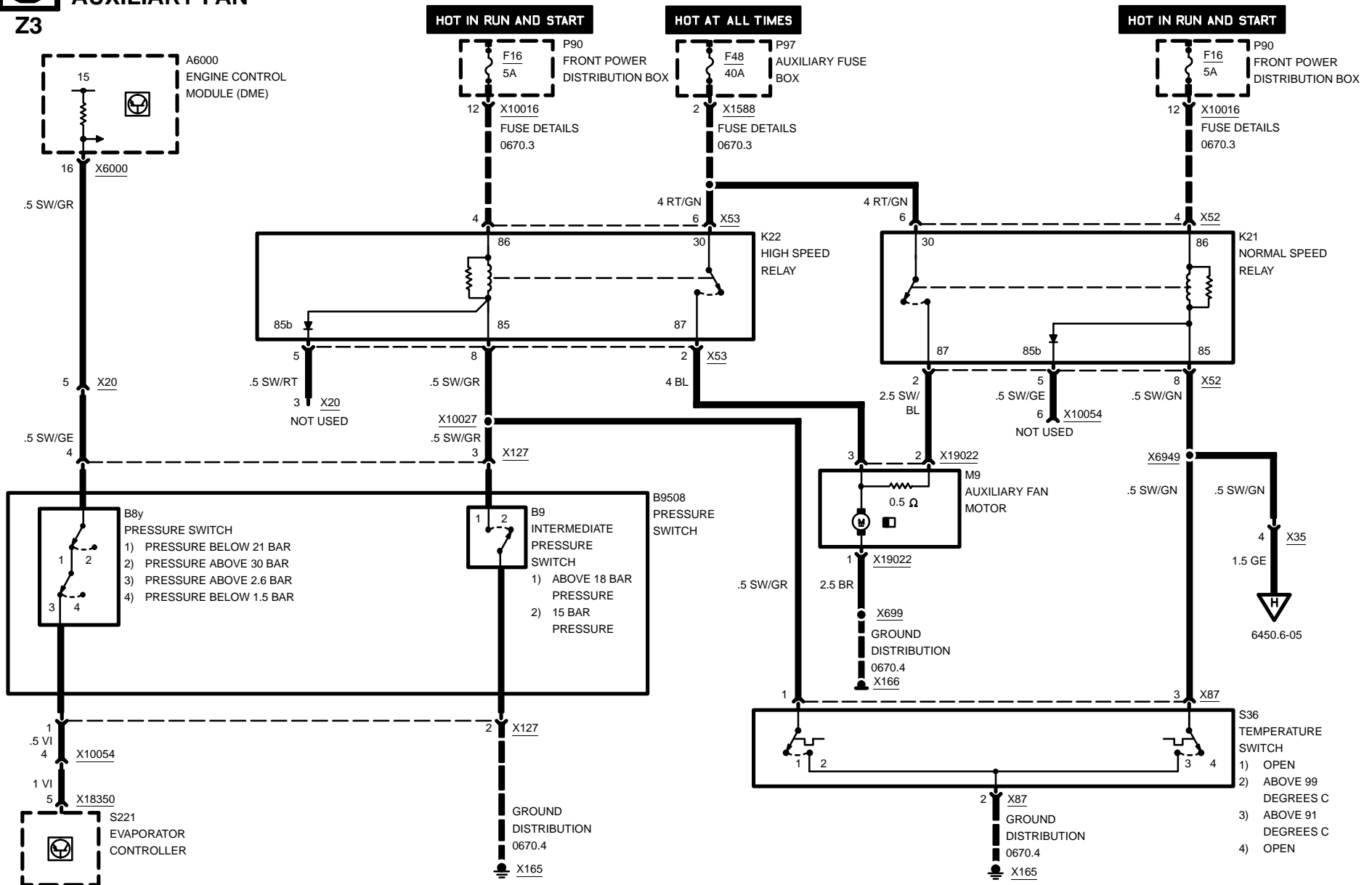

03/00

6450.6-07

1999



6510.1 RADIO/HIFI

Z3

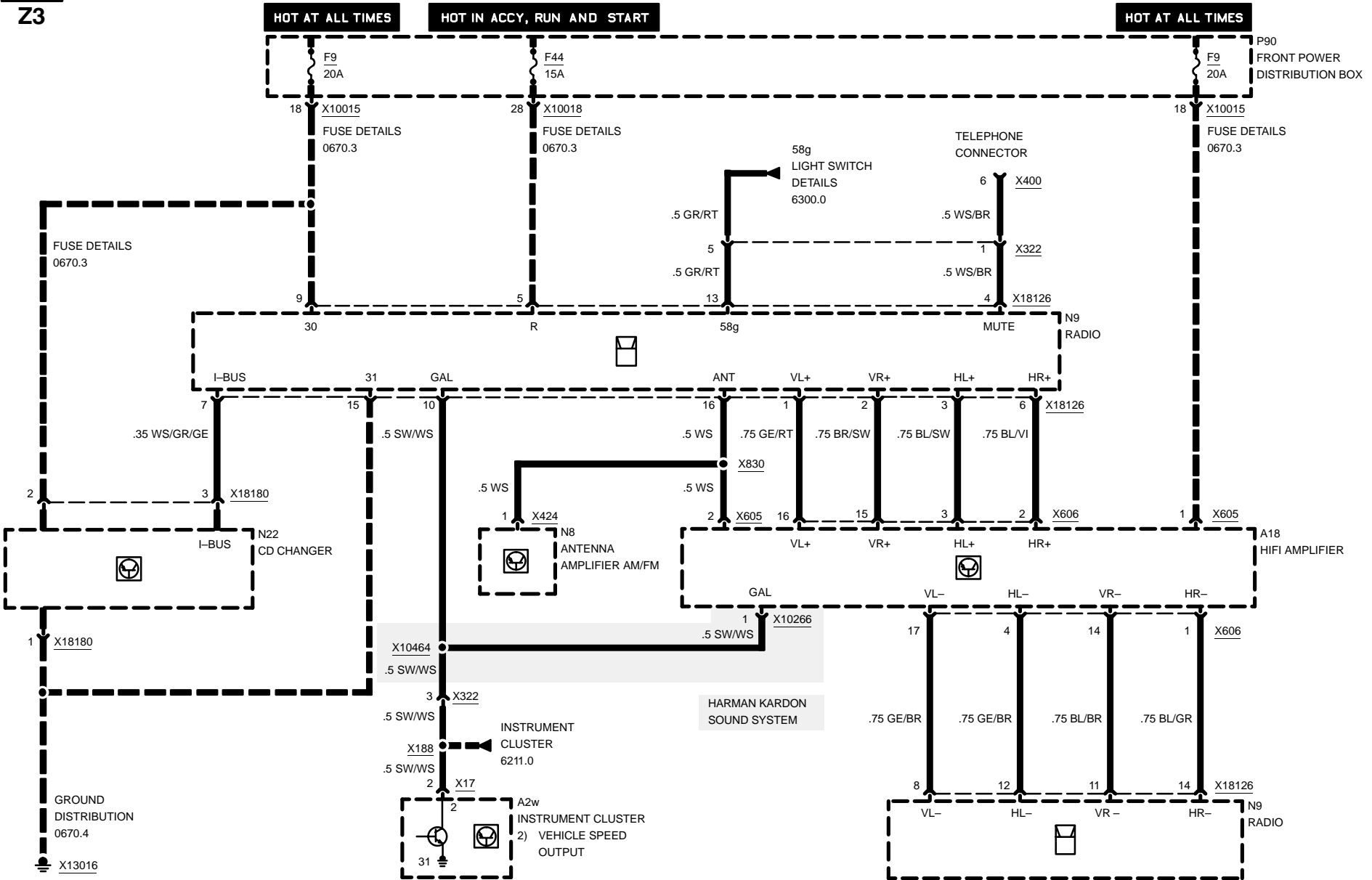

03/00

6510.1-00

1999



RADIO/HIFI

Z3

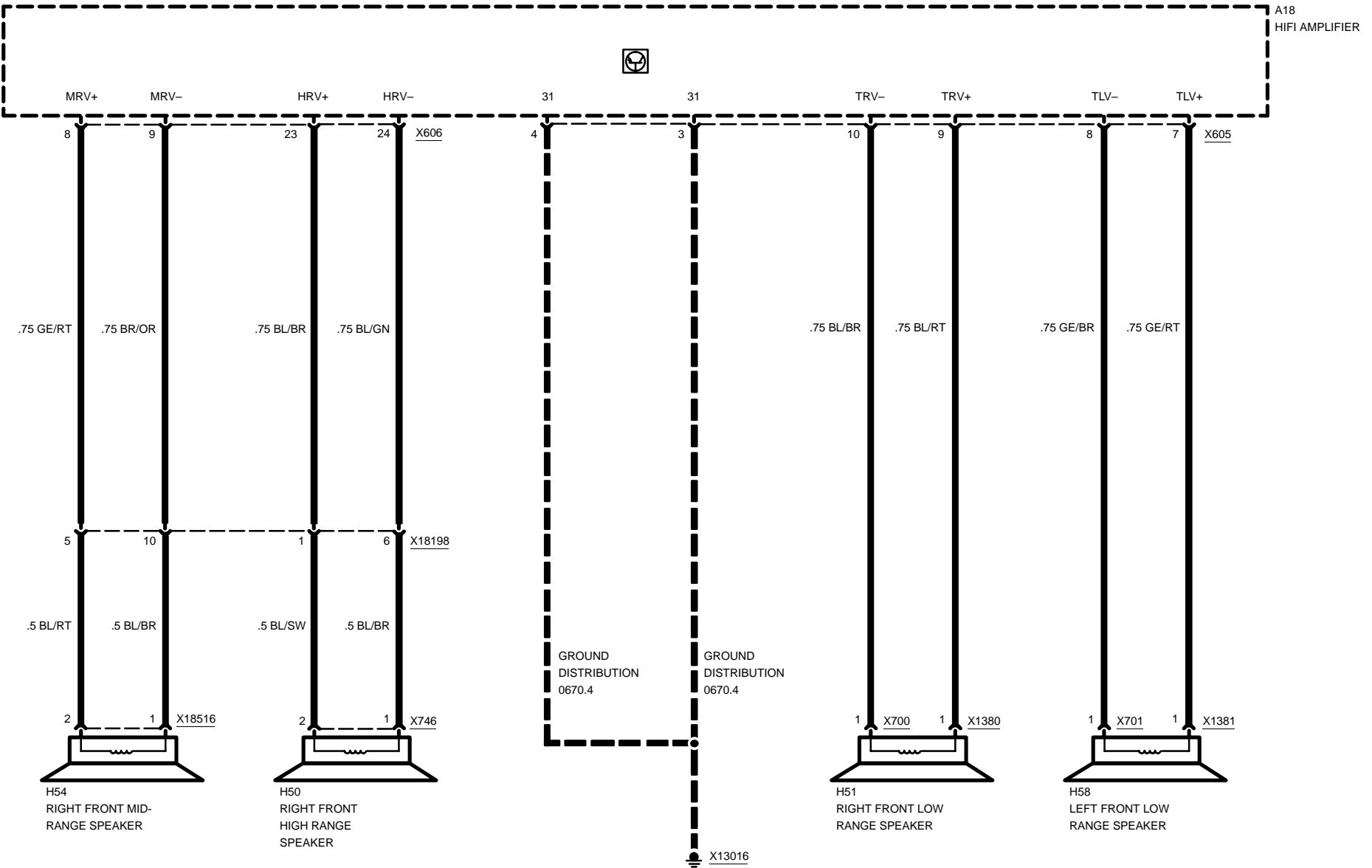

03/00

6510.1-01

1999



RADIO/HIFI

COUPE WITH HARMAN KARDON SOUND SYSTEM AND ROADSTER

Z3

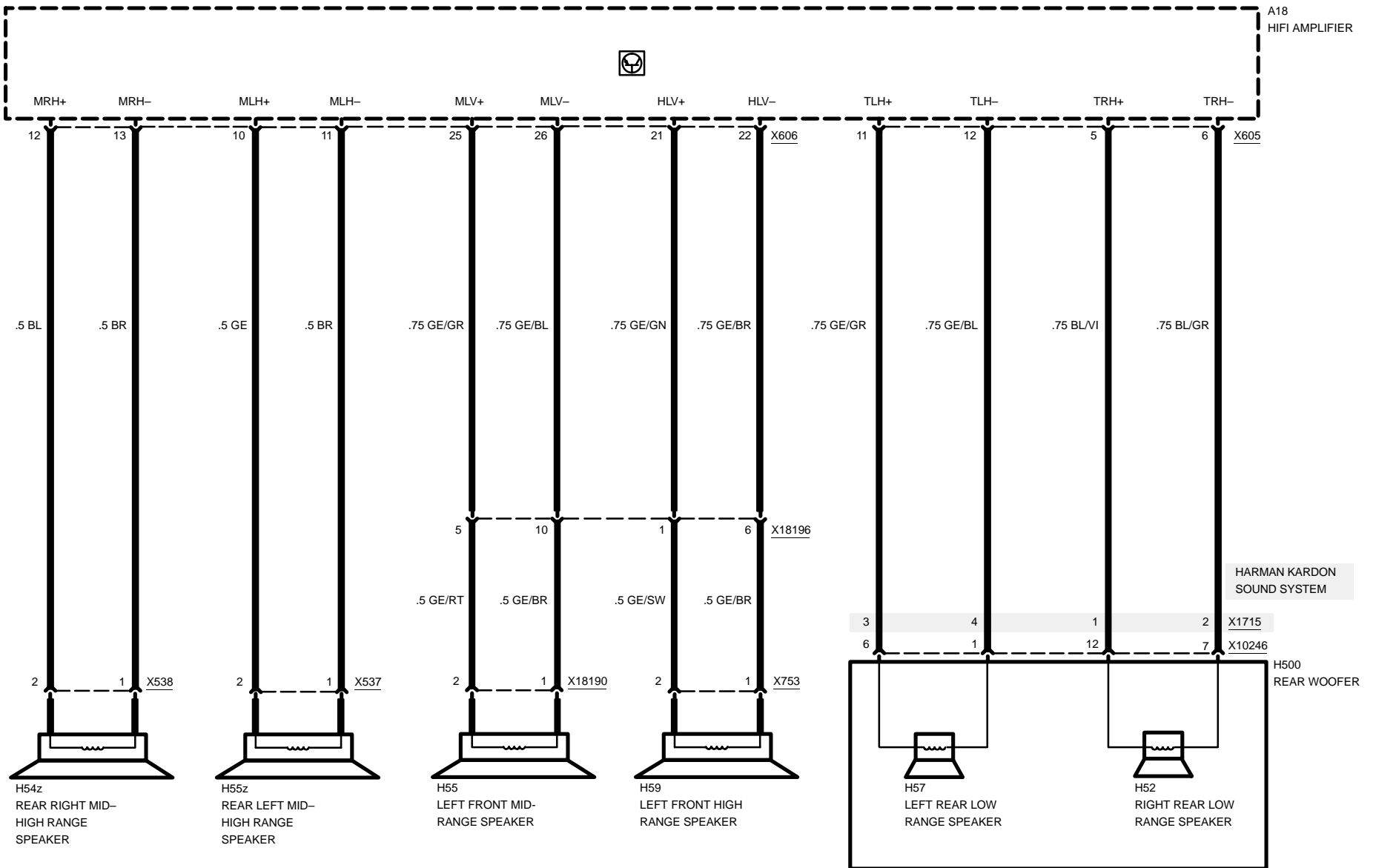

03/00

6510.1-02

1999



RADIO/HIFI

COUPE WITH HIFI

Z3

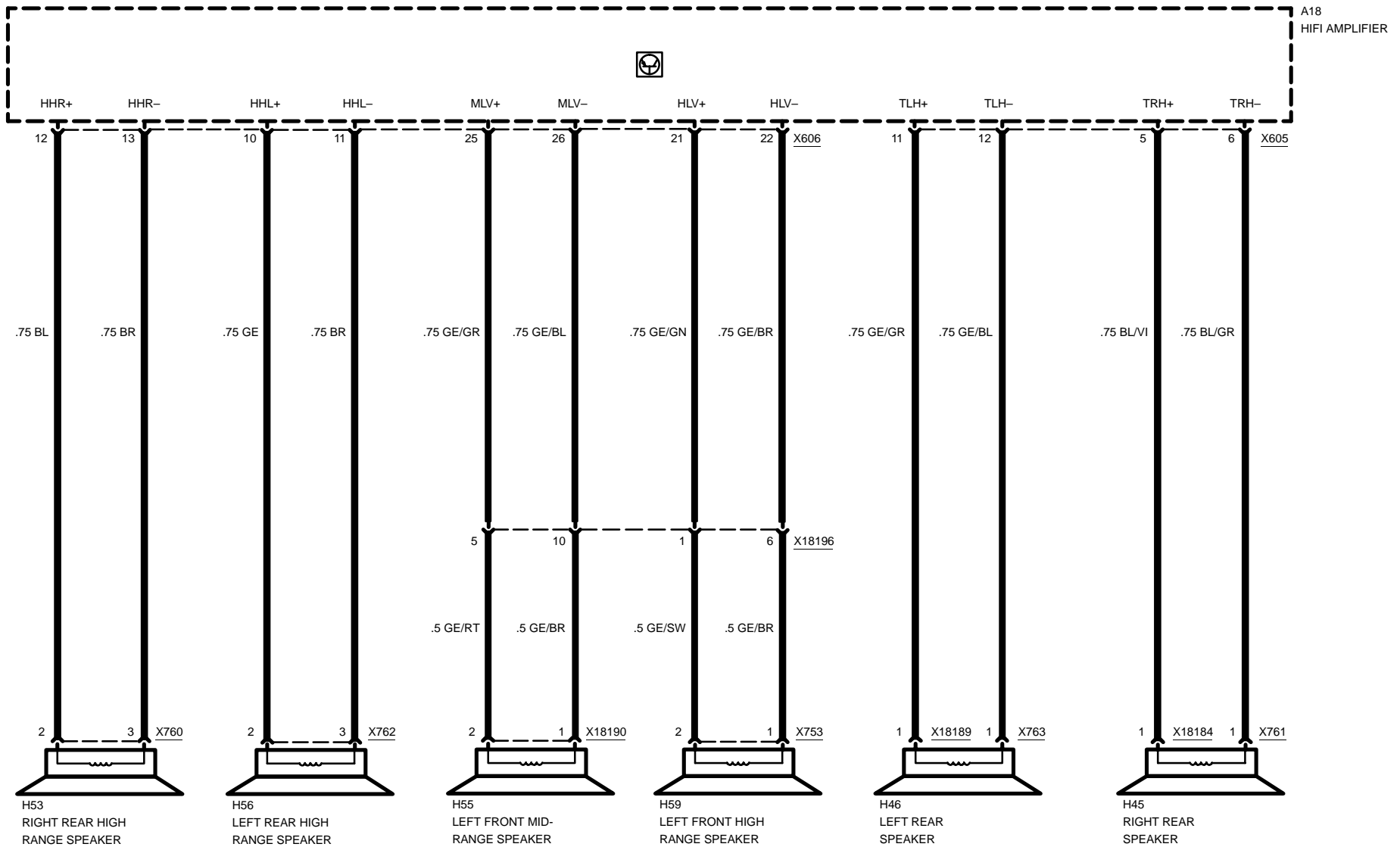

03/00

6510.1-03

1999



RADIO/HIFI

Z3

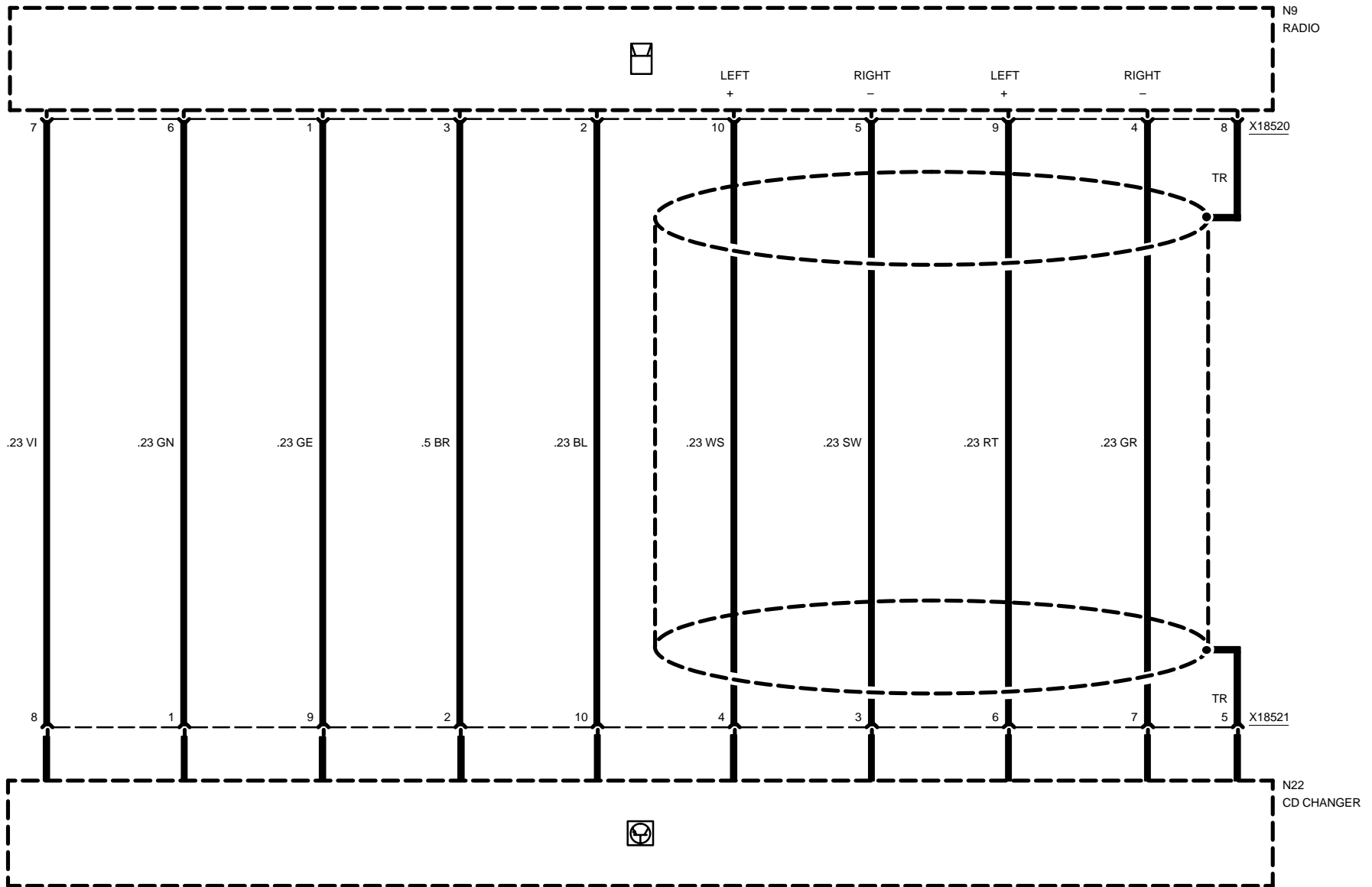

03/00

6510.1-04

1999



6561.0 CELLULAR TELEPHONE (PROVISIONS)

PROVISIONS

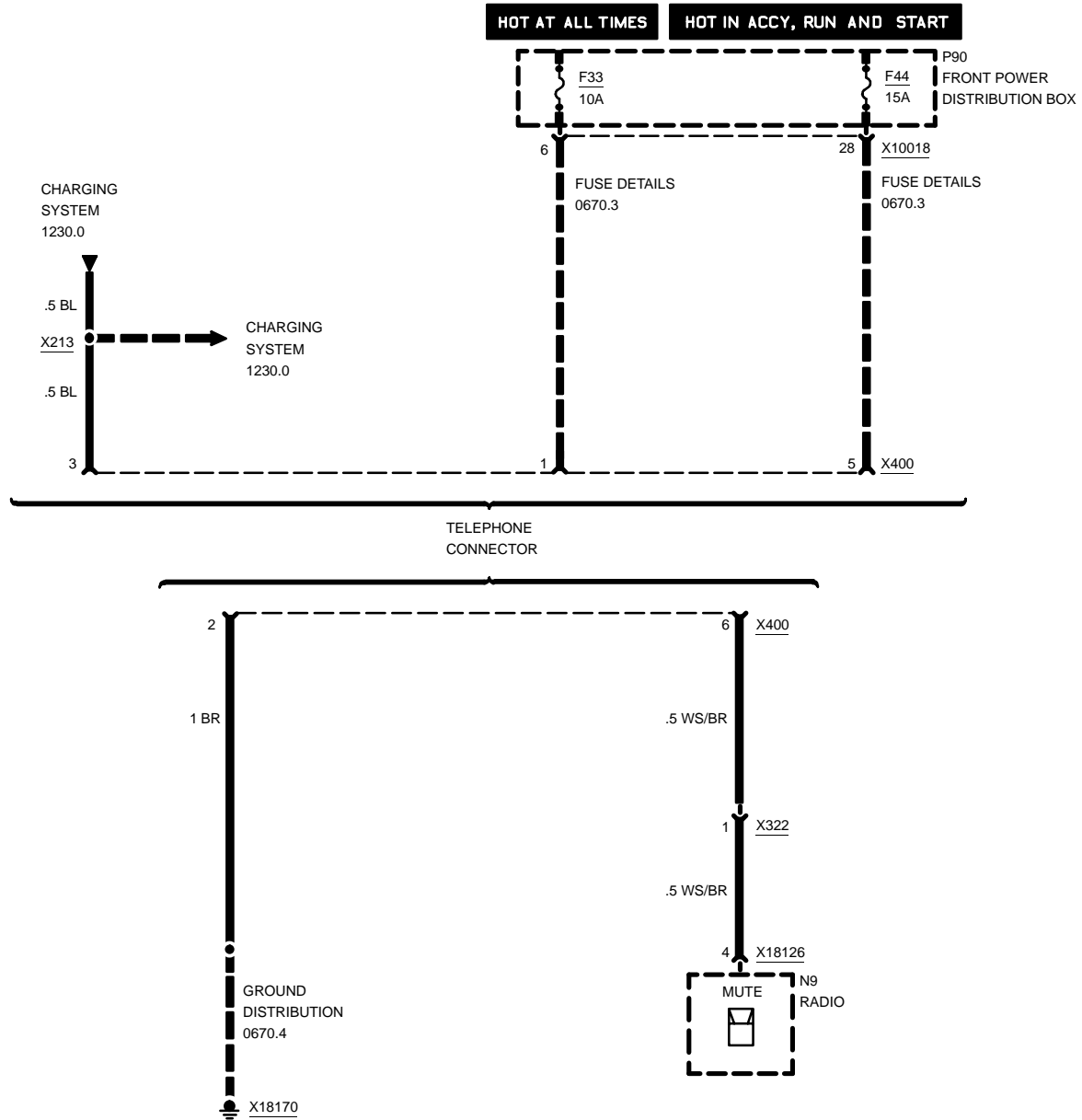

03/00

6561.0-00

1999



Z3

6571.0 CRUISE CONTROL (TEMPOMAT)

M VERSIONS

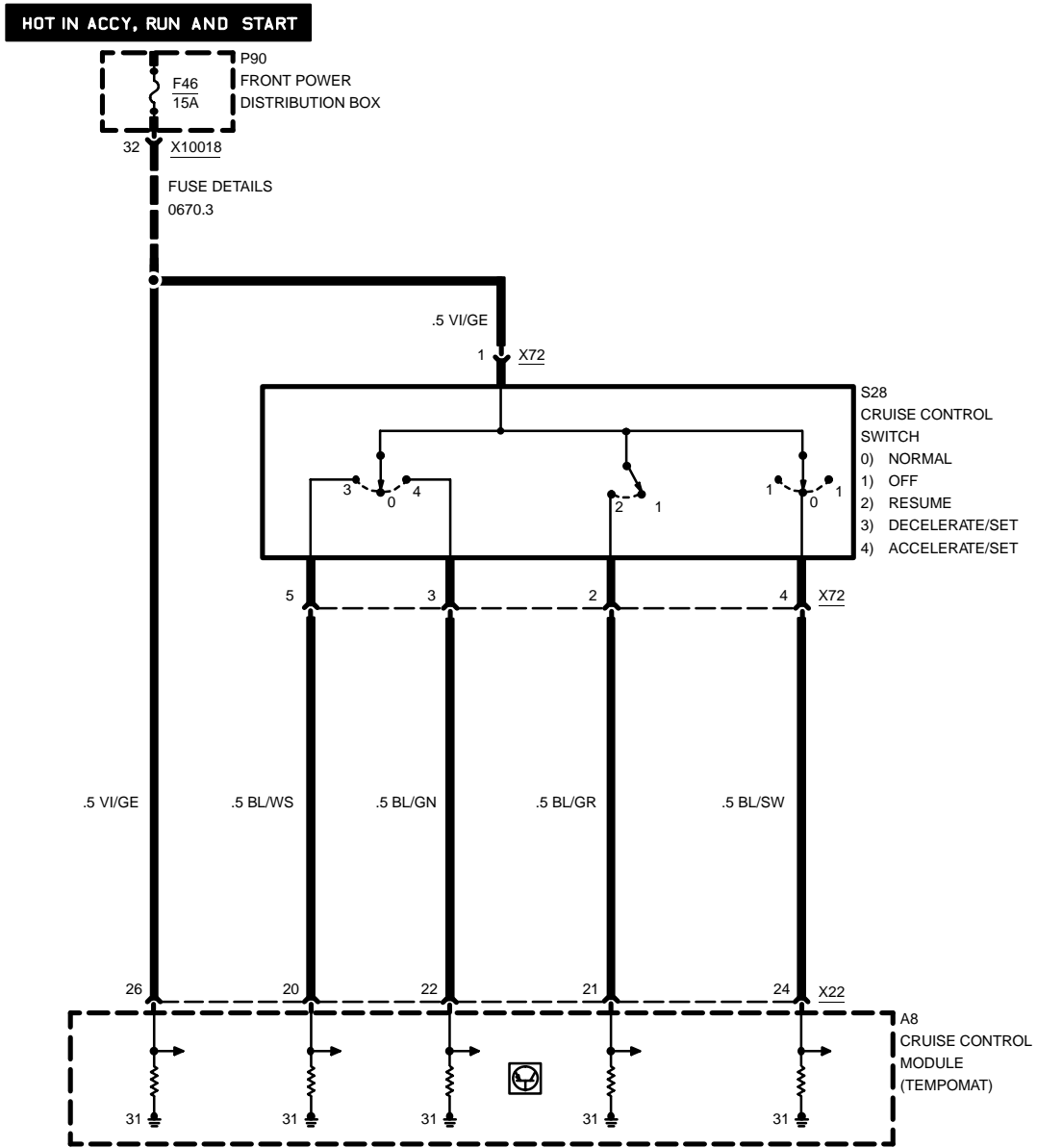

03/00

6571.0-00

1999



CRUISE CONTROL (TEMPOMAT)

M VERSIONS

Z3

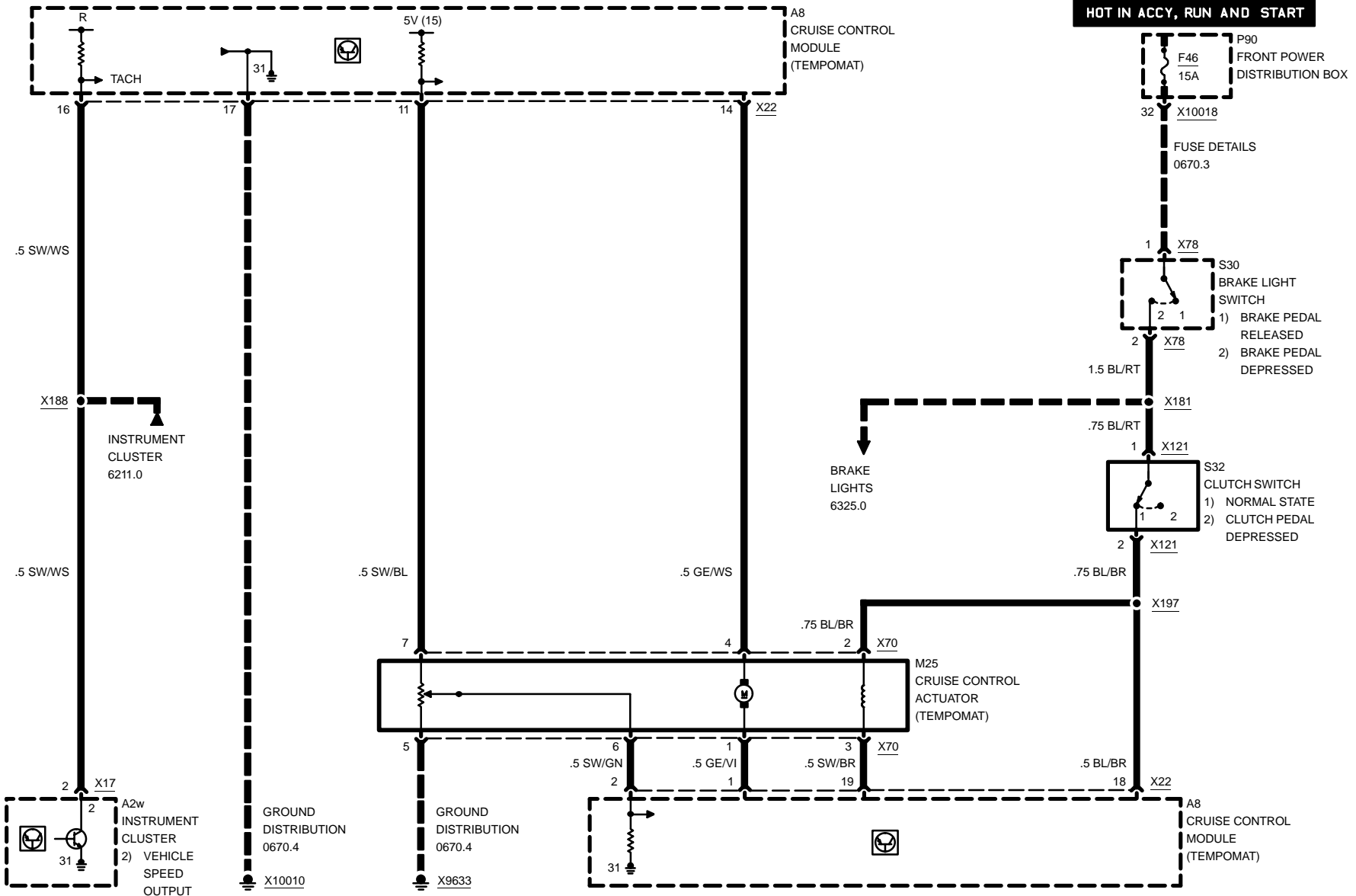

03/00

6571.0-01

1999

CRUISE CONTROL (TEMPOMAT)

Z3 VERSIONS

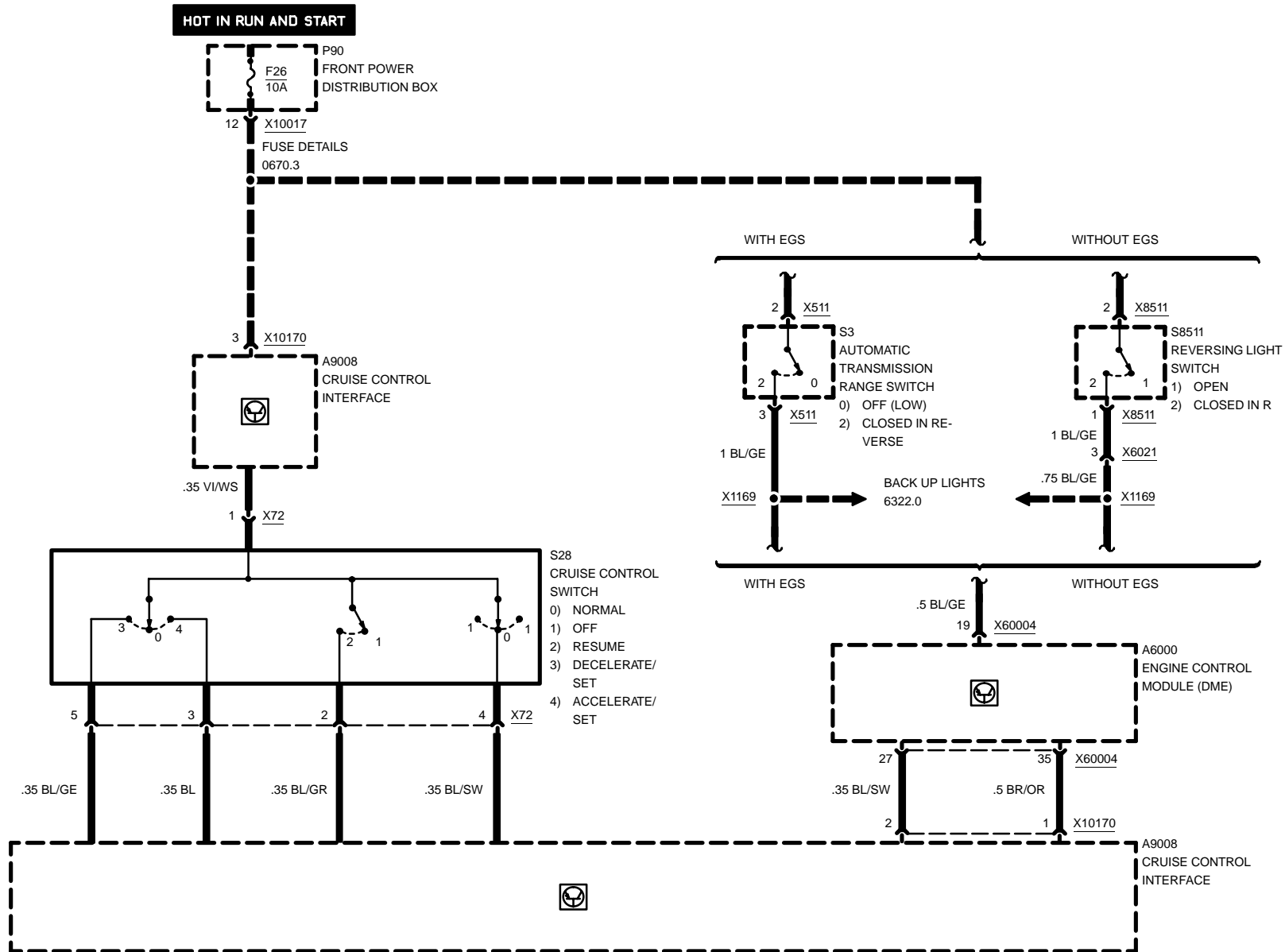



CRUISE CONTROL (TEMPOMAT)

Z3 VERSIONS

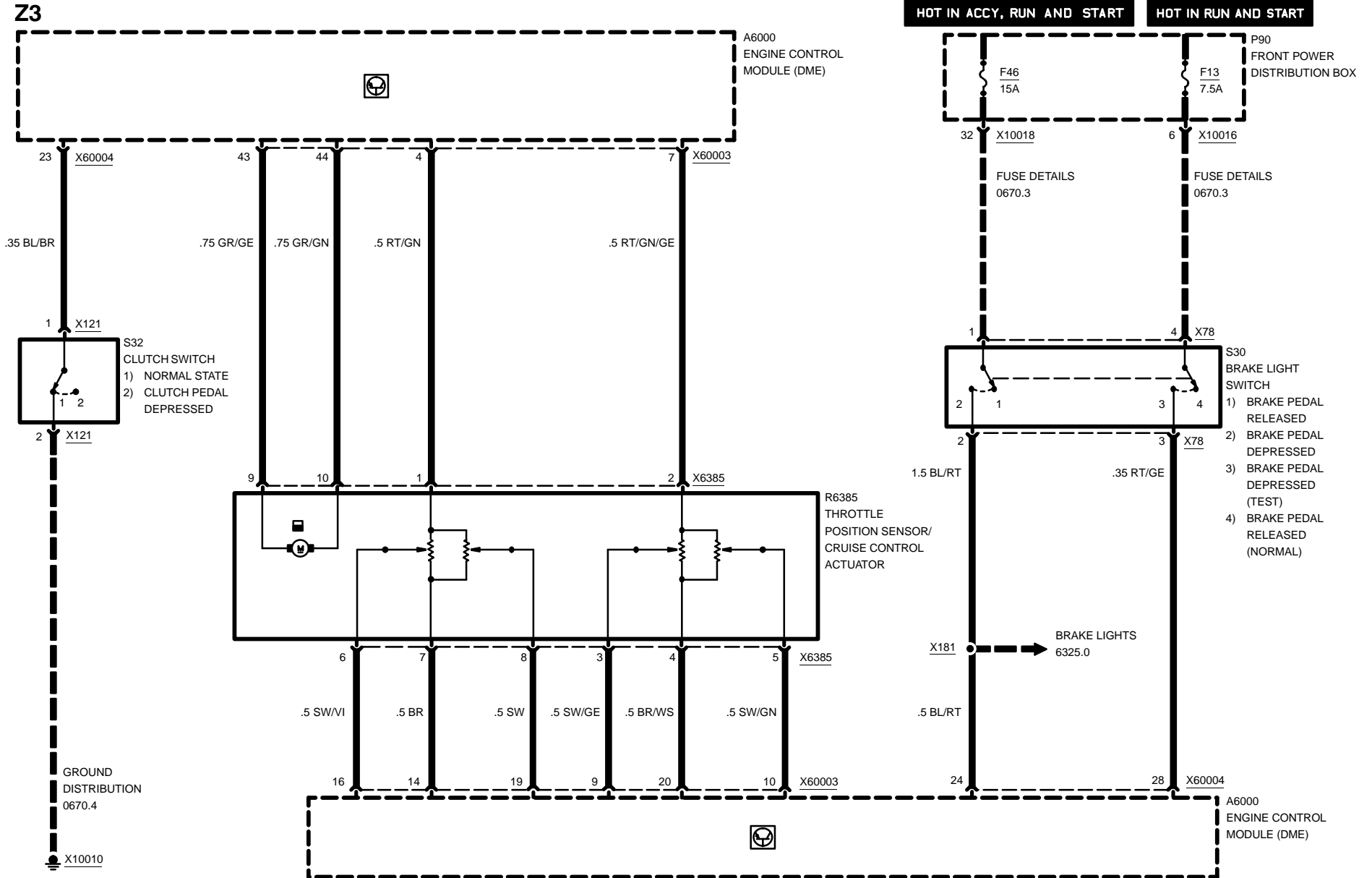

03/00

6571.0-03

1999

6575.2 ANTI-THEFT SYSTEM (ALPINE)

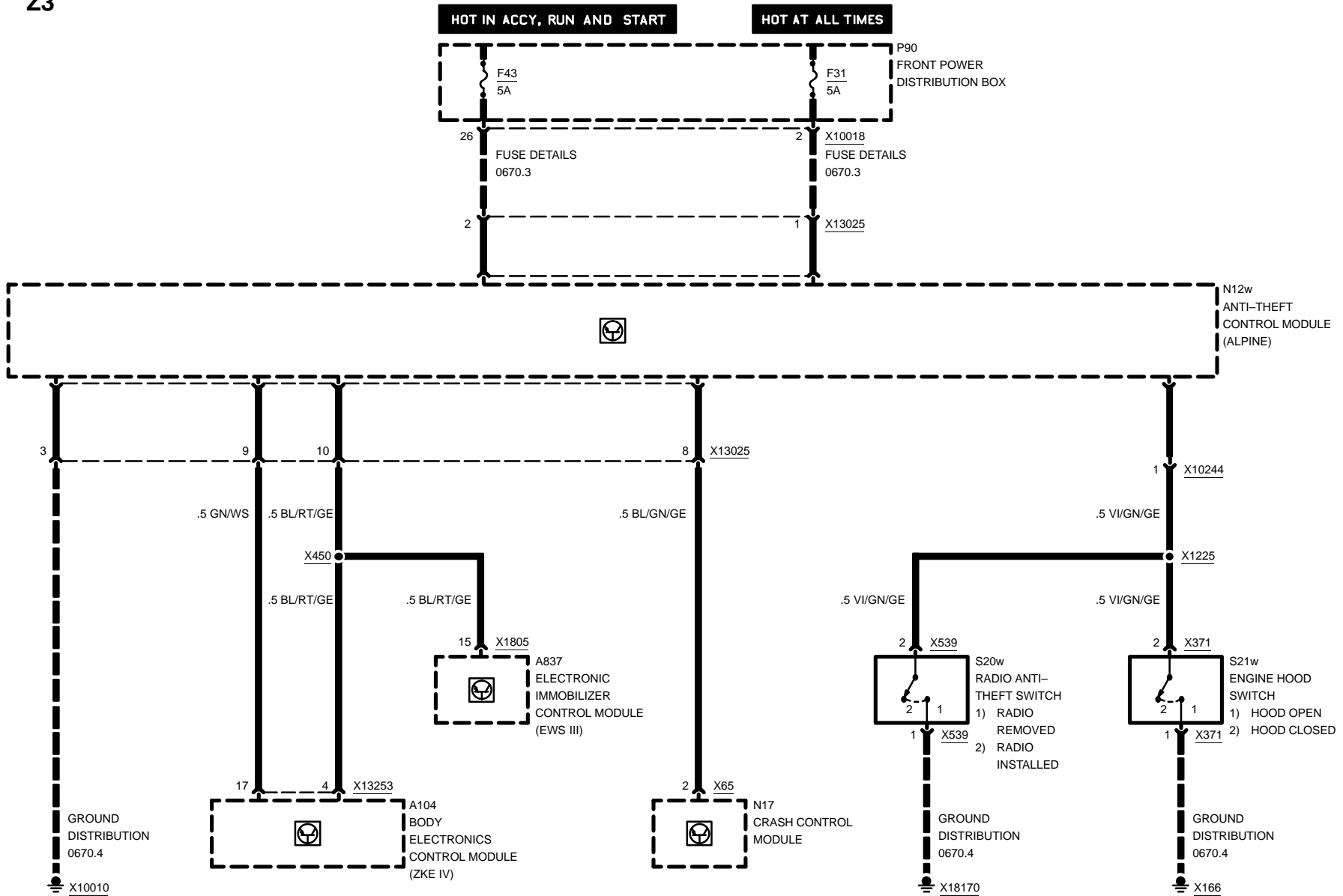

ANTI-THEFT SYSTEM (ALPINE)

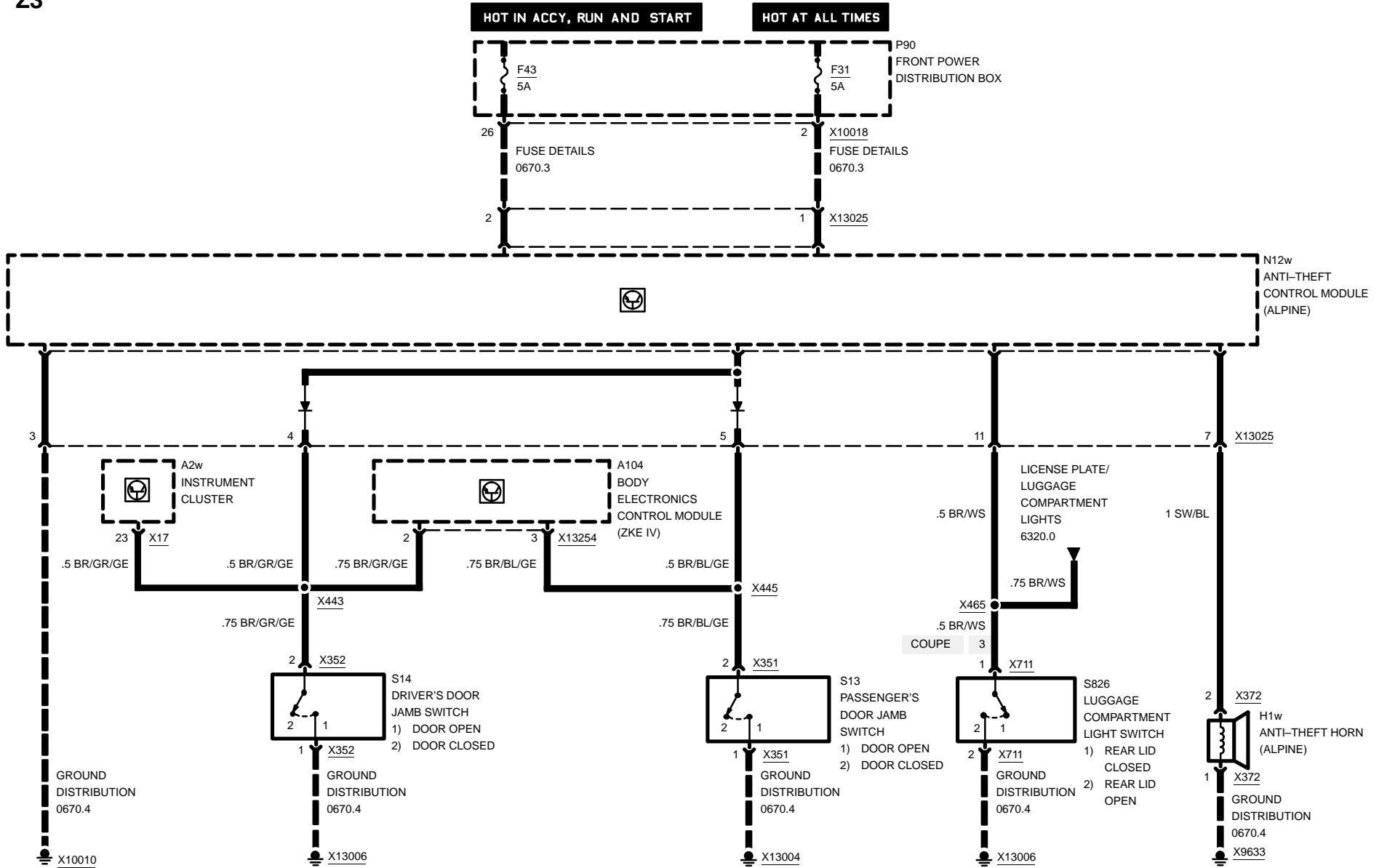



Z3

6581.3 BOARD COMPUTER (BC - LOW)

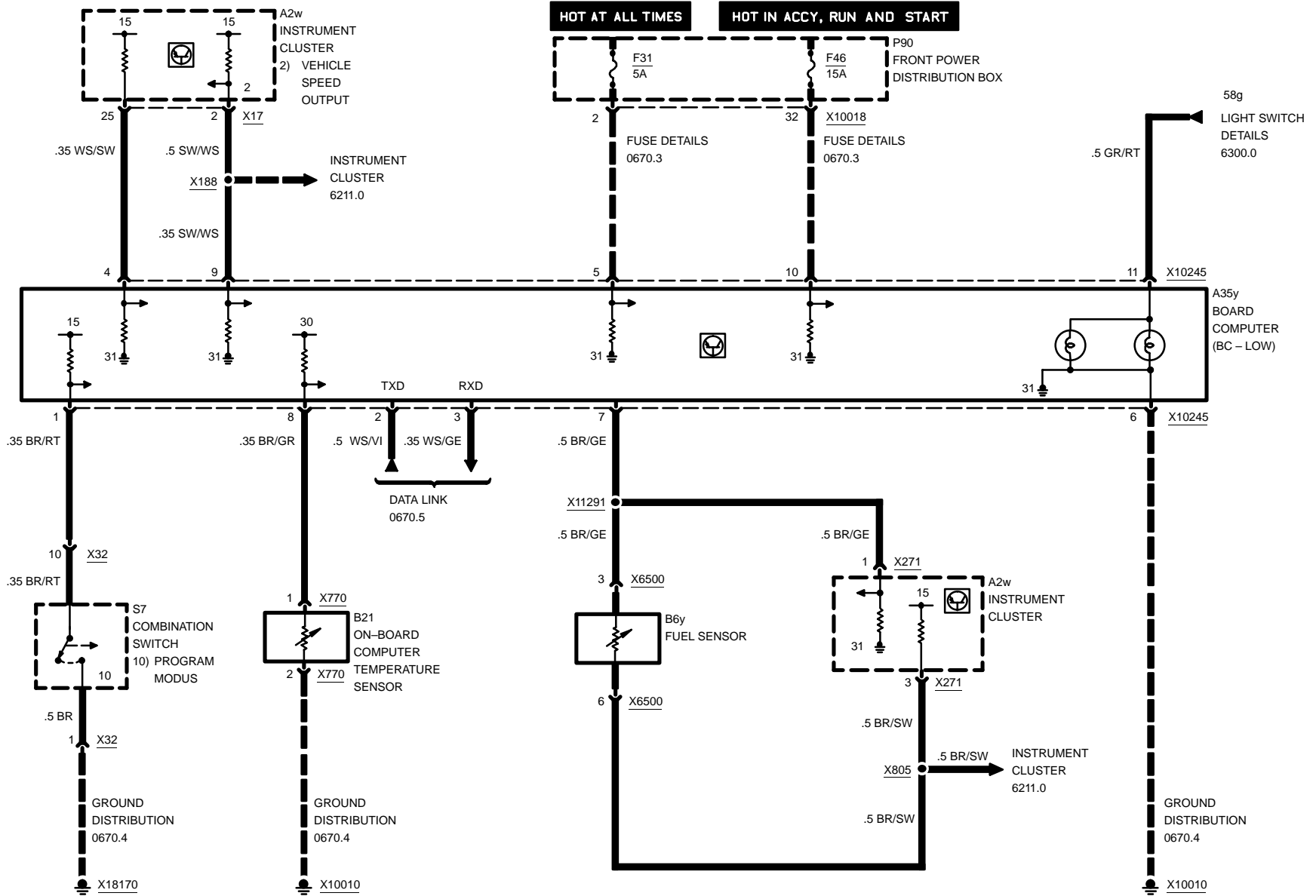

03/00

6581.3-00

1999



7000.0 COMPONENT LOCATION CHART

Z3

COMP.	DESCRIPTION	LOCATION	7100.0	8500.0
A2w ..	INSTRUMENT CLUSTER	LH side of dash	20-2	
A8	CRUISE CONTROL MODULE (TEMPOMAT)	behind glove box	00-2	
A12 ..	SUPPLEMENTAL RESTRAINT SYSTEM CONTROL MODULE	below center console	22-2	
A18 ..	HIFI AMPLIFIER	in RH side of luggage compartment (ROADSTER)	27-3	
A18 ..	HIFI AMPLIFIER	in RH side of luggage compartment (COUPE)	46-1	
A35y .	BOARD COMPUTER (BC – LOW)	center console	00-3	
A36 ..	REAR WIPER/WASHER INTERVAL CONTROL MODULE	in lift gate	37-2	
A51 ..	WIPER/WASHER MODULE	behind glove box	38-2	
A52 ..	SLIP CONTROL MODULE (ABS/ASC)	front LH side of engine compartment (Z3 VERSIONS)	39-3	
A52 ..	SLIP CONTROL MODULE (ABS/ASC)	behind glove box (M VERSIONS)	00-2	
A104 .	BODY ELECTRONICS CONTROL MODULE (ZKE IV)	behind glove box	38-2	
A110 ..	DIGITAL CLOCK	center console		
A113 ..	SEAT OCCUPANCY DETECTOR	under RH front seat	24-1	
A113 ..	SEAT OCCUPANCY DETECTOR	under RH front seat (WITH SPORT SEAT)	11-2	
A605 .	FUSE HOLDER	center console (radio and console removed)	36-1	
A837 .	ELECTRONIC IMMOBILIZER CONTROL MODULE (EWS III)	LH side of steering column	38-3	
A6000	ENGINE CONTROL MODULE (DME)	rear RH side of engine compartment in E-Box (M VERSIONS)	00-1	
A6000	ENGINE CONTROL MODULE (DME)	rear RH side of engine compartment in E-Box (Z3 VERSIONS)	40-2	

03/00

7000.0-0

1999



COMPONENT LOCATION CHART

Z3

COMP.	DESCRIPTION	LOCATION	7100.0	8500.0
A8500	TRANSMISSION CONTROL MODULE (EGS)	rear RH side of engine compartment in E-Box	42-3	
A9008	CRUISE CONTROL INTERFACE	near steering column	38-3	
A19007	THERMAL OIL LEVEL SENSOR (TOENS) CONTROL MODULE	behind glove box	38-1	
B1	RIGHT FRONT SPEED SENSOR – ABS	on RH front wheel, above brake caliper		
B2	LEFT FRONT SPEED SENSOR – ABS	on LH front wheel, above brake caliper	12-3	
B3	RIGHT REAR SPEED SENSOR – ABS	on RH rear wheel, above brake caliper		
B4	LEFT REAR SPEED SENSOR – ABS	on LH rear wheel, above brake caliper		
B6y	FUEL SENSOR	in fuel tank		
B8y	PRESSURE SWITCH	front RH side of engine compartment		
B9	INTERMEDIATE PRESSURE SWITCH	front RH side of engine compartment		
B10	VEHICLE SPEED SENSOR	on differential	15-2	
B14	EVAPORATOR TEMPERATURE SENSOR	RH side of LH footwell	21-2	
B16	LEFT FRONT BRAKE PAD SENSOR	on LH front wheel, above brake caliper	12-3	
B17	RIGHT REAR BRAKE PAD SENSOR	behind RH rear wheel		
B18	BRAKE FLUID LEVEL SWITCH	rear LH side of engine compartment	09-1	
B21	ON-BOARD COMPUTER TEMPERATURE SENSOR	in RH front bumper	11-3	
B59	OIL TEMPERATURE GAUGE	center console		
B65	FUEL TANK PRESSURE SENSOR	under rear storage compartment	07-2	
B78	DRIVER'S SIDE IMPACT SENSOR	under LH front seat	35-3	
B79	PASSENGER'S SIDE IMPACT SENSOR	under RH front seat	35-1	

03/00

7000.0-1

1999



COMPONENT LOCATION CHART

Z3

COMP.	DESCRIPTION	LOCATION	7100.0	8500.0
B211 ..	VOLTMETER	center console		
B6203	CRANKSHAFT POSITION/RPM SENSOR	rear LH side of engine compartment (M VERSIONS)	32-3	
B6203	CRANKSHAFT POSITION/RPM SENSOR	rear LH side of engine compartment (Z3 VERSIONS)	41-3	
B6204	CAMSHAFT POSITION SENSOR (CYLINDER IDENTIFICATION)	front of engine	31-3	
B6205	INTAKE AIR TEMPERATURE SENSOR ..	front LH side of engine compartment (M VERSIONS)	34-1	
B6205	INTAKE AIR TEMPERATURE SENSOR ..	top center of engine (Z3 VERSIONS)	42-2	
B6207	HOT FILM AIR MASS METER	LH side of engine compartment (M VERSIONS)	33-3	
B6207	HOT FILM AIR MASS METER	LH side of engine compartment (Z3 VERSIONS)		
B6209	HALL EFFECT CAMSHAFT SENSOR	front of engine		
B6214	CAMSHAFT POSITION SENSOR 1 (INLET)	front of engine		
B6224	CAMSHAFT POSITION SENSOR 2 (OUTLET)	front of engine	47-2	
B6231	OIL PRESSURE SWITCH	lower LH side of engine (M VERSIONS)	32-2	
B6231	OIL PRESSURE SWITCH	LH side of engine compartment (Z3 VERSIONS)	44-1	
B6232	ENGINE COOLANT TEMPERATURE SENSOR	front of engine		
B6236	ENGINE COOLANT TEMPERATURE SENSOR	front of engine	40-1	
B6238	OIL TEMPERATURE SENSOR	RH side of oil filter (M VERSIONS)	32-2	
B6238	OIL TEMPERATURE SENSOR	RH side of oil filter (Z3 VERSIONS)	44-1	
B6240	KNOCK SENSOR	LH side of engine (Z3 VERSIONS)	42-1	
B6240	KNOCK SENSOR	top front of engine (M VERSIONS)	33-2	

03/00

7000.0-2

1999



COMPONENT LOCATION CHART

Z3

COMP.	DESCRIPTION	LOCATION	7100.0	8500.0
B6247	CHARCOAL FILTER SHUT-OFF VALVE . . .	under LH rear of car	12-1	
B6254	THERMAL OIL LEVEL SWITCH	lower LH side of engine compartment	47-1	
B6256	DUAL TEMPERATURE SENSOR (COOLANT TEMPERATURE)	rear of engine compartment	32-1	
B6279	THERMOSTAT, CHARACTERISTIC MAP COOLING	front of engine	39-1	
B9508	PRESSURE SWITCH	front RH side of engine compartment	30-2	
B62101	OXYGEN SENSOR I (IN FRONT OF CATALYTIC CONVERTER)	on catalytic converter	43-3	
B62102	OXYGEN SENSOR I (BEHIND CATALYTIC CONVERTER)	on catalytic converter		
B62201	OXYGEN SENSOR II (IN FRONT OF CATALYTIC CONVERTER)	on catalytic converter	43-3	
B62202	OXYGEN SENSOR II (BEHIND CATALYTIC CONVERTER)	on catalytic converter		
C101 .	CONTACT RING	top of steering column	36-3	
D100 .	DATA LINK CONNECTOR	rear RH side of engine compartment (M VERSIONS)	31-1	
D100 .	DATA LINK CONNECTOR	rear LH side of engine compartment (Z3 VERSIONS)	39-3	
D110 .	OBD II CONNECTOR	center console right	28-3	
E7	LEFT HEADLIGHT	front LH side of engine compartment		
E8	RIGHT HEADLIGHT	front RH side of engine compartment		
E9	REAR DEFOGGER I	hard top		
E11 . . .	LEFT HIGH BEAM LIGHT	near front LH headlight	29-1	
E12 . .	RIGHT HIGH BEAM LIGHT	near front RH headlight		

03/00

7000.0-3

1999



COMPONENT LOCATION CHART

Z3

COMP.	DESCRIPTION	LOCATION	7100.0	8500.0
E13	LEFT LOW BEAM LIGHT	near front LH headlight	29-1	
E14	RIGHT LOW BEAM LIGHT	near front RH headlight	29-3	
E15	LEFT PARK LIGHT	near front LH headlight		
E16	LEFT REAR LIGHT ASSEMBLY	LH side of body rear end		
E17	RIGHT REAR LIGHT ASSEMBLY	RH side of body rear end	01-1	
E19	RIGHT PARK LIGHT	near front RH headlight		
E21	LEFT FRONT MARKER LIGHT	front of vehicle		
E22	RIGHT FRONT MARKER LIGHT	front of vehicle		
E25	FRONT ASHTRAY LIGHT	center console		
E26	LEFT FOG LIGHT	under LH front bumper		
E27	RIGHT FOG LIGHT	under RH front bumper	13-2	
E28	FRONT CIGAR LIGHTER	center console		
E28a	CIGAR LIGHTER CONNECTION	TIRE INFLATION SYSTEM		
E29	FRONT CIGAR LIGHTER LIGHT	center console	22-3	
E32	LUGGAGE COMPARTMENT LIGHT	in luggage compartment (ROADSTER)		
E32	LUGGAGE COMPARTMENT LIGHT	in roof panel (COUPE)		
E34	FRONT DOME LIGHT/MAP READING ASSEMBLY	in roof panel		
E43	LEFT LICENSE PLATE LIGHT	underside of luggage compartment lid, near license plate		
E44	RIGHT LICENSE PLATE LIGHT	underside of luggage compartment lid, near license plate		
E51	LEFT WASHER JET HEATER	on underside of engine hood	37-1	
E52	RIGHT WASHER JET HEATER	on underside of engine hood	37-1	

03/00

7000.0-4

1999



COMPONENT LOCATION CHART

Z3

COMP.	DESCRIPTION	LOCATION	7100.0	8500.0
E56	DRIVER'S SEATBACK HEATER	in top of LH backrest		
E57	DRIVER'S SEAT HEATER	under LH front seat		
E58	PASSENGER'S SEAT HEATER	underside of RH front seat		
E59	PASSENGER'S SEATBACK HEATER	in top of RH backrest		
E82	TRANSMISSION POSITION INDICATOR LIGHT	center console	22-1	
E96	GEAR SHIFT LEVER INDICATOR	center console		
E99	HARD TOP CONNECTOR 1	near LH rear wheel well		
E105	HEAT/A/C CONTROL PANEL ILLUMINATION	center of dash	21-3	
E106	HEAT/A/C CONTROL PANEL ILLUMINATION	center of dash	21-3	
E800	FRONT LEFT INTERIOR LIGHT	near interior rear view mirror		
F97	FUSIBLE LINK	in RH side of luggage compartment	01-1	
G1	BATTERY	in RH side of luggage compartment	01-1	
G5	DRIVER'S AIR BAG GAS GENERATOR	behind steering wheel		
G6	PASSENGER'S AIR BAG GAS GENERATOR	behind glove box above		
G12	DRIVER'S SIDE PYROTECHNICAL BELT TENSIONER	in LH front seat belt buckle	36-2	
G13	PASSENGER'S SIDE PYROTECHNICAL BELT TENSIONER	in RH front seat belt buckle	36-2	
G14	LEFT SIDE AIR BAG GAS GENERATOR	LH front door	16-2	
G15	RIGHT SIDE AIR BAG GAS GENERATOR	RH front door	35-2	

03/00

7000.0-5

1999



COMPONENT LOCATION CHART

Z3

COMP.	DESCRIPTION	LOCATION	7100.0	8500.0
G6400	B+ JUNCTION POINT E-BOX	rear RH side of engine compartment in E-Box	41-2	
G6430	B+ JUMP START JUNCTION POINT	rear RH side of engine compartment	01-2	
G6509	GENERATOR	front LH side of engine compartment	02-3	
G7512	B+ JUNCTION POINT	below LH side of dash		
H1w ..	ANTI-THEFT HORN (ALPINE)	rear LH side of engine compartment	09-1	
H2 ...	LEFT HORN	under LH front bumper		
H3 ...	RIGHT HORN	RH front of wheel well	13-2	
H4 ...	RIGHT FRONT TURN LIGHT	front of vehicle		
H7 ...	LEFT FRONT TURN LIGHT	front of vehicle		
H8 ...	RIGHT FRONT AUXILIARY TURN LIGHT .	front of vehicle		
H9 ...	LEFT FRONT AUXILIARY TURN LIGHT ..	front of vehicle		
H10 ..	CHIME MODULE	below LH side of dash		
H34 ..	HIGH LEVEL STOP LIGHT	on lift gate (ROADSTER)	45-1	
H34 ..	HIGH LEVEL STOP LIGHT	on lift gate (COUPE)		
H45 ..	RIGHT REAR SPEAKER	in roof panel		
H46 ..	LEFT REAR SPEAKER	in roof panel		
H50 ..	RIGHT FRONT HIGH RANGE SPEAKER .	in upper RH front door		
H51 ..	RIGHT FRONT LOW RANGE SPEAKER .	in lower RH A-pillar		
H52 ..	RIGHT REAR LOW RANGE SPEAKER ...	in rear speaker box		
H53 ..	RIGHT REAR HIGH RANGE SPEAKER ..	in roof panel		
H54 ..	RIGHT FRONT MIDRANGE SPEAKER ...	in upper RH front door		

03/00

7000.0-6

1999



COMPONENT LOCATION CHART

Z3

COMP.	DESCRIPTION	LOCATION	7100.0	8500.0
H54z	REAR RIGHT MID-HIGH RANGE SPEAKER	in rear speaker box (ROADSTER)	07-3	
H54z	REAR RIGHT MID-HIGH RANGE SPEAKER	in roof panel (COUPE)		
H55	LEFT FRONT MIDRANGE SPEAKER	in upper LH front door		
H55z	REAR LEFT MID-HIGH RANGE SPEAKER	in rear speaker box (ROADSTER)	10-1	
H55z	REAR LEFT MID-HIGH RANGE SPEAKER	in roof panel (COUPE)		
H56	LEFT REAR HIGH RANGE SPEAKER	in roof panel		
H57	LEFT REAR LOW RANGE SPEAKER	in rear speaker box		
H58	LEFT FRONT LOW RANGE SPEAKER	in lower LH A-pillar		
H59	LEFT FRONT HIGH RANGE SPEAKER	in upper LH front door		
H500	REAR WOOFER	in rear speaker box (COUPE)	46-1	
H500	REAR WOOFER	in rear speaker box (ROADSTER)		
I1008	SEAT MAT	in passenger's seat area		
K2	HORN RELAY	rear LH side of engine compartment in Power Distribution Box	09-2	
K4	BLOWER RELAY	rear LH side of engine compartment in Power Distribution Box	09-2	
K9	UNLOADER RELAY, TERMINAL 15	rear LH side of engine compartment in Power Distribution Box	09-3	
K16	HAZARD FLASHER RELAY	rear LH side of engine compartment in Power Distribution Box	09-2	
K19	COMPRESSOR CONTROL RELAY	rear LH side of engine compartment in Power Distribution Box	09-3	
K21	NORMAL SPEED RELAY	rear LH side of engine compartment in Power Distribution Box	09-3	
K22	HIGH SPEED RELAY	rear LH side of engine compartment in Power Distribution Box	09-3	
K33a	AIR CONDITIONING RELAY, MOTRONIC	rear LH side of engine compartment in Power Distribution Box	09-2	

03/00

7000.0-7

1999



COMPONENT LOCATION CHART

Z3

COMP.	DESCRIPTION	LOCATION	7100.0	8500.0
K46	.. HIGH BEAM LIGHT RELAY	footwell, driver's side (USA)	19-1	
K46z	.. DAY LIGHT RELAY MODULE	footwell, driver's side (CANADA)		
K47	.. FRONT FOG LIGHT RELAY	rear LH side of engine compartment in Power Distribution Box	09-2	
K48	.. LOW BEAM LIGHT RELAY	rear LH side of engine compartment in Power Distribution Box	09-2	
K70	.. CENTRAL LOCKING LUGGAGE COMPARTMENT LID MOTOR RELAY (ZV)	rear LH side of engine compartment in Power Distribution Box	08-2	
K94	.. ENGINE CONTROL RELAY (ABS/ASC) ..	rear LH side of engine compartment in Power Distribution Box	09-3	
K95	.. VALVE RELAY (ABS/ASC)	rear LH side of engine compartment in Power Distribution Box	09-3	
K910	.. PASSENGER'S SEAT TILT ADJUST CUT- OFF RELAY	underside of RH front seat	11-1	
K911	.. PASSENGER'S SEAT LENGTH ADJUST CUT-OFF RELAY	underside of RH front seat	11-1	
K920	.. DRIVER'S SEAT TILT ADJUST CUT-OFF RELAY	underside of LH front seat	10-2	
K921	.. DRIVER'S SEAT LENGTH ADJUST CUT- OFF RELAY	underside of LH front seat	10-2	
K6300	ENGINE CONTROL MODULE RELAY	rear RH side of engine compartment in E-Box (M VERSIONS)	00-1	
K6300	ENGINE CONTROL MODULE RELAY	rear RH side of engine compartment in E-Box (Z3 VERSIONS)	41-1	
K6304	SECONDARY AIR PUMP RELAY	rear RH side of engine compartment in E-Box (M VERSIONS)	00-1	
K6304	SECONDARY AIR PUMP RELAY	rear RH side of engine compartment in E-Box (Z3 VERSIONS)	41-1	
K6326	UNLOADER RELAY, TERMINAL 15	rear RH side of engine compartment in E-Box (M VERSIONS)	00-1	
K6326	UNLOADER RELAY, TERMINAL 15	rear RH side of engine compartment in E-Box (Z3 VERSIONS)	41-1	
K6301w	FUEL PUMP RELAY	below LH side of dash	19-1	

03/00

7000.0-8

1999



COMPONENT LOCATION CHART

Z3

COMP.	DESCRIPTION	LOCATION	7100.0	8500.0
K6394	COMPRESSOR RELAY	TIRE INFLATION SYSTEM		
K18363	CONVERTIBLE TOP RELAY I (CLOSE) ...	in LH side of luggage compartment	25-3	
K18364	CONVERTIBLE TOP RELAY II (OPEN) ...	in LH side of luggage compartment	25-3	
L1	EWS TOROIDAL COIL	at ignition switch		
M2 ...	FUEL PUMP	in fuel tank		
M3 ...	WIPER MOTOR	rear of engine compartment	45-3	
M4 ...	WASHER PUMP	front RH side of engine compartment on washer fluid reservoir		
M7 ...	HEADLIGHT/FOG LIGHT WASHER PUMP	front RH side of engine compartment on washer fluid reservoir		
M9 ...	AUXILIARY FAN MOTOR	behind front grille		
M12 ..	DRIVER'S DOOR LOCK MOTOR	driver's door		
M13 ..	PASSENGER'S DOOR LOCK MOTOR ...	passenger's door		
M17 ..	LUGGAGE COMPARTMENT LOCK MOTOR	rear side of luggage compartment behind trim panel (ROADSTER)		
M17 ..	LUGGAGE COMPARTMENT LOCK MOTOR	in lift gate (Z3 COUPE)	37-2	
M17 ..	LUGGAGE COMPARTMENT LOCK MOTOR	in lift gate (M COUPE)	46-3	
M21 ..	DRIVER'S WINDOW MOTOR	in driver's door	17-2	
M23 ..	PASSENGER'S WINDOW MOTOR	in passenger's door	18-3	
M24y .	TILT SUNROOF MOTOR	in roof panel		
M25 ..	CRUISE CONTROL ACTUATOR (TEMPOMAT)	rear LH side of engine compartment	08-3	
M30 ..	BLOWER MOTOR	rear of engine compartment		

03/00

7000.0-9

1999



COMPONENT LOCATION CHART

Z3

COMP.	DESCRIPTION	LOCATION	7100.0	8500.0
M51 ..	DRIVER'S SEAT MOVEMENT MOTOR ...	under LH front seat	25-1	
M51 ..	DRIVER'S SEAT MOVEMENT MOTOR ...	under LH front seat (WITH SPORT SEAT)	10-3	
M52 ..	DRIVER'S SEAT HEIGHT MOTOR	under LH front seat	25-1	
M52 ..	DRIVER'S SEAT HEIGHT MOTOR	under LH front seat (WITH SPORT SEAT)	10-3	
M59 ..	PASSENGER'S SEAT HEIGHT MOTOR ..	under RH front seat	24-1	
M60 ..	PASSENGER'S SEAT MOVEMENT MOTOR	under RH front seat	24-1	
M93 ..	AUXILIARY THROTTLE POSITION MOTOR (ADS)	front of engine	08-1	
M101 .	CONVERTIBLE TOP MOTOR	in LH side of luggage compartment	25-3	
M111 .	FRESH AIR RECIRCULATION MOTOR ...	RH side of LH footwell	21-2	
M805 .	ELECTRICAL COMPRESSOR	TIRE INFLATION SYSTEM		
M6506	E-BOX FAN	in E-Box		
M6510	STARTER	rear LH side of engine compartment	02-2	
N5 ...	ANALOG CLOCK	center console		
N8 ...	ANTENNA AMPLIFIER AM/FM	in LH side of luggage compartment behind trim panel (ROADSTER)		
N8 ...	ANTENNA AMPLIFIER AM/FM	in roof panel (COUPE)	37-3	
N9 ...	RADIO	center console		
N12w .	ANTI-THEFT CONTROL MODULE (ALPINE)	behind glove box		
N17 ..	CRASH CONTROL MODULE	footwell, driver's side	19-1	
N22 ..	CD CHANGER	in RH side of luggage compartment		
P90 ..	FRONT POWER DISTRIBUTION BOX ...	rear LH side of engine compartment		

03/00

7000.0-10

1999



COMPONENT LOCATION CHART

Z3

COMP.	DESCRIPTION	LOCATION	7100.0	8500.0
P95 ..	AUXILIARY FUSE BOX	below LH side of dash		
P97 ..	AUXILIARY FUSE BOX	below LH side of dash	19-1	
P98 ..	FUSE HOLDER IN E-BOX	rear RH side of engine compartment in E-Box	40-3	
P99 ..	FUSE HOLDER	in RH side of luggage compartment		
R11 ...	BLOWER RESISTORS	rear of engine compartment behind firewall		
R31 ..	AUXILIARY THROTTLE POSITION SENSOR	front of engine	33-3	
R6252	THROTTLE POSITION SENSOR	front of engine	33-3	
R6385	THROTTLE POSITION SENSOR/CRUISE CONTROL ACTUATOR	top LH side of engine	39-2	
R8554	RESISTOR	on cylinder head		
S2	IGNITION SWITCH	LH side of dash		
S3	AUTOMATIC TRANSMISSION RANGE SWITCH	center console	22-1	
S4	HORN SWITCH	on steering wheel		
S5	WIPER/WASHER SWITCH	LH side of dash RH side of steering column above		
S6	ASC SWITCH	center console		
S7	COMBINATION SWITCH	LH side of dash LH side of steering column above		
S8	LIGHT SWITCH	LH side of dash		
S10 ..	FOG LIGHT SWITCH	LH side of dash		
S13 ..	PASSENGER'S DOOR JAMB SWITCH ...	RH B-pillar	26-1	
S14 ..	DRIVER'S DOOR JAMB SWITCH	LH B-pillar	27-1	
S17 ..	MIRROR CONTROL SWITCH	in upper LH front door		

03/00

7000.0-1-1

1999



COMPONENT LOCATION CHART

Z3

COMP.	DESCRIPTION	LOCATION	7100.0	8500.0
S18	HAZARD SWITCH	center console bottom		
S20w	RADIO ANTI-THEFT SWITCH	center console (radio and console removed)	36-1	
S21w	ENGINE HOOD SWITCH	near LH headlight assembly	29-1	
S28	CRUISE CONTROL SWITCH	LH side of dash RH side of steering column above		
S30	BRAKE LIGHT SWITCH	LH footwell	20-1	
S31	PARK BRAKE SWITCH	center console on rear of park brake lever		
S32	CLUTCH SWITCH	LH footwell	20-1	
S36	TEMPERATURE SWITCH	front RH side of engine compartment	30-1	
S38y	TILT SUNROOF SWITCH	in roof panel		
S47	DRIVER'S DOOR LOCK SWITCH	in driver's door	17-1	
S49	PASSENGER'S DOOR LOCK SWITCH	in passenger's door		
S51	DRIVER'S SEAT, SEAT CONTROL SWITCH	LH front seat		
S53	DRIVER'S SEAT, SEAT HEATER SWITCH	center console	23-1	
S54	PASSENGER'S SEAT, SEAT HEATER SWITCH	center console	23-1	
S56	PASSENGER'S SEAT, SEAT CONTROL SWITCH	RH front seat		
S58	DRIVER'S SEAT BELT SWITCH	in LH front seat belt buckle		
S59	PASSENGER'S SEAT BELT SWITCH	in RH front seat belt buckle		
S75	BLOWER SWITCH	center of dash	21-3	
S76	REAR WINDOW DEFOGGER SWITCH	center console		

03/00

7000.0-12

1999



COMPONENT LOCATION CHART

Z3

COMP.	DESCRIPTION	LOCATION	7100.0	8500.0
S117	LUGGAGE COMPARTMENT LID LOCKING SWITCH	in lift gate		
S126y	DRIVER'S POWER WINDOW SWITCH	center console near gearshift lever		
S127y	PASSENGER'S POWER WINDOW SWITCH	center console near gearshift lever		
S143	CONVERTIBLE TOP ACTUATING SWITCH	center console		
S164	CONVERTIBLE TOP END-POSITION MICRO SWITCH	at convertible top linkage	17-3	
S198	JET HEATER THERMOSWITCH	on front RH wheel well		
S220	AIR CONDITIONING/RECIRCULATING SWITCH ASSEMBLY	center console	00-3	
S221	EVAPORATOR CONTROLLER	RH side of LH footwell	21-2	
S232	COMPRESSOR MAIN SWITCH	TIRE INFLATION SYSTEM		
S235	STARTER IMMOBILIZATION SWITCH	LH footwell	20-1	
S408	INTERIOR LIGHT SWITCH	near interior rear view mirror	28-2	
S531	TEMPERATURE WHEEL SWITCH	center of dash	21-3	
S559	PASSENGER'S AIR BAG CUT-OFF SWITCH	center console		
S826	LUGGAGE COMPARTMENT LIGHT SWITCH	underside of luggage compartment lid		
S910	DRIVER'S SEAT LIMIT SWITCH	in driver's seatback	45-2	
S911	PASSENGER'S SEAT LIMIT SWITCH	in passenger's seatback	45-2	
S8503	PROGRAM SWITCH	center console	22-1	
S8507	KICK-DOWN SWITCH	behind gas pedal	19-3	

03/00

7000.0-13

1999



COMPONENT LOCATION CHART

Z3

COMP.	DESCRIPTION	LOCATION	7100.0	8500.0
S8511	REVERSING LIGHT SWITCH	LH side of transmission	14-2	
T6151	CYL. 1 IGNITION COIL	RH side of engine compartment		
T6152	CYL. 2 IGNITION COIL	RH side of engine compartment		
T6153	CYL. 3 IGNITION COIL	RH side of engine compartment		
T6154	CYL. 4 IGNITION COIL	RH side of engine compartment		
T6155	CYL. 5 IGNITION COIL	RH side of engine compartment		
T6156	CYL. 6 IGNITION COIL	RH side of engine compartment		
X0	B+ JUNCTION POINT	rear LH side of engine compartment in Power Distribution Box	02-1	
X2	BATTERY B+ START POINT	rear LH side of engine compartment in Power Distribution Box (M VERSIONS)		
X2	BATTERY B+ START POINT	in RH side of luggage compartment (Z3 VERSIONS)		
X4	GROUND	LH side of engine compartment		
X8	CABLE SOCKET B+	in RH side of luggage compartment		
X9	CABLE SOCKET B+	below LH side of dash		
X16 ..	(26 PINS, NATURAL)	LH side of dash rear side of instrument cluster, A2w	20-2	00-3
X17 ..	(26 PINS, BLUE)	LH side of dash rear side of instrument cluster, A2w	20-2	00-3
X20 ..	(25 PINS, BLACK)	rear LH side of engine compartment	08-1	04-4
X22 ..	(26 PINS, BLUE)	behind glove box	00-2	00-3
X29 ..	(1 PIN, —)	LH side of steering column		
X32 ..	(12 PINS, NATURAL)	on steering column	19-2	02-4
X33 ..	(12 PINS, BLACK)	on steering column	19-2	02-4
X35 ..	(4 PINS, BLACK)	RH side of LH footwell	21-1	03-1
X44 ..	(9 PINS, BLACK)	Power Distribution Box rear LH side of engine compartment		03-4

03/00

7000.0-14

1999



COMPONENT LOCATION CHART

Z3

COMP.	DESCRIPTION	LOCATION	7100.0	8500.0
X45	.. (9 PINS, BLACK)	Power Distribution Box rear LH side of engine compartment		03-4
X50	.. (9 PINS, BLACK)	Power Distribution Box, rear LH side of engine compartment		03-4
X51	.. (9 PINS, BLACK)	Power Distribution Box rear LH side of engine compartment		03-4
X52	.. (9 PINS, BLACK)	Power Distribution Box rear LH side of engine compartment		03-4
X53	.. (9 PINS, BLACK)	Power Distribution Box rear LH side of engine compartment		03-4
X56	.. (9 PINS, BLACK)	Power Distribution Box rear LH side of engine compartment		03-4
X58	.. (9 PINS, BLACK)	Power Distribution Box rear LH side of engine compartment		03-4
X63	.. (9 PINS, BLACK)	Power Distribution Box rear LH side of engine compartment		03-4
X64	.. (9 PINS, BLACK)	Power Distribution Box rear LH side of engine compartment		03-4
X65	.. (9 PINS, BLACK)	below LH side of dash		03-4
X70	.. (8 PINS, BLACK)	rear LH side of engine compartment	08-3	06-2
X72	.. (6 PINS, NATURAL)	on steering column	19-2	05-3
X74	.. (50 PINS, NATURAL)	below center console	22-2	11-2
X78	.. (4 PINS, BLACK)	on steering column	20-1	03-1
X82	.. (3 PINS, BLACK)	under radiator	13-1	05-5
X85	.. (3 PINS, BLACK)	rear LH side of engine compartment	14-3	05-5
X87	.. (3 PINS, BLACK)	RH top of radiator	30-1	02-5
X105	.. (2 PINS, GRAY)	on underside of engine hood	37-1	
X106	.. (2 PINS, GRAY)	on underside of engine hood	37-1	
X107	.. (2 PINS, BLACK)	front RH side of engine compartment on washer fluid reservoir		
X111	.. (2 PINS, BLACK)	rear LH side of engine compartment	09-1	
X113	.. (3 PINS, GRAY)	behind RH front wheel	13-3	06-3

03/00

7000.0-15

1999



COMPONENT LOCATION CHART

Z3

COMP.	DESCRIPTION	LOCATION	7100.0	8500.0
X114	(3 PINS, GRAY)	behind LH front wheel	12-2	06-3
X118	(2 PINS, BLACK)	behind LH front wheel	12-2	
X121	(2 PINS, WHITE)	LH footwell	20-1	
X123	(2 PINS, GRAY)	front RH side of engine compartment on washer fluid reservoir		
X127	(4 PINS, BLACK)	front RH side of engine compartment	30-2	05-4
X128	(3 PINS, BLACK)	front LH side of engine compartment		02-5
X130	(2 PINS, GRAY)	near front LH headlight	29-2	
X131	(2 PINS, BLACK)	near front LH headlight	29-2	
X132	(2 PINS, BLACK)	on front LH wheel well		
X133	(2 PINS, BLACK)	on front RH wheel well	13-2	
X134	(2 PINS, BLACK)	near front RH headlight	29-3	
X135	(2 PINS, GRAY)	near front RH headlight	29-3	
X137	(3 PINS, BLACK)	front RH side of engine compartment	30-3	02-5
X142	(2 PINS, GRAY)	under LH rear of car	16-1	
X143	(2 PINS, GRAY)	under RH rear of car	15-3	
X163	(3 PINS, BLACK)	front RH side of engine compartment on washer fluid reservoir near RH headlight assembly	30-2	05-5
X165	GROUND	front RH side of engine compartment	04-2	
X166	GROUND	front LH side of engine compartment	05-1	
X170	GROUND	behind LH footwell speaker grille	03-2	
X256	(26 PINS, BLACK)	RH A-pillar	18-1	03-5
X257	(26 PINS, BLACK)	LH A-pillar	16-3	03-5

03/00

7000.0-16

1999



COMPONENT LOCATION CHART

Z3

COMP.	DESCRIPTION	LOCATION	7100.0	8500.0
X271	(12 PINS, BLACK)	LH side of dash rear side of instrument cluster, A2w	20-2	01-3
X275	(4 PINS, NATURAL)	under LH front seat	25-2	03-1
X275	(4 PINS, NATURAL)	under LH front seat (WITH SPORT SEAT)	10-3	03-1
X279	(4 PINS, NATURAL)	under RH front seat	24-2	03-1
X279	(4 PINS, NATURAL)	under RH front seat (WITH SPORT SEAT)	11-2	03-1
X285	(15 PINS, BLUE)	behind glove box	38-2	05-1
X295	(8 PINS, BLACK)	on steering column	19-2	03-3
X311	(3 PINS, BLACK)	in luggage compartment lid (ROADSTER)	28-1	01-1
X311	(3 PINS, BLACK)	in lift gate (COUPE)	37-2	01-1
X315	(2 PINS, BLACK)	in luggage compartment lid (ROADSTER)	28-1	
X315	(2 PINS, BLACK)	in lift gate (COUPE)	37-2	
X316	(4 PINS, VIOLET)	center console near gearshift lever		07-1
X318	(8 PINS, BLACK)	in RH rear side of luggage compartment behind RH rear light assembly	01-1	02-1
X319	(8 PINS, BLACK)	in LH side of luggage compartment behind trim panel		02-1
X322	(6 PINS, BLACK)	footwell, driver's side	19-1	03-6
X324	(4 PINS, VIOLET)	center console near gearshift lever		07-1
X333	(4 PINS, NATURAL)	rear of engine compartment below center of cowl	45-3	03-1
X336	(3 PINS, BLACK)	in upper RH A-pillar		01-1
X351	(3 PINS, BLACK)	RH B-pillar	26-1	01-1
X352	(3 PINS, BLACK)	LH B-pillar	27-1	01-1
X357	(2 PINS, WHITE)	near interior rear view mirror	28-2	
X371	(3 PINS, BLACK)	near front LH headlight	29-1	02-5

03/00

7000.0-17

1999



COMPONENT LOCATION CHART

Z3

COMP.	DESCRIPTION	LOCATION	7100.0	8500.0
X372	(2 PINS, GRAY)	rear LH side of engine compartment	09-1	
X379	(1 PIN, NATURAL)	HARD TOP CONNECTOR 1		
X380	(1 PIN, NATURAL)	HARD TOP CONNECTOR 1		
X383	(2 PINS, BLACK)	on differential	15-2	
X389	(2 PINS, BLACK)	LEFT FRONT AUXILIARY TURN LIGHT		
X390	(2 PINS, BLACK)	RIGHT FRONT AUXILIARY TURN LIGHT		
X400	(8 PINS, BLACK)	center console		02-1
X413	(3 PINS, BLACK)	HIGH LEVEL STOP LIGHT (ROADSTER)	45-1	01-1
X413	(3 PINS, BLACK)	HIGH LEVEL STOP LIGHT (COUPE)		01-1
X423	(1 PIN, —)	below center console on rear of park brake lever		
X424	(1 PIN, —)	in LH side of luggage compartment behind trim panel (ROADSTER)		
X424	(1 PIN, —)	in roof panel (COUPE)	37-3	
X494	GROUND	below center console	03-1	
X503	(12 PINS, BLACK)	LH side of dash	20-3	07-2
X504	(4 PINS, NATURAL)	LH side of dash	20-3	03-1
X511	(8 PINS, BLACK)	center console	22-1	02-1
X516	(5 PINS, BLACK)	center console		02-6
X521	(6 PINS, BLUE)	center console		04-5
X522	(3 PINS, NATURAL)	RH side of LH footwell		04-3
X531	(1 PIN, NATURAL)	center console	22-3	
X532	(2 PINS, BLACK)	center console	22-3	
X537	(3 PINS, BLACK)	REAR LEFT MID-HIGH RANGE SPEAKER (ROADSTER)	10-1	01-1

03/00

7000.0-18

1999



COMPONENT LOCATION CHART

Z3

COMP.	DESCRIPTION	LOCATION	7100.0	8500.0
X537	(3 PINS, BLACK)	in roof panel REAR LEFT MID-HIGH RANGE SPEAKER (COUPE)		01-1
X538	(3 PINS, BLACK)	REAR RIGHT MID-HIGH RANGE SPEAKER (ROADSTER)	07-3	01-1
X538	(3 PINS, BLACK)	in roof panel REAR RIGHT MID-HIGH RANGE SPEAKER (COUPE)		01-1
X539	(2 PINS, BLACK)	center console (radio and console removed)	36-1	
X605	(12 PINS, BLACK)	in RH forward side of luggage compartment (ROADSTER)	27-3	01-5
X605	(12 PINS, BLACK)	in RH forward side of luggage compartment (COUPE)	46-1	01-5
X606	(26 PINS, BLACK)	in RH forward side of luggage compartment (ROADSTER)	27-3	00-3
X606	(26 PINS, BLACK)	in RH forward side of luggage compartment (COUPE)	46-1	00-3
X623	(4 PINS, BLACK)	in driver's door	17-2	07-1
X624	(4 PINS, BLACK)	in passenger's door	18-3	07-1
X625	(6 PINS, BLACK)	in driver's door	17-2	08-2
X641	(6 PINS, BLACK)	in passenger's door	18-2	07-4
X643	(6 PINS, WHITE)	in roof panel		04-6
X651	(6 PINS, VIOLET)	center console	23-1	04-5
X658	(6 PINS, VIOLET)	center console	23-1	04-5
X660	(6 PINS, BLACK)	LH front door behind door panel		07-4
X693	(1 PIN, NATURAL)	TIRE INFLATION SYSTEM		
X700	(1 PIN, —)	behind RH footwell speaker grille	23-3	
X701	(1 PIN, —)	behind LH footwell speaker grille		
X709	(2 PINS, BLACK)	underside of luggage compartment lid, near license plate		
X710	(2 PINS, BLACK)	underside of luggage compartment lid, near license plate		
X711	(2 PINS, BLACK)	in luggage compartment lid	28-1	

03/00

7000.0-19

1999



COMPONENT LOCATION CHART

Z3

COMP.	DESCRIPTION	LOCATION	7100.0	8500.0
X712	(1 PIN, BLACK)	in luggage compartment (ROADSTER)		
X712	(4 PINS, NATURAL)	in roof panel (COUPE)	37-3	
X713	(2 PINS, BLACK)	under RH rear of car	15-3	
X726	(2 PINS, NATURAL)	under LH front seat	25-1	
X726	(2 PINS, NATURAL)	under LH front seat (WITH SPORT SEAT)	10-3	
X728	(2 PINS, BLACK)	under LH front seat	25-1	
X728	(2 PINS, BLACK)	under LH front seat (WITH SPORT SEAT)	10-3	
X733	(4 PINS, BLACK)	under LH front seat	25-2	03-1
X733	(4 PINS, BLACK)	under LH front seat (WITH SPORT SEAT)	10-3	03-1
X734	(2 PINS, NATURAL)	under RH front seat	24-1	
X734	(2 PINS, NATURAL)	under RH front seat (WITH SPORT SEAT)	11-1	
X737	(2 PINS, BLACK)	under RH front seat	24-1	
X737	(2 PINS, BLACK)	under RH front seat (WITH SPORT SEAT)	11-2	
X740	(4 PINS, BLACK)	under RH front seat	24-2	03-1
X740	(4 PINS, BLACK)	under RH front seat (WITH SPORT SEAT)	11-2	
X742	(2 PINS, YELLOW)	in passenger's door		
X744	(4 PINS, GRAY)	in passenger's door	18-3	05-4
X746	(3 PINS, YELLOW)	in passenger's door	18-3	10-5
X747	(2 PINS, YELLOW)	in driver's door	17-1	
X749	(2 PINS, GRAY)	in driver's door	17-2	
X753	(3 PINS, YELLOW)	in driver's door	17-2	10-5
X760	(3 PINS, BLACK)	RIGHT REAR HIGH RANGE SPEAKER		01-1

03/00

7000.0-20

1999



COMPONENT LOCATION CHART

Z3

COMP.	DESCRIPTION	LOCATION	7100.0	8500.0
X761	(1 PIN, BLACK)	RIGHT REAR SPEAKER		
X762	(3 PINS, BLACK)	LEFT REAR HIGH RANGE SPEAKER		01-1
X763	(1 PIN, BLACK)	LEFT REAR SPEAKER		
X766	(2 PINS, BLACK)	LH front of vehicle		
X767	(2 PINS, BLACK)	RH front of vehicle		
X768	(2 PINS, BLACK)	on front LH wheel well		
X769	(2 PINS, BLACK)	RH front of wheel well	13-2	
X770	(2 PINS, YELLOW)	in RH front bumper	11-3	
X771	(2 PINS, NATURAL)	RH side of LH footwell	21-2	
X778	(4 PINS, BLACK)	under LH front seat		07-1
X778	(4 PINS, BLACK)	under LH front seat (WITH SPORT SEAT)	10-2	07-1
X782	(3 PINS, ORANGE)	behind glove box above	00-2	07-5
X783	(3 PINS, ORANGE)	underside of steering column	36-3	07-5
X898	(8 PINS, BLACK)	under rear storage compartment (ROADSTER)	26-2	08-3
X898	(4 PINS, NATURAL)	center console (M COUPE)		07-1
X898	(8 PINS, BLACK)	center console (Z3 COUPE)		08-3
X904	(4 PINS, BLACK)	RH side of LH footwell		03-1
X905	(7 PINS, BLACK)	center of dash	21-3	09-3
X1014	(1 PIN, BLACK)	center console	22-3	
X1098	(3 PINS, BLACK)	LH side of dash	20-3	01-1
X1116	GROUND	in LH side of luggage compartment	06-3	
X1148	(2 PINS, BLACK)	on front RH wheel well		

03/00

7000.0-21

1999



COMPONENT LOCATION CHART

Z3

COMP.	DESCRIPTION	LOCATION	7100.0	8500.0
X1155	(2 PINS, BLACK)	center console		
X1166	GROUND	behind glove box	04-1	
X1170	(25 PINS, GRAY)	front LH side of engine compartment	39-3	09-4
X1175	(83 PINS, NATURAL)	behind glove box	00-2	08-4
X1178	(2 PINS, WHITE)	center console	27-2	
X1193	(3 PINS, BLACK)	center console	22-1	01-1
X1213	(2 PINS, BLACK)	center console		
X1255	(4 PINS, BLACK)	TIRE INFLATION SYSTEM		03-1
X1265	(1 PIN, NATURAL)	HARD TOP CONNECTOR 1		
X1266	(1 PIN, NATURAL)	HARD TOP CONNECTOR 1		
X1376	(9 PINS, BLACK)	front Power Distribution Box rear LH side of engine compartment		03-4
X1380	(1 PIN, —)	behind RH footwell speaker grille	23-3	
X1381	(1 PIN, —)	behind LH footwell speaker grille		
X1439	(2 PINS, BLACK)	center console		
X1441	GROUND	below center console	03-3	
X1517	(6 PINS, BLACK)	RH side of LH footwell	21-2	09-2
X1588	(2 PINS, BLACK)	below LH side of dash	19-1	
X1715	(4 PINS, NATURAL)	in rear left speaker box (ROADSTER)	26-3	03-1
X1715	(4 PINS, NATURAL)	in RH forward side of luggage compartment (COUPE)	46-1	03-1
X1764	(3 PINS, BLACK)	RH side of steering column	38-3	01-1
X1775	(3 PINS, NATURAL)	in lift gate		10-5
X1805	(15 PINS, NATURAL)	LH side of steering column	38-3	05-1

03/00

7000.0-22

1999



COMPONENT LOCATION CHART

Z3

COMP.	DESCRIPTION	LOCATION	7100.0	8500.0
X1883	(2 PINS, YELLOW)	LH front door	16-2	
X1884	(2 PINS, YELLOW)	RH front door	35-2	
X1885	(3 PINS, BLACK)	under LH front seat	35-3	10-1
X1886	(3 PINS, BLACK)	under RH front seat	35-1	10-1
X1976	CABLE SOCKET B+	below LH side of dash		
X1977	CABLE SOCKET B+	below LH side of dash		
X1978	CABLE SOCKET B+	below LH side of dash		
X1979	CABLE SOCKET B+	below LH side of dash		
X1980	CABLE SOCKET B+	below LH side of dash		
X1981	CABLE SOCKET B+	below LH side of dash		
X1982	CABLE SOCKET B+	below LH side of dash		
X2213	(15 PINS, NATURAL)	LH side of engine compartment	08-1	05-1
X2227	(4 PINS, BLUE)	center console		07-1
X3040	(2 PINS, BLACK)	TIRE INFLATION SYSTEM		
X3158	(1 PIN, NATURAL)	TIRE INFLATION SYSTEM		
X5115	(2 PINS, BLACK)	center console (radio and console removed)	36-1	
X6000	(88 PINS, NATURAL)	rear RH side of engine compartment in E-Box	00-1	00-1
X6002	(20 PINS, BLACK)	rear RH side of engine compartment (M VERSIONS)		04-1
X6002	(20 PINS, BLACK)	rear LH side of engine compartment (Z3 VERSIONS)		04-1
X6011	(2 PINS, BLUE)	rear RH side of engine compartment in E-Box	40-3	
X6021	(4 PINS, BLACK)	rear RH side of engine compartment in E-Box	40-3	03-1
X6031	(12 PINS, BLACK)	rear LH side of engine compartment (M VERSIONS)	08-1	01-6

03/00

7000.0-23

1999



COMPONENT LOCATION CHART

Z3

COMP.	DESCRIPTION	LOCATION	7100.0	8500.0
X6031	(18 PINS, BLACK)	rear RH side of engine compartment in E-Box (Z3 VERSIONS)	40-3	07-3
X6053	(4 PINS, NATURAL)	rear RH side of engine compartment in E-Box	41-2	03-1
X6054	(2 PINS, NATURAL)	rear RH side of engine compartment in E-Box	41-1	
X6101	(2 PINS, BLACK)	top center of engine		
X6102	(2 PINS, BLACK)	top center of engine		
X6103	(2 PINS, BLACK)	top center of engine		
X6104	(2 PINS, BLACK)	top center of engine		
X6105	(2 PINS, BLACK)	top center of engine		
X6106	(2 PINS, BLACK)	top center of engine		
X6120	(2 PINS, BLACK)	LH side of engine compartment (Z3 VERSIONS)	44-1	
X6120	(2 PINS, BLACK)	LH side of engine compartment (M VERSIONS)	34-2	
X6130	(3 PINS, BLACK)	front of engine	43-1	10-2
X6133	(2 PINS, BLACK)	rear RH side of engine compartment	31-2	
X6139	(3 PINS, BLACK)	under LH center of car	47-1	05-5
X6150	(10 PINS, BLACK)	rear RH side of engine compartment	31-1	05-2
X6151	(3 PINS, BLACK)	top RH side of engine		09-5
X6152	(3 PINS, BLACK)	top RH side of engine		09-5
X6153	(3 PINS, BLACK)	top RH side of engine		09-5
X6154	(3 PINS, BLACK)	top RH side of engine		09-5
X6155	(3 PINS, BLACK)	top RH side of engine		09-5
X6156	(3 PINS, BLACK)	top RH side of engine		09-5
X6163	(2 PINS, BLACK)	LH side of engine compartment (M VERSIONS)	31-3	

03/00

7000.0-24

1999



COMPONENT LOCATION CHART

Z3

COMP.	DESCRIPTION	LOCATION	7100.0	8500.0
X6163	(2 PINS, BLACK)	LH side of engine compartment (Z3 VERSIONS)	44-2	
X6167	(2 PINS, BLACK)	LH side of engine compartment	39-3	
X6203	(3 PINS, BLACK)	rear LH side of engine compartment (M VERSIONS)	33-1	10-2
X6203	(3 PINS, BLACK)	rear LH side of engine compartment (Z3 VERSIONS)	41-3	06-4
X6204	(3 PINS, BLACK)	front of engine below intake manifold	33-1	10-2
X6205	(2 PINS, BLACK)	top center of engine (Z3 VERSIONS)	42-2	
X6205	(2 PINS, BLACK)	front LH side of engine compartment (M VERSIONS)	34-1	
X6207	(4 PINS, BLACK)	LH side of engine compartment (M VERSIONS)	33-3	10-4
X6207	(3 PINS, BLACK)	LH side of engine compartment (Z3 VERSIONS)		10-2
X6214	(3 PINS, BLACK)	front of engine	44-3	10-2
X6224	(3 PINS, BLACK)	front of engine	47-2	06-4
X6231	(2 PINS, BLACK)	LH side of engine compartment (Z3 VERSIONS)	44-1	
X6231	(2 PINS, BLACK)	front of engine (M VERSIONS)	32-2	
X6236	(2 PINS, BLACK)	LH side of engine	40-1	
X6238	(2 PINS, BLACK)	RH side of oil filter (M VERSIONS)	32-2	
X6238	(2 PINS, BLACK)	RH side of oil filter (Z3 VERSIONS)	44-1	
X6240	(4 PINS, BLACK)	LH side of engine near starter (Z3 VERSIONS)	42-1	06-1
X6240	(4 PINS, BLACK)	LH side of engine (M VERSIONS)	33-1	06-1
X6247	(2 PINS, BLACK)	under LH rear of car	12-1	
X6252	(3 PINS, BLACK)	front of engine	33-3	10-2
X6254	(3 PINS, BLACK)	LH side of engine	47-1	06-4
X6256	(4 PINS, BLACK)	rear of engine compartment		10-3

03/00

7000.0-25

1999



COMPONENT LOCATION CHART

Z3

COMP.	DESCRIPTION	LOCATION	7100.0	8500.0
X6275	(2 PINS, BLACK)	top center of engine (M VERSIONS)	31-3	
X6275	(2 PINS, BLACK)	top center of engine (Z3 VERSIONS)	42-2	
X6276	(2 PINS, BLACK)	front of engine	47-2	
X6279	(2 PINS, BLACK)	front of engine	39-1	
X6300	(9 PINS, BLACK)	rear RH side of engine compartment in E-Box		03-4
X6301	(9 PINS, BLACK)	below LH side of dash		03-4
X6304	(9 PINS, BLACK)	rear RH side of engine compartment in E-Box		03-4
X6326	(9 PINS, BLACK)	rear RH side of engine compartment in E-Box		03-4
X6385	(10 PINS, BLACK)	top LH side of engine	39-2	05-2
X6394	(9 PINS, BLACK)	TIRE INFLATION SYSTEM		03-4
X6430	CABLE SOCKET B+ JUMP START JUNCTION POINT	rear RH side of engine compartment		
X6431	CABLE SOCKET B+ JUMP START JUNCTION POINT	rear RH side of engine compartment		
X6432	CABLE SOCKET B+ JUMP START JUNCTION POINT	rear RH side of engine compartment		
X6433	CABLE SOCKET B+ JUMP START JUNCTION POINT	rear RH side of engine compartment		
X6437	CABLE SOCKET B+ JUMP START JUNCTION POINT	rear RH side of engine compartment		
X6454	GROUND	rear RH side of engine compartment (Z3 VERSIONS)		
X6454	GROUND	rear RH side of engine compartment (M VERSIONS)	04-2	
X6455	GROUND	rear RH side of engine compartment (M VERSIONS)	04-2	
X6455	GROUND	rear RH side of engine compartment (Z3 VERSIONS)		

03/00

7000.0-26

1999



COMPONENT LOCATION CHART

Z3

COMP.	DESCRIPTION	LOCATION	7100.0	8500.0
X6456	GROUND	rear RH side of engine compartment	06-1	
X6500	(6 PINS, BLACK)	under rear storage compartment	07-1	06-5
X6501	(3 PINS, BLACK)	under rear storage compartment	07-1	02-5
X6506	(2 PINS, BLACK)	in E-Box	41-1	
X6509	CABLE SOCKET ALTERNATOR B+	front LH side of engine compartment	02-3	
X6510	CABLE SOCKET STARTER, TERMINAL 50	rear LH side of engine compartment at starter	02-2	
X6511	CABLE SOCKET STARTER, TERMINAL 30h	rear LH side of engine compartment at starter		
X6512	CABLE SOCKET STARTER, TERMINAL 30	rear LH side of engine compartment at starter	02-2	
X6524	(3 PINS, BLACK)	front LH side of engine compartment	43-2	10-2
X6550	(2 PINS, BLACK)	under LH center of car	34-3	
X7509	CABLE SOCKET ALTERNATOR, TERMINAL D+	front LH side of engine compartment	02-3	
X8500	(88 PINS, NATURAL)	rear RH side of engine compartment in E-Box	42-3	00-1
X8503	(6 PINS, VIOLET)	center console	22-1	04-5
X8505	(16 PINS, BLACK)	on RH side of transmission	15-1	11-4
X8507	(1 PIN, BLACK)	behind gas pedal	19-3	
X8511	(2 PINS, BLACK)	LH side of transmission	14-2	
X8516	(2 PINS, BLACK)	LH side of transmission		
X8533	(2 PINS, BLACK)	LH side of engine compartment	08-1	
X9023	(3 PINS, BLACK)	in lift gate	46-2	01-1
X9170	CABLE SOCKET GROUND	LH side of engine compartment		

03/00

7000.0-27

1999



COMPONENT LOCATION CHART

Z3

COMP.	DESCRIPTION	LOCATION	7100.0	8500.0
X9336	(4 PINS, NATURAL)	in upper RH A-pillar		03-1
X9633	GROUND	behind LH footwell speaker grille	03-2	
X9990	(3 PINS, BLACK)	underside of LH front seat		11-1
X9991	(10 PINS, BLACK)	underside of LH front seat	10-2	11-5
X9994	(3 PINS, BLACK)	underside of RH front seat		11-1
X9995	(10 PINS, BLACK)	underside of RH front seat	11-1	11-5
X9997	(2 PINS, ORANGE)	behind steering wheel		
X10010	GROUND	behind glove box	04-1	
X10013	(2 PINS, NATURAL)	behind steering wheel		
X10054	(8 PINS, BLACK)	RH side of LH footwell	21-1	02-1
X10059	(3 PINS, BLACK)	center console		01-2
X10065	(2 PINS, WHITE)	LH footwell	14-1	
X10088	(2 PINS, BLACK)	front RH side of engine compartment	30-3	
X10170	(3 PINS, NATURAL)	near steering column	38-3	01-1
X10182	(18 PINS, BLACK)	behind glove box		07-3
X10214	(3 PINS, VIOLET)	under LH front seat	10-2	10-5
X10215	(3 PINS, VIOLET)	under RH front seat	11-1	10-5
X10216	(3 PINS, YELLOW)	in LH front seat belt buckle	36-2	07-5
X10217	(3 PINS, YELLOW)	in RH front seat belt buckle	36-2	07-5
X10218	(3 PINS, NATURAL)	under RH front seat	24-2	01-1
X10218	(3 PINS, NATURAL)	under RH front seat (WITH SPORT SEAT)	11-2	01-1
X10239	(3 PINS, BLACK)	front of engine	33-3	10-2

03/00

7000.0-28

1999



COMPONENT LOCATION CHART

Z3

COMP.	DESCRIPTION	LOCATION	7100.0	8500.0
X10241	(3 PINS, BLACK)	front RH side of engine compartment	30-2	05-5
X10244	(1 PIN, BLACK)	behind glove box	24-3	
X10245	(12 PINS, BLACK)	center console	00-3	01-3
X10246	(12 PINS, BLACK)	in rear left speaker box	26-3	01-3
X10262	(9 PINS, BLACK)	below LH side of dash		03-4
X10263	(6 PINS, BLACK)	center console		04-5
X10266	(6 PINS, BLACK)	in RH forward side of luggage compartment (ROADSTER)	27-3	04-5
X10266	(6 PINS, BLACK)	in RH forward side of luggage compartment (COUPE)	46-1	04-5
X10285	(2 PINS, BLACK)	in lift gate	46-3	
X10299	(4 PINS, BLACK)	RH rear wheel well	17-3	03-1
X10422	CABLE SOCKET B+	below LH side of dash		
X11104	(1 PIN, —)	near interior rear view mirror	28-2	
X11105	(1 PIN, —)	near interior rear view mirror	28-2	
X11106	(1 PIN, —)	near interior rear view mirror	28-2	
X11209	(4 PINS, BLACK)	near RH rear wheel well	17-3	03-1
X11277	(2 PINS, BLACK)	in lift gate		
X11287	CONNECTORS SOLDERED UP	center of dash		
X11402	(3 PINS, VIOLET)	in luggage compartment lid		01-1
X11403	(3 PINS, VIOLET)	in luggage compartment lid		01-1
X13004	GROUND	behind glove box	04-1	
X13006	GROUND	in LH side of luggage compartment	05-3	
X13016	GROUND	in LH side of luggage compartment	05-2	

03/00

7000.0-29

1999



COMPONENT LOCATION CHART

Z3

COMP.	DESCRIPTION	LOCATION	7100.0	8500.0
X13017	(2 PINS, BLUE)	hard top		
X13025	(12 PINS, BLACK)	behind glove box	24-3	02-4
X13032	GROUND	under rear storage compartment	06-2	
X13045	(6 PINS, NATURAL)	center console		04-5
X13057	(2 PINS, BLACK)	in lift gate	37-2	
X13146	(8 PINS, BLACK)	in LH side of luggage compartment	25-3	02-1
X13233	(2 PINS, BLACK)	center of dash behind center console		
X13252	(15 PINS, BLACK)	behind glove box	38-2	05-1
X13253	(26 PINS, VIOLET)	behind glove box	38-2	00-3
X13254	(26 PINS, GREEN)	behind glove box	38-2	00-3
X13268	(3 PINS, BLACK)	in lift gate	37-2	01-1
X13287	(1 PIN, WHITE)	center of dash behind center console		
X18080	(1 PIN, BLACK)	in LH side of luggage compartment		
X18126	(17 PINS, BLACK)	center console behind radio		02-2
X18170	GROUND	below center console	03-1	
X18180	(3 PINS, BLACK)	in RH rear side of luggage compartment		01-1
X18184	(1 PIN, BLACK)	RIGHT REAR SPEAKER		
X18189	(1 PIN, BLACK)	LEFT REAR SPEAKER		
X18190	(3 PINS, BLACK)	in driver's door	17-2	10-5
X18196	(10 PINS, BLACK)	LH A-pillar	16-3	02-3
X18198	(10 PINS, BLACK)	RH A-pillar	18-1	02-3
X18279	(2 PINS, GRAY)	in driver's door		

03/00

7000.0-30

1999



COMPONENT LOCATION CHART

Z3

COMP.	DESCRIPTION	LOCATION	7100.0	8500.0
X18280	(2 PINS, GRAY)	in passenger's door		
X18333	(2 PINS, BLACK)	on instrument cluster		
X18349	(8 PINS, BLACK)	center console	00-3	08-3
X18350	(6 PINS, BLACK)	RH side of LH footwell	21-2	03-6
X18363	(9 PINS, BLACK)	in LH side of luggage compartment		03-4
X18364	(9 PINS, BLACK)	in LH side of luggage compartment		03-4
X18365	(3 PINS, BLACK)	rear RH side of engine compartment in E-Box	41-2	04-3
X18516	(3 PINS, BLACK)	in passenger's door	18-3	10-5
X18518	(4 PINS, BLACK)	under RH front seat	11-1	07-1
X18520	(10 PINS, BLACK)	center console RADIO		
X18521	(10 PINS, BLACK)	RH side of luggage compartment CD CHANGER		
X18766	(9 PINS, BLACK)	front Power Distribution Box rear LH side of engine compartment		03-4
X18767	(9 PINS, BLACK)	front Power Distribution Box rear LH side of engine compartment		03-4
X18983	(2 PINS, BLACK)	center of dash		
X18984	(2 PINS, BLACK)	center of dash	21-3	
X18994	(3 PINS, VIOLET)	LH footwell	20-1	01-1
X19007	(12 PINS, BLACK)	behind glove box	38-1	01-3
X19018	(2 PINS, BLACK)	behind glove box	23-2	
X19022	(3 PINS, BLACK)	under radiator	13-1	05-5
X19023	(2 PINS, BLACK)	below LH side of dash		
X19245	(8 PINS, BLACK)	center console		02-1
X19527	(16 PINS, BLACK)	center console right	28-3	08-1

03/00

7000.0-31

1999



COMPONENT LOCATION CHART

Z3

COMP.	DESCRIPTION	LOCATION	7100.0	8500.0
X19528	(3 PINS, NATURAL)	under rear storage compartment	07-2	02-5
X19565	(6 PINS, NATURAL)	center console		11-3
X21111	(3 PINS, NATURAL)	center console		01-2
X21112	(2 PINS, BLACK)	center console		
X21113	(2 PINS, BLACK)	center console		
X21114	(2 PINS, BLACK)	center console		
X23146	(2 PINS, BLACK)	in LH side of luggage compartment	25-3	
X60001	(9 PINS, BLACK)	rear RH side of engine compartment in E-Box	40-2	01-4
X60002	(24 PINS, BLACK)	rear RH side of engine compartment in E-Box	40-2	04-2
X60003	(52 PINS, BLACK)	rear RH side of engine compartment in E-Box	40-2	03-2
X60004	(40 PINS, BLACK)	rear RH side of engine compartment in E-Box	40-2	09-1
X60005	(9 PINS, BLACK)	rear RH side of engine compartment in E-Box	40-2	01-4
X62101	(4 PINS, BLACK)	on catalytic converter	43-3	06-1
X62102	(4 PINS, BLACK)	on catalytic converter	42-2	06-1
X62201	(4 PINS, BLACK)	on catalytic converter	43-3	06-1
X62202	(4 PINS, BLACK)	on catalytic converter	42-2	06-1
X64101	(2 PINS, BLACK)	rear RH side of engine compartment in E-Box	41-2	
X64102	(2 PINS, BLACK)	rear RH side of engine compartment in E-Box	41-2	
X64192	(2 PINS, BLACK)	rear RH side of engine compartment in E-Box		
X89977	(2 PINS, BLACK)	rear RH side of engine compartment in E-Box	40-3	
X91009	(2 PINS, BLACK)	under RH front seat	11-2	
Y1w	ABS HYDRAULIC UNIT	rear LH side of engine compartment	08-1	

03/00

7000.0-32

1999



COMPONENT LOCATION CHART

Z3

COMP.	DESCRIPTION	LOCATION	7100.0	8500.0
Y2	AIR CONDITIONING COMPRESSOR	front RH side of engine compartment		
Y4z . . .	WATER VALVE	rear LH side of engine compartment	14-3	
Y5	DRIVER'S SIDE MIRROR	in upper LH front door		
Y6	PASSENGER'S SIDE MIRROR	in upper RH front door		
Y19 . .	SHIFT-LOCK	center console	27-2	
Y6101	CYL. 1 FUEL INJECTION VALVE	on cylinder head		
Y6102	CYL. 2 FUEL INJECTION VALVE	on cylinder head		
Y6103	CYL. 3 FUEL INJECTION VALVE	on cylinder head		
Y6104	CYL. 4 FUEL INJECTION VALVE	on cylinder head		
Y6105	CYL. 5 FUEL INJECTION VALVE	on cylinder head		
Y6106	CYL. 6 FUEL INJECTION VALVE	on cylinder head		
Y6120	EVAPORATIVE EMISSION VALVE	LH side of engine compartment (Z3 VERSIONS)	44-1	
Y6120	EVAPORATIVE EMISSION VALVE	LH side of engine compartment (M VERSIONS)	34-2	
Y6130	IDLE SPEED CONTROL VALVE	front of engine	43-1	
Y6133	AIR PUMP	rear RH side of engine compartment	31-2	
Y6139	LEAKAGE DIAGNOSIS PUMP	under LH center of car	47-1	
Y6163	SECONDARY AIR PUMP VALVE	LH side of engine compartment (M VERSIONS)	33-2	
Y6163	SECONDARY AIR PUMP VALVE	LH side of engine compartment (Z3 VERSIONS)	44-2	
Y6167	VALVE, INDIVIDUAL CONTROL INTAKE SYSTEM	LH side of engine compartment	39-3	
Y6275	VARIABLE CAMSHAFT CONTROL VALVE 1	on cylinder head	31-3	

03/00

7000.0-33

1999



Z3

COMPONENT LOCATION CHART

COMP.	DESCRIPTION	LOCATION	7100.0	8500.0
Y6275z	VARIABLE CAMSHAFT CONTROL VALVE 1 (INLET)	on cylinder head	42-2	
Y6276	VARIABLE CAMSHAFT CONTROL VALVE 2 (OUTLET)	on cylinder head	47-2	
Y6550	SOLENOID VALVE ("RUNNING LOSSES")	under LH center of car	34-3	
Y8521	TRANSMISSION VALVE UNIT	on RH side of transmission	15-1	

03/00

7000.0-34

1999

7100.0 COMPONENT LOCATION VIEWS

ELECTRICAL CONTROL MODULE LOCATIONS

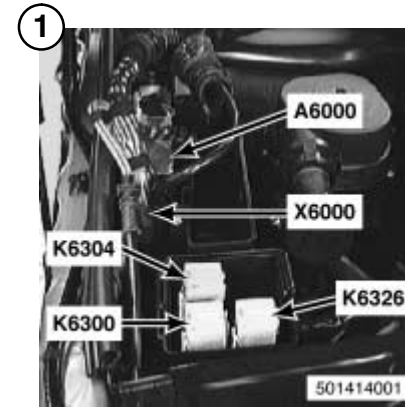
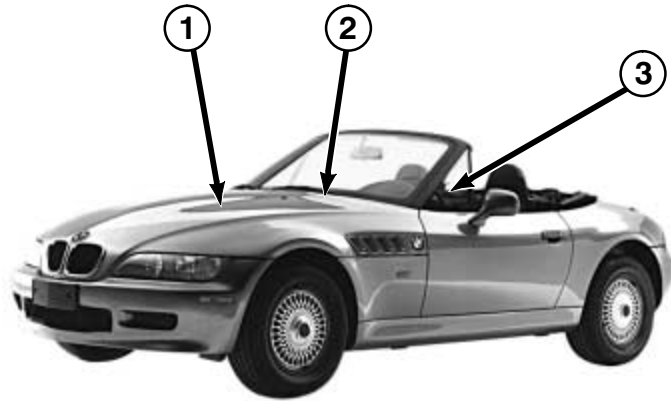

A6000
ENGINE CONTROL
MODULE (DME)

K6326
UNLOADER RELAY,
TERMINAL 15

X6000

X6000
ENGINE CONTROL
MODULE RELAY

K6304
SECONDARY AIR
PUMP RELAY

501414001

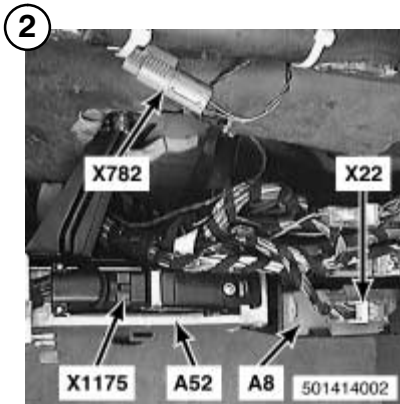

A8
CRUISE CONTROL
MODULE
(TEMPOMAT)

A52
SLIP CONTROL
MODULE
(ABS/ASC)

X22

X782

X1175

501414002

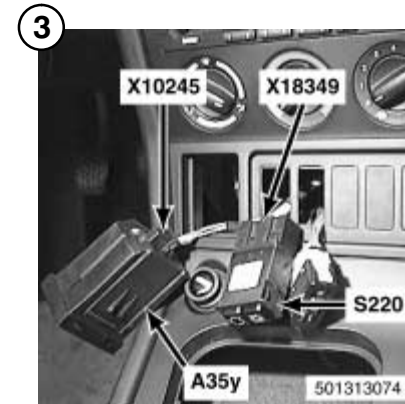

A35y
BOARD
COMPUTER
(BC - LOW)

S220
AIR CONDITIONING/
RECIRCULATING
SWITCH ASSEMBLY

X10245

X18349

501313074



COMPONENT LOCATION VIEWS

Z3

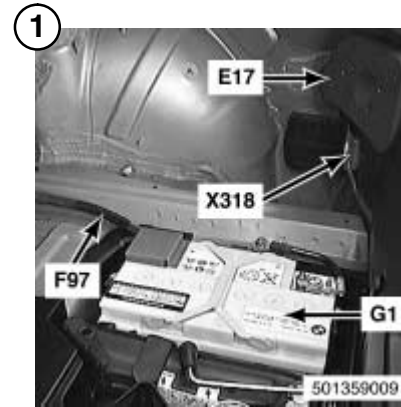
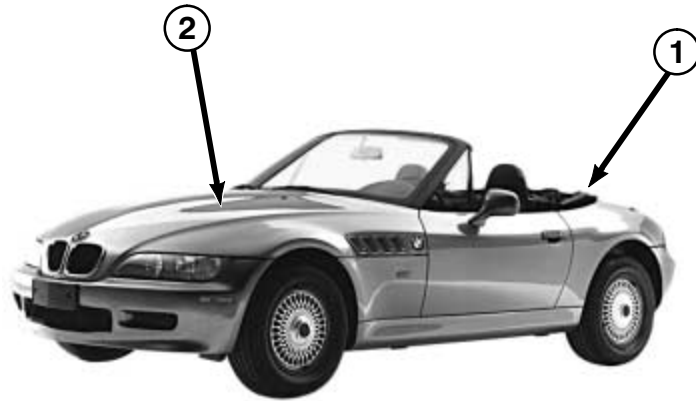
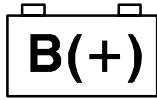

E17
RIGHT REAR LIGHT
ASSEMBLY

X318

F97
FUSIBLE LINK

G1
BATTERY



G6430
B+ JUMP START
JUNCTION POINT



COMPONENT LOCATION VIEWS

Z3

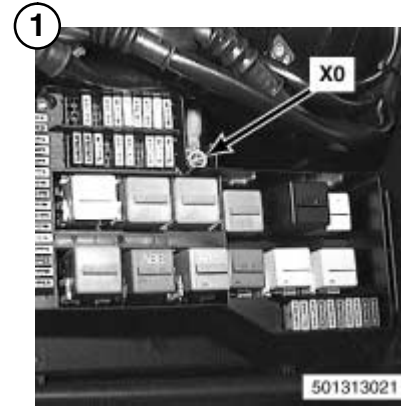
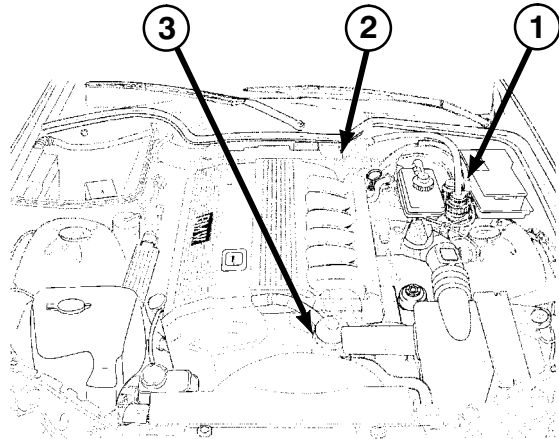
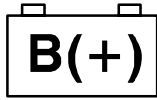

X0
B+ JUNCTION
POINT

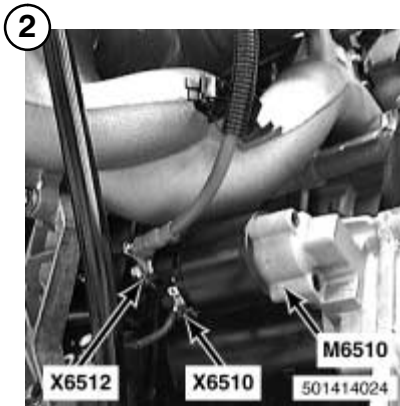

M6510
STARTER

X6510
X6512

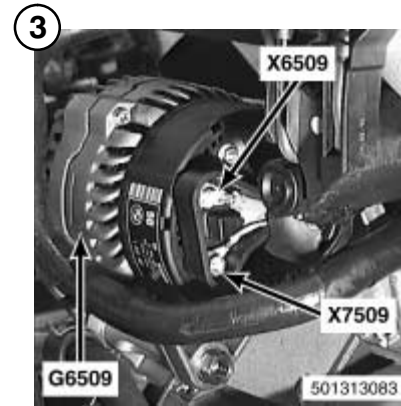

G6509
GENERATOR

X6509
X7509



COMPONENT LOCATION VIEWS

Z3

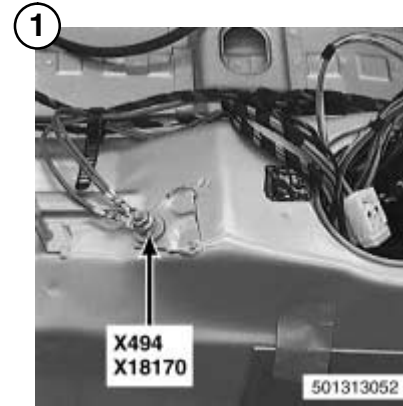
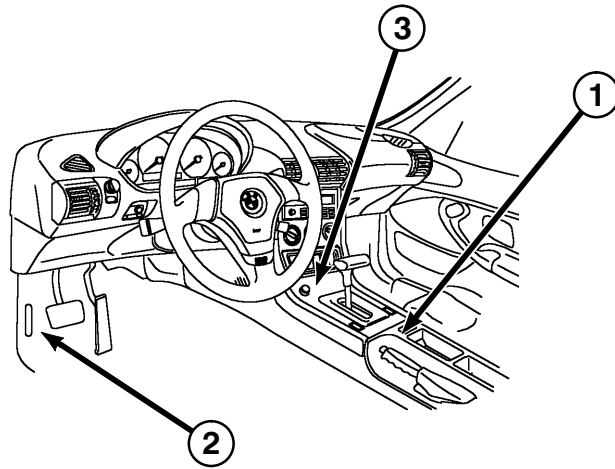
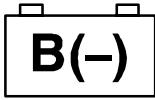

X494
GROUND

X18170
GROUND

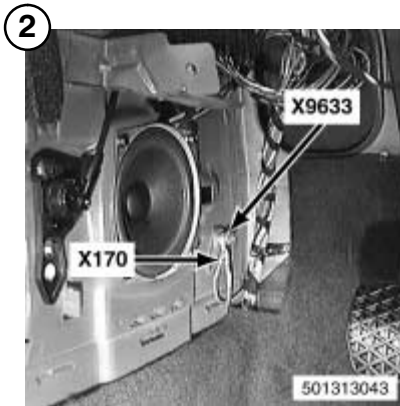

X170
GROUND

X9633
GROUND



X1441
GROUND



COMPONENT LOCATION VIEWS

Z3

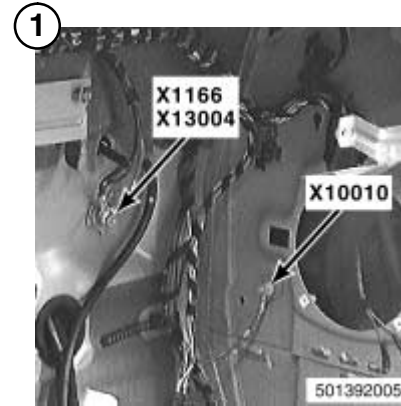
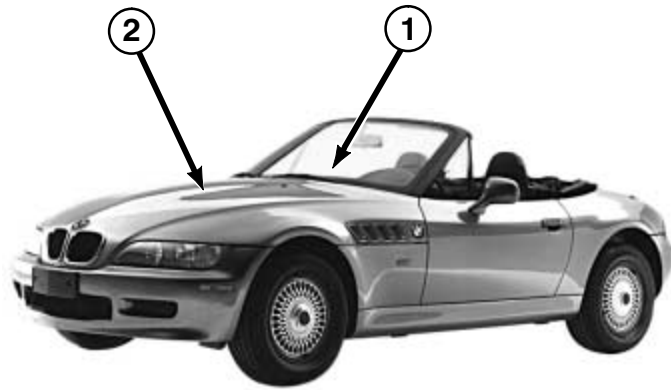
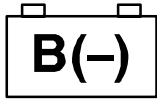

X1166
GROUND

X10010
GROUND

X13004
GROUND

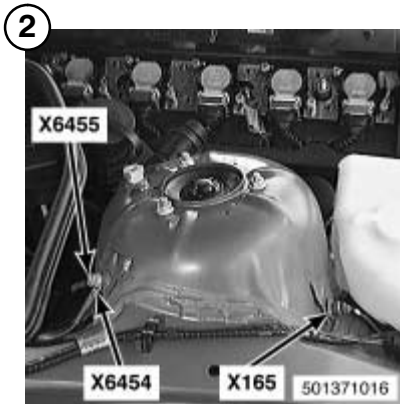

X165
GROUND

X6454
GROUND

X6455
GROUND

X6455

X6454

X165

501371016



Z3

COMPONENT LOCATION VIEWS

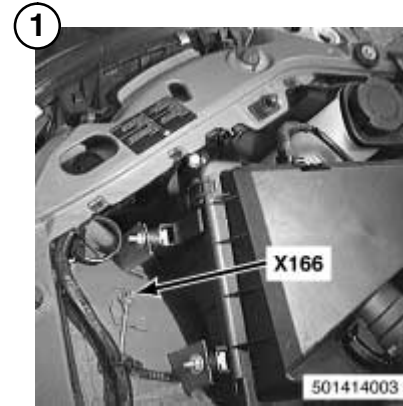
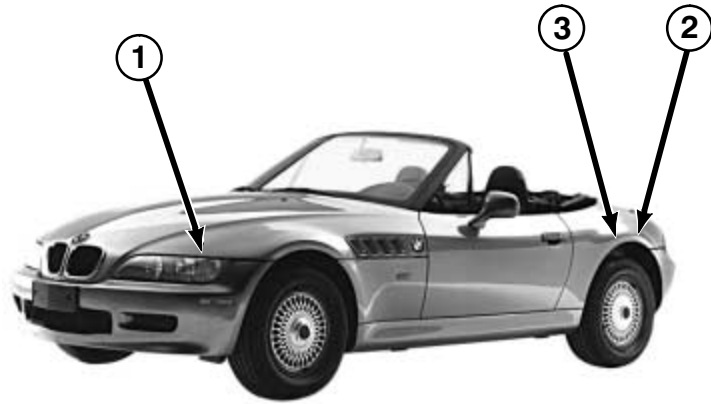
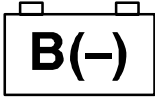

X166
GROUND



X13016
GROUND



X13006
GROUND



3

Z3

COMPONENT LOCATION VIEWS

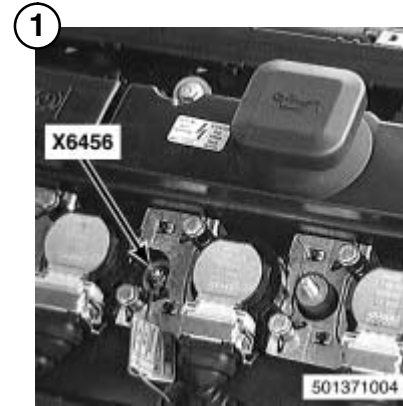
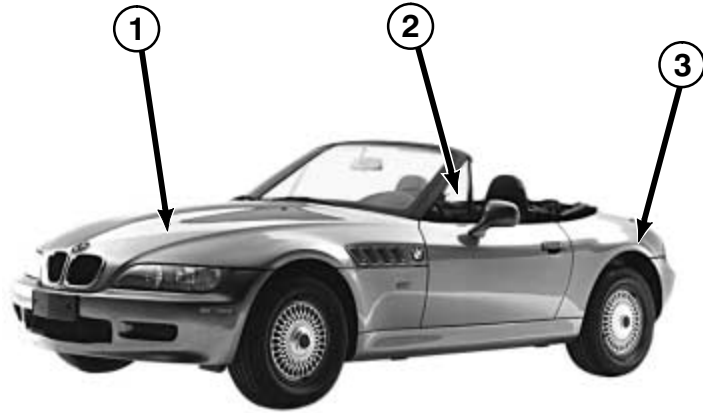
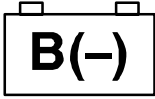

COMPONENT LOCATION VIEWS

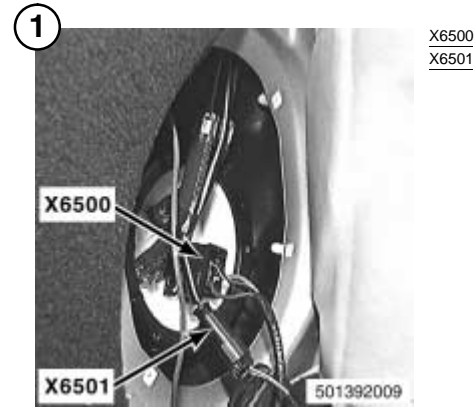
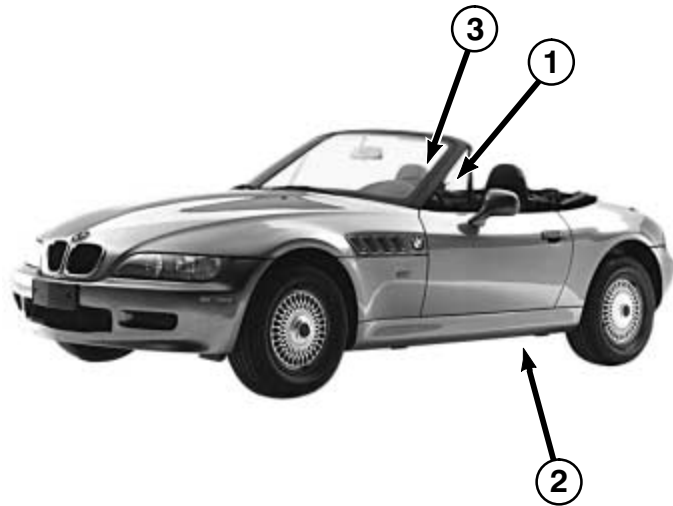

X6500
X6501



B65
FUEL TANK
PRESSURE
SENSOR

X19528

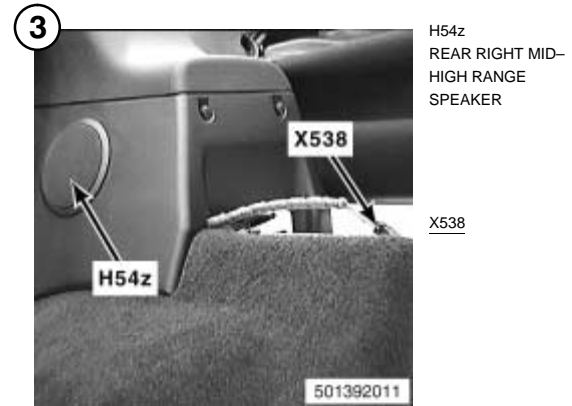

H54z
REAR RIGHT MID-
HIGH RANGE
SPEAKER

X538

COMPONENT LOCATION VIEWS

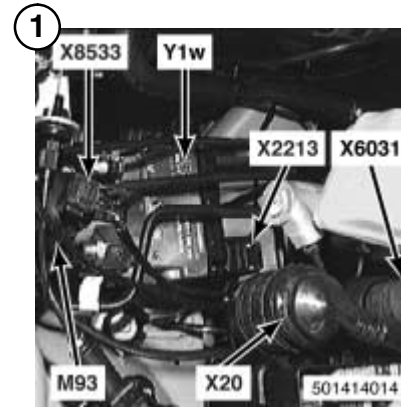
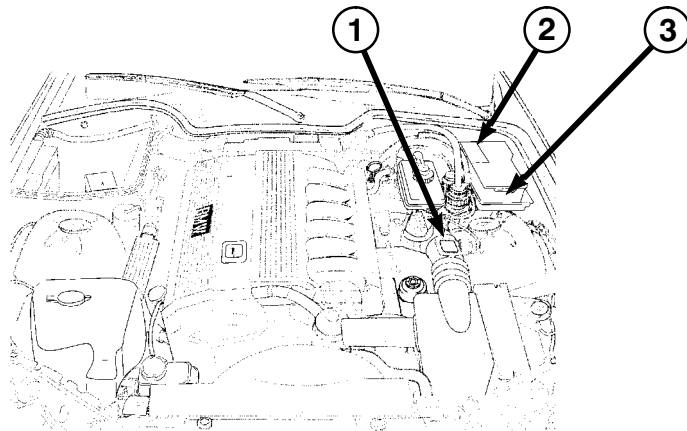

M93
AUXILIARY
THROTTLE
POSITION MOTOR
(ADS)

Y1w
ABS HYDRAULIC
UNIT

X20
X2213
X6031
X8533

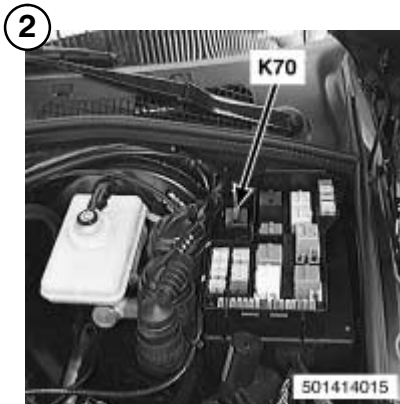

K70
CENTRAL LOCKING
LUGGAGE
COMPARTMENT
LID MOTOR RELAY
(ZV)

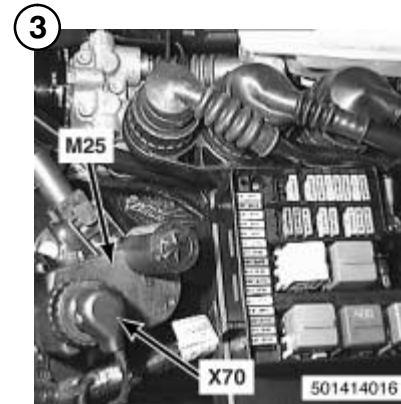

M25
CRUISE CONTROL
ACTUATOR
(TEMPOMAT)

X70

COMPONENT LOCATION VIEWS

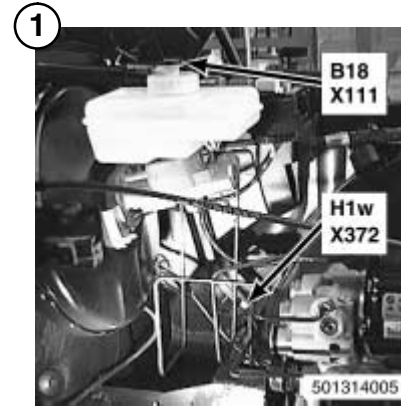
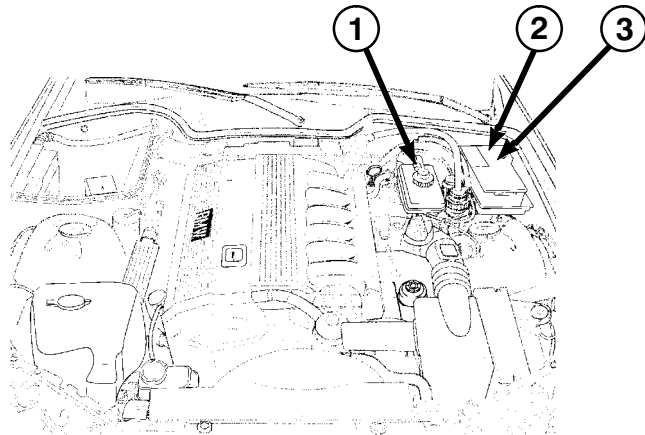

1

B18
BRAKE FLUID
LEVEL SWITCH

H1w
ANTI-THEFT HORN
(ALPINE)

X111
X372

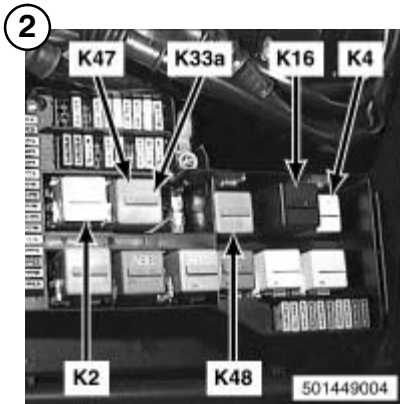

2

K2
HORN RELAY

K4
BLOWER RELAY

K16
HAZARD FLASHER
RELAY

K33a
AIR CONDITIONING
RELAY, MOTRONIC

K47
FRONT FOG LIGHT
RELAY

K48
LOW BEAM LIGHT
RELAY

501449004

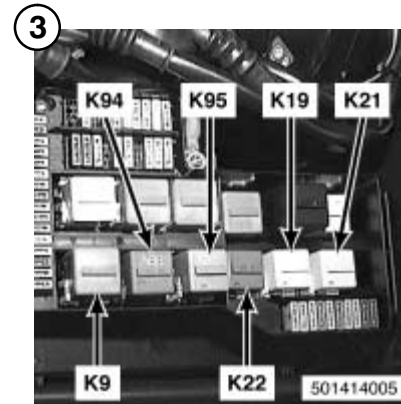

3

K9
UNLOADER RELAY,
TERMINAL 15

K19
COMPRESSOR
CONTROL RELAY

K21
NORMAL SPEED
RELAY

K94
ENGINE CONTROL
RELAY (ABS/ASC)

K95
VALVE RELAY
(ABS/ASC)

K22
HIGH SPEED
RELAY

501414005

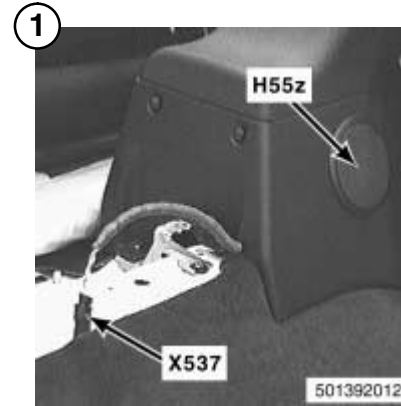
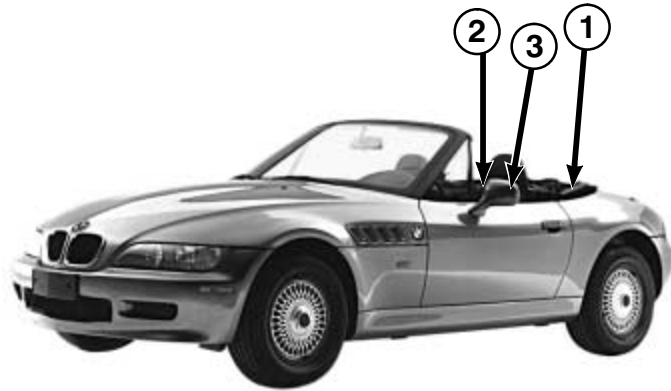

H55z
REAR LEFT MID-
HIGH RANGE
SPEAKER

X537

501392012

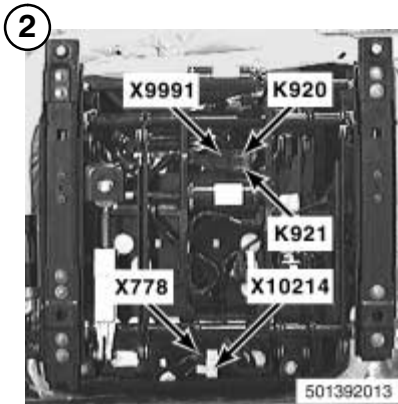

K920
DRIVER'S SEAT
TILT ADJUST CUT-
OFF RELAY

K921
DRIVER'S SEAT
LENGTH ADJUST
CUT-OFF RELAY

X778
X9991
X10214

501392013

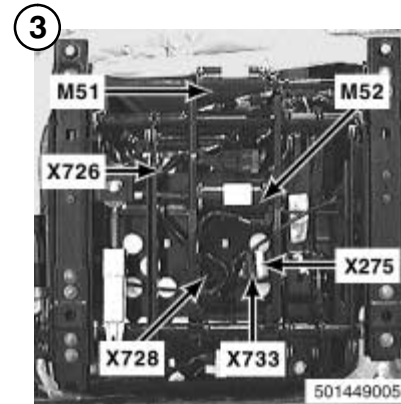

M51
DRIVER'S SEAT
MOVEMENT
MOTOR

M52
DRIVER'S SEAT
HEIGHT MOTOR

X275
X726
X728
X733

501449005

COMPONENT LOCATION VIEWS

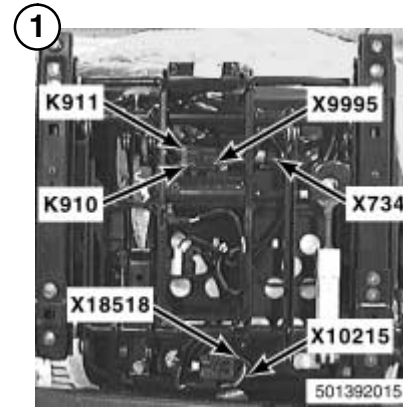
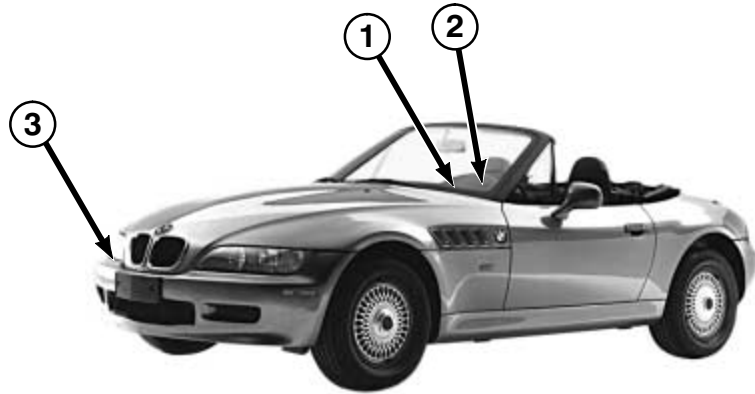

K910
PASSENGER'S
SEAT TILT ADJUST
CUT-OFF RELAY

K911
PASSENGER'S
SEAT LENGTH AD-
JUST CUT-OFF
RELAY

X734
X9995
X10215
X18518

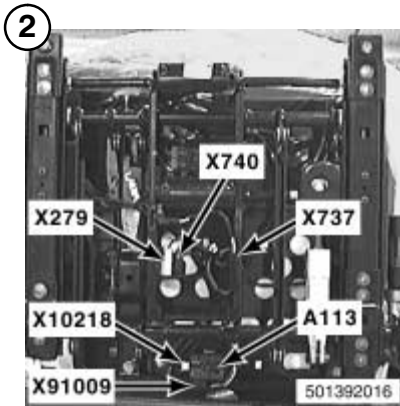

A113
SEAT OCCUPANCY
DETECTOR

X279
X737
X740
X10218
X91009

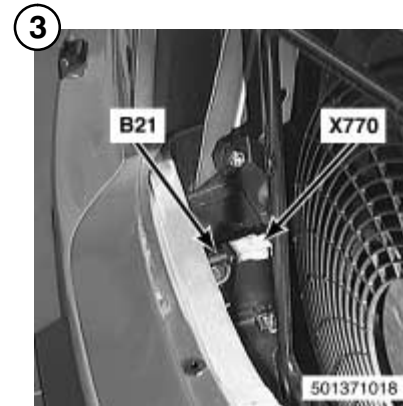

B21
ON-BOARD
COMPUTER
TEMPERATURE
SENSOR

X770

COMPONENT LOCATION VIEWS

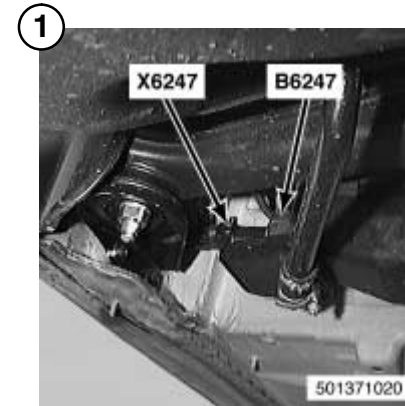
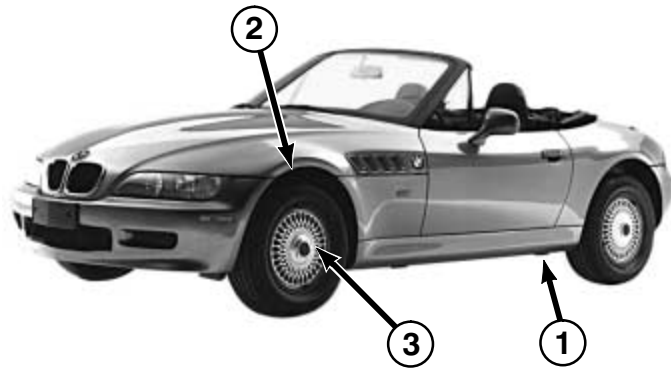

B6247
CHARCOAL FILTER
SHUT-OFF VALVE

X6247

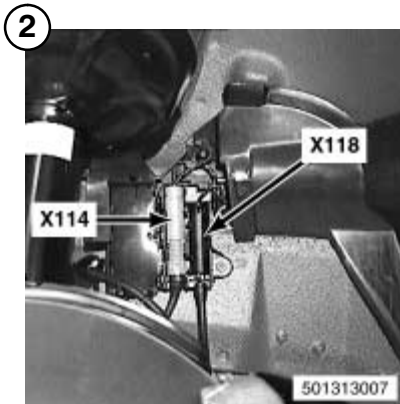

X114
X118

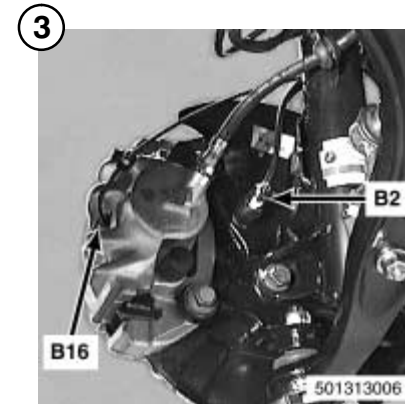

B2
LEFT FRONT
SPEED SENSOR –
ABS

B16
LEFT FRONT
BRAKE PAD
SENSOR

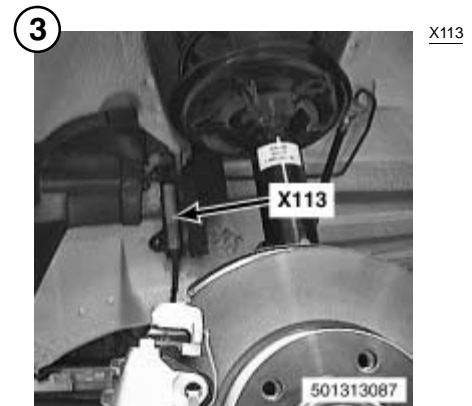
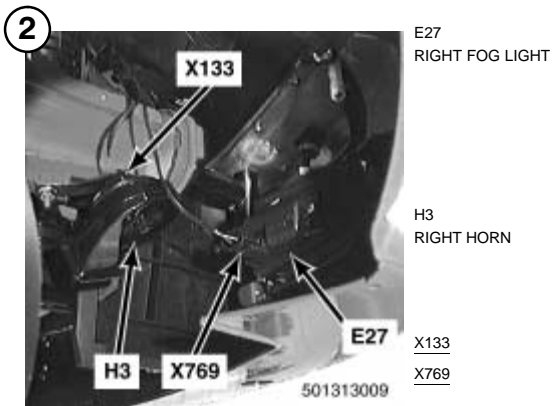
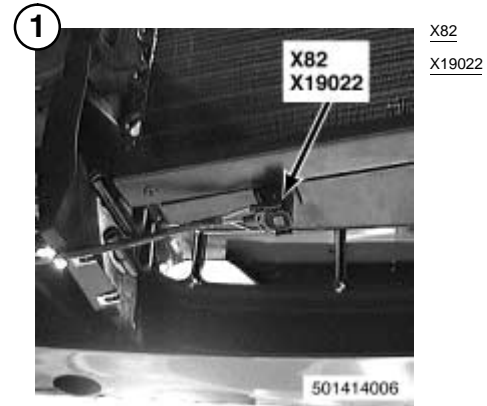
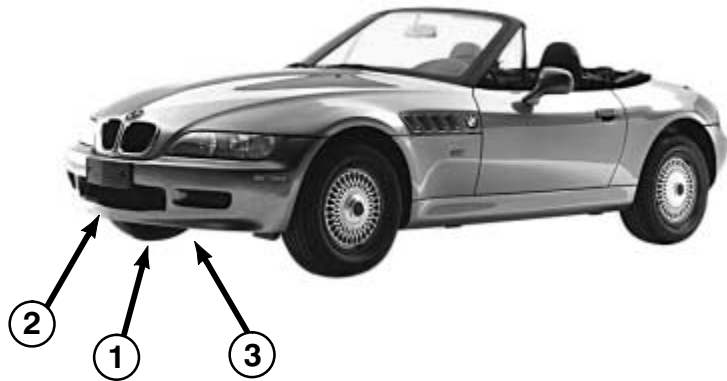

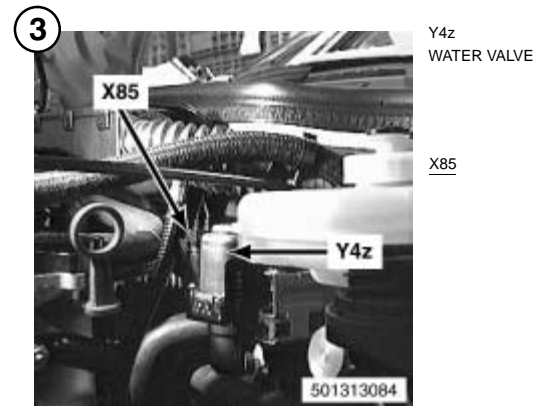
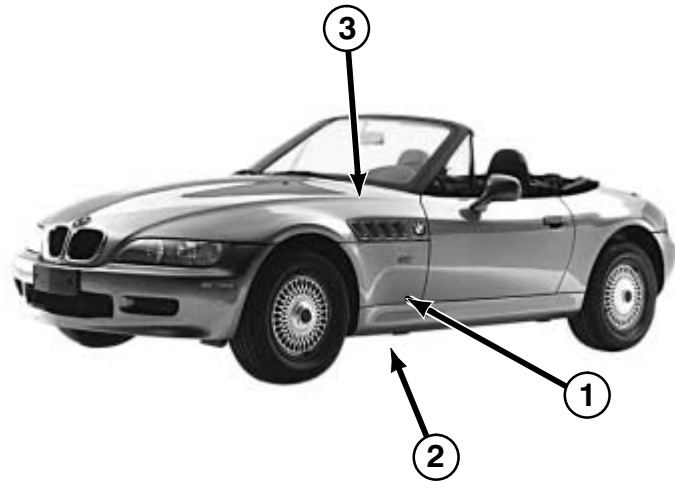

COMPONENT LOCATION VIEWS

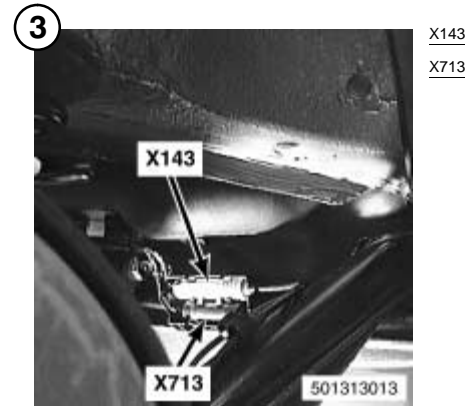
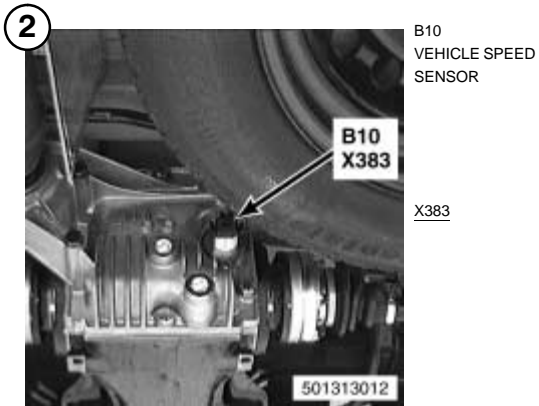
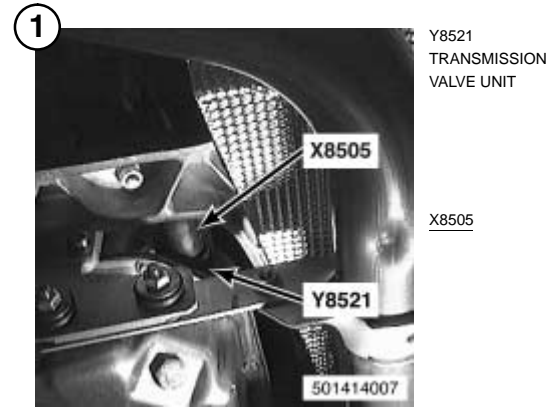
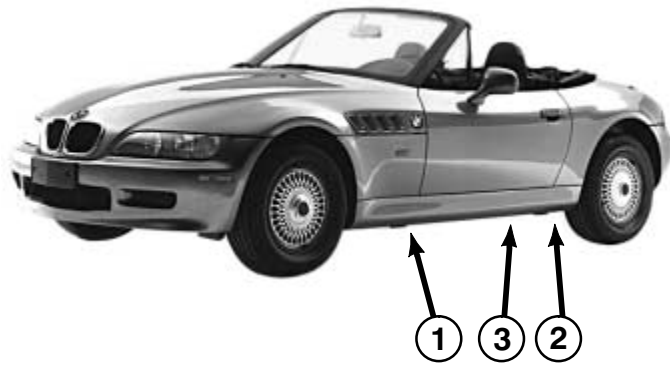

COMPONENT LOCATION VIEWS

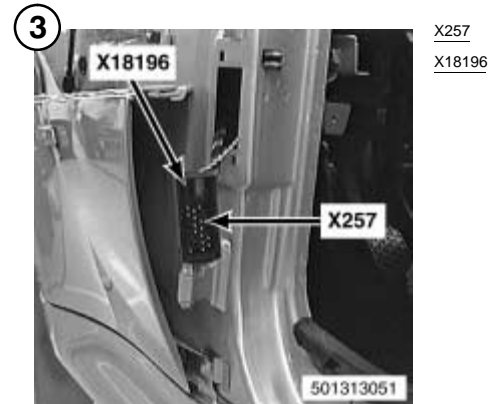
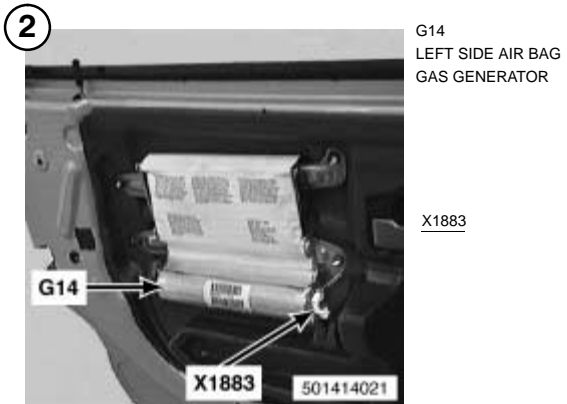
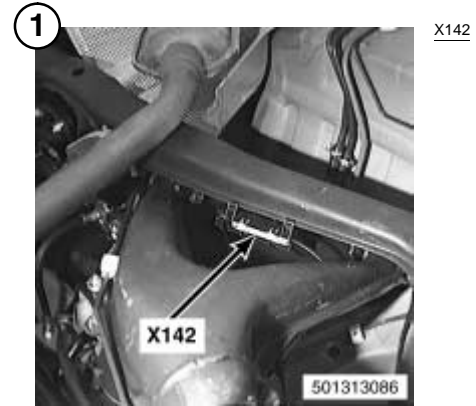
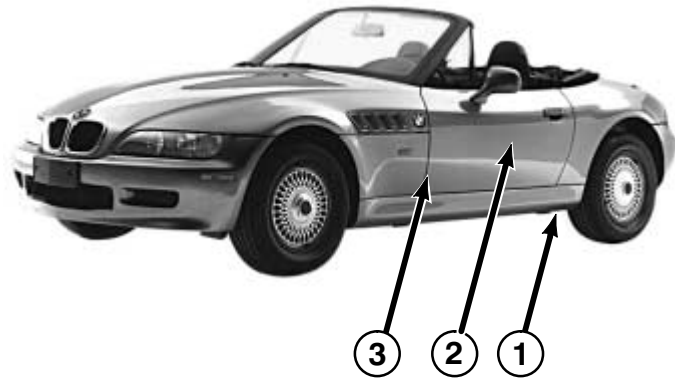

COMPONENT LOCATION VIEWS

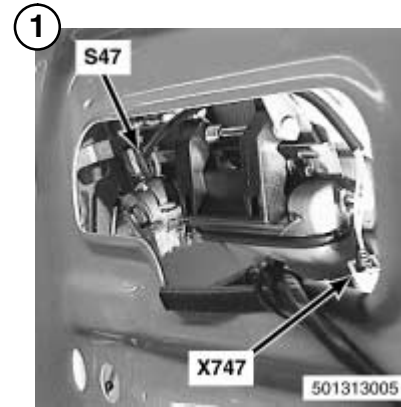
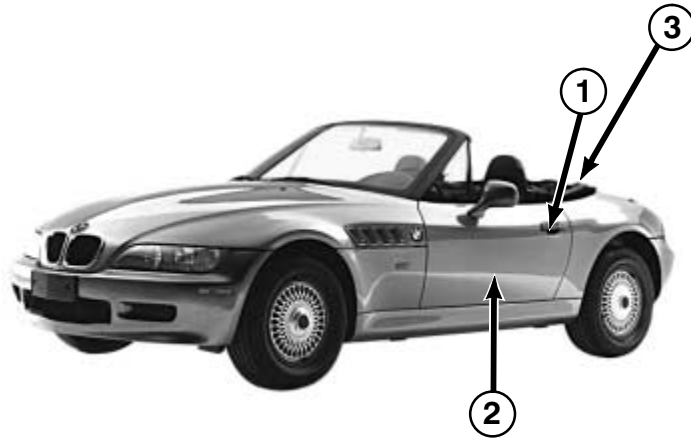

S47
DRIVER'S DOOR
LOCK SWITCH

X747

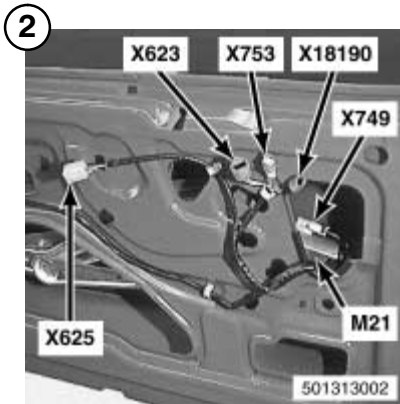

M21
DRIVER'S WINDOW
MOTOR

X623
X625
X749
X753
X18190

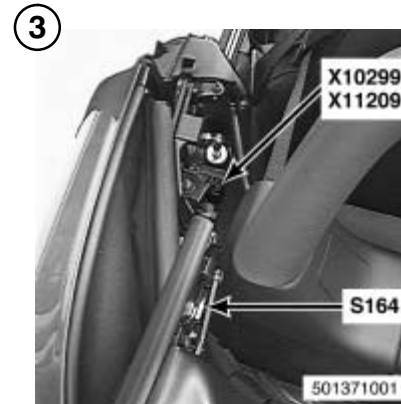

S164
CONVERTIBLE TOP
END-POSITION MI-
CRO SWITCH

X10299
X11209

COMPONENT LOCATION VIEWS

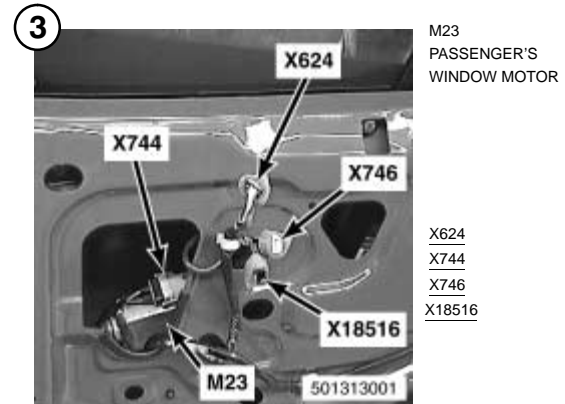
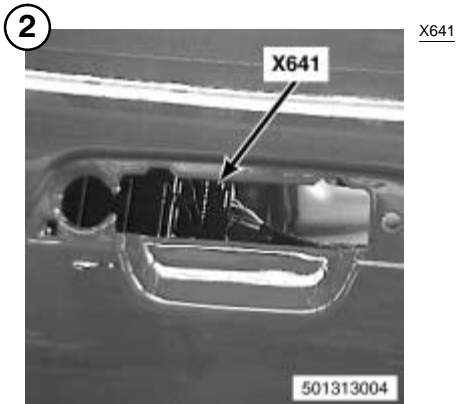
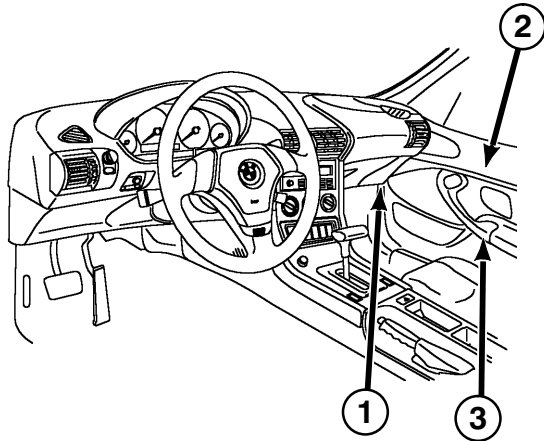

COMPONENT LOCATION VIEWS

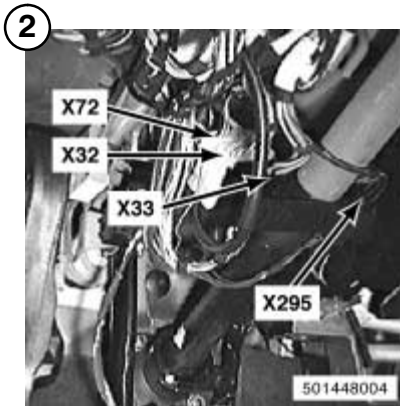
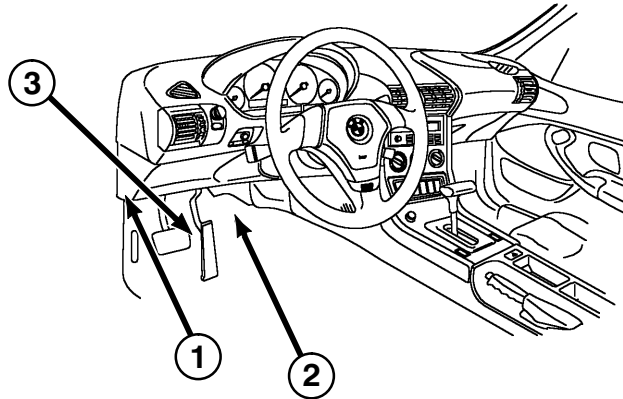

X32
X33
X72
X295

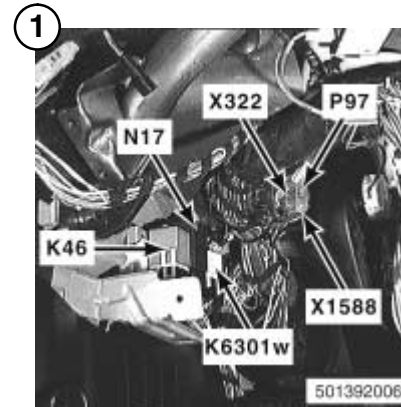

K46 HIGH BEAM LIGHT RELAY	P97 AUXILIARY FUSE BOX
K6301w FUEL PUMP RELAY	X322 X1588
N17 CRASH CONTROL MODULE	

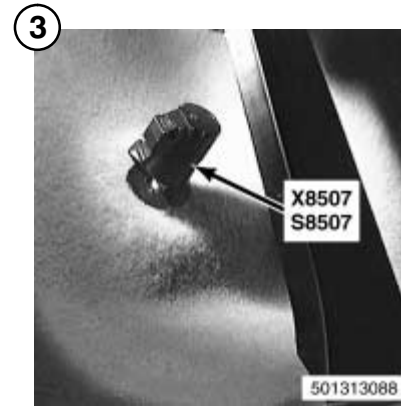

S8507
KICK-DOWN
SWITCH

X8507

COMPONENT LOCATION VIEWS

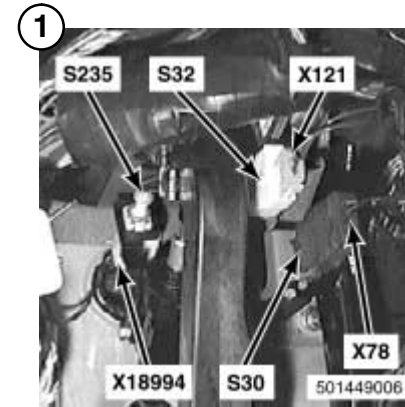
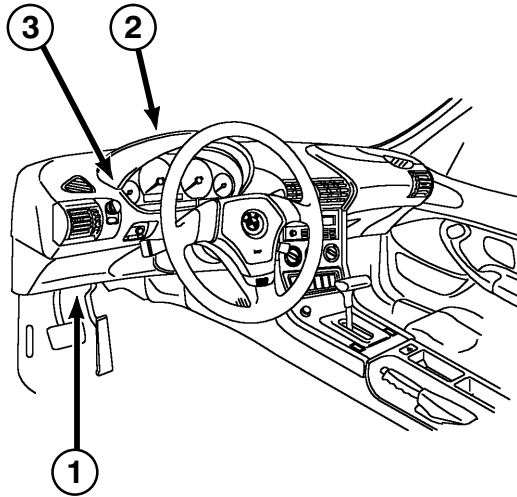

S30
BRAKE LIGHT
SWITCH

X78
X121
X18994

S32
CLUTCH SWITCH

S235
STARTER
IMMOBILIZATION
SWITCH

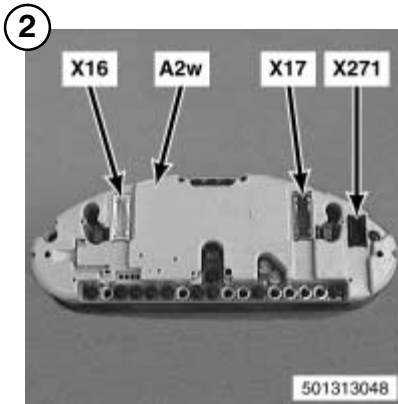

A2w
INSTRUMENT
CLUSTER

X16
X17
X271

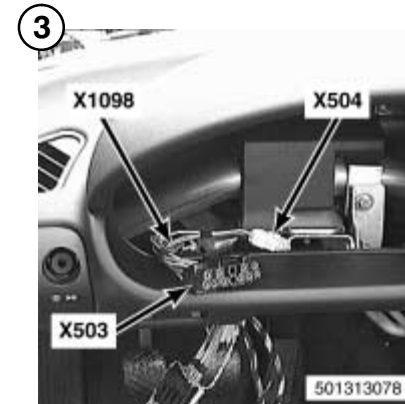

X503
X504
X1098

COMPONENT LOCATION VIEWS

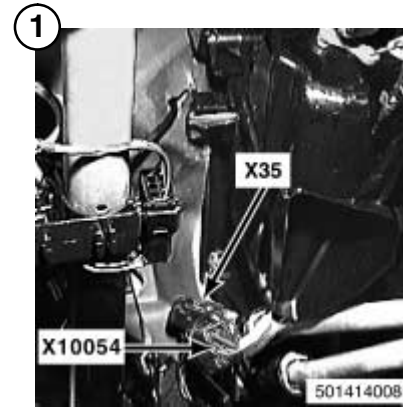
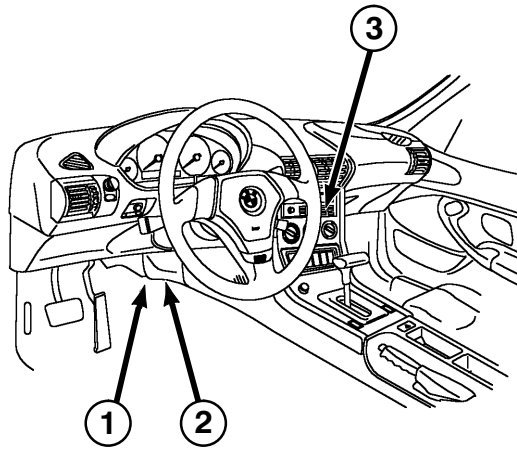

X35
X10054

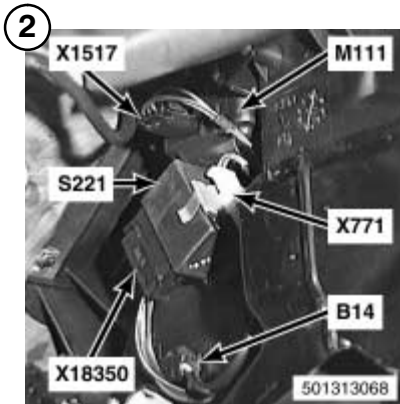

B14
EVAPORATOR
TEMPERATURE
SENSOR

X771
X1517
X18350

M111
FRESH AIR
RECIRCULATION
MOTOR

S221
EVAPORATOR
CONTROLLER

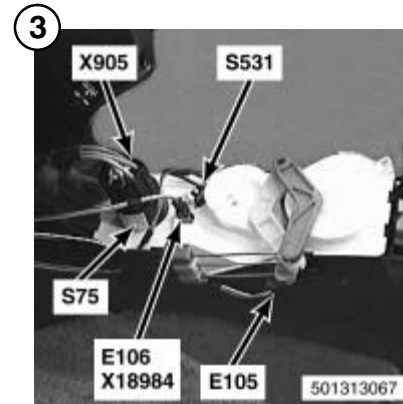

E105
HEAT/A/C
CONTROL PANEL
ILLUMINATION

S531
TEMPERATURE
WHEEL SWITCH

E106
HEAT/A/C
CONTROL PANEL
ILLUMINATION

X905
X18984

S75
BLOWER SWITCH

COMPONENT LOCATION VIEWS

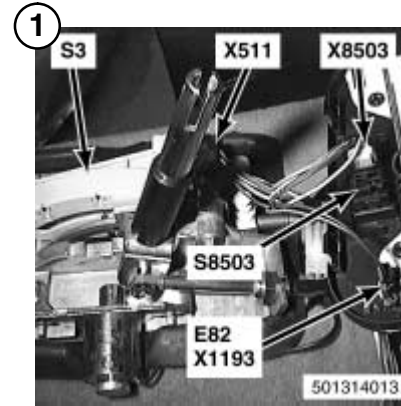
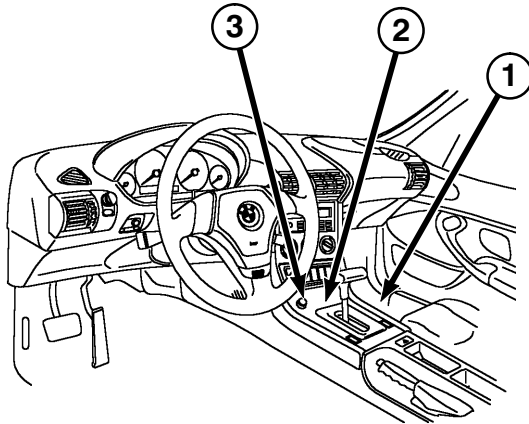

E82
TRANSMISSION
POSITION INDICA-
TOR LIGHT

X511
X1193
X8503

S3
AUTOMATIC
TRANSMISSION
RANGE SWITCH

S8503
PROGRAM SWITCH

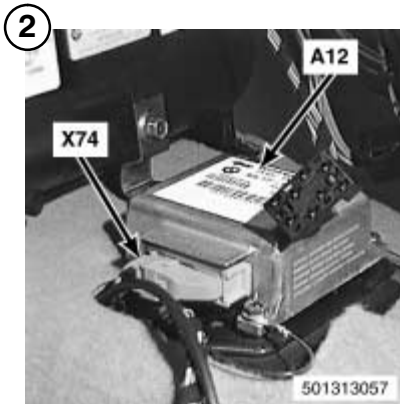

A12
SUPPLEMENTAL
RESTRAINT
SYSTEM CONTROL
MODULE

X74

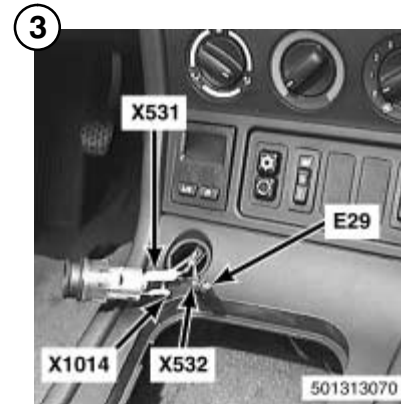

E29
FRONT CIGAR
LIGHTER LIGHT

X531
X532
X1014

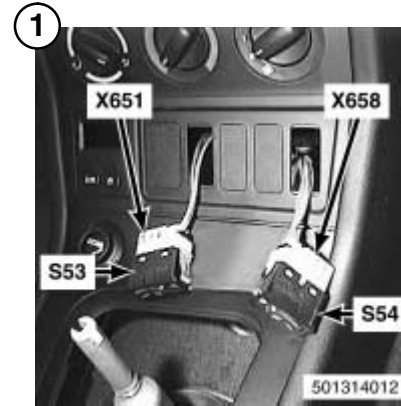
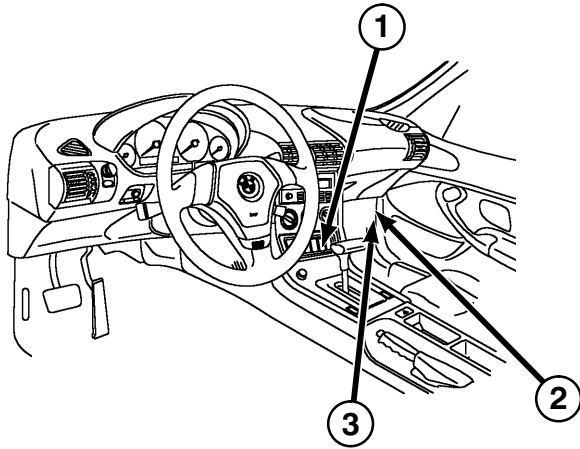

S53
DRIVER'S SEAT,
SEAT HEATER
SWITCH

S54
PASSENGER'S
SEAT, SEAT
HEATER SWITCH

X651
X658

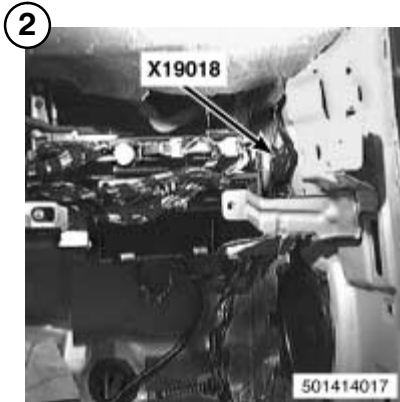

X19018

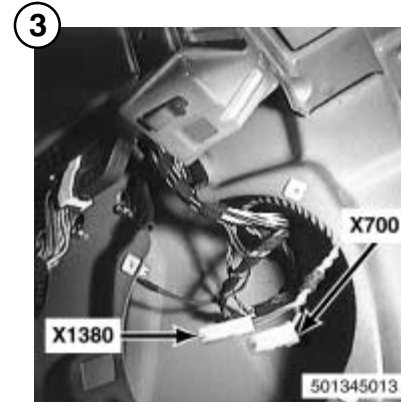

X700
X1380

COMPONENT LOCATION VIEWS

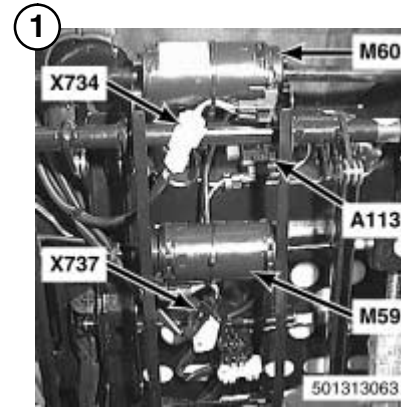
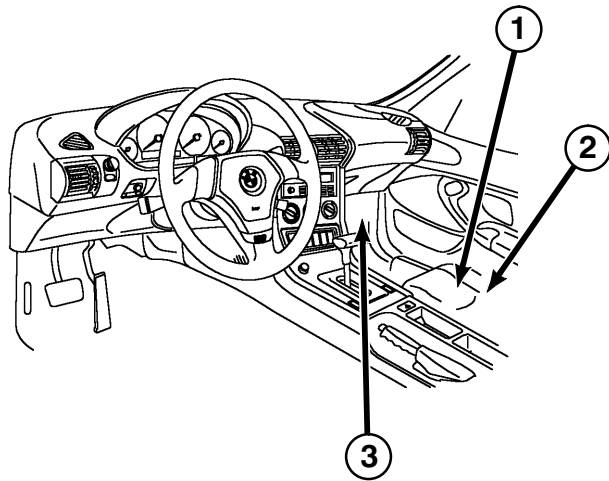

A113 SEAT OCCUPANCY DETECTOR X734
X737

M59 PASSENGER'S SEAT HEIGHT MOTOR

M60 PASSENGER'S SEAT MOVEMENT MOTOR

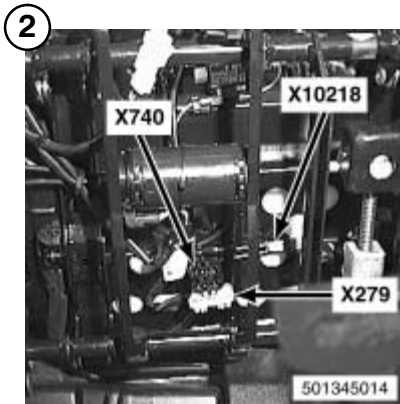

X279
X740
X10218



X10244
X13025

COMPONENT LOCATION VIEWS

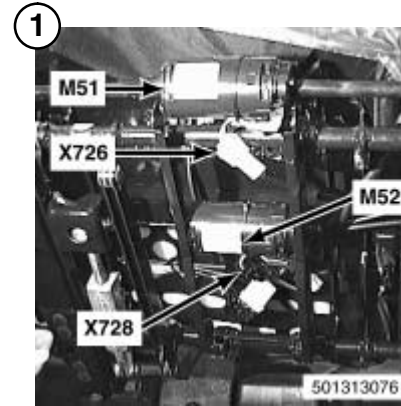
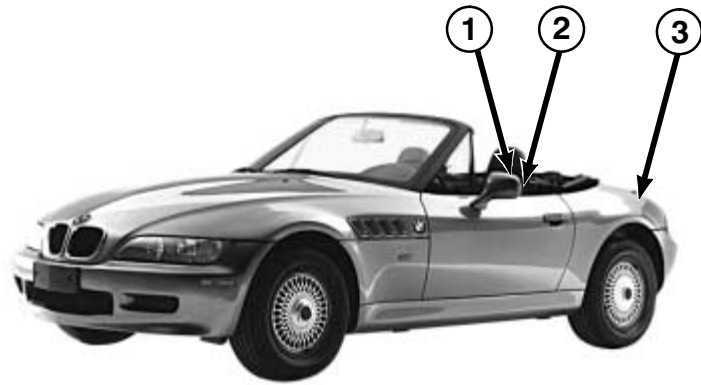

M51
DRIVER'S SEAT
MOVEMENT
MOTOR

M52
DRIVER'S SEAT
HEIGHT MOTOR

X726
X728

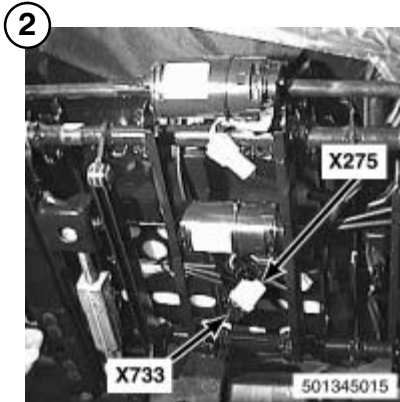

X275
X733

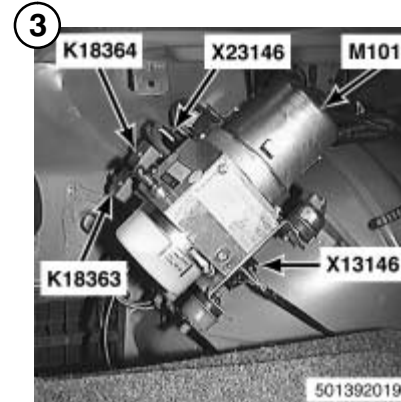

K18363
CONVERTIBLE TOP
RELAY I (CLOSE)

X13146
X23146

K18364
CONVERTIBLE TOP
RELAY II (OPEN)

M101
CONVERTIBLE TOP
MOTOR

COMPONENT LOCATION VIEWS

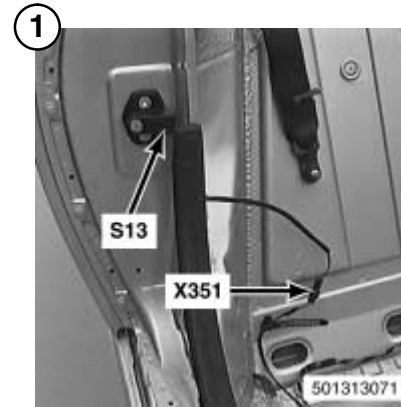
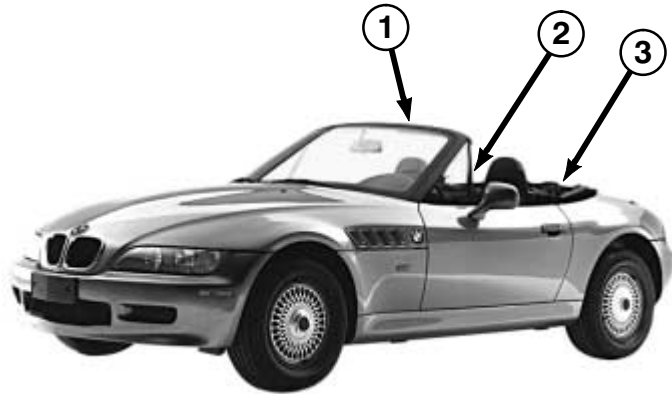

S13
PASSENGER'S
DOOR JAMB
SWITCH

X351



X898



X1715
X10246

COMPONENT LOCATION VIEWS

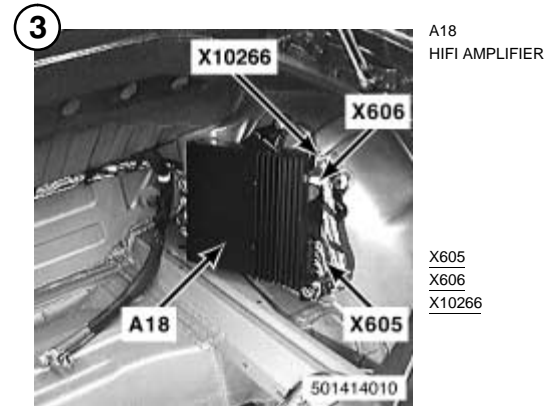
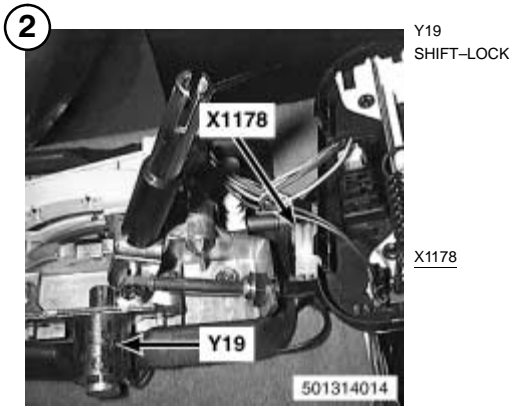
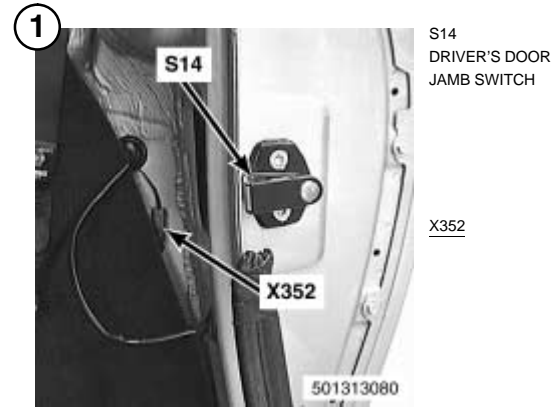

COMPONENT LOCATION VIEWS

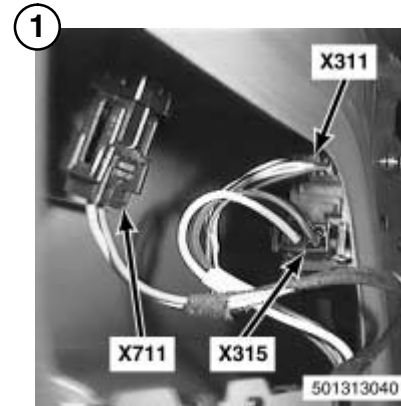
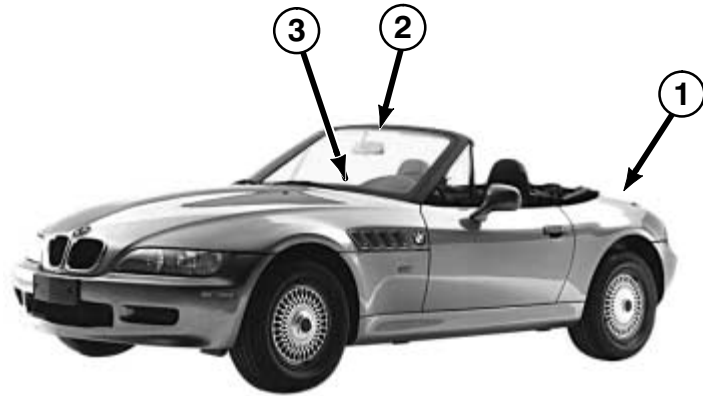

X311
X315
X711

501313040

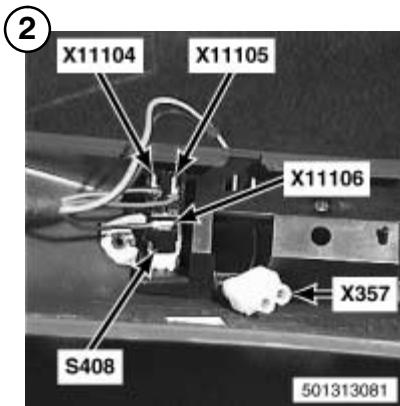

S408
INTERIOR LIGHT
SWITCH

X357
X11104
X11105
X11106

501313081

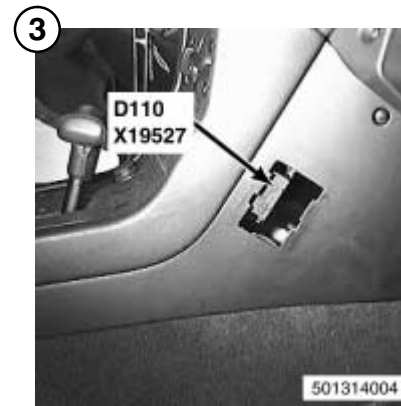

D110
OBD II
CONNECTOR

X19527

501314004

COMPONENT LOCATION VIEWS

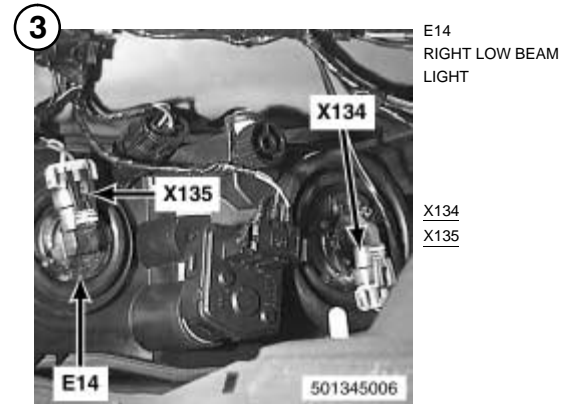
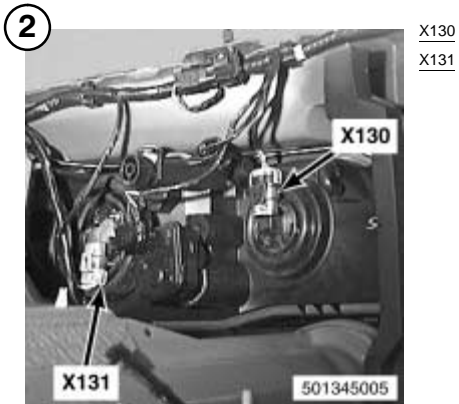
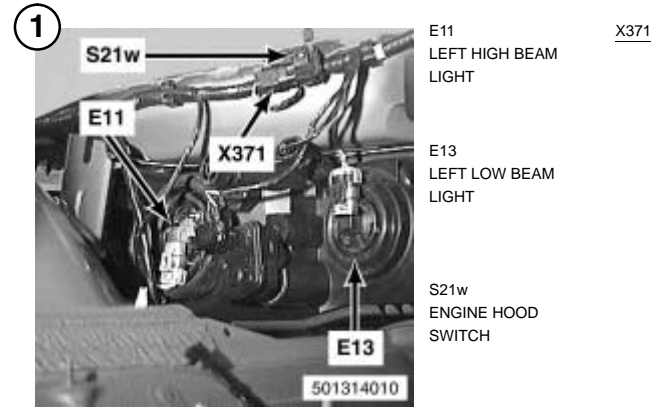
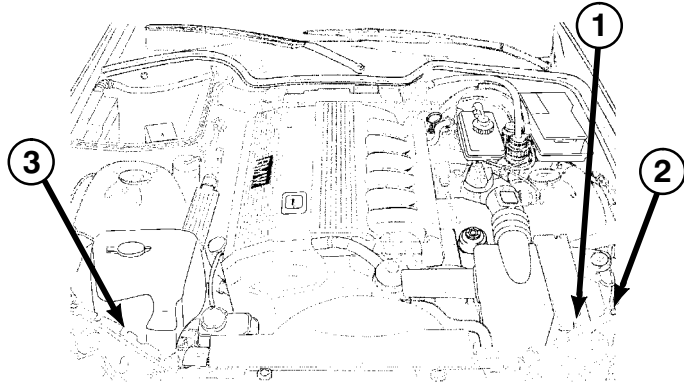

COMPONENT LOCATION VIEWS

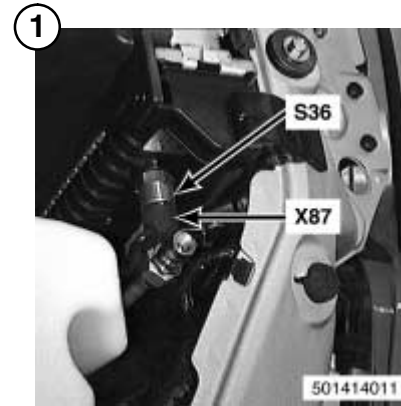
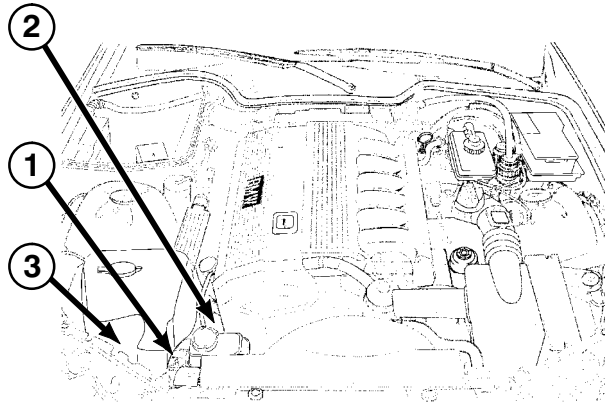

S36
TEMPERATURE
SWITCH

X87

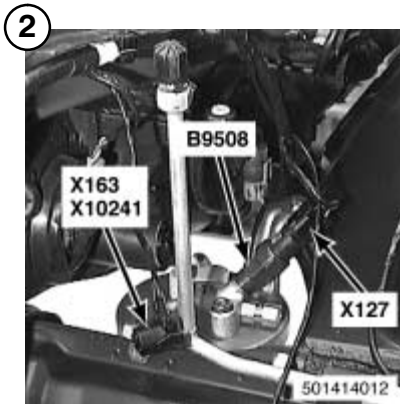

B9508
PRESSURE
SWITCH

X127
X163
X10241

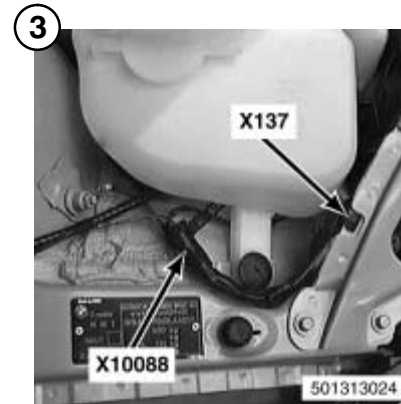

X137
X10088

COMPONENT LOCATION VIEWS

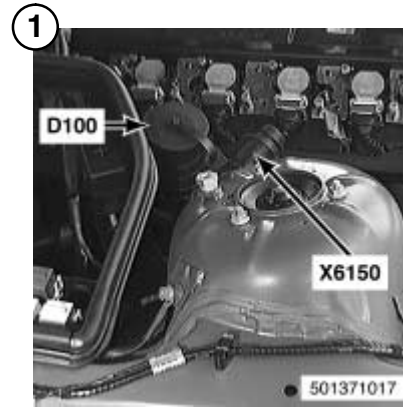
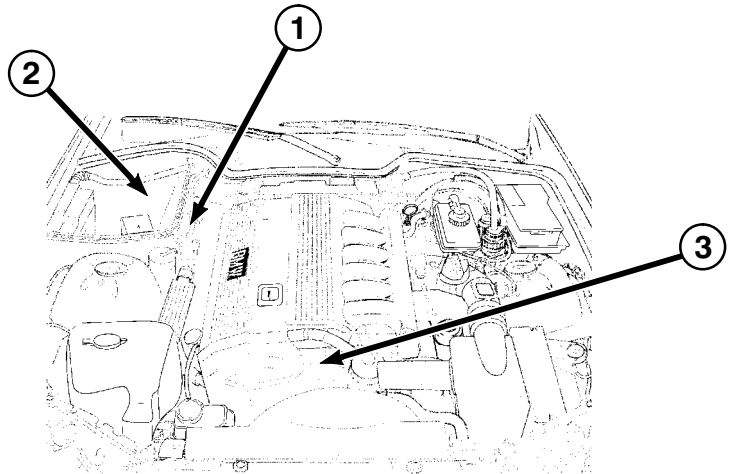

D100
DATA LINK
CONNECTOR

X6150

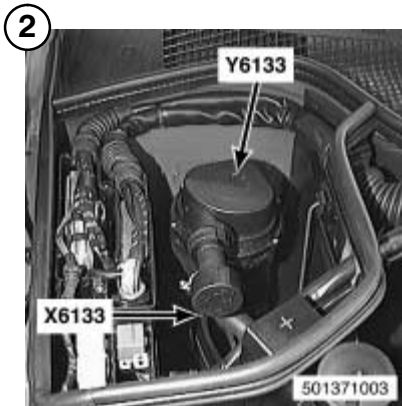

Y6133
AIR PUMP

X6133

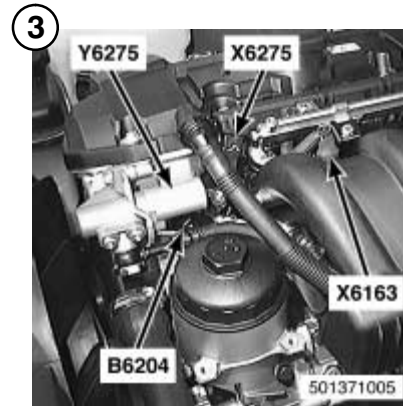

B6204
CAMSHAFT
POSITION SENSOR
(CYLINDER
IDENTIFICATION)

Y6275
VARIABLE CAM-
SHAFT CONTROL
VALVE 1

X6163
X6275

COMPONENT LOCATION VIEWS

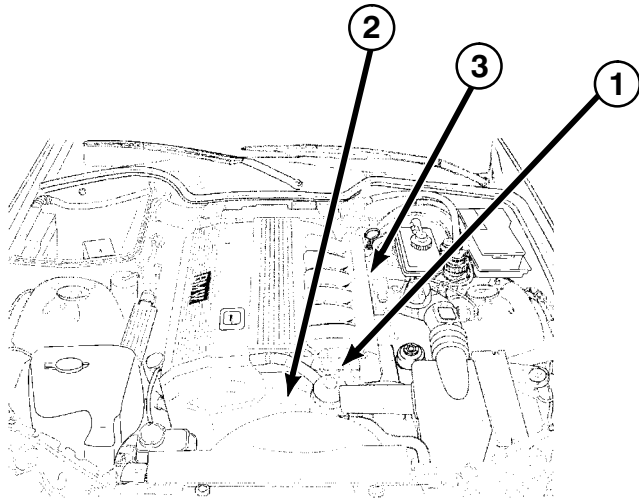

B6256
DUAL
TEMPERATURE
SENSOR
(COOLANT
TEMPERATURE)

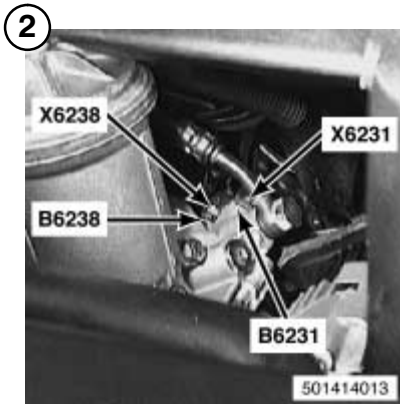

B6231
OIL PRESSURE
SWITCH

B6238
OIL TEMPERATURE
SENSOR

X6231
X6238

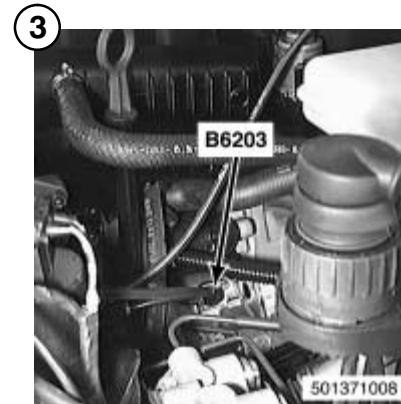

B6203
CRANKSHAFT
POSITION/RPM
SENSOR

COMPONENT LOCATION VIEWS

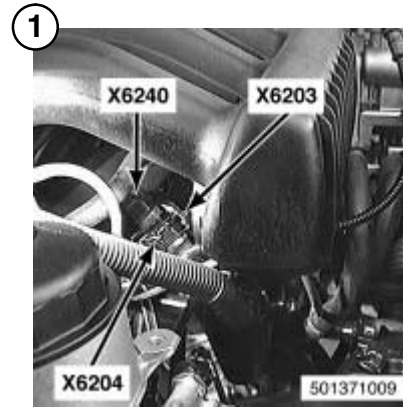
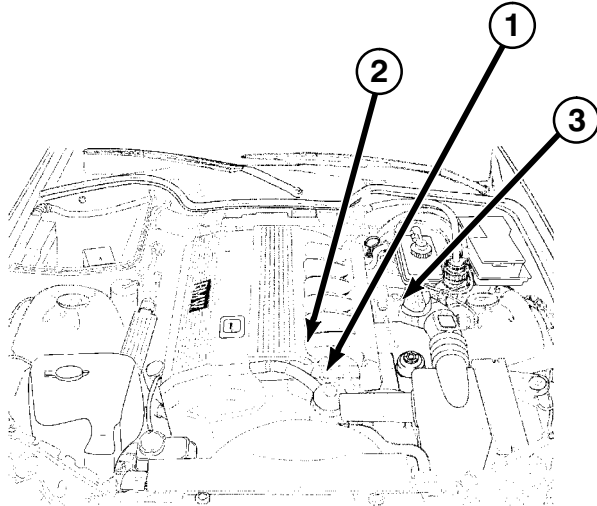

X6203
X6204
X6240



B6240
KNOCK SENSOR

Y6163
SECONDARY AIR
PUMP VALVE

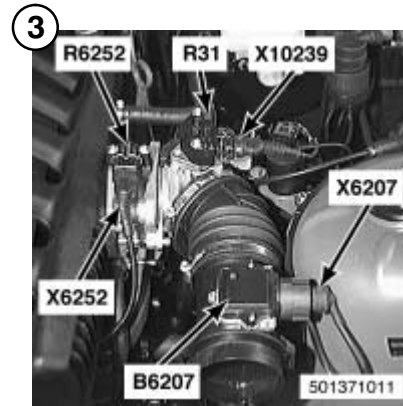

B6207
HOT FILM AIR
MASS METER

X6207
X6252
X10239

R31
AUXILIARY
THROTTLE
POSITION SENSOR

R6252
THROTTLE
POSITION SENSOR

COMPONENT LOCATION VIEWS

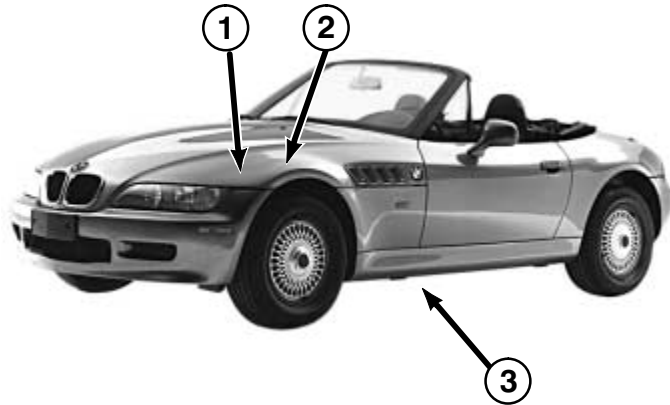

B6205
INTAKE AIR
TEMPERATURE
SENSOR

X6205

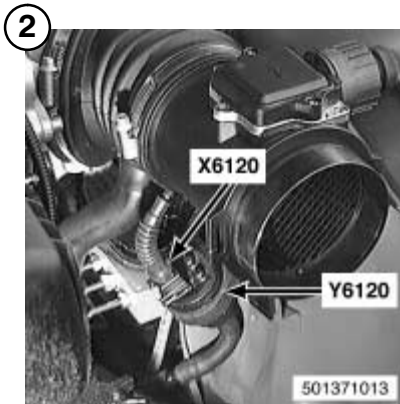

Y6120
EVAPORATIVE
EMISSION VALVE

X6120

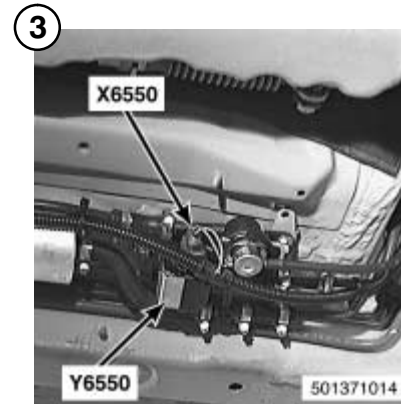

Y6550
SOLENOID VALVE
("RUNNING
LOSSES")

X6550

COMPONENT LOCATION VIEWS

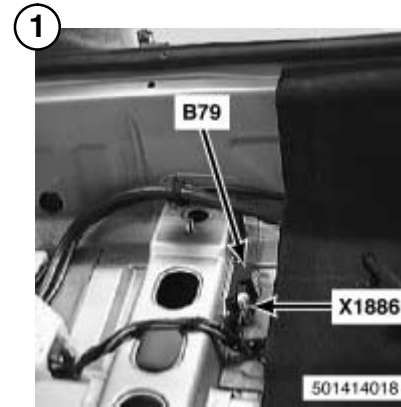
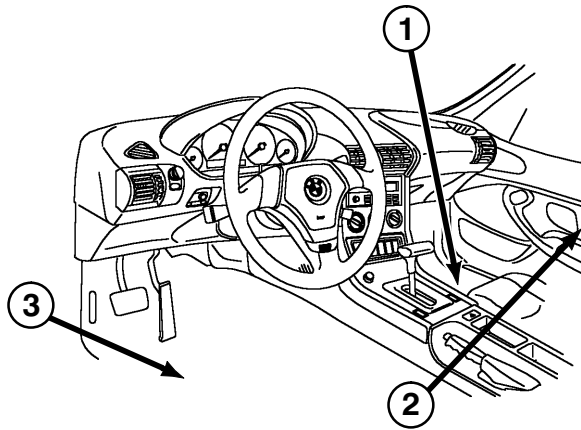

B79
PASSENGER'S
SIDE IMPACT
SENSOR

X1886

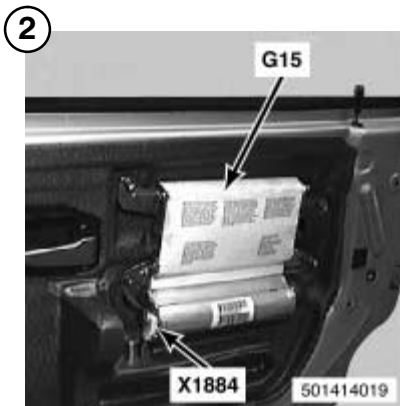

G15
RIGHT SIDE AIR
BAG GAS
GENERATOR

X1884

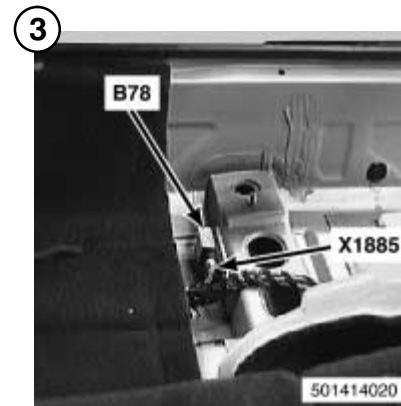

B78
DRIVER'S SIDE IM-
PACT SENSOR

X1885

COMPONENT LOCATION VIEWS

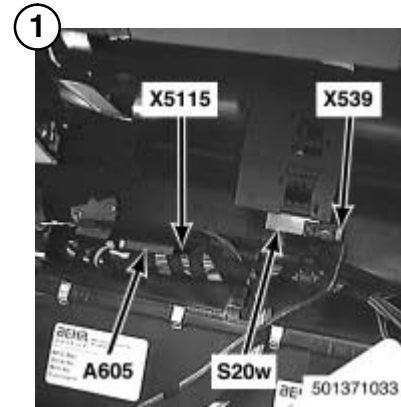
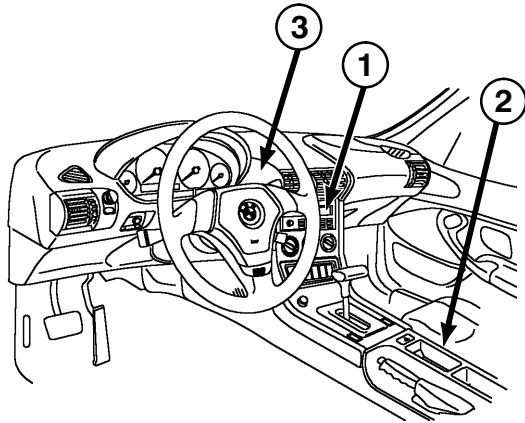

A605
FUSE HOLDER

S20w
RADIO ANTI-
THEFT SWITCH

X539
X5115

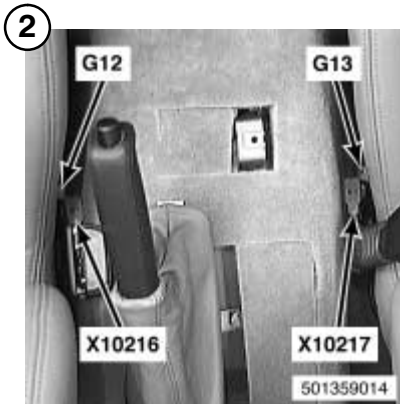

G12
DRIVER'S SIDE
PYROTECHNICAL
BELT TENSIONER

G13
PASSENGER'S
SIDE
PYROTECHNICAL
BELT TENSIONER

X10216
X10217

501359014

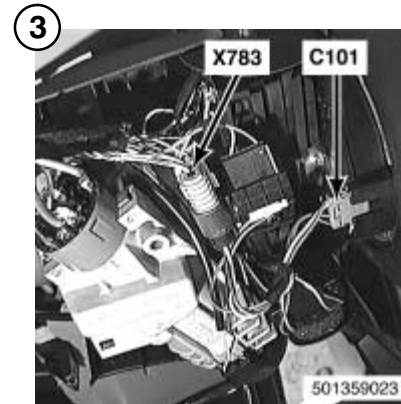

C101
CONTACT RING

X783

501359023

COMPONENT LOCATION VIEWS

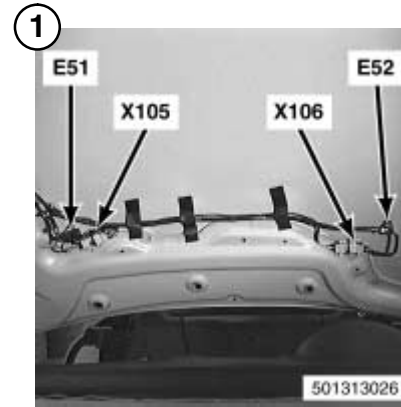
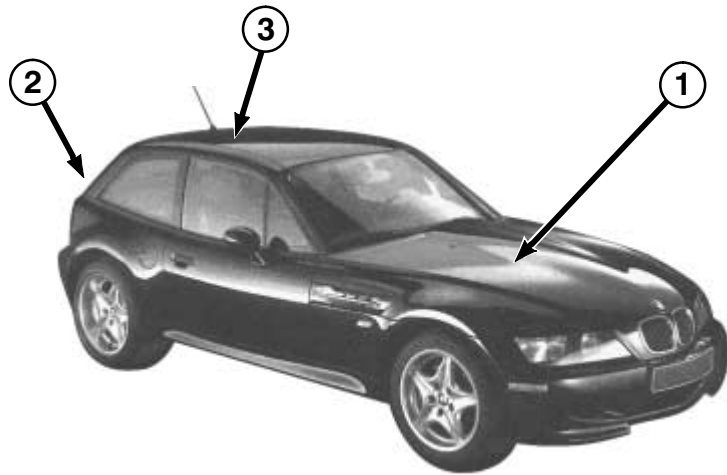

E51
LEFT WASHER JET
HEATER

E52
RIGHT WASHER
JET HEATER

X105
X106

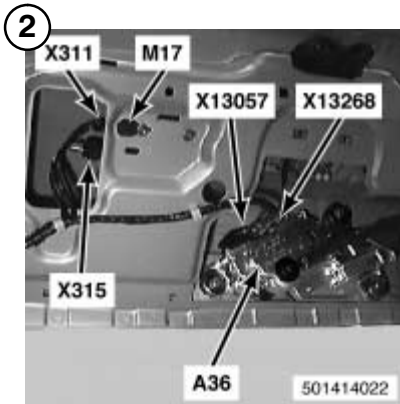

A36
REAR WIPER/
WASHER INTERVAL
CONTROL MODULE

M17
LUGGAGE
COMPARTMENT
LOCK MOTOR

X311
X315

X13057
X13268

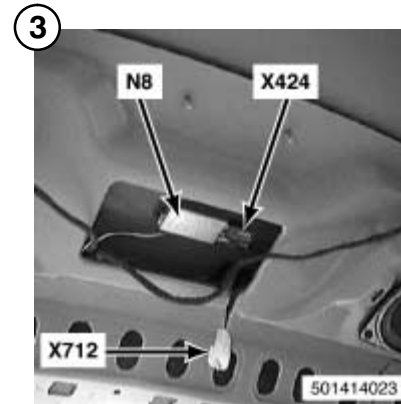

N8
ANTENNA
AMPLIFIER AM/FM

X424
X712

COMPONENT LOCATION VIEWS

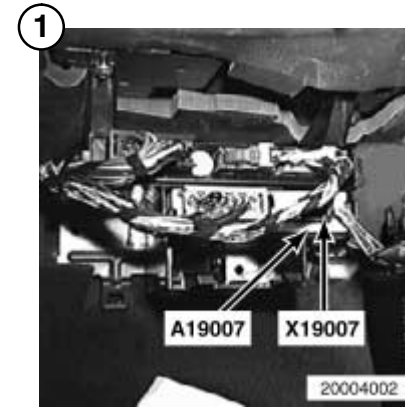
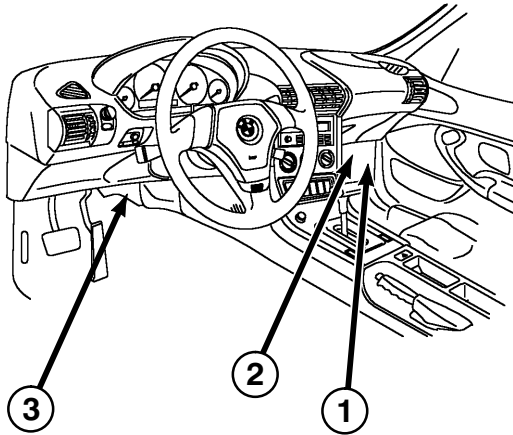

A19007
THERMAL OIL
LEVEL SENSOR
(TOENS) CONTROL
MODULE

X19007

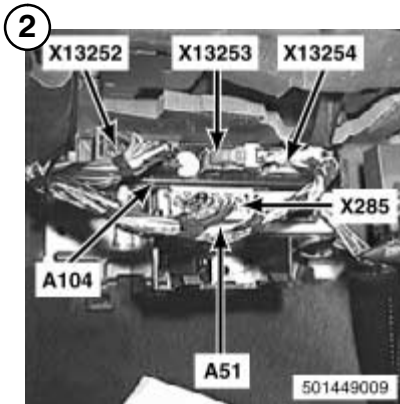

A51
WIPER/WASHER
MODULE

A104
BODY
ELECTRONICS
CONTROL MODULE
(ZKE IV)

X285
X13252
X13253
X13254

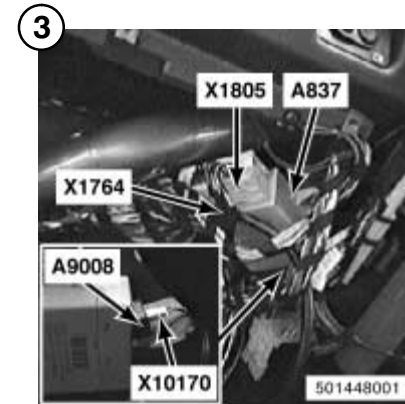

A837
ELECTRONIC
IMMOBILIZER
CONTROL MODULE
(EWS III)

A9008
CRUISE CONTROL
INTERFACE

X1764
X1805
X10170

COMPONENT LOCATION VIEWS

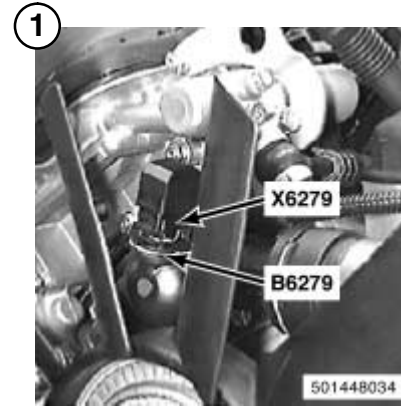
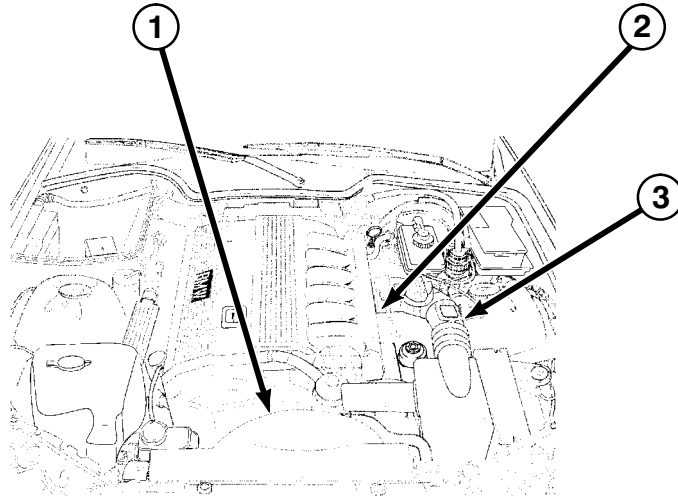

B6279
THERMOSTAT,
CHARACTERISTIC
MAP COOLING

X6279

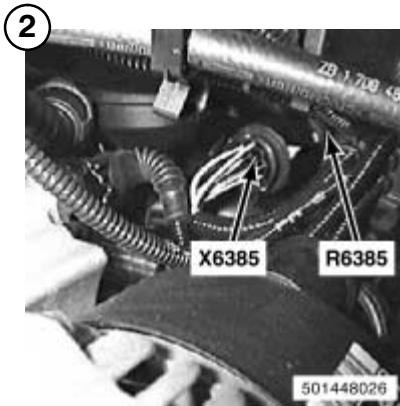

R6385
THROTTLE
POSITION SEN-
SOR/CRUISE
CONTROL
ACTUATOR

X6385

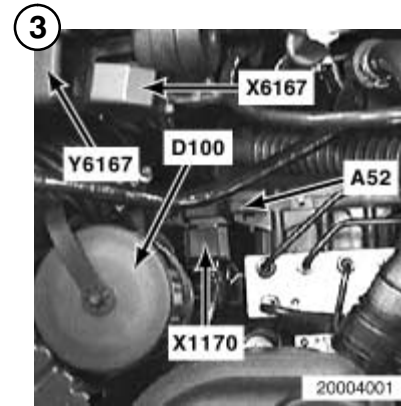

A52
SLIP CONTROL
MODULE
(ABS/ASC)

X1170
X6167

D100
DATA LINK
CONNECTOR

Y6167
VALVE, INDIVIDUAL
CONTROL INTAKE
SYSTEM

COMPONENT LOCATION VIEWS

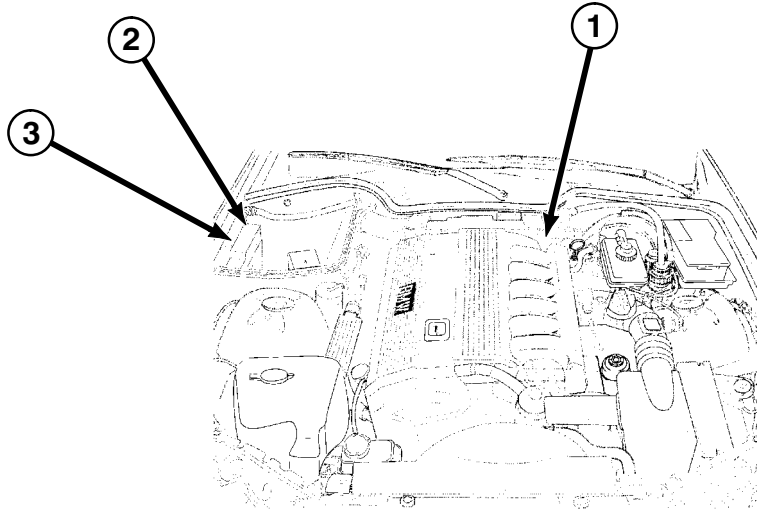

B6236
ENGINE COOLANT
TEMPERATURE
SENSOR

X6236

501449033

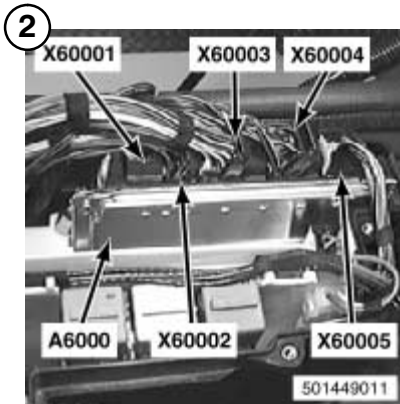

A6000
ENGINE CONTROL
MODULE (DME)

X60001
X60002
X60003
X60004
X60005

501449011

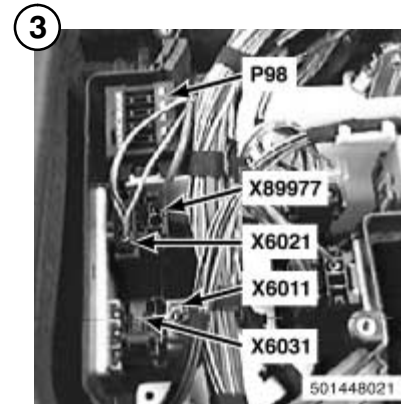

P98
FUSE HOLDER IN
E-BOX

X6011
X6021
X6031
X89977

501448021

COMPONENT LOCATION VIEWS

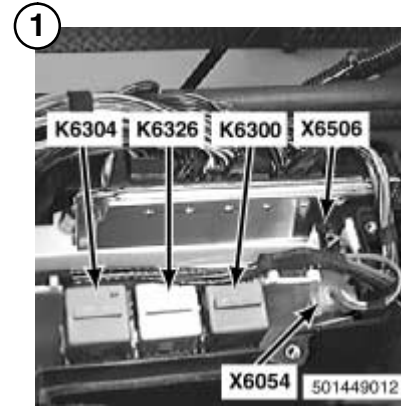
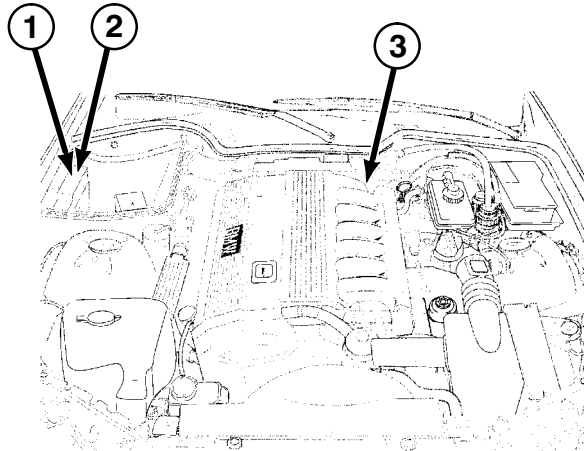

K6300 ENGINE CONTROL
MODULE RELAY

X6054
X6506

K6304
SECONDARY AIR
PUMP RELAY

K6326
UNLOADER RELAY,
TERMINAL 15

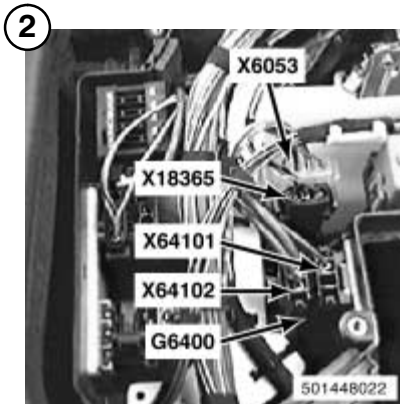

G6400
B+ JUNCTION
POINT E-BOX

X6053
X18365
X64101
X64102

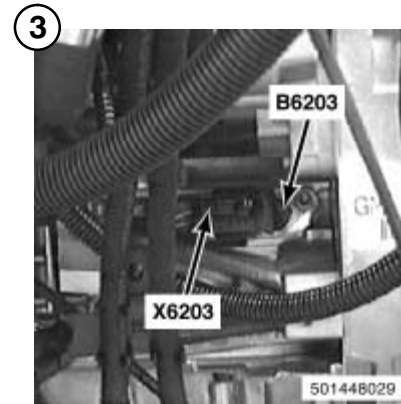

B6203
CRANKSHAFT
POSITION/RPM
SENSOR

X6203

COMPONENT LOCATION VIEWS

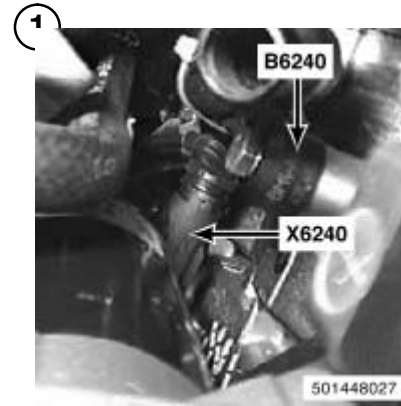
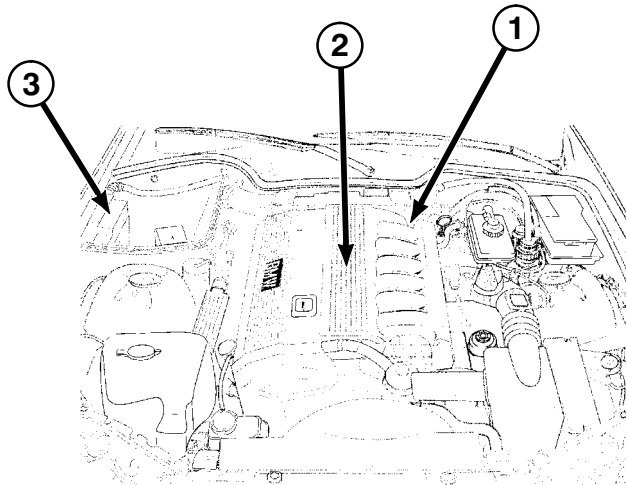

B6240
KNOCK SENSOR

X6240

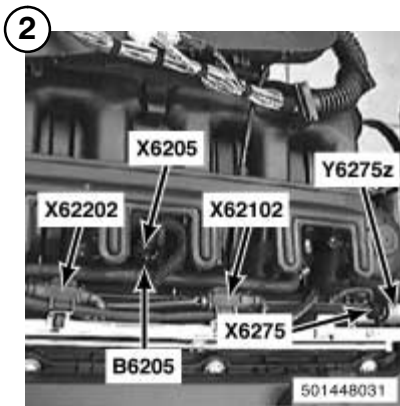

B6205
INTAKE AIR
TEMPERATURE
SENSOR

Y6275z
VARIABLE CAM-
SHAFT CONTROL
VALVE 1 (INLET)

X6205
X6275
X62102
X62202

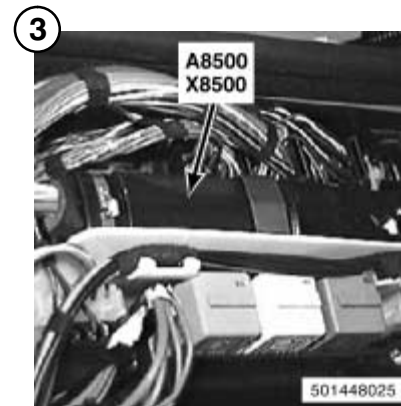

A8500
TRANSMISSION
CONTROL MODULE
(EGS)

X8500

COMPONENT LOCATION VIEWS

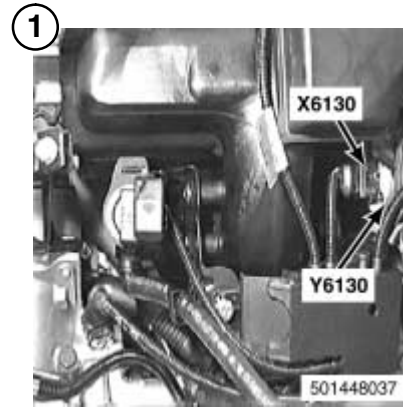
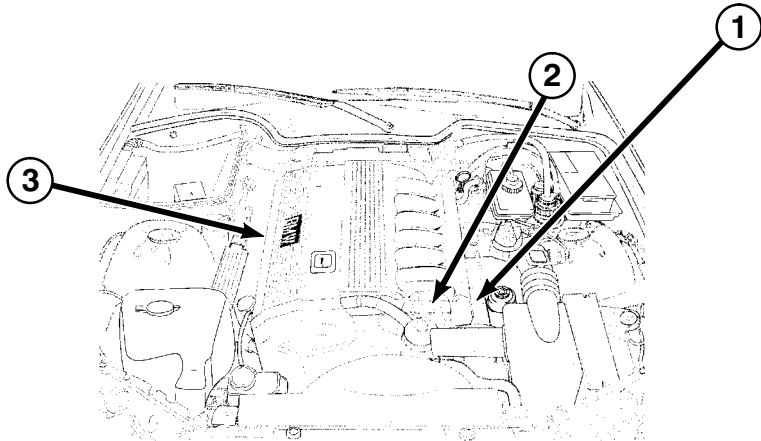

Y6130
IDLE SPEED
CONTROL VALVE

X6130



X6524

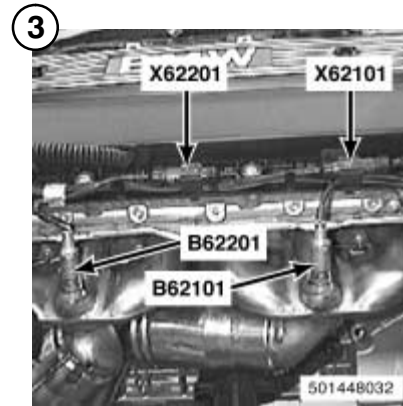

B62101
OXYGEN SENSOR I
(IN FRONT OF
CATALYTIC
CONVERTER)

B62201
OXYGEN SENSOR
II (IN FRONT OF
CATALYTIC
CONVERTER)

X62101
X62201

COMPONENT LOCATION VIEWS

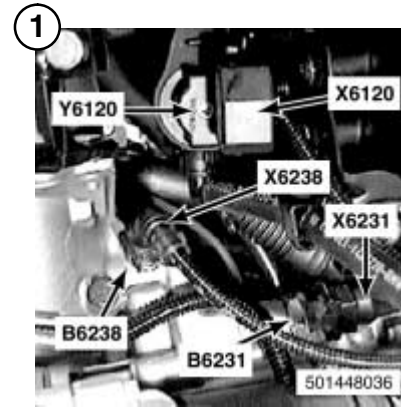
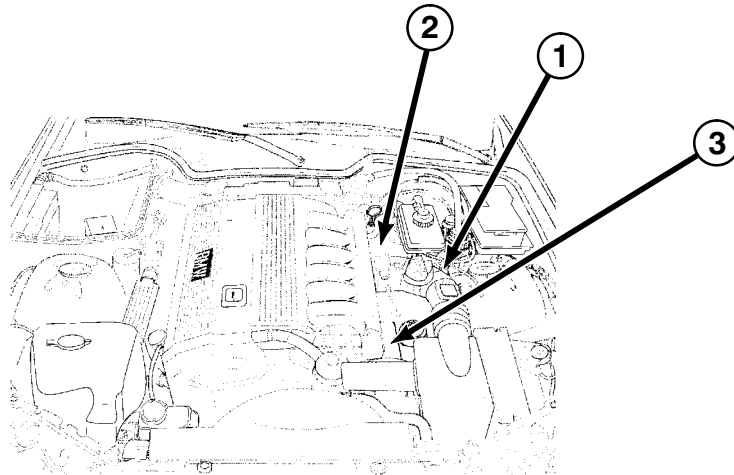

B6231
OIL PRESSURE
SWITCH

X6120
X6231
X6238

B6238
OIL TEMPERATURE
SENSOR

Y6120
EVAPORATIVE
EMISSION VALVE

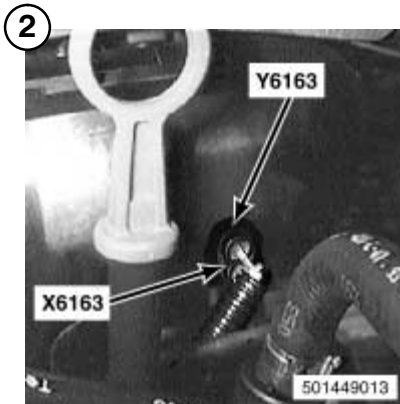

Y6163
SECONDARY AIR
PUMP VALVE

X6163

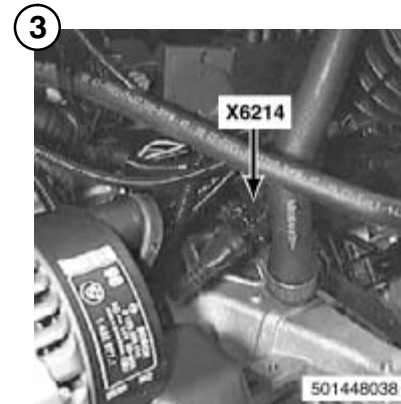

X6214

COMPONENT LOCATION VIEWS

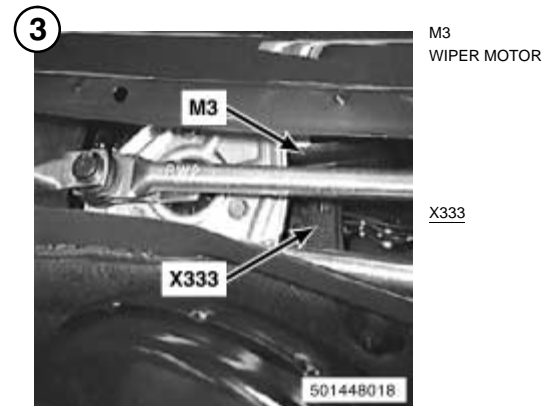
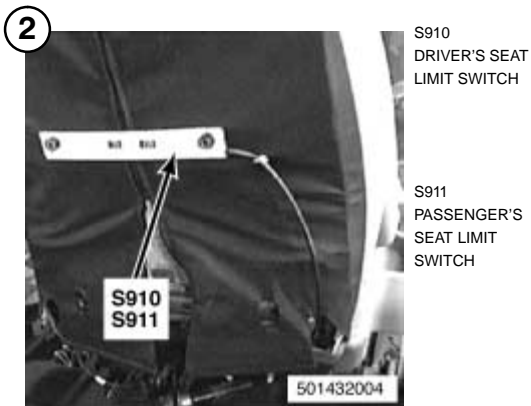
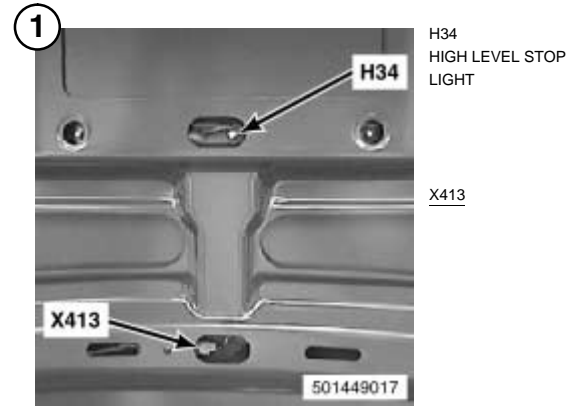
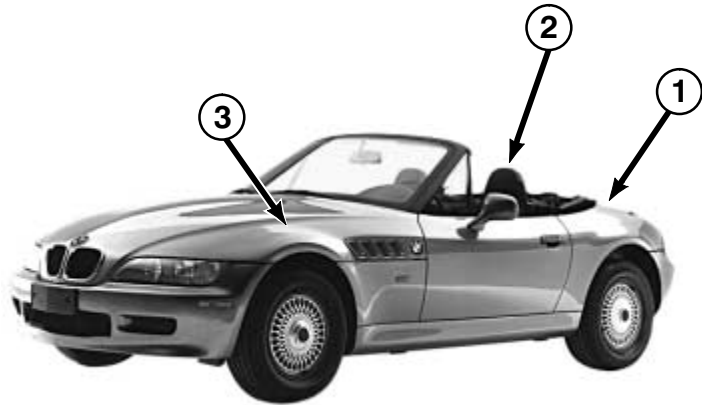

COMPONENT LOCATION VIEWS

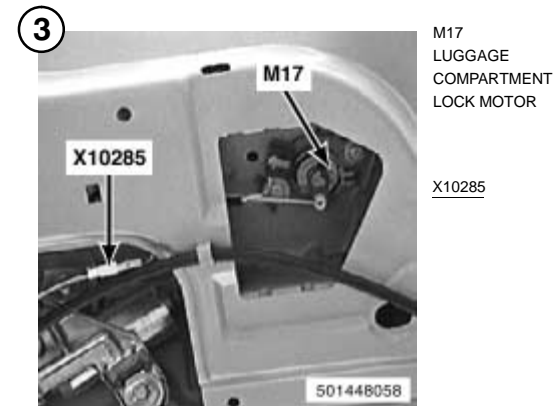
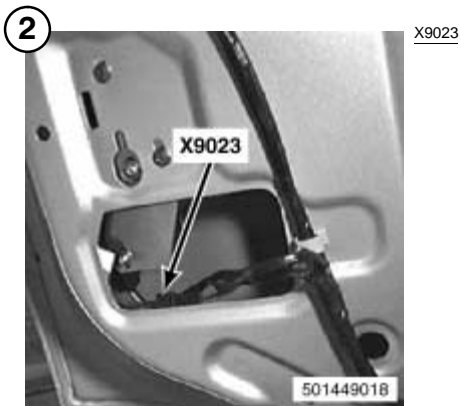
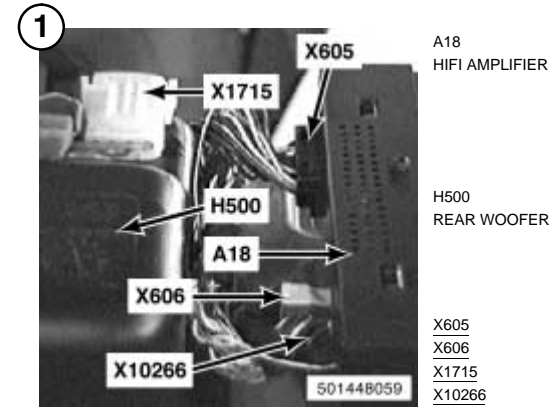

COMPONENT LOCATION VIEWS

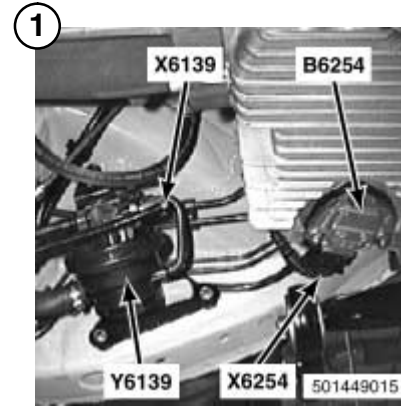
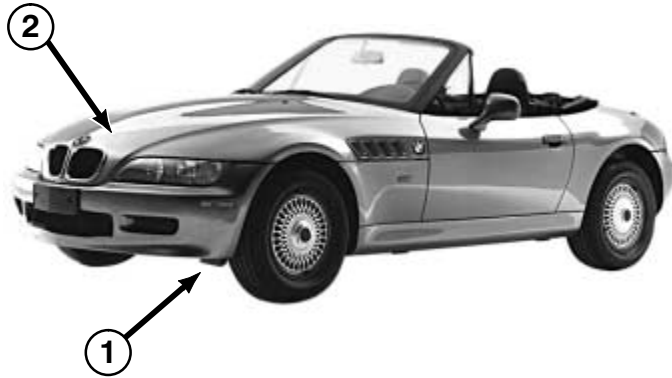

B6254
THERMAL OIL
LEVEL SWITCH

Y6139
LEAKAGE DIAGNO-
SIS PUMP

X6139
X6254

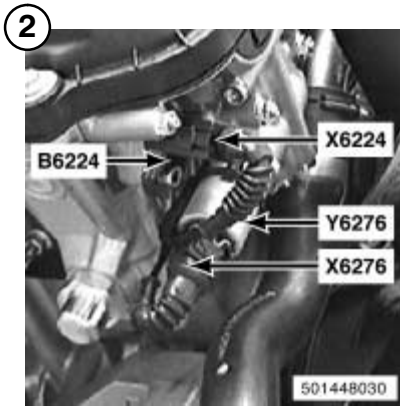

B6224
CAMSHAFT
POSITION SENSOR
2 (OUTLET)

Y6276
VARIABLE CAM-
SHAFT CONTROL
VALVE 2 (OUTLET)

X6224
X6276



8000.0 SPLICE LOCATION VIEWS

Z3

SPLICE	HARNESS	PAGE NUMBER	SPLICE	HARNESS	PAGE NUMBER
X181–X185	BODY	8000.0-03	X849–X851	DRIVER'S DOOR	8000.0-04
X188	BODY	8000.0-04	X876–X877	RADIO/HIFI/CD	NOT SHOWN
X189	IHKS	NOT SHOWN	X878–X888	BODY	8000.0-03
X191–X197	BODY	8000.0-04	X942	PASSENGER'S DOOR	8000.0-04
X203	BODY	8000.0-03	X985	IHKS	NOT SHOWN
X213	BODY	8000.0-04	X1015–X1019	BODY	8000.0-03
X216–X223	BODY	8000.0-03	X1022–X1027	BODY	8000.0-03
X245–X246	BODY	8000.0-03	X1028–X1029	BODY	8000.0-04
X276	BODY	8000.0-03	X1036–X1047	BODY	8000.0-03
X443	BODY	8000.0-03	X1055	BODY	8000.0-04
X445	BODY	8000.0-03	X1066–X1076	BODY	8000.0-03
X449	BODY	8000.0-04	X1079	BODY	8000.0-04
X450	BODY	8000.0-03	X1091	BODY	8000.0-04
X453–X465	BODY	8000.0-04	X1100–X1115	BODY	8000.0-03
X470	BODY	8000.0-03	X1152–X1164	BODY	8000.0-03
X530	BODY	8000.0-03	X1168–X1169	BODY	8000.0-03
X576–X595	BODY	8000.0-03	X1182	BODY	8000.0-04
X697–X699	BODY	8000.0-03	X1186	BODY	8000.0-03
X704	CONSOLE INSTRUMENTS	NOT SHOWN	X1214	BODY	8000.0-03
X805	BODY	8000.0-04	X1225	BODY	8000.0-04
X806	BODY	8000.0-03	X1234–X1235	BODY	8000.0-04
X814–X818	IHKS	NOT SHOWN	X1236	BODY	8000.0-03
X824–X830	RADIO/HIFI/CD	NOT SHOWN	X1258	BODY	8000.0-03

03/00

8000.0-00

1999



SPLICE LOCATION VIEWS

SPLICE	HARNESS	PAGE NUMBER	SPLICE	HARNESS	PAGE NUMBER
X1263	BODY	8000.0-04	X6832–X6836	M52 ENGINE (Z3 VERSIONS)	8000.0-05
X1264	BODY	8000.0-03	X6863–X6868	S52 ENGINE (M VERSIONS)	8000.0-06
X1280	BODY	8000.0-03	X6900	M52 ENGINE (Z3 VERSIONS)	8000.0-05
X1429–X1435	IHKS	NOT SHOWN	X6960–X6965	M52 ENGINE (Z3 VERSIONS)	8000.0-05
X1608	BODY	8000.0-04	X8000–X8015	S52 ENGINE (M VERSIONS)	8000.0-06
X1610–X1616	BODY	8000.0-03	X8038–X8051	S52 ENGINE (M VERSIONS)	8000.0-06
X1617–X1618	BODY	8000.0-04	X8071–X8074	S52 ENGINE (M VERSIONS)	8000.0-06
X1620–X1625	BODY	8000.0-03	X8073	M52 ENGINE (Z3 VERSIONS)	8000.0-05
X1682	BODY	8000.0-03	X8103	S52 ENGINE (M VERSIONS)	8000.0-06
X1683–X1894	BODY	8000.0-03	X8564–X8565	M52 ENGINE (Z3 VERSIONS)	8000.0-05
X1893–X1894	BODY	8000.0-03	X9454	BODY	8000.0-03
X2233	BODY	8000.0-03	X9806	CONSOLE INSTRUMENTS	NOT SHOWN
X6411–X6415	S52 ENGINE (M VERSIONS)	8000.0-06	X9992–X9993	DRIVER'S SEAT	NOT SHOWN
X6420	S52 ENGINE (M VERSIONS)	8000.0-06	X9996–X9997	PASSENGER'S SEAT	NOT SHOWN
X6458	M52 ENGINE (Z3 VERSIONS)	8000.0-05	X10008	BODY	8000.0-03
X6458–X6460	S52 ENGINE (M VERSIONS)	8000.0-06	X10009	BODY (Z3 VERSIONS)	8000.0-03
X6460	M52 ENGINE (Z3 VERSIONS)	8000.0-05	X10009	BODY (M VERSIONS)	8000.0-04
X6475	S52 ENGINE (M VERSIONS)	8000.0-06	X10014–X10048	BODY	8000.0-03
X6492	S52 ENGINE (M VERSIONS)	8000.0-06	X10064	BODY	8000.0-04
X6810	S52 ENGINE (M VERSIONS)	8000.0-06	X10126	BODY	8000.0-03
X6820–X6822	S52 ENGINE (M VERSIONS)	8000.0-06	X10189	BODY	8000.0-03
X6830–X6835	S52 ENGINE (M VERSIONS)	8000.0-06	X10464	RADIO/HIFI	NOT SHOWN
X6849	S52 ENGINE (M VERSIONS)	8000.0-06	X10468–X10469	BODY	8000.0-03



Z3

SPLICE LOCATION VIEWS

SPLICE	HARNESS	PAGE NUMBER
X11212	BODY	8000.0-03
X11264	BODY	8000.0-03
X11291	BODY	8000.0-04
X11337–X11353	BODY	8000.0-03
X11355	BODY	8000.0-04
X11357	BODY	8000.0-03
X13007	BODY	8000.0-03
X13011–X13047	BODY	8000.0-04
X13134	BODY	8000.0-03
X13304	BODY	8000.0-04
X13281	BODY	8000.0-03
X18061	BODY	8000.0-03
X18510	BODY	8000.0-03
X19513	RADIO/HIFI/CD	NOT SHOWN
X19525–X19526	BODY	8000.0-03
X64109	BODY	8000.0-03
X64119	BODY	8000.0-03
X64129	BODY	8000.0-03
X64591	BODY (Z3 VERSIONS)	8000.0-03
X64591	BODY (M VERSIONS)	8000.0-04
X68309	IHKS	NOT SHOWN

SPLICE LOCATION VIEWS
BODY HARNESS

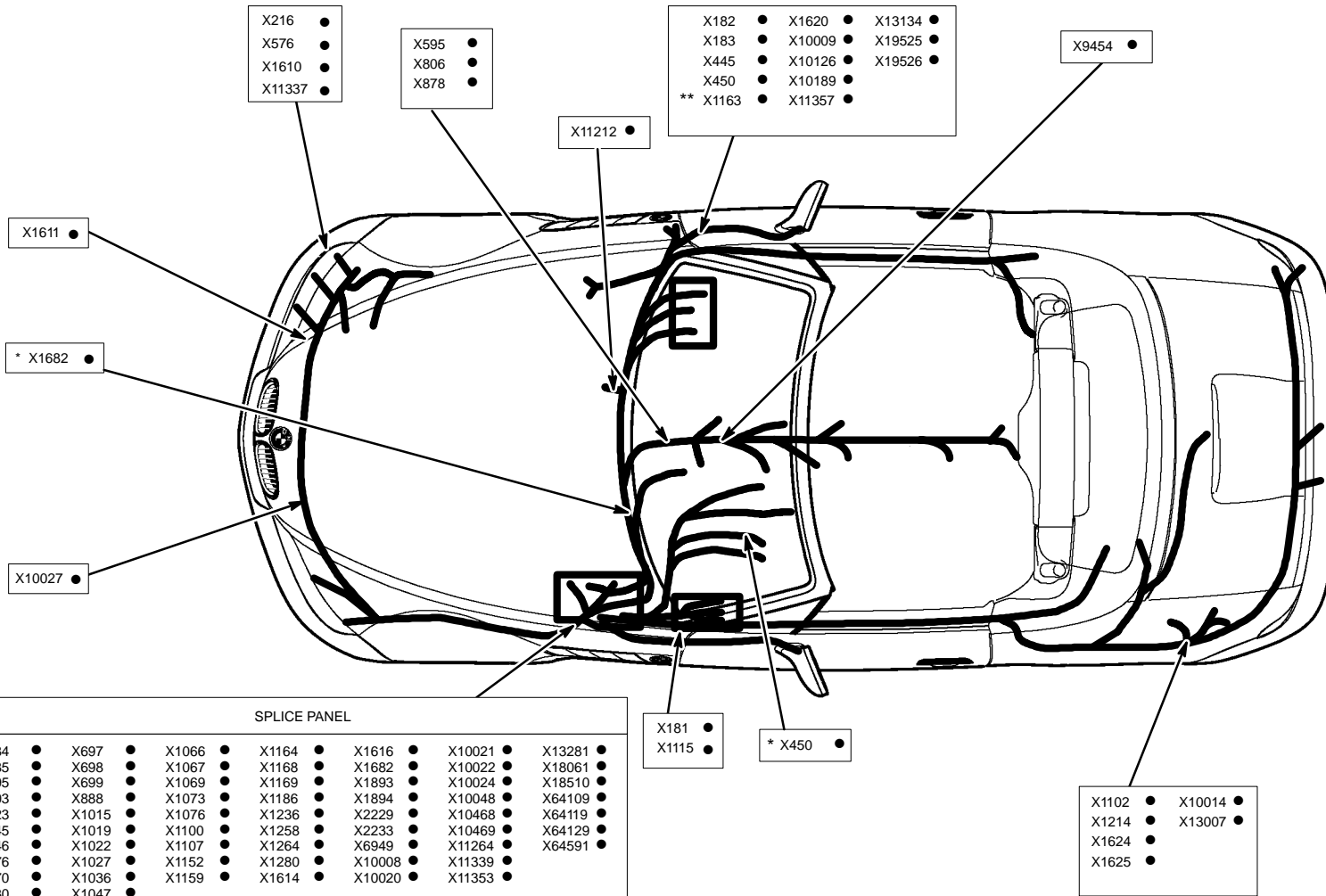

SPLICE PANEL							
X184	●	X697	●	X1066	●	X1164	●
X185	●	X698	●	X1067	●	X1168	●
X195	●	X699	●	X1069	●	X1169	●
X203	●	X888	●	X1073	●	X1186	●
X223	●	X1015	●	X1076	●	X1236	●
X245	●	X1019	●	X1100	●	X1258	●
X246	●	X1022	●	X1107	●	X1264	●
X276	●	X1027	●	X1152	●	X1280	●
X470	●	X1036	●	X1159	●	X1614	●
X530	●	X1047	●				
				X1166	●	X1616	●
				X1168	●	X1682	●
				X1169	●	X1893	●
				X1186	●	X1894	●
				X1236	●	X2229	●
				X1258	●	X2233	●
				X1264	●	X6949	●
				X1280	●	X10008	●
				X1614	●	X10020	●
						X10021	●
						X10022	●
						X10024	●
						X10468	●
						X10469	●
						X11264	●
						X11339	●
						X11353	●
						X13281	●
						X18061	●
						X18510	●
						X64109	●
						X64119	●
						X64129	●
						X64591	●

**

* Z3 VERSIONS
** M VERSIONS

SPLICE LOCATION VIEWS
BODY HARNESS

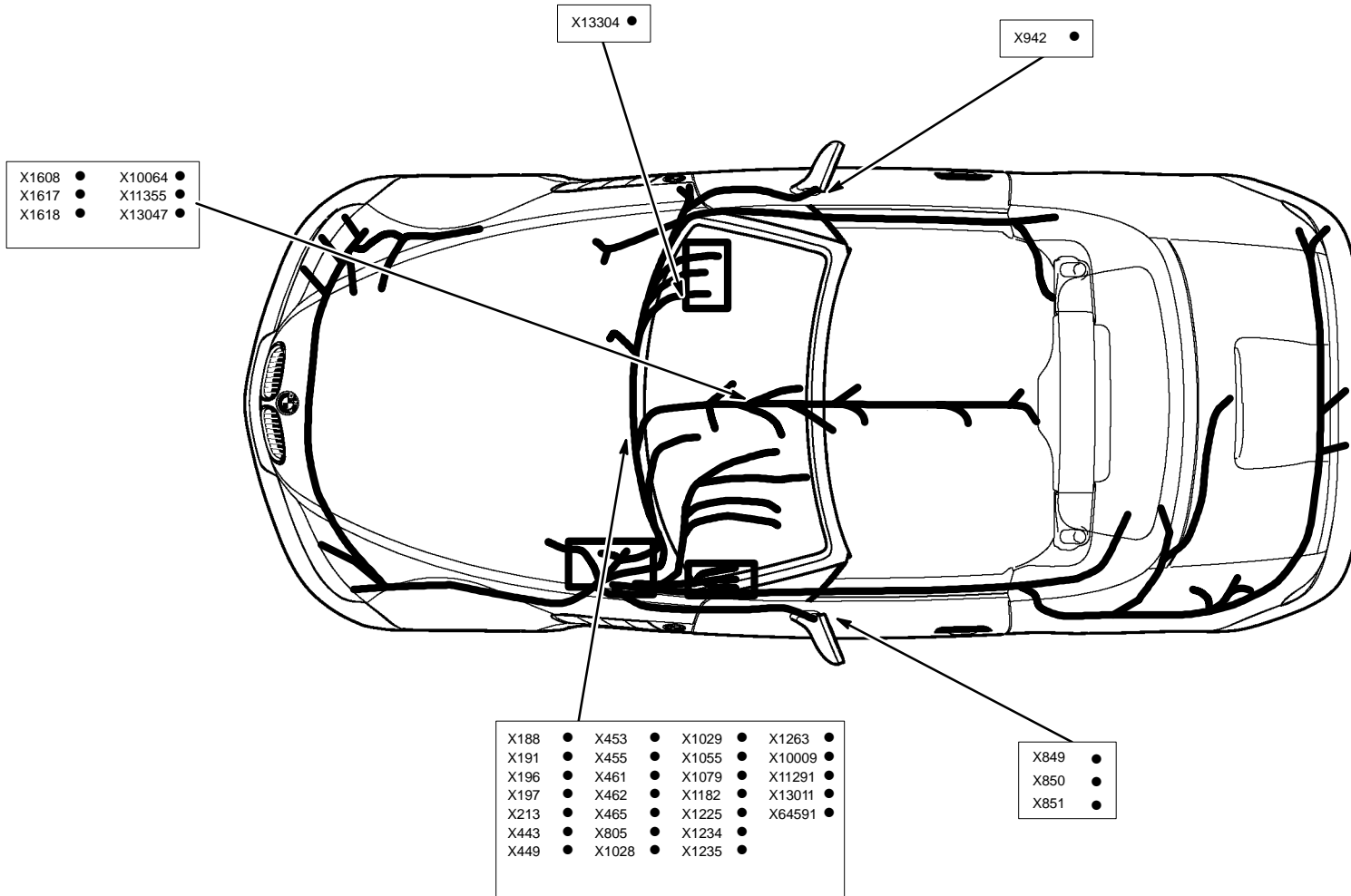



Z3

SPLICE LOCATION VIEWS

ENGINE HARNESS M52

Z3 VERSIONS

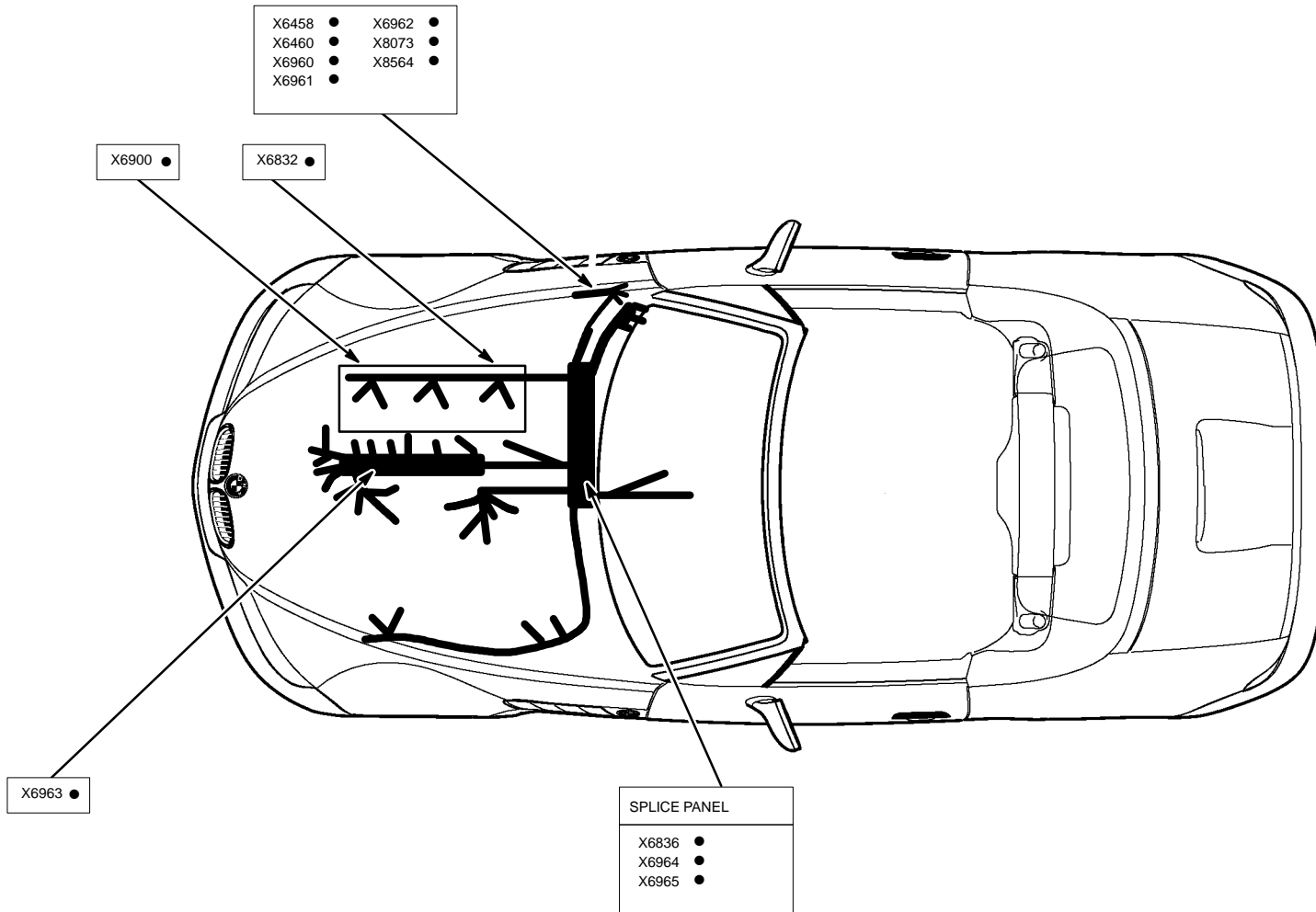



SPLICE LOCATION VIEWS

ENGINE HARNESS S52

M VERSIONS

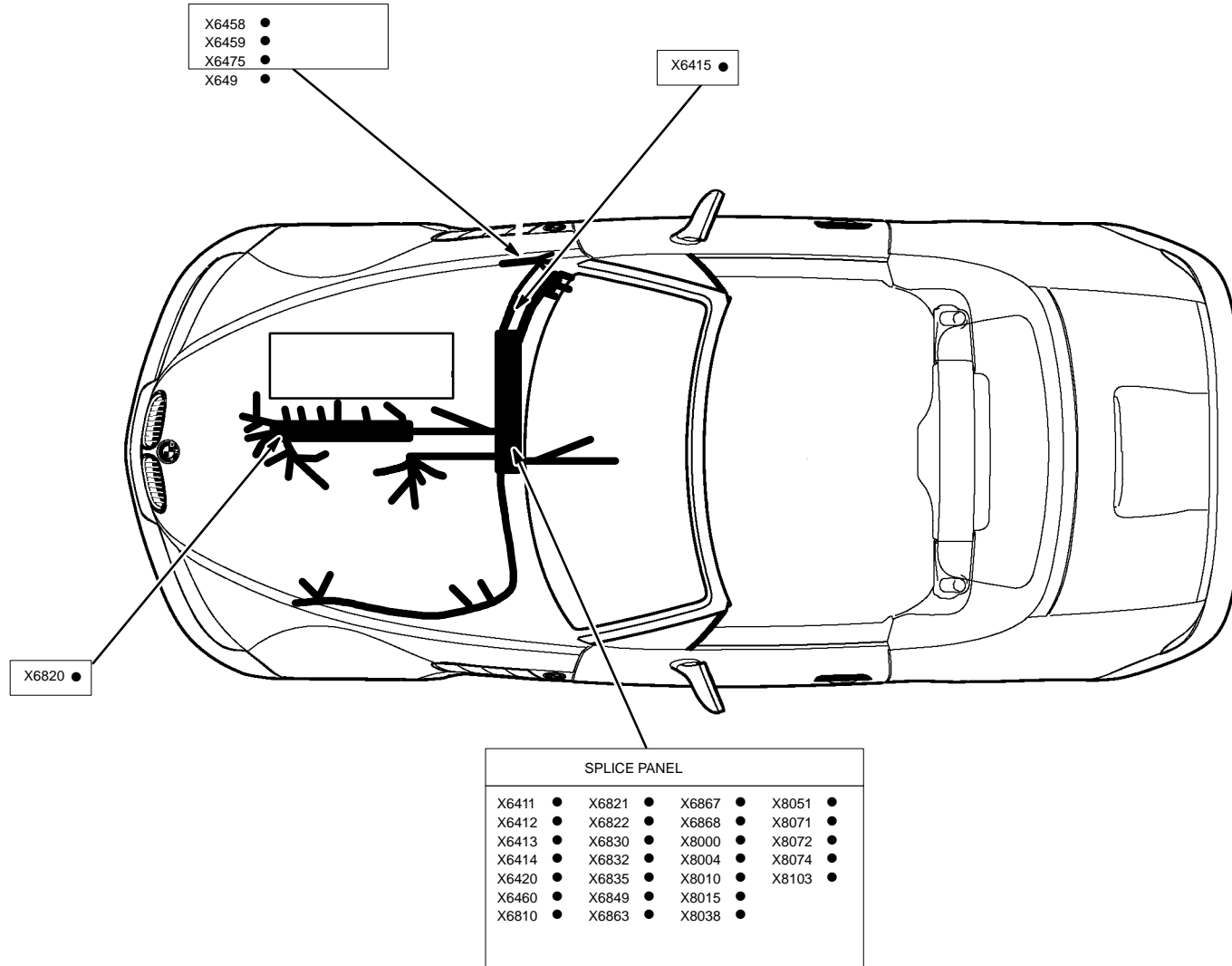



Z3

8500.0 CONNECTOR VIEWS

FIG. 1

B880001.00

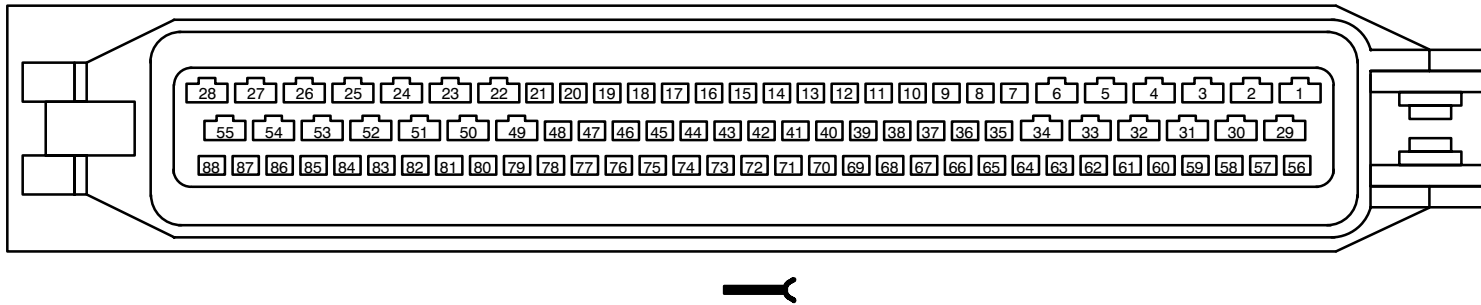

FIG. 2

B040030.00

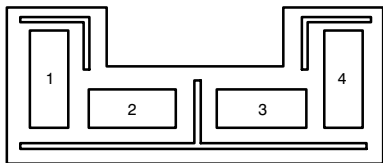
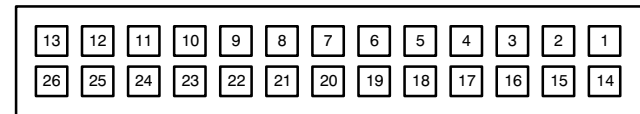

FIG. 3

B260005.00





CONNECTOR VIEWS

Z3

FIG. 1

B030024

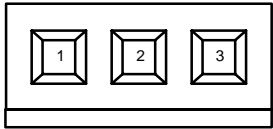

FIG. 2

B030046.00

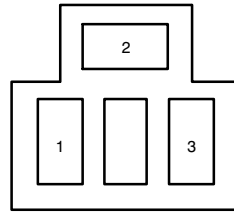

FIG. 3

B120001.01

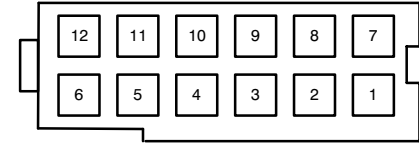

FIG. 4

B090008.00

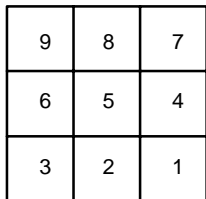

FIG. 5

B120002.02

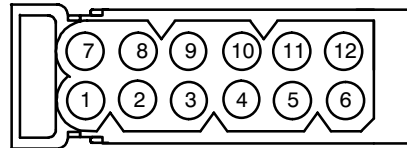
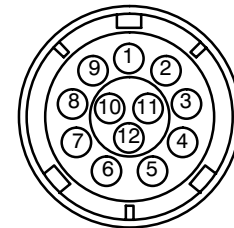

FIG. 6

B120015



03/00

8500.0-01

1999

FIG. 1

B080002.00

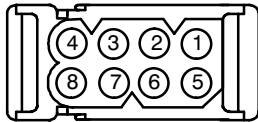

FIG. 2

B170001.00

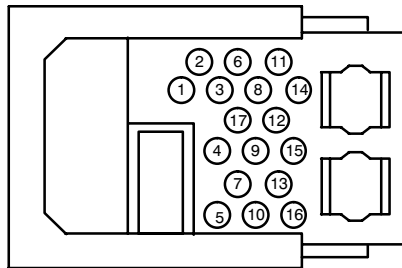

FIG. 3

B100008.00

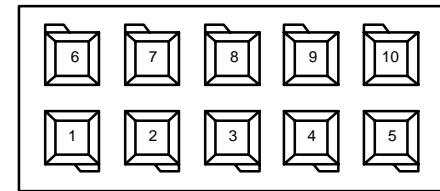

FIG. 4

B120004.01

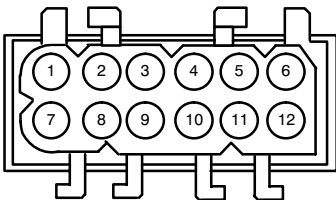

FIG. 5

B030004.01

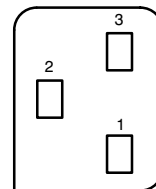

FIG. 6

B050003.00

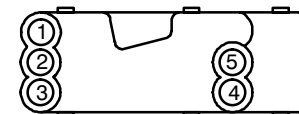

FIG. 1

B040004.00

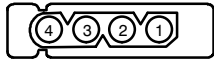

FIG. 2

B520001.00

52	51	50	49	48	47	46	45	44	43	42	41	40
39	38	37	36	35	34	33	32	31	30	29	28	27
26	25	24	23	22	21	20	19	18	17	16	15	14
13	12	11	10	9	8	7	6	5	4	3	2	1



FIG. 3

B080001.00

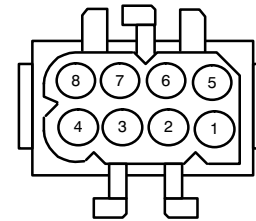

FIG. 4

B090002.00

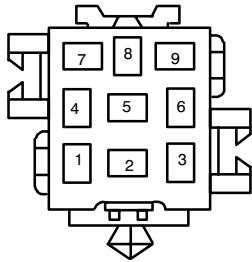

FIG. 5

B260002.01

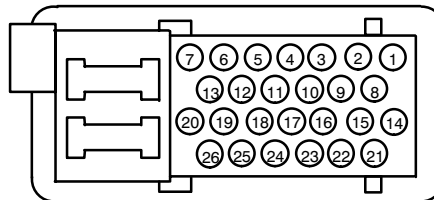
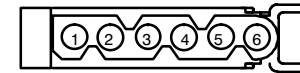

FIG. 6

B060001.02





CONNECTOR VIEWS

Z3

FIG. 1

B200003.00

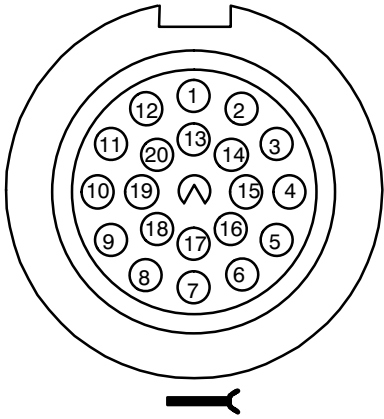

FIG. 2

B240002.00

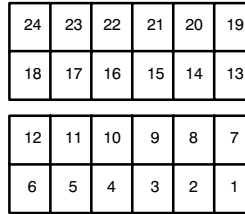

FIG. 3

B030003.00



FIG. 4

B250001.02

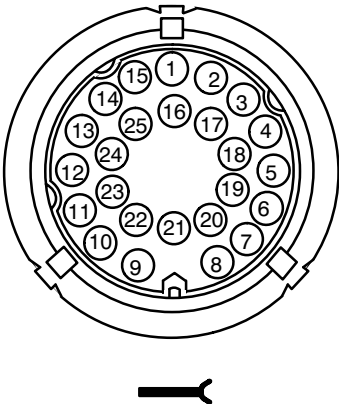

FIG. 5

B060019.03

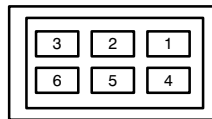
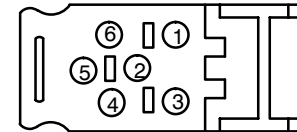

FIG. 6

B060036.00



CONNECTOR VIEWS

FIG. 1

B150002.00

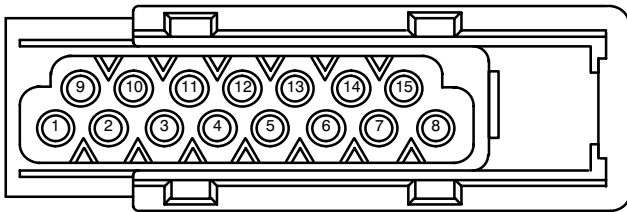

FIG. 2

B100014.00

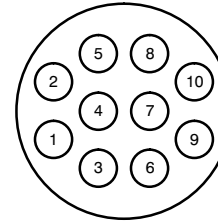

FIG. 3

B060038.00

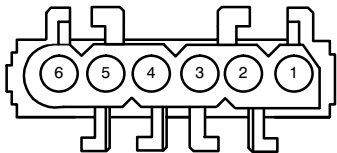

FIG. 4

B040027.00

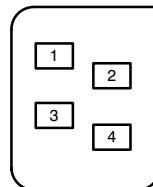
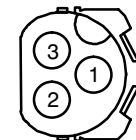

FIG. 5

B030006.00



CONNECTOR VIEWS

FIG. 1

B0400028.00

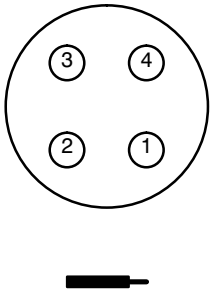

FIG. 2

B080020.00

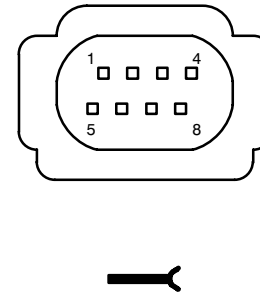

FIG. 3

B0300044.00

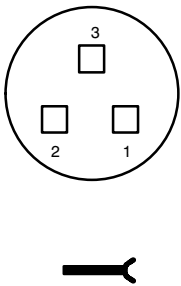

FIG. 4

B030049.00

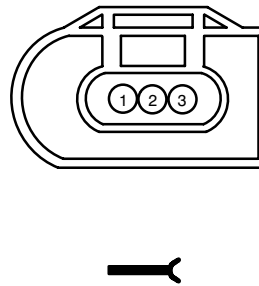

FIG. 5

B060041.00

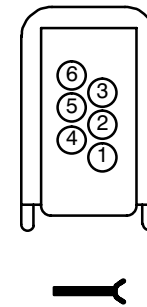

FIG. 1

B040026

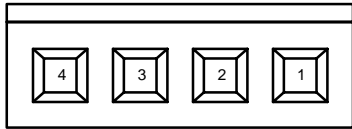

FIG. 2

B120006.00

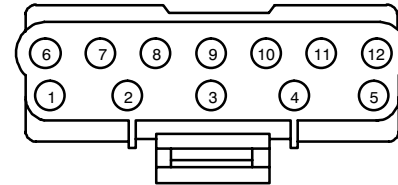

FIG. 3

B180000.00

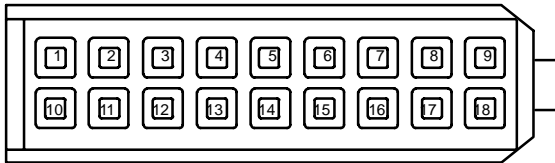

FIG. 4

B060037.00

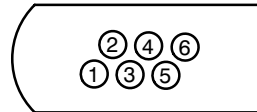
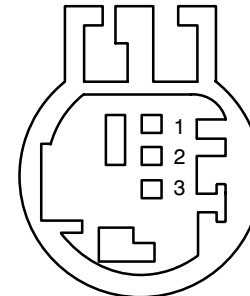

FIG. 5

B030042.00





CONNECTOR VIEWS

Z3

FIG. 1

B160002.00

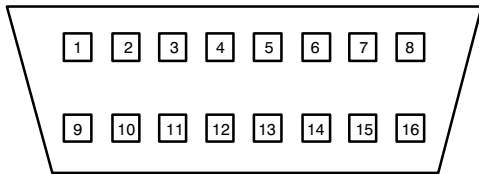

FIG. 2

B060013.00

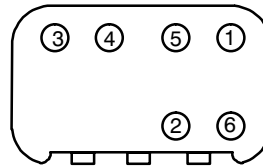

FIG. 3

B080013.00

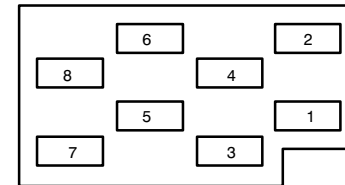
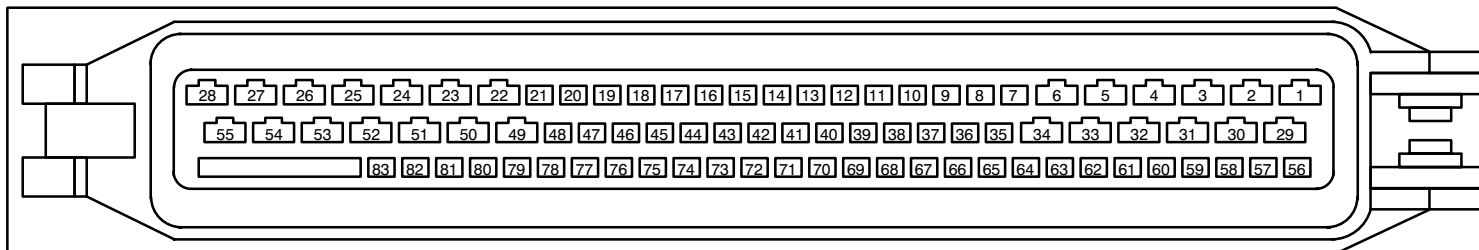

FIG. 4

B830001.00





Z3

CONNECTOR VIEWS

FIG. 1

B400000.00

31	32	33	34	35	36	37	38	39	40
21	22	23	24	25	26	27	28	29	30
11	12	13	14	15	16	17	18	19	20
1	2	3	4	5	6	7	8	9	10



FIG. 2

B060043.00

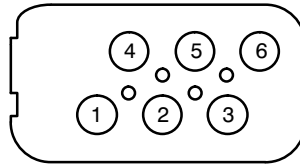

FIG. 3

B070012.00

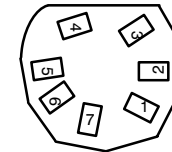

FIG. 4

B250004.00

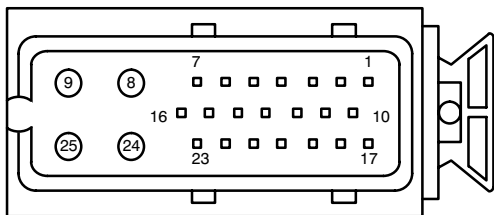
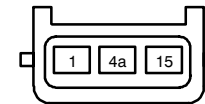

FIG. 5

B030015.08





CONNECTOR VIEWS

Z3

FIG. 1

B030048a

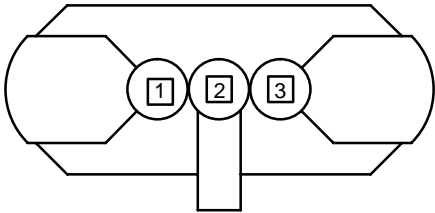

FIG. 2

B030018.02

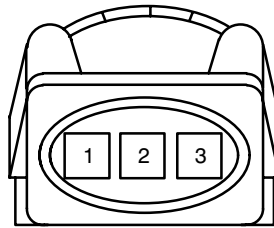

FIG. 3

B040023.02

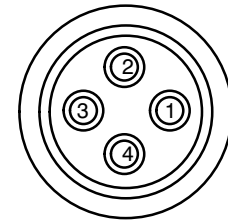

FIG. 4

B040023.01

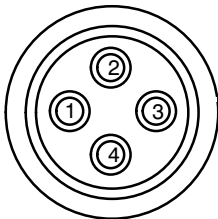
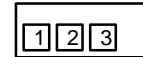

FIG. 5

B030036.01





CONNECTOR VIEWS

Z3

FIG. 1

B030022.00

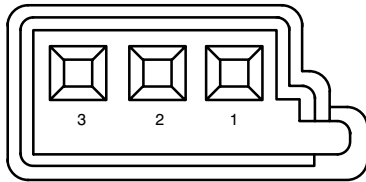

FIG. 2

B500000.00

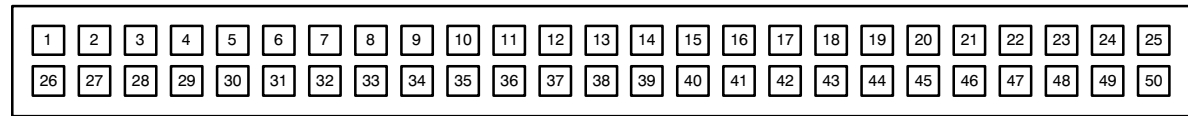

FIG. 3

B060042

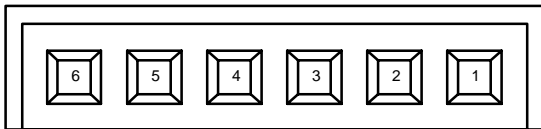

FIG. 4

B160001.00

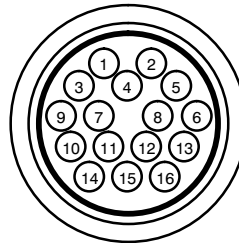
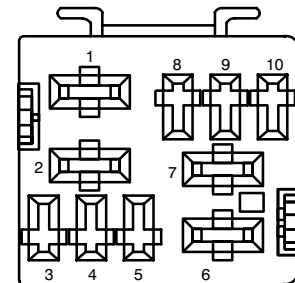

FIG. 5

B100004.02



Free Manuals Download Website

<http://myh66.com>

<http://usermanuals.us>

<http://www.somanuals.com>

<http://www.4manuals.cc>

<http://www.manual-lib.com>

<http://www.404manual.com>

<http://www.luxmanual.com>

<http://aubethermostatmanual.com>

Golf course search by state

<http://golfingnear.com>

Email search by domain

<http://emailbydomain.com>

Auto manuals search

<http://auto.somanuals.com>

TV manuals search

<http://tv.somanuals.com>