

Rider's Manual (US Model)

K 1300 S

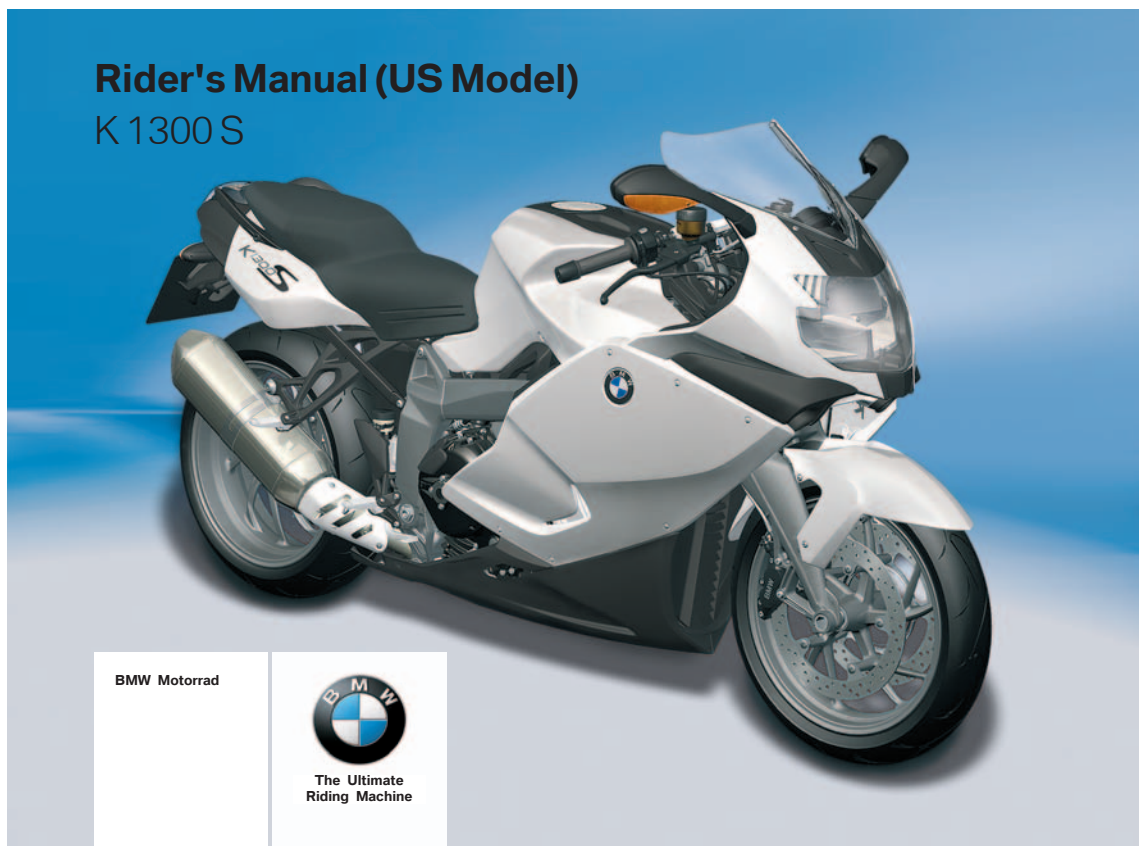

BMW Motorrad



The Ultimate
Riding Machine

Motorcycle/Retailer Data

Motorcycle data

Model

Vehicle Identification Number

Color number

First registration

Registration number

Retailer Data

Contact in Service

Ms./Mr.

Phone number

Retailer's address/phone number (company stamp)

Details described or illustrated in this booklet may differ from the motorcycle's actual specification as purchased, the accessories fitted or the national-market specification. No claims will be entertained as a result of such discrepancies.

Dimensions, weights, fuel consumption and performance data are quoted to the customary tolerances.

The right to modify designs, equipment and accessories is reserved.

Errors and omissions excepted.

© 2008 BMW Motorrad

Not to be reproduced either wholly or in part without written permission from BMW Motorrad, After Sales.

Printed in Germany.

The most important data for a filling station stop can be found in the following chart.

Fuel	
Recommended fuel quality	98 ROZ/RON, Super Plus unleaded 95 ROZ/RON, Super unleaded (fuel type can be used with reduced performance and consumption)
Usable fuel quantity	Approx. 5 gal (Approx. 19 l)
Reserve fuel quantity	≥1.1 gal (≥4 l)
Tire inflation pressure	
Tire pressure, front	36.3 psi (2.5 bar), Single rider, with cold tire 36.3 psi (2.5 bar), Driver with passenger and/or load, with cold tire
Tire pressure, rear	42.1 psi (2.9 bar), Single rider, with cold tire 42.1 psi (2.9 bar), Driver with passenger and/or load, with cold tire

BMW recommends 

Order No.: 01 41 7 714 427
09.2008, 1st Edition



Welcome to BMW

We congratulate you on your choice of a motorcycle from BMW and welcome you to the community of BMW riders.

Familiarize yourself with your new motorcycle so that you can ride it safely and confidently in all traffic situations.

Please read this Rider's Manual carefully before starting to use your new BMW motorcycle. It contains important information on how to operate the controls and how to make the best possible use of all your BMW's technical features.

In addition, it contains information on maintenance and care to help you maintain your motorcycle's reliability and safety, as well as its value.

If you have any questions concerning your motorcycle, your authorized BMW Motorrad retailer

is always happy to provide advice and assistance.

We wish you many miles of safe and enjoyable riding

BMW Motorrad.

Table of Contents

You can also use the index at the end of this Rider's Manual to find a specific topic.

1 General instructions	5	3 Status indicators	19	Odometer and	
Overview	6	Standard displays	20	tripmeters	49
Abbreviations and		Displays with onboard com-		Onboard computer	51
symbols	6	puter	21	Tire Pressure Control	
Equipment	7	Displays with Tire Pressure		RDC	54
Technical data	7	Control RDC	21	Lights	55
Currentness of this manu-		Displays with heated hand		Turn indicators	56
al	7	grips.....	22	Hazard warning flashers	56
2 Overviews	9	Standard warning indica-		Emergency ON/OFF	
General view, left side	11	tors.....	22	switch	57
General view, right side	13	Warning indicators of on-		BMW Motorrad Integral	
Left handlebar fitting	14	board computer	29	ABS	58
Handlebar fitting, right.....	15	ABS warning indicators	31	Automatic Stability Control	
Underneath seat	16	ASC warning indicators	34	ASC	59
Instrument cluster	17	RDC warning indicators	36	Heated hand grips	60
Headlight.....	18	Anti-theft alarm warning indi-		Clutch	61
		cators	41	Brakes	61
		4 Operation	45	Mirrors	62
		Ignition switch and steering		Spring preload	62
		lock	46	Damping	63
		Electronic immobilizer		Electronic suspension ad-	
		EWS	47	justment ESA	63
		Clock.....	48	Tires	65
				Headlight.....	66

Seat	67	7 Accessories	91	9 Care	131
Helmet holder	68	General instructions	92	Care products	132
Luggage loops	68	Onboard socket	92	Washing your motorcycle.....	132
5 Riding	69	Luggage	93	Cleaning sensitive motorcycle-	132
Safety instructions	70	Case	94	cle parts	132
Checklist	71	Flat tire kit	96	Paint care	133
Starting	72	8 Maintenance	99	Protective wax coating	134
Running in	74	General instructions	100	Storing motorcycle	134
Shifting gear	75	Toolkit	100	Returning motorcycle to	134
Brakes	76	Engine oil	101	use	134
Parking your motorcycle	77	Brake system	102	10 Technical data	135
Refueling	79	Brake pads	102	Troubleshooting chart	136
Securing motorcycle for		Brake fluid	104	Threaded fasteners	137
transport	80	Clutch	106	Engine	139
6 Technology in		Tires	107	Fuel	140
detail	83	Rims	107	Engine oil	140
Brake system with BMW		Wheels	108	Clutch	141
Motorrad Integral ABS	84	Front wheel stand	116	Transmission	141
Engine management with		Rear-wheel stand	117	Rear-wheel drive	142
BMW Motorrad ASC	86	Lamps	118	Running gear	142
Tire Pressure Control		Jump-starting	125	Brakes	144
RDC	87	Battery	126	Wheels and tires	144
Electronic Suspension Ad-				Electrical system	146
justment ESA II	89			Frame	147

Dimensions	148
Weights	148
Riding specifications	149
11 Service	151
Reporting safety	
defects	152
BMW Motorrad Service ...	153
BMW Motorrad Service	
Quality	153
BMW Motorrad Service	
Card - On-the-spot break-	
down assistance	153
BMW Motorrad Service	
Network	154
Maintenance work.....	154
Confirmation of mainte-	
nance work.....	155
Confirmation of service....	160

General instructions

Overview 6
Abbreviations and symbols 6
Equipment 7
Technical data 7
Currentness of this manual 7



Overview

Chapter 2 of this Rider's Manual will provide you with an initial overview of your motorcycle. All maintenance and repair work carried out on your motorcycle will be documented in Chapter 11. Proof of the maintenance work performed is a prerequisite for generous treatment of claims. When the time comes to sell your BMW, please remember to hand over this Rider's Manual; it is an important part of the motorcycle.

Abbreviations and symbols



Indicates warnings that you must comply with for reasons of your safety and the safety of others, and to protect your motorcycle against damage.



Special information on operating and inspecting your motorcycle as well as maintenance and adjustment procedures.



Indicates the end of an item of information.



Instruction.



Result of an activity.



Reference to a page with more detailed information.



Indicates the end of accessory or equipment-dependent information.



Tightening torque.



Technical data.

OE	Optional equipment The motorcycles are assembled complete with all the BMW optional extras originally ordered.
OA	Optional accessories BMW optional accessories can be purchased and installed at your authorized BMW Motorrad retailer.
EWS	Electronic immobilizer.
DWA	Anti-theft alarm.
ABS	Anti-Lock Brake System.
ASC	Automatic Stability Control.
ESA	Electronic Suspension Adjustment Electronic suspension adjustment.

RDC Tire Pressure Control (TPC).

Equipment

When you ordered your BMW Motorrad, you chose various items of custom equipment. This Rider's Manual describes optional extras (OE) offered by BMW and selected optional accessories (OA). This explains why the manual may also contain descriptions of equipment which you have not ordered. Please note, too, that your motorcycle might not be exactly as illustrated in this manual on account of country-specific differences.

If your BMW is equipped with options or accessories not described in this Rider's Manual, then this equipment is described in a separate operating manual.

Technical data

All dimensions, weights and outputs in the Rider's Manual refer to the Deutsche Institut für Normung e. V. (DIN) and comply with its tolerance regulations. Versions for individual countries may differ.

Currentness of this manual

The high safety and quality standards of BMW motorcycles are maintained by constant development work on designs, equipment and accessories. Because of this, your motorcycle may differ from the information supplied in the Rider's Manual. In addition, BMW Motorrad cannot guarantee the total absence of errors. We hope you will appreciate that no claims can be entertained on the basis of the data, illustrations or descriptions in this manual.



General instructions

Overviews

General view, left side.....	11
General view, right side	13
Left handlebar fitting.....	14
Handlebar fitting, right	15
Underneath seat	16
Instrument cluster	17
Headlight	18

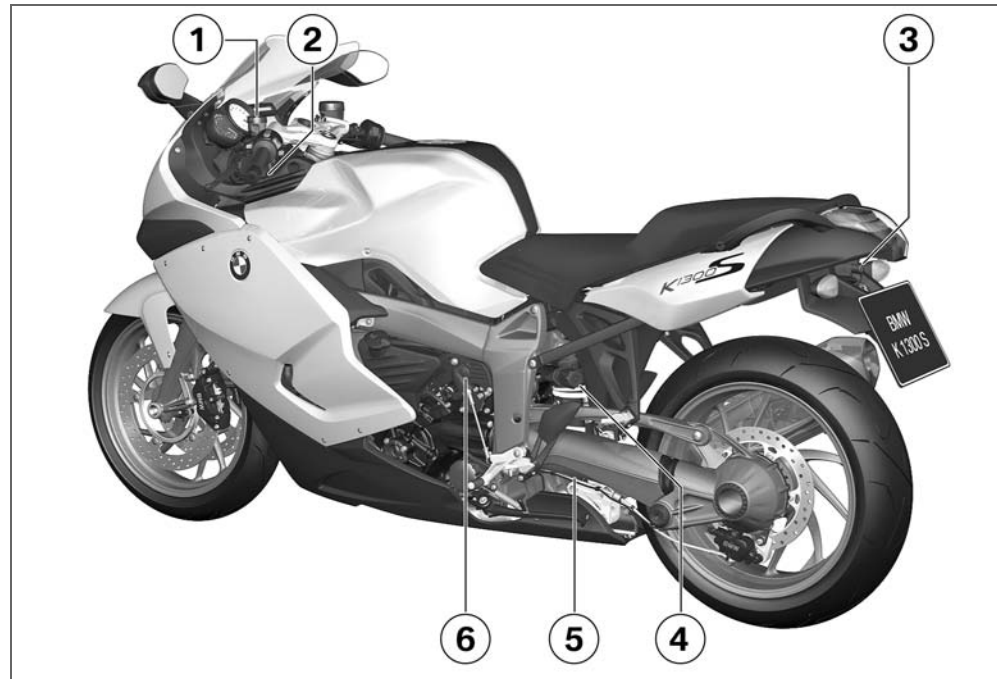



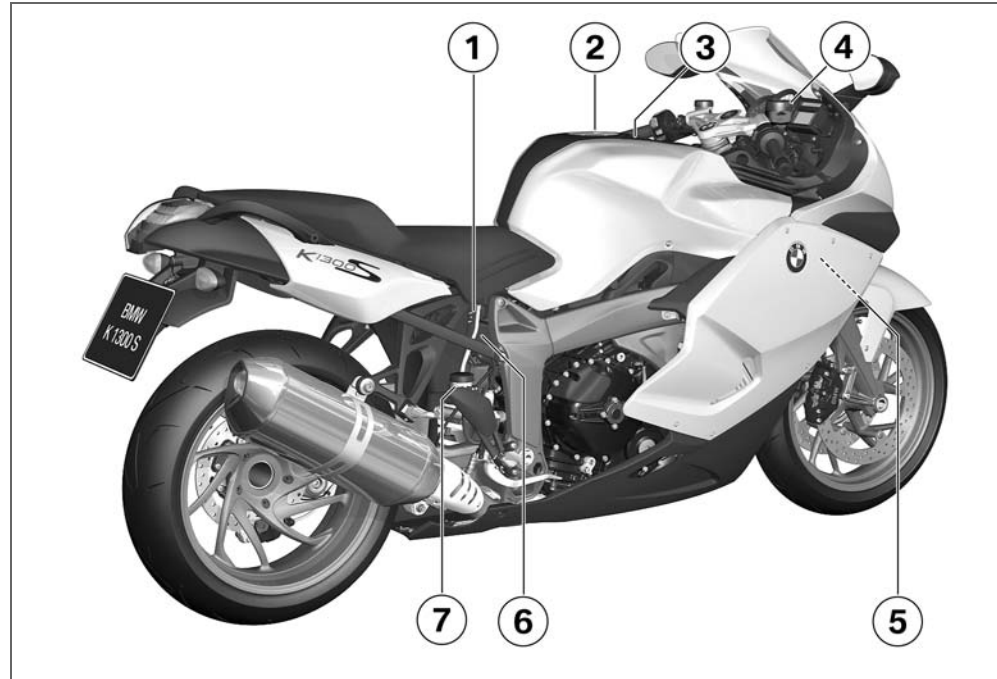

General view, left side

- 1 Clutch fluid reservoir
(⇒ 106)
- 2 Headlight range adjustment (below instrument cluster) (⇒ 66)
- 3 Seat lock (below tail light)
(⇒ 67)
- 4 Adjuster for spring preload, rear (⇒ 62)
- 5 Adjustment of rear damping (⇒ 63)
- 6 Onboard socket (⇒ 92)



General view, right side

- 1 Engine oil level indicator
( 101)
- 2 Fuel filler opening ( 79)
- 3 Battery compartment
( 127)
- 4 Brake-fluid reservoir, front
( 102)
- 5 Vehicle identification number (on the upper front wheel control)
- 6 Type plate (on rear cross tube)
- 7 Brake-fluid reservoir, rear
( 105)

Left handlebar fitting

- 1** High-beam headlight and headlight flasher (→ 55)
- 2** Operating odometer (→ 49)
 - with onboard computer^{OE}
 - Operating onboard computer (→ 51)
- 3** Hazard warning flashers (→ 56)
- 4** Operating turn indicators (→ 56)
- 5** Horn
- 6** – with Electronic Suspension Adjustment (ESA II)^{OE}
 - Operating ESA (→ 64)
- 7** ABS operation (→ 58)
 - with automatic Stability Control^{OE}
 - Operating the ASC (→ 59)

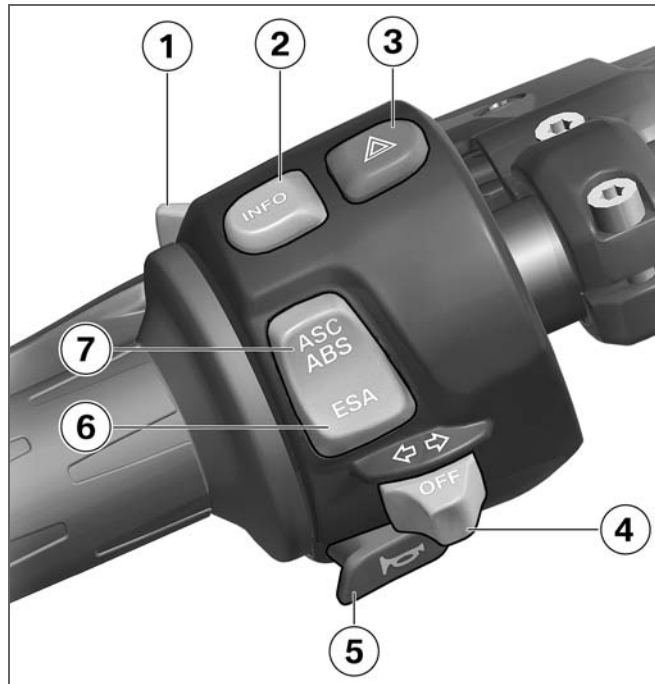

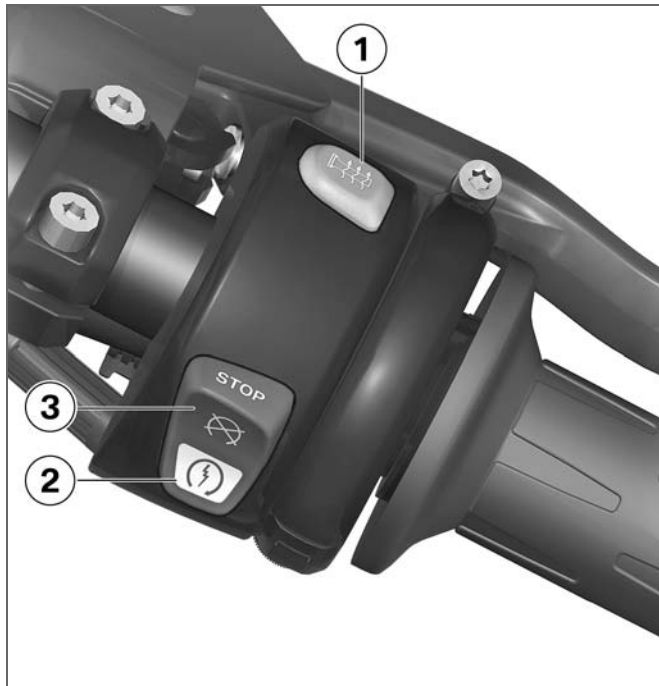

Handlebar fitting, right

- 1 – with heated handlebar grips^{OE}
Heated hand grips (→ 60)
- 2 Starter button (→ 72)
- 3 Emergency ON/OFF switch (→ 57)

2

15

Overviews

Underneath seat

- 1 Luggage loops
- 2 Rider's Manual (US Model)
- 3 Tire inflation pressure table
- 4 Payload table
- 5 Helmet holder (→ 68)
- 6 Toolkit (→ 100)
- 7 Engine oil fill location (→ 102)

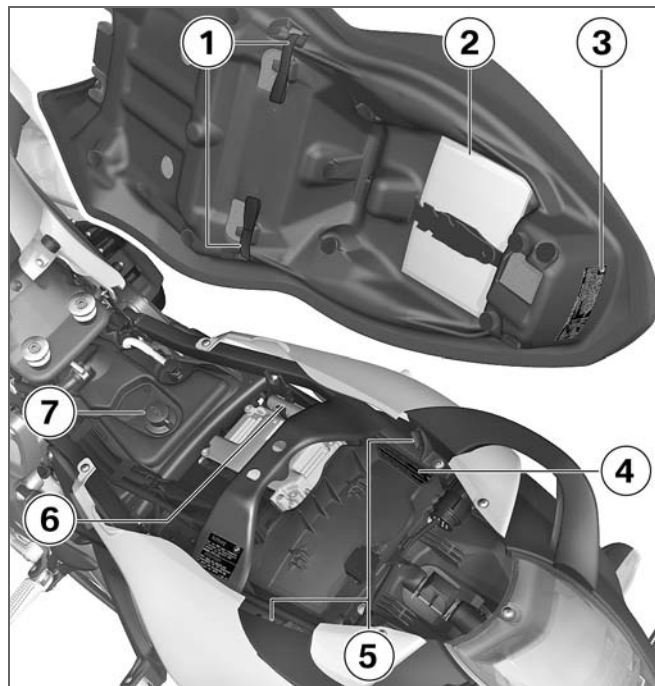

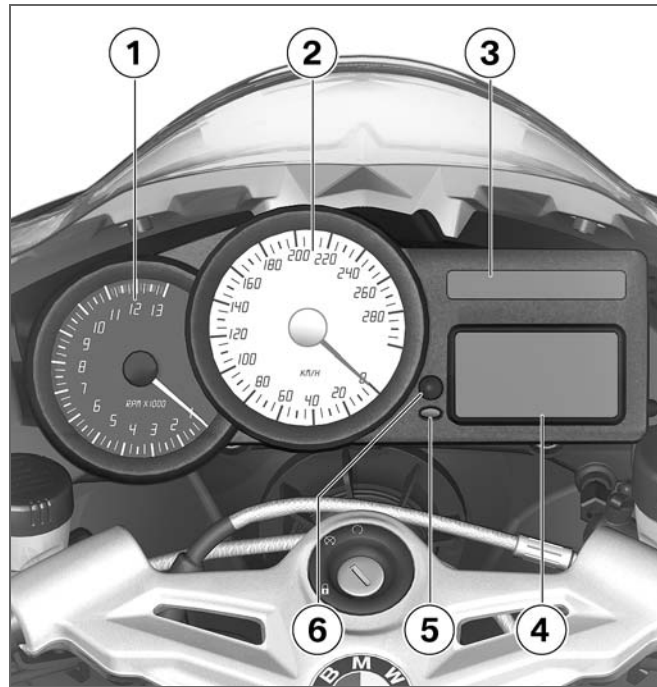

Instrument cluster

- 1 Tachometer
- 2 Speedometer
- 3 Indicator lights (➡ 20)
- 4 Multifunction display (➡ 20)
- 5 Ambient brightness sensor (for brightness adjustment of instrument lighting)
– with anti-theft alarm^{OE}
Anti-theft alarm indicator light (see anti-theft alarm operating instructions)
- 6 Operating odometer (➡ 49)
Operating clock (➡ 48)

▶ The instrument-cluster lighting has automatic day and night switchover.◀

Headlight

- 1 High-beam headlight
- 2 Low-beam headlight
- 3 Parking lights

Overviews

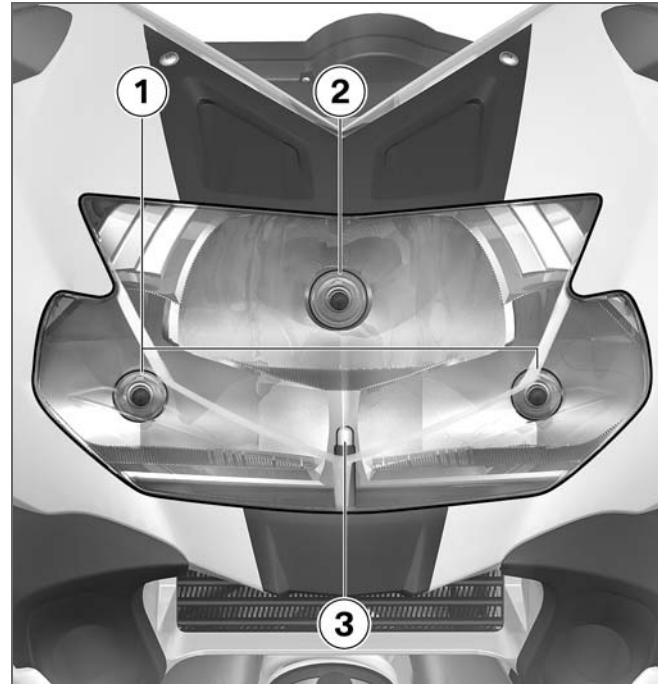

Status indicators

Standard displays	20
Displays with onboard computer	21
Displays with Tire Pressure Control RDC	21
Displays with heated hand grips	22
Standard warning indicators	22
Warning indicators of onboard com- puter.....	29
ABS warning indicators	31
ASC warning indicators	34
RDC warning indicators.....	36
Anti-theft alarm warning indicators	41

Standard displays

Multifunction display

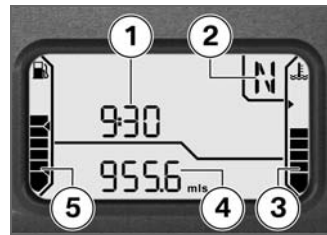

- 1 Clock (→ 48)
- 2 Gear indicator (→ 20)
- 3 Coolant temperature (→ 20)
- 4 Odometer and tripmeters (→ 49)
- 5 Fuel capacity (→ 20)

Indicator lights

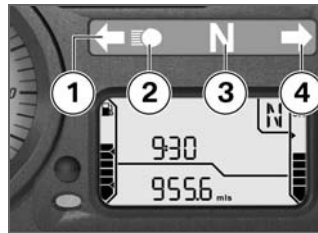



- 1 Turn indicators, left
- 2 High-beam headlight
- 3 Idling
- 4 Turn indicators, right

Fuel capacity

 The horizontal bars under the gas pump symbol indicated the remaining fuel quantity. When the fuel in the tank is topped up the gauge briefly shows the original level, before the reading is updated.

Gear indicator

 The gear engaged or N for neutral appears on the display.

 If no gear is engaged, the 'neutral' indicator light also lights up.

Coolant temperature

 The lateral bars under the temperature symbol show the coolant temperature level.

Service display



If the time remaining until the next service lies within a month,

the service date is briefly displayed following the pre-ride check. The month and year are shown as two digits each separated by a dash; in this example the display means "March 2007".



If the motorcycle is driven long distances annually, it is possible that earlier service is required. If the odometer reading for the earlier service lies within 600 miles (1,000 km), the remaining miles (kilometers) are counted down in 60-mile (100-km) steps and briefly displayed following the pre-ride check.

If the service interval has been exceeded, the general warning light also lights up yellow in addition to the date or mileage display. The Service lettering is displayed continuously.

▶ If the service display already more than one month before the service date, or if the Service lettering does not stop after the service date is exceeded, then the date stored in the instrument cluster must be set. This situation can occur if the battery has been disconnected for a longer time.

Consult a certified workshop, preferably an authorized BMW Motorrad retailer, for setting of the date.◀

Displays with onboard computer

– with onboard computer^{OE}

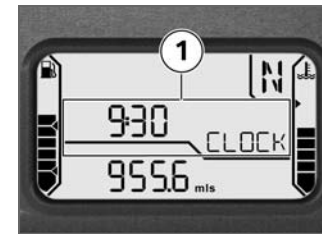

1 Onboard computer display area (→ 51)

Displays with Tire Pressure Control RDC

– with Tire Pressure Control (TPC/RDC)^{OE}

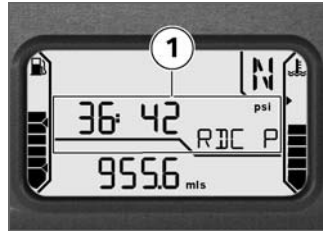

1 Display of tire inflation pressures (→ 54)

▶ The tire inflation pressures are shown temperature-compensated (see the chapter "Technology in Detail").◀

Displays with heated hand grips

– with heated handlebar grips^{OE}

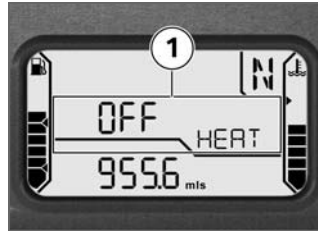

1 Display of heating levels (→ 60)

Standard warning indicators

Display

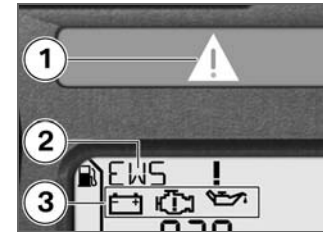











Warnings are indicated by the 'General' warning light **1** showing in combination with a warning word, for example **2** or with one of the warning symbols **3**. The 'General' warning light shows red or yellow, depending on the urgency of the warning. If several warnings are active, all corresponding warning lights and warning symbol are displayed; warnings are shown alternately.

The possible warnings are listed on the next page.



Status indicators

Overview of warning indicators

Indicator lights	Displays	Meaning
 Lights up yellow	EWS ! Is indicated	Electronic immobilizer is active (→ 26)
 Lights up yellow	FUEL ! Is indicated	Fuel down to reserve (→ 26)
 Lights up red	 Temperature display flashes	Coolant temperature too high (→ 26)
 Lights up yellow	 Is indicated	Engine in emergency-operation mode (→ 26)
 Flashes red	 Is indicated	Engine oil pressure insufficient (→ 27)
 Lights up red	 Is indicated	Battery charge current insufficient (→ 27)
 Lights up yellow	LAMP R ! Is indicated	Rear bulb defective (→ 28)
	LAMP F ! Is indicated	Front bulb defective (→ 28)

Indicator lights	Displays	Meaning
 Lights up yellow	LAMP S ! Is indicated	Bulbs defective ( 28)

Electronic immobilizer is active

 General warning light shows yellow.

EWS ! is indicated.

Possible cause:

The key being used is not authorized for starting, or communication between the key and engine electronics is disrupted.

- Remove other ignition keys located on the ignition key.
- Use the reserve key.
- Have the defective key replaced, preferably by an authorized BMW Motorrad retailer.

Fuel down to reserve

 General warning light shows yellow.

FUEL ! is indicated.

 A fuel shortage can lead to misfiring and to the engine dying unexpectedly. Misfiring can

damage the catalytic converter, and the engine dying unexpected can lead to accidents.

Do not drive until the fuel tank is completely empty.◀

Possible cause:

At the most, the fuel tank still contains the reserve fuel quantity.



Reserve fuel quantity

- ≥1.1 gal (≥4 l)

- Refueling (➔ 79).

Coolant temperature too high



General warning light shows red.



Temperature display flashes.



Continued driving with an overheated engine can result in engine damage.

Be sure to observe the measures listed below.◀

Possible cause:

The coolant temperature is too high.

- If possible, continue driving in the part-load range to cool down the engine.
- In traffic jams, switch off the engine, but keep the ignition switched on so that the radiator fan continues to operate.
- Should the coolant temperature frequently be too high, have the fault rectified as quickly as possible by a specialized workshop, preferably an authorized BMW Motorrad retailer.

Engine in emergency-operation mode



General warning light shows yellow.



Engine symbol appears on the display.



The engine is in the emergency operating mode. Only reduced engine performance may be available, which can lead to danger driving situations, especially during passing maneuvers.

Adapt your driving style to the possibly reduced engine performance.◀

Possible cause:

The engine control unit has diagnosed a fault. In exceptional cases, the engine stops and can no longer be started. Otherwise, the engine runs in the emergency operating mode.

- Continued driving is possible, however the accustomed engine performance may not be available.
- Have the malfunction corrected as soon as possible by a spe-

cialized workshop, preferably an authorized BMW Motorrad retailer.

Engine oil pressure insufficient



General warning light flashes red.



Oil-can symbol appears on the display.

The oil pressure in the lubricating oil circuit is too low. If the warning light lights up, stop immediately and switch off the engine.

▶ The warning on insufficient engine oil pressure is no substitute for the function of an oil-level indicator. The correct engine oil level can only be checked on the oil level indicator.◀

Possible cause:

The engine oil level is too low.

- Checking engine oil level (➡ 101).

If oil level is too low:

- Topping up engine oil (➡ 102).

Possible cause:

The engine oil pressure is insufficient.



Driving with insufficient engine oil pressure can result in engine damage.

Do not continue driving.◀

- Have the malfunction corrected as soon as possible by a specialized workshop, preferably an authorized BMW Motorrad retailer.

Battery charge current insufficient



General warning light shows red.



Battery symbol appears on the display.



A discharged battery leads to the failure of various motorcycle systems, e.g. lighting, engine or ABS. This can result in dangerous driving situations. If possible, do not continue driving. ◀

The battery is not being charged. If you continue driving, the vehicle electronics will discharge the battery.

Possible cause:

Alternator or alternator belt defective

- Have the malfunction corrected as soon as possible by a specialized workshop, preferably an authorized BMW Motorrad retailer.

Rear bulb defective



General warning light shows yellow.

LAMP R ! is indicated.



A defective bulb places your safety at risk because it is easier for other users to oversee the motorcycle.

Replace defective bulbs as soon as possible; always carry a complete set of spare bulbs if possible. ◀

Possible cause:

Rear light or brake light bulb defective.

- The diode tail light must be replaced. Please contact a specialized workshop, preferably an authorized BMW Motorrad retailer.

Front bulb defective

LAMP F ! is indicated.



A defective bulb places your safety at risk because it is easier for other users to oversee the motorcycle.

Replace defective bulbs as soon as possible; always carry a complete set of spare bulbs if possible. ◀

Possible cause:

Low-beam, high-beam, parking or turn indicator bulb defective.

- Replacing low-beam and high-beam bulbs (➡ 119).
- Replacing parking light bulb (➡ 120).
- Replacing front turn indicator bulbs (➡ 122).
- Replacing rear turn indicator bulbs (➡ 123).

Bulbs defective



General warning light shows yellow.

LAMP S ! is indicated.

 A defective bulb places your safety at risk because it is easier for other users to oversee the motorcycle. Replace defective bulbs as soon as possible; always carry a complete set of spare bulbs if possible.◀

Possible cause:

A combination of several bulb defects is present.

- See the fault descriptions above.

Warning indicators of onboard computer

Display

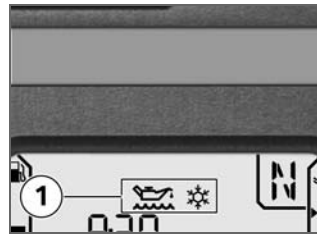

– with onboard computer^{OE}



Warnings of the onboard computer are shown in area **1**.

The possible warnings are listed on the next page.

Overview of warning indicators

Indicator lights	Displays	Meaning
	Is indicated	Engine oil level too low (→ 31)
	Check Oil Is indicated	
	Is indicated	Ice warning (→ 31)

Engine oil level too low

 Oil level symbol appears on the display.

Check Oil is indicated.

Possible cause:

The electronic oil level sensor has detected a low engine oil level. Check the engine oil level on the oil level indicator the next time you stop for refueling:

- Checking engine oil level (➔ 101).

If oil level is too low:

- Topping up engine oil (➔ 102).

Possible cause:

If "Check oil level" appears in the display, although a correct oil level has been measured on the oil level indicator, the oil level sensor may be defective.

- Contact a specialized workshop, preferably an authorized BMW Motorrad retailer.

Ice warning

 Ice crystal symbol appears on the display.

Possible cause:

The air temperature measured at the motorcycle is lower than 37 °F (3 °C).

 The ice warning does not mean that there is no risk of black ice forming at measured temperatures above 37 °F (3 °C). Always think well ahead when temperatures are low, especially on bridges and where the road is in the shade.◀

- Think well ahead when driving.

ABS warning indicators

Display



ABS warnings are indicated by the ABS warning light **1**.

In some countries an alternative display of the ABS warning light is possible.

 Possible country-dependent versions.







Additional information on the BMW Motorrad Integral ABS is provided from page (➔ 84); an



overview of the possible warnings is provided on the following page.

Status indicators

Overview of warning indicators

Indicator lights	Displays	Meaning
 Flashes		ABS self-diagnosis not completed ( 34)
 Lights up		ABS deactivated ( 34)
 Lights up		ABS error ( 34)

ABS self-diagnosis not completed

 ABS warning light flashes.

Possible cause:

The ABS function is not available, because the self-diagnosis has not been completed. To check the wheel sensors, the motorcycle must be driven a few yards.

- Ride off slowly. It must be noted that the ABS function is not available until the self-diagnosis has been completed.

ABS deactivated

 ABS warning light lights up.

Possible cause:

The ABS system has been deactivated by the driver.

- Switching on ABS function ( 58).

ABS error

 ABS warning light lights up.

Possible cause:

The ABS control unit has detected an error. The ABS function is not available.

- Continued driving is possible while taking the failed ABS function into account. Observe additional information on situations which can lead to an ABS error ( 85).
- Have the malfunction corrected as soon as possible by a specialized workshop, preferably an authorized BMW Motorrad retailer.

ASC warning indicators





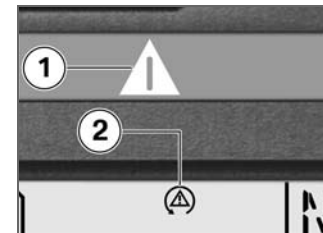

Display

– with automatic Stability Control^{OE}



ASC warnings are displayed with the ASC symbol **2** in conjunction with the general warning light **1**. Additional information on the BMW Motorrad ASC is provided from page ( 86); an overview of the possible warnings is provided on the following page.

Overview of warning indicators

Indicator lights	Displays	Meaning
 Flashes rapidly in yellow	 Is indicated	ASC intervention (→ 36)
	 Flashes slowly	Self-diagnosis not completed (→ 36)
	 Is indicated	ASC deactivated (→ 36)
 Lights up yellow	 Is indicated	ASC error (→ 36)

ASC intervention

General warning light flashes rapidly in yellow.



ASC symbol is displayed.

The ASC has detected instability at the rear wheel and has reduced the torque. The warning light flashes longer than the duration of the ASC intervention. As a result, the driver is provided with optical feedback on the regulation carried out even after the critical driving situation.

Self-diagnosis not completed

ASC symbol flashes.

Possible cause:

The self-diagnosis was not completed; the ASC function is not available. So that the ASC self-diagnosis can be completed, the

engine must be running and the motorcycle must be moved at a speed of at least 3 mph (5 km/h).

- Ride off slowly. It must be noted that the ASC function is not available until the self-diagnosis has been completed.

ASC deactivated

ASC symbol is displayed.

Possible cause:

The ASC system has been deactivated by the driver.

- with automatic Stability Control^{OE}
- Activating ASC function (►► 59).

ASC error

General warning light shows yellow.



ASC symbol is displayed.

Possible cause:

The ASC control unit has detected an error. The ASC function is not available.

- Continue driving is possible. It must be noted that the ASC function is not available. Observe additional information on situations which can lead to an ASC error (►► 87).
- Have the malfunction corrected as soon as possible by a specialized workshop, preferably an authorized BMW Motorrad retailer.

RDC warning indicators**Display**

– with Tire Pressure Control (TPC/RDC)^{OE}



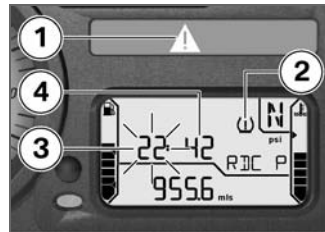



The displayed tire inflation pressures refer to a tire temperature of 68 °F (20 °C) (► 88).



The warning symbol **2** signals a critical tire inflation pressure, and the corresponding tire inflation pressure of the front wheel **3** or the rear wheel **4** flashes. If the critical value is at the limit of the permissible tolerance, the general warning light **1** also lights up in yellow. If the determined tire inflation pressure is outside the permissible tolerance, the general warning light **1** flashes in red.

Additional information on the BMW Motorrad TPC/RDC is provided from page (► 87); an overview of the possible warnings is provided on the following page.

Overview of warning indicators

Indicator lights	Displays	Meaning
 Lights up yellow		Tire inflation pressure in limit area of permissible tolerance (➡ 39)
The critical tire inflation pressure flashes		
 Flashes red		Tire inflation pressure outside permissible tolerance (➡ 39)
The critical tire inflation pressure flashes		
"--" or "-- --" is indicated		Transmission error (➡ 39)
 Lights up yellow		Sensor defective or system fault (➡ 40)
"--" or "-- --" is indicated		
 Lights up yellow	RDC ! is indicated	Battery of tire-inflation pressure sensor weak (➡ 40)

Tire inflation pressure in limit area of permissible tolerance

 General warning light shows yellow.

 Tire symbol appears on the display.

The critical tire inflation pressure flashes.

Possible cause:

The measured tire inflation pressure is in the limit area of the permissible tolerance.

- Correct tire inflation pressure in accordance with instructions on back of cover of Rider's Manual.

 Before adjusting the tire inflation pressure, observe the information on temperature compensation and on inflation pressure adjustment in the chapter "Technology in detail".◀

Tire inflation pressure outside permissible tolerance

 General warning light flashes red.

 Tire symbol appears on the display.

The critical tire inflation pressure flashes.

Possible cause:

The measured tire inflation pressure is outside the permissible tolerance.

- Check tire for damage and drivability.

Is it still possible to drive with tire:

 Incorrect tire inflation pressure result in poorer handling of the motorcycle.

Always adapt your driving style to the incorrect tire inflation pressure.◀

- Correct tire inflation pressure at next opportunity.

 Before adjusting the tire inflation pressure, observe the information on temperature compensation and on inflation pressure adjustment in the chapter "Technology in detail".◀

- Have the tire checked for damage by a specialized workshop, preferably an authorized BMW Motorrad retailer.

If you are unsure about the drivability of the tire:

- Do not continue driving.
- Inform roadside service.

Transmission error

"--" or "-- --" is indicated.

Possible cause:

The motorcycle's speed has not exceeded the threshold of approx. 20 mph (30 km/h). The TPC/RDC sensors do not send their signal until after this speed

has been exceeded for the first time (→ 87).

- Watch RDC display at higher speed. A permanent fault has not occurred until the general warning light also lights up. In this case:
- Have fault eliminated by a specialized workshop, preferably an authorized BMW Motorrad retailer.

Possible cause:

There is a fault in the radio connection to the RDC sensors.

Possible causes are radio systems in the surrounding area, which interfere with the connection between the RDC control unit and the sensors.

- Watch the RDC display in another environment. A permanent fault has not occurred until the general warning light also lights up. In this case:

- Have fault eliminated by a specialized workshop, preferably an authorized BMW Motorrad retailer.

Sensor defective or system fault



General warning light shows yellow.



Tire symbol appears on the display.

"--" or "-- --" is indicated.

Possible cause:

Wheels without installed RDC sensors are mounted.

- Retrofit wheel set with RDC sensors.

Possible cause:

One or two RDC sensors have failed.

- Have fault eliminated by a specialized workshop, preferably

an authorized BMW Motorrad retailer.

Possible cause:

A system fault has occurred.

- Have fault eliminated by a specialized workshop, preferably an authorized BMW Motorrad retailer.

Battery of tire-inflation pressure sensor weak



General warning light shows yellow.

RDC ! is indicated.



This error message is only displayed for a short time following the pre-ride check.◀

Possible cause:

The battery of the tire inflation pressure sensor no longer has its full capacity. The operation of the tire inflation pressure control is only ensured for a limited time.

- Contact a specialized workshop, preferably an authorized BMW Motorrad retailer.

The possible warnings are listed on the next page.

Anti-theft alarm warning indicators

Display

– with anti-theft alarm^{OE}

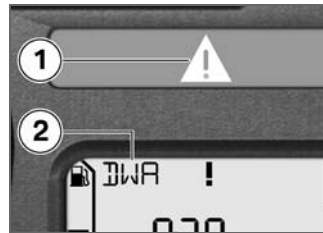

Anti-theft alarm warning are shown as warnings **2** in conjunction with the general warning light **1** following the pre-ride check and refer to the capacity of the internal anti-theft alarm battery.



42

Status indicators

Overview of warning indicators

Indicator lights	Displays	Meaning
	DWALO ! Is indicated	Anti-theft alarm battery weak (→ 43)
 Lights up yellow	DWA ! Is indicated	Anti-theft alarm battery drained (→ 43)

Anti-theft alarm battery weak

DWALO ! is indicated.

 This error message is only displayed for a short time following the pre-ride check.◀

Possible cause:

The anti-theft alarm battery no longer has its full capacity. The operation of the anti-theft alarm is only ensured for a limited time with the motorcycle battery disconnected.

- Contact a specialized workshop, preferably an authorized BMW Motorrad retailer.

Anti-theft alarm battery drained

 General warning light shows yellow.

DWA ! is indicated.

 This error message is only displayed for a short time following the pre-ride check.◀

Possible cause:

The anti-theft alarm battery has no capacity. The operation of the anti-theft alarm is no longer ensured with the motorcycle battery disconnected.

- Contact a specialized workshop, preferably an authorized BMW Motorrad retailer.



Status indicators

Operation

Ignition switch and steering lock	46	Mirrors	62
Electronic immobilizer EWS	47	Spring preload	62
Clock	48	Damping	63
Odometer and tripmeters	49	Electronic suspension adjustment ESA	63
Onboard computer	51	Tires	65
Tire Pressure Control RDC	54	Headlight	66
Lights	55	Seat	67
Turn indicators	56	Helmet holder	68
Hazard warning flashers	56	Luggage loops	68
Emergency ON/OFF switch	57		
BMW Motorrad Integral ABS	58		
Automatic Stability Control ASC	59		
Heated hand grips	60		
Clutch	61		
Brakes	61		

Ignition switch and steering lock

Keys

You receive two master keys and one spare key. If a key is lost, please note the information on the electronic immobilizer (EWS) (► 47).

Ignition key and steering lock, tank filler cap lock and seat lock are all operated with the same key.

– with case^{OA}

Cases with locks for the same key can be ordered on request. Please contact a specialized workshop for this purpose, preferably an authorized BMW Motorrad retailer.◁

Switching on ignition

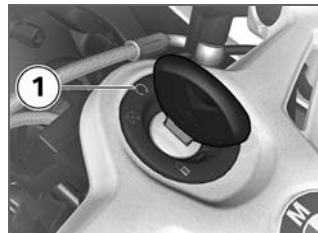

- Turn key to position **1**.
 - » Parking lights and all function circuits switched on.
 - » Engine can be started.
 - » Pre-ride check is performed. (► 73)
 - » ABS self-diagnosis is performed. (► 73)
- with automatic Stability Control^{OE}
 - » ASC self-diagnosis is performed. (► 74)

Switching off ignition



- Turn key to position **2**.
 - » Light switched off.
 - » Handlebars not locked.
 - » Key can be removed.
 - » Electrically powered accessories remain operational for a limited period of time.
 - » Battery can be recharged via onboard socket.

Locking handlebars

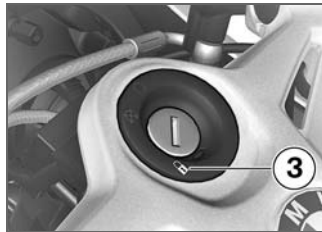

⚠ If the motorcycle is on the side stand, the surface of the ground will determine whether it is better to turn the handlebars to the left or right. However, the motorcycle is more stable on a level surface with the handlebars turned to the left than with the handlebars turned to the right.

On level ground, always turn the handlebars to the left to set the steering lock.◀

- Turn handlebars to full left or right lock position.

- Turn key to position **3** while moving handlebars slightly.
 - » Ignition, lights and all function circuits switched off.
 - » Handlebars locked.
 - » Key can be removed.

Electronic immobilizer EWS

Theft protection

The electronic immobilizer helps protect your BMW motorcycle from theft, and this enhanced security is at your disposal without any need for you to set parameters or activate additional systems. The engine of a motorcycle fitted with this electronic immobilizer can be started only with the keys that belong to the motorcycle. You can also have your authorized BMW Motorrad retailer disable particular keys, for example in the event that you lose your keys. The engine can-

not be started with a key that has been barred.

Electronics in key

The motorcycle's electronics exchange certain continuously changing signals with the electronics in the key; these signals are specific to your motorcycle and they are transmitted via the ring antenna in the ignition lock. The ignition is not enabled for starting until the key has been recognized as "authorized" for your motorcycle.

▶ A spare key attached to the same ring as the ignition key used to start the engine could "irritate" the electronics, in which case the enabling signal for starting is not issued. The warning EWS is shown in the multifunction display. Always store the spare key separately from the ignition key.◀

Replacement and extra keys

Replacement and spare keys are only available through an authorized BMW Motorrad retailer. The keys are part of an integrated security system, so the retailer is under an obligation to check the legitimacy of all applications for replacement/extra keys. If you want to have a lost key barred, you must bring along all other keys that belong to the motorcycle. A key that has been barred can subsequently be cleared and reactivated for use.

Clock

Setting clock

 Attempting to set the clock while riding the motorcycle can lead to accidents. Adjust the clock only when the motorcycle is stationary. ◀

- Switch on the ignition.
 - without onboard computer^{OE}
 - without Tire Pressure Control (TPC/RDC)^{OE}
 - without heated handlebar grips^{OE}

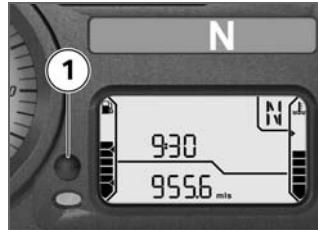

- Press button **1** repeatedly until total mileage is shown.



- Press alternative button **2** repeatedly until total mileage is shown. ◀

- with onboard computer^{OE}
- or
- with Tire Pressure Control (TPC/RDC)^{OE}
- or
- with heated handlebar grips^{OE}



- Press button **2** repeatedly until clock is shown.

▷ In this case, the button in the instrument cluster is only used to operate the odometer.◀◀

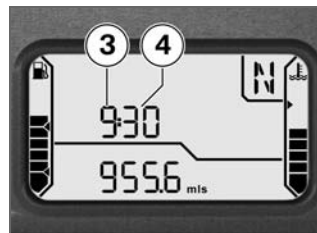

- Hold down button.
- » Hours **3** flash.
- Press button.
- » Hours increase by one each time button is pressed.
- Hold down button.
- » Minutes **4** flash.
- Press button.
- » Minutes increase by one each time button is pressed.
- Press and hold button or no longer press it.
- » End setting; set time is displayed.

Odometer and tripmeters

Selecting readings

- Switch on the ignition.

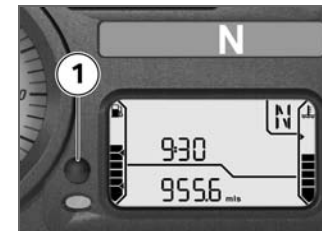

- Press button **1**.



Each time the button is pressed, the display shows values starting with the current value in the following order:

- Total distance covered
- Tripmeter 1 (Trip I)
- Tripmeter 2 (Trip II)
- Operating range (after reaching reserve level)

- without onboard computer^{OE}
- without Tire Pressure Control (TPC/RDC)^{OE}
- without heated handlebar grips^{OE}



- Press button **2** as an alternative.<

Resetting tripmeter

- Switch on the ignition.
- Select desired tripmeter.

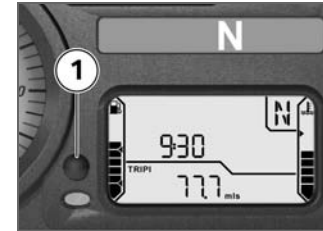

- Hold down button **1**.
- » Tripmeter is reset.

- without onboard computer^{OE}
- without Tire Pressure Control (TPC/RDC)^{OE}
- without heated handlebar grips^{OE}



- Press button **2** as an alternative.<

Residual range

- without onboard computer^{OE}



The operating range indicates what distance can still be driven with the remaining fuel. It is only displayed after the fuel reserve is reached. This distance is calculated on the basis of fuel level and average consumption. When refueling after running on reserve, make sure that you top up the tank to a level above reserve, as otherwise the sensor will not be able to register the new level. Otherwise neither the

fill level nor the operating range display can be updated.

▶ The determined residual range is an approximate reading. BMW Motorrad therefore recommends that you do not try to use the full remaining range before refueling.<

Onboard computer

- with onboard computer^{OE}

Selecting readings

- Switch on the ignition.



- Press button **1**.



Each time the button is pressed, the display shows values starting with the current value in the following order:

- Ambient temperature
- Average speed
- Average consumption
- Range
- Oil level indicator
- with Tire Pressure Control (TPC/RDC)^{OE}
Tire inflation pressures
- with heated handlebar grips^{OE}
Grip heating level

Ambient temperature

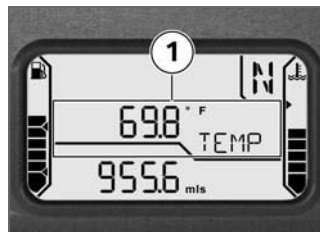

When the motorcycle is stopped, the engine heat can falsify the measurement of the ambient temperature **1**. If the influence of the engine heat becomes too great, -- is temporarily shown in the display.

 If the ambient temperature drops below 3 °C, a warning of possible icing-up appears. The display automatically switches from any other mode to the temperature reading when the temperature drops below this threshold for the first time.

Average speed



The average speed **1** is calculated based on the elapsed time since the last reset. Times during which the engine was stopped are excluded from the calculation.

Resetting average speed

- Switch on the ignition.
- Select average speed.



- Hold down button **1**.
- » Average speed is reset.

Average consumption



The average consumption **1** is calculated by dividing the distance covered since the last re-

set by the corresponding amount of fuel used.

Resetting average consumption

- Switch on the ignition.
- Select average speed.



- Hold down button **1**.
- » Average consumption is reset.

Range

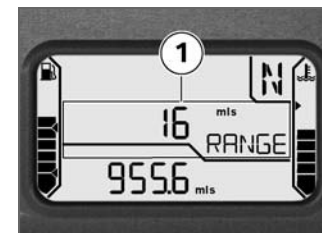

The functional description of the operating range (➔ 51) also applies to the range **1**. However, the range can also be displayed before the fuel reserve is reached.

To calculate the range, a special average consumption is used, which does not always match the value that can be shown on the display.

If the motorcycle is standing on the side stand, the fuel level cannot be correctly determined due to the inclined position. For this

reason the range is only calculated while driving.

▶ The determined range is an approximate reading. BMW Motorrad therefore recommends that you do not try to use the full range before refueling.◀

Oil level indicator



The oil level indicator **1** provides information on the oil level in the engine. It can only be displayed when the motorcycle is stopped.

The conditions for the oil level indicator are as follows:

- Engine at operating temperature.
- Engine idling for at least 10 seconds.
- Side-stand retracted.
- Motorcycle is vertical.

The readings mean:
OK: Oil level correct.
CHECK: Check oil level during next refueling stop.

◻ If other information of the onboard computer is displayed, this symbol continues to be shown until the oil level is detected as correct again.

---: No measurement possible (above-mentioned conditions not met).

The most recently measured level is displayed for five seconds when you next switch on the ignition.

▶ Should, despite a correct oil level on the display of the engine oil reservoir, "Check oil level" appear continuously in the display, the oil level sensor may be defective. In this case, please contact your authorized BMW Motorrad retailer.◀

Tire Pressure Control RDC

- with Tire Pressure Control (TPC/RDC)^{OE}

Displaying tire inflation pressure

- Switch on the ignition.



- Press button **1** repeatedly until tire inflation pressures are shown.



The tire inflation pressures are displayed with the lettering RDC P. The left-hand value indicates the inflation pressure of

the front wheel, and the right-hand value the inflation pressure of the rear wheel. The displayed tire inflation pressures refer to a tire temperature of 68 °F (20 °C). Immediately after switching on the ignition, --- is displayed, as the transfer of the inflation pressure values does not begin until a speed of 20 mph (30 km/hr) is exceeded for the first time.

Lights

Parking lights

The side lights switch on automatically when the ignition is switched on.

▶ The parking lights are a strain on the battery. Do not leave the ignition switched on longer than absolutely necessary.◀

Low-beam headlight

The low-beam headlight switches on automatically when you start the engine.

▶ With the engine switched off, you can switch on the lights by switching on the high-beam headlight with the ignition switched on or by operating the headlight flasher.◀

High-beam headlight



- Press high-beam headlight switch **1** forward.
- » High-beam headlight is switched on.

- Move high-beam headlight switch **1** into initial position.
- » High-beam headlight is switched off.
- Pull high-beam headlight switch **1** toward rear.
- » High-beam headlight is switched on as long as switch is pressed (headlight flasher).

Switching on parking lights

- Switch off the ignition.



- Immediately after switching off the ignition, press and hold the

- turn indicator button **1** toward left.
- » Parking light switches on.

Switching off parking lights

- Switch ignition on and then off again.
- » Parking light switched off.

Turn indicators

Operating turn indicators



- Press turn indicator button **1** toward left.
- » Left-hand turn indicator is switched on.

- » Indicator light for left-hand turn indicator flashes.
- Press turn indicator button toward right.
- » Right-hand turn indicator is switched on.
- » Indicator light for right-hand turn indicator flashes.
- Press turn indicator button in middle position.
- » Turn indicator is switched off.
- » Turn indicator lights in indicator light panel are off.

Hazard warning flashers

Switching on hazard warning flashers

- Switch on the ignition.

⚠ The hazard warning flashers place a strain on the battery. Do not use the hazard warning flashers for longer than absolutely necessary.◀



- Press button **1** for hazard warning flashers.

▶ If a turn indicator button is pressed with the ignition switched on, the flashing function replaces the emergency flashing function as long as the button is pressed. If the turn indicator button is released, the emergency flasher function becomes active again.◀

- » The hazard warning flashers are switched on.
- » Indicator lights for left and right turn indicator flash.
- Switch off the ignition.

- » Hazard warning flashers continue to operate.
- » Indicator lights for left and right turn indicator are off.

Switching off hazard warning flashers



- Press button **1** for hazard warning flashers.
- » Hazard warning flashers are switched off.

Emergency ON/OFF switch



- 1** Emergency ON/OFF switch

! Operating the emergency ON/OFF switch when riding can cause the rear wheel to lock and thus cause a fall. Do not operate the emergency ON/OFF switch when riding.◀

The engine can be switched off easily and quickly using the emergency ON/OFF switch.

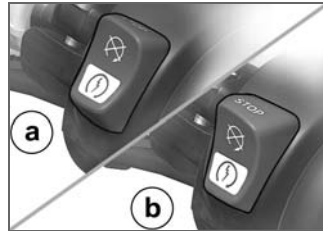

- a** Engine switched off
b Operating position

BMW Motorrad Integral ABS

Switching off ABS function

- Stop motorcycle or switch on ignition with motorcycle stationary.



- Press and hold button **1** until ABS warning light changes its display behavior.

brake failure ABS warning light lights up.

– with automatic Stability Control^{ASC}

- » First the ASC symbol changes its display behavior. Press and hold button **1** until ABS warning light reacts. In this case, the ASC setting does not change.
- Release ABS button within two seconds.

brake failure ABS warning light continues to light up.

» ABS function is deactivated, integral function continues to be active.

Switching on ABS function



- Press and hold button **1** until ABS warning light changes its display behavior.

brake failure ABS warning light goes out; if self-diagnosis has not been completed, it begins to flash.

- Release ABS button within two seconds.

brake failure ABS warning light remains off or continues to flash.

- » ABS function is switched on.
- As an alternative, the ignition can also be switched off and then on again.

▷ If the ABS light continues to light up after switching the ignition off and then on again, an ABS fault has occurred.◀

Automatic Stability Control ASC



– with automatic Stability Control OE

Switching off ASC function

- Switch on the ignition.



▷ The ASC function can also be deactivated while driving.◀



- Press and hold ASC button **1**.
-  ASC symbol is continuously displayed.
- Release ASC button within two seconds.
-  ASC symbol continues to be displayed.
- » ASC function is deactivated.

Activating ASC function



- Press and hold ASC button **1**.
-  ASC symbol is no longer displayed; if self-diagnosis is not completed, it begins to flash.
- Release ASC button within two seconds.
-  ASC symbol remains off or continues to flash.
- » ASC function is activated.
- As an alternative to pressing the ASC button, the ignition can also be switched off and then on again.

▶ If the ASC warning light lights up after switching the ignition off and on and then continued driving over 5 mph (10 km/h), an ASC error has occurred.◀

Heated hand grips

– with heated handlebar grips^{OE}

Operating heated hand grips

- Start engine.

▶ The heated hand grips option can only be activated when the engine is running. If the engine is switched off, the heated hand grips must be reactivated once the engine has been restarted.◀



- Press button **1** once.
- » Current setting is displayed.

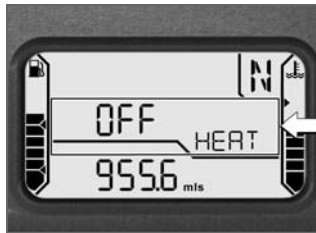

The handlebar grips can be heated at two different levels. The second level is used for fast heat-up of the grips; then the switch should be switched back

to the first level. The heated hand grips option can only be activated when the engine is running.

- Press button **1** repeatedly until desired heating level is shown.



Heating function off.



50% heating output



100% heating output

» If no further changes are made, the selected heating level is set.

» After a short time, the last information selected is shown in the display.

Clutch

Adjusting clutch lever

 If the position of the clutch fluid reservoir is changed, air can enter the clutch system. Do not reposition the handlebar controls on the handlebars or the handlebars in their mounts.◀

 Adjusting the clutch lever while driving can lead to accidents.

Only adjust the clutch lever when the motorcycle is stationary.◀



- Turn adjusting screw **1** clockwise.

 The adjusting screw can be turned more easily if you press the clutch lever forward when doing so.◀

- » Distance between handlebar grip and clutch lever increases.
- Turn adjusting screw **1** counterclockwise.
- » Distance between handlebar grip and clutch lever decreases.

Brakes

Adjusting handbrake lever

 Changing the position of the brake-fluid reservoir can allow air to penetrate the brake system.

Do not reposition the handlebar controls on the handlebars or the handlebars in their mounts.◀

 Adjusting the brake lever while driving can lead to accidents.

Only adjust the brake lever when the motorcycle is stationary.◀

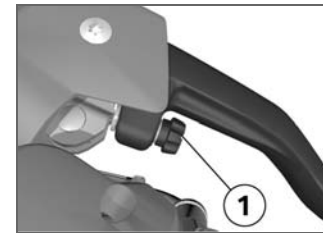

- Turn adjusting screw **1** clockwise.

 The adjusting screw can be turned more easily if you press the handbrake lever forward when doing so.◀

- » Distance between handlebar grip and handbrake lever increases.
- Turn adjusting screw **1** counterclockwise.
- » Distance between handlebar grip and handbrake lever decreases.

Mirrors

Adjusting mirrors

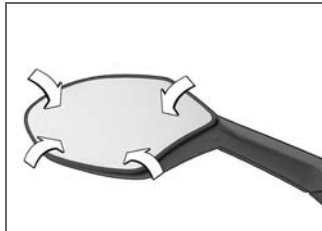

- Move mirror into desired position by applying light pressure at edge.

Spring preload

Setting

It is essential to set spring preload of the rear suspension to suit the load carried by the motorcycle. Increase spring preload when the motorcycle is heavily loaded and reduce spring

preload accordingly when the motorcycle is lightly loaded.

Adjusting spring preload for rear wheel

- Make sure ground is level and firm and park motorcycle.



⚠ Your motorcycle's handling will suffer if you do not match the spring-preload and damping-characteristic settings. Adjust the damping characteristic to suit the spring preload.◀

⚠ Adjusting the spring preload while the motorcycle is being ridden can lead to accidents. Adjust the spring preload only when the motorcycle is stationary.◀

- To increase spring preload, turn handwheel **1** in direction of arrow HIGH.
- To decrease spring preload, turn handwheel **1** in direction of arrow LOW.

 Basic setting of spring preload, rear

– without Electronic Suspension Adjustment (ESA II)^{OE}

– Turn upper adjustment wheel as far as possible in direction of arrow LOW, then turn 13 clicks in direction of arrow HIGH (Full tank of gas, with rider 187 lbs (85 kg))◀

Damping Setting

The damping must be adjusted to the road conditions and the spring preload.

- A rough road surface requires softer damping than a smooth road surface.
- An increase in spring preload requires firmer damping, a reduction in spring preload requires softer damping.

Adjusting damping on rear wheel

- Make sure ground is level and firm and park motorcycle.



- Adjust damping with the toolkit using the adjusting screw **1**.

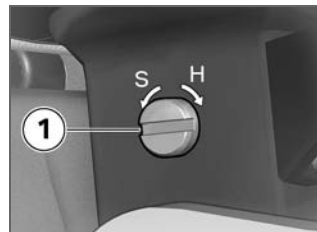

- To increase damping, turn adjusting screw **1** in arrow direction H.

- To decrease damping, turn adjusting screw **1** in arrow direction S.

 Basic setting of rear wheel rear-wheel damping

- without Electronic Suspension Adjustment (ESA II)^{OE}

- Turn adjusting screw as far as possible in direction of arrow H, then turn one and one-half turn in direction of arrow S (Full tank of gas, with rider 187 lbs (85 kg))◀

Electronic suspension adjustment ESA

- with Electronic Suspension Adjustment (ESA II)^{OE}

Settings

Using the electronic suspension adjustment ESA you can conveniently adjust your motorcycle to its loading and the ground. To do this, the loading state must be set and the desired riding mode selected.

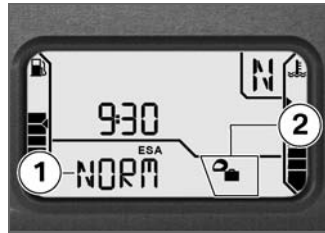

The selected riding mode is indicated in the multifunction display in area **1**, the loading state in area **2**. Three loading states can be set, and there are three riding modes available for each state.

The odometer display is hidden for the duration of the ESA display.

Calling up settings

- Switch on the ignition.



- Press button **1**.
 - » Current setting is displayed.
 - » Display goes out automatically after a few seconds.

Setting riding mode

- Start engine.

▶ The driving mode can be set while driving.◀



- Press button **1**.
 - » Current setting is displayed.
- Press button **1** once in each case.

Starting from the current state, the display is in the following order:

- COMF: comfort mode
- NORM: normal mode
- SPORT: sport mode
- » If no further changes are made, the riding mode is set as indicated. A short time after the

adjustment is completed, the display is automatically hidden again.

Setting loading state

- Start engine.

▷ The loading state cannot be set while driving.◀



- Press button **1**.
 - » Current setting is displayed.
 - Press and hold button **1** until display changes each time.
- Starting from the current state, the display is in the following order:



One-up



One-up with luggage



Two-up (with luggage)

» If no further changes are made, the loading state is set as indicated.

Tires

Checking tire pressure



Incorrect tire inflation pressure results in poorer handling characteristics of the motorcycle and reduces the life of the tires.

Ensure proper tire inflation pressure.◀



At high road speeds, tire valves installed perpendicular to the wheel rim have a

tendency to open as a result of centrifugal force.

In order to avoid a sudden loss of tire inflation pressure, fit a valve cap with rubber sealing ring to the rear tire and make sure that the cap is screwed on firmly.◀

- Make sure ground is level and firm and park motorcycle.
- Check tire pressures against data below.



Tire pressure, front

– 36.3 psi (2.5 bar) (Single rider, with cold tire)

– 36.3 psi (2.5 bar) (Driver with passenger and/or load, with cold tire)



Tire pressure, rear

– 42.1 psi (2.9 bar) (Single rider, with cold tire)



Tire pressure, rear

- 42.1 psi (2.9 bar) (Driver with passenger and/or load, with cold tire)

If tire pressure is too low:

- Correct tire pressure.

Headlight Adjusting headlight for RHD/LHD traffic

If the motorcycle is ridden in a country where the opposite rule of the road applies, its asymmetric low-beam headlight will tend to dazzle oncoming traffic.

Have the headlight adjusted to the relevant conditions by a specialized workshop, preferably an authorized BMW Motorrad retailer.



Ordinary adhesive tape damages the plastic lens.

To prevent damage to the plastic lens, consult a specialized workshop, preferably an authorized BMW Motorrad retailer. ◀

Headlight range and spring preload

The headlight range generally remains constant due to the adjustment of the spring preload to the loading state.

Spring preload adjustment may only be insufficient when the motorcycle is very heavily loaded. In this case, the headlight range must be adjusted to the weight.



If you are unsure whether the basic headlight setting is correct, consult a specialized workshop, preferably an authorized BMW Motorrad retailer. ◀

Headlight range adjustment

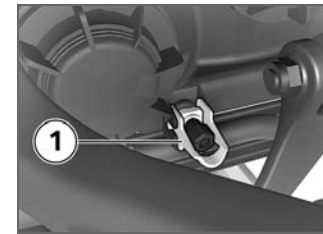

1 Headlight range adjustment

In the case of very high payloads, the available spring preload adjustment might not be adequate. To avoid dazzling oncoming traffic, the headlight adjustment can be corrected by adjusting the swivel lever.

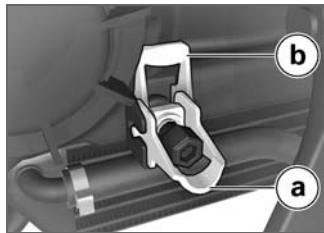

- a** Neutral position
- b** Position with heavy payload

Seat

Removing seat

- Make sure ground is level and firm and park motorcycle.

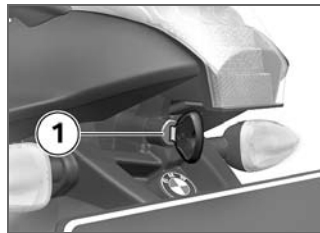

- Turn key in seat lock **1** counterclockwise while pressing down on the rear of the seat.

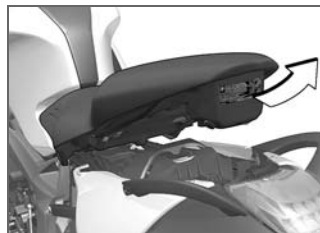

- Raise the seat at the rear.

! If seat is laid on a rough surface, seat edges can be damaged.

Lay the seat on the reference side on a smooth, clean surface, e.g. on the tank. ◀

- Let go of the key and pull the seat from the retaining bracket towards the rear.

Installing seat

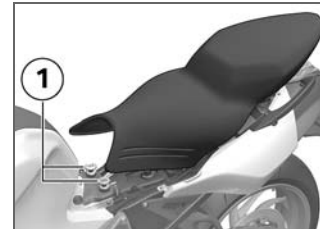

! If too much pressure is applied in the forward direction, there is a danger that the motorcycle will be pushed off its stand.

Make sure that the motorcycle is steady on its stand.◀

- Push the seat forward into the holders **1**, then press down firmly on the rear.
- » The seat can be heard to lock into place.

Helmet holder

- Removing seat (⇒ 67).

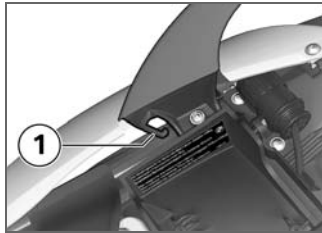

⚠ The helmet catch can scratch the paneling. When hooking on the helmet, watch the position of the helmet lock.◀

- Hook chin strap into helmet holder **1** on left or right.
- Installing seat (⇒ 67).

Luggage loops

- Removing seat (⇒ 67).
- Turn over seat.

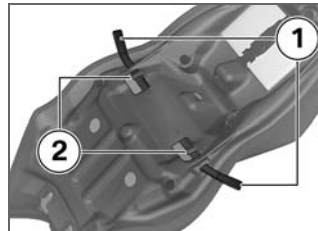

- Take loops **1** out of holders **2** and lay outwards.
- Installing seat (⇒ 67).

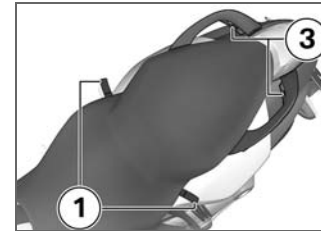

- Use loops **1** and eyes **3** on grab handles in conjunction with luggage belts to lash luggage down to the passenger seat.

Riding

Safety instructions	70
Checklist	71
Starting	72
Running in	74
Shifting gear	75
Brakes	76
Parking your motorcycle	77
Refueling	79
Securing motorcycle for transport	80

Safety instructions

Rider's equipment

Do not ride without the correct clothing. Always wear:

- Helmet
- Rider's suit
- Gloves
- Boots

This applies even to short journeys, and to every season of the year. Your authorized BMW Motorrad retailer will be happy to advise you and has the correct clothing for every purpose.

Speed

If you ride at high speed, always bear in mind that various boundary conditions can adversely affect the handling of your motorcycle:

- Settings of spring-strut and shock absorber system
- Imbalanced load

- Loose clothing
- Insufficient tire inflation pressure
- Poor tire tread
- Etc.

Correct loading

 Overloading and imbalanced loads can adversely affect the motorcycle's handling. Do not exceed the gross weight limit and observe the loading information.◀

Alcohol and drugs

 Even small amounts of alcohol or drugs will adversely affect your perception and your ability to assess situations and make decisions, and slow down your reflexes. Medication can exacerbate these effects.

Do not ride your motorcycle after consuming alcohol, drugs and/or medication.◀

Risk of poisoning

Exhaust fumes contain carbon monoxide, which is colorless and odorless but highly toxic.

 Inhaling exhaust fumes therefore represents a health hazard and can even cause loss of consciousness with fatal consequences.

Do not inhale exhaust fumes. Do not run the engine in closed rooms.◀

High voltage

 Touching live parts of the ignition system with the engine running can cause electric shock.

Do not touch parts of the ignition system when the engine is running.◀

Catalytic converter

If misfiring causes unburned fuel to enter the catalytic converter, there is a danger of overheating and damage.

For this reason, observe the following points:

- Do not run the fuel tank dry
- Do not run the engine with the spark-plug cap removed
- Stop the engine immediately if it misfires
- Use unleaded fuel only
- Comply with all specified maintenance intervals.

 Unburned fuel will destroy the catalytic converter. Note the points listed for protection of the catalytic converter.◀

Risk of fire

Temperatures at the exhaust are high.

 Flammable materials (e.g. hay, leaves, grass, clothing and luggage, etc.) could ignite if allowed to come into contact with the hot exhaust pipe. Make sure that no highly flammable materials can come in contact with the hot exhaust system.◀

 Cooling would be inadequate if the engine were allowed to idle for a lengthy period with the motorcycle at a standstill: overheating would result. In extreme cases, the motorcycle could catch fire. Do not allow the engine to idle unnecessarily. After starting, ride off immediately.◀

Tampering with control unit of electronic engine-management system

 Tampering with the engine control unit can damage the motorcycle and cause accidents. Do not tamper with the engine control unit.◀

 Tampering with the engine control unit can result in mechanical loads that the motorcycle's components are not designed to withstand. Damage caused in this way is not covered by the warranty. Do not tamper with the engine control unit.◀

Checklist

Use the following checklist to check important functions, settings and wear limits before you ride off:

- Brakes
- Front and rear brake fluid levels
- Clutch
- Clutch fluid level
- Shock absorber setting and spring preload
- Tread depth and tire inflation pressure
- Firm seating of cases and luggage

At regular intervals:

- Engine oil level (every time you refuel)
- Brake pad wear (during every third stop for refueling)

Starting

Side stand

You cannot start the motorcycle with the side stand extended and a gear engaged. The engine will switch itself off if you start it with the transmission in neutral

and then engage a gear before retracting the side stand.

Transmission

You can start the engine when the transmission is in neutral or if you pull the clutch with a gear engaged. Do not engage the clutch until after switching on the ignition, as otherwise the engine cannot be started. When the transmission is in neutral, the green neutral indicator light is on and the gear indicator in the multifunction display shows N.

Starting engine

- Switch on the ignition.
 - » Pre-ride check is performed. (►► 73)
 - » ABS self-diagnosis is performed. (►► 73)
 - with automatic Stability Control^{OE}
 - » ASC self-diagnosis is performed. (►► 74)



- Press starter button **1**.

▶ At extremely low temperatures it may be necessary to operate the throttle twist grip during starting. At ambient temperatures below 32 °F (0 °C), actuate the clutch after switching on the ignition.◀

▶ The start attempt is automatically interrupted if battery voltage is too low. Recharge the battery before you start the engine, or use jump leads and a donor battery to start.◀

- » Engine starts.

» Consult the troubleshooting chart if the engine refuses to start. (➔ 136)

Pre-ride check

The instrument cluster runs a test of the 'General' warning light when the ignition is switched on: this is the "Pre-Ride-Check". In the process, the warning light first lights up red and then yellow to test its function. The test is aborted if you start the engine before it completes.

To initialize, the exhaust flap is completely opened once then closed again.

Phase 1

 General warning light shows red.

– CHECK ! is indicated.

Phase 2

 General warning light shows yellow.

– CHECK ! is indicated.

If the 'General' warning light does not show:

 Some malfunctions cannot be indicated if the 'General' warning light cannot be displayed.

Check that the 'General' warning light comes on, and that it shows red and yellow.◀

- Have the malfunction corrected as soon as possible by a specialized workshop, preferably an authorized BMW Motorrad retailer.

ABS self-diagnosis

The readiness for operation of the BMW Motorrad Integral ABS is checked by the self-diagnosis. Self-diagnosis is performed au-

tomatically when you switch on the ignition. To check the wheel sensors, the motorcycle must drive faster than 3 mph (5 km/h).

Phase 1

» Checking the diagnosable system components while stopped.

 ABS warning light flashes.

 Possible country-specific version of ABS warning light.

Phase 2

» Checking the wheel sensors while starting off.

 ABS warning light flashes.

 Possible country-specific version of ABS warning light.

ABS self-diagnosis completed

- » The ABS warning light goes out.

If an ABS fault is indicated after the ABS self-diagnosis is completed:

- Continue driving is possible. It must be noted that neither the ABS nor the integral function is available.
- Have the malfunction corrected as soon as possible by a specialized workshop, preferably an authorized BMW Motorrad retailer.

ASC self-diagnosis

- with automatic Stability Control^{OE}

The readiness for operation of the BMW Motorrad ASC is checked by the self-diagnosis. Self-diagnosis is performed automatically when you switch

on the ignition. So that the ASC self-diagnosis can be completed, the engine must be running and the motorcycle must drive at a speed of at least 3 mph (5 km/h).

Phase 1

- » Checking the diagnosable system components while stopped.



ASC symbol flashes.

Phase 2

- » Checking diagnosable system components while driving.



ASC symbol flashes.

ASC self-diagnosis completed

- » The ASC symbol is no longer displayed.

If an ASC fault is indicated after ASC self-diagnosis is completed:

- Continue driving is possible. It must be noted that the ASC function is not available.
- Have the malfunction corrected as soon as possible by a specialized workshop, preferably an authorized BMW Motorrad retailer.

Running in**The first 600 miles (1,000 km)**

- While running in the motorcycle, vary the throttle opening and engine-speed range frequently.
- Try to do most of your riding during this initial period on twisting, fairly hilly roads, avoiding high-speed main roads and highways if possible.

 Exceeding the specified engine speeds while running will lead to increased engine wear.

Adhere to the specified engine run-in speeds.◀

- Do not exceed the engine run-in speeds.

 Engine break-in speed
– <7000 min ⁻¹

- Do not accelerate at full throttle.
- Avoid low engine speeds at full load.
- After 300 - 750 miles (500 - 1,200 km), have the first inspection performed.

Brake pads

New brake pads must "bed down" and therefore do not achieve their optimum friction levels during the first 300 miles

(500 km). This initial reduction in braking efficiency can be compensated for by exerting greater pressure on the levers.

 New brake pads can extend stopping distance by a significant margin. Brake early.◀

Tires

New tires have a smooth surface. This must be roughened by riding in a restrained manner at various heel angles until the tires are run in. This running in procedure is essential if the tires are to achieve maximum grip.

 New tires have not achieved their full adhesion yet. There is a danger of accidents when driving at extreme angles. Avoid extreme angles.◀

Shifting gear

Gearshift assistant

– with gearshift assistant^{OE}

Your motorcycle is equipped with a shifting assistant developed based on racing requirements. It enables upshifting without actuating the clutch or throttle valve in virtually all load and engine speed ranges. During acceleration the throttle valve can remain open, and the shifting time is reduced to a minimum. The gears are shifted into as usual with foot force on the shift lever.



The sensor **1** in the shift linkage detects the shift request and initiates shifting support.

When driving at constant speed in low gears at high engine speeds, upshifting without clutch operation can result in major load change reactions. , BMW Motorrad recommends only upshifting with clutch operation in these driving situations. The shifting assistant should not be used in the area of the rev-limiter.

No shifting support is provided in the following situations:

- during shifting with engaged clutch
- during shifting with the throttle valve closed (overrun)
- during downshifts<

Brakes

How is the shortest braking distance achieved?

The dynamic load distribution between the front and rear wheel changes during braking. The heavier you brake, the more the front wheel is loaded. The greater the wheel load, the more braking force can be transferred. To achieve the shortest possible braking distance, the front brake must be applied quickly and with increasing force. This optimally utilizes the dynamic load increase on the front wheel. At the

same time, the clutch should also be actuated. With the "forced braking" often practiced in which the brake pressure is generated as quickly as possible and with great force, the dynamic load distribution cannot follow the increased deceleration and the braking force cannot be completely transferred to the road surface. To prevent the front wheel from locking, the ABS system must intervene and reduce the brake pressure; the braking distance increases.

Descending mountain passes

 There is a danger of the brakes fading if you use only the rear brakes when descending mountain passes. Under extreme conditions, the brakes could overheat and suffer severe damage. Use both front and rear brakes,

and make use of the engine's braking effect as well.◀

Wet brakes

 After washing the motorcycle, after driving through water or in the rain, braking can be delayed due to damp brake disks and brake pads. Brake early until the brakes are dry or braked until dry.◀

Salt on brakes

 The full braking effect can be delayed if the motorcycle is ridden on salt-covered roads and the brakes are not applied for some time. Brake early until the salt layer of the brake disks and brake pads has been braked off.◀

Oil or grease on brakes

 Oil and grease on the brake disks and pads considerably diminish braking efficiency. Especially after repair and maintenance tasks, make sure that the brake disks and brake pads are free of oil and grease.◀

Dirt or mud on brakes

 When the motorcycle is ridden on loose surfaces or muddy roads, the brakes may fail to take effect immediately because of dirt or moisture on the disks or brake pads. Brake early until the brakes are braked clean.◀

Parking your motorcycle

Placing on side stand

 If the ground is soft or uneven, there is no guarantee that the motorcycle will rest firmly on the stand. Always check that the ground under the stand is level and firm.◀

- Switch off the engine.
- Pull handbrake lever.
- Hold motorcycle upright and balanced.
- Use your left foot to extend side stand fully.

 The side stand is designed to support only the weight of the motorcycle. Do not lean or sit on the motorcycle with the side stand extended.◀

- Slowly lean the motorcycle to the side until its weight is taken

by the stand and dismount to the left.

 If the motorcycle is on the side stand, the surface of the ground will determine whether it is better to turn the handlebars to the left or right. However, the motorcycle is more stable on a level surface with the handlebars turned to the left than with the handlebars turned to the right.

On level ground, always turn the handlebars to the left to set the steering lock.◀

- Turn handlebars to full left or right lock position.
- Check that the motorcycle is standing firmly.

 On a grade, the motorcycle should always face uphill; select 1st gear.◀

- Lock steering lock.

Remove from side stand

- Unlock steering lock.
- From left, grip handlebars with both hands.
- Pull handbrake lever.
- Swing your right leg over the seat and lift motorcycle to upright position.
- Hold motorcycle upright and balanced.

 An extended side stand can catch on the ground when the motorcycle is moving and lead to a fall.

Retract the side stand before moving the vehicle.◀

- Sit on motorcycle and use your left foot to retract side stand.

Placing on center stand

– with center stand^{OA}

 If the ground is soft or uneven, there is no guarantee

that the motorcycle will rest firmly on the stand.

Always check that the ground under the stand is level and firm.◀

- Switch off the engine.
- Dismount and keep your left hand on left handlebar grip.
- Grasp passenger seat handle or rear frame with your right hand.
- Using your right foot, press center stand toward rear until feet rest on ground.
- Place full weight of body on center stand while pulling motorcycle toward rear.

 Excessive movements could result in the center stand retracting, and the motorcycle would topple as a result.

Do not sit on the motorcycle while it is resting on the center stand.◀

- Check that the motorcycle is standing firmly.
- Lock steering lock.

Pushing off center stand

– with center stand^{OA}

- Unlock steering lock.
- Place your left hand on left handlebar grip.
- With your right hand, grip rear grab handle or rear frame.
- Push motorcycle forward off center stand.
- Make sure that center stand is fully retracted.

Refueling

 Fuel is highly flammable. Fire at the fuel tank can result in fire and explosion. Do not smoke. Never bring a naked flame near the fuel tank.◀

 Fuel expands when exposed to heat. When the tank is overfilled, fuel can escape and get onto the rear wheel. This results in a danger of falling. Do not fill the tank past the bottom edge of the filler neck.◀

 Fuel attacks plastic surfaces, making them cloudy or unattractive. Wipe off any fuel that gets onto plastic parts immediately.◀

 Fuel can attack the material of the windshield; it then becomes dull or unsightly. Wipe off any fuel that gets onto the windshield immediately.◀

 Leaded fuel will destroy the catalytic converter. Use only unleaded fuel.◀

- Make sure the ground is level and firm and park the motorcycle.

- Open protective cap.

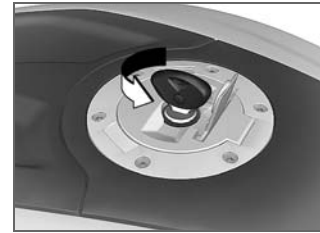

- Open fuel tank cap with ignition key by turning it counter-clockwise.

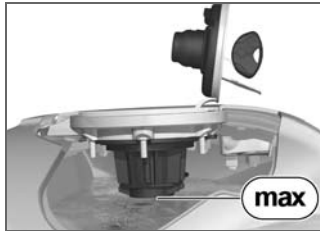

- Refuel with quality listed below at most until lower edge of filler neck is reached.



Recommended fuel quality

– 98 ROZ/RON (Super Plus unleaded)

– 95 ROZ/RON (Super unleaded (fuel type can be used with reduced performance and consumption))



Usable fuel quantity

– Approx. 5 gal (Approx. 19 l)



Reserve fuel quantity

– ≥ 1.1 gal (≥ 4 l)

- Press fuel tank cap down firmly to close.
- Remove key and close protective cap.

Securing motorcycle for transport

- Protect all components along which straps are routed against scratching. For example, use adhesive tape or soft cloths.



The motorcycle can tip away to the side and fall over.

Secure the motorcycle against tipping away to the side. ◀

- Push motorcycle onto transport surface, and do not place on side stand or center stand.

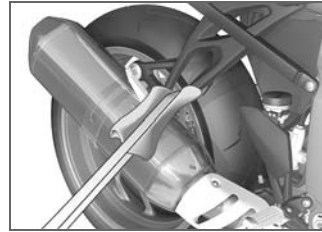
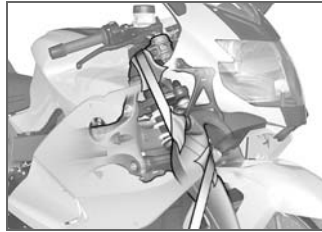

Components can be damaged.

Do not pinch components, e.g. brake lines or wiring harnesses. ◀

- Place front strap over the frame and route downward.
- Guide the strap through the wheel carrier toward the front and tension downward.
- Fasten straps at rear on both sides on passenger footrests and tension.
- Tension all straps evenly; motorcycle should be compressed as greatly as possible.

5

82

Riding

Technology in detail

Brake system with BMW Motorrad
Integral ABS 84

Engine management with BMW
Motorrad ASC 86

Tire Pressure Control RDC 87

Electronic Suspension Adjustment
ESA II 89

Brake system with BMW Motorrad Integral ABS

Partially integral brake

Your motorcycle is equipped with a partially integral brake configuration. Both front and rear brakes are applied simultaneously when you pull the handbrake lever.

The footbrake lever acts only on the rear brake.

The BMW Motorrad Integral ABS adapts the braking force distribution between the front and rear wheel brake to the loading of the motorcycle during braking.

 Spinning of the rear wheel with the front brake pulled (burn out) is made considerably more difficult by the integral function. The result may be damage to the rear wheel brake and the clutch.

Avoid burn-outs. ◀

How does ABS work?

The maximum braking force that can be transferred to the road surface is partially dependent on the friction coefficient of the road surface. Gravel, ice, snow and wet roads offer a considerably poorer friction coefficient than a dry, clean asphalt surface. The poorer the friction coefficient of the road surface is, the longer the braking distance will be.

If the maximum transferrable braking force is exceeded when the driver increases the brake pressure, the wheels begin to block and driving stability is lost, and a fall can result. Before this situation occurs, ABS intervenes and adjusts the brake pressure to the maximum transferrable braking force. This enables the wheels to continue to turn and maintains driving stability regardless of the road surface condition.

What happens when rough roads are encountered?

Bumpy or rough roads can briefly lead to a loss of contact between the tires and the road surface, until the transferrable braking force is reduced to zero. If braking is carried out in this situation, ABS must reduce the brake pressure to ensure driving stability when restoring contact to the road. At this point in time, the BMW Motorrad Integral ABS must assume extremely low friction coefficients (gravel, ice, snow) so that the running wheels turn in every imaginable case and the driving stability is ensured. After detecting the actual conditions, the system adjusts the optimum brake pressure.

How is the BMW Motorrad Integral ABS noticeable to the rider?

If the ABS system must reduce the braking forces due to the conditions described above, then vibrations can be felt at the handbrake lever.

If the handbrake lever is pulled, then braking pressure is built up at the rear wheel with the integral function. If the footbrake pedal is first actuated after this, the brake pressure already built up can be felt earlier than the counter-pressure, than when the footbrake pedal is actuated before or together with the handbrake lever.

Lifting off rear wheel

Even during severe braking, a high level of tire grip can mean that the front wheel does not lock up until very late, if at all. Consequently, ABS does not intervene until very late, if at all.

Under these circumstances the rear wheel can lift off the ground, and the outcome can be a high-siding situation in which the motorcycle can flip over.



Heavy braking can lead to the rear wheel lifting off the ground.

When braking, bear in mind that the ABS control cannot be relied on in all circumstances to prevent the rear wheel from lifting off the ground. ◀

What are the design characteristics of the BMW Motorrad Integral ABS?

The BMW Motorrad Integral ABS ensures driving stability on any surface within the limits of driving physics. The system is not optimized for special requirements resulting under extreme weath-

er conditions offroad or on the racetrack.

Special situations

To detect the tendency of the wheels to lock up, the speeds of the front and rear wheel are compared. If implausible values are detected over a longer period of time, the ABS function is deactivated for safety reasons and an ABS fault is indicated. The condition for a fault message is the completed self-diagnosis. In addition to problems on the BMW Motorrad Integral ABS, unusual driving conditions can also lead to a fault message.

Unusual driving conditions:

- Heating up on the main or auxiliary stand at idle or with gear engaged.
- Rear wheel locked-up for a longer period of time by en-

gine brake, e.g. when riding downhill offroad.

Should a fault message result due to one of the driving conditions described above, the ABS function can be reactivated by switching the ignition off and then on again.

How important is regular maintenance?

 Any technical system is always only as good as its maintenance condition.

To ensure that the BMW Motorrad ABS is in an optimally maintained condition, it is vital that the specified inspection intervals be complied with. ◀

Reserves for safety

But remember: the potentially shorter braking distances which BMW Motorrad Integral ABS permits must not be used as an ex-

cuse for careless riding. ABS is primarily a means of ensuring a safety margin in genuine emergencies.

Take care when cornering. When you apply the brakes on a corner, the motorcycle's weight and momentum take over and even BMW Motorrad Integral ABS is unable to counteract their effects.

Engine management with BMW Motorrad ASC

– with automatic Stability Control^{OE}

How does ASC work?

The BMW Motorrad ASC compares the wheel speeds of the front and rear wheel. From the speed difference the slip, and with it the stability reserves on the rear wheel are determined. When a slip limit is exceeded, the

engine torque is adapted by the engine management system.

What are the design characteristics of the BMW Motorrad ASC?

The BMW Motorrad ASC is an assistance system for the driver and is designed for driving on public roads. Especially in at the limits of driving physics, the driver has a considerable influence on the control options of the ASC (shifting weight in curves, loose loads). The system is not optimized for special requirements resulting under extreme weather conditions offroad or on the racetrack. The BMW Motorrad ASC can be deactivated for these cases.

 Even with ASC, physical laws cannot be overridden. The driver is always responsible for adapting his/her driving style. Do not reduce the additional

safety provided with risky driving.◀

Special situations

At an increasing angle, the acceleration performance is increasingly limited in accordance with physical laws. This can result in delayed acceleration when coming out of very tight curves.

To detect spinning or slipping away of the rear wheel, the speeds of the front and rear wheel are compared. If implausible values are detected over a longer period of time, the ASC function is deactivated for safety reasons and an ASC fault is indicated. The condition for a fault message is the completed self-diagnosis.

In the following unusual driving states, the BMW Motorrad ASC can be automatically deactivated.

Unusual driving conditions:

- Driving on the rear wheel (wheely) for a longer period with ASC deactivated.
- Rear wheel spinning in place with front brake pulled (burn out).
- Heating up on the main or auxiliary stand at idle or with gear engaged.

The ASC is reactivated by switching the ignition on and off and then driving at a speed above 5 mph (10 km/h).

If the front wheel loses contact to the ground during extreme acceleration, the ASC reduces the engine torque until the front wheel touches the ground again. In this case, BMW Motorrad recommends turning back the throttle twist grip somewhat to achieve a stable driving state again as quickly as possible.

On a slippery surface, the throttle twist grip should never be suddenly turned back completely without pull the clutch at the same time. The engine braking torque can cause the rear wheel to block, resulting in an unstable driving state. This case cannot be controlled by the BMW Motorrad ASC.

Tire Pressure Control RDC

- with Tire Pressure Control (TPC/RDC)^{OE}

Function

A sensor is located in each tire, which measures the air temperature and the inflation pressure inside the tire and sends these values to the control unit.

The sensors are equipped with a centrifugal controller, which does not enable the transmission of the measured values un-

til a speed of approx. 20 mph (30 km/h) is reached. Before initial reception of the tire inflation pressure, -- is shown in the display for each tire. The sensors continue to transmit the measured values for approx. 15 minutes after the motorcycle comes to a stop.

The control unit can manage four sensors, and as a result two sets of wheels with RDC sensors can be driven. If a RDC control unit is installed, however the wheels have no sensors, then an error message is output.

Tire inflation pressure ranges

The RDC control unit distinguishes between three tire inflation pressure ranges matched to the motorcycle:

- Inflation pressure within the permissible tolerance.
- Inflation pressure at the limits of the permissible tolerance.
- Inflation pressure outside the permissible tolerance.

Temperature compensation

The tire inflation pressures are shown temperature-compensated in the multifunction display; they refer to a tire air temperature of 68 °F (20 °C). As the air-pressure testers at filling stations show a temperature-dependent tire inflation pressure, they do not match the values indicated in the multifunction display in most cases.

Adjusting inflation pressure

Compare the TPC/RDC value in the multifunction display with the value on the back cover of the Rider's Manual. The difference between the two values must be compensated with the air pressure tester at the filling station.

Example: According to the Rider's Manual, the tire inflation pressure is to be 36.3 psi (2.5 bar), however 33.4 psi (2.3 bar) is shown in the multifunction display, i.e. it is low by 2.9 psi (0.2 bar). The tester at the filling station indicates 34.8 psi (2.4 bar). This value must be increased by 2.9 psi (0.2 bar) to 37.7 psi (2.6 bar) to produce the correct tire inflation pressure.

Electronic Suspension Adjustment ESA II

– with Electronic Suspension Adjustment (ESA II)^{OE}

Chassis adjustments

The proper loading state must first be selected when the motorcycle is stationary according to the motorcycle's load. Depending on the riding mode selected, the dampings are set on both spring struts and the spring base and spring rate are set on the rear spring strut. If the selected riding mode is changed, the spring rate on the rear spring strut is also adjusted in addition to the damping of both spring struts. This enables very precise adjustment of the chassis to all riding conditions, including while riding.

- The combination of spring base, damping and spring rate ensures the chassis geometry is always appropriate.
- The static normal position is virtually maintained while riding.
- The different riding and loading conditions are offset so that the handling of the motorcycle remains constant.

It is possible to electrically change the spring rate through the combination of a conventional coil spring with a plastic element (Elastogran), the lateral expansion of which can be electrohydraulically limited using a displaceable sleeve. The more the sleeve surrounds the plastic element, the more its expansion is limited and the spring rate increases. The highest spring rate is achieved when the sleeve completely encloses the plastic element and sits on the steel

spring. Accordingly, the spring rate is lower, the less the sleeve limits the expansion of the plastic element.

Accessories

General instructions..... 92
Onboard socket..... 92
Luggage 93
Case..... 94
Flat tire kit 96

General instructions

BMW Motorrad recommends the use of parts and accessories for your motorcycle that are approved by BMW for this purpose. Your authorized BMW Motorrad retailer is the right place to go for genuine BMW parts and accessories, other BMW-approved products, and expert advice on their installation and use.

These parts and products have been tested by BMW for safety, function and suitability. BMW accepts product liability for these products.

Conversely, BMW is unable to accept any liability whatsoever for parts and accessories which it has not approved.

 BMW Motorrad cannot examine or test each product of outside origin to ensure that it can be used on or in connection with BMW motorcycles without

constituting a safety hazard. Nor is this guarantee provided when the official approval of a specific country has been granted. Tests conducted by these instances cannot make provision for all operating conditions experienced by BMW motorcycles and, consequently, they are not sufficient in some circumstances.

Use only parts and accessories approved by BMW for your motorcycle. ◀

Whenever you are planning modifications, comply with all the legal requirements. The motorcycle must not infringe on national road-vehicle construction and use regulations.

Onboard socket

Ratings



The supply to the socket **1** is cut off automatically if battery voltage is too low or the load exceeds the maximum rating.

Operating electrical accessories

You can start using electrical accessories only when the ignition is switched on. The accessory remains operational if the ignition is subsequently switched off. Approx. 15 minutes after switching off the ignition and/or during

starting, the onboard socket is switched off to take the load off the motorcycle electrical system.

Cable routing

The cables from the onboard socket to the auxiliary device must be routed in such a way that they:

- Do not impede the rider
- Do not restrict or obstruct the steering angle and handling characteristics
- Cannot be trapped



Improperly routed cables can impede the rider. Route the cables as described above.◀

Luggage

Correct loading



Overloading and imbalanced loads can adversely affect the motorcycle's handling. Do not exceed the gross weight

limit and observe the loading information.◀

- Adjust setting of spring preload, damping characteristic and tire inflation pressures to suit total weight.
- with case^{OA}
- Ensure that case volumes on left and right are equal.
- Make sure that weight is uniformly distributed between right and left.
- Pack heavy items of luggage downwards and inwards.
- Observe maximum payload of case and corresponding top speed.

 Payload of case
- ≤18 lbs (≤8 kg)

 Speed limit for driving with case
- ≤112 mph (≤180 km/h)◀

- with tank rucksack^{OA}

- Observe maximum payload of tank rucksack and corresponding top speed.

 Payload of tank rucksack
- max 11 lbs (max 5 kg)

 Speed limit for driving with tank rucksack
- max 81 mph (max 130 km/h)◀

- with tank bag^{OA}

- Observe maximum payload of tank bag and corresponding top speed.



Payload of tank bag

– ≤11 lbs (≤5 kg)



Speed limit for driving with tank bag

– ≤81 mph (≤130 km/h)◁

Case

– with case^{OA}

Opening case



- Turn lock barrel in direction OPEN.

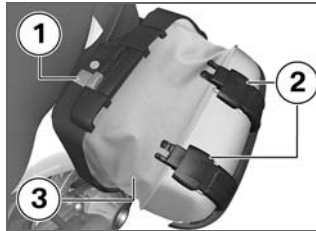

- Pull gray release lever **1** (OPEN) upward.
- » Lock straps **2** open.
- Pull gray release lever (OPEN) upwards again while simultaneously pulling case lid **3** out of retainer.

Closing case

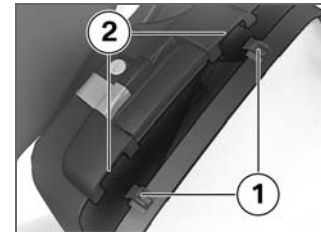

- Press catches **1** of case lid into retainers **2**.
- » The catches can be heard to lock into place.
- Press catches of lock straps into locking devices **2**.
- » The catches can be heard to lock into place.
- Check secure fastening of case lid and lock straps.

Adjusting case volume

- Open case and close only the case lid again.



- Turn lock strap buckles **1** of lock straps outward.
- Pull out the lock straps upwards to their full extent.
 - » The maximum volume has been set.



- Close lock straps.
- Press lock straps against case body.
 - » The case volume is adapted to the contents.

Removing case



- Turn lock barrel in direction RELEASE.

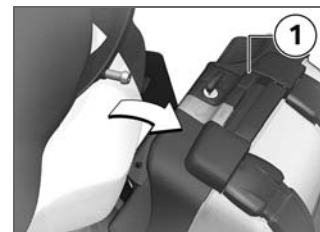

- Pull black release lever **1** (RELEASE) upwards while simul-

- taneously pulling the case outward.
- Then lift case out of lower mounting.

Mounting case

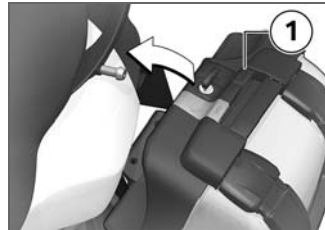

- Hook case into lower mounting.
- Pull black release lever **1** (RELEASE) upwards while simultaneously pushing the case into upper mounting.
- Press black release lever (RELEASE) downward.
- Check case for secure hold.

Secure hold

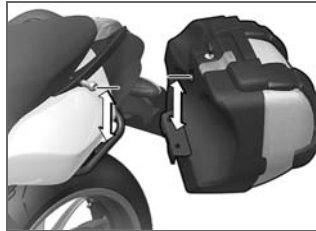

If a case wobbles or is difficult to fit, it has to be adapted to the gap between the upper and lower mounting. The height of the lower holder for the case can be changed on the inside of the case.

Flat tire kit

– with flat tire kit^{OA}

Stowing flat tire kit

- Removing seat (➔ 67).

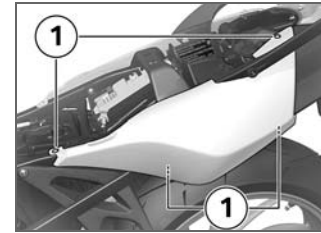

- Remove screws **1** and side trim.

▶ To protect the side panel from scratches, lay it on the seat.◀



- Position flat tire kit using a rubber band as shown.

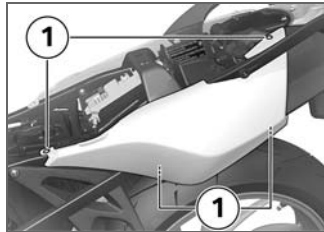

- Attach side trim and fit screws **1**.
- Installing seat (➔ 67).

Accessories

Maintenance

General instructions.....	100
Toolkit	100
Engine oil	101
Brake system	102
Brake pads	102
Brake fluid	104
Clutch	106
Tires	107
Rims	107
Wheels	108
Front wheel stand	116
Rear-wheel stand	117
Lamps	118
Jump-starting.....	125
Battery.....	126



General instructions

The 'Maintenance' chapter describes work involving the checking and replacement of wear parts that can be performed with a minimum of effort.

If special tightening torques are to be taken into account for assembly, these are listed. An overview of all required tightening torques is contained in the chapter "Technical Data".

Information on additional maintenance and repair work is provided in the Repair Manual for your motorcycle on DVD, which you can obtain from your authorized BMW Motorrad retailer.

Special tools and thorough specialized knowledge are required to carry out some of the work described here. If you are in doubt, consult a certified workshop, preferably your authorized BMW Motorrad retailer.

Toolkit

Toolkit

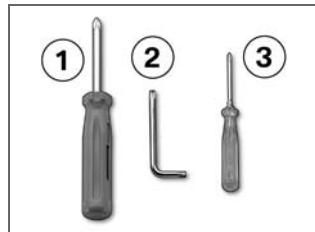

- 1 Reversible screwdriver with Phillips and straight blade
- 2 TORX wrench, T25
- 3 Small screwdriver with Phillips blade

Onboard-toolkit service set

– with service toolkit^{OA}

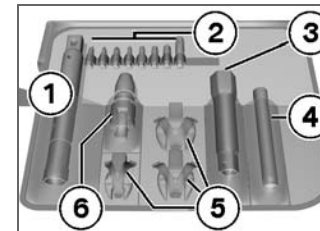

- 1 Pull-out tool holder for mounting all tools via adapters and for removing spark plug
- 2 1/4" bits
Bits of various sizes
- 3 3/8" Allen key, 22 mm for removing quick-release axle on front wheel
- 4 Flashlight
- 5 Socket wrench
Open-ended wrenches of various sizes

- 6 Adapter for holding 1/4" bits and 9x12 mm and 3/8" jointed adapter

Engine oil

Checking engine oil level

- without center stand^{OA}
- Make sure ground is level and firm and hold motorcycle at operating temperature vertically.<
- with center stand^{OA}
- Make sure ground is level and firm and place motorcycle at operating temperature on its center stand.<

 After longer motorcycle immobilization periods, engine oil can collect in the oil pan; this must be pumped into the oil tank before the reading is taken. Here, the engine oil must be at operating temperature. Checking the oil level with the engine cold

or after a short trip leads to misinterpretations and therefore to incorrect oil fill quantities. To ensure that the display of the engine oil level is correct, only check the oil level after a longer trip.<

- Let the engine run in neutral for one minute.
- Switch off ignition.

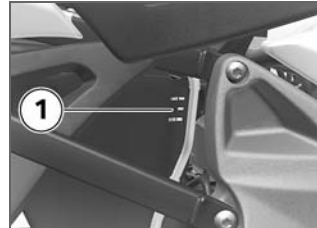

- Read off the oil level from the display **1**.



 Specified level of engine oil

- between MIN and MAX marking

If oil level is below MIN mark:

- Topping up engine oil (➔ 102).

If the oil level is above the MAX mark:

- Have oil level corrected by a specialized workshop, preferably an authorized BMW Motorrad retailer.

Topping up engine oil

- Removing seat (➔ 67).
- Wipe area around fill location clean.



- Remove cap from oil fill location **1** by turning counterclockwise.

⚠ Both too little and too much engine oil can lead to engine damage. Always make sure that the oil level is correct.◀

- Add engine oil up to specified level.

- Checking engine oil level (➔ 101).
- Install cap of oil fill location **1** by turning clockwise.
- Installing seat (➔ 67).

Brake system

Operating safety

A fully functional brake system is a basic requirement for the road safety of your motorcycle.

Do not ride the motorcycle if you have any doubts about the dependability of the brake system.

In this case, have the brake system checked by a specialized workshop, preferably by an authorized BMW Motorrad retailer.

⚠ Incorrect working practices endanger the reliability of the brakes.

Have all work on the brake system performed by a specialized

workshop, preferably by an authorized BMW Motorrad retailer.◀

Checking brake operation

- Pull handbrake lever.
 - » Pressure point must be clearly perceptible.
- Press footbrake lever.
 - » Pressure point must be clearly perceptible.

Brake pads

Checking front brake pad thickness

⚠ Dropping below the minimum pad thickness leads to reduced braking performance and may result in damage to the brakes.

In order to ensure the operating reliability of the brake system, make sure that the brake pads are not worn beyond their minimum thickness.◀

- Make sure ground is level and firm and park motorcycle.

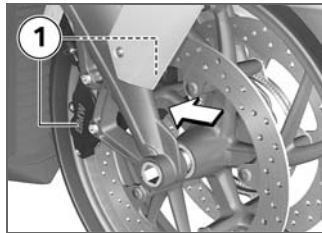

- Visually inspect the left and right brake pads to ascertain their thickness. Direction of view: between wheel and front wheel control to brake calipers **1**.

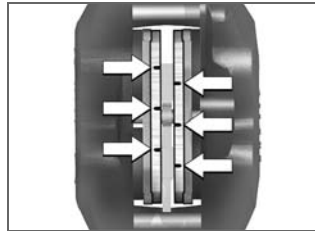

 Front brake-pad wear limit

– min 0.04 in (min 1 mm) (Only friction material without carrier plate. Wear markings (grooves) must be clearly visible.)

If the wear indicating mark is no longer clearly visible:

- Have the brake pads replaced by a specialized workshop, preferably an authorized BMW Motorrad retailer.

Checking rear brake pad thickness

 Dropping below the minimum pad thickness leads to reduced braking performance and may result in damage to the brakes.

In order to ensure the operating reliability of the brake system, make sure that the brake pads are not worn beyond their minimum thickness.◀

- Make sure the ground is level and firm and park the motorcycle.



- Check the brake pad thickness with visual inspection. Direction of view: from right to brake caliper **1**.

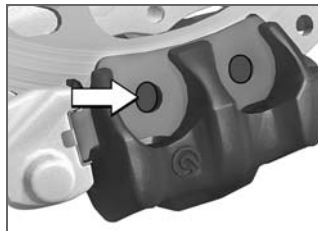

Rear brake-pad wear limit

– min 0.04 in (min 1.0 mm)
(Only friction material without carrier plate. Brake disk must not be visible through bore hole of inner brake pad.)

If brake disk is visible:

- Have the brake pads replaced by a specialized workshop, preferably an authorized BMW Motorrad retailer.

Brake fluid

Checking front brake fluid level

- without center stand^{OA}
 - Make sure ground is level and firm and hold motorcycle vertically.<
- with center stand^{OA}
 - Make sure ground is level and firm and place motorcycle on its center stand.<
 - Move handlebars into straight-ahead position.



⚠ A low fluid level in the brake reservoir can allow air to penetrate the brake system. This significantly reduces braking efficiency. Check brake fluid level regularly.◀

- Read off brake fluid level at brake-fluid reservoir **1**.

▷ In the event of brake pad wear, the brake fluid level in the brake-fluid reservoir falls.◀



 Front brake fluid level
– Brake fluid DOT4
– The brake fluid level must not fall below the MIN mark. (Brake fluid reservoir horizontal, motorcycle standing upright and handlebars straight ahead)

If brake fluid level drops below permissible level:

- Have the defect corrected as soon as possible by a specialized workshop, preferably an

authorized BMW Motorrad retailer.

Checking rear brake fluid level

- without center stand^{OA}
 - Make sure the ground is level and firm and hold motorcycle vertically.◀
- with center stand^{OA}
 - Make sure ground is level and firm and place motorcycle on its center stand.◀

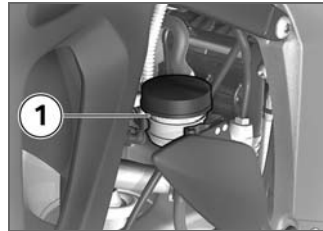

! A low fluid level in the brake reservoir can allow air to penetrate the brake system. This significantly reduces braking efficiency. Check brake fluid level regularly.◀

- Read off brake fluid level at brake-fluid reservoir **1**.

▷ In the event of brake pad wear, the brake fluid level in the brake-fluid reservoir falls.◀



 Rear brake fluid level

– Brake fluid DOT4

– The brake fluid level must not fall below the MIN mark. (Brake-fluid reservoir horizontal, motorcycle standing upright)

If brake fluid level drops below permissible level:

- Have the defect corrected as soon as possible by a specialized workshop, preferably an

authorized BMW Motorrad retailer.

Clutch

Checking clutch operation

- Pull the clutch lever.
 - » Pressure point must be clearly perceptible.
- If no clear pressure point can be felt:

- Have the clutch checked by a specialized workshop, preferably an authorized BMW Motorrad retailer.

Checking clutch fluid level

– without center stand^{OA}

- Make sure the ground is level and firm and hold motorcycle vertically.◀

– with center stand^{OA}

- Make sure ground is level and firm and place motorcycle on its center stand.◀

- Move handlebars into straight-ahead position.



- Read off clutch fluid level at clutch fluid reservoir **1**.

▷ The fluid level in the clutch fluid reservoir rises due to clutch wear.◀

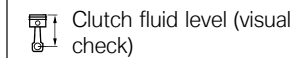

Clutch fluid level (visual check)

– Clutch fluid level must not drop.

If fluid level drops:

⚠ Unsuitable hydraulic fluids could cause damage to the clutch system.

No fluids may be poured in.◀

- Have the defect corrected as soon as possible by a specialized workshop, preferably an authorized BMW Motorrad retailer.

▷ The clutch system is filled with a special hydraulic fluid that does not require changing.◀

Tires

Checking tire tread depth

⚠ The handling of your motorcycle can already change for the worse before the legally prescribed minimum tread depth is reached.

Have tires replaced even before the minimum tread depth is reached.◀

- Make sure ground is level and firm and park motorcycle.
- Measure tire tread depth in main tread grooves with wear indicating marks.

▷ Tires have wear indicators integrated into the main tread grooves. If the tire tread has worn down to the level of the marks, the tire is completely worn. The locations of the marks are indicated on the edge of the tire, e.g. by the letters TI, TWI or by an arrow.◀

When the minimum tread depth is reached:

- Replace tires concerned.

Rims

Checking rims

- Make sure the ground is level and firm and park the motorcycle.

- Visually inspect rims for defects.
- Have damaged rims checked and, if necessary, replaced by a specialized workshop, preferably an authorized BMW Motorrad retailer.

Wheels

Tire recommendation

For every size of tire, BMW Motorrad has tested and approved certain makes as roadworthy. BMW Motorrad cannot evaluate the suitability of other tires, and can therefore take no responsibility for their driving safety.

BMW Motorrad recommends only using the tires tested and approved by BMW Motorrad. Extensive information is available at your authorized BMW Motorrad retailer or on the Internet at www.bmw-motorrad.com.

Affect of wheel sizes on chassis control systems

The wheel sizes play a major role in the chassis control systems ABS and ASC. Especially the diameter and width of the wheels are stored in the control unit as the basis for all necessary calculations. A change in these sizes due to conversion to others than the wheels installed as standard equipment can seriously affect the control comfort of these systems.

The sensor wheels required for wheel speed detection must also match the control systems installed and may not be replaced. If you want to equip your motorcycle with different wheels, please speak to a specialized workshop, and preferably a BMW Motorrad retailer. In some cases the data stored in the control units can be adapted to the new wheel sizes.

TPC/RDC sticker

– with Tire Pressure Control (TPC/RDC)^{OE}

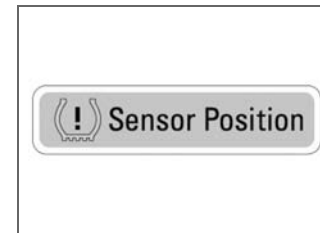

 The TPC sensors can be damaged by improper tire mounting. Inform the BMW Motorrad retailer or the specialized workshop that the wheel is equipped with a TPC sensor.◀

On motorcycles equipped with TPC/RDC, a corresponding sticker is located on the wheel rim at the position of the TPC/RDC sensor. During a tire change it

must be ensured that the TPC/RDC sensor is not damaged. Inform the BMW Motorrad retailer or the specialized workshop of the TPC/RDC sensor.

Removing front wheel

- Make sure the ground is level and firm and park the motorcycle.

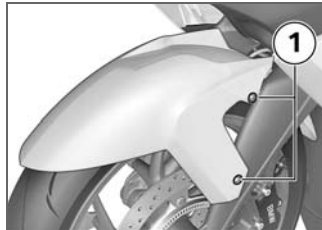

- Remove screws **1** on left and right.
- Pull out front wheel cover toward front.

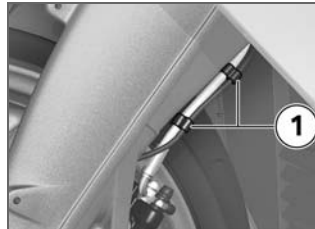

- Unclip two retaining clips **1** of the ABS sensor cable on brake line.
- Mask off area of wheel rim that could be scratched in process of removing brake calipers.

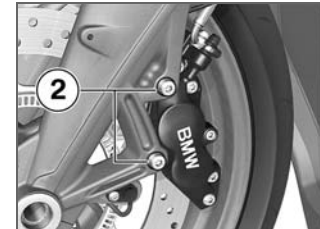

⚠ Once the calipers have been removed, there is a risk of the brake pads being pressed together to the extent that they cannot be slipped back over the brake disk on reassembly. Do not operate the handbrake lever when the brake calipers have been removed.◀

- Remove securing screws **2** of left and right brake calipers.

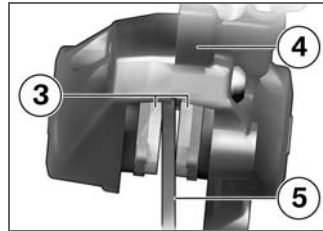

- Push brake pads **3** apart slightly by rocking the brake caliper **4** back and forth against the brake disk **5**.
- Carefully pull brake calipers back and out until clear of brake disks.
- When pulling off left brake caliper, make sure that ABS sensor cable is not damaged.

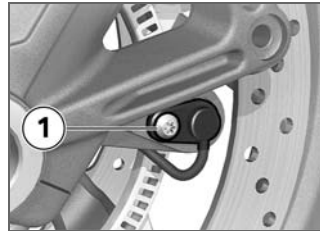

- Remove screw **1** and take ABS sensor out of hole.
- without center stand^{OA}
- Place motorcycle on an auxiliary stand; BMW Motorrad recommends BMW Motorrad rear wheel stand.
- Installing rear-wheel stand (→ 117).<
- with center stand^{OA}
- Make sure ground is level and firm and place motorcycle on its center stand.<

- Raise front of motorcycle until the front wheel can turn freely. BMW Motorrad recommends the BMW Motorrad front-wheel stand for lifting the motorcycle.
- Fitting front wheel stand (→ 116).

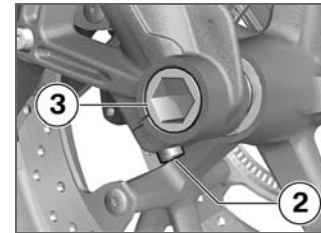

- ⚠ The left axle clamping screw fixes the threaded bush in place in the front suspension. A poorly aligned threaded bush results in incorrect spacing between the ABS sensor ring and the ABS sensor, and therefore to ABS malfunctions or destruction of the ABS sensor.

To ensure the proper alignment of the threaded bush, do not loosen or remove the left axle clamping screw.◀

- Remove right-hand axle clamping screw **2**.
- Remove quick-release axle **3** while supporting wheel.
- Place the front wheel in the front wheel guide on the ground.

 The ABS sensor can be damaged when rolling out the front wheel.

Watch the ABS sensor when rolling out the front wheel.◀

- Roll front wheel forward to remove.

Installing front wheel

 Malfunctions may occur during control interventions by ABS and ASC if a wheel other than the standard wheel is installed.

Please see the information on the effect of wheel sizes on the chassis control systems ABS and ASC at the beginning of this chapter.◀

 Threaded fasteners not tightened to the specified torque can work loose or their threads can suffer damage. Always have the tightening torques checked by a specialized workshop, preferably an authorized BMW Motorrad retailer.◀

 The front wheel must be installed right way round to rotate in the correct direction. Observe the direction of rotation arrows on the tires or on the rim.◀

- Roll front wheel into front wheel guide.

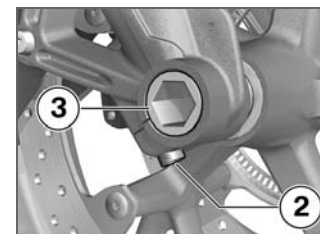

- Lift front wheel and install quick-release axle **3** with torque.

 Quick-release axle in threaded bush

– 37 lb/ft (50 Nm)

- Tighten the right-hand axle clamping screw **2** with the specified torque.

 Clamping bolt in wheel carrier

– 14 lb/ft (19 Nm)

- Remove front wheel stand.

- without center stand^{OA}
- Remove rear wheel stand.<

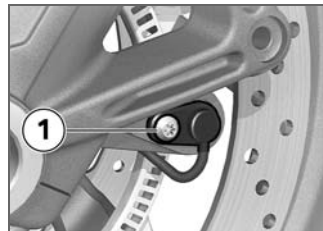

- Insert ABS sensor into hole and install screw **1**.
- Ease brake calipers onto brake disks.

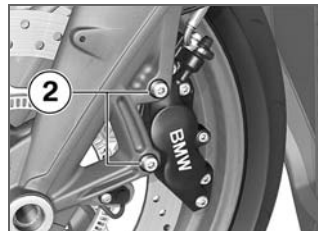

- Install securing screws **2** on left and right with specified torque.

Front brake caliper on wheel carrier

– 22 lb/ft (30 Nm)



- Clip in the two retaining clips **1** for the ABS sensor cable on the brake line.
- Remove adhesive tape from wheel rim.
- Press handbrake lever firmly a number of times until resistance point is felt.

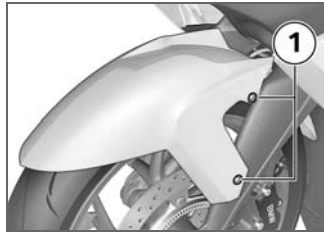

- Install front wheel cover and fit screws **1** on right and left.

Removing rear wheel

– without center stand^{OA}

- Place motorcycle on an auxiliary stand; BMW Motorrad recommends BMW Motorrad rear wheel stand.
- Installing rear-wheel stand (→ 117).<

– with center stand^{OA}

- Make sure ground is level and firm and place motorcycle on its center stand.<

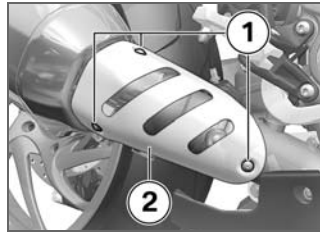

- Remove three screws **1** on the muffer cover **2**.
- Take off cover.

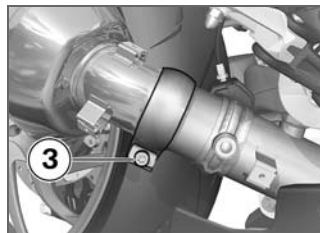

- Loosen screw **3** on clamp far enough that the clip can be twisted.

- Do not remove sealing grease from clamp.



- Remove screw **4** on the rear footrest while supporting the end muffler.

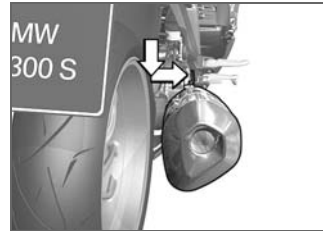

- First turn the end muffler downward slightly and then outward.
- Engage first gear.

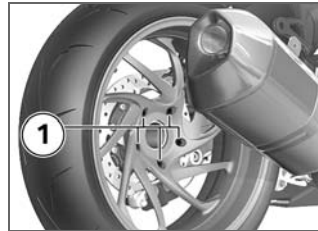

- Remove five screws **1** on rear wheel, holding wheel as you do so.
- When using the BMW Motorrad rear wheel stand: remove the lock washer.
- Lower rear wheel to the ground and roll out toward rear.
- When using the BMW Motorrad rear wheel stand: remount the lock washer.

Installing rear wheel

 Malfunctions may occur during control interventions by ABS and ASC if a wheel other

than the standard wheel is installed.

Please see the information on the effect of wheel sizes on the chassis control systems ABS and ASC at the beginning of this chapter. ◀

 Threaded fasteners not tightened to the specified torque can work loose or their threads can suffer damage. Always have the tightening torques checked by a specialized workshop, preferably an authorized BMW Motorrad retailer. ◀

- When using the BMW Motorrad rear wheel stand: remove the lock washer.
- Roll and mount rear wheel onto rear wheel support.
- When using the BMW Motorrad rear wheel stand: remount the lock washer.

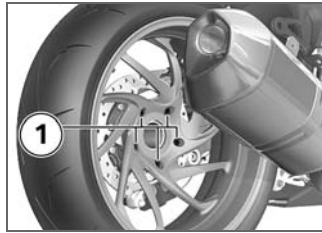

- Fit five screws **1** and tighten diagonally with specified torque.

 Tighten rear wheel on wheel flange
– Tightening sequence: diagonally
– 44 lb/ft (60 Nm)

- Turn the end muffler to its initial position.

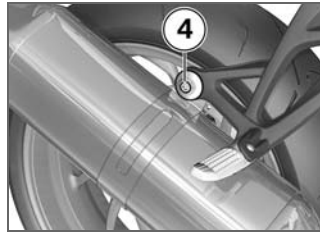

- Tighten screw **4** on the rear footrest with the appropriate torque.

 Muffler on passenger footrest
– 16 lb/ft (22 Nm)

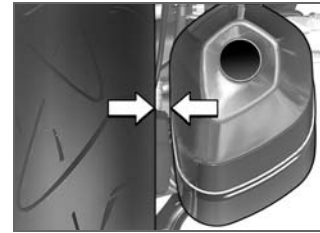

- Align end muffler in such a way that the grip of the plug-selectable screwdriver (toolkit) fits between the tires and end muffler.

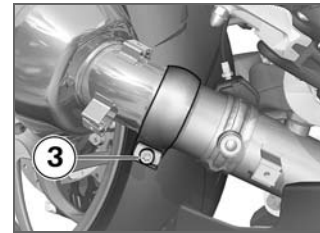

- Align clip as shown.

- Tighten screw **3** on the clamp with the appropriate torque.



Muffler with ball-joint clamp on manifold

– 26 lb/ft (35 Nm)

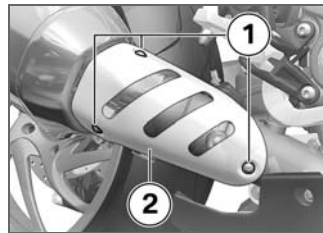

- Position muffer cover **2** and fit three screws **1**.

- without center stand^{OA}
- Remove rear wheel stand.<

Front wheel stand

Fitting front wheel stand



The BMW Motorrad front wheel stand is not designed for holding motorcycles without a center or other auxiliary stands. A motorcycle standing on the front wheel stand and the rear wheel alone can fall over.

Place the motorcycle on the center stand or an auxiliary stand before lifting it with the BMW Motorrad front wheel stand.<

- Use basic stand with tool number (0 402 241) in combination with front-wheel adapter (0 402 243).

– without center stand^{OA}

- Place motorcycle on an auxiliary stand; BMW Motorrad recommends BMW Motorrad rear wheel stand.

- Installing rear-wheel stand (➔ 117).<

– with center stand^{OA}

- Make sure ground is level and firm and place motorcycle on its center stand.<

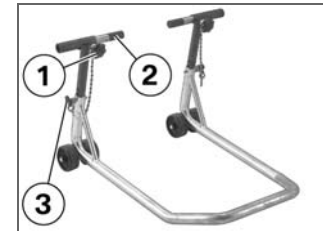

- Loosen adjusting screws **1**.
- Push two mounting pins **2** far enough apart that front suspension fits between them.
- Use locating pins **3** to set front wheel stand to desired height.
- Center front wheel stand relative to front wheel and push it against front axle.

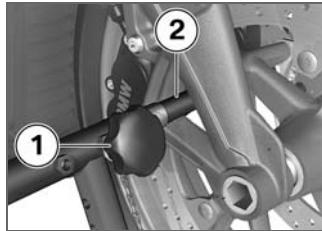

⚠ The sensor ring of the BMW Motorrad Integral ABS can be damaged. Only push the left mounting pin so far inward that it does not touch the sensor ring.◀

- Push two mounting pins **2** through triangles of brake caliper support toward inside so that front wheel can still be rolled through.
- Tighten adjusting screws **1**.



⚠ If the motorcycle is resting on the center stand: The motorcycle is raised too far at the front, the center stand lifts off the ground and the motorcycle can tip over to the side. When raising the motorcycle, make sure that the center stand remains on the ground.◀

- Apply uniform pressure to push front wheel stand down and raise motorcycle.

Rear-wheel stand Installing rear-wheel stand

- Use basic stand with tool number (0 402 245) with rear axle adapter (0 402 250).

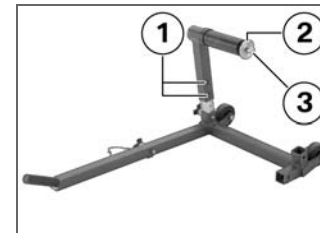

- Set desired height of rear wheel stand using bolts **1**.
- Remove the lock washer **2**; to do so, press the unlock button **3**.
- Make sure ground is level and firm and place the motorcycle on its side stand.

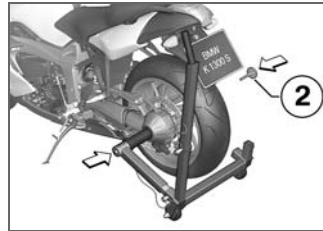

- Push rear wheel stand from left into rear axle.
- Mount lock washer **2** from right by pressing release button.
- With your left hand, grab the passenger grab handle of the motorcycle and with your right hand grab the grip of the rear wheel stand.

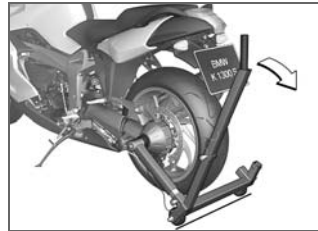

- Position motorcycle vertically while simultaneously pressing the grip of the stand back so that both of the stand's rollers rest on the ground.
- Then press the grip down to the ground.

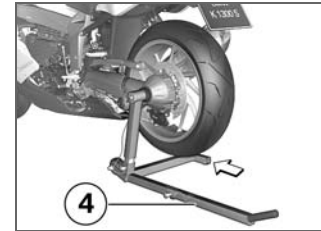

- To ensure a secure position, install lever **4** on the short side of the stand.

Lamps

General instructions

A warning appears in the multi-function display if a bulb is defective. If the brake or rear light fails, the symbol is accompanied by the 'General' warning light, which lights up yellow.

 A defective bulb places your safety at risk because it is easier for other users to oversee the motorcycle.

Replace defective bulbs as soon as possible; always carry a complete set of spare bulbs if possible.◀

 The bulb is pressurized and can cause injury if damaged.

Wear eye and hand protection when replacing bulbs.◀

 An overview of the bulb types installed in your motorcycle is provided in the chapter "Technical Data".◀

 Do not touch the glass of new bulbs with your fingers. For installation, use a clean, dry cloth. Dirt deposits, in particular oil and grease, interfere with heat radiation from the bulb. Overheating and therefore short service life of the bulbs are the consequence.◀

Replacing low-beam and high-beam bulbs

 The alignment of the connector may differ from the illustration depending on the bulb to be replaced.◀

- Make sure the ground is level and firm and park the motorcycle.
- Switch off the ignition.



- Remove the covers **1** on the high-beam bulbs and/or the cover **2** on the low-beam bulbs by turning counterclockwise.



- Disconnect plug **3**.

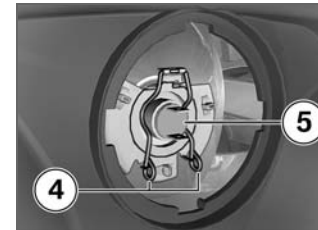

- Remove spring strap **4** from detents and fold up.
- Remove bulb **5**.

- Replace defective bulb.

 Bulbs for low-beam headlight

– H7 / 12 V / 55 W

 Bulb for high-beam headlight

– H7 / 12 V / 55 W

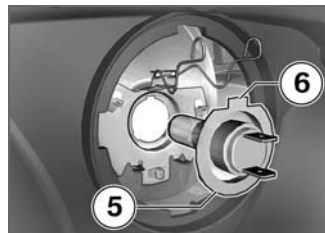

- Insert bulb **5** while ensuring correct position of lug **6**.

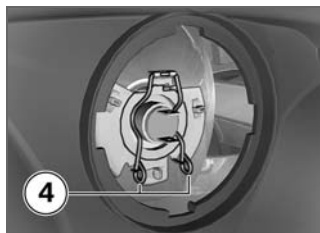

- Install spring straps **4** in locks.

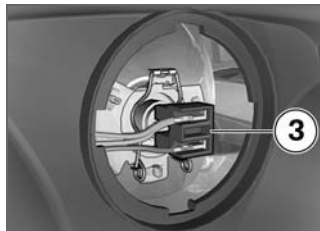

- Close connector **3**.



- Install covers **1** for high-beam bulbs and/or cover **2** for low-beam bulbs by turning clockwise.

Replacing parking light bulb

- Make sure the ground is level and firm and park the motorcycle.
- Switch off the ignition.

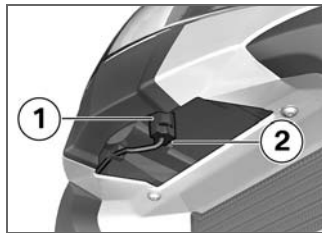

- Unlock and disconnect plug connection **1** beneath headlight at position **2**.



- Remove bulb socket **3** from the headlight housing from be-

low by turning it counterclockwise.

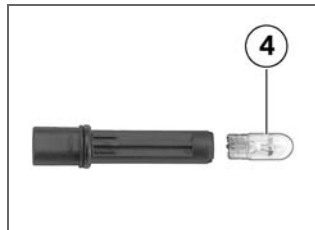

- Remove bulb **4** from bulb holder.
- Replace defective bulb.

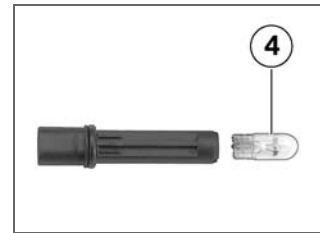
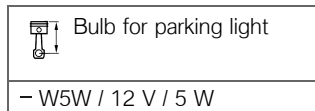

- Insert bulb **4** into bulb socket.



- Install bulb socket **3** in headlight housing from below by turning clockwise.

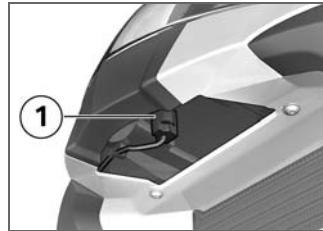

- Close connector **1** below headlight.

Replacing front turn indicator bulbs

⚠ If it is not standing firmly, the motorcycle could topple in the course of the operations described below.

Make sure that the motorcycle is steady on its stand. ◀

- Make sure the ground is level and firm and park the motorcycle.
- Switch off the ignition.

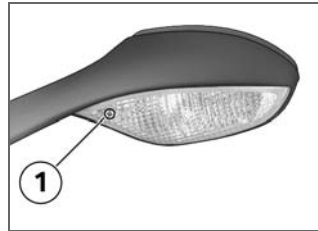

- Remove screw **1**.

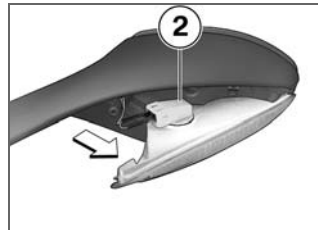

- Pull lamp housing on screw connection side out of mirror housing.

- Remove bulb holder **2** from lamp housing by turning it counterclockwise.

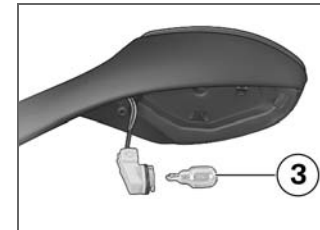

- Remove bulb **3** from bulb holder.

- Replacing defective bulb

 Bulbs for flashing turn indicators, front

– W16W / 12 V / 16 W

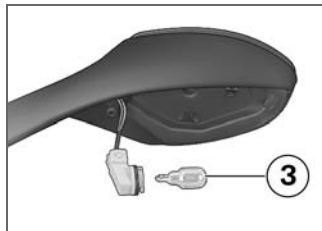

- Install bulb **3** in bulb socket.

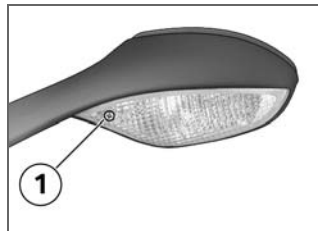

- Install screw **1**.



- Remove screw **1**.

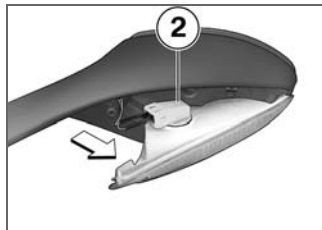

- Install bulb socket **2** in lamp housing by turning clockwise.
- Insert lamp housing in mirror housing.

Replacing rear turn indicator bulbs

- Make sure the ground is level and firm and park the motorcycle.
- Switch off the ignition.

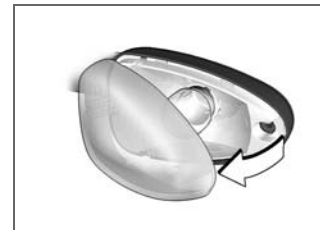

- Pull lamp housing on screw connection side out of turn indicator housing.

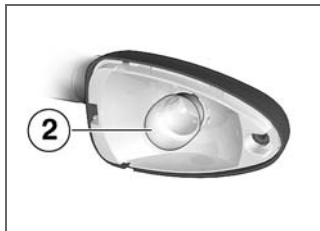

- Press bulb **2** into socket and turn counterclockwise to remove.
- Replace defective bulb.

 Bulbs for flashing turn indicators, rear

– R10W / 12 V / 10 W

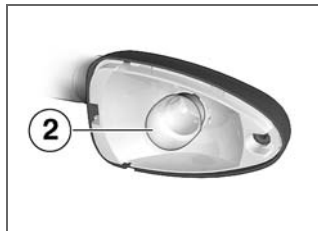

- Press bulb **2** into fitting and install turning clockwise.

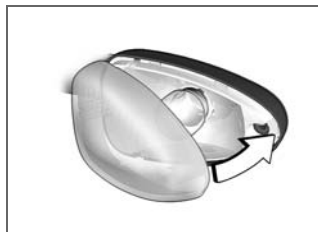

- Insert lamp glass in turn indicator housing.



- Install screw **1**.

Diode rear light

If more LEDs have burned out in the tail light than are indicated in the Technical Data below, the tail light bulb must be replaced. In this case:

- Contact a specialized workshop, preferably an authorized BMW Motorrad retailer.

 Maximum number of defective LEDs in taillight

– 1 (Brake light/taillight (red))

– 1 (License plate light (white))

Jump-starting

 The wires leading to the power socket do not have a load-capacity rating adequate for jump-starting the engine. Excessively high current can lead to a cable fire or damage to the motorcycle electronics.

Do not use the onboard socket to jump-start the engine of the motorcycle. ◀

 Touching live parts of the ignition system with the engine running can cause electric shock.

Do not touch parts of the ignition system when the engine is running. ◀

 A short-circuit can result if the crocodile clips of the jump leads are accidentally brought into contact with the motorcycle.

Use only jump leads fitted with

fully insulated crocodile clips at both ends. ◀

 Jump-starting with a donor-battery voltage higher than 12 V can damage the motorcycle electronics.

The battery of the donor vehicle must have a voltage of 12 V. ◀

- When jump-starting the engine, do not disconnect the battery from the onboard electrical system.
- Removing battery compartment cover (➡ 128).
- Run engine of donor vehicle during jump-starting.
- Begin by connecting one end of red jump lead to positive terminal of discharged battery and other end to positive terminal of donor battery.
- Then connect one end of black jumper lead to negative terminal of donor battery, and other end to negative terminal of discharged battery.
- Start the engine of the vehicle with the discharged battery in the usual way; if the engine does not start, wait a few minutes before repeating the attempt in order to protect the starter motor and the donor battery.
- Allow both engines to idle for a few minutes before disconnecting jump leads.
- Disconnect jump lead from negative terminals first, then disconnect second lead from positive terminals.
- Installing battery compartment cover (➡ 129).

Battery Maintenance instructions

Correct upkeep, recharging and storage will prolong the life of the battery and are essential if warranty claims are to be considered.

Compliance with the points below is important in order to maximize battery life:

- Keep the surface of the battery clean and dry
- Do not open the battery
- Do not top up with water
- Be sure to read and comply with the instructions for charging the battery on the following pages
- Do not turn the battery upside down

 If the battery is not disconnected, the onboard electronics (clock etc.) will drain the battery. This can cause the battery to run flat. If this happens,

warranty claims will not be accepted.

During periods when the motorcycle is not being used, of more than four weeks, disconnect the battery from the motorcycle or connect a trickle charger to the battery.◀

 BMW Motorrad has developed a trickle-charger specially designed for compatibility with the electronics of your motorcycle. Using this charger, you can keep the battery charged during long periods when the motorcycle is not being used without having to disconnect the battery from the motorcycle's onboard systems. Additional information is available at your authorized BMW Motorrad retailer.◀

Charging connected battery

 Charging the connected battery directly at the battery terminals can damage the motorcycle electronics. To charge the battery via the battery terminals, disconnect the battery first.◀

 If you switch on the ignition and the multifunction display and indicator lights fail to light up, the battery is completely flat. Attempting to charge a completely flat battery via the onboard socket can cause damage to the motorcycle's electronics. Always charge a completely drained battery directly at the terminals of the disconnected battery.◀

 Charging the battery via the onboard socket is only possible with suitable chargers. Unsuitable chargers can result in

damage to the motorcycle electronics.

Use BMW chargers with the part numbers 71 60 7 688 864 (220 V) or, as applicable, 71 60 7 688 865 (110 V). If in doubt, charge the disconnected battery directly at the terminals.◀

- Charge disconnected battery via onboard socket.

▷ The motorcycle's onboard electronics know when the battery is fully charged. The onboard socket is switched off when this happens.◀

- Comply with operating instructions of charger.

▷ If you are unable to charge the battery via the onboard socket, you may be using a charger that is not compatible with your motorcycle's electronics. In this case, please charge the battery

directly at the terminals of the disconnected battery.◀

Charging disconnected battery

- Charge battery using a suitable charger.
- Comply with operating instructions of charger.
- Once the battery is fully charged, disconnect the charger's terminal clips from the battery terminals.

▷ In the case of longer periods when the motorcycle is not being used, the battery must be recharged regularly. See the instructions for caring for your battery. Always fully recharge the battery before returning it to use.◀

Removing battery

- Removing battery compartment cover (➔ 128).

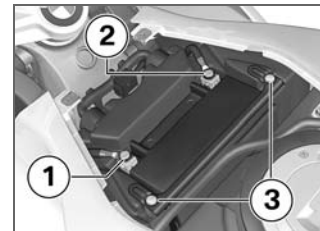

! An incorrect disconnection sequence increase the risk of short-circuiting. Always observe the proper sequence.◀

- Remove negative cable **1** first.
- Then remove positive cable **2**.
- Unscrew screws **3** and pull retaining bracket toward rear.
- Lift battery upwards; if it is difficult to move, moving it back and forth will help.

Installing battery

- Place battery in battery compartment, positive terminal on right in direction of travel.

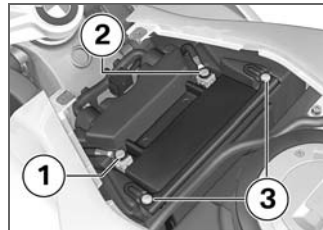

- Push retaining strap over battery and install screws **3**.

⚠ An incorrect installation sequence increases the risk of short-circuiting. Always observe the proper sequence. ◀

- First install positive battery cable **2**.
- Then install negative battery cable **1**.

▶ If the motorcycle was disconnected from the battery for a longer time, the current date must be entered in the instrument cluster to ensure the proper operation of the service display.

Consult a certified workshop, preferably an authorized BMW Motorrad retailer, for setting of the date. ◀

- Installing battery compartment cover (➡ 129).
- Setting clock (➡ 48).

Removing battery compartment cover

- Make sure the ground is level and firm and park the motorcycle.

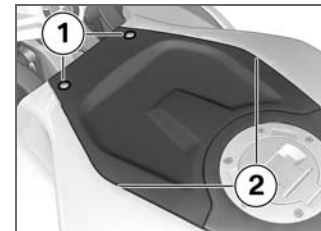

- Remove screws **1**.
- Remove battery compartment cover forward and upward while ensuring the anchorages are in position **2**.

Installing battery compartment cover

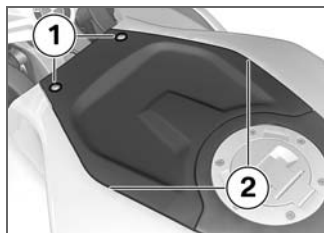

- Position battery compartment cover at the rear and close while ensuring the anchorages are in position **2**.
- Install screws **1**.

Care

Care products 132
Washing your motorcycle 132
Cleaning sensitive motorcycle
parts 132
Paint care 133
Protective wax coating 134
Storing motorcycle..... 134
Returning motorcycle to use 134



Care

Care products

BMW Motorrad recommends that you use cleaning and care products available at your authorized BMW Motorrad retailer. BMW CareProducts have been materials tested, laboratory tested, and field tested and provide optimum care and protection for the materials used in your motorcycle.

 The use of unsuitable cleaning and care products can damage motorcycle components. For cleaning, do not use any solvents such as nitro-thinners, cold cleaning agents, fuel or similar, and do not use cleaning agents that contain alcohol.◀

Washing your motorcycle

BMW Motorrad recommends that you use BMW Insect Remover to soften and wash off insects and stubborn dirt from painted parts before washing the motorcycle.

To prevent stains, do not wash the motorcycle immediately after it has been exposed to bright sunlight and do not wash it in the sun.

Make sure that the motorcycle is washed frequently, especially during the winter months.

To remove road salt, clean the motorcycle with cold water immediately after every trip.

 After washing the motorcycle, after driving through water or in the rain, braking can be delayed due to damp brake disks and brake pads.

Brake early until the brakes are dry or braked until dry.◀

 Warm water intensifies the effect of salt. Only use cold water to remove road salt.◀

 The high pressure of steam cleaners can damage seals, the hydraulic brake system, the electrical system and the seat. Do not use a steam jet or high-pressure cleaning equipment.◀

Cleaning sensitive motorcycle parts

Plastics

Clean plastic parts with water and BMW plastic care emulsion. This includes in particular:

- Windshields and wind deflectors
- Headlight lens made of plastic
- Covering glass of the instrument cluster

– Black, unpainted parts

 If plastic parts are cleaned using unsuitable cleaning agents, the surfaces can be damaged.

Do not use cleaning agents that contain alcohol, solvents or abrasives to clean plastic parts.

'Fly sponges' or sponges with hard surfaces can also lead to scratches.◀

 Soften stubborn dirt and dead insects by covering the affected areas with a wet cloth.◀

Windshield

Clean off dirt and insects with a soft sponge and plenty of water.

 Fuel and chemical solvents attack the windshield material; the windshield becomes cloudy or dull.

Do not use cleaning agents.◀

Chrome

Especially in the case of road salt, carefully clean chrome parts with plenty of water and BMW auto shampoo. Use chrome polish for additional treatment.

Radiator

Clean the radiator regularly to prevent overheating of the engine due to inadequate cooling. For example, use a garden hose with low water pressure.

 Cooling fins can be bent easily.

When cleaning the radiator, ensure that the fins are not bent.◀

Rubber

Treat rubber components with water or BMW rubber protection coating agent.

 Using silicone sprays for the care of rubber seals can cause damage.

Do not use silicon sprays or other care products that contain silicon.◀

Paint care

Washing the motorcycle regularly will help counteract the long-term effects of substances that damage the paint, especially if your motorcycle is ridden in areas with high air pollution or natural sources of dirt, e.g. tree resin or pollen.

However, remove particularly aggressive materials immediately; otherwise changes in the paint or discoloration can occur. These include spilled fuel, oil, grease, brake fluid as well as bird droppings. BMW Car Polish or BMW Paint Cleaner are recommended for this.

Contamination of the paint finish is particularly easy to see after the motorcycle has been washed. Remove this type of soiling with

cleaning naphtha or spirit on a clean cloth or cotton ball. BMW Motorrad recommends removing tar spots with BMW Tar Remover. Then add a protective wax coating to the paint at these locations.

Protective wax coating

To preserve the finish of your motorcycle, BMW Motorrad recommends using BMW Car Wax or agents that contain carnauba or synthetic waxes.

A sure sign that the paint must be protected, is the fact that water no longer pearls up on it.

Storing motorcycle

- Clean motorcycle.
- Remove battery.
- Spray brake and clutch lever, and main and side stand pivots with a suitable lubricant.

- Coat bare metal and chrome-plated parts with an acid-free grease (e.g. Vaseline).
- Park motorcycle in a dry room so that both wheels are unloaded.

▶ Before putting the motorcycle into storage, have the engine oil and the oil filter element changed by a specialist workshop, preferably an authorized BMW Motorrad retailer. Combine work for storing/returning to use with maintenance service or an inspection.◀

Returning motorcycle to use

- Remove the protective wax coating.
- Clean the motorcycle.
- Install a charged battery.
- Before starting: Observe checklist.

Technical data

Troubleshooting chart	136	Riding specifications	149
Threaded fasteners	137		
Engine	139		
Fuel.....	140		
Engine oil	140		
Clutch	141		
Transmission	141		
Rear-wheel drive	142		
Running gear	142		
Brakes	144		
Wheels and tires	144		
Electrical system.....	146		
Frame	147		
Dimensions	148		
Weights.....	148		

Troubleshooting chart

Engine does not start at all or is very difficult to start

Possible cause	Remedy
Side stand	Retract side stand (➡ 72).
Gear engaged and clutch not operated	Place transmission in neutral or disengage clutch (➡ 72).
Clutch disengaged before ignition on	Switch on ignition first, then disengage clutch.
No fuel in tank	Refueling (➡ 79).
Battery drained	Charging connected battery (➡ 126).

Threaded fasteners

Front wheel	Value	Valid
Front brake caliper on wheel carrier		
M8 x 32 - 10.9	22 lb/ft (30 Nm)	
Clamping bolt in wheel carrier		
M8 x 30	14 lb/ft (19 Nm)	
Quick-release axle in threaded bush		
M24 x 1.5	37 lb/ft (50 Nm)	
Rear wheel	Value	Valid
Muffler on passenger footrest		
M8 x 30	16 lb/ft (22 Nm)	
Muffler with ball-joint clamp on manifold		
M8 x 60	26 lb/ft (35 Nm)	
Cover on muffler		
M5 x 8	2 lb/ft (3 Nm)	

10

137

Technical data

10
138

Technical data

Rear wheel	Value	Valid
Tighten rear wheel on wheel flange		
M10 x 1.25 x 40	diagonally	
	44 lb/ft (60 Nm)	

Engine

Engine design	Transverse-mounted four-cylinder, four-stroke in-line engine, angled 55° toward front. With four valves per cylinder, actuated by two overhead camshafts and trailing valve levers; liquid cooled, electronic fuel injection, integrated six-speed cassette transmission, dry-sump lubrication
Displacement	1293 cc (1293 cm ³)
Cylinder bore	3.1 in (80 mm)
Piston stroke	2.5 in (64.3 mm)
Compression ratio	13:1
Rated output	175 hp (129 kW), - at engine speed: 9250 min ⁻¹
– with power reduction 79 kW ^{OE}	107 hp (79 kW), - at engine speed: 9000 min ⁻¹
Torque	103 lb/ft (140 Nm), - at engine speed: 8250 min ⁻¹
– with power reduction 79 kW ^{OE}	87 lb/ft (118 Nm), At: 3750 min ⁻¹
Maximum engine speed	max 11000 min ⁻¹
Idle speed	1050±50 min ⁻¹

10

139

Technical data

Fuel

Recommended fuel quality	98 ROZ/RON, Super Plus unleaded 95 ROZ/RON, Super unleaded (fuel type can be used with reduced performance and consumption)
Usable fuel quantity	Approx. 5 gal (Approx. 19 l)
Reserve fuel quantity	≥1.1 gal (≥4 l)

Engine oil

Engine oil, capacity	3.7 quarts (3.5 l), with filter change 0.5 quarts (0.5 l), Difference between Min and Max
Engine oils, permissible viscosity classes and products	
SAE 10W-40	≥-4 °F (≥-20 °C), Winter operation
Castrol GPS SAE 10W-40	≥-4 °F (≥-20 °C)
SAE 15W-40	≥14 °F (≥-10 °C)
Oil grades	Engine oils of the API classification SF or better. Engine oils of the ACEA classification A2 or better. BMW Motorrad recommends not using synthetic oils for the first 6000 miles (10000 km). Ask your BMW Motorrad retailer for engine oils suitable for your motorcycle.

Clutch

Clutch design	Multi-disk oil-bath clutch
---------------	----------------------------

Transmission

Transmission design	Claw-shifted 6-speed transmission integrated in engine housing
Transmission gear ratios	1.559 (92:59 teeth), Primary gear ratio 2.294 (39:17 teeth), 1st gear 1.789 (34:19 teeth), 2nd gear 1.458 (35:24 teeth), 3rd gear 1.240 (31:25 teeth), 4th gear 1.094 (35:32 teeth), 5th gear 0.971 (33:34 teeth), 6th gear 1.045 (23:22 teeth), Angle drive

Rear-wheel drive

Type of final drive	Shaft drive with bevel gears
Type of rear suspension	BMW EVO Paralever, single-arm light-alloy cast swinging arm with two joints and torque support
Number of teeth on rear-wheel drive (gear ratio)	2.82 (31:11)

Running gear**Front wheel**

Type of front suspension	Double leading link
Design of front suspension strut	Central spring strut with coil pressure spring and single-tube gas-pressure shock absorber.
– with Electronic Suspension Adjustment (ESA II) ^{OE}	Central spring strut with single-tube gas-pressure shock absorber and electric adjustable rebound-stage damping.
Spring travel, front	4.9 in (125 mm), On wheel

Rear wheel	
Type of rear suspension	BMW EVO Paralever, single-arm light-alloy cast swinging arm with two joints and torque support
Type of rear suspension	Lever-system-coupled central spring strut with coil pressure spring and single-tube gas-filled shock absorber. Spring preload with stepless hydraulic adjustment; rebound-stage damping with stepless adjustment
– with Electronic Suspension Adjustment (ESA II) ^{OE}	via lever-system-coupled central spring strut with coil pressure spring and single-tube gas-filled shock absorber, electric adjustable rebound-stage damping and electrohydraulic adjustable spring preload
Spring travel, rear	5.3 in (135 mm), On wheel

Brakes

Type of front brake	hydraulically operated twin disk brake with 4-piston fixed calipers and floating brake disks
Brake-pad material, front	Sintered metal
Type of rear brake	Hydraulic disk brake with 2-piston floating caliper and fixed brake disk
Brake-pad material, rear	Organic

Wheels and tires

Recommended tire combinations	You can obtain an overview of the current tire approvals from your authorized BMW Motorrad retailer or on the Internet at www.bmw-motorrad.com .
-------------------------------	--------------------------------------------------------------------------------------------------------------------------------------------------------------------------------------------

Front wheel

Front wheel design	Cast aluminum, MT H2
Front-wheel rim size	3.50" x 17"
Front tire designation	120 / 70 ZR 17

Rear wheel	
Rear wheel design	Cast aluminum, MT H2
Rear-wheel rim size	6.0" x 17"
Rear tire designation	190 / 55 ZR 17
Tire inflation pressure	
Tire pressure, front	36.3 psi (2.5 bar), Single rider, with cold tire 36.3 psi (2.5 bar), Driver with passenger and/or load, with cold tire
Tire pressure, rear	42.1 psi (2.9 bar), Single rider, with cold tire 42.1 psi (2.9 bar), Driver with passenger and/or load, with cold tire

10

145

Technical data

Electrical system

Electrical rating of onboard socket	max 5 A
Fuses	All circuits are electronically protected, so plug-in fuses are no longer necessary. If an electronic fuse trips and de-energizes a circuit, the circuit is active as soon as the ignition is switched on after the fault has been rectified.
Battery	
Battery manufacturer and designation	Yuasa YTX 14 BS
Battery design	AGM (Absorptive Glass Mat) battery.
Battery voltage	12 V
Battery capacity	14 Ah
Technical data	
Spark plugs, manufacturer and designation	NGK KR9CI
Electrode gap of spark plug	0.03 in (0.8 mm), New
Bulbs	
Bulb for high-beam headlight	H7 / 12 V / 55 W
Bulbs for low-beam headlight	H7 / 12 V / 55 W
Bulb for parking light	W5W / 12 V / 5 W
Bulb for taillight/brake light	LED / 12 V

Bulb of license plate light	W5W / 12 V / 5 W
Maximum number of defective LEDs in taillight	1, Brake light/taillight (red) 1, License plate light (white)
Bulbs for flashing turn indicators, front	W16W / 12 V / 16 W
Bulbs for flashing turn indicators, rear	R10W / 12 V / 10 W

Frame

Frame design	Cast light allow - welded design with screwed-on tubular steel rear frame
Location of type plate	On right wheel carrier
Location of vehicle identification number	Front right side frame section

10

147

Technical data

Dimensions

Motorcycle length	86.5 in (2196 mm)
Motorcycle height	48.1 in (1221 mm), Across windshield at DIN unladen weight
Motorcycle width	35.6 in (905 mm), Across mirrors
Driver's seat height	32.3 in (820 mm), Without driver
– with low double seat ^{OE}	31.1 in (790 mm), Without driver
Rider's inside-leg arc, heel to heel	71.3 in (1810 mm), Without driver
– with low double seat ^{OE}	70.1 in (1780 mm), Without driver

Weights

Unladen weight	560 lbs (254 kg), DIN unladen weight, ready for road, 90 % full tank of gas, without OE
Permissible gross weight	1014 lbs (460 kg)
Maximum payload	454 lbs (206 kg)

Riding specifications

Top speed	>124 mph (>200 km/h)
-----------	----------------------

10

149

Technical data

Service

Reporting safety defects 152
BMW Motorrad Service 153
BMW Motorrad Service Quality 153
BMW Motorrad Service Card - On-
the-spot breakdown assistance 153
BMW Motorrad Service
Network 154
Maintenance work 154
Confirmation of maintenance
work 155
Confirmation of service 160

Reporting safety defects

If you believe that your vehicle has a defect which could cause a crash or could cause injury or death, you should immediately inform the National Highway Traffic Safety Administration (NHTSA) in addition to notifying BMW of North America, LLC.

If NHTSA receives similar complaints, it may open an investigation, and if it finds that a safety defect exists in a group of vehicles, it may order a recall and remedy campaign. However, NHTSA cannot become involved in individual problems between you, your dealer, or BMW of North America, LLC.

To contact NHTSA, you may call the Vehicle Safety Hotline toll-free at 1-888-327-4236 (TTY: 1-800-424-9153); go to <http://www.safercar.gov>; or write to: Administrator, NHTSA, 400 Seventh Street, SW., Washington, DC 20590. You can also obtain other information about motor vehicle safety from <http://www.safercar.gov>.

BMW Motorrad Service

Advanced technology requires specially adapted methods of maintenance and repair.



If this maintenance and repair work is performed inexpertly, there is a danger of damage and associated safety risks. BMW Motorrad recommends having corresponding work on your motorcycle carried out by a specialized workshop, preferably by an authorized BMW Motorrad retailer. ◀

You can obtain information on the contents of the BMW Services from your BMW Motorrad retailer.

Have all maintenance and repair work carried out confirmed in the "Service" chapter in this manual. Your authorized BMW Motorrad retailer is supplied with all the latest technical information and therefore possesses the neces-

sary technical know-how. BMW Motorrad recommends that you refer any questions about your motorcycle to your authorized BMW Motorrad retailer.

BMW Motorrad Service Quality

BMW Motorrad means not only quality workmanship and high reliability, but also an outstanding quality of service.

To ensure that your BMW is always in optimum condition, BMW Motorrad recommends that you adhere to the regular maintenance schedule for your motorcycle, preferably having the work done by your authorized BMW Motorrad retailer. For generous treatment of claims submitted after the warranty period has expired, evidence of regular maintenance is essential.

Certain signs of wear, moreover, may otherwise not be noticed

until it is too late to correct them at moderate cost. The workshop personnel at BMW Motorrad retailers have thorough knowledge of your motorcycle and can take action before minor problems can turn into major trouble. By having the necessary repairs done properly and in good time, you save time and money in the long run.

BMW Motorrad Service Card - On-the-spot breakdown assistance

With all new BMW motorcycles, the BMW Motorrad Service Card protects you in the event of a breakdown with an extensive range of services such as breakdown assistance, motorcycle transportation etc. (differing regulations are possible in individual countries). In the case of a breakdown, you contact the Mobile Service of BMW Motorrad. Here you will find our specialists

ready to help with both advice and action.

Important country-specific contact addresses and the relevant after-sales service organization phone numbers as well as information on Mobile Service and the retail network can be found in the "Service Kontakt/Service Contact" brochures.

BMW Motorrad Service Network

With its worldwide service network, BMW Motorrad can attend to you and your motorcycle in over 100 countries around the globe. In Germany alone, there are approximately 200 authorized BMW Motorrad retailers ready to assist you.

All information concerning the international dealership network can be found in the brochure "Service Contact Europe" or

"Service Contact Africa, America, Asia, Australia, Oceania".

Maintenance work

BMW Pre-Delivery Check

The BMW pre-delivery check is carried out by your authorized BMW Motorrad retailer before it turns over the motorcycle to you.

BMW Running-in Check

The BMW running-in check has to be performed when the motorcycle has covered between 300 miles (500 km) and 750 miles (1,200 km).

BMW Service

BMW Service is carried out once a year. The scope of the services performed may be dependent on the vehicle owner and the mileage driven. Your BMW Motorrad retailer confirms that the service has been performed

and enters the date for the next service.

For drivers who drive long distances annually, it may be necessary to come in for service before the entered date. In this case a corresponding maximum odometer reading will also be entered in the confirmation of service. If this odometer reading is reached before the next service date, service must be performed sooner.

The service display in the multifunction display reminds you of the next service date approx. one month or 600 miles (1,000 km) before the entered values.

Confirmation of maintenance work

BMW Pre-Delivery Check

Conducted

on _____

Stamp, Signature

BMW Running-in Check

Conducted

on _____

Odometer reading _____

Next service
at the latest

on _____

or, if reached sooner,

Odometer reading _____

Stamp, Signature

11

155

Service

BMW Service

Conducted

on _____

Odometer reading _____

Next service
at the latest

on _____

or, if reached sooner,

Odometer reading _____

Stamp, Signature

BMW Service

Conducted

on _____

Odometer reading _____

Next service
at the latest

on _____

or, if reached sooner,

Odometer reading _____

Stamp, Signature

BMW Service

Conducted

on _____

Odometer reading _____

Next service
at the latest

on _____

or, if reached sooner,

Odometer reading _____

Stamp, Signature

BMW Service
Conducted
on _____
Odometer reading _____
Next service
at the latest
on _____
or, if reached sooner,
Odometer reading _____

Stamp, Signature

BMW Service
Conducted
on _____
Odometer reading _____
Next service
at the latest
on _____
or, if reached sooner,
Odometer reading _____

Stamp, Signature

BMW Service
Conducted
on _____
Odometer reading _____
Next service
at the latest
on _____
or, if reached sooner,
Odometer reading _____

Stamp, Signature

BMW Service

Conducted

on _____

Odometer reading _____

Next service
at the latest

on _____

or, if reached sooner,

Odometer reading _____

Stamp, Signature

BMW Service

Conducted

on _____

Odometer reading _____

Next service
at the latest

on _____

or, if reached sooner,

Odometer reading _____

Stamp, Signature

BMW Service

Conducted

on _____

Odometer reading _____

Next service
at the latest

on _____

or, if reached sooner,

Odometer reading _____

Stamp, Signature

BMW Service
Conducted
on _____
Odometer reading _____
Next service
at the latest
on _____
or, if reached sooner,
Odometer reading _____

Stamp, Signature

BMW Service
Conducted
on _____
Odometer reading _____
Next service
at the latest
on _____
or, if reached sooner,
Odometer reading _____

Stamp, Signature

BMW Service
Conducted
on _____
Odometer reading _____
Next service
at the latest
on _____
or, if reached sooner,
Odometer reading _____

Stamp, Signature

Confirmation of service

The table is intended as proof of maintenance and repair work, the installed optional accessories and any special campaign (recall) work carried out.

Work carried out	Odometer reading	Date

Work carried out	Odometer reading	Date

A

- Abbreviations and symbols, 6
- ABS
 - Operating element, 14
 - Operation, 58
 - Self-diagnosis, 73
 - Technology in detail, 84
 - Warning indicators, 31
- Anti-theft alarm
 - Indicator light, 17
 - Warning indicators, 41
- ASC
 - Operating element, 14
 - Operation, 59
 - Self-diagnosis, 74
 - Switching off, 59
 - Switching on, 59
 - Technology in detail, 86
 - Warning indicator, 36
 - Warning indicators, 34

B

- Battery
 - Charging connected battery, 126
 - Charging disconnected battery, 127
 - Closing battery compartment, 129
 - Installing, 128
 - Location, 13
 - Opening battery compartment, 128
 - Removing, 127
 - Technical data, 146
 - Warning for battery charge current, 27
- BMW Motorrad Service Card, 153
- Brake fluid
 - Checking fluid levels, 104
 - Front reservoir, 13
 - Rear reservoir, 13

Brake pads

- Checking brake pad thicknesses, 102
- Running in, 75

Brakes

- Adjusting brake lever, 61
- Checking operation, 102
- Safety instructions, 76
- Technical data, 144

C

- Case
 - Operation, 94
- Checklist, 71
- Clock, 20
 - Adjusting, 48
- Clutch
 - Adjusting clutch lever, 61
 - Checking fluid level, 106
 - Checking operation, 106
 - Fluid reservoir, 11
 - Technical data, 141
- Confirmation of maintenance work, 155

- Coolant
 - Temperature display, 20
 - Warning indicator, 26
- Currentness of this manual, 7
- D**
- Damping
 - Adjusting, 63
 - Rear adjustment element, 11
- Dimensions
 - Technical data, 148
- E**
- Electrical system
 - Technical data, 146
- Electronic immobilizer EWS
 - Warning indicator, 26
- Emergency ON/OFF switch, 15, 57
- Engine
 - Operating element, 15
 - Starting, 72
 - Technical data, 139
 - Temperature display, 20
 - Warning for engine electronics, 26
- Engine oil
 - Check level, 101
 - Fill level indicator, 13
 - Fill location, 16
 - Technical data, 140
 - Topping up, 102
 - Warning for engine oil level, 31
 - Warning for engine oil pressure, 27
- Equipment, 7
- ESA
 - Operating element, 14
 - Operation, 63
 - Technology in detail, 89
- F**
- Flat tire kit, 96
- Frame
 - Technical data, 147
- Front wheel stand
 - Mounting, 116
- Fuel
 - Fill level indicator, 20
 - Fill location, 13
 - Refueling, 79
 - Technical data, 140
- Warning for fuel down to reserve, 26
- Fuses, 146
- G**
- Gear indicator, 20
- H**
- Handlebar fittings
 - General view, left, 14
 - General view, right, 15
- Hazard warning flashers
 - Operating element, 14
 - Operation, 56
- Headlight
 - Adjusting for RHD/LHD traffic, 66
 - Headlight range, 66
 - Headlight range adjustment, 11
 - Overview, 18
- Heated hand grips, 60
 - Operating element, 15
- Helmet holder, 16, 68

High-beam headlight
Indicator light, 20
Switching on, 55
Horn, 14

I

Idling
Indicator light, 20
Ignition
Switching off, 46
Switching on, 46
Immobilizer, 47
Warning indicator, 26
Indicator lights, 17
Overview, 20
Instrument cluster
Ambient brightness sensor, 17
Overview, 17

J

Jump-starting, 125

K

Keys, 46

L

Lamps

General instructions, 118
Headlight overview, 18
Replacing front turn indicator
bulbs, 122
Replacing high-beam bulb, 119
Replacing low-beam bulb, 119
Replacing parking light
bulb, 120
Replacing rear light, 124
Replacing rear turn indicator
bulbs, 123
Technical data, 146
Warning for bulb failure, 28

Lights

Headlight flasher, 14, 55
High-beam headlight, 14
Operating element, 14
Switch on low-beam
headlight, 55
Switching on high-beam
headlight, 55
Switching on parking lights, 56
Switching on side lights, 55

Luggage

Information on loading and
securing, 93
Luggage loops, 16, 68

M

Maintenance
General instructions, 100
Maintenance intervals, 154
Mirrors
Adjusting, 62
Motorcycle
Returning to use, 134
Storing, 134
Switching off, 77
Multifunction display, 17
Overview, 20

O

Odometer and tripmeters, 20
Operating element, 14
Operation, 49
Onboard computer
Ambient temperature, 52
Average consumption, 53
Average speed, 52

- Oil level indicator, 54
- Operating element, 14
- Operation, 51
- Range, 53
- Warning indicators, 29
- Onboard socket, 11, 92
- Onboard toolkit
 - Contents, 100
 - Location, 16
- Overview of warning indicators, 24, 30, 33, 35, 38, 42
- Overviews
 - Headlight, 18
 - Instrument cluster, 17
 - Left side of motorcycle, 11
 - Left-hand handlebar fitting, 14
 - Multifunction display, 20
 - Right side of motorcycle, 13
 - Right-hand handlebar fitting, 15
 - Underneath seat, 16

P

- Parking light
 - Switching on, 56
- Pre-ride check, 73

R

- Rear-wheel drive
 - Technical data, 142
- Rear-wheel stand
 - Mounting, 117
- Refueling, 79
- Reserve quantity
 - Warning indicator, 26
- Residual range, 51
- Returning to use, 134
- Rider's Manual
 - Location, 16
- Running gear
 - Technical data, 142
- Running in, 74

S

- Safety instructions
 - Brakes, 76
 - General information, 70

- Seat
 - Installing, 67
 - Locking device, 11
 - Removing, 67
- Service, 153
- Service Card, 153
- Service display, 20
- Shifting gear
 - Gearshift assistant, 75
 - Shift reversal, 75
- Side stand
 - For starting, 72
- Spark plugs, 146
- Speedometer, 17
- Spring preload
 - Adjusting, 62
 - Rear adjustment element, 11
- Starting, 72
- Status indicators
 - Also see warning indicators, 20
 - Standard displays, 20
 - Warning indicators, 22

Steering lock
 Locking, 47
Storing, 134
Switching off, 77

T

Tachometer, 17
Technical data
 Battery, 146
 Brakes, 144
 Bulbs, 146
 Clutch, 141
 Dimensions, 148
 Electrical system, 146
 Engine, 139
 Engine oil, 140
 Frame, 147
 Fuel, 140
 Rear-wheel drive, 142
 Running gear, 142
 Spark plugs, 146
 Standards, 7
 Transmission, 141
Weights, 148
Wheels and tires, 144

Tire Pressure Control TPC/RDC
 Operation, 54
 Rim sticker, 108
 Technology in detail, 87
Warning indicators, 36

Tires

 Checking inflation pressure, 65
 Checking tread depth, 107
 Inflation pressure table, 16
 Recommendation, 108
 Running in, 75
 Technical data, 144

Torques, 137

Transmission
 For starting, 72
 Technical data, 141

Transport

 Lashing down, 80
 Troubleshooting chart, 136

Turn indicators

 Indicator light, 20
 Operating element, 14
 Operation, 56

Type plate, 13**V**

Vehicle Identification Number, 13

W

Warning indicators, 22
 Display, 22

 With ABS, 31
 With anti-theft alarm, 41
 With ASC, 34
 With onboard computer, 29
 With TPC/RDC, 36

Warning lights, 17

Weights

 Payload table, 16
 Technical data, 148

Wheels

 Checking rims, 107
 Installing front wheel, 111
 Installing rear wheel, 114
 Removing front wheel, 109
 Removing rear wheel, 113
 Size change, 108
 Technical data, 144

Free Manuals Download Website

<http://myh66.com>

<http://usermanuals.us>

<http://www.somanuals.com>

<http://www.4manuals.cc>

<http://www.manual-lib.com>

<http://www.404manual.com>

<http://www.luxmanual.com>

<http://aubethermostatmanual.com>

Golf course search by state

<http://golfingnear.com>

Email search by domain

<http://emailbydomain.com>

Auto manuals search

<http://auto.somanuals.com>

TV manuals search

<http://tv.somanuals.com>